



◆ **CATÁLOGO - TARIFA**
(Válida hasta Mayo 2022)

2021-22



ÍNDICE

Estufas ECO ECO stoves



ZEN:
1.375,00 €
8kw
pag. 9



ZOOM:
1.529,00 €
8kw
pag. 11



YUMI:
1.399,00 €
8,5kw
pag. 13



LUCKY:
1.629,00 €
10kw
pag. 15



YUMBO:
1.749,00 €
11,3kw
pag. 17



KIWI:
1.649,00 €
7,2kw
pag. 19

Estufas aire Air stoves



OLE:
1.139,00 €
5,5kw
pag. 21



VIP PLUS:
1.159,00 €
6kw
pag. 23



VERY PLUS:
1.339,00 €
7kw
pag. 25



LIS:
1.369,00 €
7,5kw
pag. 27



VIVA:
1.499,00 €
7,5kw
pag. 29



IDEAL:
2.249,00€
8,2kw
pag. 31



OPTIMA PLUS 9:
2.295,00 €
8,6kw
pag. 33



LILA:
1.459,00 €
9,7kw
pag. 35



LINDA PLUS:
1.559,00 €
9,7kw
pag. 37



CORNER PLUS:
2.169,00 €
9,7kw
pag. 39



BELINDA:
1.659,00 €
10kw
pag. 41



LOUVRE:
2.395,00 €
10kw
pag. 43



LINUX:
1.719,00 €
11kw
pag. 45



ZENITH:
2.259,00 €
13kw
pag. 47

Estufas aire o canalizada
Air or flow stoves



■ OPTIMA PLUS 11:
2.499,00 €
OPTIMA PLUS 11 WIND:
2.749,00 €
10,7kw
pag. 51



■ LIPTON:
1.799,00 €
LIPTON WIND:
2.199,00 €
12kw
pag. 53



■ ZEPPELIN:
2.919,00 €
ZEPPELIN WIND:
3.349,00 €
15,7kw
pag. 55

Estufas canalizadas
Flow stoves



■ LYON WIND:
1.880,00 €
9,7kw
pag. 57



■ ODESIA WIND:
2.499,00 €
11,5kw
pag. 59

Estufas aire pasillo
Air hallway stoves



■ KINOX:
1.799,00 €
7,2kw
pag. 63



■ AVALON:
2.495,00 €
11kw
pag. 65



■ STYLO WOOD:
2.249,00 €
11kw
pag. 67

Estufas pasillo aire o canalizada
Air or flow hallway stoves



■ AVANT:
1.899,00 €
AVANT WIND:
2.120,00 €
11kw
pag. 69



■ KIMONO:
1.799,00 €
KIMONO WIND:
2.090,00 €
7,2kw
pag. 71



■ KISS:
1.679,00 €
KISS WIND:
1.970,00 €
7,2kw
pag. 73



■ STYLO:
1.999,00 €
STYLO WIND:
2.199,00 €
11kw
pag. 75

Estufas aire Box
Air stoves box



■ NORDIC:
2.089,00 €
8,8kw
pag. 79

Estufas de aire o canalizada Box
Flow box stoves



■ RUBY 70/80/90:
2.149,00 €
RUBY WIND 70/80/90:
2.495,00 €
10kw
pag. 81



■ ZAPHIR:
2.299,00 €
ZAPHIR WIND:
2.695,00 €
9,3kw
pag. 83

Estufas de exterior
Outdoor stoves



■ MINNIE:
1.699,00 €
10kw
pag. 111



■ MICKEY:
1.799,00 €
10kw
pag. 111

Cocina de pellet
Pellet cooker



■ CUISINE:
2.799,00 €
8,1kw
pag. 85

Accesorios
Accessories



■ ACCESORIOS
pag. 114-130

Hidroestufas agua
Hydro stoves



■ LLAMA:
2.399,00 €
15kw
pag. 89



■ LAIA:
2.780,00 €
16kw
pag. 91



■ LAURA PLUS:
3.099,00 €
20kw
pag. 93



■ LASER:
3.850,00 €
31kw
pag. 95



■ TURBO 10/14:
3.300,00 €
13-16kw
pag. 97

Calderas de pellets
Pellet boilers



■ ESENCIAL 15:
3.339,00 €
15kw
pag. 101



■ SUPREMA 15/20/26/45:
3.689,00 €
15-45kw
pag. 103



■ BIOPEL 20/30/40
4.599,00 €
20-40kw
pag. 105

Calderas de leña
Wood boilers



■ ECOPLUS 25/32/40/50:
2.999,00 €
25-50kw
pag. 107

ECODISEÑO 2022: ¿Qué es?

ECODESIGN 2022: What is it?

ESP

El reglamento de la Unión Europea 2015/1185 establece los requisitos de diseño ecológico para la producción, comercialización y puesta en funcionamiento de aparatos de calefacción local de combustibles sólidos ≤ 50KW.

Todos los aparatos producidos a partir del 1 de enero de 2022 deberán cumplir con el anexo II de este reglamento. **Los aparatos producidos con anterioridad** a esa fecha podrán comercializarse aún no cumpliendo con el reglamento y estarán **exentos** de inspección.

El anexo II de este reglamento establece para estufas, hidroestufas y calderas de pellet el límite **mínimo** de eficiencia o rendimiento estacional admisible superior o igual a 79%, así como los límites **máximos** de emisiones o contaminación, en particular deberá ser inferior a 300 mg/m³ de monóxido de carbono y 20 mg/m³ de partículas de polvo.

El anexo III establece la información a transmitir al consumidor: valores técnicos, manuales montaje, instalación o mantenimiento, incluso para su reciclado o eliminación. La información quedará reflejada en la web, el producto y el material comercial a disposición del consumidor.



ENG

The European Union regulation 2015/1185 establishes the ecological design requirements for the production, commercialization and commissioning of local heating appliances for solid fuels <50KW.

All devices produced as of January 1, 2022 must comply with Annex II of these regulations. Devices produced prior to that date may be marketed still not complying with the regulations and will be exempt from inspection.

Annex II of this regulation establishes for stoves, hydro stoves and pellet boilers the minimum limit of efficiency or admissible seasonal yield greater than 79%, as well as the maximum limits of emissions or pollution, in particular it must be less than 300 mg / m³ of carbon monoxide and 20 mg / m³ of dust particles.

Annex III establishes the information to be transmitted to the consumer: technical values, assembly, installation or maintenance manuals, including for recycling or disposal. The information will be reflected on the web, the product and the commercial material available to the consumer.

ECODISEÑO 2022: TODAS LAS ESTUFAS EOSS CUMPLEN

ECODESIGN 2022: ALL EOSS STOVES COMPLY

ESP

Nuestro departamento técnico y ensayos ha realizado una labor intensa de I+D+i para lograr adaptar **todas nuestras estufas** al cumplimiento de los requisitos de eficiencia y emisiones establecidas en el anexo II del Reglamento 2015/1185.

El principal inconveniente radica en cumplir con las emisiones, para lo cual EOSS ha optado por emplear braseros más compactos, en cuyo interior se desarrollan temperaturas de combustión superiores logrando un efecto incinerador que aumenta el rendimiento del equipo y reduce las emisiones. De esta manera, las emisiones contaminantes se reducen entre 30% a 50% respecto a estufas convencionales.

Además, EOSS incorpora en el modelo OPTIMA la **tecnología 24V** con procesos de encendido de ciclos muy rápidos inferiores a 4 minutos; como resultado la energía eléctrica consumida cae de forma drástica.

ENG

*Our technical and testing department has carried out intense R & D & i work to adapt **all our stoves** to meet the efficiency and emission requirements established in Annex II of Regulation 2015/1185.*

The main drawback lies in complying with emissions, for which EOSS has chosen to use more compact braziers, which in its inside higher combustion temperatures are developed, achieving an incinerative effect that increases the performance of the equipment and reduces emissions. In this way, pollutant emissions are reduced between 30% to 50% compared to conventional stoves.

*Furthermore, EOSS incorporates **24V technology** in the OPTIMA model with very fast cycle ignition processes of less than 4 minutes; as a result, the electrical energy consumed drops drastically.*

Ventajas EOSS / EOSS Advantages



ESP

Nuestras estufas logran los **consumos más bajos del mercado**, gracias a los elevados rendimientos y a la tecnología de combustión modulante que garantiza el máximo ahorro.

ENG

The EOSS pellet stoves achieve the lowest consumption rates of the market, thanks to the highest efficiencies, to the modulating combustion technology and the maximum use of the generated heat become a guarantee for the highest savings.



ESP

Nuestra tecnología combina ventiladores de mínimo impacto acústico. El resultado satisfactorio lo descubrirá en su vivienda: **puro silencio**.

ENG

Our technology combines ventilators with minimum noise impact. You will discover the satisfactory results at your home: pure silence.

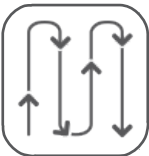

ESP

Fruto del equipo I+D, nace este novedoso intercambiador HOT-AIR que consigue un **mayor aprovechamiento del calor y la temperatura impulsada a la vivienda es muy superior**.

ENG

As a result of a R&D investigation arise this novel exchanger with HOT-AIR. This system achieves a much higher heat use and the temperature impulsed to the home is far higher.

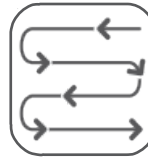

ESP

Algunas tienen intercambiador tubular horizontal, **hace posible comportarse como una caldera instantánea de gas**. Es la única del mercado que se comporta así.

ENG

Some have a horizontal tubular exchanger, and makes it possible to behave like a boiler gas snapshot. It is the only one on the market that it behaves like this.

Información adicional / Additional information



ESP

Los valores de los **decibelios recogidos** en el catálogo son el promedio de los ensayos realizados a 1 metro de distancia en una cámara insonorizada.

No existe una norma Europea homologada para la medición del ruido de una estufa de pellet. El valor recogido en el catálogo es por este motivo orientativo.

ENG

The values of the decibels indicated in the catalog are the average of the tests performed at a distance of 1 meter in a soundproof chamber.

There is no European standard approved for the measurement of the noise of one pellet stove. Therefore, the value indicated in the catalog is illustrative.



ESP

POT. NOM. **Potencia desarrollada** por la estufa en el ensayo de homologación a potencia 5 cumpliendo con las emisiones de la legislación vigente según la norma EN14975.

ENG

Power developed by the stove in the test of homologation to power 5 fulfilling with the emissions of current legislation according to the standard EN14975.



ESP

POT. MAX. La **potencia máxima** de los equipos se logra aumentando la cantidad de pellet en el menú Pellet/trabajo a +9. Las emisiones generadas a potencia máxima pueden no cumplir con la normativa vigente en cada país.

ENG

The maximum power of the equipment is achieved by increasing the amount of pellet in the Pellet/work menu to +9. The emissions generated at maximum power may not fulfill with the regulations in force in each country.



ESP

Temperatura de vivienda: la medición se realiza con un pellet de PCI superior a 4300kcal/kg en la salida de la rejilla. Mediciones con calidades de pellet inferiores generarán menor calor y temperatura a vivienda.

ENG

House temperature: the measurement it is been carried out with a pellet of PCI higher than 4300kcal/kg in the outlet of the grid. Measurements of lower pellet qualities will generate lower heat and temperature to the house.

UNA REVOLUCIÓN EN EL APROVECHAMIENTO DEL CALOR A REVOLUTION IN THE USE OF HEAT

ESP

A partir del 1 de enero del 2022 todas las estufas producidas en la UE deberán cumplir con la normativa ECODESIGN. La nueva normativa recoge las distintas disposiciones europeas, definiendo criterios más estrictos de eficiencia y emisiones contaminantes. La eficiencia tendrá en cuenta, no sólo el rendimiento de la combustión, sino también el consumo eléctrico.

EOSS ha ido más allá, superando esos requisitos en beneficio del usuario, pues la normativa no valora de forma directa el aprovechamiento del calor generado en una estufa de aire.

EOSS ha desarrollado la tecnología denominada Hot-Air©. Consiste y se traduce, en que a igualdad de potencia con cualquier estufa de la competencia, ¡la estufa EOSS calienta más! Y esto es así porque los m³/h de aire impulsado a vivienda (caudal del ventilador), tienen mayor temperatura y el aire sale más caliente.

Dado que el calor introducido en vivienda no se corresponde con la potencia de la estufa, sino que es el caudal de aire a la temperatura de salida en rejilla, al introducir más calor, la estufa comienza a modular antes y reduce el consumo de pellet diario. Al modular, la estufa abandona la potencia nominal y pasa a potencia mínima. Mínimo consumo, mínimo ruido. Esto se traduce en una significativa ventaja para su bolsillo, al obtener un ahorro del 15% en la compra del pellet.

En resumen, la avanzada tecnología Hot-Air© que incorporan las estufas EOSS, le aportan: Un AHORRO importante en el combustible, un mayor CONFORT por menor ruido y MAYOR RAPIDEZ DEL CALENTAMIENTO de su casa, gracias al aire a muy alta temperatura.

ENG

From January 1, 2022, all stoves produced in the EU must comply with ECODESIGN regulations. The new regulation includes the different European provisions, defining stricter criteria of efficiency and polluting emissions. Efficiency will take into account not only combustion performance, but also electricity consumption.

EOSS has gone further, exceeding those requirements for the benefit of the user, since the regulations do not directly assess the use of the heat generated in an air stove.

EOSS has developed the Hot-Air © technology. It consists in, that at equal power as any competing stove, the EOSS stove heats up more! And this is so because the m³ / h of air driven into the house, (fan flow), have a higher temperature, the air comes out hotter.

In this case, the heat introduced into the house does not correspond to the power of the stove, but it's the air flow at the outlet temperature on the grid. By introducing more heat, the stove begins to modulate sooner and reduces the consumption of daily pellets. When modulating, the stove leaves the nominal power and goes to minimum power. Minimum consumption, minimum noise. This turns to a 15% savings in the purchase of pellets.

In summary, the advanced Hot-Air © technology that the EOSS stoves incorporate, gives you: A significant SAVING in fuel. Greater COMFORT due to less noise. And a WARM HOUSE much SOONER, thanks to the hot air emitted.



Ver pag. 51-52



OPTIMA PLUS 11 / OPTIMA PLUS 11

- WARRANTY 5Y
- CONTROL (APP)
- ECODESIGN

potencia nominal nominal thermal output	Potencia máxima MAXIMUM POWER	Consumo Consumption	Wp	η	kg	kg
12,7 kw	0,64 - 2,35 Kg/h	170°C	93,4%	42J/h	110kg	

Certificación
Certification

Medidas
Measurements

A+ CE

24V SILENCIO / 24V SILENCE
¡Las estufas más silenciosas del mercado! / *The quietest stoves on the market!*

■ CONTROL REMOTO VÍA WIFI O SMS AUMENTE SU CONTROL EN UN CLICK

REMOTE CONTROL WIFI OR SMS. INCREASE YOUR COMFORT WITH A CLICK

ESP

Mediante el KIT WIFI podrá encender y apagar, modificar temperatura o potencias y programar su estufa o caldera desde cualquier punto.

El KIT WIFI precisa de una red inalámbrica en su vivienda, para que la estufa o hidroestufa esté conectada a internet.

Para viviendas que no dispongan de internet, como por ejemplo segundas viviendas, existe la posibilidad de instalar un router 4G WIRELESS wifi de tarjeta prepago con datos. Esto se puede comprar en cualquier tienda de informática y de este modo la vivienda tendrá internet y por medio de nuestro kit wifi de EOSS, el cliente podrá encender/apagar la estufa, variar la temperatura y potencia de consigna de manera remota.

ENG

After registering previously in the EOSS website, through the WIFI KIT you will be able to switch on, modify temperature or power and program your stove or boiler even from your job location.

The WIFI KIT requires a wireless net at your home, so that the stove or boiler is connected to the internet.

For homes that do not have internet, such as second homes, there is the possibility of installing a 4G WIRELESS wifi router with a prepaid card with data. This can be purchased at any computer store and in this way the home will have internet and through our EOSS Wi-Fi kit, the customer can turn on / off the stove, vary the temperature and setpoint power remotely.

**¡Ya está disponible en Apple Store y Google Play
la nueva APP de EOSS para dispositivos móviles!**

*The new EOSS APP for mobile devices is now
available on the Apple Store and Google Play!*

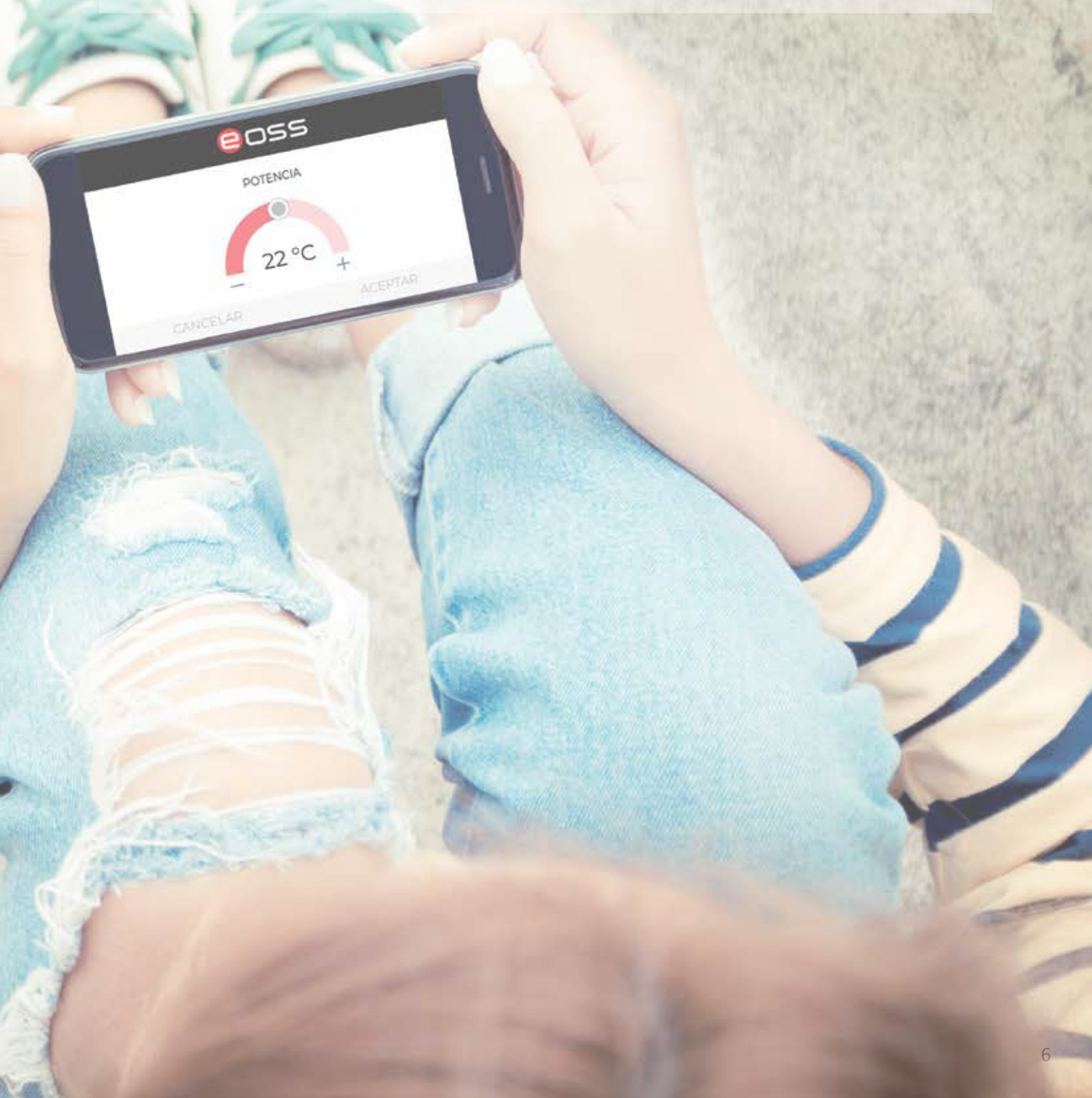

■ **ESTUFAS PELLET AIRE**
EL CONFORT QUE LE ACOMPAÑA

PELLET AIR STOVES

THE COMFORT THAT ACCOMPANIES YOU





ESP

Las estufas de pellet de aire representan uno de los sistemas más ventajosos e innovadores para la calefacción doméstica. Son prácticas, fáciles de usar y sencillas de instalar, de hecho el funcionamiento es completamente automático.

Las estufas de aire incorporan un ventilador de aire que garantiza el calentamiento de la vivienda de hasta 157 m². Existe una amplia gama de estufas de aire según potencia, estética y diseño.

ENG

The air pellet stove has become one of the most advantageous and innovative domestic heating systems. On one side they are practical, easy to use and easy to install, indeed the running is completely automatic.

The stoves include an air ventilator which guarantees the heating up of a house until 157 m². It does exist a wide range of air stoves according to power, aesthetic and design.



Zen	Referencia	Salida de humos \varnothing	Dimensiones (AxHxL)	P.V.P € (sin IVA)
Zen	ZEN8-7777	80 mm	438 x 921 x 463 mm	1.375,00 €
Mando a distancia	VATL	-	-	35,00 €

ESP

Estufa de pellet de aire Zen de atractivo diseño con revestimiento en acero y perfiles frontales y laterales en cromo disponible en 3 colores. Estufa muy compacta de 8kW adecuada para instalar en cualquier zona de la vivienda. Estufa de gran rendimiento por la alta temperatura de salida de aire a 115°C.

ENG

Air pellet stove Zen styled in an attractive design with steel claddings and frontal and side profiles in chrome, available in 3 different colours. This 8kW power compact stove is likely to be installed in any room of your home. Stove with high efficiency because it's high temperature of the fan at 115°C.



Potencia nominal
Nominal heat output

8 kw

Potencia máxima
Maximum power

9 kw

Consumo
Consumption

0,5 - 1,9 Kg/h

Temp Salida
Output

115°C

η

91%

Max

39dB

kg

56kg

m²

80m²

kg

15kg

Colores (Mate)
Colour (Matte)



BCO



BDX



BLK

Certificación
Certifications



Medidas
Measures

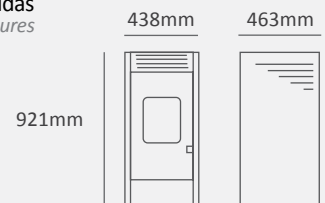

ESP

- Perfiles cromados en el frontal y lateral
- Vermiculita en cámara de combustión
- Programación diaria, semanal y fin de semana
- Salida de humos posterior (tubo 25 cm + T90)
- Modulación automática
- Protección contra sobrecalentamiento
- Sensor de temperatura
- Control de temperatura de humos

OPCIONAL

- Control remoto vía internet (Kit WIFI)
- Mando a distancia

ENG

- Frontal and side profiles in chromo
- Vermiculite in combustion chamber
- Daily, weekly and weekend programming
- Rear smoke outlet (25cm tube + T90)
 - Automatic modulation
 - Overheating protection
 - Temperature sensor
- Smoke temperature control

OPTIONAL

- Internet remote control (Kit WIFI)
- Remote control



Zoom	Referencia	Salida de humos \varnothing	Dimensiones (AxHxL)	P.V.P € (sin IVA)
Zoom	ZOOM8-777	80 mm	438 x 921 x 463 mm	1.529,00 €
Mando a distancia	VATL	-	-	35,00 €

ESP

Estufa de pellet de aire Zoom de 8kW con un atractivo diseño de revestimiento en acero y frontal en piedra en 2 acabados diferentes. Estufa muy compacta de 8kW adecuada para instalar en cualquier zona de la vivienda. Estufa de gran rendimiento por la alta temperatura de salida de aire a 115°C.

ENG

The 8KW Zoom pellet stove, has a very attractive design, with steel cladding and a stone front in 2 different finishes. This 8kW power compact stove is likely to be installed in any room of your home. Stove with high efficiency because it's high temperature of the fan at 115°C.



Potencia nominal
Nominal heat output

8 kw

Potencia máxima
Maximum power

9 kw

Consumo
Consumption

0,5 - 1,9 Kg/h

Temp Salida
Output

115°C

η

91%

Max

39dB

kg

65kg

m²

80m²

kg

15kg

Colores
Colour

NEGRO OXIDO



CALACATTA

Certificación
Certifications



Medidas
Measures

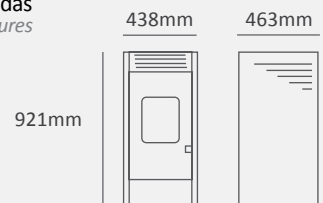

ESP

- Frontal con acabado en PIEDRA
- Vermiculita en la cámara de combustión
- Programación diaria, semanal y fin de semana
- Salida de humos posterior (tubo 25 cm + T90)
- Modulación automática
- Protección contra sobrecalentamiento
- Sensor de temperatura
- Control de temperatura de humos

OPCIONAL

- Control remoto vía internet (Kit WIFI)
- Mando a distancia

ENG

- Stove with stone front
- Vermiculite in combustion chamber
- Daily, weekly and weekend programming
- Rear smoke outlet (25cm tube + T90)
- Automatic modulation
- Overheating protection
- Temperature sensor
- Smoke temperature control

OPTIONAL

- Internet remote control (Kit WIFI)
- Remote control



Yumi	Referencia	Salida de humos \varnothing	Dimensiones (AxHxL)	P.V.P € (sin IVA)
Yumi	YUMI-7777-COL	80 mm	480 x 965 x 575 mm	1.399,00 €
Mando a distancia	VATL	-	-	35,00 €

ESP

Estufa de diseño moderno de líneas rectas con un emparrillado superior. Destaca por una construcción robusta con brasero en acero inoxidable y paredes interiores revestidas de vermiculita.

ENG

Modern design stove with straight lines with an upper grill. It stands out for its robust construction with a stainless steel brazier and vermiculite-coated interior walls.



Potencia nominal
Nominal heat output

8,5 kw

Potencia máxima
Maximum power

10 kw

Consumo
Consumption

0,64-1,85 Kg/h

Temp Salida
Output

95°C

η

92,2%

Max

39dB

kg

90kg

m²

85m²

kg

25kg

Colores
Colour



BDX



BLK

Certificación
Certifications



Medidas
Measures

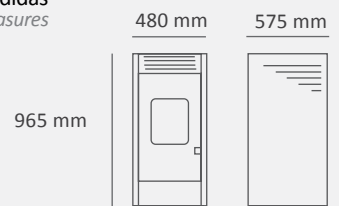

ESP

- Vermiculita en cámara de combustión
- Top superior estriado
- Brasero en acero inoxidable
- Programación diaria, semanal y fin de semana
- Salida de humos posterior (T90)
- Modulación automática
- Protección contra sobrecalentamiento
- Sensor de temperatura
- Control de temperatura de humos

OPCIONAL

- Control remoto vía internet (Kit WIFI)
- Mando a distancia

ENG

- Vermiculite in combustion chamber
- Upper grill
- Stainless steel brazier
- Daily, weekly and weekend programming
- Rear smoke outlet (T90)
- Automatic modulation
- Overheating protection
- Temperature sensor
- Smoke temperature control

OPTIONAL

- Internet remote control (Kit WIFI)
- Remote control



Lucky	Referencia	Salida de humos \varnothing	Dimensiones (AxHxL)	P.V.P € (sin IVA)
Lucky	LUCKY10-7	80 mm	457 x 996 x 570 mm	1.629,00 €
Mando a distancia	VATL	-	-	35,00 €

ESP

Estufa de diseño elegante con una decoración frontal en inoxidable. Destaca por una construcción robusta con brasero en hierro fundido y paredes interiores revestidas de vermiculita.

ENG

This stove has an elegant design with a front decoration in stainless steel. It stands out for its robust construction with a cast iron brazier and vermiculite-coated interior walls.



Potencia nominal
Nominal heat output

10 kw

Potencia máxima
Maximum power

12 kw

Consumo
Consumption

0,8 - 2,2 Kg/h

Temp Salida
Output

120°C

η

87,6%

Max

42dB

kg

108kg

m²

100m²

kg

16kg

Colores
Colour



BCR



BDX



BLK

Certificación
Certifications



Medidas
Measures

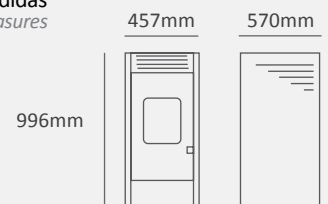

ESP

- Laterales de la cámara de combustión en vermiculita
- Perfil cromado delantero
- Programación diaria, semanal y fin de semana
- Salida de humos posterior (T90)
- Modulación automática
- Protección contra sobrecalentamiento
- Sensor de temperatura
- Control de temperatura de humos

OPCIONAL

- Control remoto vía internet (Kit WIFI)
- Mando a distancia

ENG

- Sides of the combustion chamber in vermiculite
- Chrome front profile
- Daily, weekly and weekend programming
- Smoke outlet: rear (T90)
- Automatic modulation
- Overheating protection
- Temperature sensor
- Smoke temperature control

OPTIONAL

- Internet remote control (Kit WIFI)
- Remote control



Yumbo	Referencia	Salida de humos \varnothing	Dimensiones (AxHxL)	P.V.P € (sin IVA)
Yumbo	YUMBO-777-COL	80 mm	475 x 1070 x 585 mm	1.749,00 €
Mando a distancia	VATL	-	-	35,00 €

ESP

Estufa de diseño moderno de líneas rectas con un emparrillado superior. Destaca por una construcción robusta con brasero en acero inoxidable y paredes interiores revestidas de vermiculita.

ENG

Modern design stove with straight lines with an upper grill. It stands out for its robust construction with a stainless steel brazier and vermiculite-coated interior walls.



Potencia nominal
Nominal heat output

11,3 kw

Potencia máxima
Maximum power

13 kw

Consumo
Consumption

1,1-2,5 Kg/h

Temp Salida
Output

95°C

η

90,5%

Max

39dB

kg

118kg

m²

113m²

kg

30kg

Colores
Colour



BDX



BLK

Certificación
Certifications



Medidas
Measures

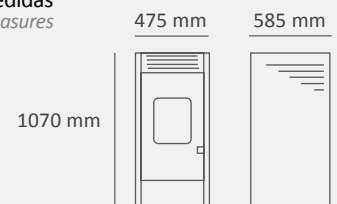

ESP

- Top superior estriado
- Brasero en acero inoxidable
- Programación diaria, semanal y fin de semana
- Salida de humos posterior (T90)
- Modulación automática
- Protección contra sobrecalentamiento
- Sensor de temperatura
- Control de temperatura de humos

OPCIONAL

- Control remoto vía internet (Kit WIFI)
- Mando a distancia

ENG

- Vermiculite in combustion chamber
- Upper grill
- Stainless steel brazier
- Daily, weekly and weekend programming
- Rear smoke outlet (T90)
- Automatic modulation
- Overheating protection
- Temperature sensor
- Smoke temperature control

OPTIONAL

- Internet remote control (Kit WIFI)
- Remote control



Kiwi	Referencia	Salida de humos \varnothing	Dimensiones (AxHxL)	P.V.P € (sin IVA)
Kiwi	KIWI-77777-COLOR	80 mm	743 x 1010 x 277 mm	1.649,00 €
Mando a distancia	VATL	-	-	35,00 €

ESP

Estufa de diseño pasillo funcional de tan sólo 28cm de fondo. Destaca por su diseño de líneas rectas. Además dispone de versatilidad para la salida de humos, ya sea superior, posterior o lateral derecha. Esta es la estufa adecuada para cualquier salón o pasillo de dimensiones reducidas.

ENG

Functional corridor design stove with a depth of only 28cm. It stands out for its design of straight lines. It also has versatility for the smoke outlet, either upwards, rear or to the right side. This is the perfect stove for any small living room or hallway.



Potencia nominal
Nominal heat output

7,2 kw

Potencia máxima
Maximum power

9,2 kw

Consumo
Consumption

0,6-1,68 Kg/h

Temp
Salida
Output

95°C

η

95%

Max

39dB

kg

67kg

m²

72m²

kg

15kg

Colores
Colour



BCO



BRZ



BLK

Certificación
Certifications



Medidas
Measures

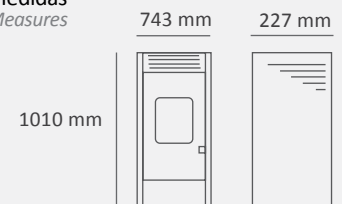

ESP

- Salida de humos posterior (necesario codo 90 especial)
- Salida de humos lateral derecha (necesario codo 90 especial)
- Salida de humos superior (necesario conector hembra-hembra)
- Programación diaria, semanal y fin de semana
- Modulación automática
- Protección contra sobrecalentamiento
- Sensor de temperatura
- Control de temperatura de humos

OPCIONAL

- Control remoto vía internet (Kit WIFI)
- Mando a distancia

ENG

- Rear smoke outlet (special 90 elbow required)
- Right side smoke outlet (special 90 elbow required)
- Upper smoke outlet (female-female connector required)
- Daily, weekly and weekend programming
- Automatic modulation
- Overheating protection
- Temperature sensor
- Smoke temperature control

OPTIONAL

- Internet remote control (Kit WIFI)
- Remote control



Ole	Referencia	Salida de humos ϕ	Dimensiones (AxHxL)	P.V.P € (sin IVA)
Ole	OLE5-7777	80 mm	438 x 790 x 461 mm	1.139,00 €
Cajón cenizas	CS-A00286_00	-	-	26,25 €
Mando a distancia	VATL	-	-	35,00 €

ESP

Estufa de pellet de aire Ole de proporciones equilibradas con revestimiento en acero disponible en 3 colores diferentes. Ninguna otra estufa de 5,5kW emite el aire frontal a 100°C.

ENG

Air pellet stove Ole of well-balanced proportions with steel claddings available in 3 different colours. No other stove in the market of 5.5kW, emits the frontal air at 100°C.



Potencia nominal
Nominal heat output

5,5 kw

Potencia máxima
Maximum power

8 kw

Consumo
Consumption

0,5 - 1,3 Kg/h

°Temp
Salida
Output

100°C

η

91%

Max

39dB

kg

56kg

m²

55m²

kg

15kg

Colores (Mate)
Colour (Matte)



BCO



BDX



BLK

Certificación
Certifications



Medidas
Measures

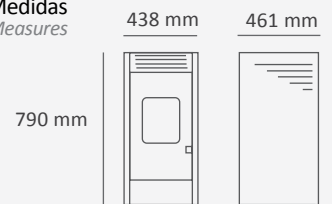

ESP

- Incluye vermiculita en cámara de combustión
- Programación diaria, semanal y fin de semana
- Salida de humos posterior (tubo 0,25m + T90)
- Salida de humos lateral derecho (codo 90º especial)
- Modulación automática
- Protección contra sobrecalentamiento
- Sensor de temperatura
- Control de temperatura de humos

OPCIONAL

- Control remoto vía internet (Kit WIFI)
- Mando a distancia

ENG

- Vermiculite in combustion chamber
- Daily, weekly and weekend programming
- Rear smoke outlet (25cm tube + T90)
- Right side smoke outlet (special 90º bent)
 - Automatic modulation
 - Overheating protection
 - Temperature sensor
- Smoke temperature control

OPTIONAL

- Internet remote control (Kit WIFI)
- Remote control



Vip Plus	Referencia	Salida de humos ϕ	Dimensiones (AxHxL)	P.V.P € (sin IVA)
Vip Plus	VIP5-7777	80 mm	438 x 921 x 463 mm	1.159,00 €
*Vip Plus Oliva	VIP5-OL77	80 mm	438 x 921 x 463 mm	1.219,00 €
Cajón cenizas	CS-A00286_00	-	-	26,25 €
Mando a distancia	VATL	-	-	35,00 €

ESP

Estufa de pellet de aire Vip Plus de atractivo diseño con revestimiento en acero disponible en 3 colores diferentes. Estufa muy compacta de 6kW adecuada para instalar en cualquier zona de la vivienda. Estufa de gran rendimiento por la alta temperatura de salida de aire a 100°C. Posibilidad de quemar hueso de aceituna además del pellet (versión OLIVA).

ENG

Air pellet stove Vip Plus styled in an attractive design with steel claddings available in 3 different colours. This 6kW power compact stove is likely to be installed in any room of your home. High performance stove due to high air outlet temperature at 100°C Possibility to burn olive stone (OLIVA version).

VIP PLUS / OLIVA



Potencia nominal
Nominal heat output

6 kw

Potencia máxima
Maximum power

8 kw

Consumo
Consumption

0,5 - 1,3 Kg/h

°Temp Salida
Output

100°C

η

91%

Max

39dB

kg

70kg

m²

60m²

kg

15kg

Colores (Mate)
Colour (Matte)



BCO



BDX



BLK

Certificación
Certifications



Medidas
Measures

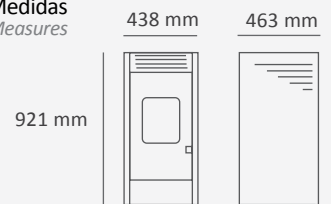

ESP

- Incluye vermiculita en cámara de combustión
- Programación diaria, semanal y fin de semana
- Salida de humos posterior (tubo 25 cm + T90)
- Salida de humos lateral derecho (codo 90º especial)
- Modulación automática
- Protección contra sobrecalentamiento
- Sensor de temperatura
- Control de temperatura de humos

OPCIONAL

- ***OLIVA**: Multicombustible (Pellet y Hueso de aceituna)
- Control remoto vía internet (Kit WIFI)
- Mando a distancia

ENG

- Vermiculite in combustion chamber
- Daily, weekly and weekend programming
- Rear smoke outlet (25cm tube + T90)
- Right side smoke outlet (special 90º edge)
 - Automatic modulation
 - Overheating protection
 - Temperature sensor
- Smoke temperature control

OPTIONAL

- ***OLIVA**: Multifuel (Pellet and olive stone)
- Internet remote control (Kit WIFI)
- Remote control



Very Plus	Referencia	Salida de humos \varnothing	Dimensiones (AxHxL)	P.V.P € (sin IVA)
Very Plus	VERY7-777	80 mm	458 x 920 x 501 mm	1.339,00 €
*Very Plus Oliva	VERY7-OL7	80 mm	458 x 920 x 501 mm	1.399,00 €
Mando a distancia	VALT	-	-	35,00 €

ESP

Estufa de pellet de aire Very Plus compacta y sencilla. El color del revestimiento en acero envuelve el aparato desde su lateral en 3 posibles colores. Temperatura de salida frontal a 115°C con tan solo 7kW. Posibilidad de quemar hueso de aceituna además del pellet (versión OLIVA).

ENG

Air pellet stove Very Plus compact and simple. The cladding's color in steel surrounds the device from its lateral to the upper zone in 3 optional colours. Frontal output temperature at 115°C with just 7kW. Possibility to burn olive stone (OLIVA version).

VERY PLUS / OLIVA



Potencia nominal
Nominal heat output

7 kw

Potencia máxima
Maximum power

9 kw

Consumo
Consumption

0,6 - 1,7 Kg/h

°Temp Salida
Output

115°C

η

92,5%

Max

39dB

kg

74kg

m²

70m²

kg

15kg

Colores (Mate)
Colour (Matte)



BCO



BDX



BLK

Certificación
Certifications



Medidas
Measures

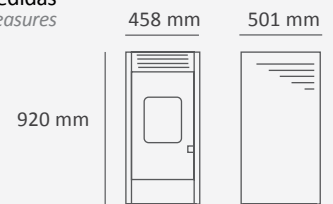

ESP

- Programación diaria, semanal y fin de semana
- Salida de humos posterior (tubo 25 cm + T90)
- Modulación automática
- Protección contra sobrecalentamiento
- Sensor de temperatura en salida de humos
- Control de temperatura de humos

OPCIONAL

- ***OLIVA**: Multicombustible (Pellet y Hueso de aceituna)
- Control remoto vía internet (Kit WIFI)
- Mando a distancia

ENG

- Daily, weekly and weekend programming
- Rear smoke outlet (25cm tube + T90)
- Automatic modulation
- Overheating protection
- Temperature sensor
- Smoke temperature control

OPCIONAL

- ***OLIVA**: Multifuel (Pellet and olive stone)
- Internet remote control (Kit WIFI)
- Remote control



Lis	Referencia	Salida de humos \varnothing	Dimensiones (AxHxL)	P.V.P € (sin IVA)
Lis	LIS8-7777	80 mm	430 x 910 x 530 mm	1.369,00 €
Mando a distancia	VATL	-	-	35,00 €

ESP

Estufa de pellet de aire Lis destaca por su alta temperatura de salida frontal a 100°C, gracias a su potente intercambiador HOTAIR®. Los contornos redondeados en la parte superior e inferior confieren un toque de modernidad a la vez que de elegancia. Según el tamaño de su vivienda podrá optar por una gama de estufas con este innovador diseño. Un altísimo rendimiento de 94,8% será la mejor garantía para el ahorro diario en combustible.

ENG

Lis air pellet stove stands out for its high front outlet temperature of 100 ° C, thanks to its powerful HOTAIR © exchanger. The rounded contours at the top and bottom give a touch of modernity as well as elegance. Depending on the size of your home, you can choose a range of stoves with this innovative design. A very high performance of 94.8% will be the best guarantee for daily fuel savings.



Potencia nominal
Nominal heat output

7,5 kw

Potencia máxima
Maximum power

10 kw

Consumo
Consumption

0,6 - 1,7 Kg/h

Temp Salida
Output

100°C

η

94,8%

Max

39dB

kg

68kg

m²

75m²

kg

14kg

Colores
Colour

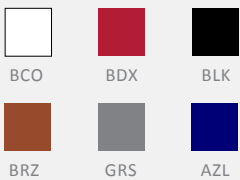

Certificación
Certifications



Medidas
Measures

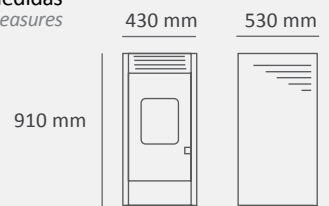

ESP

- Incluye vermiculita en cámara de combustión
- Brasero de acero inoxidable
- Programación diaria, semanal y fin de semana
- Salida de humos posterior (T 90)
- Modulación automática y protección contra sobrecalentamiento
- Sensor de temperatura
- Control de temperatura en salida de humos
- Display vertical ocultable

OPCIONAL

- Control remoto vía internet (Kit WIFI)
- Mando a distancia

ENG

- Vermiculite in combustion chamber
- Stainless steel firepot
- Daily, weekly and weekend programming
- Smoke outlet: rear (T90)
- Automatic modulation and overheating protection
- Temperature sensor
- Smoke temperature control
- Concealed vertical display

OPTIONAL

- Internet remote control (Kit WIFI)
- Remote control



Viva	Referencia	Salida de humos \varnothing	Dimensiones (AxHxL)	P.V.P € (sin IVA)
Viva	VIV8-7777	80 mm	460 x 983 x 469 mm	1.499,00 €
Mando a distancia	VATL	-	-	35,00 €

ESP

Estufa de pellet de aire Viva de atractivo diseño y líneas modernas, busca el contraste con el zócalo. Este contraste realza su figura, cuyo revestimiento en acero esta disponible en 2 colores innovadores: beige y gris titanio. Temperatura de salida frontal a 100°C. Un altísimo rendimiento de 94,8% será la mejor garantía para el ahorro diario en combustible.

ENG

Viva air pellet stove with an attractive design and modern lines, looks for the contrast with the plinth. This contrast enhances your figure, whose steel coating is available in 2 innovative colors: beige and titanium gray. Temperature of front outlet at 100 ° C. A very high performance of 94.8% will be the best guarantee for daily fuel savings



Potencia nominal
Nominal heat output

7,5 kw

Potencia máxima
Maximum power

10 kw

Consumo
Consumption

0,6 - 1,7 Kg/h

Temp Salida
Output

100°C

η

94,8%

Max

39dB

kg

68kg

m²

75m²

kg

14kg

Colores
Colour



N+ B

N+G

Certificación
Certifications

A⁺

CE
EN 14785



Medidas
Measures

983 mm

460 mm



469 mm



ESP

- Incluye vermiculita en cámara de combustión
- Brasero de acero inoxidable
- Programación diaria, semanal y fin de semana
- Salida de humos posterior (T90)
- Modulación automática
- Protección contra sobrecalentamiento
- Sensor de temperatura
- Control de temperatura de humos

OPCIONAL

- Control remoto vía internet (Kit WIFI)
- Mando a distancia

ENG

- Vermiculite in combustion chamber
- Stainless steel brazier
- Daily, weekly and weekend programming
- Smoke outlet: rear (T90)
- Automatic modulation
- Overheating protection
- Temperature sensor
- Smoke temperature control

OPTIONAL

- Internet remote control (Kit WIFI)
- Remote control



Ideal	Referencia	Salida de humos \varnothing	Dimensiones (AxHxL)	P.V.P € (sin IVA)
Ideal	IDCIR8-77	80 mm	534 x 1065 x 575 mm	2.249,00 €
Mando a distancia	VATL	-	-	35,00 €

ESP

La estufa de pellet de aire Ideal de diseño circular, incluye una doble puerta en cristal curvo. El contorno circular es próximo a un círculo perfecto. Estufa de 8,2kW de potencia nominal con temperatura en rejilla frontal de 130°C

ENG

The Pellet air stove Ideal , with circular design, includes a double door in courved glass. The circular shape is almost a perfect circle. Air stove with 8,2kW with frontal output temperature at 130 °C.



Potencia nominal
Nominal heat output

8,2 kw

Potencia máxima
Maximum power

10,2 kw

Consumo
Consumption

0,8 - 2 Kg/h

Temp Salida
Output

130°C

η

90%

Max

39dB

kg

120kg

m²

82m²

kg

15kg

Colores
Colour



BCO
(brillo)



BLK
(mate)

Certificación
Certifications



Medidas
Measures

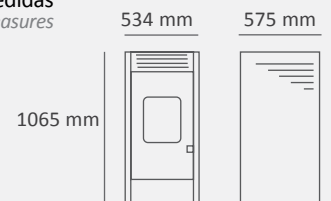

ESP

- DOBLE PUERTA: Puerta exterior curva en vidrio y puerta interior plana
- Programación diaria, semanal y fin de semana
- Salida de humos posterior (T90)
- Modulación automática
- Protección contra sobrecalentamiento
- Sensor de temperatura
- Control de temperatura de humos
- KIDS PROTECTION: Puerta completa frontal en vidrio (doble puerta)

OPCIONAL

- Control remoto vía internet (Kit WIFI)
- Mando a distancia

ENG

- DOUBLE DOOR: Outer curved door in glass and a flat inner door
- Daily, weekly and weekend programming
- Smoke outlet: rear (T90)
- Automatic modulation
- Overheating protection
- Temperature sensor
- Smoke temperature control
- KIDS PROTECTION: Frontal door complet in glass (double door)

OPTIONAL

- Internet remote control (Kit WIFI)
- Remote control

OPTIMA PLUS 9 / OLIVA



Optima PLUS 9	Referencia	Salida de humos \varnothing	Dimensiones (AxHxL)	P.V.P € (sin IVA)
Optima PLUS 9	OPT9-7777	80 mm	520 x 1050 x 516 mm	2.295,00 €
*Optima PLUS 9 Oliva	OPT9-O777	80 mm	520 x1050 x 516 mm	2.355,00 €
Mando a distancia	VATL	-	-	35,00 €

ESP

La estufa de pellet de aire Optima 9 Plus de nueva generación destaca por la mayor temperatura de aire caliente frontal por encima de 150°C. Logra un 20% menos de consumo de pellet a igual potencia y 20% menos de consumo eléctrico. Posibilidad de quemar hueso de aceituna además del pellet (versión OLIVA). Puro silencio gracias al motorreductor de pellet de 24V.

ENG

New generation Optima 9 Plus air pellet stove stands out for the higher temperature of the frontal hot air above 150°C. Achieves 20% less consumption of pellet at the same power and 20% less of electric consumption. Possibility of burning olive stone besides pellet (in OLIVA version). Pure silence thanks to the 24V pellet gearmotor.

OPTIMA PLUS 9 / OLIVA



Potencia nominal
Nominal heat output

8,6 kw

Potencia máxima
Maximum power

11 kw

Consumo
Consumption

0,64-1,93Kg/h

°Temp Salida
Output

150°C

η

95,4%

Icon of ear
Max

42dB

kg

110kg

m²

86m²

kg

22kg

Colores (Mate)
Colour (Matte)



BCO



BDX



BLK



AZL

Certificación
Certifications



Medidas
Measures

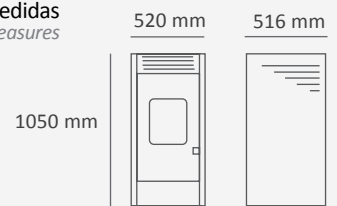

ESP

- MÁXIMO SILENCIO: Motorreductor 24V
- CRISTAL LIMPIO: Cortina de aire
- Frontal de la cámara de combustión en vermiculita
- Brasero de acero inoxidable
- Programación diaria, semanal y fin de semana
- Salida de humos: posterior (tubo 25 cm + T90)
- Modulación automática
- Protección contra sobrecalentamiento
- Sensor de temperatura en salida de humos
- Control de temperatura de humos

OPCIONAL

- *OLIVA: Multicombustible (Pellet y Hueso de aceituna)
- Mando a distancia

ENG

- MAXIMUM SILENCE: Gearmotor 24V
- CLEAN GLASS: Air curtain
- Front of the combustion chamber in vermiculite
- Saitnless steel brazier
- Daily, weekly and weekend programming
- Smoke outlet: rear (25cm tube + T90)
- Automatic modulation
- Overheating protection
- Temperature sensor
- Smoke temperature control

OPCIONAL

- *OLIVA: Multifuel (Pellet and olive stone)
- Remote control



Lila	Referencia	Salida de humos \varnothing	Dimensiones (AxHxL)	P.V.P € (sin IVA)
Lila	LIL10-777	80 mm	430 x 1010 x 530 mm	1.459,00 €
Lila Master	LIL10MA-7	80 mm	430 x 1010 x 530 mm	1.539,00 €
Mando a distancia	VATL	-	-	35,00 €

ESP

Estufa de pellet de aire Lila con contornos redondeados en la parte superior e inferior confieren un toque de modernidad a la vez que de elegancia. La versión convencional de la Lila dispone de un display programable LCD. La versión **MASTER** incorpora un nuevo display de ruletas de fácil manejo.

ENG

*The air pellet stove Lila with rounded edges at the top and bottom give a touch of modernity as well as elegance to the stove. The conventional version of the Lila has a programmable LCD display. The **MASTER** versión incorporates a new easy-to-use roulette display.*

LILA / MASTER



Display LILA



Display LILA MASTER

Potencia nominal
Nominal heat output

9,7 kw

Potencia máxima
Maximum power

12 kw

Consumo
Consumption

0,7 - 2,2 Kg/h

Temp Salida
Output

100°C

η

94,8%

Max

42dB

kg

72kg

m²

100m²

kg

23kg

Colores
Colour



BCO BDX BLK BRZ GRS

Certificación
Certifications



Medidas
Measures

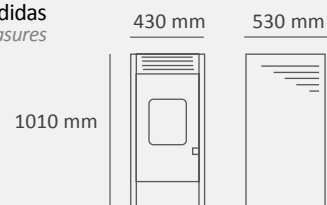

ESP

- Incluye vermiculita en cámara de combustión
- Brasero de acero inoxidable
- Programación diaria, semanal y fin de semana
- Salida de humos posterior (T90)
- Protección contra sobrecalentamiento
- Sensor de temperatura y control de temperatura de humos
- Display vertical ocultable
- **LILA MASTER:** Incluye display de ruletas

OPCIONAL

- Control remoto vía internet (Kit WIFI)
- Mando a distancia
- **LILA MASTER:** No admite: Kit WIFI
- **LILA MASTER:** No admite: Mando a distancia

ENG

- Vermiculite in combustion chamber
- Stainless steel brazier
- Daily, weekly and weekend programming
- Smoke outlet: rear (T90)
- Overheating protection
- Temperature sensor and smoke temperature control
- Concealed vertical display
- **LILA MASTER:** includes a roulette display

OPTIONAL

- Internet remote control (Kit WIFI)
- Remote control
- **LILA MASTER:** Not suitable: Kit WIFI
- **LILA MASTER:** Not suitable: Remote control



Linda Plus	Referencia	Salida de humos \varnothing	Dimensiones (AxHxL)	P.V.P € (sin IVA)
Linda Plus	5110441-7	80 mm	470 x 1000 x 480 mm	1.559,00 €
Mando a distancia	VATL	-	-	35,00 €

ESP

Estufa de pellet de aire Linda Plus con un diseño tradicional. La estufa incorpora decoraciones cromadas que transmiten elegancia. Temperatura de salida frontal a 100°C. Un altísimo rendimiento de 94,8% será la mejor garantía para el ahorro diario en combustible.

ENG

Air pellet stove Linda Plus has a traditional design. The stove has two chromed decorations which transmit elegance. Temperature of front outlet at 100 ° C. A very high performance of 94.8% will be the best guarantee for daily fuel savings.

LINDA PLUS



Potencia nominal
Nominal heat output

9,7 kw

Potencia máxima
Maximum power

12 kw

Consumo
Consumption

0,7 - 2,2 Kg/h

Temp Salida
Output

100°C

η

94,8%

Max

42dB

kg

80kg

m²

100m²

kg

23kg

Colores
Colour



BCO



BDX



BLK



BRZ

Certificación
Certifications



CE
EN 14785



Medidas
Measures

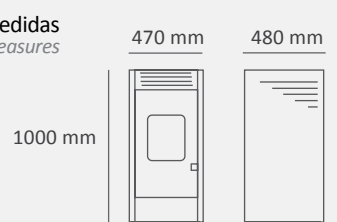

ESP

- Incluye vermiculita en cámara de combustión
- Manilla y perfiles frontales cromados
- Brasero de acero inoxidable
- Programación diaria, semanal y fin de semana
- Salida de humos posterior (T90)
- Modulación automática
- Protección contra sobrecalentamiento
- Sensor de temperatura
- Control de temperatura de humos

OPCIONAL

- Control remoto vía internet (Kit WIFI)
- Mando a distancia

ENG

- Vermiculite in combustion chamber
- Handle and frontal profiles chromed
- Stainless steel brazier
- Daily, weekly and weekend programming
- Smoke outlet: rear (T90)
- Automatic modulation
- Overheating protection
- Temperature sensor
- Smoke temperature control

OPTIONAL

- Internet remote control (Kit WIFI)
- Remote control



Corner Plus	Referencia	Salida de humos \varnothing	Dimensiones (AxHxL)	P.V.P € (sin IVA)
Corner Plus	CORN-7777	80 mm	859 x 974 x 694 mm	2.169,00 €
Mando a distancia	VATL	-	-	35,00 €

ESP

La estufa de pellet de aire Corner Plus ha sido dotada del nuevo sistema de direccionamiento del aire SUIT patentado. Este sistema permite al usuario final **dirigir el aire caliente** expulsado hacia la zona de la vivienda a calentar. El aire es orientable en 2 sentidos evitando obstáculos que impidan la correcta difusión del aire. La estufa ha sido diseñada para su integración en esquinas.

ENG

*The Corner Plus air pellet stove has been equipped with the new patented SUIT air steering system. This system allows the end user to **direct the hot air** expelled to the area of the house to be heated. The air is adjustable in 2 directions avoiding obstacles that prevent the correct diffusion of the air. The stove has been designed for integration in corners.*

CORNER PLUS

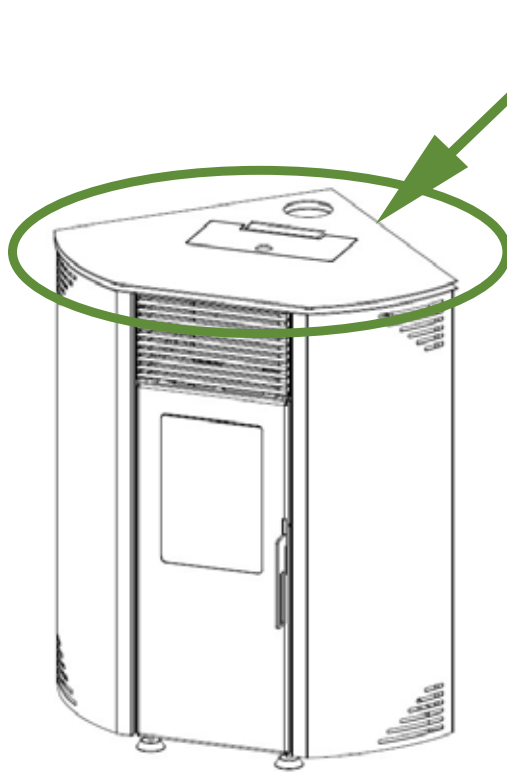

SISTEMA SUIT: Aire direccionable

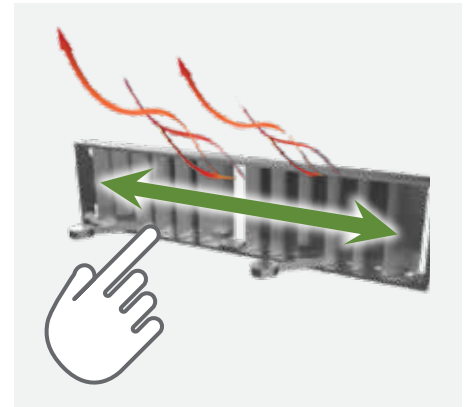

Potencia nominal
Nominal heat output

9,7 kw

Potencia máxima
Maximum power

12 kw

Consumo
Consumption

0,7 - 2,2 Kg/h

Temp Salida
Output

100°C

η

94,8%

Max

42dB

kg

80kg

m²

100m²

kg

23kg

Colores
Colour



BCO



BLK

Certificación
Certifications



CE
EN 14785



Medidas
Measures

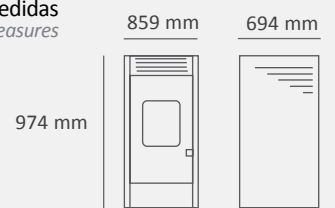

ESP

- Incluye vermiculita en cámara de combustión
- Parte posterior 90° para esquinas.
- SISTEMA SUIT dirige el aire.
- Brasero de acero inoxidable
- Programación diaria, semanal y fin de semana
- Salida de humos posterior (T90 + 0,25m) o superior (T90 + codo 45°)
- Modulación automática
- Protección contra sobrecalentamiento
- Sensor de temperatura
- Control de temperatura de humos

OPCIONAL

- Control remoto vía internet (Kit WIFI)
- Mando a distancia

ENG

- Vermiculite in combustion chamber
- Back side 90° for corners
- SUIT air directioning system
- Stainless steel brazier
- Daily, weekly and weekend programming
- Smoke outlet: superior (T90 + 45° bent)
- Automatic modulation
- Overheating protection
- Temperature sensor
- Smoke temperature control

OPTIONAL

- Internet remote control (Kit WIFI)
- Remote control



Belinda	Referencia	Salida de humos \varnothing	Dimensiones (AxHxL)	P.V.P € (sin IVA)
Belinda	BELINDA-7	80 mm	513 x 1000 x 595 mm	1.659,00 €
Mando a distancia	VATL	-	-	35,00 €

ESP

Estufa de pellet de aire Belinda con un diseño tradicional. La estufa combina la **puerta y el frontal de hierro fundido** con dos decoraciones cromadas que transmiten robustez. El interior incorpora paneles de vermiculita para mejor aprovechamiento del calor.

ENG

*Belinda air pellet stove with a traditional design. The stove combines the **door and the front of cast iron** with two chrome decorations that convey robustness. The inside incorporates vermiculite panels for better use of heat.*



Potencia nominal
Nominal heat output

10 kw

Potencia máxima
Maximum power

12 kw

Consumo
Consumption

0,8 - 2,4 Kg/h

Temp Salida
Output

115°C

η

87,6%

Max

42dB

kg

108kg

m²

100m²

kg

16kg

Colores
Colour



BCR



BDX



BLK

Certificación
Certifications



CE
EN 14785



Medidas
Measures

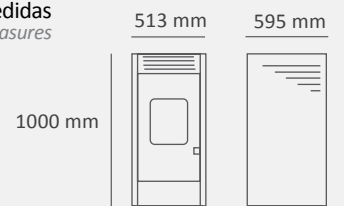

ESP

- Laterales de la cámara de combustión en vermiculita
- Perfiles frontales cromados
- Puerta, top superior y brasero en fundición.
- Programación diaria, semanal y fin de semana
- Salida de humos posterior (T90)
- Modulación automática
- Protección contra sobrecalentamiento
- Sensor de temperatura
- Control de temperatura de humos

OPCIONAL

- Control remoto vía internet (Kit WIFI)
- Mando a distancia

ENG

- Sides of the combustion chamber in vermiculite
- Chrome front profiles
- Door, top top and brazier in cast iron.
- Daily, weekly and weekend programming
- Smoke outlet: rear (T90)
- Automatic modulation
- Overheating protection
- Temperature sensor
- Smoke temperature control

OPTIONAL

- Internet remote control (Kit WIFI)
- Remote control



Louvre	Referencia	Salida de humos ϕ	Dimensiones (A x H x L)	P.V.P € (sin IVA)
Louvre	VLOUVRE10-777	80 mm	520 x 770 x 600 mm	2.395,00 €
KIT humos central superior	SUPLOU	-	-	225,00 €
Mando a distancia	VATL	-	-	35,00 €

ESP

Estufa de pellet de aire Louvre, de 10kW, capaz de calefactar hasta una vivienda de 100m². La estufa incorpora decoraciones rústicas que transmiten un toque clásico. La salida de aire esta bajo la puerta con 2 ventiladores potentes de 150m³/h cada uno.

ENG

Air pellet stove Louvre with 10kW power, therefore it is capable to heat a 100m² house. The stove has a rustic decoration which transmits classic touch. The air outlet is below the door with 2 powerful ventilators of 150m³/h each one.



Potencia nominal
Nominal heat output

10 kw

Potencia máxima
Maximum power

12 kw

Consumo
Consumption

0,7 - 2,2 Kg/h

Temp Salida
Output

100°C

η

94%

Max

45dB

kg

100kg

m²

100m²

kg

15kg

Colores
Colour



BLK
(mate)

Certificación
Certifications



Medidas
Measures

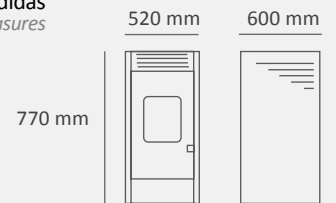

ESP

- Incluye vermiculita en cámara de combustión
- Brasero de acero inoxidable
- Programación diaria, semanal y fin de semana
- Salida de humos posterior (codo 90 especial + 0,25 + T90)
- Salida de humos superior interna izquierda (conector H-H)
- Salida de humos central superior (kit de humos central superior)
- Modulación automática
- Protección contra sobrecalentamiento
- Sensor de temperatura y control de temperatura de humos

OPCIONAL

- Control remoto vía internet (Kit WIFI)
- Mando a distancia

ENG

- Vermiculite in combustion chamber
- Stainless steel brazier
- Daily, weekly and weekend programming
- Smoke outlet: rear (special curve 90 +0.25m +T90)
- Smoke outlet: top internal left (connector female-female)
- Smoke outlet: top central (special kit)
- Automatic modulation
- Overheating protection
- Temperature sensor and smoke temperature control

OPTIONAL

- Internet remote control (Kit WIFI)
- Remote control



Linux	Referencia	Salida de humos \varnothing	Dimensiones (AxHxL)	P.V.P € (sin IVA)
Linux	LIN12-777	80 mm	470 x 1005 x 530 mm	1.719,00 €
Mando a distancia	VATL	-	-	35,00 €

ESP

Estufa de pellet de aire Linux destaca por su alta **temperatura de salida frontal a 115°C**, gracias a su potente intercambiador HOTAIR®. Los contornos redondeados en la parte superior e inferior confieren un toque de modernidad a la vez que de elegancia. Según el tamaño de su vivienda podrá optar por una gama de estufas con este innovador diseño. Un altísimo rendimiento de 94,8% será la mejor garantía para el ahorro diario en combustible.

ENG

Linux air pellet stove stands out for its high front outlet temperature of 115 ° C, thanks to its powerful HOTAIR © exchanger. The rounded contours at the top and bottom give a touch of modernity as well as elegance. Depending on the size of your home, you can choose a range of stoves with this innovative design. A very high performance of 94.8% will be the best guarantee for daily fuel savings.



Potencia nominal
Nominal heat output

11 kw

Potencia máxima
Maximum power

13 kw

Consumo
Consumption

1,0 - 2,3 Kg/h

Temp Salida
Output

115°C

η

94,8%

Max

45dB

kg

91kg

m²

110m²

kg

23kg

Colores
Colour



BCO



BDX



BLK

Certificación
Certifications



CE
EN 14785



Medidas
Measures

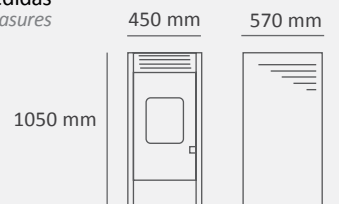

ESP

- Incluye vermiculita en cámara de combustión
- Brasero de acero inoxidable
- Programación diaria, semanal y fin de semana
- Salida de humos posterior (T90)
- Modulación automática
- Protección contra sobrecalentamiento
- Sensor de temperatura y control de temperatura de humos
- Display vertical ocultable

OPCIONAL

- Control remoto vía internet (Kit WIFI)
- Mando a distancia

ENG

- Vermiculite in combustion chamber
- Stainless steel brazier
- Daily, weekly and weekend programming
- Smoke outlet: rear (T90)
- Automatic modulation
- Overheating protection
- Temperature sensor and smoke temperature control
- Hidden vertical display

OPTIONAL

- Internet remote control (Kit WIFI)
- Remote control



Zenith	Referencia	Salida de humos \varnothing	Dimensiones (AxHxL)	P.V.P € (sin IVA)
Zenith	ZENITH-77	80 mm	500 x 1021 x 545 mm	2.259,00 €
Mando a distancia	VATL	-	-	35,00 €

ESP

Estufa de pellet de aire Zenith, de 13kW y un **magnífico caudal de 390 m³/h**, capaz de calefactar hasta una vivienda de 130m² con holgura. La estufa incorpora decoraciones cromadas en todo el contorno superior que transmiten gran elegancia.

ENG

*Zenith air pellet stove, 13kW and a **magnificent flow of 390 m³/h**, capable of heating up to a 130m² home with ease. The stove incorporates chrome decorations around the upper contour that convey great elegance.*



Potencia nominal
Nominal heat output

13 kw

Potencia máxima
Maximum power

15 kw

Consumo
Consumption

0,9 - 2,9 Kg/h

Temp Salida
Output

100°C

η

91,3%

Max

52dB

kg

120kg

m²

130m²

kg

25kg

Colores
Colour



BCO



BLK

Certificación
Certifications



kiwa
Partner for progress

Medidas
Measures

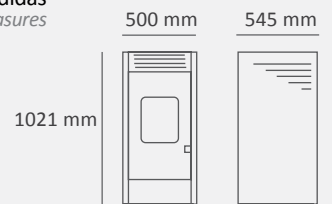

ESP

- Brasero de acero inoxidable
- Programación diaria, semanal y fin de semana
- Salida de humos posterior (T90)
- Modulación automática
- Protección contra sobrecalentamiento
- Sensor de temperatura
- Control de temperatura de humos

OPCIONAL

- Control remoto vía internet (Kit WIFI)
- Mando a distancia

ENG

- Stainless steel brazier
- Daily, weekly and weekend programming
- Smoke outlet: rear (T90)
- Automatic modulation
- Overheating protection
- Temperature sensor
- Smoke temperature control

OPTIONAL

- Internet remote control (Kit WIFI)
- Remote control

■ ESTUFAS CANALIZADAS

REPARTE EL CALOR POR TODA LA CASA

AIR FLOW STOVES

DISTRIBUTES HEAT THROUGHOUT THE HOUSE



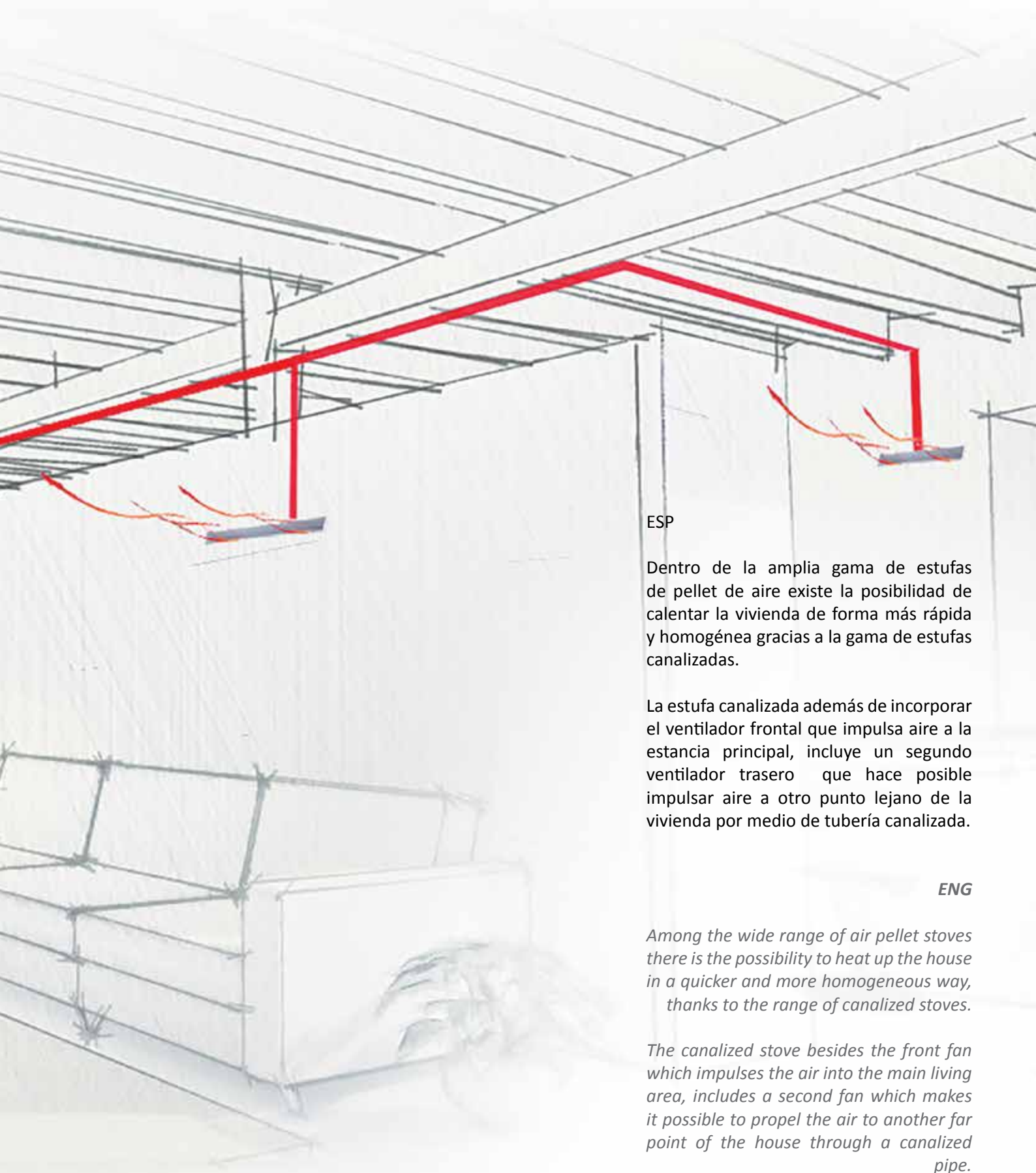

ESP

Dentro de la amplia gama de estufas de pellet de aire existe la posibilidad de calentar la vivienda de forma más rápida y homogénea gracias a la gama de estufas canalizadas.

La estufa canalizada además de incorporar el ventilador frontal que impulsa aire a la estancia principal, incluye un segundo ventilador trasero que hace posible impulsar aire a otro punto lejano de la vivienda por medio de tubería canalizada.

ENG

Among the wide range of air pellet stoves there is the possibility to heat up the house in a quicker and more homogeneous way, thanks to the range of canalized stoves.

The canalized stove besides the front fan which impulses the air into the main living area, includes a second fan which makes it possible to propel the air to another far point of the house through a canalized pipe.



Optima PLUS 11	Referencia	Salida de humos \varnothing	Dimensiones (AxHxL)	P.V.P € (sin IVA)
Optima PLUS11	OPT11-777	80 mm	520 x 1050 x 516 mm	2.499,00 €
*Optima WIND	OPTW11-77	80 mm	520 x 1050 x 516 mm	2.749,00 €
Mando a distancia	VATL	-	-	35,00 €

ESP

La estufa de pellet aire o canalizada Optima Plus 11 de nueva generación destaca por la mayor temperatura de **aire caliente frontal por encima de 170°C. Logra grandes ahorros; 20% menos de consumo de pellet a igual potencia y 20% menos de consumo eléctrico.** El efecto del calentamiento es súbito gracias al ventilador centrífugo de 230m³/h. La versión canalizada incorpora un segundo ventilador independiente que añade un caudal 150m³/h al calentamiento de la vivienda.

ENG

*The new generation Optima Plus 11 air or ducted pellet stove stands out for its higher **frontal hot air temperature above 170°C.** It achieves **big savings; 20% less pellet consumption at the same power and 20% less electricity consumption.** The heating effect is sudden thanks to the 230m³/h centrifugal fan. The channeled version incorporates a second independent fan that adds a flow rate of 150m³/h to heating the home.*

OPTIMA PLUS 11 / OPTIMA PLUS 11 WIND



AIRE + CANALIZADA



Potencia nominal
Nominal heat output

OPTIMA: **10,7 kw**

O. WIND:

Potencia máxima
Maximum power

14 kw

Consumo
Consumption

0,64-2,35 Kg/h

Temp Salida
Output

170°C
140°C front.
115°C canal.

η

95,4%

Max

42dB

kg

110kg

m²

107m²

kg

22kg

Colores
Colour



BCO



BDX



BLK



AZL

Certificación
Certifications

A+

CE

EN 14785



ISTITUTO ITALIANO DEL MARCHIO DI QUALITÀ

Medidas
Measures

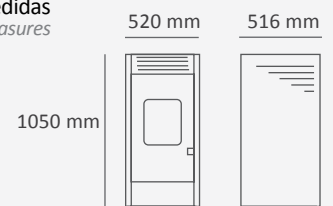

ESP

- MÁXIMO SILENCIO: Motorreductor 24V
- CRISTAL LIMPIO: cortina de aire
- Frontal cámara combustión en vermiculite
- Programación diaria, semanal y fin de semana
- Salida de humos: posterior (tubo 25 cm + T90)
- Modulación automática
- Protección contra sobrecalentamiento
- Sensor de temperatura en salida de humos
- Control de temperatura de humos
- *WIND: 1 salida canalizable Ø 80mm. 2 ventiladores independientes (frontal + trasero)

OPCIONAL

- Mando a distancia

ENG

- MAXIMUM SILENCE: Gearmotor 24V
- CLEAN GLASS: Air curtain
- Frontal combustion chamber in vermiculite
- Daily, weekly and weekend programming
- Smoke outlet: rear (25cm tube + T90)
- Automatic modulation
- Overheating protection
- Temperature sensor
- Smoke temperature control
- *WIND: 1 ductable outlet Ø 80mm, 2 independent fans (front + rear)

OPCIONAL

- Remote control

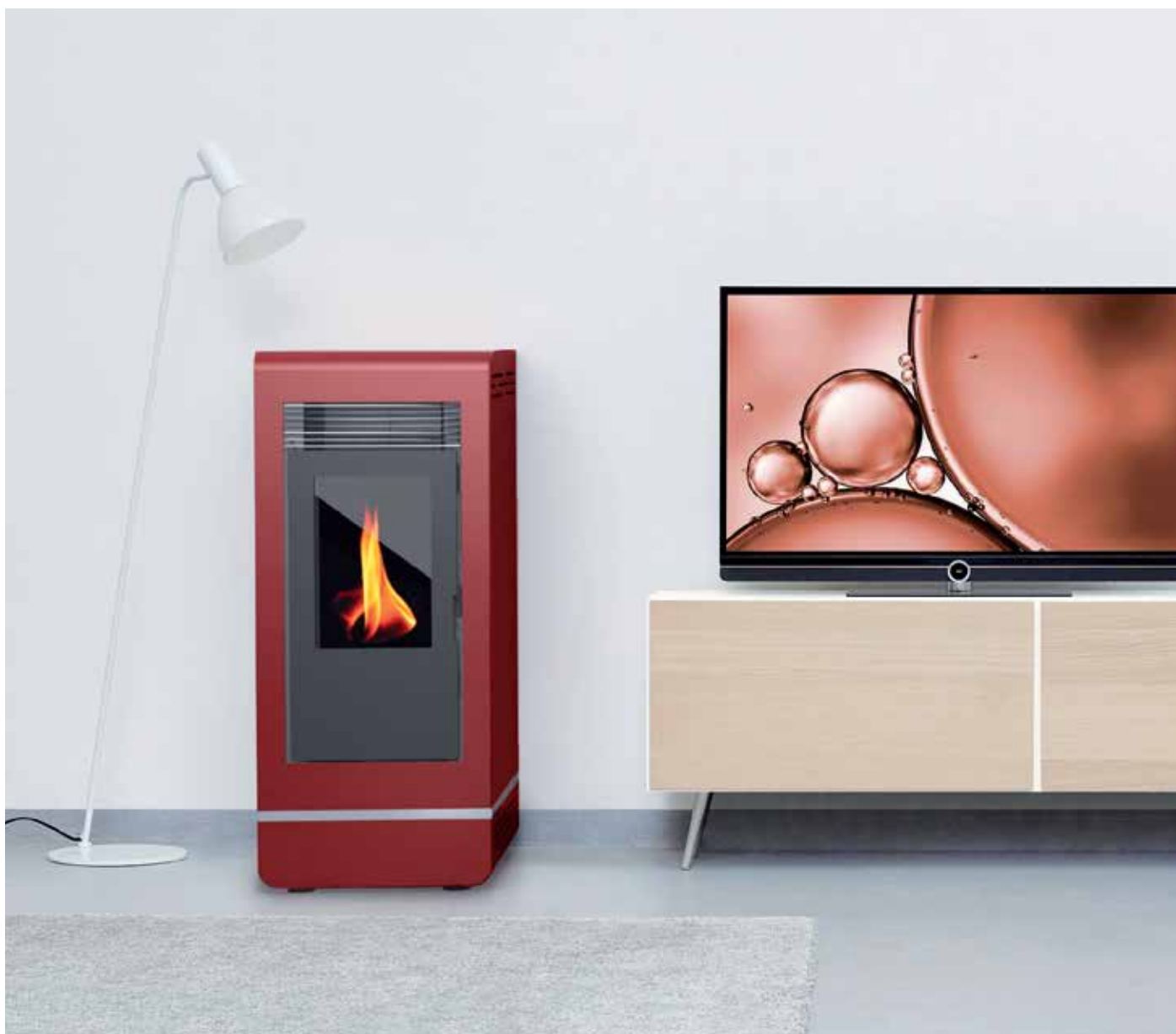

Lipton	Referencia	Salida de humos \varnothing	Dimensiones (AxHxL)	P.V.P € (sin IVA)
Lipton	LIP12-777	80 mm	450 x 1050 x 570 mm	1.799,00 €
*Lipton WIND	LIPTONW-7	80 mm	450 x 1050 x 570 mm	2.199,00 €
Mando a distancia	VATL	-	-	35,00 €

ESP

Estufa de pellet de aire ventilada o canalizada Lipton con un innovador diseño y decoraciones en cromo para alzar la elegancia de los contornos redondeados. **Temperatura de salida frontal a 135°C** junto a un altísimo rendimiento de 94,8% será la mejor garantía para el ahorro diario en combustible. La versión canalizada emplea 3 ventiladores, uno frontal y dos para la canalización trasera, totalizando 690 m3/h de caudal de calentamiento.

ENG

*Lipton ventilated or channeled pellet stove with an innovative design and chrome decorations to enhance the elegance of the rounded contours. **Front outlet temperature of 135°C** together with a very high efficiency of 94.8% will be the best guarantee for daily fuel savings. The ducted version uses 3 fans, one front and two for the rear ducting, totalizing 690 m3/h of heating flow.*

LIPTON / LIPTON WIND



AIRE + CANALIZADA



Potencia nominal
Nominal heat output

LIPTON: **12 kw**

L. WIND:

Potencia máxima
Maximum power

14 kw

Consumo
Consumption

1 - 2,8 Kg/h

Temp Salida
Output

135°C
115°C front.
75°C canal.

η

94,8%

Max

48dB

kg

95kg

m²

120m²

kg

23kg



Colores
Colour



Certificación
Certifications

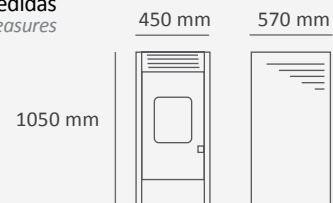

Medidas
Measures



ESP

- Incluye vermiculita en cámara de combustión
- Incluye perfiles cromados en la parte inferior (frontal y laterales)
- Brasero de acero inoxidable
- Programación diaria, semanal y fin de semana
- Salida de humos posterior (T90)
- Modulación automática
- Protección contra sobrecalentamiento
- Sensor de temperatura y control de temperatura de humos
- Display vertical ocultable
- ***WIND:** 2 salidas canalizadas Ø 80mm con 3 ventiladores (frontal + 2 traseros)

OPCIONAL

- Control remoto vía internet (Kit WIFI)
- Mando a distancia

ENG

- Vermiculite in combustion chamber
- Includes chrome profiles at the bottom (front and sides)
- Stainless steel brazier
- Daily, weekly and weekend programming
- Smoke outlet: rear (T90)
- Automatic modulation
- Overheating protection
- Temperature sensor and smoke temperature control
- Hidden vertical display
- ***WIND:** 2 ductable outlets Ø 80mm with 3 fans (frontal + 2 rears)

OPTIONAL

- Internet remote control (Kit WIFI)
- Remote control



Zeppelin	Referencia	Salida de humos \varnothing	Dimensiones (AxHxL)	P.V.P € (sin IVA)
Zeppelin	ZEPPELIN7	80 mm	693 x 1119 x 634 mm	2.919,00 €
*Zeppelin WIND	ZEPWIND-7	80 mm	693 x 1119 x 634 mm	3.349,00 €
Mando a distancia	VATL	-	-	35,00 €

ESP

Estufa de pellet de aire o canalizada de 16kW capaz de calefactar hasta una vivienda de 160m². La estufa incorpora elegantes decoraciones cromadas en todo el contorno superior. La versión canalizada emplea 3 ventiladores, uno frontal y 2 para la canalización trasera, que totalizan un brutal **caudal de aire 690 m³/h** disponiendo de dos salidas posteriores para lograr un calentamiento homogéneo de la vivienda.

ENG

16kW ventilated air or channeled air pellet stove capable of heating up to a 160m² home. The stove incorporates elegant chrome decorations around the upper contour. The channeled version uses 3 fans, one for the front and 2 for the rear ducting, which totalize an extreme air flow of 690 m³/h with two rear outlets to achieve homogeneous heating of the home.

ZEPPELIN / ZEPPELIN WIND

AIRES + CANALIZADA



Potencia nominal
Nominal heat output

15,7 kw

Potencia máxima
Maximum power

18 kw

Consumo
Consumption

1,5 - 3,6 Kg/h

Temp Salida
Output

100°C

η

89%

Max

55dB

kg

160kg

m²

160m²

kg

55kg

Colores
Colour



BCO



BLK

Certificación
Certifications

A⁺

CE
EN 14785

kiwa
Partner for progress

Medidas
Measures

693 mm 634 mm
1119 mm



ESP

- Incluye vermiculita en cámara de combustion
- Brasero de acero inoxidable
- Programación diaria, semanal y fin de semana
- Salida de humos posterior (T90)
- Modulación automática
- Protección contra sobrecalentamiento
- Sensor de temperatura y control de temperatura de humos
- ***WIND:** 2 salidas canalizadas Ø 80mm con 3 ventiladores (1 frontal + 2 traseros)

OPCIONAL

- Control remoto vía internet (Kit WIFI)
- Mando a distancia

ENG

- Includes vermiculite in combustion chamber
- Stainless steel brazier
- Daily, weekly and weekend programming
- Smoke outlet: rear (T90)
- Automatic modulation
- Overheating protection
- Temperature sensor and smoke temperature control
- ***WIND:** 2 ductable outlets Ø 80mm with 3 fans (1 frontal + 2 rears)

OPTIONAL

- Internet remote control (Kit WIFI)
- Remote control

LYON WIND

CANALIZADA

NEW



Lyon WIND	Referencia	Salida de humos \varnothing	Dimensiones (AxHxL)	P.V.P € (sin IVA)
Lyon WIND	30006FG01	80 mm	502 x 1044 x 522 mm	1.880,00 €
Mando a distancia	VATL	-	-	35,00 €

ESP

Estufa de pellet de aire canalizada Lyon con diseño compacto y sencillo. El color del revestimiento en acero envuelve el aparato desde su lateral en 3 posibles colores. La versión canalizada está diseñada para impulsar aire a otros puntos de la vivienda. La estufa emplea **dos ventiladores independientes**, uno frontal y un segundo para la canalización.

ENG

*The air flow Lyon stove has a compact and plain design. The steel cladding is in 3 colours available. The canalized version is designed to propel air to other places in the house. The stove has **2 independent fans**. A frontal one and another one for the canalization.*

LYON WIND

CANALIZADA



Potencia nominal
Nominal heat output

9,7 kw

Potencia máxima
Maximum power

12 kw

Consumo
Consumption

0,8-2,2 Kg/h

Temp
Salida
Output

110°C front.
75°C canal.

η

94,8%

Max

42dB

kg

108kg

m²

100m²

kg

23kg

Colores
Colour



BCO



BDX



BLK

Certificación
Certifications



Medidas
Measures

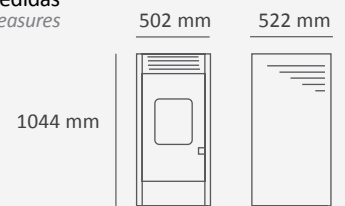

ESP

- Incluye vermiculita en cámara de combustión
- Brasero de acero inoxidable
- Programación diaria, semanal y fin de semana
- Salida de humos posterior (0,25m + T90)
- Modulación automática
- Protección contra sobrecalentamiento
- Sensor de temperatura y control de temperatura de humos
- Display vertical ocultable
- *WIND: 1 salida canalizada Ø 80mm con 2 ventiladores (frontal + trasero)

OPCIONAL

- Control remoto vía internet (Kit WIFI)
- Mando a distancia

ENG

- Vermiculite in combustion chamber
- Stainless steel brazier
- Daily, weekly and weekend programming
- Smoke outlet: rear (0,25m + T90)
- Automatic modulation
- Overheating protection
- Temperature sensor and smoke temperature control
- Concealed vertical display
- *WIND: 1 ductable outlets Ø 80mm with 2 fans (frontal + rear)

OPTIONAL

- Internet remote control (Kit WIFI)
- Remote control



Odesia WIND	Referencia	Salida de humos ϕ	Dimensiones (AxHxL)	P.V.P € (sin IVA)
Odesia WIND	ODS11-777	80 mm	601 x 1041 x 553 mm	2.499,00 €
Mando a distancia	VATL	-	-	35,00 €

ESP

Elegida como la mejor estufa canalizable del certamen BEPOSITIVE de Lyon. Estufa diseñada para **canalizaciones muy exigentes** pues dispone de 2 ventiladores traseros para canalizar de forma independiente a una altísima temperatura 95°C. Además dispone de otros dos ventiladores frontales que impulsan a a 115 °C. Estos 4 ventiladores mueven un **increíble caudal de 760m³/h**. Disponible en 3 colores.

ENG

*Chosen as the best duct stove in the BEPOSITIVE competition in Lyon. Stove designed for very demanding ducting installations as it has 2 rear fans to channel independently at a very high temperature of 95°C. It also has two other front fans that drive at 115 °C. These 4 fans move **an incredible flow of 760m³/h**. Available in 3 colors.*

ODESIA WIND

CANALIZADA



Potencia nominal
Nominal heat output

11,5 kw

Potencia máxima
Maximum power

14 kw

Consumo
Consumption

0,8 - 2,8 Kg/h

Temp Salida
Output

**115°C front.
90°C canal.**

η

95,4%

Max

55dB

kg

127kg

m²

115m²

kg

23kg

Colores (Mate)
Colour (Matte)



BCO



BDX



BLK

Certificación
Certifications



CE
EN 14785



Medidas
Measures

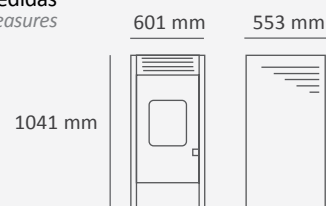

ESP

- 2 salidas canalizables Ø 80mm con 2 ventiladores independientes
- Laterales de cámara de combustión y deflector de llamas en vermiculita
- 2 ventiladores frontales
- Brasero de fundición
- Programación diaria, semanal y fin de semana
- Salida de humos posterior (T90 + tubo 0,25)
- Modulación automática
- Protección contra sobrecalentamiento
- Sensor de temperatura y control de temperatura de humos

OPCIONAL

- Control remoto vía internet (Kit WIFI)
- Mando a distancia

ENG

- 2 ductable outlets Ø 80mm with 2 independent fans
- Sides of combustion chamber and deflector flames in vermiculite
- 2 front fans
- Cast iron firepot
- Daily, weekly and weekend programming
- Smoke outlet: rear (T90 + pipe 0,25)
- Automatic modulation
- Overheating protection
- Temperature sensor and smoke temperature control

OPTIONAL

- Internet remote control (Kit WIFI)
- Remote control



ESTUFAS DE PASILLO
PERFECTAS PARA ESPACIOS REDUCIDOS

CORRIDOR STOVES
PERFECT FOR REDUCED SPACES





Kinox	Referencia	Salida de humos \varnothing	Dimensiones (AxHxL)	P.V.P € (sin IVA)
Kinox	KINOX-777-COLOR	80 mm	743 x 1010 x 277 mm	1.799,00 €
Mando a distancia	VATL	-	-	35,00 €

ESP

La estufa de pasillo de 28cms KINOX ha sido dotada del nuevo **sistema de direccionamiento del aire SUIT** patentado. Este sistema permite al usuario final **dirigir el aire caliente** expulsado hacia la zona de la vivienda a calentar. Así al instalarse en un pasillos o estancias alargadas podemos orientar el chorro de aire en 2 sentidos hacia donde se necesita ganando en efectividad.

ENG

*The 28 cm KINOX corridor stove has been equipped with the new patented **SUIT air directing system**. This system allows the end user to **direct the hot air** expelled towards the area of the home to be heated. Thus, when installed in corridors or long rooms, we can direct the air jet in 2 directions to where it is needed, gaining in effectiveness.*



SISTEMA SUIT: Aire direccionable

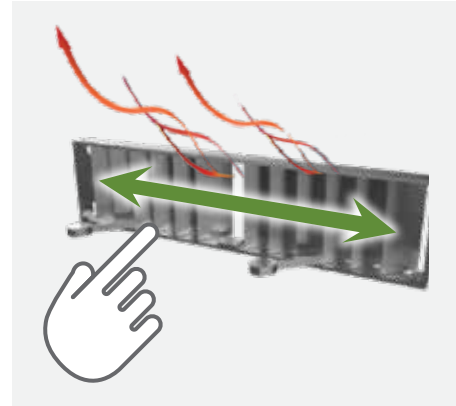

Potencia nominal
Nominal heat output

7,2 kw

Potencia máxima
Maximum power

9,2 kw

Consumo
Consumption

0,6-1,68 Kg/h

Temp Salida
Output

95°C

η

95%

Max

45dB

kg

67kg

m²

72m²

kg

15kg

Colores
Colour



BCO

Certificación
Certifications



Medidas
Measures

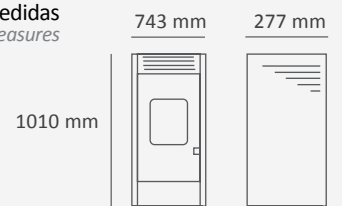

ESP

- SISTEMA SUIT dirige el aire.
- Salida de humos posterior (necesario codo 90 especial)
- Salida de humos lateral derecha (necesario codo 90 especial)
- Salida de humos superior (necesario conector hembra-hembra)
- Programación diaria, semanal y fin de semana
- Modulación automática
- Protección contra sobrecalentamiento
- Sensor de temperatura
- Control de temperatura de humos

OPCIONAL

- Control remoto vía internet (Kit WIFI)
- Mando a distancia

ENG

- SUIT air directioning system
- Rear smoke outlet (special 90 elbow required)
- Right side smoke outlet (special 90 elbow required)
- Upper smoke outlet (female-female connector required)
- Daily, weekly and weekend programming
- Automatic modulation
- Overheating protection
- Temperature sensor
- Smoke temperature control

OPTIONAL

- Internet remote control (Kit WIFI)
- Remote control



Avalon	Referencia	Salida de humos \varnothing	Dimensiones (AxHxL)	P.V.P € (sin IVA)
Avalon	VAVAN11ST	80 mm	770 x 970 x 280 mm	2.495,00 €
Mando a distancia	VATL	-	-	35,00 €

ESP

Estufa de pellet de aire Avalon de atractivo diseño con acabado en piedra. Es un aparato ideal para instalarse en pasillos o salones pequeños gracias a su mínima anchura de tan sólo 28cm. Instalación muy versátil.

ENG

Air pellet Avalon stove has an attractive design with stone front. It is a perfect device to be installed in corridors or small halls thanks to its minimum width of only 28cm. Very versatile installation.



Potencia nominal
Nominal heat output

11 kw

Potencia máxima
Maximum power

13 kw

Consumo
Consumption

1 - 2,2 Kg/h

°Temp Salida
Output

115°C

η

93%

Max

45dB

kg

95kg

m²

110m²

kg

15kg

Colores
Colour



NEGRO OXIDO



CALACATTA

Certificación
Certifications



Medidas
Measures

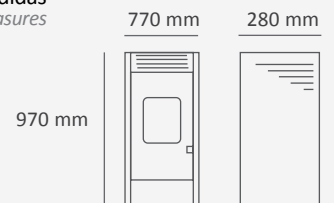

ESP

- Vermiculita en cámara de combustión
- Frontal con acabado en PIEDRA
- Brasero de acero inoxidable
- Programación diaria, semanal y fin de semana
- Salida de humos posterior (codo especial 90 y T90), superior dcha (conector H-H) o lateral derecho (codo especial 90 + T90)
- Modulación automática
- Protección contra sobrecalentamiento
- Sensor de temperatura
- Control de temperatura de humos
- Display vertical ocultable

OPCIONAL

- Control remoto vía internet (Kit WIFI)
- Mando a distancia

ENG

- Vermiculite in combustion chamber
- Stove with STONE front
- Stainless steel firepot
- Daily, weekly and weekend programming
- Smoke outlet: rear (special bent 90 + T90), top right (connector FEMALE) or right lateral (special bent 90 + T90)
- Automatic modulation
- Overheating protection
- Temperature sensor
- Smoke temperature control
- Concealed vertical display

OPTIONAL

- Internet remote control (Kit WIFI)
- Remote control



Stylo Wood	Referencia	Salida de humos \varnothing	Dimensiones (AxHxL)	P.V.P € (sin IVA)
Stylo Wood	STYLOWOOD7-ABE	80 mm	650 x 1200 x 280 mm	2.249,00 €
Mando a distancia	VATL	-	-	35,00 €

ESP

Estufa de aire Stylo Wood de atractivo diseño con acabado en **madera natural de abedul**. Esta estufa de pasillo de 28cms ha sido dotada del nuevo sistema de direccionamiento del aire SUIT patentado. Este sistema permite al usuario final **dirigir el aire caliente** expulsado hacia la zona de la vivienda a calentar. Así al instalarse en pasillos o estancias alargadas podemos orientar el chorro de aire en 2 sentidos hacia donde se necesita ganando en efectividad.

ENG

*Stylo Wood air stove with an attractive design finished in **natural birch wood**. This 28cm corridor stove has been equipped with the new patented SUIT air directing system. This system allows the end user to **direct the hot air** expelled towards the area of the home to be heated. Thus, when installed in corridors or long rooms, we can direct the air jet in 2 directions to where it is needed, gaining in effectiveness.*



SISTEMA SUIT: Aire direccionable

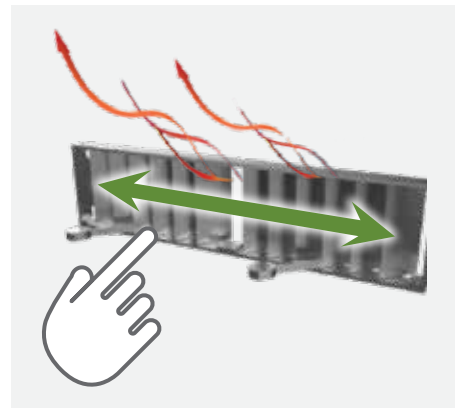

Potencia nominal
Nominal heat output

11 kw

Potencia máxima
Maximum power

13 kw

Consumo
Consumption

1 - 2,2 Kg/h

Temp Salida
Output

115°C

η

93%

Max

45dB

kg

95kg

m²

110m²

kg

15kg

Colores
Colour



ABEDUL

Certificación
Certifications



Medidas
Measures

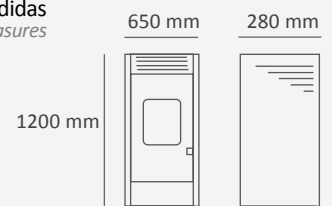

ESP

- SISTEMA SUIT dirige el aire
- Vermiculita en cámara de combustión
- Brasero de acero inoxidable
- Programación diaria, semanal y fin de semana
- Modulación automática
- Protección contra sobrecalentamiento y sensor de temperatura
- Control de temperatura de humos
- 2 ventiladores frontales superiores, caudal max 150+150 m3/h
- Salida humos: posterior (necesario codo 90 especial) o lateral dcho (necesario codo 90 especial)
- Doble puerta

OPCIONAL

- Control remoto vía internet (Kit WIFI)
- Mando a distancia

ENG

- SUIT air directioning system
- Vermiculite in combustion chamber
- Stainless steel firepot
- Daily, weekly and weekend programming
- Automatic modulation
- Overheating protection and temperature sensor
- Smoke temperature control
- 2 front fans, maximum flow 150+150 m3/h
- Smoke outlet: rear (special curve 90 +T90) or lateral right (special curve 90 +T90)
- Double door

OPTIONAL

- Internet remote control (Kit WIFI)
- Remote control



Avant	Referencia	Salida de humos \varnothing	Dimensiones (AxHxL)	P.V.P € (sin IVA)
Avant	VAVAN11-7	80 mm	770 x 970 x 280 mm	1.899,00 €
*Avant WIND	CAVAN11-7	80 mm	770 x 970 x 280 mm	2.120,00 €
Mando a distancia	VATL	-	-	35,00 €

ESP

Estufa potente de pasillo de 28 cms ventilada con **gran temperatura 115°C** a vivienda para calentar una gran estancia. También disponible en versión Avant canalizada con 1 ventilador frontal y dos ventiladores canalizables independientes con salidas posteriores o laterales a izquierda y derecha. Esta versión alcanza un caudal de 480 m³/h.

ENG

*Powerful corridor stove of 28 cm ventilated with a **very high temperature at the front grill of 115°C** available to heat a large room. Also available in a ducted Avant version with 1 front fan and two independent ducted fans for the canalization with rear outlet or both left and right side outlets. The ducted versión achieves a flow of 480 m³/h.*

AVANT / AVANT WIND

AIRE + CANALIZADA



Potencia nominal
Nominal heat output

Potencia máxima
Maximum power

Consumo
Consumption

AVANT: **11 kw**

13 kw

1 - 2,2 Kg/h

A. WIND:

Temp Salida
Output





Max

kg

m²



kg

115°C 93% 45dB 95kg 110m² 15kg
100°C front.
100°C canal.

Colores
Colour

Certificación
Certifications

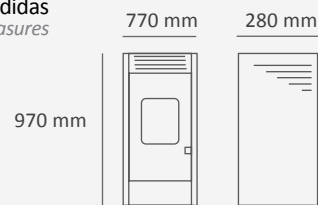
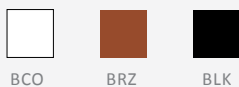
Medidas
Measures



ESP

- Vermiculita en cámara de combustión
- Brasero de acero inoxidable
- Programación diaria, semanal y fin de semana
- Modulación automática
- Protección contra sobrecalentamiento y sensor de temperatura
- Control de temperatura de humos
- Display vertical ocultable
- AVANT: salida humos: superior (necesario conector H-H)
- AVANT / AVANT WIND: Salida de humos posterior (codo especial 90 + T90) o lateral derecho (codo especial 90 + T90)
- AVANT WIND: 2 salidas canalizadas (Ø 80mm). 3 ventiladores (frontal y 2 para canalizar). Canalización dcha: trasera o lateral dcha o superior. Canalización izda: trasera o lateral izda

OPCIONAL

- Control remoto vía internet (Kit WIFI)
- Mando a distancia

ENG

- Vermiculite in combustion chamber
- Stainless steel firepot
- Daily, weekly and weekend programming
- Automatic modulation
- Overheating protection and temperature sensor
- Smoke temperature control
- Concealed vertical display
- AVANT: smoke outlet: top (necessary connector F-F)
- AVANT / AVANT WIND: smoke outlet rear (especial curve 90 + T90) or lateral right (especial curve 90 + T90)
- AVANT WIND: 2 exit for ducted (Ø 80mm). 3 fans (front + 2 x ducted). Duted right: rear or lateral right or top. Duted left: rear or lateral left.

OPTIONAL

- Internet remote control (Kit WIFI)
- Remote control



Kimono	Referencia	Salida de humos \varnothing	Dimensiones (AxHxL)	P.V.P € (sin IVA)
Kimono	KIMONO-77-COLOR	80 mm	743 x 1010 x 300 mm	1.799,00 €
*Kimono WIND	KIMONOW-7-COLOR	80 mm	743 x 1010 x 300 mm	2.090,00 €
Mando a distancia	VATL	-	-	35,00 €

ESP

Estufa de pasillo de 30 cms anchura con una gran elegancia por su **frontal integro en vidrio negro**, aporta un toque de elegancia y glamour a la estancia. **Debe instalarse sujeta a pared**. Resulta versátil en su instalación gracias a las salidas de humos posibles: superior, lateral derecho o trasera. La salida de canalización puede ser superior o posterior.

ENG

*30 cms wide corridor stove with great elegance due to its **full black glass front**, it adds a touch of elegance and glamor to the room. It **must be installed attached to the wall**. It is versatile in its installation thanks to the possible smoke outlets: upper, right side or rear. The ducting outlet can be either top or rear.*



Potencia nominal
Nominal heat output

KIMONO: **7,2 kw**

K. WIND:

Potencia máxima
Maximum power

9,2 kw

Consumo
Consumption

0,6-1,68 Kg/h

Temp Salida
Output

95°C
80°C front.
80°C canal.

η

95%

Max

39dB

kg

67kg

m²

72m²

kg

15kg

Colores
Colour



Certificación
Certifications



Medidas
Measures

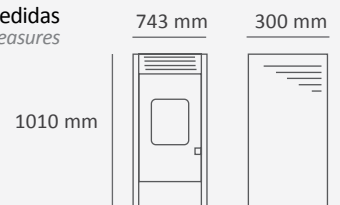

ESP

- KIMONO/KIMONO WIND: Salida de humos posterior (necesario codo 90 especial)
- KIMONO/KIMONO WIND: Salida de humos lateral derecha (necesario codo 90 especial)
- KIMONO: Salida de humos superior (necesario conector hembra-hembra)
- KIMONO WIND: 1 salida canalizada (Ø80mm). 2 ventiladores (frontal y canalización). Canalización: trasera o lateral dcha o superior dcha
- Doble puerta
- Programación diaria, semanal y fin de semana
- Modulación automática
- Protección contra sobrecalentamiento
- Sensor de temperatura
- Control de temperatura de humos

OPCIONAL

- Control remoto vía internet (Kit WIFI)
- Mando a distancia

ENG

- KIMONO/KIMONO WIND: Rear smoke outlet (necessary 90 especial curve)
- KIMONO/KIMONO WIND: Lateral right smoke outlet (necessary 90 especial curve)
- KIMONO: Upper smoke outlet (female-female connector required)
- KIMONO WIND: Exit for ducted (Ø 80mm). 2 fans (front + ducted). Duted fan: rear or lateral right or top.
- Double door
- Daily, weekly and weekend programming
- Automatic modulation
- Overheating protection
- Temperature sensor
- Smoke temperature control

OPTIONAL

- Internet remote control (Kit WIFI)
- Remote control



Kiss	Referencia	Salida de humos \varnothing	Dimensiones (AxHxL)	P.V.P € (sin IVA)
Kiss	KISS777777- COLOR	80 mm	743 x 1010 x 277 mm	1.679,00 €
*Kiss WIND	KISSWIND-77-COLOR	80 mm	743 x 1010 x 277 mm	1.970,00 €
Mando a distancia	VATL	-	-	35,00 €

ESP

Estufa delicada, elegante y esbelta de curvas perfectas y tan solo 28 cms de ancho. Resulta versátil en su instalación gracias a las salidas de humos posibles: superior, lateral derecho o trasera. La salida de canalización puede ser superior o posterior. La salida de canalización puede ser superior o posterior.

ENG

Delicate, elegant and slender stove with perfect curves and only 28 cm wide. It is versatile in its installation thanks to the possible smoke outlets: upper, right side or rear. The ducting outlet can be either top or rear.





Potencia nominal
Nominal heat output

KISS: **7,2 kw**

K. WIND:

Potencia máxima
Maximum power

9,2 kw

Consumo
Consumption

0,6-1,68 Kg/h

Temp Salida
Output

95°C

**80°C front.
80°C canal.**

η

95%

Max

39dB

kg

67kg

m²

72m²

kg

15kg

Colores
Colour



BCO



BRZ



BLK

Certificación
Certifications



Medidas
Measures

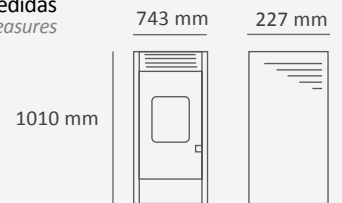

ESP

- KISS / KISS WIND: Salida de humos posterior (necesario codo 90 especial)
- KISS / KISS WIND: Salida de humos lateral derecha (necesario codo 90 especial)
- KISS: Salida de humos superior (necesario conector hembra-hembra)
- KISS WIND: 1 salida canalizada (Ø80mm). 2 ventiladores (frontal y canalización). Canalización: trasera o lateral dcha o superior dcha
- Programación diaria, semanal y fin de semana
- Modulación automática
- Protección contra sobrecalentamiento
- Sensor de temperatura
- Control de temperatura de humos

OPCIONAL

- Control remoto vía internet (Kit WIFI)
- Mando a distancia

ENG

- KISS / KISS WIND: Rear smoke outlet (necessary 90 especial curve)
- KISS / KISS WIND: Lateral right smoke outlet (necessary 90 especial curve)
- KISS: Upper smoke outlet (female-female connector required)
- KISS WIND: Exit for ducted (Ø80mm). 2 fans (front + ducted). Ducted fan: rear or lateral right or top.
- Daily, weekly and weekend programming
- Automatic modulation
- Overheating protection
- Temperature sensor
- Smoke temperature control

OPTIONAL

- Internet remote control (Kit WIFI)
- Remote control

STYLO / STYLO WIND

 AIRE + CANALIZADA



Stylo	Referencia	Salida de humos \varnothing	Dimensiones (AxHxL)	P.V.P € (sin IVA)
Stylo	STYLO77777	80 mm	650 x 1200 x 280 mm	1.999,00 €
*Stylo WIND	STYLOWIND7	80 mm	650 x 1200 x 280 mm	2.199,00 €
Mando a distancia	VATL	-	-	35,00 €

ESP

Estufa de Stylo de formato alto (1,2m) pero dimensiones muy reducidas (28cms de fondo) para instalarse en pasillos o salones pequeños con un atractivo diseño estilizado gracias a sus contornos curvos. **Gran temperatura 115°C** a vivienda para calentar una gran estancia. También disponible en versión Stylo canalizada con un ventilador frontal y otro independiente posterior o lateral derecho.

ENG

*Stylo stove with a high format (1.2m) but very small dimensions (28cms deep) to be installed in corridors or small rooms with an attractive slim design thanks to its curved contours. **Great temperature 115°C** in the home outlet capable to heat a large room. Also available in a ducted Stylo version with a front fan and an independent rear or right side fan.*

STYLO / STYLO WIND



AIRE + CANALIZADA



Potencia nominal
Nominal heat output

STYLO: **11 kw**

S. WIND:

Potencia máxima
Maximum power

13 kw

Consumo
Consumption

1 - 2,2 Kg/h

Temp Salida
Output

115°C
100°C front.
100°C canal.

η

93%

Max

45dB

kg

95kg



m²

110m²

kg

15kg

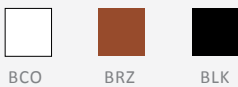

Colores
Colour



Certificación
Certifications

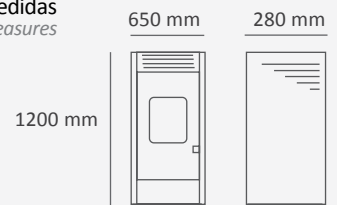

Medidas
Measures



ESP

- STYLO / STYLO WIND: Salida de humos posterior (necesario codo 90 especial)
- STYLO / STYLO WIND: Salida de humos lateral derecha (necesario codo 90 especial)
- STYLO WIND: 1 salida canalizada (Ø80mm). 2 ventiladores (frontal y canalización).
- Canalización: trasera o lateral dcha
- STYLO: 2 ventiladores superior frontales, máximo caudal caliente 150+150 m3/h
- Vermiculita en cámara de combustión
- Braseiro de acero inoxidable
- Programación diaria, semanal y fin de semana
- Modulación automática
- Protección contra sobrecalentamiento y sensor de temperatura
- Control de temperatura de humos
- Doble puerta

OPCIONAL

- Control remoto vía internet (Kit WIFI)
- Mando a distancia

ENG

- STYLO / STYLO WIND: Rear smoke outlet (necessary 90 especial curve)
- STYLO / STYLO WIND: Lateral right smoke outlet (necessary 90 especial curve)
- STYLO WIND: Exit for ducted (Ø80mm). 2 fans (front + ducted).
- Ducted fan: rear or lateral right
- STYLO: 2 front fans, maximum hot flow 150+150 m3/h
- Vermiculite in combustion chamber
- Stainless steel firepot
- Daily, weekly and weekend programming
- Automatic modulation
- Overheating protection and temperature sensor
- Smoke temperature control
- Double door

OPTIONAL

- Internet remote control (Kit WIFI)
- Remote control

INSERTS

BOX STOVES







Nordic	Referencia	Salida de humos ϕ	Dimensiones (A x H x L)	P.V.P € (sin IVA)
Nordic	N9-777777777	80 mm	733 x 527 x 550 mm	2.089,00 €
Nordic Box	NB9-777777777	80 mm	733 x 527 x 550 mm	2.179,00 €
Nordic Box Oliva	NB9OLI-777777	80 mm	733 x 527 x 550 mm	2.239,00 €
KIT carga compuerta	HJC1	-	-	163,00 €
Mando a distancia	VATL	-	-	Incluido
Soporte inferior	KIE	Altura ajustable 300-400-500	850 x 300 x 460 mm	349,00 €

ESP

Insert de pellet de aire Nordic de amplio cristal con una amplia visión del fuego. La versión NORDIC BOX incorpora de forma una bandeja de carga de pellet en la parte superior de la puerta, evitando apagar la estufa para realizar el llenado de la misma. La nueva gama OLIVA es capaz de quemar pellet y hueso de aceituna.

ENG

The Nordic pellet air insert has a large glass with a bright view of the fire. The NORDIC BOX version incorporates a pellet loading tray in the upper part of the door, avoiding turning off the stove to fill it. The new OLIVA version is capable of burning apart from wood pellets also olive bones.

NORDIC / BOX / OLIVA



Potencia nominal
Nominal heat output

8,8 kw

Potencia máxima
Maximum power

12 kw

Consumo
Consumption

0,8 - 2,1 Kg/h

°Temp Salida
Output

90°C

η

90%

Max

42dB

kg

90kg

m²

100m²

kg

13kg

Colores
Colour



BLK

Certificación
Certifications



Medidas
Measures

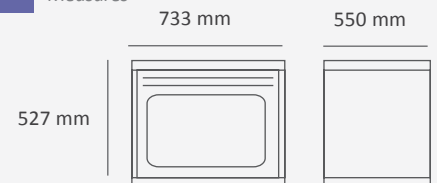

ESP

- NORDIC BOX: Incluye bandeja de carga de pellet
- NORDIC BOX OLIVA: Incluye bandeja de carga de pellet
- NORDIC BOX OLIVA: Multicombustible (Pellet y Hueso de aceituna)
- Brasero de acero
- Programación diaria, semanal y fin de semana
- Salida de humos superior (conector H-H)
- Modulación automática
- Protección contra sobrecalentamiento
- Sensor de temperatura
- Control de temperatura de humos
- Mando a distancia

OPCIONAL

- Control remoto vía internet (Kit WIFI)
- Kit carga compuerta y soporte inferior

ENG

- NORDIC BOX: Includes a pellet loading tray
- NORDIC BOX OLIVA: Include a pellet loading tray
- NORDIC BOX OLIVA: Multifuel (Pellet and olive stone)
- Steel firepot
- Daily, weekly and weekend programming
- Smoke outlet: upper (F-F conector)
- Automatic modulation
- Overheating protection
- Temperature sensor
- Smoke temperature control
- Remote control

OPTIONAL

- Internet remote control (Kit WIFI)
- Charging kit with door and bottom support



Ruby	Referencia	Salida de humos \varnothing	Dimensiones (AxHxL)	P.V.P € (sin IVA)
Ruby 70	RUBY70-777777	80 mm	700 x 500 x 550 mm	2.149,00 €
Ruby 80	RUBY80-777777	80 mm	800 x 500 x 550 mm	2.295,00 €
Ruby 90	RUBY90-777777	80 mm	900 x 500 x 550 mm	2.495,00 €
Ruby 70 WIND	RUBYWIND70-77	80 mm	700 x 500 x 550 mm	2.495,00 €
Ruby 80 WIND	RUBYWIND80-77	80 mm	800 x 500 x 550 mm	2.695,00 €
Ruby 90 WIND	RUBYWIND90-77	80 mm	900 x 500 x 550 mm	2.895,00 €
*Bandeja carga frontal Ruby 70	CS-A00892_00	-	700 x 60 x 550 mm	139,00 €
*Bandeja carga frontal Ruby 80	CS-A00894_00	-	800 x 60 x 550 mm	139,00 €
*Bandeja carga frontal Ruby 90	CS-A00893_00	-	900 x 60 x 550 mm	139,00 €
Soporte inferior	KIE	Altura ajustable 300-400-500	850 x 300 x 460 mm	349,00 €
KIT carga compuerta	HJC1	-	-	163,00 €
Mando a distancia	VATL	-	-	Incluido

* ES: La bandeja de carga tiene 6cm adicionales de altura

* EN: The pellet drawer is an additional 6cm high

ESP

El insert de pellet Ruby con formato panorámico; ventilado o canalizable con amplio cristal y una espectacular visión del fuego. La bandeja de carga superior con 6 cms adicionales de altura es opcional y se instala sobre el aparato. Un potente ventilador centrífugo mueve un gran caudal 390 m³/h a una temperatura extrema de 120°C. Hay 3 anchos diferentes disponible en 70, 80 y 90cm acorde con las dimensiones de su salón.

ENG

The Ruby pellet insert with panoramic format; ventilated or ductable with a large glass and a spectacular view of the fire. The top loading tray with an additional 6 cm height is optional and is installed on the appliance. A powerful centrifugal fan moves a large flow 390 m³/h at an extreme temperature of 120°C. There are 3 different available widths of 70, 80 and 90cm according to the size of the living room.

RUBY / RUBY WIND 70/80/90

AIRE + CANALIZADA



Potencia nominal
Nominal heat output

RUBY: 10 kw
R. WIND:

Potencia máxima
Maximum power

12 kw

Consumo
Consumption

0,8 - 2,1 Kg/h

Temp Salida
Output

120 °C

η

90%

Max

42dB
48dB

kg

90kg



m²

100m²

kg

16kg

90°C canal.

Colores
Colour



BLK



Certificación
Certifications



Medidas
Measures

R 70: 700 mm
 R 80: 800 mm
 R 90: 900 mm

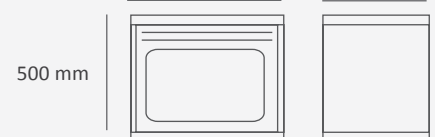
550 mm



ESP

- Brasero de acero
- Programación diaria, semanal y fin de semana
- Salida de humos superior izquierda (conector H-H)
- Modulación automática
- Protección contra sobrecalentamiento
- Sensor de temperatura
- Control de temperatura de humos
- Mando a distancia
- RUBY WIND: 1 salida canalizada superior trasera derecha de Ø80 mm con 2 ventiladores independientes (lateral + canalizada)

OPCIONAL

- Control remoto vía internet (Kit WIFI)
- Kit carga compuerta y soporte inferior
- Bandeja de carga de pellet

ENG

- Steel firepot
- Daily, weekly and weekend programming
- Smoke outlet: upper (F-F conector)
- Automatic modulation
- Overheating protection
- Temperature sensor
- Smoke temperature control
- Remote control
- RUBY WIND: 1 ductable top right rear Ø 80mm outlet with 2 independent fans (lateral + channeling)

OPTIONAL

- Internet remote control (Kit WIFI)
- Charging kit with door and bottom support
- Pellet loading tray



Zaphir	Referencia	Salida de humos \varnothing	Dimensiones (AxHxL)	P.V.P € (sin IVA)
Zaphir	ZAPHIR-777777	80 mm	732 x 555 x 608 mm	2.299,00 €
*Zaphir WIND	ZAPHIRWIND-77	80 mm	732 x 555 x 608 mm	2.695,00 €
Soporte inferior	KIE	Altura ajustable 300-400-500	850 x 300 x 460 mm	349,00 €
KIT carga compuerta	HJC1	-	-	163,00 €
Mando a distancia	VATL	-	-	Incluido
Bandeja carga frontal	-	-	-	Incluido

ESP

El nuevo insert de pellet Zaphir con formato panorámico fantástico; ventilado o canalizable con amplio cristal y una espectacular visión del fuego. La bandeja de carga superior suministrada de serie detrás de la rejilla. Los 3 ventiladores incorporados mueven un caudal brutal 480m³/h que calentara de forma muy rápida su vivienda

ENG

The new Zaphir pellet insert with an amazing panoramic format; ventilated or ductable with a large glass and a spectacular view of the fire. The standard supplied top loading tray behind the grill. The 3 built-in fans move a brutal 480m³/h flow that will heat up your home very quickly.

ZAPHIR / ZAPHIR WIND 70/80/90



AIRE + CANALIZADA



Potencia nominal
Nominal heat output

ZAPHIR: **9,3 kw**
Z. WIND:

Potencia máxima
Maximum power

10,5 kw

Consumo
Consumption

0,8-2,1 Kg/h

Temp Salida
Output

100°C

**100°C front.
70°C canal.**

η

95%

Max

55dB

kg

90kg

m²

93m²

kg

16kg

Colores
Colour



BLK

Certificación
Certifications



Medidas
Measures



ESP

- Incluye vermiculita en cámara de combustión
- Brasero de acero
- Programación diaria, semanal y fin de semana
- Salida de humos superior izquierda (conector H-H)
- Modulación automática
- Protección contra sobrecalentamiento
- Sensor de temperatura
- Control de temperatura de humos
- Mando a distancia
- Bandeja carga frontal de serie
- ZAPHIR: 3 ventiladores frontales
- ZAPHIR WIND: 2 salidas canalizadas (Ø 80mm). 3 ventiladores (frontal + 2 canalizaciones superiores)

OPCIONAL

- Control remoto vía internet (Kit WIFI)
- Kit carga compuerta y soporte inferior

ENG

- Vermiculite in combustion chamber
- Steel firepot
- Daily, weekly and weekend programming
- Smoke outlet: upper (F-F conector)
- Automatic modulation
- Overheating protection
- Temperature sensor
- Smoke temperature control
- Remote control
- Pellet loading tray
- ZAPHIR: 3 front fans
- ZAPHIR WIND: Exit for ducted (Ø 80mm). 3 fans (front + 2 for ducted). Includes adapter for ducted rear or lateral

OPTIONAL

- Internet remote control (Kit WIFI)
- Charging kit with door and bottom support



Cuisine	Referencia	Encimera	Salida de humos \varnothing	Dimensiones (AxHxL)	P.V.P € (sin IVA)
Cuisine	5170015-7-ANC	Acero	80 mm	900 x 850 x 650 mm	2.799,00 €
Mando a distancia	VATL	-	-	-	35,00 €

ESP

Cocina de pellet de aire Cuisine, aparentemente es una cocina económica que nos permite cocinar tanto en el horno como en la encimera de chapa. Sin embargo, gracias a la incorporación de un ventilador de vivienda, el comportamiento es similar al de una estufa de pellet de aire convencional.

ENG

Pellet air cooker Cuisine is apparently only a solid fuel cooker which allows to cook in the oven as well as in the steel plate. However thanks to the inclusion of a air fan, the behaviour is similar to a conventional pellet air stove.



Potencia nominal
Nominal heat output

8,1 kw

Potencia máxima
Maximum power

11,1 kw

Consumo
Consumption

0,7 - 1,9 Kg/h

η

86%

Max.

39dB

kg

163kg

m²

80m²

kg

15kg

Colores
Colour



BLK

Certificación
Certifications

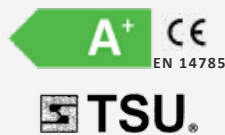

Medidas
Measures

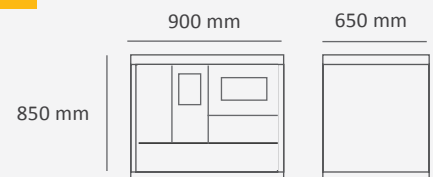

ESP

- Brasero de fundición
- Horno: (A x H x L) 33 x 25 x 46cm
- Programación diaria
- Salida de humos superior derecha, posterior y lateral derecha
- Modulación automática
- Protección contra sobrecalentamiento
- Sensor de temperatura
- Control de temperatura en salida de humos
- Ventilador de vivienda

OPCIONAL

- Mando a distancia

ENG

- Cast iron firepot
- Oven: (H x H x D) 33 x 25 x 46cm
- Programming daily
- Right upper, rear and right side smoke outlet
- Automatic modulation
- Protection against overheating
- Temperature sensor
- Flux temperature control
- Housing fan

OPTIONAL

- Remote control

HIDROESTUFAS Y CALDERAS

AGUA CALIENTE PARA SU HOGAR

HIDRO STOVES AND BOILERS *HOT WATER FOR YOUR HOME*

ESP

La hidroestufa es una caldera de biomasa compacta, con estética de estufa de aire, para instalarse en un salón, cocina u otra estancia. Calienta el agua del sistema de calefacción y el depósito de agua caliente sanitaria (opcional).

Al disponer de un cristal en la puerta, permite ver el fuego y conseguir un ambiente más agradable dentro de la vivienda. Por el contrario las calderas se instalan fuera de la vivienda, por ejemplo garaje, para el mejor aprovechamiento de la vivienda.

Como novedad, el modelo TURBO 10/14 incorpora un intercambiador tubular horizontal de acero que hace posible comportarse como una caldera instantánea de gas. Es la única caldera de biomasa del mercado mundial que se comporta como una caldera instantánea.

ENG

The hidrostove is a compact biomass boiler, with the aesthetic of an air stove, to be installed in a hall, kitchen or other rooms. Since it works as a boiler, it heats up the water of the heating system and the sanitary hot water at a water tank (optional).

The front glass door allows to see the fire and achieves a more pleasant atmosphere at your home. On contrary boilers are installed outside the living area, for example at a garage.

As a novelty, the model TURBO 10/14 includes a horizontal tubular exchanger which makes it is possible to behave as a instantaneous gas boiler.





Llama	Referencia	Salida de humos \varnothing	Dimensiones (AxHxL)	P.V.P € (sin IVA)
Llama	RIT15-777	80 mm	513 x 1041 x 595 mm	2.399,00 €
Mando a distancia	VATL	-	-	35,00 €

ESP

Hydroestufa con medidas muy compactas que incluye de serie todos los accesorios para conectarse directamente al circuito de calefacción. La generación de ACS es posible mediante un depósito opcional con lo que cumplirá con la normativa sin necesidad de placas solares.

ENG

This very compact size stove includes as standard all the accessories for a direct connection to the heating circuit. The production of hot water is possible by using an optional water tank which will fulfill the requirements of the law avoiding solar panels.



P. nominal
Nominal P.

P. H2O
H2O P.

P. máxima
Maximum P.

Consumo
Consumption

η

\varnothing

kg

m²

kg

15 kw

10,3 kw

18 kw

1,0 - 2,9 Kg/h

92,4% 80mm 136kg 100m² 19kg

Colores
Colour

Certificación
Certifications

Medidas
Measures



BCR



BRX



BLK

A⁺ CE
EN 14785

TSU.

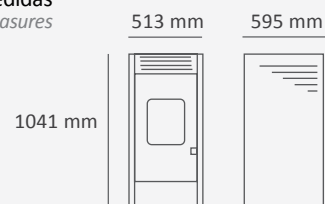

ESP

- Puerta de fundición y brasero de acero
- Incluye: bomba de impulsión, vaso de expansión 8L, purgador automático y válvula de seguridad
- No incluye medidor de presión ni sonda ambiente
- Programación diaria, semanal y fin de semana
- Salida de humos trasera (T90)
- Modulación automática y protección contra sobrecalentamiento
- Sensor de temperatura
- Control de temperatura en salida de humos
- Impulsión y retorno 1 pulgada

OPCIONAL

- Control remoto vía internet (Kit WIFI)
- Mando a distancia

ENG

- Cast iron door and steel firepot
- Includes: drive pump, 8L expansion vessel, automatic drain valve and safety valve
- Does not include: pressure probe and temperature probe
- Daily, weekly and weekend programming
- Rear exhaust outlet (T90)
- Automatic modulation and protection against overheating
- Temperature sensor
- Temperature control
- Drive and return 1 inch

OPTIONAL

- Remote control via internet (WIFI Kit)
- Remote control



Laia	Referencia	Salida de humos \varnothing	Dimensiones (AxHxL)	P.V.P € (sin IVA)
Laia	5180001-7	80 mm	520 x 1010 x 570 mm	2.780,00 €
Mando a distancia	VATL	-	-	35,00 €

ESP

Hydroestufa con medidas muy compactas que incluye de serie todos los accesorios para conectarse directamente al circuito de calefacción. La generación de ACS es posible mediante un depósito opcional con lo que cumplirá con la normativa sin necesidad de placas solares.

ENG

This very compact size stove includes as standard all the accessories for a direct connection to the heating circuit. The production of hot water is possible by using an optional water tank which will fulfill the requirements of the law avoiding solar panels.



P. nominal
Nominal P.

P. H2O
H2O P.

P. máxima
Maximum P.

Consumo
Consumption

η

\emptyset

kg

m²

kg

16 kw

13 kw

19 kw

1,3 - 3,3 Kg/h

92,1%

80mm

181kg

130m²

25kg

Colores
Colour

Certificación
Certifications

Medidas
Measures



BCR



BRX



BLK



EN 14785

TSU

520 mm

570 mm

1010 mm



ESP

- Brasero de fundición
- Incluye: bomba de impulsión, vaso de expansión 6L, purgador automático y válvula de seguridad
- No incluye medidor de presión ni sonda ambiente
- Programación diaria, semanal y fin de semana
- Salida de humos trasera (T90)
- Modulación automática y protección contra sobrecalentamiento
- Sensor de temperatura
- Control de temperatura en salida de humos
- Impulsión y retorno 1 pulgada

OPCIONAL

- Control remoto vía internet (Kit WIFI)
- Mando a distancia

ENG

- Cast iron firepot
- Includes: drive pump, 6L expansion vessel, automatic drain valve and safety valve
- Does not include: pressure probe and temperature probe
- Daily, weekly and weekend programming
- Rear exhaust outlet (T90)
- Automatic modulation and protection against overheating
- Temperature sensor
- Temperature control
- Drive and return 1 inch

OPTIONAL

- Remote control via internet (WIFI Kit)
- Remote control



Laura Plus	Referencia	Salida de humos \varnothing	Dimensiones (AxHxL)	P.V.P € (sin IVA)
Laura Plus	5170202-7	80 mm	594 x 1115 x 669 mm	3.099,00 €
Mando a distancia	VATL	-	-	35,00 €

ESP

Hidroestufa que incluye de serie todos los accesorios para conectarse directamente al circuito de calefacción. La generación de ACS es posible mediante un depósito opcional con lo que cumplirá con la normativa sin necesidad de placas solares.

ENG

Water pellet hidrostove includes as standard all the accessories for a direct connection to the heating circuit. The production of hot water is possible by using an optional water tank which will fulfill the requirements of the law avoiding solar panels.

LAURA PLUS



P. nominal
Nominal P.

P. H2O
H2O P.

P. máxima
Maximum P.

Consumo
Consumption



20 kw

17,3 kw

22 kw

1,4 - 3,5 Kg/h

94% 80mm 220kg 173m² 40kg

Colores
Colour



BCR



BRX



BLK

Certificación
Certifications



Medidas
Measures



ESP

- Brasero y puerta de fundición
- Incluye: bomba de impulsión, vaso de expansión 8L, purgador automático y válvula de seguridad
- No incluye medidor de presión ni sonda ambiente
- Programación diaria, semanal y fin de semana
- Salida de humos trasera (T90)
- Modulación automática y protección contra sobrecalentamiento
- Sensor de temperatura
- Control de temperatura en salida de humos
- Impulsión y retorno 1 pulgada

OPCIONAL

- Control remoto vía internet (Kit WIFI)
- Mando a distancia

ENG

- Cast iron firepot and door
- Includes: drive pump, 8L expansion vessel, automatic drain valve and safety valve
- Does not include: pressure probe and temperature probe
- Daily, weekly and weekend programming
- Rear exhaust outlet (T90)
- Automatic modulation and protection against overheating
- Temperature sensor
- Temperature control
- Drive and return 1 inch

OPTIONAL

- Remote control via internet (WIFI Kit)
- Remote control



Laser	Referencia	Salida de humos \varnothing	Dimensiones (AxHxL)	P.V.P € (sin IVA)
Laser	LASER-777-BCR	80 mm	603 x 1301 x 669 mm	3.850,00 €
Mando a distancia	VATL	-	-	35,00 €
Anticondensación	12142	-	-	Incluido

ESP

La hidroestufa más potente de la gama incluye todos los accesorios para conectarse directamente al circuito de calefacción. La generación de ACS es posible mediante un depósito opcional con lo que cumplirá con la normativa sin necesidad de placas solares.

ENG

The most powerful hydro stove of the range includes all the accessories for direct connection to the heating circuit. The production of hot water is possible by using an optional water tank which will fulfill the requirements of the law avoiding solar panels.



P. nominal
Nominal P.

P. H2O
H2O P.

P. máxima
Maximum P.

Consumo
Consumption

η

\emptyset

kg

m²

kg

31 kw

25 kw

33 kw

1,2 - 7,2 Kg/h

91%

80mm

250kg

250m²

60kg

Colores
Colour



BCR

Certificación
Certifications



TSU.

Medidas
Measures



ESP

- Puerta de fundición y brasero de acero
- Incluye: bomba de impulsión, vaso de expansión 8L, purgador automático y válvula de seguridad
- No incluye medidor de presión ni sonda ambiente
- Programación diaria, semanal y fin de semana
- Salida de humos trasera (T90)
- Modulación automática y protección contra sobrecalentamiento
- Sensor de temperatura
- Control de temperatura en salida de humos
- Impulsión y retorno 1 pulgada

OPCIONAL

- Control remoto vía internet (Kit WIFI)
- Mando a distancia remoto

ENG

- Cast iron door and steel firepot
- Includes: drive pump, 8L expansion vessel, automatic drain valve and safety valve
- Does not include: pressure probe and temperature probe
- Daily, weekly and weekend programming
- Rear exhaust outlet (T90)
- Automatic modulation and protection against overheating
- Temperature sensor
- Temperature control
- Drive and return 1 inch

OPTIONAL

- Remote control via internet (WIFI Kit)
- Remote control



Turbo	Referencia	Salida de humos ϕ	Dimensiones (AxHxL)	P.V.P € (sin IVA)
Turbo 10	TURBO10-77	80 mm	509 x 1151 x 547 mm	3.300,00 €
Turbo 14	TURBO14-77	80 mm	509 x 1151 x 547 mm	3.630,00 €
Mando a distancia	VATL	-	-	35,00 €
Ventilador vivienda	-	-	-	Incluido

ESP

La tecnología TURBO INOX[®] única en el mercado con **intercambiador de acero inoxidable** logra el mejor rendimiento del mercado con el mínimo **consumo tan solo 790 gr/hora** de pellet en modulación. Esta tecnología tubular aplicada a calderas de biomasa es lo más próximo a una **caldera de gas: calor casi instantáneo**. Además las hidroestufas TURBO incorporan de serie un potente ventilador de vivienda frontal para calentar eficazmente el ambiente en el que se ubica. La innovación de la caldera y los tubos de intercambio en acero inoxidable Aisi 304 son una **garantía de eterna duración**, pero sobre todo de inmediata conversión de calor en los radiadores.

ENG

*The unique TURBO INOX[®] technology on the market with a **stainless steel exchanger** achieves the best performance on the market with the **minimum consumption of only 790 gr/hour** of modulating pellets. This tubular technology applied to biomass boilers is the closest thing to a **gas boiler: almost instantaneous heat**. In addition, TURBO hydro stoves have a powerful front housing fan as standard to effectively heat the environment in which it is located. The innovation of the boiler and the exchange tubes in Aisi 304 stainless steel are a **guarantee of eternal duration**, but above all of immediate heat conversion in the radiators.*

TURBO 10/14

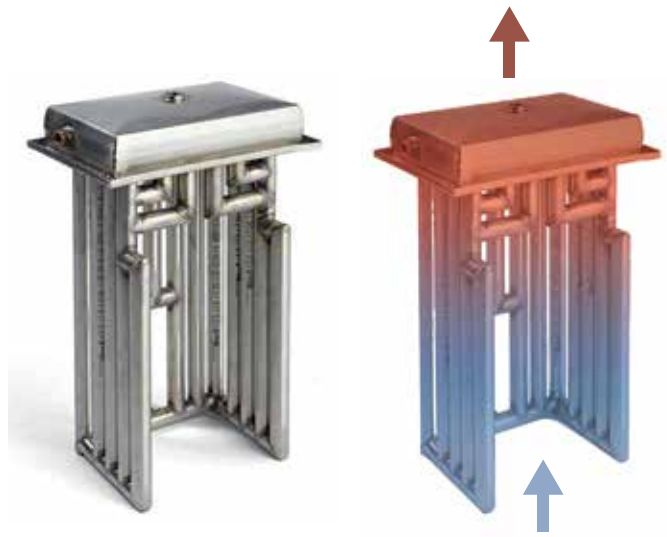

CALDERA INOX:

EOSS es la única empresa del sector que fabrica estufas que producen agua caliente equipadas con intercambiadores de calor y calderas de acero inoxidable. Este material permite una producción más rápida y superior de agua caliente, evitando cualquier problema relacionado con la formación de óxido.

P. nominal
Nominal P.

P. H2O
H2O P.

P. máxima
Maximum P.

Consumo
Consumption

η

\varnothing

kg

m²

kg

T10: **12,9 kw**
T14: **16 kw**

9,8 kw
11,8 kw

14,5 kw
18,5 kw

0,79-3,04 Kg/h
0,79-3,88 Kg/h

92,1% 80mm 125kg 100m² 23kg

92,1% 80mm 125kg 120m² 23kg

Colores
Colour

Certificación
Certifications

Medidas
Measures

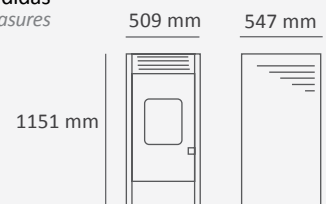

ESP

- **HIDROESTUFA MIXTA: AIRE + AGUA (INCLUYE VENTILADOR DE VIVIENDA)**
- Puerta de fundición y brasero de acero
- Incluye: bomba de impulsión, vaso de expansión 8L, purgador automático y válvula de seguridad
- No incluye medidor de presión ni sonda ambiente
- Programación diaria, semanal y fin de semana
- Salida de humos trasera (T90)
- Modulación automática y protección contra sobrecalentamiento
- Sensor de temperatura
- Control de temperatura en salida de humos
- Impulsión y retorno 3/4 pulgada

OPCIONAL

- Control remoto vía internet (Kit WIFI)
- Mando a distancia remoto

ENG

- **HIDROSTOVE MIX: AIR + HIDRO (INCLUDE HOUSE FAN)**
- Cast iron door and steel firepot
- Includes: drive pump, 8L expansion vessel, automatic drain valve and safety valve
- Does not include: pressure probe and temperature probe
- Daily, weekly and weekend programming
- Rear exhaust outlet (T90)
- Automatic modulation and protection against overheating
- Temperature sensor
- Temperature control
- Drive and return 3/4 inch

OPTIONAL

- Remote control via internet (WIFI Kit)
- Remote control

CALDERAS

BOILERS

ESP

EOSS es la única marca del sector que fabrica calderas que producen agua caliente equipadas con **intercambiadores de calor en acero inoxidable**.

Este material permite una producción más rápida y superior de agua caliente, evitando cualquier problema relacionado con la formación de óxido, garantizando una **larga vida del producto**.

ENG

EOSS is the only brand in the sector that manufactures boilers that produce hot water equipped with *stainless steel heat exchangers*.

This material allows a production more fast and superior hot water, avoiding any problem related to the formation of rust, guaranteeing a ***long product life***.





Esencial 15	Referencia	Salida de humos \varnothing	Dimensiones (AxHxL)	P.V.P € (sin IVA)
Esencial 15	ESEN15-77-GRS	80 mm	860 x 1365 x 520 mm	3.339,00 €
Mando a distancia	VATL	-	-	35,00 €
Silo pellet adicional	SILOSUPR26	175 kg	430 x 1490 x 760 mm	699,00 €

ESP

La caldera de pellet Esencial tiene todo lo que una vivienda convencional precisa para garantizar su calefacción y agua caliente sanitaria. Su alta eficiencia garantiza un consumo bajo de combustible. La opción de silo adicional proporciona autonomía y comodidad.

ENG

The Esencial pellet boiler has everything a conventional home needs to guarantee its heating and domestic hot water. Its high efficiency will guarantee low fuel consumption. The additional silo option provides autonomy and comfort.

ESENCIAL 15



Limpieza semiautomática del intercambiador de calor por medio de tirador

Semi-automatic cleaning of the heat exchanger by means of handle



*Caldera con silo de pellet adicional de 175 kg



Potencia nominal
Nominal heat output

15 kw

Potencia máxima
Maximum power

15 kw

Consumo
Consumption

0,95 - 3 Kg/h

η \varnothing kg m^2 kg

91,2% 80mm 160kg 150m² 75kg

Colores
Colour



GRS

Certificación
Certifications



Medidas
Measures

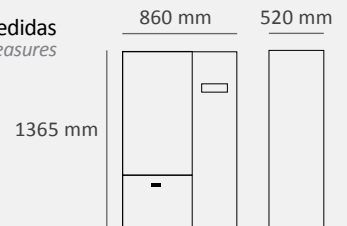

ESP

- Bomba de impulsión, vaso de expansión de 10 litros y válvula de seguridad de 3bar.
- Programación diaria, semanal y fin de semana
- No incluye medidor de presión ni sonda ambiente
- Salida de humos trasera (T90)
- Modulación automática y protección contra sobrecalentamiento
- Sensor de temperatura
- Control de temperatura en salida de humos
- Impulsión y retorno 1 pulgada

OPCIONAL

- Control remoto vía internet (Kit WIFI)
- Mando a distancia
- Silo adicional de pellet (175 kg)

ENG

- Drive pump, 10 liter expansion tank and 3 bar safety valve.
- Daily, weekly and weekend programming
- Does not include: pressure probe and temperature probe
- Rear exhaust outlet (T90)
- Automatic modulation and protection against overheating
- Temperature sensor
- Temperature control
- Drive and return 1 inch

OPTIONAL

- Internet remote control (Kit WIFI)
- Remote control
- Additional pellet silo (175 kg)



Suprema	Referencia	Salida de humos ϕ	Dimensiones (AxHxL)	P.V.P € (sin IVA)
Suprema 15	SUPR15-77-GRS	80 mm	860 x 1365 x 520 mm	3.689,00 €
**Suprema 20	SUPR20-77-GRS	80 mm	860 x 1365 x 520 mm	4.029,00 €
**Suprema 26	SUPR26-77-GRS	80 mm	860 x 1490 x 520 mm	4.389,00 €
**Suprema 45	SUPR45-77-GRS	130 mm	900 x 1670 x 620 mm	6.159,00 €
Mando a distancia	VATL	-	-	35,00 €
Silo pellet adicional	SILOSUPR26	175 kg	430 x 1490 x 760 mm	699,00 €
Válvula anticondesacion DN 25	12142	-	-	118,80 €

ESP

La caldera de pellet Suprema gana en confort para el usuario final. El **sistema de limpieza automático** combina la innovación del brasero móvil con el raspado del intercambiador tubular. Su **alta eficiencia** garantiza un consumo bajo de combustible. La opción de silo adicional proporciona autonomía y comodidad.

ENG

*The Suprema pellet boiler gains in comfort for the end user. The **automatic cleaning system** combines the innovation of the mobile brazier with the scraping of the tubular exchanger. Its **high efficiency** will guarantee low fuel consumption. The additional silo option provides autonomy and comfort.*

SUPREMA 15/20/26/45



Limpeza automática del intercambiador de calor motorizado

Automatic clean motorized

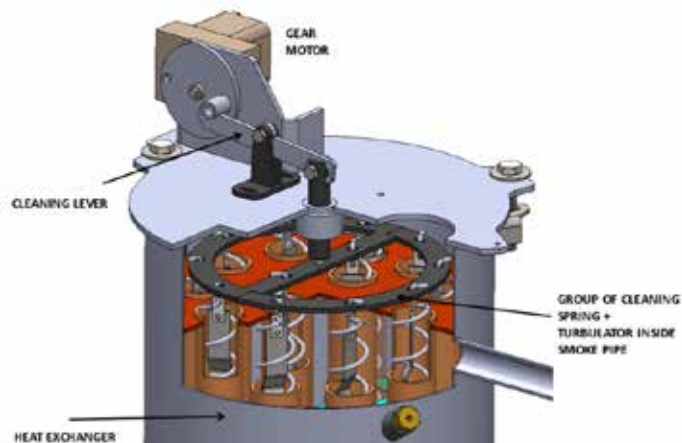

Limpeza automática del quemador motorizada

Automatic clean motorized

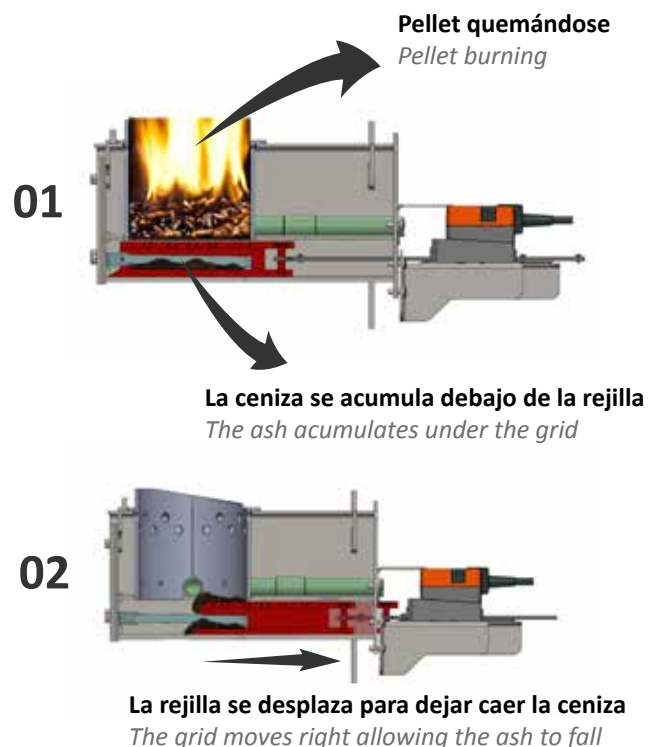

Potencia nominal
Nominal heat output

Potencia máxima
Maximum power

Consumo
Consumption

η **∅** **kg** **m²** **kg**

Model	Nominal Power (kw)	Maximum Power (kw)	Consumption (Kg/h)
S15:	15 kw	15 kw	0,95 - 3 Kg/h
S20:	20 kw	20 kw	1,2 - 3,8 Kg/h
S26:	26 kw	26 kw	1,7 - 5 Kg/h
S45:	45 kw	45 kw	2,6 - 8,6 Kg/h

Model	Efficiency (%)	Ø (mm)	Weight (kg)	Area (m ²)	Capacity (kg)
S15/20:	91,2%	80mm	160kg	150m ²	75kg
S20/26:	88,9%	80mm	165kg	200m ²	75kg
S26/45:	89,2%	80mm	185kg	260m ²	90kg
S45:	89,3%	130mm	250kg	450m ²	115kg

Colores
Colour



GRS

Certificación
Certifications



Medidas
Measures

S15/20/26: 860mm
S45: 900 mm

S15/20/26: 520 mm
S45: 620 mm

S15/20: 1365 mm
S26: 1490 mm
S45: 1670 mm

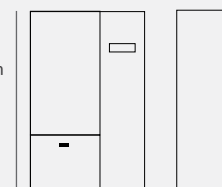

ESP

- Limpieza automática del quemador y del intercambiador de calor
- Bomba de impulsión, vaso de expansión de 10 litros y válvula de seguridad 3bar
- Programación diaria, semanal y fin de semana
- No incluye medidor de presión ni sonda ambiente
- Salida de humos trasera (T90)
- Modulación automática y protección contra sobrecalentamiento
- Sensor de temperatura
- Control de temperatura en salida de humos
- Impulsión y retorno 1 pulgada
- ** SUPREMA 20,26 y 45: Incluyen de serie vavula anticondensaion

OPCIONAL

- Control remoto vía internet (Kit WIFI)
- Mando a distancia
- Silo adicional de pellet (175 kg)

ENG

- Automatic burner cleaning system and automatic heat exchanger system
- Drive pump, 10 liter expansion tank and 3 bar safety valve.
- Daily, weekly and weekend programming
- Does not include: pressure probe and temperature probe
- Rear exhaust outlet (T90)
- Automatic modulation and protection against overheating
- Temperature sensor
- Temperature control
- Drive and return 1 inch
- ** SUPREMA 20,26 & 45: include anticondensation valve

OPTIONAL

- Internet remote control (Kit WIFI)
- Remote control
- Additional pellet silo (175 kg)



Biopel	Referencia	Salida de humos \varnothing	Dimensiones (AxHxL)	P.V.P € (sin IVA)
Biopel 20 kW + silo 150kg	BIOPEL20KW150KG	150 mm	1102 x 1234 x 953 mm	4.599,00 €
Biopel 20 kW+ silo 250kg	BIOPEL20KW250KG	150 mm	1252 x 1234 x 1180 mm	4.759,00 €
Biopel 30 kW+ silo 150kg	BIOPEL30KW150KG	150 mm	1102 x 1234 x 953 mm	4.829,00 €
Biopel 30 kW+ silo 250kg	BIOPEL30KW250KG	150 mm	1252 x 1234 x 1180 mm	4.989,00 €
Biopel 40 kW+ silo 250kg*	BIOPEL40KW250KG	150 mm	1352 x 1234 x 1180 mm	7.995,00 €
Bomba electrónica	DP0006HW	-	-	205,00 €
Válvula anticondesacion DN 32	12957	-	-	129,60 €
Válvula descarga térmica DBV1	14043	-	-	140,00 €
Grupo seguridad	GS	-	-	100,00 €
Regulador de tiro 150 mm	RCO-150	-	-	100,00 €
Sonda temp KTY control ACS	345718000080	-	-	30,00 €
Sonda lambda (10% ahorro combustible)	40500100101	-	-	750,00 €
Extraccion automática cenizas	-	-	-	500,00 €-900 ,00 € (según modelo)
Limpieza automática quemador e intercambiador por soplado (compresor)	-	-	-	550,00 €

* INCLUIDO: Limpieza automática quemador e intercambiador por soplado (compresor)

ESP

La caldera de biomasa BIOPEL incorpora una regulación PID para la detección del poder calorífico del combustible y lograr el máximo ahorro. La caldera BIOPEL incorpora de serie la conexión remota via el wifi de la vivienda. La limpieza automática del quemador e intercambiador de calor por solpado por medio de un compresor opcional o de serie según modelo. La caldera de biomasa multicomcombustible puede quemar pellet y hueso de aceituna. La regulación PID determina la potencia real generada en función de la calidad del pellet, transmitiendo la potencia exacta que precisa la vivienda en cada instante. La caldera regula el dosado de combustible y aire en base al poder calorífico detectado ajustando la potencia.

ENG

The BIOPEL biomass boiler includes a PID regulation to detect the calorific power of the fuel and achieve maximum savings. The BIOPEL boiler incorporates as standard the remote connection via the home's Wi-Fi.

Automatic cleaning of the burner and heat exchanger by brazing by means of an optional or standard compressor depending on the model. It is a Multi-fuel biomass boiler which can burn pellets and olive bones. The PID regulation measures the real generated power depending on the quality of the pellet, transmitting the exact required power by the home at all times. The boiler regulates the dosage of fuel and air based on the calorific value detected by adjusting the power.

BIOPEL 20/30/40



	Potencia nominal <i>Nominal heat output</i>	Potencia máxima <i>Maximum power</i>	Consumo <i>Consumption</i>	η	\varnothing	kg	m ²	kg
B20+silos150kg:	19,43 kw	20 kw	1,1-4,4 Kg/h	92,82%	150mm	228+55kg	200m ²	150kg
B20+silos250kg:	19,43 kw	20 kw	1,1-4,4 Kg/h	92,82%	150mm	228+95kg	200m ²	250kg
B30+silos150kg:	31,5 kw	30 kw	1,9-7,2 Kg/h	92,2%	150mm	228+55kg	300m ²	150kg
B30+silos250kg:	31,5 kw	30 kw	1,9-7,2 Kg/h	92,2%	150mm	228+95kg	300m ²	250kg
B40+silos250kg:	42,48 kw	40 kw	2,6-10 Kg/h	91,41%	150mm	400+95kg	400m ²	250kg

Colores
Colour



GRS + NRJ

Certificación
Certifications

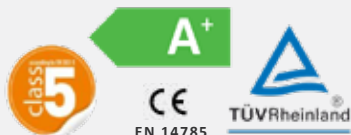

Medidas
Measures

B 20/30+150kg: 1102 mm
B 20/30+250kg: 1252 mm
B 40+250kg: 1352 mm
B 20/30+150kg: 953 mm
B 20/30/40+250kg: 1180 mm

B 20/30/40: 1234 mm



ESP

- Regulación automática de la combustión PID
- Control vía online de serie
- No necesita depósito de inercia, admite conexión directa al circuito de radiadores.
- Puertas NO incluidos en Biopel 40
- Puertas pagados en Biopel 20/30
- Impulsión y retorno DN 32
- Obligatorio válvula anticondensacion
- Limpieza automática quemador e intercambiaodor de serie en Biopel 40

ING

- Automatic PID combustion regulation
- Control via online as standard
- Does not need buffer tank, supports connection direct to the radiator circuit.
- Shipping NOT included in Biopel 40
- Carriage paid in Biopel 20/30
- Flow and return DN 32
- Mandatory anti-condensation valve
- Automatic burner and exchanger cleaning as standard in Biopel 40



Ecoplus	Referencia	Salida de humos \varnothing	Dimensiones (AxHxL)	P.V.P € (sin IVA)
Ecoplus 25	ECOPLUS25BOYSIS	160 mm	595 x 1425 x 1175 mm	2.999,00 €
Ecoplus 32	ECOPLUS32BOYSIS	160 mm	595 x 1475 x 1175 mm	3.299,00 €
Ecoplus 40	ECOPLUS40BOYSIS	160 mm	595 x 1545 x 1175 mm	3.549,00 €
Ecoplus 50	ECOPLUS50BOYSIS	160 mm	695 x 1545 x 1270 mm	3.779,00 €

ESP

La caldera de leña de gasificación ECOPLUS de llama invertida de CLASE 5 se encuentra disponible en 4 potencias desde 25 a 50 KW. Dispone de regulación automática de potencia de serie gracias al control del aire primario y secundario. El interior está revestido de refractarios en cámara de combustión para garantizar una larga vida de la caldera.

ENG

The ECOPLUS reverse flame gasification wood logs boiler has CLASS 5 and is available in 4 powers from 25 to 50 KW. It has automatic power regulation as standard thanks to the control of the primary and secondary air. The interior is lined with refractories in the combustion chamber to guarantee a long life for the boiler.

ECOPLUS 25/32/40/50

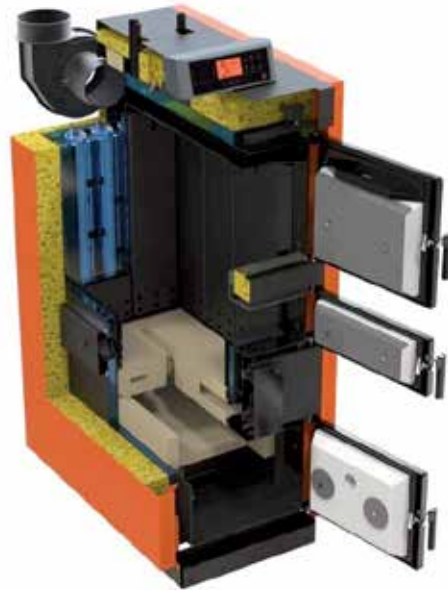
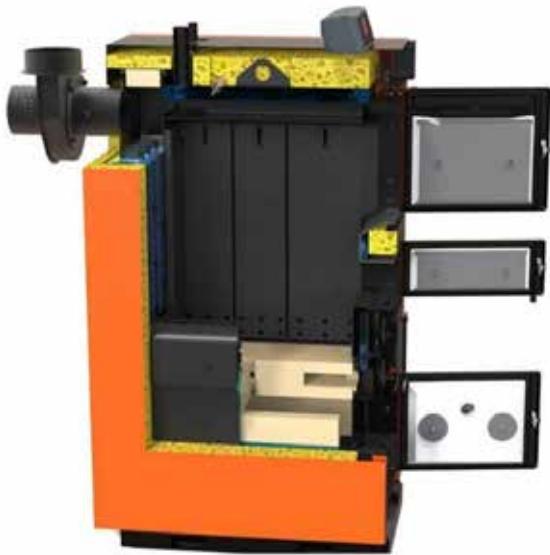

Potencia nominal
Nominal heat output

Vol. cámara combustión
Combustion chamber vol.

η **\varnothing** **kg** **m²**

E25:	25 kw
E32:	32 kw
E40:	40 kw
E50:	50 kw

120 l
130 l
140 l
220 l

92%	160mm	465kg	250m ²
92%	160mm	480kg	320m ²
92%	160mm	580kg	400m ²
92%	160mm	680kg	500m ²

Colores
Colour

Certificación
Certifications

Medidas
Measures



BLK + NRJ



E25/32/40: 595 mm E25/32/40: 1175 mm
E50: 695 mm E50: 1270 mm

E25: 1425 mm
E32: 1475 mm
E40/50: 1545 mm

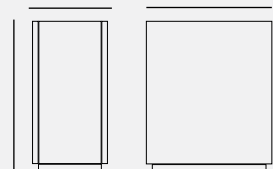

ESP

- Caldera de gasificación de llama invertida
- Imprescindible instalar depósito de inercia y válvula anticondensacion
- Volumen inercia = 13 x volumen cámara combustion
- Máxima longitud de troncos en cámara combustion 50cm (18-40kw) y 60cm (50kw)
- Portes NO incluidos en caldera
- Impulsión y retorno 1 1/2 pulgadas

ING

- Inverted flame gasification boiler
- It is essential to install an inertia tank and anti-condensation valve
- Inertia volume = 13 x combustion chamber volume
- Maximum length of logs in combustion chamber 50cm (18-40kw) and 60cm (50kw)
- Shipping NOT included in the boiler
- Inlet and return 1 1/2 inches

ESTUFAS PIROLÍTICAS DE PELLET

PELLET PYROLYTIC STOVES

ESP

¡Disfruta de las terrazas también durante el invierno!

Eficiencia y sostenibilidad en un solo producto. MICKEY / MINNIE es el calentador pirolítico para exterior que responde a la creciente atención al cambio climático, en armonía con elecciones cada vez más conscientes. Los sistemas de calefacción se encuentran entre los elementos más impactantes a nivel ambiental. Para esto, la tendencia de la industria es explorar nuevas fronteras de la innovación, que gracias a la tecnología de materiales y una visión amplia del diseño repensar en clave prácticas eco-sostenibles de la vida diaria.

MICKEY / MINNIE quiere ser la columna vertebral de una nueva cultura verde, calentando los espacios “al aire libre” durante los fríos meses de invierno.

ENG

Enjoy the terraces also during the winter!

Efficiency and sustainability in a single product. MICKEY / MINNIE is the outdoor pyrolytic heater that responds to the growing attention to climate change, in harmony with increasingly conscious choices. Heating systems are among the most impactful elements at an environmental level. For this, the trend of the industry is to explore new frontiers of innovation, which thanks to the technology of materials and a broad vision of design rethink eco-sustainable practices of daily life in key.

MICKEY / MINNIE wants to be the backbone of a new green culture, warming “outdoor” spaces during the cold winter months.



MINNIE-MICKEY



Minnie-Mickey	Referencia	Dimensiones (AxHxL)	P.V.P € (sin IVA)
Minnie	FU005	500 x 1755 x 500 mm	1.699,00 €
Mickey	FU006	500 x 2225 x 500 mm	1.799,00 €

ESP

Las estufas para exterior MICKEY & MINNIE funcionan gracias a la combustión de pellets mediante el proceso de la PIRÓLISIS. Las estufas se encienden mediante pastillas o líquido de encendido y el ventilador tiene una función solo para el encendido. Además resulta MUY ECONÓMICO gracias a su bajísimo consumo (2,5€ de combustible de pellet durante 4 horas).

ENG

MICKEY & MINNIE outdoor stoves work thanks to the combustion of pellets through the PYROLYSIS process. The stoves are ignited by tablets or ignition fluid and the fan has a function for ignition only. It is also VERY ECONOMIC thanks to its very low consumption (€ 2.5 pellet fuel for 4 hours).



ENCENDIDO FÁCIL y SENCILLO:



1.- Quite el brasero y cárguelo con 8kg de pellets para un funcionamiento durante 5h.



2.- Llène hasta el nivel y enciéndalo con las pastillas o con el líquido encendedor.



3.- Reinserte el brasero dentro de la estufa y encienda el ventilador.



4.- En 10 min la estufa estará en funcionamiento y **NO SE PODRÁ APAGAR** hasta que se consuma el pellet.

Potencia nominal
Nominal heat output

MINNIE: **8 kw**
MICKEY: **8 kw**

Potencia máxima
Maximum power

10 kw
10 kw

Consumo
Consumption

2 Kg/h
2 Kg/h



4-5h



2000mA



67kg



200m²



8kg

4-5h

2000mA

72kg

150m²

8kg

Colores
Colour



BLK

Certificación
Certifications



CE
EN 14785

Medidas
Measures

MINNIE: 1755 mm
MICKEY: 2225 mm



500 mm

ESP

- Batería y cable cargador **INCLUIDO**
- Duración carga en POT. MAX: 4 h (llama amarilla) / Duración carga en POT. MIN: 5 h (llama azul). Tiempo de recarga 8h.
- Transporte: sobre ruedas
- Regulador de ventilador: 0 (apagado) - MAX. (encendido)
- Batería de ventilación: 12V DC 7 Ah recargable
- Ventilador: 12V DC 0,27° 3,24W
- En caso de instalarlos en una carpa, siempre deberán mantener a una distancia mínima de 1 metro desde el techo. Para estos casos, se recomienda utilizar el modelo MINNIE por su menor altura.
- El ventilador debe encenderse y apagarse manualmente. Tiene una función inicial para el encendido durante 20min, a partir de la cual se puede apagar.
- El brasero deberá llenarse siempre hasta arriba para un correcto encendido. Cargas menores provocarán fallos de encendido.

ENG

- Battery and charger cable **INCLUDED**
- Duration of load in POT. MAX: 4 h (yellow flame) / POT. MIN: 5 h (blue flame). Full charging time: 8h
- Transport: on wheels
- Fan regulator: 0 (off) - MAX. (switched on)
- Ventilation battery: 12V DC 7 Ah rechargeable
- Fan: 12V DC 0.27 ° 3.24W
- In case of installing them in a tent, they should always keep a minimum distance of 1 meter from the ceiling. For these cases, it is recommended to use the MINNIE model due to its lower height.
- The fan must be switched on and off manually. It has an initial function to turn it on for 20min, after which it can be turned off.
- The brazier must always be filled to the top for correct lighting. Smaller loads will cause misfires.

ACCORDING
ACCESORIOS
AGGIUNTI



ACCESORIOS



KIT WIFI



¡¡NUEVA APP!!

- Disponible en Apple Store y Play Store para Apple y Android.
- Para el funcionamiento del **KIT WIFI** es necesario tener una **Red Wifi** local dando cobertura al lugar en el que se encuentra la estufa.



Nom.	<p>CONTROL REMOTO KIT WIFI</p>  <p>Control remoto de la estufa via WIFI, se puede encender la estufa, apagar, cambiar potencia de trabajo y temperatura de vivienda. Es necesario disponer wifi en la vivienda donde esté ubicada la estufa</p>	<p>SOLUCIÓN GPRS con kit wifi + router wifi 4G WIRELESS de tarjeta prepago con datos</p>  <p>Mediante un router con tarjeta sim que genere una zona wifi para la estufa. El kit wifi EOSS le permitira encender la estufa, apagar, cambiar potencia de trabajo y temperatura de vivienda.</p>
€	210,00 €	Router 4G LTE WIRELESS a cargo del cliente final
Ref.	PT009_A01	Router 4G LTE WIRELESS P.e. mod TP link TL-MR6400

BASIC LINE

TUBO PELLET

Ø	80
Espesor	1,2 mm
Calidad / Certificación	Acero / EN1856-2KIWA Acero negro Vitrificado y lacado
Color	Negro Mate
Junta - Silicona	T 300°C - Pres 200 Pa





ACCESORIOS

PELLET: CHIMENEA NEGRA Ø 80

Nom.	Tubería 1000 mm BASIC		Tubería 500 mm BASIC		Tubería 250 mm BASIC		T 90° doble Hembra BASIC	
Il.								
Ø	Ø80	Ø100	Ø80	Ø100	Ø80	Ø100	Ø80	Ø100
€	26,40 €	31,50 €	20,20 €	24,20 €	17,50 €	20,50 €	41,60 €	45,00 €
Ref.	RP080/1000CZ12P	RP100/1000CZ12P	RP080/500-CZ12P	RP100/500-CZ12P	RP080/250-CZ12P	RP100/250-CZ12P	TR080/90-CZ12P	TR100/90-CZ12P

Nom.	T 90° doble Macho BASIC		Tapa Condensados BASIC		Codo 45° BASIC		Codo 90° BASIC	
Il.								
Ø	Ø80	Ø100	Ø80	Ø100	Ø80	Ø100	Ø80	Ø100
€	41,60 €	45,00 €	22,70 €	25,00 €	26,80 €	31,00 €	32,20 €	38,00 €
Ref.	W-SOL-TR080/90	W-SOL-TR100/90	MS/Z080-C12P	MS/Z100-C12P	KS080/45-CZ12P	KS100/45-CZ12P	KS080/90-CZ12P	KS100/90-CZ12P

Nom.	Abrazadera a pared ajustable BASIC		Conector pellet Hembra-Hembra BASIC		Codo ESPECIAL 90 BASIC		Codo 90 INSPECCION BASIC	
Il.								
Ø	Ø80	Ø100						
€	19,50 €	22,00 €	30,00 €		35,00 €		65,00 €	
Ref.	OMD-I-080-CZ12P	OMD-I-100-CZ12P	ZZ080-CZ1.2P		KS8090CZ12P2SEG		KSR080/90-CZ12P	

Nom.	Embellecedor circular BASIC		Junta silicona NEGRA BASIC (entre chimeneas)		Embellecedor ovalado silicona BASIC		Insert techo/tele hat BASIC	
Il.								
Ø	Ø80	Ø100			Ø80		Ø80	
€	14,30 €	15,00 €	1,50 €		15,00 €		38,00 €	
Ref.	ROZII080-CZ12P	ROZII100-CZ12P	M-PROF-LARKI-80		ROZIII080-CZ12		ROZ/WJ80-CZ1,2	

Nom.	Caperuza fachada antiviento NEGRA		Caperuza a fachada trapecio (no apta para zonas ventosas)		Caperuza a fachada NEGRA		Caperuza china vertical NEGRA		Caperuza antiviento vertical INOX	
Il.										
Ø	Ø80	Ø100					Ø 80		Ø 100	
€	39,60 €	45,00 €	54,00 €		28,00 €		29,50 €		34,00 €	
Ref.	WBZ080-CZ1.2P	WBZ100-CZ1.2P	CZNP080-CH		WB080-CZ1.2P		DK080-CZ1.2P		DK100-CZ1.2P	
										WCG80-CH-B

SLIM LINE SLIM LINE SLIM LINE

TUBO LISO PELLET

∅	80
Espesor	<u>1,2 mm</u>
Calidad / Certificación	Acero / EN1856-2KIWA
Color	Negro Mate
Junta - Silicona	T 300°C - Pres 200 Pa



ACCESORIOS

PELLET: SLIM NEGRA Ø 80

Nom.	Tubería 1m SLIM	Tubería 0,5m SLIM	Tubería 0,25m SLIM	Tubería 0,5 m INSPECCION SLIM
Il.				
€	27,00 €	20,70 €	17,90 €	37,80 €
Ref.	RP80/1000CZ12SP	RP80/500CZ1.2SP	RP80/250CZ1.2SP	RPR80/05CZ12SP

Nom.	Tubo telescopico SLIM (0,4m-0,6 m)	Codo 45º SLIM	T90 doble Hembra SLIM	T90 INSPECCION SLIM
Il.				
€	61,60 €	27,40 €	42,20 €	57,60 €
Ref.	RT80/2X033SP12S	KS080/45-CZ12SP	TR080/90CZ12SP	TRZ80/90CZ1.2SP

Nom.	Codo especial 90º INSPECCION SLIM	Codo 90º SLIM	Codo 90º INSPECCION SLIM	Codo especial 90º SLIM
Il.				
€	62,20 €	32,70 €	60,00 €	35,50 €
Ref.	KSR80/90CZ12SP2	KS080/90-CZ12SP	KSR080/90CZ12SP	KS080/90SP2SEG

Nom.	Tapa condensados SLIM	Conector Hembra-Hembra SLIM	Conector Macho-Macho SLIM
Il.			
€	24,00 €	7,60 €	25,00 €
Ref.	MS/Z080-CZ12SP	ZZ-80-CZ1.2SP	ZM80-CZ1.2SP

Nom.	Abrazadera pared ajustable SLIM	Junta Silicona SLIM roja (entre chimeneas)	Spray chimenea negra SLIM
Il.			
€	21,40 €	4,50 €	33,00 €
Ref.	OMD-I-080CZ12SP	USZCZELKA-80SPP	FARBASENOTHERM

INOX LINE INOX LINE INOX LINE





PELLET: CHIMENEA INOX Ø80 PARED SIMPLE AISI 316L

Ø	80
Espesor	0,6 mm
Calidad / Certificación	316L / EN1856-2KIWA
Color	Inox
Junta - Silicona	T 300°C - Pres 200 Pa









ACCESORIOS

PELLET: INOX LINE Ø 80

Nom.	INOX SIMPLE 80 tubería 1m	INOX SIMPLE 80 tubería 0,5 m	INOX SIMPLE 80 tubería 0,25m	INOX SIMPLE 80 T 90 doble Hembra
Ilu.				 Hembra
€	28,40 €	19,50 €	13,70 €	36,60 €
Ref.	RP80/1000-KS	RP80/500-KS	RP80/250-KS	TR80/90-CH5-KS

Nom.	INOX SIMPLE 80 codo 45º	INOX SIMPLE 80 codo 90º	BASIC NEGRA tapa condensados 80	BASIC NEGRO Embellecedor circular 80
Ilu.				
€	21,00 €	29,00 €	22,70 €	14,30 €
Ref.	KS80/45-KS	KS80/90-KS	MS/Z080-C12P	ROZII080-CZ12P

Nom.	BASIC NEGRA Abrazadera pared ajustable	BASIC NEGRA Conector Hembra-Hembra	Caperuza fachada antiviento NEGRA	Caperuza a fachada trapecio (no apta para zonas ventosas)
Ilu.				
€	19,50 €	30,00 €	39,60 €	54,00 €
Ref.	OMD-I-080-CZ12P	ZZ080-CZ1.2P	WBZ080-CZ1.2P	CZNP080-CH

Nom.	Caperuza a fachada NEGRA	Caperuza china vertical NEGRA	Caperuza antiviento vertical INOX
Ilu.			
€	28,00 €	29,50 €	53,40 €
Ref.	WB080-CZ1.2P	DK080-CZ1.2P	WCG80-CH-B

INOX DOBLE LINE INOX DOBLE LINE INOX DOBLE LINE



**PELLET:
CHIMENEA INOX 316L Ø80 PARED DOBLE**





Ø	INT. 80/ EXT. 140
Espesor	0,6 mm
Calidad / Certificación	316 L/EN1856-2KIWA
Color	Inox
Junta - Silicona	T 300°C - Pres 200 Pa





ACCESORIOS

CHIMENEA INOX DOBLE PARED Ø 80

Nom.	INOX DOBLE PARED Tubería 1 m Ø80/140 (incluye abrazadera)	INOX DOBLE PARED Tubería 0,5 m Ø80/140 (incluye abrazadera)	INOX DOBLE PARED Tubería 0,25 m Ø80/140 (incluye abrazadera)	INOX DOBLE PARED T90 80/140 (incluye 2 abrazaderas) 2 hembras
Ilu.				 Macho Hembra Hembra
€	90,00 €	70,00 €	50,00 €	97,00 €
Ref.	RPD080/140/1000	RPD080/140/500	RPD080/140/250	TRPD080/140/90-CH

Nom.	INOX DOBLE PARED Codo 45 Ø80/140 (incluye abrazadera)	INOX DOBLE PARED Codo 90 Ø80/140 (incluye abrazadera)	INOX DOBLE PARED Caperuza china Ø80/140 (incluye abrazadera)	INOX DOBLE PARED Tapa condensados Ø80/140 CON drenaje y soporte (incluye abrazadera)
Ilu.				
€	65,00 €	95,00 €	55,00 €	40,00 €
Ref.	KSD080/140/45	KSD080/140/90	DKD080/140-CHS	MSD080/140-KSIZ

Nom.	Abrazadera entre chimenea Ø140	Abrazadera a pared ajustable Ø140	INOX DOBLE PARED transición simple a doble Ø80/140 (incluye abrazadera)
Ilu.			
€	10,00 €	34,00 €	35,00 €
Ref.	OPI140-X	OMD140-X	ZTD-N-080/140

HERMETIC LINE

(TUBERÍAS DE GAS)

**GAS Y PELLET:
DOBLE FLUJO DE TOMA DE AIRE DEL EXTERIOR**

∅	100/150 - 130/200
Espesor	0,6 mm
Certificación	EN1856-2KIWA
Calidad Interior/ Exterior	304 / 316 L
Color	Inox





ACCESORIOS

GAS Y PELLET: HERMETIC LINE

Nom.	Adaptador UNIVERSAL M-H 1000 mm		Adaptador UNIVERSAL M-H 250 mm		Tubería 1000 mm HERMETIC		Tubería 500 mm HERMETIC		Tubería 250 mm HERMETIC	
Il.										
Ø	Ø100/150	Ø130/200	Ø100/150	Ø130/200	Ø100/150	Ø130/200	Ø100/150	Ø130/200	Ø100/150	Ø130/200
€	82,00 €	109,00 €	39,00 €	54,00 €	75,00 €	103,00 €	49,00 €	68,00 €	32,00 €	49,00 €
Ref.	ADD.../.../1SGS		ADD.../.../250		RPD.../.../1SGS		RPD.../.../5SGS		RPD.../.../2SGS	

Nom.	Tubería 250 mm HERMETIC INSPECCION		Tubería Telescopica 250 mm HERMETIC		Codo 30º HERMETIC		Codo 15º HERMETIC	
Il.								
Ø	Ø100/150	Ø130/200	Ø100/150	Ø130/200	Ø100/150	Ø130/200	Ø100/150	Ø130/200
€	70,00 €	86,00 €	97,00 €	134,00 €	52,00 €	64,00 €	52,00 €	64,00 €
Ref.	RPDR.../.../250		RTD.../...2X250		KSD.../.../30-SGSP		KSD.../.../15-SGSP	



Nom.	Codo 90º HERMETIC INSPECCION		Codo 90º HERMETIC		Codo 45º HERMETIC	
Il.						
Ø	Ø100/150	Ø130/200	Ø100/150	Ø130/200	Ø100/150	Ø130/200
€	103,00 €	125,00 €	66,00 €	87,00 €	52,00 €	64,00 €
Ref.	KSDr.../.../90-SGSP		KSD.../.../90-SGSP		KSD.../.../45-SGSP	

Nom.	Soporte a pared		Soporte Intermedio HERMETIC		Reductor HERMETIC		Set renovación HERMETIC	
Il.								
Ø	Ø100/150	Ø130/200	Ø100/150	Ø130/200	Ø100/150	Ø130/200	Ø100/150	Ø130/200
€	95,00 €	95,00 €	78,00 €	87,00 €	56 €	59 €	122,00 €	134,00 €
Ref.	KWD.../.../5-15-SGSP		PPD.../...-SGSP		RDD.../.../...-SGSP		PPDR.../...-SGSP	

Nom.	Abrazadera a pared		Terminal Vertical TEJADO		Terminal Horizontal FACHADA	
Il.						
Ø	Ø150	Ø200	Ø100/150	Ø130/200	Ø100/150	Ø130/200
€	33,00 €	33,00 €	62,00 €	73,00 €	129,00 €	169,00 €
Ref.	OMD-I-...-X/SGS		WG.../...PION-S		WB.../...-POIII	

POLITUBE

TUBO DE CANALIZACIÓN FLEXIBLE

Nom.	POLITUBE 60 con 10 metros por caja	POLITUBE 80 con 10 metros por caja	POLITUBE 125 con 8 metros por caja	POLITUBE 150 con 6 metros por caja	Conector tubería corrugada Macho-Macho		Conector tubería corrugada Hembra-Hembra	
Ilustración								
Ø	Ø60	Ø80	Ø125	Ø150	Ø60	Ø80	Ø125	Ø150
€	26,00 €/m (caja 10m 260,00 €)	29,00 €/m (caja 10m 290,00 €)	41,00 €/m (caja 8m 328,00 €)	51,00 €/m (caja 6m 306,00 €)	18,00 €	4,00 €	4,50 €	4,50 €
Ref.	POLITUBE 60	POLITUBE 80	POLITUBE 125	POLITUBE 150	ZWS-60-OC	ZWS-80-OC	ZWS-125-OC	ZWS-150-OC

** muy flexible (Radio 8cm en tubo Ø80mm), muy ligero, robusto (polyester con hilo de acero) y autoextinguible con una gran resistencia a altas temperaturas hasta 180°C y gran capacidad de aislamiento.

El grado de aislamiento es equiparable al CORCHO. El polyester tiene la misma conductividad térmica que el corcho (0,03-0,04 W/mK), frente al acero cuya conductividad es 100 veces superior (50-60 W/mK).

APROVECHAMIENTO DEL CALOR		
TIPO CANALIZACIÓN	7 m acero SIN aislar	7m POLITUBE
TEMPERATURA SALIDA en estufa	80°C	80°C
TEMPERATURA tras canalización	50°C (frio)	70°C (caliente)
PÉRDIDA DE CALOR	30°C (MUY MALO)	10°C (MUY BUENO)



MÍNIMAS PÉRDIDAS TÉRMICAS gracias a la pared interna LISA que minimiza las pérdidas por fricción al paso del aire y material de muy baja conductividad térmica (como el corcho) - evitando el uso de aislamiento externo envolvente adicional.

ECONOMICO. Reducción de 80% del tiempo de ejecución de una instalación. Evita el coste adicional del aislamiento, pero lo que es más importante el tiempo y coste del operario en instalar un tubo de acero rígido y calorifugarlo. La gran flexibilidad de este tubo permite instalarlo rápidamente.

INOXFLEX



TUBO DE HUMOS FLEXIBLE 316 L

Nom.	INOXFLEX diam 80 ROLLO 10 metros (exterior flexible corrugada e interior de pared lisa)	INOXFLEX diam 125 ROLLO 10 metros (exterior flexible corrugada e interior de pared lisa)	INOXFLEX diam 150 ROLLO 10 metros (exterior flexible corrugada e interior de pared lisa)	Conector tubería corrugada Macho-Macho	Conector tubería corrugada Hembra-Hembra	
Ilu.						
∅	INT. 80-EXT. 83 Radio mín en curvatura 150mm	INT. 125-EXT. 128 Radio mín en curvatura 240mm	INT. 150-EXT. 153 Radio mín en curvatura 260mm	∅80	∅125	∅150
€	224,00 €/caja	314,00 €/caja	381,00 €/caja	4,00 €	4,50 €	4,50 €
Ref.	LIS0280	LIS02125	LIS02150	ZWS-80-OC	ZWS-125-OC	ZWS-150-OC

INOXFLEX: Entubado de conductos de chimenea con el fin de evitar el humo proveniente de calderas de gas natural propano, gasóleo, leña, carbón, etc. No es apto para instalaciones donde haya ambientes alógenos, tales como: Lavanderías, tintorerías, etc. Fabricado en acero inoxidable AISI-316 de 0,12 de espesor con doble hoja. Su pared interna, lisa, constituida en una sola banda, permite evitar los problemas de condensación. Resiste una temperatura de 450° C, en funcionamiento normal, con puntas de 750° C. La gran flexibilidad de este tubo, permite el entubado de chimeneas con problemas de condensación o rotura de paredes.

ALUFLEX



TUBO CANALIZACIÓN EXTENSIBLE (ALUMINIO)

Nom.	Tubería aluminio extensible 1- 3 m					
Ilu.						
∅	∅80	∅100	∅125	∅150	∅200	∅250
€	8,00 €	11,00 €	12,00 €	15,00 €	22,00 €	28,00 €
Ref.	RESF-080-AL	RESF-100-AL	RESF-125-AL	RESF-150-AL	RESF-200-AL	RESF-250-AL

Nom.	VIP lamela fija BLANCO (SIN rueda)					VIP lamela fija NEGRA (SIN rueda)				
llu.										
rejilla	200 x 145	190 x 170	240 x 170	325 x 170	450 x 170	200 x 145	190 x 170	240 x 170	325 x 170	450 x 170
€	22,50 €	26,00 €	30,00 €	32,80 €	42,30 €	22,50 €	26,00 €	30,00 €	32,80 €	42,30 €
Ref.	KRVZS200* 145-B	KRZS 190X170-BC	KRVZS 240X170MLB	KRVZS 325*170-B	KRVZS 450*170-B	KRVZS 200X145	KRVZS 190X170	KRVZS2 40*170-CZ	KRVZS 325X170-CZ	KRVZS 450X170-CZ

Nom.	VIP lamela fija BLANCO (CON rueda)					VIP lamela fija NEGRA (CON rueda)				
llu.										
rejilla	200 x 145	190 x 170	240 x 170	325 x 170	450 x 170	200 x 145	190 x 170	240 x 170	325 x 170	450 x 170
€	33,50 €	33,00 €	35,50 €	42,70 €	52,40 €	33,50 €	33,00 €	35,50 €	42,70 €	52,40 €
Ref.	KRVZ 200X145-BCO	KRVZ1 90X170-BCO	KRVZ 240X170-BCO	KRVZ 325X170-BCO	KRVZ 45X17-BCO	KRVZ 200X145-CZ	KRVZ 190X170-CZ	KRVZ 240X170-CZ	KRVZ3 25X170-CZ	KRVZ 450X170-CZ





Nom.	VIP lamela malla BLANCA	VIP lamela malla NEGRA
llu.		
rejilla	240 x 170 mm	240 x 170 mm
€	18,00 €	18,00 €
Ref.	KRVSM240X170-CZ	KRVSM240X170-B



Nom.	VIP lamela transición interior Ø80*					VIP lamela transición interior Ø125*			
llu.									
rejilla	200 x 145	190 x 170	240 x 170	325 x 170	450 x 170	190 x 170	240 x 170	325 x 170	450 x 170
€	3,60 €	5,00 €	5,70 €	7,80 €	15,80 €	5,00 €	5,70 €	7,80 €	15,80 €
Ref.	KDPKRV 20X14/80	KDPKRV 19X17/80	KDPKRV 240170080	KDPKRV 325*170/8	KDPKRV 450*17080	KDPKRV 19X17/125	KDPKRV 240170125	KDPKRV 325*170/1	KDPKRV 450*17012

Nom.	Vip lamela transicion interior DOBLE Ø80	Vip lamela transicion interior DOBLE Ø125
llu.		
rejilla	450 x 170 mm	450 x 170 mm
€	16,00 €	16,00 €
Ref.	KDPKRV451702*80	KDPKRV45*17/2*1



*Consultar para diámetros de 100-150

REJILLAS SUN, REJILLAS CIRCULARES Y SUS ACCESORIOS

Nom.	SUN Transicion Interior				NEGRO rejilla SUN FIJA (SIN rueda)	BLANCA rejilla SUN FIJA (SIN rueda)	BLANCA rejilla SUN FIJA (CON rueda)
Ilustración							
Ø	Ø80	Ø100	Ø125	Ø150			
rejilla	195x170	195x175	195x176	195x177	175 x 195 mm	175 x 195 mm	175 x 195 mm
€	3,00 €	3,00 €	3,00 €	3,00 €	13,00 €	13,00 €	25,00 €
Ref.	KDPRL2/080-OC	KDPK2/100	KDPK2/125	KDPK2/150	K2-ML-CZ	K2-ML-B	KZ2-ML-B

Nom.	POINT REJILLA BLANCA circular regulable Ø80	POINT REJILLA NEGRA circular regulable Ø80
Ilustración		
Ø		
€	36,00 €	36,00 €
Ref.	KR080-ML.B	KR080-ML.CZ



ACCESORIOS CANALIZACIÓN

Nom.	GALVANIZADO bifurcacion 1 a 2 en Y			NEGRO bifurcacion 1 a 2 en Y Ø80
Ilustración				
Ø	Ø80	Ø125	Ø150	2 hembras Macho
€	10,00 €	10,00 €	10,00 €	45,00 €
Ref.	YS-080/120-OC	YS-125/120-OC	YS-150/120-OC	YR080/120-CZ1.2

ACCESORIOS VARIOS

Nom.	Pasamuros telescopio 320-550 mm Ø80	Toma aire UNIVERSAL tubo entrada a estufa 35mm-60mm membrana elastica	Cinta Aluminio 150°C 5cm*10m	GALVANIZADO ampliacion entrada aire 80 a 105
Ilustración				
€	57,70 €	75,00 €	5,00 €	25,00 €
Ref.	NO080A-ML	37060903	TA50*10/150°C	W-ZAD21-6636

LEÑA: CANALIZACIÓN VENTILACION FORZADA Y EXTRACCIÓN HUMOS

Nom.	Ventilador Aire Caliente			Extractor a tejado		Interruptor Ruleta
Ilustración						
Ø	Ø125 400m3/h	Ø150 600m3/h	Ø150 800m3/h	Ø150	Ø200	
€	246,00 €	288,00 €	326,00 €	582,00 €	582,00 €	56,00 €
Ref.	AN1+RO200	AN2+RO200	AN3+RO200	GCK150CH+RO200	GCK2000CH+RO200	RO200

TUBERÍA DE LEÑA



Nom.	NEGRO LEÑA Tuberia 1 m			NEGRO LEÑA Tuberia 0,5 m			NEGRO LEÑA Tuberia 0.25m		
Il.									
Ø	Ø150	Ø200	Ø250	Ø150	Ø200	Ø250	Ø150	Ø200	Ø250
€	40,00 €	47,00 €	58,00 €	30,00 €	24,00 €	42,00 €	22,00 €	26,00 €	30,00 €
Ref.	PR-150/1000-CZ2	PR-200/1000-CZ2	PR-250/1000-CZ2	PR-150/500-CZ2	PR-200/500-CZ2	PR-250/500-CZ2	PR-150/250-CZ2	PR-200/250-CZ2	PR-250/250-CZ2

Nom.	NEGRO LEÑA Codo 45º			NEGRO LEÑA Codo 90º			NEGRO LEÑA Codo 90º con inspección		
Il.									
Ø	Ø150	Ø200	Ø250	Ø150	Ø200	Ø250	Ø150	Ø200	Ø250
€	27,00 €	30,00 €	33,00 €	27,00 €	33,00 €	33,00 €	29,00 €	36,00 €	44,00 €
Ref.	KS-150/45-CZ2	KS200/45-CZ	KS-250/45-CZ2	KS150/90-CZ	KS200/90-CZ	KS-250/90-CZ2	KSR-150/90-CZ2	KSR-200/90-CZ2	KSR-250/90-CZ2

Nom.	NEGRO LEÑA Embellecedor circular			NEGRO LEÑA Conector M-M			NEGRO LEÑA Conector H-H			NEGRO LEÑA Abrazadera ajustable a pared		
Il.												
Ø	Ø150	Ø200	Ø250	Ø150	Ø200	Ø250	Ø150	Ø200	Ø250	Ø150	Ø200	Ø250
€	15,00 €	20,00 €	23,00 €	28,00 €	30,00 €	33,00 €	24,00 €	29,00 €	34,00 €	30,00 €	30,00 €	30,00 €
Ref.	ROZ-150-CZ	ROZ-200-CZ	ROZ-250-CZ	ZM-150-CZ2	ZM-200-CZ2	ZM-250-CZ2	ZZ-150-CZ2	ZZ-200-CZ2	ZZ-250-CZ2	OMD-150-X	OMD-200-X	OMD-250-X

REGULADORES DE LEÑA: TIRO EXCESIVO





Nom.	Regulador de tiro 80 Macho	Regulador de tiro 150 Macho	Regulador de tiro 180 Macho
Il.			
Ø	Ø80	Ø150	Ø180
€	77,00 €	100,00 €	227,00 €
Ref.	RCO-80	RCO-150	KW11Z-180

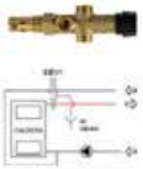
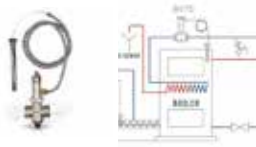
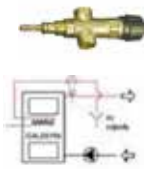

ACCESORIOS

FONTANERIA



Nom.	Valvula descarga termica DBV1 g 3/4" (UNI/BIOPEL)	Valvula descarga termica BVT5 95 1,3m g 3/4" (HDG)	Valvula descarga termica JBV1 g 3/4" (ECOMAX)	Bomba WITA DELTA PLUS U55/32 electronica alta eficiencia DN32 g 5/4"
llu.				
€	140,00 €	133,00 €	95,00 €	205,00 €
Ref.	14043	BVT595	8877	DP006HW

Nom.	Valvula anticondensación 55° C DN25 (1")	Valvula anticondensación 55° C DN32 (1 1/4" o 5/4")	Termostato de inmersión simple (Para instalar en depósitos)	Grupo seguridad hasta 100 kW (manometro, val seg 3 bar y purgador)
llu.				
€	118,80 €	129,60 €	38,00 €	100,00 €
Ref.	12142	12957	GCARR002	GS



ACCESORIOS

KIT LIMPIEZA CHIMENEAS

Nom.	Kit limpieza chimenea	Opcional cable prolongador 4 m
llu.		
	- Incluye: maletín, cable 6 m, hilo de silicona, tubo adaptador para aspirador de cenizas - Se acciona por medio del taladro (no suministrado) - No se genera ceniza en la vivienda, máxima limpieza	
€	500,00 €	275,00 €
Ref.	SFS6000 + UTO1PLT	PSSA-4000

S  **LAR**
T E C N I K

DISTRIBUIDOR AUTORIZADO

Versión 210515

El distribuidor tiene derecho a modificar sin previo aviso características de cualquier tipo

 **eOSS**

styled in spain
made in europe