

saving
water
around
the world

fominaya®
Original *Since 1939*

SISTEMAS INSTALACIONES SANITARIOS 2023 V1



COMPROMISO I+D
MEDIOAMBIENTAL



SOLUCIONES DE
AHORRO DE AGUA



PLÁSTIC
FREE

EMBALAJES
ECOLÓGICOS



RECYCLED
PAPER

PAPEL Y CARTÓN
RECICLADO



Made in Spain



MANAGEMENT SYSTEM CERTIFICATE

Certificate no.:
248742-2017-AQ-IBE-ENAC

Initial certification date:
03 March 2000

Valid:
17 November 2020 – 16 November 2023

This is to certify that the management system of
FOMINAYA, S.A.
Ctra. del Pla, s/n, 46117, Bétera, Valencia, Spain

has been found to conform to the Quality Management System standard:
ISO 9001:2015

This certificate is valid for the following scope:

Design, production and commercialization of flushing and filling articles for WC cisterns and concealed systems with double push button and their accessories; design, production and commercialization of accessories for sanitary water installations.

Place and date:
Barcelona, 15 October 2021

For the issuing office:
DNV - Business Assurance
Gran Via de les Corts Catalanes 130-136, Pl. 9,
08038, Barcelona, Spain



Ana del Rio Salgado
Management Representative

Lack of fulfillment of conditions as set out in the Certification Agreement may render this Certificate invalid.
ACCREDITED UNIT: DNV GL Business Assurance España, S.L.U., Gran Via de les Corts Catalanes 130-136, Pl. 9, 08038 Barcelona, Spain - TEL: +34 93 479 26 00.
www.dnv.es/assurance



Fundada en 1939, Fominaya® es una empresa española especialista en diseño, fabricación, distribución y comercialización de artículos destinados a instalaciones sanitarias (sistemas de descarga, sistemas de alimentación, sistemas de accionamiento para cisternas sanitarias...), artículos destinados a instalaciones de agua y accesorios. En la actualidad se encuentra presente en más de cuarenta países repartidos por todo el mundo.

La gama de productos Fominaya® cumple estrictamente con la filosofía y estrategia que le ha hecho convertirse en referente:

- INNOVACIÓN + DESARROLLO
- RESPONSABILIDAD MEDIOAMBIENTAL
- NUESTRO OBJETIVO: LA EXCELENCIA



COMPROMISO I+D
MEDIOAMBIENTAL



SOLUCIONES DE
AHORRO DE AGUA



PLÁSTIC
FREE

EMBALAJES
ECOLÓGICOS



RECYCLED
PAPER

PAPEL Y CARTÓN
RECICLADO



Made in Spain



fominaya®

SAVING WATER AROUND THE WORLD

Portugal, France, Morocco, Tunisia, Algeria,
Libya, Syria, Lebanon, Russia, Malta, Albania,
Romania, Cyprus, Czech Republic, Gabon, Réunion,
Mauritius, Madagascar, Tahiti, Jordan, Kuwait, Qatar,
Bahrain, India, Saudi Arabia, United Arab Emirates,
Italy, Belgium, United Kingdom, Kenya, Tanzania,
Uganda, Kazakhstan, Kyrgyzstan, Turmenistan, Polynesia,
Suriname, Sri Lanka, Colombia, Peru, Cuba, Mexico...



Made in Spain

NOVEDADES

DRACKO

DESCARGADOR UNIVERSAL CON CABLE

Regulación de la doble descarga:

PRODUCTO VERDE.

Compatible bases Roca* y Fominaya®.

DRACKO 10 (Ref. 0139301011)

Pulsador + Campana + Base +
Acople + Kit de Juntas

DRACKO 12 (Ref. 0139309011-0139307011)

Pulsador + Campana + Base +
Acople + Kit de Juntas + Tornillos

 **20 UDS** Packaging Bolsa - **Packaging Caja**

Disponibilidad: 2023



PULSADORES ¡YA DISPONIBLES!

ESPECIAL INODOROS CON AGUJERO EXTRA GRANDE

PTY 2 (Ref. 0142304110)



Compatible con:

Fomi **CYCLON**
Fomi **TYFON 3G**
Fomi **TYFON+**
AQUA SIMPLE

P 2 (Ref. 0142205110)



Compatible con:

Fomi **EcoCYCLON**
Fomi **EcoTYFON 5G**
AQUA DOBLE

PDK 2 (Ref. 0142206110)



Compatible con:

Fomi **DRACKO**

 **10 UDS/CAJA EN PULSADORES PARA CISTERNAS DE HASTA 60 MM Ø**

NILO BIDÉ

BASTIDOR SUJECIÓN BIDÉ

Bastidor metálico con regulación universal.
Instalación de bidé suspendido en pared sólida o pladur.
Para bidé suspendido con distancia 180 ó 230 mm.



Bastidor universal altura 114 cm.
Soportes de pie galvanizados ajustables de 0 a 20 cm.
Dos conexiones para instalación de las llaves de regulación entrada de agua en latón con R 1/2".
La posición de la entrada es ajustable de 6 a 35 cm.
Codo de salida bidet HPDE Ø 30-46 mm.
Distancia de sujeción 18 ó 23 cm.
Pintura electrostática, color gris.
Peso máximo 400 Kg.
No incluye accesorios de sujeción.

CE-NILO-B
Ref. 0110400001
Packaging Caja

1 uds/caja

PVP: 170,00 €

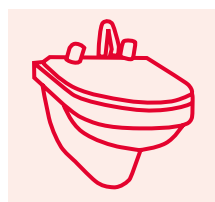

NILO LAVABO

BASTIDOR SUJECIÓN LAVABO

Bastidor metálico con regulación universal.
Instalación de lavabo suspendido en pared sólida o pladur.
Para lavabo suspendido con distancia entre 40 y 380 mm.



Bastidor universal altura 114 cm.
Soportes de pie galvanizados ajustables de 0 a 20 cm.
Dos conexiones para instalación de las llaves de regulación entrada de agua en latón con R 1/2".
La posición de la entrada es ajustable de 6 a 35 cm.
Codo de salida bidet HPDE Ø 32-44 mm.
Pintura electrostática, color gris.
No incluye accesorios de sujeción.

CE-NILO-L
Ref. 0110300001
Packaging Caja

1 uds/caja

PVP: 180,00 €





NILO_{CE}

BASTIDOR SUJECCIÓN INODORO 12 CM

Regulación de la doble descarga: **PRODUCTO VERDE**.

Instalación de cisterna de WC en pared sólida o pladur.

Para WC suspendido con distancia 180 ó 230 mm.

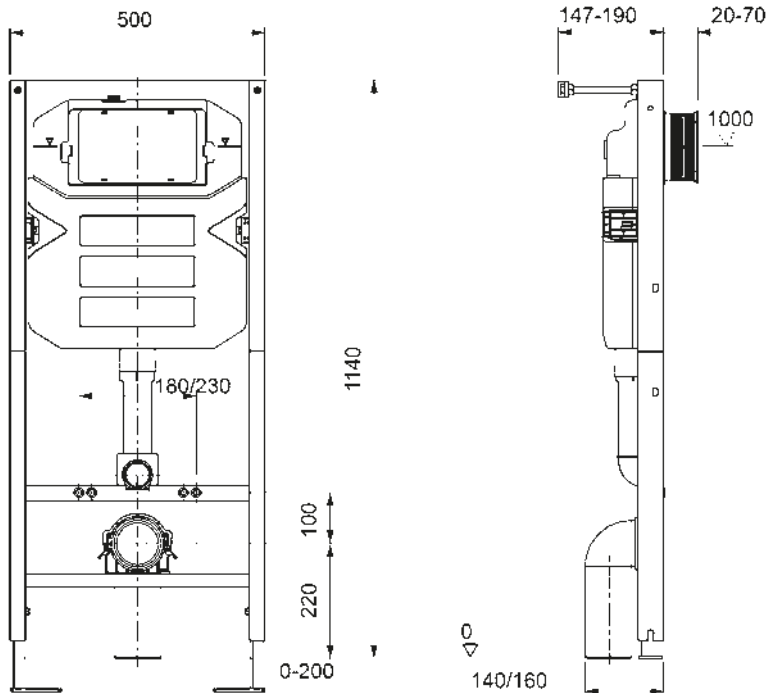

Descarga ajustable para 6/3 ó 4,5/3 l.

Set de conexión de WC Ø 90 mm.

Codo de salida WC en PVC ó HDPE Ø 110 mm.

Soportes pie galvanizados ajustables de 0 a 20 cm.

Cisterna empotrada aislada de la condensación.

Descargador de doble pulsador ajustable.

Válvula regulación conexión suministro de agua R 1/2".

Tapón de protección para los tubos de descarga.

Tapa de protección para apertura de servicio.

Barras con rosca M 12 para sujeción en cerámica.

Pintura electrostática, color gris.

Peso máximo 400 Kg.

Incluye accesorios de sujeción.

CE-NILO-I

Ref. 0110220001

Packaging Caja

1 uds/caja

PVP: 260,00 €

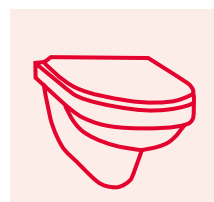



PÜLSADORES

PULSADOR MECÁNICO

Descarga interrumpible: **PRODUCTO VERDE**.
 Soporte de fijación. Instalación rápida.
 Incluye material de instalación.



QÜADRIGA PQC-M-CE

Ref. 0111110001

1 uds/caja

PVP: 38,90 €

Cromo Mate

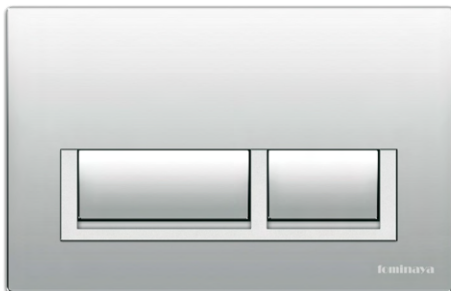

QÜADRIGA PQC-B-CE

Ref. 0111110002

1 uds/caja

PVP: 38,90 €

Cromo Brillo



QÜADRIGA PQC-N-CE

Ref. 0111110003

1 uds/caja

PVP: 43,57 €

Negro



COLISEÜM PCO-M-CE

Ref. 0111130001

1 uds/caja

PVP: 43,57 €

Cromo Mate



COLISEÜM PCO-B-CE

Ref. 0111130002

1 uds/caja

PVP: 39,90 €

Cromo Brillo



COLISEÜM PCO-N-CE

Ref. 0111130003

1 uds/caja

PVP: 39,90 €

Negro

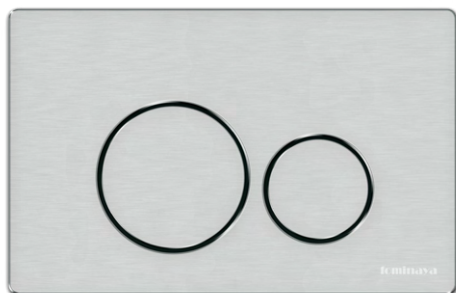

VANDALÜS PVA-M-CE

Ref. 0111140001

1 uds/caja

PVP: 79,90 €

Acero Inoxidable Mate

ANTIVANDÁLICO



VANDALÜS PVA-B-CE

Ref. 0111140002

1 uds/caja

PVP: 101,90 €

Acero Inoxidable Brillo

ANTIVANDÁLICO

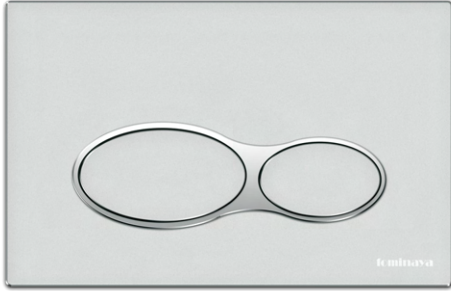
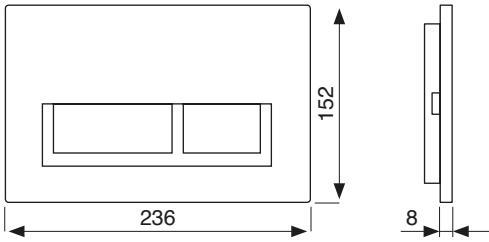

CIRCÜS PCC-M-CE
Ref. 0111120001

1 uds/caja

PVP: 51,00 €

Cromo Mate

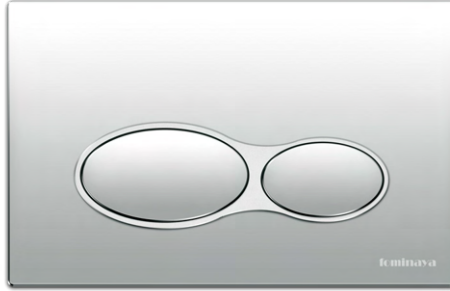

CIRCÜS PCC-B-CE
Ref. 0111120002

1 uds/caja

PVP: 51,00 €

Cromo Brillo

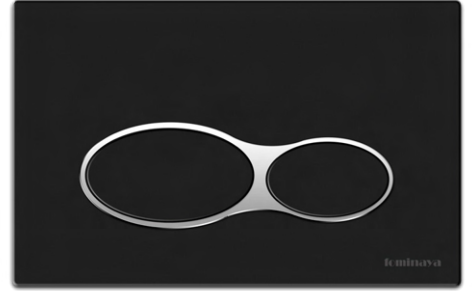

CIRCÜS PCC-N-CE
Ref. 0111120003

1 uds/caja

PVP: 51,00 €

Negro

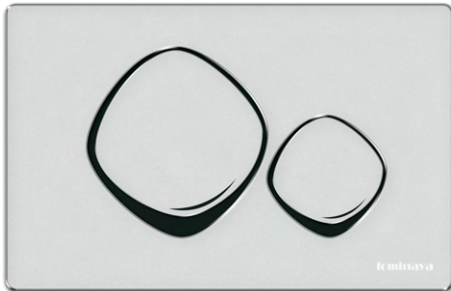

SPARTACÜS PSP-M-CE
Ref. 0111150001

1 uds/caja

PVP: 28,90 €

Cromo Mate

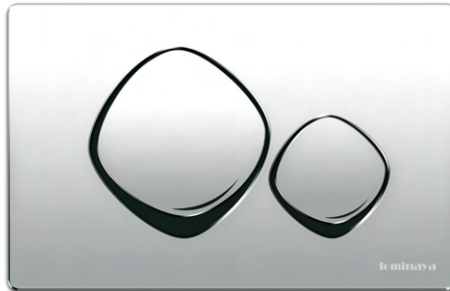

SPARTACÜS PSP-B-CE
Ref. 0111150002

1 uds/caja

PVP: 28,90 €

Cromo Brillo

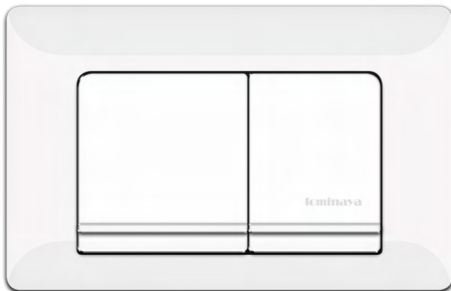

DOMÜS PDM-BL-CE
Ref. 0111160004

1 uds/caja

PVP: 25,45 €

Blanco

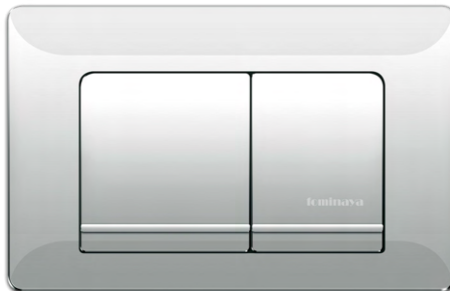

DOMÜS PDM-CB-CE
Ref. 0111160002

1 uds/caja

PVP: 29,62 €

Cromo Brillo

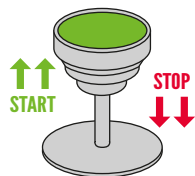

Installation Video



TIRADOR

DESCARGADOR UNIVERSAL

Mecanismos universales de tirador.
No es necesario cortar elementos para su instalación.
Compatible bases Negra y Fominaya®.



CE 3
Ref. 0146003100
Packaging Bolsa
25 uds/caja
PVP: 3,26 €
Campana
Especial reposición



DE 1
Ref. 0147004100
Packaging Bolsa
20 uds/caja
PVP: 5,16 €
Campana + Base +
Kit de Juntas



Installation Video



TIRADOR

DESCARGADOR UNIVERSAL REGULABLE

Regulación de la descarga: **PRODUCTO VERDE**.
No es necesario cortar elementos para su instalación.
Compatible bases Negra y Fominaya®.



OCEAN DE 2
Ref. 0147106300
Packaging Bolsa
25 uds/caja
PVP: 7,58 €
Campana + Base + Acople +
Kit de Juntas



BAHYA DE 3
Ref. 0147109400
Packaging Bolsa
25 uds/caja
PVP: 12,36 €
Tirador + Campana + Base + Acople +
Kit de Juntas (especial Victoria)



TYFON 3G

DESCARGADOR UNIVERSAL INTERRUPTIBLE

Descarga interrumpible: **PRODUCTO VERDE.**

No es necesario desmontar la cisterna.

Compatible bases Roca* y Fominaya®.

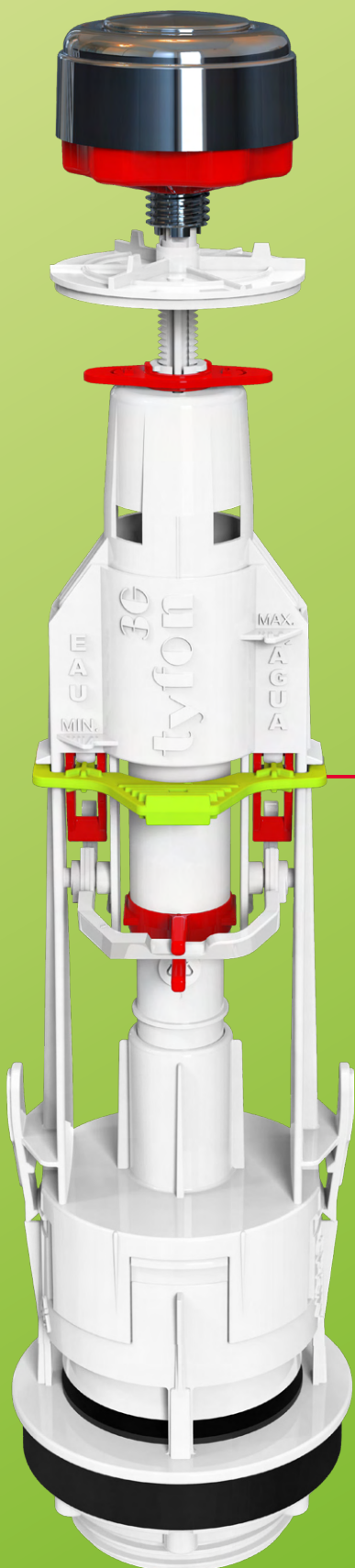

**NOVEDAD:
SISTEMA DE
INSTALACIÓN &
TRANSPORTE**



Installation Video



TYFON 3G 4

Ref. 0129305011

Packaging Bolsa

25 uds/caja

PVP: 11,32 €

Pulsador + Campana + Acople Especial reposición

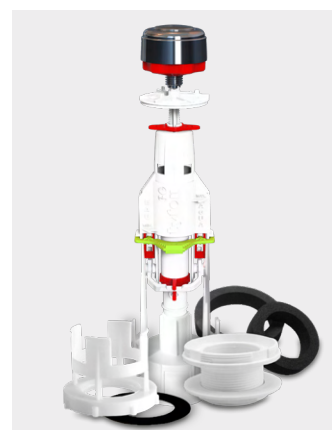

TYFON 3G 10

Ref. 0129307011

Packaging Bolsa

25 uds/caja

PVP: 14,01 €

Pulsador + Campana + Base + Acople + Kit de Juntas



TYFON 3G 12

Ref. 0129317031

Packaging Caja

20 uds/caja

PVP: 14,73 €

Pulsador + Campana + Base + Acople + Kit de Juntas + Tornillos

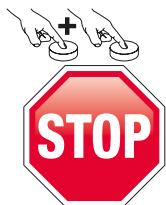

Installation Video

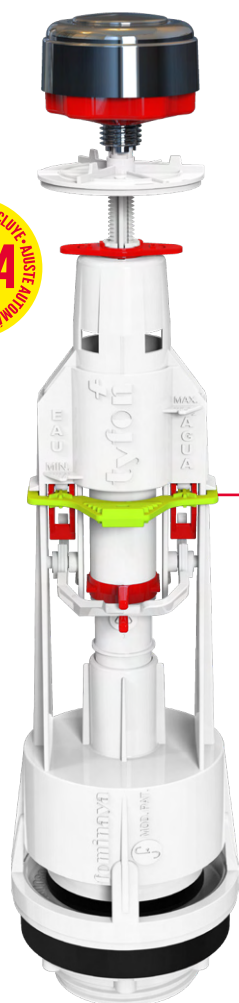

TYFON⁺

DESCARGADOR UNIVERSAL INTERRUPTIBLE

Descarga interrumpible: **PRODUCTO VERDE.**

NOVEDAD: SISTEMA DE INSTALACIÓN & TRANSPORTE.

Compatible bases Negra y Fominaya®.



TYFON⁺ 5
Ref. 0129101031
Packaging Bolsa

25 uds/caja

PVP: 11,32 €

Pulsador + Campana + Base +
Kit de Juntas



TYFON⁺ 10
Ref. 0129106031
Packaging Bolsa

25 uds/caja

PVP: 12,91 €

Pulsador + Campana + Base +
Acople + Kit de Juntas



Installation Video



CYCLON

DESCARGADOR UNIVERSAL REGULABLE

Regulación de la descarga: **PRODUCTO VERDE.**

No es necesario cortar elementos para su instalación.

Compatible bases Negra y Fominaya®.



CYCLON 5
Ref. 0129201031
Packaging Bolsa

25 uds/caja

PVP: 11,76 €

Pulsador + Campana + Base +
Kit de Juntas



CYCLON 10
Ref. 0129206031
Packaging Bolsa

25 uds/caja

PVP: 13,35 €

Pulsador + Campana + Base +
Acople + Kit de Juntas



ECO TYFON 5G

DESCARGADOR UNIVERSAL REGULABLE

Regulación de la doble descarga: **PRODUCTO VERDE**.
No es necesario desmontar la cisterna.
Compatible bases Roca* y Fominaya®.



**NOVEDAD:
SISTEMA DE
INSTALACIÓN &
TRANSPORTE**



Installation Video



ECO TYFON 5G 4
Ref. 0139305011

Packaging Bolsa
25 uds/caja

PVP: 12,64 €

Pulsador + Campana + Acople Especial reposición



ECO TYFON 5G 10
Ref. 0139327031

Packaging Bolsa
25 uds/caja

PVP: 15,71 €

Pulsador + Campana + Base + Acople + Kit de Juntas



ECO TYFON 5G 12

Ref. 0139328011 - 0139327011

Packaging Bolsa - **Packaging Caja**
25 uds/caja 20 uds/caja

PVP: 16,17 € - 16,93 €

Pulsador + Campana + Base + Acople + Kit de Juntas + Tornillos



9L
3-4L



Installation Video



DRACKO

DESCARGADOR UNIVERSAL CON CABLE

Regulación de la doble descarga: **PRODUCTO VERDE.**
El cable siempre por encima del agua: anticorrosión.
Compatible bases Roca* y Fominaya®.



DRACKO 10
Ref. 0139301011

Packaging Bolsa

20 uds/caja

PVP: 24,99 €

Pulsador + Campana + Base +
Acople + Kit de Juntas

Disponibilidad: 2023



DRACKO 12
Ref. 0139309011 - 0139307011

Packaging Bolsa - **Packaging Caja**

20 uds/caja 20 uds/caja

PVP: 26,11 € - 26,64 €

Pulsador + Campana + Base +
Acople + Kit de Juntas + Tornillos

Disponibilidad: 2023

6-9L
3-4L



Installation Video



ECO CYCLON

DESCARGADOR UNIVERSAL DOBLE REGULACIÓN

Regulación de la doble descarga: **PRODUCTO VERDE.**
No es necesario cortar elementos para su instalación.
Compatible bases Negra y Fominaya®.



ECO CYCLON 6

Ref. 0139206011

Packaging Bolsa

25 uds/caja

PVP: 20,77 €

Pulsador + Campana + Base
+ Kit de Juntas



ECO CYCLON 12

Ref. 0139207011

Packaging Caja

20 uds/caja

PVP: 21,87 €

Pulsador + Campana + Base +
Acople + Kit de Juntas + Tornillos



FENYX DUAL

FLOTADOR COMPACTO UNIVERSAL

Lateral + inferior. Boya regulable: **PRODUCTO VERDE**.
Cierre progresivo pistón: especial todo tipo de aguas.
Llenado rápido. Sin mantenimiento. Compacto.

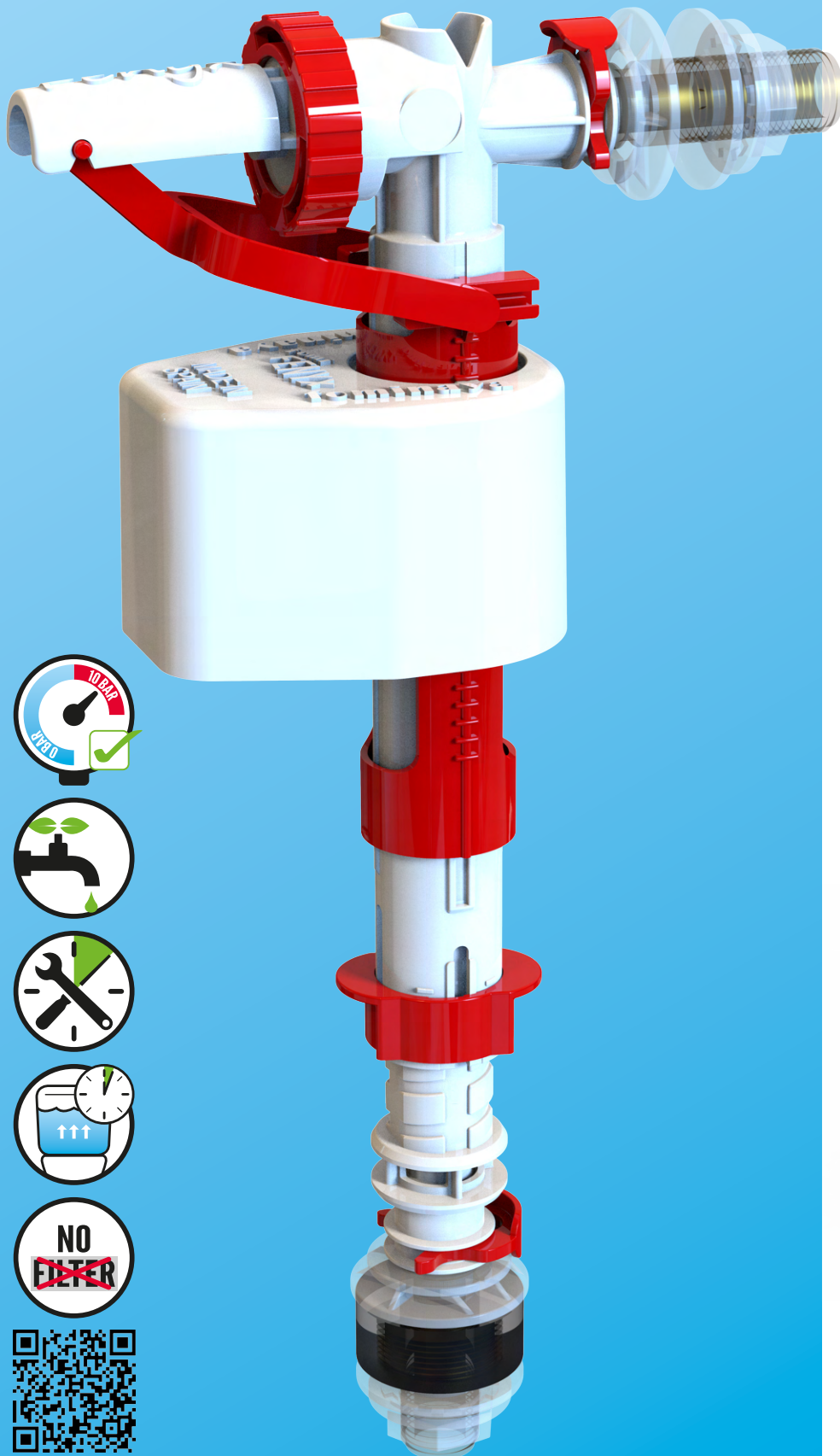

Installation Video



FENYX DUAL
Ref. 0144401420
Packaging Bolsa

25 uds/caja

PVP: 11,28 €

Ø 3/8" Latón

Sistema patentado: 201430093



FENYX DUAL Ref.
0144405420

Packaging Caja

12 uds/caja

PVP: 12,99 €

Ø 3/8" Latón

Sistema patentado: 201430093

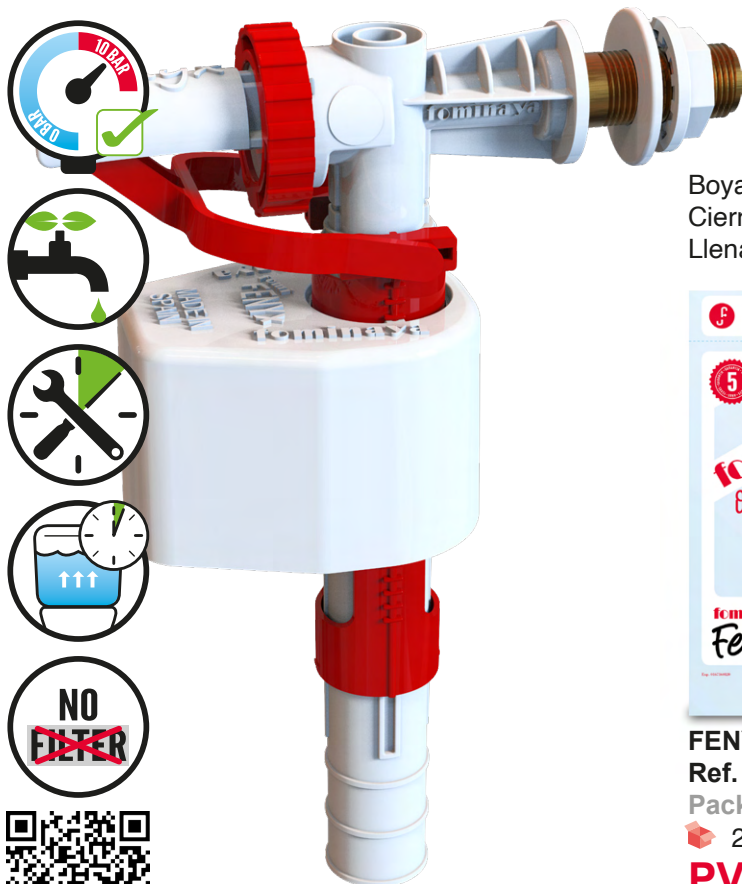

FENYX L

FLOTADOR COMPACTO LATERAL

Boya regulable: **PRODUCTO VERDE**.
Cierre progresivo pistón: especial todo tipo de aguas.
Llenado rápido. Sin mantenimiento. Compacto.



Installation Video



FENYX L38LB
Ref. 0144180120
Packaging Bolsa

25 uds/caja

PVP: 6,46 €

Ø 3/8" Latón

Sistema patentado: 201430093



FENYX L38L
Ref. 0144160120
Packaging Caja

16 uds/caja

PVP: 9,01 €

Ø 3/8" Latón

Sistema patentado: 201430093

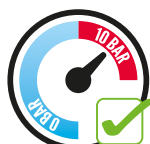

Installation Video

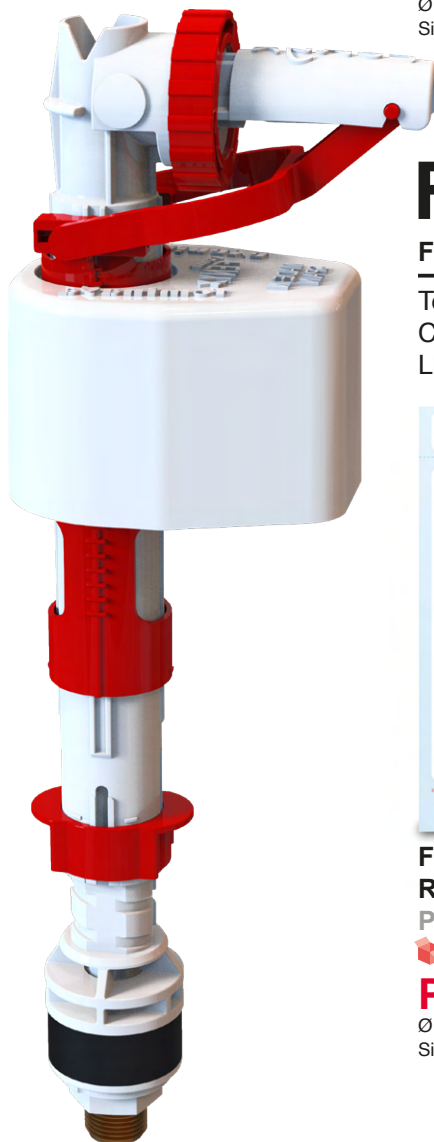

FENYX V

FLOTADOR COMPACTO INFERIOR

Telescópico. Boya regulable: **PRODUCTO VERDE**.
Cierre progresivo pistón: especial todo tipo de aguas.
Llenado rápido. Sin mantenimiento. Compacto.



FENYX V38LB
Ref. 0144380320
Packaging Bolsa

25 uds/caja

PVP: 8,81 €

Ø 3/8" Latón

Sistema patentado: 201430093



FENYX V38L
Ref. 0144360320
Packaging Caja

16 uds/caja

PVP: 11,46 €

Ø 3/8" Latón

Sistema patentado: 201430093



Installation Video



Installation Video



NEMO

FLOTADOR COMPACTO LATERAL

Boya regulable: **PRODUCTO VERDE**.
Muy silencioso. Cierre estanco. Cierre instantáneo.
Sistema antirretorno. Compacto.



NEMO 38L
Ref. 0144191110
Packaging Caja
16 uds/caja
PVP: 10,61 €
Ø 3/8" Latón
Filtro de mantenimiento



TYTAN

FLOTADOR COMPACTO INFERIOR

Telescópico. Boya regulable: **PRODUCTO VERDE**.
Muy silencioso. Cierre estanco. Cierre instantáneo.
Sistema antirretorno. Compacto.



TYTAN 38L
Ref. 0144391310
Packaging Caja
16 uds/caja
PVP: 12,25 €
Ø 3/8" Latón
Filtro de mantenimiento



Installation Video



GL 1

GRIFO FLOTADOR LATERAL

Boya regulable: **PRODUCTO VERDE**.
Cierre estanco. Cierre progresivo. Sistema antirretorno.
Resistente a las aguas más duras.



GL 1
Ref. 0144100110
Packaging Bolsa

50 uds/caja

PVP: 5,38 €

Ø 3/8" Latón
Boya poliestireno expandido

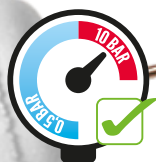

Installation Video



GT 1

GRIFO FLOTADOR INFERIOR

Telescópico. Boya regulable: **PRODUCTO VERDE**.
Cierre estanco. Cierre progresivo. Sistema antirretorno.
Resistente a las aguas más duras.



GT 1
Ref. 0144300310
Packaging Bolsa

20 uds/caja

PVP: 7,86 €

Ø 3/8" Latón
Boya poliestireno expandido



TYFON+

DESCARGADOR UNIVERSAL INTERRUPTIBLE

Descarga interrumpible: **PRODUCTO VERDE**.
 NOVEDAD: SISTEMA REGULACIÓN & TRANSPORTE.
 Compatible bases Negra y Fominaya®.

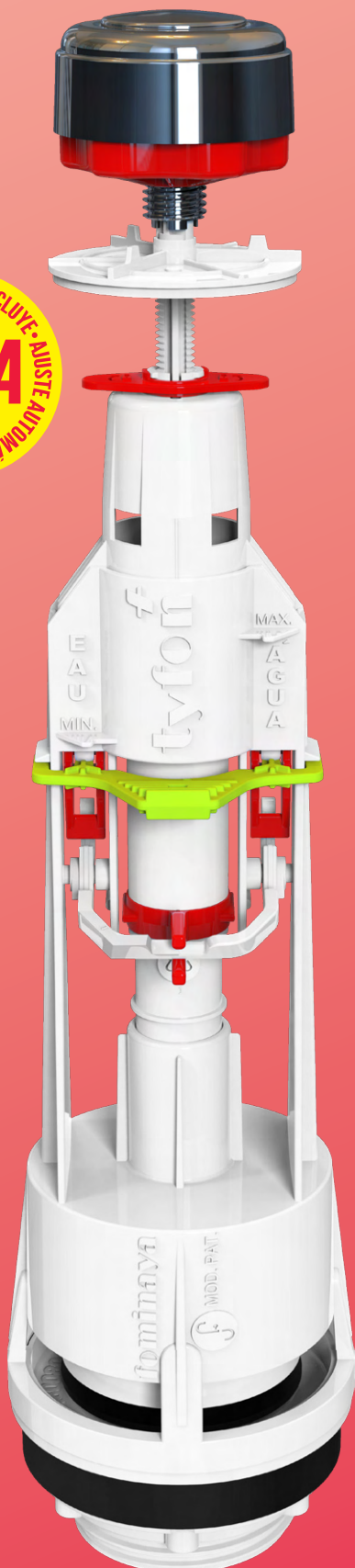

TYFON+ 3 GL 1
 Ref. 0129101231
 Packaging Bolsa
 20 uds/caja
PVP: 18,57 €
 Mecanismo completo Tyfon+ 5 +
 Grifo Lateral + Tornillos + Embellecedor



TYFON+ 1 GT 1
 Ref. 0129101131
 Packaging Bolsa
 20 uds/caja
PVP: 20,49 €
 Mecanismo completo Tyfon+ 5 +
 Grifo Inferior + Tornillos



TYFON+ 14 FENYXL
 Ref. 0129701231
 Packaging Bolsa
 15 uds/caja
PVP: 20,82 €
 Mecanismo completo Tyfon+ 5 +
 Flotador Lateral + Tornillos + Embellecedor



TYFON+ 15 FENYXV
 Ref. 0129701131
 Packaging Bolsa
 15 uds/caja
PVP: 22,75 €
 Mecanismo completo Tyfon+ 5 +
 Flotador Inferior + Tornillos



TYFON+ 7 NEMO
 Ref. 0129501231
 Packaging Bolsa
 15 uds/caja
PVP: 24,18 €
 Mecanismo completo Tyfon+ 5 +
 Flotador Lateral + Tornillos + Embellecedor



TYFON+ 8 TYTAN
 Ref. 0129501131
 Packaging Bolsa
 15 uds/caja
PVP: 25,60 €
 Mecanismo completo Tyfon+ 5 +
 Flotador Inferior + Tornillos

HIDRONEUMÁTICO

DESCARGADOR CON PULSADOR EMPOTRABLE

Mecanismo accionado por pulsador empotrable.
Para cisternas de 15 litros.
La instalación puede quedar oculta.

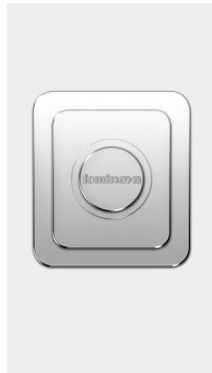

Pulsador PE 5
Ref. 0158001100
Packaging Caja
10 uds/caja
PVP: 11,81 €
Compatible: DC 52/D 5 M



CONJUNTO DC 52
Ref. 0153004101
Packaging Bolsa
10 uds/caja
PVP: 31,98 €
Descargador + Pulsador PE 5 + Juntas +
Tubos conexión + Grifo lateral GL 1

Cisterna no incluida



CISTERNA CQ 3
Ref. 0153002101
Packaging Caja
1 uds/caja
PVP: 42,45 €
Cisterna de 15 litros
Equipamiento: DC 52

GRIFOS CAZOLETA

Boya regulable: **PRODUCTO VERDE**.
Cierre estanco. Cierre instantáneo. Sistema antiretorno.
Resistente a las aguas más duras.



GC 1
Ref. 0151600630
Packaging Granel
25 uds/caja
PVP: 6,63 €
Grifo lateral (Latón) + Tuerca (Plástico)
Ø 3/8" Latón + Longitud: 30 mm

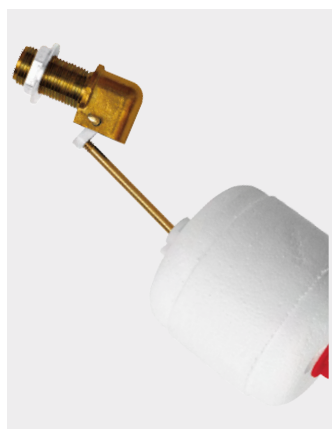

GCB 1
Ref. 0151650630
Packaging Bolsa
25 uds/caja
PVP: 8,02 €
Grifo lateral (Latón) + Tuerca + Boya
Ø 3/8" Latón + Longitud: 30 mm

GRIFOS PISTÓN

Cierre estanco. Cierre instantáneo.
Sistema antiretorno.
Resistente a las aguas más duras.



GP 2
Ref. 0151501530
Packaging Granel
25 uds/caja
PVP: 10,34 €
Grifo lateral (Latón) + Tuerca (Plástico)
Ø 3/8" Latón + Longitud: 32 mm

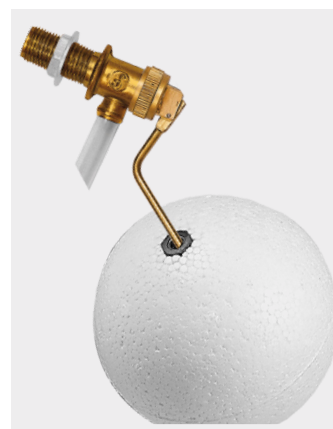

GPB 2
Ref. 0151551530
Packaging Bolsa
25 uds/caja
PVP: 11,52 €
Grifo lateral (Latón) + Tuerca (Plástico) + Boya
Ø 3/8" Latón + Longitud: 32 mm



DESCARGADOR D 5 M
Ref. 0156005020
 Packaging Bolsa
 15 uds/caja
PVP: 16,37 €
 Descargador + Juntas + Grifo GL1



CAMPANA D 25
Ref. 0155003320
 Packaging Bolsa
 25 uds/caja
PVP: 1,92 €
 Compatible: DC 254
 Ø 65 mm



CAMPANA D 025
Ref. 0155003310
 Packaging Bolsa
 25 uds/caja
PVP: 3,46 €
 Compatible: DC 251 / DC 252
 Ø 65 mm



CAMPANA D 026
Ref. 0155004410
 Packaging Bolsa
 25 uds/caja
PVP: 2,22 €
 Compatible: DC 261 / DC 262
 Ø 57 mm

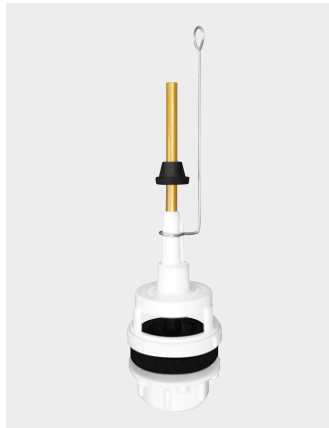

DESCARGADOR DC 251
Ref. 0156003510
 Packaging Bolsa
 25 uds/caja
PVP: 5,24 €
 Ø 12 mm + Longitud: 175 mm (Latón)
 Base: PS/SBR (Plástico)



DESCARGADOR DC 252
Ref. 0156003610
 Packaging Bolsa
 25 uds/caja
PVP: 10,44 €
 Ø 12 mm + Longitud: 175 mm (Latón)
 Base: Zamak-5 (Metal)



DESCARGADOR DC 254
Ref. 0156003720
 Packaging Bolsa
 25 uds/caja
PVP: 3,67 €
 Ø 12 mm + Longitud: 175 mm (Plástico)
 Base: PS/SBR (Plástico)

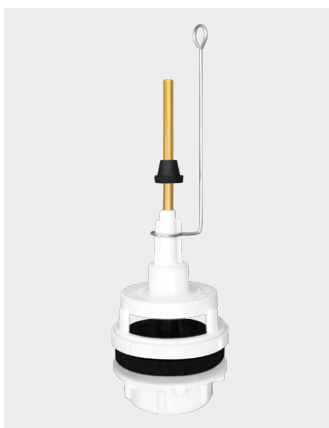

DESCARGADOR DC 261
Ref. 0156004810
 Packaging Bolsa
 25 uds/caja
PVP: 3,94 €
 Ø 5 mm + Longitud: 165 mm (Latón)
 Base: PS/SBR (Plástico)



DESCARGADOR DC 262
Ref. 0156004910
 Packaging Bolsa
 25 uds/caja
PVP: 9,29 €
 Ø 5 mm + Longitud: 165 mm (Latón)
 Base: Zamak-5 (Metal)

BOLSAS EQUIPADAS CISTERNA ALTA

Contiene: Descargador + Juntas + Cadenilla/Tirador + Grifo 3/8" Latón con Varilla y Boya
+ Palanca + Tornillos + Tacos + Escarpías



CISTERNA EQUIPADA CQ 2
Ref. 0153002608

Packaging Bolsa

8 uds/caja

PVP: 31,14 €

Capacidad: 15 litros Equipamiento: BL 254



BOLSA EQUIP. BL 252
Ref. 0153004607

Packaging Bolsa

20 uds/caja

PVP: 22,99 €

Grifo: GC 1

Descargador: DC 252



BOLSA EQUIP. BL 263
Ref. 0153014110

Packaging Bolsa

20 uds/caja

PVP: 18,83 €

Grifo: GL 1

Descargador: DC 262



BOLSA EQUIP. BL 254
Ref. 0153004608

Packaging Bolsa

20 uds/caja

PVP: 16,22 €

Grifo: GC 1

Descargador: DC 254



BOLSA EQUIP. BL 261
Ref. 0153004609

Packaging Bolsa

20 uds/caja

PVP: 16,34 €

Grifo: GC 1

Descargador: DC 261



BOLSA EQUIP. BL 262
Ref. 0153004610

Packaging Bolsa

20 uds/caja

PVP: 21,69 €

Grifo: GC 1

Descargador: DC 262



Manguito MX DÚO
 Ref. 0138543020
 Packaging Bolsa
 15 uds/caja
PVP: 5,60 €
 Excéntrico Ø 90 / 110 mm



Manguito M 9
 Ref. 0138043010
 Granel
 36 uds/caja
PVP: 4,78 €
 Recto Ø 90 mm



Manguito M 11
 Ref. 0138043020
 Granel
 36 uds/caja
PVP: 4,95 €
 Recto Ø 110 mm



Manguito MX 9
 Ref. 0138043030
 Granel
 36 uds/caja
PVP: 4,78 €
 Excéntrico Ø 90 mm



Cisterna C 2
 Ref. 0153002011
 Packaging Bolsa
 8 uds/caja
PVP: 15,60 €
 Capacidad: 15 litros



Bajante BI 1
 Ref. 0154067010
 Packaging Caja
 10 uds/caja
PVP: 7,69 €
 Altura: 175 mm Ø 32 mm



Manguito MX 11
 Ref. 0138043040
 Granel
 36 uds/caja
PVP: 4,95 €
 Excéntrico Ø 110 mm



Junta CM 1
 Ref. 0138048070
 Granel
 36 uds/caja
PVP: 1,65 €
 Ø 90 / 110 mm



Junta CM 2
 Ref. 0138048090
 Granel
 36 uds/caja
PVP: 1,82 €
 Standard

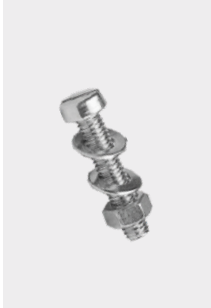

Tornillos TP 1
 Ref. 0154564010
 Granel
 100 uds/caja
PVP: 0,35 €
 Hierro Galvanizado



Kit Tornillos TP 2
 Ref. 0154564030
 Packaging Bolsa
 50 uds/caja
PVP: 1,23 €
 Tornillos + Tacos + Escarpías



Racor latón R1
 Ref. 0154006010
 Granel
 25 uds/caja
PVP: 1,26 €
 Ø 32 mm

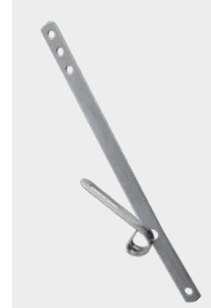

Palanca PA 27
 Ref. 0154007020
 Granel
 25 uds/caja
PVP: 1,23 €
 Longitud: 275 mm



Palanca PA 30
 Ref. 0154007030
 Granel
 25 uds/caja
PVP: 1,14 €
 Longitud: 300 mm



Tapa WC TA 1
 Ref. 0153600010
 Packaging Bolsa
 12 uds/caja
PVP: 13,46 €
 Polipropileno (Incluye tornillos)



Tapa WC TA 2
 Ref. 0153600020
 Packaging Caja
 10 uds/caja
PVP: 31,43 €
 ABS (Incluye tornillos)



Cadenilla CA 1
 Ref. 0154005010
 Packaging Bolsa
 25 uds/caja
PVP: 3,12 €
 Hierro Galvanizado



Enchufe EG 3
 Ref. 0154043010
 Granel
 25 uds/caja
PVP: 1,32 €
 Compatible: Peninsular



Enchufe EG 1
 Ref. 0154043020
 Granel
 25 uds/caja
PVP: 1,48 €
 Compatible: Lucerna



Enchufe EG 2
 Ref. 0154043030
 Granel
 25 uds/caja
PVP: 1,54 €
 Compatible: Victoria

CISTERNA BAJA RECAMBIOS



Campana CF 2
 Ref. 0146007200
 Packaging Bolsa
 25 uds/caja
PVP: 4,08 €
 Standard



Descargador DF 2
 Ref. 0147003200
 Packaging Bolsa
 50 uds/caja
PVP: 5,35 €
 Ganchillo: 195 mm



Descargador DF 3
 Ref. 0147008200
 Packaging Bolsa
 50 uds/caja
PVP: 5,35 €
 Ganchillo: 175 mm



Campana CE 4
 Ref. 0146104300
 Packaging Bolsa
 20 uds/caja
PVP: 6,29 €
 Campana invertida standard



CF 1
 Ref. 0146105400
 Packaging Bolsa
 25 uds/caja
PVP: 10,11 €
 Especial Victoria



Boya BY 7
 Ref. 0144701740
 Granel
 25 uds/caja
PVP: 0,93 €
 Poliestireno expandido



Acople AD 1
 Ref. 0138529010
 Granel
 25 uds/caja
PVP: 1,54 €
 Adaptador Roca-Gala*



Acople AD 2
 Ref. 0138529020
 Granel
 25 uds/caja
PVP: 1,54 €
 Adaptador Roca-Gala*



Acople AD 3
 Ref. 0138529030
 Granel
 25 uds/caja
PVP: 1,54 €
 Adaptador Roca-Gala*



Base BT 1
 Ref. 0138508010
 Granel
 25 uds/caja
PVP: 1,04 €
 Base + Tuerca Fominaya®



Base BT 2
 Ref. 0138508020
 Granel
 25 uds/caja
PVP: 1,04 €
 Base + Tuerca Fominaya®



Base BT 3
 Ref. 0138508030
 Granel
 25 uds/caja
PVP: 1,54 €
 Base + Tuerca Tyfon 3G + Dracko (anterior 2022)



Pulsador PTY 1
 Ref. 0142303110
 Packaging Bolsa
 25 uds/caja
PVP: 3,47 €
 Pulsador Tyfon + Cyclon



Pulsador P 1
 Ref. 0142203110
 Packaging Bolsa
 25 uds/caja
PVP: 6,53 €
 Pulsador Eco Cyclon

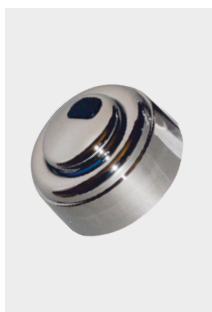

Pulsador PDK 1
 Ref. 0142204110
 Packaging Bolsa
 25 uds/caja
PVP: 6,53 €
 Pulsador Dracko



Pulsador PTY 2
 Ref. 0142304110
 Packaging Bolsa
 10 uds/caja
PVP: 5,47 €
 Cisternas Ø > 48 mm



Pulsador P 2
 Ref. 0142205110
 Packaging Bolsa
 10 uds/caja
PVP: 8,53 €
 Cisternas Ø > 48 mm



Pulsador PDK 2
 Ref. 0142206110
 Packaging Bolsa
 10 uds/caja
PVP: 8,53 €
 Cisternas Ø > 48 mm



Manivela PC 2
 Ref. 0142015130
 Packaging Bolsa
 10 uds/caja
PVP: 16,12 €
 Especial Roca / 280 mm



Manivela PM 2
 Ref. 0142019130
 Packaging Bolsa
 10 uds/caja
PVP: 13,93 €
 Concreto / 230 mm



Tirador TV 1 C
 Ref. 0142001110
 Packaging Bolsa
 25 uds/caja
PVP: 2,41 €
 ABS Cromado: 83 mm



Tirador TV 1 A
 Ref. 0142001120
 Packaging Bolsa
 25 uds/caja
PVP: 6,80 €
 Latón Cromado: 83 mm



Tirador TV 5 C
 Ref. 0142005110
 Packaging Bolsa
 25 uds/caja
PVP: 3,05 €
 ABS Cromado: 114 mm



Tirador TV 5 A
 Ref. 0142005120
 Packaging Bolsa
 25 uds/caja
PVP: 7,03 €
 Latón Cromado: 114 mm



Tirador TV 6 C
 Ref. 0142006110
 Packaging Bolsa
 25 uds/caja
PVP: 2,65 €
 ABS Cromado: 88 mm



Tirador TV 6 A
 Ref. 0142006120
 Packaging Bolsa
 25 uds/caja
PVP: 6,62 €
 Latón Cromado: 88 mm



Tirador TV 4 C
 Ref. 0142004110
 Packaging Bolsa
 25 uds/caja
PVP: 2,55 €
 ABS Cromado: 114 mm



Tirador TV 4 A
 Ref. 0142004120
 Packaging Bolsa
 25 uds/caja
PVP: 6,57 €
 Latón Cromado: 114 mm



Embelledor TP C
 Ref. 0138015010
 Granel
 25 uds/caja
PVP: 1,11 €
 Tapón Lateral ABS Cromado

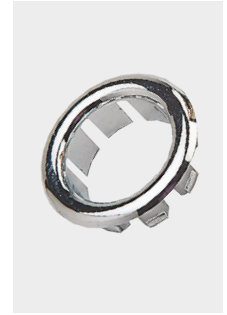

Embelledor EM 1
 Ref. 0138015040
 Granel
 50 uds/caja
PVP: 0,47 €
 Embellecedor Lavabo / Bidé

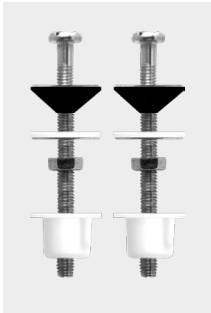

Tornillos TC 1
 Ref. 0140564030
 Packaging Bolsa
 25 uds/caja
PVP: 2,18 €
 Cisterna / WC RM 6 x 80 mm

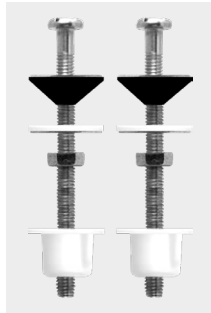

Tornillos TC 2
 Ref. 0140564040
 Packaging Bolsa
 25 uds/caja
PVP: 2,47 €
 Cisterna / WC RM 6 x 120 mm



Tornillos TI 1
 Ref. 0140564050
 Packaging Bolsa
 25 uds/caja
PVP: 1,26 €
 Inodoro / Bidé Vertical



Tornillos TI 2
 Ref. 0140564060
 Packaging Bolsa
 25 uds/caja
PVP: 2,00 €
 Inodoro / Bidé Horizontal



Tornillos TI 5
 Ref. 0140564080
 Packaging Bolsa
 25 uds/caja
PVP: 7,18 €
 Inodoro / Bidé Horizontal



Tornillos TL 1
 Ref. 0138564010
 Packaging Bolsa
 25 uds/caja
PVP: 2,00 €
 Lavabo



Obturadora RF 1
 Ref. 0138003030
 Granel
 100 uds/caja
PVP: 1,00 €
 Ø 68 x 18 mm



Obturadora RF 2
 Ref. 0138003040
 Granel
 100 uds/caja
PVP: 1,05 €
 Ø 68 x 18 mm



Obturadora RB 1
 Ref. 0138003010
 Granel
 100 uds/caja
PVP: 0,53 €
 Ø 56 x 18 mm



Obturadora RB 2
 Ref. 0138003020
 Granel
 100 uds/caja
PVP: 1,33 €
 Ø 73 x 23 mm Especial Roca



Obturadora RB 4
 Ref. 0138003080
 Granel
 100 uds/caja
PVP: 0,82 €
 Ø 65 x 17 mm Fominaya®



Obturadora RB 5
 Ref. 0138003090
 Granel
 100 uds/caja
PVP: 0,59 €
 Ø 62 x 17 mm Fominaya®



Obturadora RB 3
 Ref. 0138003050
 Granel
 100 uds/caja
PVP: 0,65 €
 Ø 68 x 32 mm Victoria Nuevo



Junta JI 1
 Ref. 0138048040
 Granel
 50 uds/caja
PVP: 1,12 €
 Ø 105 x 85 x 10 mm



Junta JI 3
 Ref. 0138048010
 Granel
 50 uds/caja
PVP: 1,76 €
 Ø 100 x 59 mm



Junta JI 5
 Ref. 0138048030
 Granel
 50 uds/caja
PVP: 1,94 €
 Ø 110 x 58 mm



Kit Juntas KJ 1
 Ref. 0138548010
 Granel
 50 uds/caja
PVP: 2,24 €
 Ø 111 / 82 / 56 mm x 20 Espesor



Kit Juntas KJ 2
 Ref. 0138548020
 Granel
 50 uds/caja
PVP: 1,88 €
 Ø 111 / 82 / 56 mm x 15 Espesor

CISTERNA EMPOTRADA RECAMBIOS



Descargador DE 4
 Ref. 0110701010
 Packaging Bolsa
 1 uds/caja
PVP: 18,18 €
 Compatible: Sena + Nilo + Volga



Descargador DE 5
 Ref. 0110702010
 Packaging Bolsa
 1 uds/caja
PVP: 24,24 €
 Compatible: Nilo CE + Volga CE



Descargador DE 6
 Ref. 0110703010
 Packaging Bolsa
 1 uds/caja
PVP: 24,24 €
 Compatible: Alba CE



Grifo GL 8
 Ref. 0110181120
 Packaging Bolsa
 1 uds/caja
PVP: 36,35 €
 Compatible: Alba CE
 Ø3/8" POM



Grifo GL 9
 Ref. 0110182120
 Packaging Bolsa
 1 uds/caja
PVP: 36,35 €
 Compatible: Nilo CE + Volga CE
 Ø3/8" POM



Flexible FLEX1
 Ref. 011067010
 Packaging Bolsa
 1 uds/caja
PVP: 18,18 €
 Compatible: Sena/Nilo/Volga
 (ant. 2015) - H1/2" - H3/8"

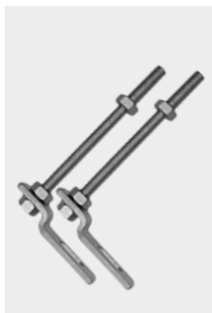

Tornillos TSP 1
 Ref. 0111564029
 Packaging Bolsa
 1 uds/caja
PVP: 17,59 €
 Compatible: Nilo CE

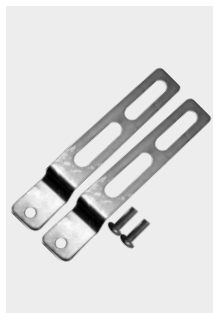

Tornillos TSP 3
 Ref. 0111564059
 Packaging Bolsa
 1 uds/caja
PVP: 16,47 €
 Compatible: Volga CE



Placa PSA
 Ref. 0111076019
 Packaging Bolsa
 1 uds/caja
PVP: 15,76 €
 Compatible: Sena + Nilo + Volga



Soporte SMA 12
 Ref. 0111076029
 Packaging Bolsa
 1 uds/caja
PVP: 12,12 €
 Compatible: Nilo CE



Soporte SMA 8
 Ref. 0111076059
 Packaging Bolsa
 1 uds/caja
PVP: 12,12 €
 Compatible: Alba CE



Protección PTAC
 Ref. 0111073019
 Packaging Bolsa
 1 uds/caja
PVP: 18,18 €
 Compatible: Todos



Codo CDI 1
 Ref. 0111527049
 Packaging Bolsa
 1 uds/caja
PVP: 18,18 €
 Compatible: Sena + Nilo + Volga
 Ø90/110 mm



Codo CDI 2
 Ref. 0111527069
 Packaging Bolsa
 1 uds/caja
PVP: 19,41 €
 Compatible: Sena + Nilo + Volga
 Ø110 mm



Codo CDI 3
 Ref. 0111527089
 Packaging Bolsa
 1 uds/caja
PVP: 19,41 €
 Compatible: Alba CE



Conexión CSA 1
 Ref. 0111527059
 Packaging Bolsa
 1 uds/caja
PVP: 11,22 €
 Compatible: Todos



Conexión CSA 2
 Ref. 0111527079
 Packaging Bolsa
 1 uds/caja
PVP: 7,29 €
 Compatible: Todos



Codo CDB
 Ref. 0111527029
 Packaging Bolsa
 1 uds/caja
PVP: 6,06 €
 Compatible: Bidé + Lavabo Nilo



Tapones TP B
 Ref. 0111063019
 Packaging Bolsa
 1 uds/caja
PVP: 8,47 €
 Compatible: Todos



Llave LLR
 Ref. 0111600019
 Packaging Bolsa
 1 uds/caja
PVP: 18,18 €
 Compatible: Todos



Tornillos TI 3
 Ref. 0111564019
 Packaging Bolsa
 1 uds/caja
PVP: 12,12 €
 Compatible: Nilo + Alba CE

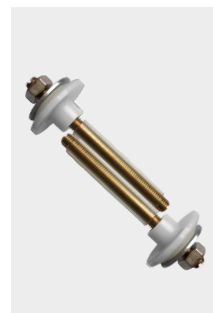

Tornillos TI 4
 Ref. 0111564039
 Packaging Bolsa
 1 uds/caja
PVP: 9,71 €
 Compatible: Lavabo Nilo



Anillo Cierre ACB
 Ref. 0111012010
 Packaging Bolsa
 1 uds/caja
PVP: 1,82 €
 Compatible: Todos



Codo CL 12
 Ref. 0111527019
 Packaging Bolsa
 1 uds/caja
PVP: 24,24 €
 Compatible: Bidé + Lavabo Nilo

fominaya®

Original Since 1939



9L
3-4L

*Doble
Descarga
Regulable*

**MECANISMO UNIVERSAL
DOBLE REGULACIÓN**

Eco
TYFON 5G



**NOVEDAD:
SISTEMA
INSTALACIÓN &
TRANSPORTE**



**AHORRO DE AGUA:
100% REGULABLE**



**5 MINUTOS:
MUY FÁCIL INSTALACIÓN**



**AHORRO DE AGUA:
DESCARGA RÁPIDA**



**COMPATIBLE
TODAS LAS BASES**

100% NACIONAL

catálogo
general
2023 - V1
TARIFA 1

fominaya®
Original *Since 1939*

SISTEMAS INSTALACIONES SANITARIOS 2023 V1



COMPROMISO I+D
MEDIOAMBIENTAL



SOLUCIONES DE
AHORRO DE AGUA



PLÁSTIC
FREE

EMBALAJES
ECOLÓGICOS



RECYCLED
PAPER

PAPEL Y CARTÓN
RECICLADO



Made in Spain



MANAGEMENT SYSTEM CERTIFICATE

Certificate no.:
248742-2017-AQ-IBE-ENAC

Initial certification date:
03 March 2000

Valid:
17 November 2020 – 16 November 2023

This is to certify that the management system of

FOMINAYA, S.A.

Ctra. del Pla, s/n,46117, Bétera, Valencia, Spain

has been found to conform to the Quality Management System standard:

ISO 9001:2015

This certificate is valid for the following scope:

Design, production and commercialization of flushing and filing articles for WC cisterns and concealed systems with double push button and their accessories; design, production and commercialization of accessories for sanitary water installations.

Place and date:
Barcelona, 15 October 2021

For the issuing office:
DNV - Business Assurance
Gran Via de les Corts Catalanes 130-136, Pl. 9,
08038, Barcelona, Spain



Ana del Rio Salgado
Management Representative

Lack of fulfilment of conditions as set out in the Certification Agreement may render this Certificate invalid.
ACCREDITED UNIT: DNV GL Business Assurance España, S.L.U., Gran Via de les Corts Catalanes 130-136, Pl. 9, 08038 Barcelona, Spain - TEL: +34 93 479 26 00.
www.dnv.es/assurance



IMAGEN	MOD.	REF.	EAN	DESCRIPCIÓN	PACK		PVP
	CE-NILO-I	0110220001	8426871108379	Bastidor Sujeción INODORO Mod. NILO CE 12 cm. Certificado CE. Pulsador no incluido Compatibilidad: Inodoro suspendido - Distancia Agujeros 180-230 mm	Caja	1	260,00
	CE-NILO-B	0110400001	8426871074964	Bastidor Sujeción BIDÉ Mod. NILO Compatibilidad: Bidé Suspendido	Caja	1	170,00
	CE-NILO-L	0110300001	8426871074957	Bastidor Sujeción LAVABO Mod. NILO Compatibilidad: Lavabo Suspendido	Caja	1	180,00
	PQC-M	0111100001	8426871074988	Pulsador Mod. QÜADRIGA - Cromo Mate Pulsador Mecánico + Soporte Fijación + Material Instalación Compatibilidad: Mod. Sena/Nilo/Volga (anterior 2015)	Caja	1	38,90
	PQC-B	0111100002	8426871080705	Pulsador Mod. QÜADRIGA - Cromo Brillo Pulsador Mecánico + Soporte Fijación + Material Instalación Compatibilidad: Mod. Sena/Nilo/Volga (anterior 2015)	Caja	1	38,90
	PQC-M-CE	0111110001	8426871108386	Pulsador Mod. QÜADRIGA - Cromo Mate Pulsador Mecánico + Soporte Fijación + Material Instalación Compatibilidad: Mod. Nilo CE/Alba CE/Volga CE/Anna CE	Caja	1	38,90
	PQC-B-CE	0111110002	8426871108393	Pulsador Mod. QÜADRIGA - Cromo Brillo Pulsador Mecánico + Soporte Fijación + Material Instalación Compatibilidad: Mod. Nilo CE/Alba CE/Volga CE/Anna CE	Caja	1	38,90
	PQC-N-CE	0111110003	8426871119368	Pulsador Mod. QÜADRIGA - Cromo Negro Pulsador Mecánico + Soporte Fijación + Material Instalación Compatibilidad: Mod. Nilo CE/Alba CE/Volga CE/Anna CE	Caja	1	43,57
	PCC-M-CE	0111120001	8426871119382	Pulsador Mod. CIRCÛS - Cromo Mate Pulsador Mecánico + Soporte Fijación + Material Instalación Compatibilidad: Mod. Nilo CE/Alba CE/Volga CE/Anna CE	Caja	1	51,00
	PCC-B-CE	0111120002	8426871119375	Pulsador Mod. CIRCÛS - Cromo Brillo Pulsador Mecánico + Soporte Fijación + Material Instalación Consultar existencias Compatibilidad: Mod. Nilo CE/Alba CE/Volga CE/Anna CE	Caja	1	51,00

IMAGEN	MOD.	REF.	EAN	DESCRIPCIÓN	PACK		PVP
	PCC-N-CE	0111120003	8426871119399	Pulsador Mod. CIRCÜS - Cromo Negro Pulsador Mecánico + Soporte Fijación + Material Instalación Compatibilidad: Mod. Nilo CE/Alba CE/Volga CE/Anna CE	Caja	1	51,00
	PCO-M-CE	0111130001	8426871119412	Pulsador Mod. COLISEÜM - Cromo Mate Pulsador Mecánico + Soporte Fijación + Material Instalación Compatibilidad: Mod. Nilo CE/Alba CE/Volga CE/Anna CE	Caja	1	43,57
	PCO-B-CE	0111130002	8426871119405	Pulsador Mod. COLISEÜM - Cromo Brillo Pulsador Mecánico + Soporte Fijación + Material Instalación Consultar existencias Compatibilidad: Mod. Nilo CE/Alba CE/Volga CE/Anna CE	Caja	1	39,90
	PCO-N-CE	0111130003	8426871119429	Pulsador Mod. COLISEÜM - Cromo Negro Pulsador Mecánico + Soporte Fijación + Material Instalación Compatibilidad: Mod. Nilo CE/Alba CE/Volga CE/Anna CE	Caja	1	39,90
	PVA-M-CE	0111140001	8426871119443	Pulsador Mod. VANDALÜS - Inoxidable Mate Pulsador Mecánico + Soporte Fijación + Material Instalación Compatibilidad: Mod. Nilo CE/Alba CE/Volga CE/Anna CE	Caja	1	79,90
	PVA-B-CE	0111140002	8426871119436	Pulsador Mod. VANDALÜS - Inoxidable Brillo Pulsador Mecánico + Soporte Fijación + Material Instalación Consultar existencias Compatibilidad: Mod. Nilo CE/Alba CE/Volga CE/Anna CE	Caja	1	101,90
	PSP-M-CE	0111150001	8426871119467	Pulsador Mod. SPARTACÜS - Cromo Mate Pulsador Mecánico + Soporte Fijación + Material Instalación Compatibilidad: Mod. Nilo CE/Alba CE/Volga CE/Anna CE	Caja	1	28,90
	PSP-B-CE	0111150002	8426871119450	Pulsador Mod. SPARTACÜS - Cromo Brillo Pulsador Mecánico + Soporte Fijación + Material Instalación Consultar existencias Compatibilidad: Mod. Nilo CE/Alba CE/Volga CE/Anna CE	Caja	1	28,90
	PDM-CB-CE	0111160002	8426871119504	Pulsador Mod. DOMÜS - Cromo Brillo Pulsador Mecánico + Soporte Fijación + Material Instalación Consultar existencias Compatibilidad: Mod. Nilo CE/Alba CE/Volga CE/Anna CE	Caja	1	29,62
	PDM-BL-CE	0111160004	8426871119498	Pulsador Mod. DOMÜS - PVC Blanco Pulsador Mecánico + Soporte Fijación + Material Instalación Compatibilidad: Mod. Nilo CE/Alba CE/Volga CE/Anna CE	Caja	1	25,45







IMAGEN	MOD.	REF.	EAN	DESCRIPCIÓN	PACK		PVP
	DE4	0110701010	8426871092067	Conjunto Descargador + Accionamiento Compatibilidad: Mod. Sena/Nilo/Volga (anterior 2015)	Bolsa	1	18,18
	DE5	0110702010	8426871108362	Conjunto Descargador Compatibilidad: Mod. Nilo CE/Volga CE	Bolsa	1	24,24
	DE6	0110703010	8426871140515	Conjunto Descargador + Sujeción Compatibilidad: Mod. Alba CE	Bolsa	1	24,24
	GL8	0110181120	8426871108355	Grifo Silencioso Lateral 3/8" + Acople + Flexible conexión Compatibilidad: Mod. Alba CE	Bolsa	1	36,35
	GL9	0110182120	8426871140522	Grifo Silencioso Lateral 3/8" + Acople + Flexible conexión Compatibilidad: Mod. Nilo CE/Volga CE	Bolsa	1	36,35
	TPB	0111063019	8426871096195	Kit Tapones Protección Compatibilidad: Todos los Modelos	Bolsa	1	8,47
	FLEX1	0111067010	8426871096270	Conexión Flexible H 1/2" - H 3/8" Compatibilidad: Mod. Sena/Nilo/Volga (anterior 2015)	Bolsa	1	18,18
	PTAC	0111073019	8426871096232	Kit Caja Protección Accionamiento Compatibilidad: Todos los Modelos	Bolsa	1	18,18
	PSA	0111076019	8426871096249	Kit Placa Soporte Accionamiento Compatibilidad: Mod. Sena/Nilo/Volga (anterior 2015)	Bolsa	1	15,76

IMAGEN	MOD.	REF.	EAN	DESCRIPCIÓN	PACK		PVP
	SPG	0111080019	8426871096287	Kit Soporte Sujeción Grifo Compatibilidad: Mod. Nilo/Volga (anterior 2015)	Bolsa	1	8,47
	P-CE	0111076039	8426871108416	Placa Cierre Frontal Compatibilidad: Mod. Nilo CE/Alba CE	Bolsa	1	7,29
	SMA12	0111076029	8426871108409	Soporte y Mecanismo Accionamiento Compatibilidad: Mod. Nilo CE	Bolsa	1	12,12
	SMA8	0111076059	8426871118637	Soporte y Mecanismo Accionamiento Compatibilidad: Mod. Alba CE	Bolsa	1	12,12
	CBA1	0111527109	8426871143554	Codo bajante salida agua cisterna a inodoro bastidor Mod. Alba CE Compatibilidad: Mod. Alba CE	Bolsa	1	21,82
	CDI1	0111527049	8426871096201	Kit Codo Desagüe Inodoro - Dia. 90 y 110 mm - Polietileno Compatibilidad: Mod. Sena/Nilo/Volga	Bolsa	1	18,18
	CDI2	0111527069	8426871100953	Codo Desagüe Inodoro - Dia. 110 mm - PVC Compatibilidad: Mod. Sena/Nilo/Volga	Bolsa	1	19,41
	CDI3	0111527089	8426871121446	Codo Desagüe Inodoro - Dia. 90 mm - PVC Compatibilidad: Mod. Alba CE	Bolsa	1	19,41
	CSA1	0111527059	8426871096218	Kit Tubo Conexión Salida Agua Cisterna Dia. 40 mm Compatibilidad: Todos los Modelos	Bolsa	1	11,22
	CSA2	0111527079	8426871117326	Manguito Conexión Salida Agua Inodoro Dia. 90 mm Compatibilidad: Todos los Modelos	Bolsa	1	7,29







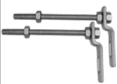

IMAGEN	MOD.	REF.	EAN	DESCRIPCIÓN	PACK		PVP
	CSAK	0111527099	8426871138109	Kit 2 Manguitos Conex.Salida y entrada Agua Inodoro Ø 90/40 mm Compatibilidad: Todos los Modelos	Bolsa	1	14,53
	TSP1	0111564029	8426871096188	Kit Juego 2 Tornillos Sujeción Pared Compatibilidad: Inodoro Mod. Nilo	Bolsa	1	17,59
	TSP3	0111564059	8426871118651	Kit Juego 2 Placas Sujeción Pared Mod. VOLGA Compatibilidad: Inodoro Mod. Volga	Bolsa	1	16,47
	LLR	0111600019	8426871096225	Kit Llave Escuadra de Regulación M-M 1/2" x 3/8" Compatibilidad: Todos los Modelos	Bolsa	1	18,18
	TI3	0111564019	8426871092036	Kit 2 Tornillos Sujeción Inodoro / Bidet Compatibilidad: Mod. Alba CE/Inodoro/Bidet Mod. Nilo	Bolsa	1	12,12
	TI4	0111564039	8426871100502	Kit 2 Tornillos Sujeción Lavabo Compatibilidad: Todos los Modelos	Bolsa	1	9,71
	ACB	0111012010	8426871092043	Anillo Cierre Tubo Conexión Salida Agua Compatibilidad: Todos los Modelos	Bolsa	1	2,04
	CL12	0111527019	8426871091985	Kit Codo Latón Conexión Toma Agua 1/2" Compatibilidad: Bidet/Lavabo Mod. Nilo	Bolsa	1	24,24
	CDB	0111527029	8426871091992	Kit Codo Polietileno Salida Agua Dia. 32 mm Compatibilidad: Bidet/Lavabo Mod. Nilo	Bolsa	1	6,06
	KASC1	0111080029	8426871143578	Kit Abrazadera sujeción codo salida agua Mod. Nilo CE Compatibilidad: Mod. Nilo CE	Bolsa	1	18,18

IMAGEN	MOD.	REF.	EAN	DESCRIPCIÓN	PACK		PVP
	TYF4-3G	0129305011	8426871108195	Descargador Universal con Pulsador Interrumpible "Fomi TYFON 3G 4" Campana + Acople Roca* - UNIVERSAL 100% Compatibilidad: Bases Blanca, Gris y Negra Roca* + Bases Fominaya	Bolsa	25	11,32
	TYF10-3G	0129307011	8426871108218	Descargador Universal con Pulsador Interrumpible "Fomi TYFON 3G 10" Mecanismo Completo (Descargador + Base + Juntas) + Acople Roca* - UNIVERSAL 100% [Packaging Bolsa] Compatibilidad: Bases Blanca, Gris y Negra Roca* + Bases Fominaya + Nueva Instalación	Bolsa	25	14,01
	TYF12-3G	0129317031	8426871121262	Descargador Universal con Pulsador Interrumpible "Fomi TYFON 3G 12" Mecanismo Completo (Descargador + Base + Juntas + Tornillos) + Acople Roca* - UNIVERSAL 100% [Packaging Caja] Compatibilidad: Bases Blanca, Gris y Negra Roca* + Bases Fominaya + Nueva Instalación	Caja	20	14,73
	TYF1-3G	0129305111	8426871108188	Conjunto Descargador con Pulsador Interrumpible "Fomi TYFON 3G 1" + Grifo Inferior GT Mecanismo Completo + Grifo Vertical Telescópico Varilla/Boya 3/8" Latón Compatibilidad: Bases Blanca y Gris Roca* + Nueva Instalación	Bolsa	20	21,59
	TYF3-3G	0129310211	8426871108171	Conjunto Descargador con Pulsador Interrumpible "Fomi TYFON 3G 3" + Grifo Lateral GL Mecanismo Completo + Grifo Lateral Varilla/Boya 3/8" Latón Compatibilidad: Bases Blanca y Gris Roca* + Nueva Instalación	Bolsa	20	19,84
	TYF7-3G	0129502231	8426871108249	Conjunto Descargador con Pulsador Interrumpible "Fomi TYFON 3G 7" + Grifo Lateral Fomi NEMO Mecanismo Completo + Grifo Lateral Servo Fomi NEMO 3/8" Latón Compatibilidad: Bases Blanca y Gris Roca* + Nueva Instalación	Bolsa	15	25,27
	TYF8-3G	0129502131	8426871108232	Conjunto Descargador con Pulsador Interrumpible "Fomi TYFON 3G 8" + Grifo Inferior Fomi TYTAN Mecanismo Completo + Grifo Vertical Telescópico Servo Fomi TYTAN 3/8" Latón Compatibilidad: Bases Blanca y Gris Roca* + Nueva Instalación	Bolsa	15	26,59
	TYF14-3G	0129552231	8426871108256	Conjunto Descargador con Pulsador Interrumpible "Fomi TYFON 3G 14" + Grifo Lateral Fomi FENYX Mecanismo Completo + Grifo Lateral Antical Fomi FENYX 3/8" Latón Compatibilidad: Bases Blanca y Gris Roca* + Nueva Instalación	Bolsa	15	22,09

IMAGEN	MOD.	REF.	EAN	DESCRIPCIÓN	PACK		PVP
	TYF4	0129102031	8426871004473	Descargador Universal con Pulsador Interrumpible "Fomi TYFON+ 4" Campana + Acople Roca* Compatibilidad: Base Negra Roca* + Bases Fominaya	Bolsa	25	10,22
	TYF5	0129101031	8426871004329	Descargador Universal con Pulsador Interrumpible "Fomi TYFON+ 5" Mecanismo Completo (Descargador + Base + Juntas) Compatibilidad: Universal: Todas las cisternas de tanque bajo y accionamiento superior	Bolsa	25	11,32
	TYF10	0129106031	8426871028943	Descargador Universal con Pulsador Interrumpible "Fomi TYFON+ 10" Mecanismo Completo (Descargador + Base + Juntas) + Acople Roca* [Packaging Bolsa] Compatibilidad: Base Negra Roca* + Bases Fominaya + Nueva Instalación	Bolsa	25	12,91
	TYF12	0129317011	8426871500050	Descargador Universal con Pulsador Interrumpible "Fomi TYFON+ 12" Mecanismo Completo (Descargador + Base + Juntas) [Packaging Caja] Compatibilidad: Universal: Todas las cisternas de tanque bajo y accionamiento superior	Caja	20	12,20
	TYF1	0129101131	8426871004350	Conjunto Descargador "Fomi TYFON+ 1" + Grifo Inferior GT Mecanismo Completo + Grifo Vertical Telescópico Varilla/Boya 3/8" Latón Compatibilidad: Universal: Todas las cisternas de tanque bajo y accionamiento superior	Bolsa	20	20,49
	TYF3	0129101231	8426871004398	Conjunto Descargador "Fomi TYFON+ 3" + Grifo Lateral GL Mecanismo Completo + Grifo Lateral Varilla/Boya 3/8" Latón Compatibilidad: Universal: Todas las cisternas de tanque bajo y accionamiento superior	Bolsa	20	18,57
	TYF7	0129501231	8426871027014	Conjunto Descargador "Fomi TYFON+ 7" + Grifo Lateral Fomi NEMO Mecanismo Completo + Grifo Lateral Servo Fomi NEMO 3/8" Latón Compatibilidad: Universal: Todas las cisternas de tanque bajo y accionamiento superior	Bolsa	15	24,18
	TYF8	0129501131	8426871027021	Conjunto Descargador "Fomi TYFON+ 8" + Grifo Inferior Fomi TYTAN Mecanismo Completo + Grifo Vertical Telescópico Servo Fomi TYTAN 3/8" Latón Compatibilidad: Universal: Todas las cisternas de tanque bajo y accionamiento superior	Bolsa	15	25,60
	TYF14	0129701231	8426871105118	Conjunto Descargador "Fomi TYFON+ 14" + Grifo Lateral Fomi FENYX Mecanismo Completo + Grifo Lateral Antical Fomi FENYX 3/8" Latón Compatibilidad: Universal: Todas las cisternas de tanque bajo y accionamiento superior	Bolsa	15	20,82
	TYF15	0129701131	8426871105071	Conjunto Descargador "Fomi TYFON+ 15" + Grifo Inferior Fomi FENYX Mecanismo Completo + Grifo Vertical Telescópico Antical Fomi FENYX 3/8" Latón Compatibilidad: Universal: Todas las cisternas de tanque bajo y accionamiento superior	Bolsa	15	22,75











IMAGEN	MOD.	REF.	EAN	DESCRIPCIÓN	PACK		PVP
	CLON4	0129202031	8426871031332	Descargador Universal con Pulsador "Fomi CYCLON 4" Campana + Acople Roca* Compatibilidad: Base Negra Roca* + Bases Fominaya	Bolsa	25	10,71
	CLON5	0129201031	8426871031349	Descargador Universal con Pulsador "Fomi CYCLON 5" Mecanismo Completo (Descargador + Base + Juntas) Compatibilidad: Universal: Todas las cisternas de tanque bajo y accionamiento superior	Bolsa	25	11,76
	CLON10	0129206031	8426871031400	Descargador Universal con Pulsador "Fomi CYCLON 10" Mecanismo Completo (Descargador + Base + Juntas) + Acople Roca* [Packaging Bolsa] Compatibilidad: Base Negra Roca* + Bases Fominaya + Nueva Instalación	Bolsa	25	13,35
	CLON12	0129206011	8426871500043	Descargador Universal con Pulsador "Fomi CYCLON 12" Mecanismo Completo (Descargador + Base + Juntas + Tornillos) + Acople Roca* [Packaging Caja] Compatibilidad: Base Negra Roca* + Bases Fominaya + Nueva Instalación	Caja	20	14,23
	CLON1	0129201131	8426871031301	Conjunto Descargador "Fomi CYCLON 1" + Grifo Inferior GT Mecanismo Completo + Grifo Vertical Telescópico Varilla/Boya 3/8" Latón Compatibilidad: Universal: Todas las cisternas de tanque bajo y accionamiento superior	Bolsa	20	20,93
	CLON3	0129201231	8426871031325	Conjunto Descargador "Fomi CYCLON 3" + Grifo Lateral GL Mecanismo Completo + Grifo Lateral Varilla/Boya 3/8" Latón Compatibilidad: Universal: Todas las cisternas de tanque bajo y accionamiento superior	Bolsa	20	19,01
	CLON7	0129601231	8426871031363	Conjunto Descargador "Fomi CYCLON 7" + Grifo Lateral Fomi NEMO Mecanismo Completo + Grifo Lateral Servo Fomi NEMO 3/8" Latón Compatibilidad: Universal: Todas las cisternas de tanque bajo y accionamiento superior	Bolsa	15	24,62
	CLON8	0129601131	8426871031370	Conjunto Descargador "Fomi CYCLON 8" + Grifo Inferior Fomi TYTAN Mecanismo Completo + Grifo Vertical Telescópico Servo Fomi TYTAN 3/8" Latón Compatibilidad: Universal: Todas las cisternas de tanque bajo y accionamiento superior	Bolsa	15	26,10
	CLON14	0129751231	8426871107808	Conjunto Descargador "Fomi CYCLON 14" + Grifo Lateral Fomi FENYX Mecanismo Completo + Grifo Lateral Antical Fomi FENYX 3/8" Latón Compatibilidad: Universal: Todas las cisternas de tanque bajo y accionamiento superior	Bolsa	15	21,26











IMAGEN	MOD.	REF.	EAN	DESCRIPCIÓN	PACK		PVP
	TYF4-5G	0139305011	8426871500135	Descargador Universal con Doble Pulsador Regulable "Fomi TYFON 5G 4" Campana + Acople Roca* - UNIVERSAL 100% Compatibilidad: Bases Blanca, Gris y Negra Roca* + Bases Fominaya	Bolsa	25	12,64
	TYF10-5G	0139327031	8426871500128	Descargador Universal con Doble Pulsador Regulable "Fomi TYFON 5G 10" Mecanismo Completo (Descargador + Base + Juntas) + Acople Roca* - UNIVERSAL 100% [Packaging Bolsa] Compatibilidad: Bases Blanca, Gris y Negra Roca* + Bases Fominaya + Nueva Instalación	Bolsa	25	15,71
	TYF12-5G	0139328011 0139327011	8426871501439 8426871500074	Descargador Universal con Doble Pulsador Regulable "Fomi TYFON 5G 12" Mecanismo Completo (Descargador + Base + Juntas + Tornillos) + Acople Roca* - UNIVERSAL 100% [Packaging Bolsa-Caja] Compatibilidad: Bases Blanca, Gris y Negra Roca* + Bases Fominaya + Nueva Instalación	Bolsa Caja	25 20	16,17 16,93
	DRK10	0139301011	NOVEDAD 2023 8426871105019	Descargador Universal Doble Pulsador con Cable "Fomi DRACKO 10" Mecanismo Completo (Descargador + Base + Juntas) + Acople Roca* [Packaging Bolsa] Compatibilidad: Bases Roca* + Bases Fominaya + Nueva Instalación	Bolsa	20	24,99
	DRK12	0139309011 0139307011	NOVEDAD 2023 8426871501460 8426871081665	Descargador Universal Doble Pulsador con Cable "Fomi DRACKO 12" Mecanismo Completo (Descargador + Base + Juntas + Tornillos) + Acople Roca* [Packaging Bolsa-Caja] Compatibilidad: Bases Roca* + Bases Fominaya + Nueva Instalación	Bolsa Caja	20 20	26,11 26,64
	DRK1	0139310211	NOVEDAD 2023 8426871081672	Conjunto Descargador "Fomi DRACKO 1" + Grifo Lateral GL Mecanismo Completo + Grifo Lateral Varilla/Boya 3/8" Latón Compatibilidad: Universal: Todas las cisternas de tanque bajo y accionamiento superior	Bolsa	20	22,31
	DRK2	0139305111	NOVEDAD 2023 8426871081658	Conjunto Descargador "Fomi DRACKO 2" + Grifo Inferior GT Mecanismo Completo + Grifo Vertical Telescópico Varilla/Boya 3/8" Latón Compatibilidad: Universal: Todas las cisternas de tanque bajo y accionamiento superior	Bolsa	15	24,12
	DRK7	0139701211	NOVEDAD 2023 8426871081696	Conjunto Descargador "Fomi DRACKO 7" + Grifo Lateral Fomi NEMO Mecanismo Completo + Grifo Lateral Servo Fomi NEMO 3/8" Latón Compatibilidad: Universal: Todas las cisternas de tanque bajo y accionamiento superior	Bolsa	15	26,92
	DRK8	0139701111	NOVEDAD 2023 8426871081689	Conjunto Descargador "Fomi DRACKO 8" + Grifo Inferior Fomi TYTAN Mecanismo Completo + Grifo Vertical Telescópico Servo Fomi TYTAN 3/8" Latón Compatibilidad: Universal: Todas las cisternas de tanque bajo y accionamiento superior	Bolsa	15	27,86
	DRK13	0139751211	NOVEDAD 2023 8426871107372	Conjunto Descargador "Fomi DRACKO 13" + Grifo Lateral Fomi FENYX Mecanismo Completo + Grifo Lateral Antical Fomi FENYX 3/8" Latón Compatibilidad: Universal: Todas las cisternas de tanque bajo y accionamiento superior	Bolsa	15	24,12
	DRK14	0139751111	NOVEDAD 2023 8426871107365	Conjunto Descargador "Fomi DRACKO 14" + Grifo Inferior Fomi FENYX Mecanismo Completo + Grifo Vertical Telescópico Antical Fomi FENYX 3/8" Latón Compatibilidad: Universal: Todas las cisternas de tanque bajo y accionamiento superior	Bolsa	15	25,99











IMAGEN	MOD.	REF.	EAN	DESCRIPCIÓN	PACK		PVP
	ECY4	0139205011	8426871033442	Descargador Universal Doble Pulsador "Fomi EcoCYCLON 4" Campana + Acople Roca* Compatibilidad: Base Negra Roca* + Bases Fominaya	Bolsa	25	19,62
	ECY6	0139206011	8426871033466	Descargador Universal Doble Pulsador "Fomi EcoCYCLON 6" Mecanismo Completo (Descargador + Base + Juntas) Compatibilidad: Universal: Todas las cisternas de tanque bajo y accionamiento superior	Bolsa	25	20,77
	ECY10	0139206031	8426871500036	Descargador Universal Doble Pulsador "Fomi EcoCYCLON 10" Mecanismo Completo (Descargador + Base + Juntas) + Acople Roca* [Packaging Bolsa] Compatibilidad: Base Negra Roca* + Bases Fominaya + Nueva Instalación	Bolsa	25	20,88
	ECY12	0139207011	8426871033503	Descargador Universal Doble Pulsador "Fomi EcoCYCLON 12" Mecanismo Completo (Descargador + Base + Juntas + Tornillos) + Acople Roca* [Packaging Caja] Compatibilidad: Base Negra Roca* + Bases Fominaya + Nueva Instalación	Caja	20	21,87
	ECY1	0139210211	8426871033411	Conjunto Descargador "Fomi EcoCYCLON 1" + Grifo Lateral GL Mecanismo Completo + Grifo Lateral Varilla/Boya 3/8" Latón Compatibilidad: Universal: Todas las cisternas de tanque bajo y accionamiento superior	Bolsa	20	24,73
	ECY2	0139205111	8426871033619	Conjunto Descargador "Fomi EcoCYCLON 2" + Grifo Inferior GT Mecanismo Completo + Grifo Vertical Telescópico Varilla/Boya 3/8" Latón Compatibilidad: Universal: Todas las cisternas de tanque bajo y accionamiento superior	Bolsa	15	26,10
	ECY7	0139601211	8426871033473	Conjunto Descargador "Fomi EcoCYCLON 7" + Grifo Lateral Fomi NEMO Mecanismo Completo + Grifo Lateral Servo Fomi NEMO 3/8" Latón Compatibilidad: Universal: Todas las cisternas de tanque bajo y accionamiento superior	Bolsa	15	28,85
	ECY8	0139601111	8426871033480	Conjunto Descargador "Fomi EcoCYCLON 8" + Grifo Inferior Fomi TYTAN Mecanismo Completo + Grifo Vertical Telescópico Servo Fomi TYTAN 3/8" Latón Compatibilidad: Universal: Todas las cisternas de tanque bajo y accionamiento superior	Bolsa	15	31,54
	ECY13	0139250211	8426871107884	Conjunto Descargador "Fomi EcoCYCLON 13" + Grifo Lateral Fomi FENYX Mecanismo Completo + Grifo Lateral Antical Fomi FENYX 3/8" Latón Compatibilidad: Universal: Todas las cisternas de tanque bajo y accionamiento superior	Bolsa	15	26,48
	ECY14	0139255111	8426871107877	Conjunto Descargador "Fomi EcoCYCLON 14" + Grifo Inferior Fomi FENYX Mecanismo Completo + Grifo Vertical Telescópico Antical Fomi FENYX 3/8" Latón Compatibilidad: Universal: Todas las cisternas de tanque bajo y accionamiento superior	Bolsa	15	26,98

IMAGEN	MOD.	REF.	EAN	DESCRIPCIÓN	PACK		PVP
	OAS1	0149012118	8426871006248	Conjunto Descargador con Tirador "Fomi OASIS 1" + Grifo Inferior GT Mecanismo Completo con Tirador Ancho Blanco + Grifo Vertical Telescópico Varilla/Boya 3/8" Latón Compatibilidad: Universal: Todas las cisternas de tanque bajo y accionamiento superior	Bolsa	20	15,99
	OAS3	0149012218	8426871028189	Conjunto Descargador con Tirador "Fomi OASIS 3" + Grifo Lateral GL Mecanismo Completo con Tirador Ancho Blanco + Grifo Lateral Varilla/Boya 3/8" Latón Compatibilidad: Universal: Todas las cisternas de tanque bajo y accionamiento superior	Bolsa	25	14,56
	COR1	0149012122	8426871006262	Conjunto Descargador con Tirador "Fomi CORAL 1" + Grifo Inferior GT Mecanismo Completo con Tirador Ancho Cromo + Grifo Vertical Telescópico Varilla/Boya 3/8" Latón Compatibilidad: Universal: Todas las cisternas de tanque bajo y accionamiento superior	Bolsa	20	18,46
	DUN1	0149001115	8426871400077	Conjunto Descargador con Tirador "Fomi DUNA 1" + Grifo Inferior GT Mecanismo Completo con Tirador Estrecho Cromo + Grifo Vertical Telescópico Varilla/Boya 3/8" Latón Compatibilidad: Universal: Todas las cisternas de tanque bajo y accionamiento superior	Bolsa	20	18,19
	DUN3	0149015215	8426871400084	Conjunto Descargador con Tirador "Fomi DUNA 3" + Grifo Lateral GL Mecanismo Completo con Tirador Estrecho Cromo + Grifo Lateral Varilla/Boya 3/8" Latón Compatibilidad: Universal: Todas las cisternas de tanque bajo y accionamiento superior	Bolsa	25	16,21
	ISL1	0149014129	8426871006286	Conjunto Descargador con Manivela "Fomi ISLA 1" + Grifo Inferior GT Mecanismo Completo con Manivela Cromo + Grifo Vertical Telescópico Varilla/Boya Compatibilidad: Universal: Todas las cisternas de tanque bajo y accionamiento frontal	Bolsa	20	27,20
	ISL2	0149014229	8426871006293	Conjunto Descargador con Manivela "Fomi ISLA 2" + Grifo Lateral GL Mecanismo Completo con Manivela Cromo + Grifo Lateral Varilla/Boya Compatibilidad: Universal: Todas las cisternas de tanque bajo y accionamiento frontal	Bolsa	25	27,15
	TYF12	0129102221	8426871004510	Conjunto Descargador "TYFON+ 12" Mod. AQUATIS + Grifo Lateral GL Mecanismo Completo + Grifo Lateral Varilla/Boya AQUATIS 3/8" Latón Compatibilidad: Universal: Todas las cisternas de tanque bajo y accionamiento superior	Bolsa	25	18,24
	TYF13	0129102121	8426871040303	Conjunto Descargador "TYFON+ 13" Mod. AQUATIS + Grifo Inferior GT Mecanismo Completo + Grifo Vertical Telescópico Varilla/Boya AQUATIS 3/8" Latón Compatibilidad: Universal: Todas las cisternas de tanque bajo y accionamiento superior	Bolsa	25	19,73

IMAGEN	MOD.	REF.	EAN	DESCRIPCIÓN	PACK		PVP
	FENYX DUAL	0144405420	8426871196314	Grifo Flotador Compacto Dual: Lateral+Inferior "Fomi FENYX" 3/8" LATÓN [Caja] Entrada lateral+inferior - Cierre Pistón Silencioso - Especial Antical - Conexión 3/8" LATÓN [Packaging Caja] Compatibilidad: Universal: Todas las cerámicas con entrada de agua superior e inferior	Caja	12	12,99
	FENYX DUAL	0144401420	8426871195676	Grifo Flotador Compacto Dual: Lateral+Inferior "Fomi FENYX" 3/8" LATÓN [Bolsa] Entrada lateral+inferior - Cierre Pistón Silencioso - Especial Antical - Conexión 3/8" LATÓN [Packaging Bolsa] Compatibilidad: Universal: Todas las cerámicas con entrada de agua superior e inferior	Bolsa	25	11,28
	FENYX L38L	0144160120	8426871116152	Grifo Flotador Compacto Lateral "Fomi FENYX" 3/8" LATÓN [Caja] Cierre Pistón Silencioso - Especial Antical - Conexión 3/8" LATÓN [Packaging Caja Individual] Compatibilidad: Universal: Todas las cerámicas con entrada de agua superior	Caja	16	9,01
	FENYX L38LB	0144180120	8426871118750	Grifo Flotador Compacto Lateral "Fomi FENYX" 3/8" LATÓN [Bolsa] Cierre Pistón Silencioso - Especial Antical - Conexión 3/8" LATÓN [Packaging Bolsa] Compatibilidad: Universal: Todas las cerámicas con entrada de agua superior	Bolsa	25	6,46
	FENYX L12R	0144162120	8426871116176	Grifo Flotador Compacto Lateral "Fomi FENYX" 1/2" POM [Caja] Cierre Pistón Silencioso - Especial Antical - Conexión 1/2" POM (Resina) [Packaging Caja Individual] Compatibilidad: Universal: Todas las cerámicas con entrada de agua superior	Caja	16	4,67
	FENYX L12RB	0144182120	8426871118774	Grifo Flotador Compacto Lateral "Fomi FENYX" 1/2" POM [Bolsa] Cierre Pistón Silencioso - Especial Antical - Conexión 1/2" POM (Resina) [Packaging Bolsa] Compatibilidad: Universal: Todas las cerámicas con entrada de agua superior	Bolsa	25	7,47
	FENYX V38L	0144360320	8426871116183	Grifo Flotador Compacto Inferior Telescópico "Fomi FENYX" 3/8" LATÓN [Caja] Cierre Pistón Silencioso - Especial Antical - Conexión 3/8" LATÓN [Packaging Caja Individual] Compatibilidad: Universal: Todas las cerámicas con entrada de agua inferior	Caja	16	11,46
	FENYX V38LB	0144380320	8426871118781	Grifo Flotador Compacto Inferior Telescópico "Fomi FENYX" 3/8" LATÓN [Bolsa] Cierre Pistón Silencioso - Especial Antical - Conexión 3/8" LATÓN [Packaging Bolsa] Compatibilidad: Universal: Todas las cerámicas con entrada de agua inferior	Bolsa	25	8,81









IMAGEN	MOD.	REF.	EAN	DESCRIPCIÓN	PACK		PVP
	FENYX V38RB	0144381320	8426871118798	Grifo Flotador Compacto Inferior Telescópico "Fomi FENYX" 3/8" POM (Resina) [Bolsa] Cierre Pistón Silencioso - Especial Antical - Conexión 3/8" POM (Resina) [Packaging Bolsa] Compatibilidad: Universal: Todas las cerámicas con entrada de agua inferior	Bolsa	25	7,37
	FENYX V12R	0144362320	8426871116206	Grifo Flotador Compacto Inferior Telescópico "Fomi FENYX" 1/2" POM (Resina) [Caja] Cierre Pistón Silencioso - Especial Antical - Conexión 1/2" POM (Resina) [Packaging Caja Individual] Compatibilidad: Universal: Todas las cerámicas con entrada de agua inferior	Caja	16	8,66
	FENYX V12RB	0144382320	8426871118804	Grifo Flotador Compacto Inferior Telescópico "Fomi FENYX" 1/2" POM (Resina) [Bolsa] Cierre Pistón Silencioso - Especial Antical - Conexión 1/2" POM (Resina) [Packaging Bolsa] Compatibilidad: Universal: Todas las cerámicas con entrada de agua inferior	Bolsa	25	7,03
	NEMO 12R	0144192120	8426871052436	Grifo Flotador Silencioso Lateral "Fomi NEMO" 1/2" POM Cierre Servo muy Silencioso - Conexión 1/2" POM (Resina) [Packaging Caja Individual] Compatibilidad: Universal: Todas las cerámicas con entrada de agua superior	Caja	16	8,79
	NEMO 38R	0144191120	8426871052443	Grifo Flotador Silencioso Lateral "Fomi NEMO" 3/8" POM Cierre Servo muy Silencioso - Conexión 3/8" POM (Resina) [Packaging Caja Individual] Compatibilidad: Universal: Todas las cerámicas con entrada de agua superior	Caja	16	8,77
	NEMO 38L	0144191110	8426871028820	Grifo Flotador Silencioso Lateral "Fomi NEMO" 3/8" LATÓN Cierre Servo muy Silencioso - Conexión 3/8" LATÓN [Packaging Caja Individual] Compatibilidad: Universal: Todas las cerámicas con entrada de agua superior	Caja	16	10,61
	TYTAN 12R	0144392320	8426871052450	Grifo Flotador Silencioso Inferior Telescópico "Fomi TYTAN" 1/2" POM Cierre Servo muy Silencioso - Conexión 1/2" POM (Resina) [Packaging Caja Individual] Compatibilidad: Universal: Todas las cerámicas con entrada de agua inferior	Caja	16	9,95
	TYTAN 38R	0144391320	8426871052467	Grifo Flotador Silencioso Inferior Telescópico "Fomi TYTAN" 3/8" POM Cierre Servo muy Silencioso - Conexión 3/8" POM (Resina) [Packaging Caja Individual] Compatibilidad: Universal: Todas las cerámicas con entrada de agua inferior	Caja	16	10,34
	TYTAN 38L	0144391310	8426871028608	Grifo Flotador Silencioso Inferior Telescópico "Fomi TYTAN" 3/8" LATÓN Cierre Servo muy Silencioso - Conexión 3/8" LATÓN [Packaging Caja Individual] Compatibilidad: Universal: Todas las cerámicas con entrada de agua inferior	Caja	16	12,25







IMAGEN	MOD.	REF.	EAN	DESCRIPCIÓN	PACK		PVP
	FENYX DÚO	0144400420	8426871129442	Conjunto Grifos Flotador Lateral + Inferior "Fomi FENYX DÚO" 3/8" LATÓN [Bolsa] Cierre Pistón Silencioso - Especial Antical - Conexión 3/8" LATÓN [Packaging Bolsa] Compatibilidad: Universal: Todas las cerámicas	Bolsa	25	14,52
	GL1	0144100110	8426871400060	Grifo Lateral Varilla/Boya "GL1" 3/8" LATÓN Cierre Pistón Varilla/Boya - Conexión 3/8" LATÓN Compatibilidad: Universal: Todas las cerámicas con entrada de agua superior	Bolsa	50	5,38
	GL5	0144100120	8426871041119	Grifo Lateral Varilla/Boya "GL5" 3/8" POM (Resina) Cierre Pistón Varilla/Boya - Conexión 3/8" POM (Resina) Compatibilidad: Universal: Todas las cerámicas con entrada de agua superior	Bolsa	50	3,72
	GL6	0144101120	8426871041126	Grifo Lateral Varilla/Boya "GL6" 1/2" POM (Resina) Cierre Pistón Varilla/Boya - Conexión 1/2" POM (Resina) Compatibilidad: Universal: Todas las cerámicas con entrada de agua superior	Bolsa	50	3,66
	GT1	0144300310	8426871400053	Grifo Inferior Telescópico Varilla/Boya "GT1" 3/8" LATÓN Cierre Pistón Varilla/Boya - Conexión 3/8" LATÓN Compatibilidad: Universal: Todas las cerámicas con entrada de agua inferior	Bolsa	20	7,86
	GT4	0144300320	8426871041102	Grifo Inferior Telescópico Varilla/Boya "GT4" 3/8" POM (Resina) Cierre Pistón Varilla/Boya - Conexión 3/8" POM (Resina) Compatibilidad: Universal: Todas las cerámicas con entrada de agua inferior	Bolsa	20	6,43
	GL2	0144505530	8426871005876	Grifo Lateral Varilla/Boya "GL2" 3/8" LATÓN ZINCADO Cierre Pistón Varilla/Boya - Conexión 3/8" LATÓN ZINCADO Compatibilidad: Dual-Alcora-Pozzi-Victoria-Venecia	Bolsa	50	9,51
	GL4	0144503530	8426871005852	Grifo Escuadra Varilla/Boya "GL4" 3/8" LATÓN ZINCADO Cierre Pistón Varilla/Boya - Conexión 3/8" LATÓN ZINCADO Compatibilidad: Loto-Lucerna Serie 2000-Alcora-Proa-Espacio	Bolsa	10	17,08



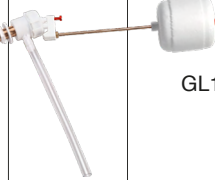
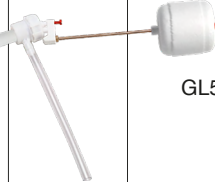





IMAGEN	MOD.	REF.	EAN	DESCRIPCIÓN	PACK		PVP
	GV1	0144500530	8426871005821	Grifo Vertical "GV1" 3/8" LATÓN- Asiento Cierre en Resina Acetalica Cierre Pistón Varilla/Boya - Conexión 3/8" LATÓN - Asiento Cierre en Resina Acetalica Compatibilidad: Nerja-Capri-Lorentina-Loira-Gaeta-Concreto-Arlanza-Confor-Aquaria-Granada	Bolsa	25	11,87
	GV2	0144502530	8426871005845	Grifo Vertical "GV2" 3/8" LATÓN- Asiento Cierre en Resina Acetalica Cierre Pistón Varilla/Boya - Conexión 3/8" LATÓN - Asiento Cierre en Resina Acetalica Compatibilidad: Yina	Bolsa	25	11,90
	GV3	0144504530	8426871005869	Grifo Vertical "GV3" 3/8" LATÓN- Asiento Cierre en Resina Acetalica Cierre Pistón Varilla/Boya - Conexión 3/8" LATÓN - Asiento Cierre en Resina Acetalica Compatibilidad: Venus-Apolo-Góndola-Domo	Bolsa	25	13,19
	BY7	0144701740	8426871005906	Boya Regulable con Soporte Guía "BY7" 3/8" Poliestireno Expandido Compatibilidad: Grifos Flotador Varilla/Boya	Grael	25	0,93
	BY14	0144700740	8426871005890	Boya Regulable con Soporte Guía "BY14" 3/8" Poliestireno Expandido - Ø14 mm con Vástago Roscado + Pasador Compatibilidad: Grifos Flotador Varilla/Boya	Grael	25	1,04
	DF1	0147002200	8426871005999	Descargador con Rebosadero Fijo y Ganchillo "DF1" Descargador Fijo con Ganchillo (131 mm) + Base + Juntas Compatibilidad: Centa-Loto-Lorentina y Leonardo	Bolsa	50	5,19
	DF2	0147003200	8426871006002	Descargador con Rebosadero Fijo y Ganchillo "DF2" Descargador Fijo con Ganchillo (195 mm) + Base + Juntas Compatibilidad: Estándar	Bolsa	50	5,35
	DF3	0147008200	8426871006033	Descargador con Rebosadero Fijo y Ganchillo "DF3" Descargador Fijo con Ganchillo (175 mm) + Base + Juntas Compatibilidad: Victoria	Bolsa	50	5,35
	DE1	0147004100	8426871028462	Descargador con Rebosadero Extensible "DE1" Descargador Extensible (Campana Standard) + Base y Juntas Compatibilidad: Universal: Todas las cisternas de tanque bajo y tirador superior	Bolsa	20	5,16











IMAGEN	MOD.	REF.	EAN	DESCRIPCIÓN	PACK		PVP
	DE2	0147106300	8426871033633	Descargador con Rebosadero Extensible "Fomi OCEAN" Descargador Extensible (Campana Invertida) + Base + Juntas + Acople Roca* Compatibilidad: Universal: Todas las cisternas de tanque bajo y tirador superior	Bolsa	25	7,58
	DE3	0147109400	8426871033657	Descargador con Rebosadero Extensible "Fomi BAHYA" Descargador con Puente y Tirador + Base + Juntas + Acople Roca* Compatibilidad: Universal: Todas las cisternas de tanque bajo y tirador superior	Bolsa	25	12,36
	CF1	0146105400	8426871033640	Campana sin Base "CF1" Campana con Puente + Tirador "Fomi BAHYA" - Especial Victoria Compatibilidad: Cisternas Victoria con fijación tapa	Bolsa	25	10,11
	CF2	0146007200	8426871005982	Campana sin Base "CF2" Campana Rebosadero Fijo con Ganchillo Standard (S/B) Compatibilidad: Universal: Todas las cisternas de tanque bajo y tirador superior	Bolsa	25	4,08
	CE3	0146003100	8426871005944	Campana Extensible "CE3" Campana Invertida Extensible - Standard FOMINAYA - Sin Base Compatibilidad: Universal: Todas las cisternas de tanque bajo y tirador superior	Bolsa	25	3,26
	CE4	0146104300	8426871033626	Campana Extensible "CE4" Campana Invertida Extensible - Fomi OCEAN - Sin Base Compatibilidad: Universal: Todas las cisternas de tanque bajo y tirador superior	Bolsa	20	6,29
	AD1	0138529010	8426871004978	Adaptador Fominaya "AD1" Series "Fomi AQUA" + "Fomi LLAURO (con bayoneta) + "Fomi TYFON+" Compatibilidad: Base Negra Roca* + Bases Fominaya	Granel	25	1,54
	AD2	0138529020	8426871033749	Adaptador Fominaya "AD2" Series "Fomi ECOCYCLON" + "Fomi CYCLON" + "Fomi BAHYA" + "Fomi OCEAN" Compatibilidad: Base Negra Roca* + Bases Fominaya	Granel	25	1,54
	AD3	0138529030	8426871092654	Adaptador Fominaya "AD3" Serie "Fomi TYFON 3G" + "Fomi DRACKO (anterior 2022)" Compatibilidad: Base Negra Roca* + Bases Fominaya	Granel	25	1,54
	BT3	0138508030	8426871092609	Conjunto Base + Tuerca "BT3" Serie "Fomi TYFON 3G" + "Fomi DRACKO (anterior 2022)" *SOLO REPOSICIÓN* Compatibilidad: Nueva Instalación	Granel	25	1,54

IMAGEN	MOD.	REF.	EAN	DESCRIPCIÓN	PACK		PVP
	BT1	0138508010	8426871004947	Conjunto Base + Tuerca "BT1" Series "Fomi AQUA" + "Fomi LLAURO (con bayoneta)" + "Fomi TYFON+" + "Fomi TYFON 3G" Compatibilidad: Nueva Instalación	Granel	25	1,04
	BT2	0138508020	8426871033763	Conjunto Base + Tuerca "BT2" Series "Fomi ECOCYCLON" + "Fomi CYCLON" + "Fomi BAHYA" + "Fomi OCEAN" Compatibilidad: Nueva Instalación	Granel	25	1,04
	PTY1	0142303110	8426871005739	Pulsador Universal "Fomi CYCLON" + "Fomi TYFON 3G" + "Fomi TYFON+" + "AQUA Simple" Cromado - Universal (Relieve + Empotrado) CYCLON + AQUA Simple + TYFON 3G + TYFON+ Compatibilidad: Mecanismos: Fomi CYCLON + AQUA Simple + Fomi TYFON 3G + Fomi TYFON+	Bolsa	25	3,47
	P1	0142203110	8426871005678	Pulsador Universal "Fomi EcoCYCLON" + "Fomi EcoTYFON 5G" + "AQUA Doble" Cromado - Universal (Relieve + Empotrado) EcoCYCLON + EcoTYFON 5G + AQUA Doble Compatibilidad: Mecanismos: Fomi EcoCYCLON + Fomi EcoTYFON 5G + AQUA Doble	Bolsa	25	6,53
	PDK1	0142204110	8426871087650	Pulsador Universal "Fomi DRACKO" Cromado - Universal (Relieve + Empotrado) DRACKO Compatibilidad: Mecanismos: Fomi DRACKO	Bolsa	25	6,53
	PTY2	0142304110	8426871501408	NOVEDAD Conjunto Pulsador PTY 2 con Aro Adaptador 60 mm Cromado - Cisternas Ø > 48 mm Compatibilidad: Mecanismos: Fomi CYCLON + AQUA SIMPLE + Fomi TYFON 3G + Fomi TYFON+	Bolsa	10	5,47
	P2	0142205110	8426871501415	NOVEDAD Conjunto Pulsador P 2 con Aro Adaptador 60 mm Cromado - Cisternas Ø > 48 mm Compatibilidad: Mecanismos: Fomi EcoCYCLON + Fomi EcoTYFON 5G + AQUA DOBLE	Bolsa	10	8,53
	PDK2	0142206110	8426871501422	NOVEDAD Conjunto Pulsador PDK 2 con Aro Adaptador 60 mm Cromado - Cisternas Ø > 48 mm Compatibilidad: Mecanismos: Fomi DRACKO	Bolsa	10	8,53
	PU1	0142016130	8426871005579	Pulsador Lateral de Uña Cromado - Metálico - Long. 175 mm Cromado - Metálico - Longitud 175 mm Compatibilidad: Yina	Bolsa	10	13,53
	PC1	0142017130	8426871005586	Pulsador Lateral Cuadradillo "PC1" Cromado - Metálico - Longitud 190 mm Compatibilidad: Zenta España - Leonardo y Lorentina	Bolsa	10	16,47
	PC2	0142015130	8426871005562	Pulsador Lateral Cuadradillo "PC2" Cromado - Metálico - Longitud 280 mm Compatibilidad: Especial Roca	Bolsa	10	16,12

IMAGEN	MOD.	REF.	EAN	DESCRIPCIÓN	PACK		PVP
	PM1	0142018130	8426871005593	Pulsador de Manivela "PM1" Cromado - Metálico - Longitud 170 mm Compatibilidad: Algarbe - Loira - Grecia - Classica y Esfinge.	Bolsa	10	13,84
	PM2	0142019130	8426871005609	Pulsador de Manivela "PM2" Cromado - Metálico - Longitud 230 mm Compatibilidad: Concreto	Bolsa	10	13,93
	PM3	0142019110	8426871127820	Pulsador de Manivela "PM3" Cromado - ABS (Plástico) - Longitud 210 mm Compatibilidad: Estándar.	Bolsa	10	4,94
	TPC	0138015010	8426871004756	Tapón Embellecedor Lateral "TPC" ABS Cromado Compatibilidad: Universal: Todas las cerámicas con entrada de agua superior	Granel	25	1,11
	TPP	0138015070	8426871112673	Tapón Embellecedor Lateral "TPP" PPCO Blanco (Plástico) Compatibilidad: Universal: Todas las cerámicas con entrada de agua superior	Granel	25	0,35
	TPI	0138015030	8426871004770	Tapón Embellecedor Inferior "TPI" Tuerca de Resina Acetalica + Junta Cierre Compatibilidad: Universal: Todas las cerámicas con entrada de agua inferior	Granel	25	0,79
	TV1A	0142001120	8426871005371	Tirador Vertical Tipo 1 - Recto - "TV1A" Pomo Latón y Base ABS Cromados - Varilla de Inoxidable - 83 mm Compatibilidad: Domo-Dual-Lucerna-Itálica-Granada-Venecia-Acuaria-Novo Espacio-Cuadraco	Bolsa	25	6,80
	TV1C	0142001110	8426871005364	Tirador Vertical Tipo 1 - Recto - "TV1C" Pomo y Base ABS Cromados - Varilla de Inoxidable - 83 mm Compatibilidad: Domo-Dual-Lucerna-Itálica-Granada-Venecia-Acuaria-Novo Espacio-Cuadraco	Bolsa	25	2,41
	TV2A	0142002120	8426871005401	Tirador Vertical Tipo 2 - Recto - "TV2A" Pomo y Base ABS Cromados - Varilla de Inoxidable - 68 mm Compatibilidad: Venus-Apolo-Confo-Nerja-Alcora-Arlanza	Bolsa	25	6,23
	TV2C	0142002110	8426871005395	Tirador Vertical Tipo 2 - Recto - "TV2C" Pomo y Base ABS Cromados - Varilla de Inoxidable - 68 mm Compatibilidad: Venus-Apolo-Confo-Nerja-Alcora-Arlanza	Bolsa	25	2,35

IMAGEN	MOD.	REF.	EAN	DESCRIPCIÓN	PACK		PVP
	TV3A	0142003120	8426871005425	Tirador Vertical Tipo 3 - Curvo - "TV3A" Pomo Latón y Base ABS Cromados - Varilla latón pintado - 76x23 mm Compatibilidad: Espacio - Gaeta.	Bolsa	25	6,30
	TV3C	0142003110	8426871005418	Tirador Vertical Tipo 3 - Curvo - "TV3C" Pomo y Base ABS Cromados - Varilla latón pintado - 76x23 mm Compatibilidad: Espacio - Gaeta.	Bolsa	25	2,53
	TV4A	0142004120	8426871005449	Tirador Vertical Tipo 4 - Curvo - "TV4A" Pomo Latón y Base ABS Cromados - Varilla Inoxidable - 114x56 mm Compatibilidad: Segesta - Roca - Lisboa - Valentine	Bolsa	25	6,57
	TV4C	0142004110	8426871005432	Tirador Vertical Tipo 4 - Curvo - "TV4C" Pomo y Base ABS Cromados - Varilla Inoxidable - 114x56 mm Compatibilidad: Segesta - Roca - Lisboa - Valentine	Bolsa	25	2,55
	TV5A	0142005120	8426871005470	Tirador Vertical Tipo 5 - Recto - "TV5A" Pomo Latón y Base ABS Cromados - Varilla Inoxidable - 114 mm Compatibilidad: Universal - Especial Roca.	Bolsa	25	7,03
	TV5C	0142005110	8426871005463	Tirador Vertical Tipo 5 - Recto - "TV5C" Pomo y Base ABS Cromados - Varilla Inoxidable - 114 mm Compatibilidad: Universal - Especial Roca.	Bolsa	25	3,05
	TV6A	0142006120	8426871005494	Tirador Vertical Tipo 6 - Curvo - "TV6A" Pomo Latón y Base ABS Cromados - Varilla Inoxidable - 88x57 mm Compatibilidad: Universal	Bolsa	25	6,62
	TV6C	0142006110	8426871005487	Tirador Vertical Tipo 6 - Curvo - "TV6C" Pomo y Base ABS Cromados - Varilla Inoxidable - 88x57 mm Compatibilidad: Universal	Bolsa	25	2,65
	TV9E	0142009310	8426871005517	Tirador Vertical Tipo 9 - Curvo - "TV9E" ABS Blanco con Base Ancha - Económico - Varilla Inoxidable - 95x50 mm Compatibilidad: Universal para agujeros de tapa diámetro 45 mm	Bolsa	25	1,82
	TV11C	0142011120	8426871005548	Tirador Vertical Tipo 11 - Curvo - "TV11C" ABS Cromado con Base Ancha - Varilla Inoxidable - 70x50 mm Compatibilidad: Universal para agujeros de tapa diámetro 45 mm. Cisternas Altaír y Bahía.	Bolsa	25	2,65









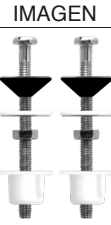

IMAGEN	MOD.	REF.	EAN	DESCRIPCIÓN	PACK		PVP
	TC1	0140564030	8426871400107	Conjunto Tornillos Sujeción Cisterna-Inodoro "TC1" Conexión Cisterna-Inodoro - INOX - RM 6x80 mm - Especiales Anticorrosión Compatibilidad: Universal	Bolsa	25	2,18
	TC2	0140564040	8426871400114	Conjunto Tornillos Sujeción Cisterna-Inodoro "TC2" INOX - RM 6x120 mm - Especiales Anticorrosión Compatibilidad: Alcora-Domo	Bolsa	25	2,47
	TC3	0140564070	8426871098038	Conjunto Tornillos Sujeción Cisterna-Inodoro "TC3" POM (Resina) - RM 9x80 mm Compatibilidad: Universal	Bolsa	25	1,12
	TI1	0140564050	8426871005357	Conjunto Tornillos Sujeción Inodoro/Bidet "TI1" Conexión Inodoro/Bidet-Suelo Vertical - Hierro Galvanizado - Cabeza Latón - RM 5x75 mm Compatibilidad: Universal	Bolsa	25	1,26
	TI2	0140564060	8426871400121	Conjunto Tornillos Sujeción Inodoro/Bidet "TI2" Conexión Inodoro/Bidet-Suelo Lateral - Hierro Galvanizado - Cabeza Acero Inoxidable - M 6 mm Compatibilidad: Universal	Bolsa	25	2,00
	TI5	0140564080	8426871124812	Conjunto Tornillos Sujeción Inodoro/Bidet "TI5" ESCUADRA Conexión Inodoro/Bidet-Suelo Lateral - ESCUADRA - INOX Compatibilidad: Universal	Bolsa	25	7,18
	TL1	0138564010	8426871004985	Conjunto Tornillos Sujeción Lavabo "TL1" Conexión Lavabo - Hierro Bicromatado - Cabeza Nylon - RM 10x110 mm Compatibilidad: Universal	Bolsa	25	2,00
	EM1	0138015040	8426871004787	Embellecedor ABS Cromado "EM1" ABS Cromado - Ø Garras 23 mm Compatibilidad: Universal	Granel	50	0,47
	H1	0138513020	8426871004961	Ganchillo de Accionamiento "H1" Ø 2x131 mm - Acero Inoxidable Compatibilidad: Zenta + Loto + Lorentina y Leonardo	Granel	25	0,94
	H2	0138513010	8426871004954	Ganchillo de Accionamiento "H2" Ø 2x205 mm - Acero Inoxidable Compatibilidad: Nerja y Capri Antiguo	Granel	25	1,12

IMAGEN	MOD.	REF.	EAN	DESCRIPCIÓN	PACK		PVP
	RV	0138003070	8426871004749	Goma de Obturación con Varilla "RV" Cjto. Goma Pera Caucho, Dia. 63 + Varilla Latón Doblada Compatibilidad:	Grael	25	3,76
	RF1	0138003030	8426871004701	Goma de Obturación "RF1" FOMINAYA - Sombrerete - Ø 68x18 mm - Caucho Virgen Compatibilidad:	Grael	100	1,00
	RF2	0138003040	8426871004718	Goma de Obturación "RF2" FOMINAYA - Sombrerete - Ø 68x18 mm - Caucho Sintético (EPDM) Compatibilidad:	Grael	100	1,05
	RB1	0138003010	8426871004688	Goma de Obturación "RB1" Plana - Ø 56x18 mm - Caucho Sintético (EPDM) Compatibilidad: Llauro - Aqña - DC52	Grael	100	0,53
	RB2	0138003020	8426871004695	Goma de Obturación "RB2" ESPECIAL ROCA* - Plana - Ø 73x23 mm - Caucho Virgen Compatibilidad: Especial Roca*	Grael	100	1,33
	RB3	0138003050	8426871004725	Goma de Obturación "RB3" VICTORIA NUEVO - Plana Ø 68x32 - Caucho Sintético (EPDM) Compatibilidad: Victoria Nuevo	Grael	100	0,65
	RB4	0138003080	8426871029940	Goma de Obturación "RB4" Plana Ø 65x17 mm - Caucho Sintético (EPDM) Compatibilidad: Cyclon - Ocean - Bahya - Roca*	Grael	100	0,82
	RB5	0138003090	8426871081719	Goma de Obturación "RB5" Plana Ø 62x17 mm - Caucho Sintético Negro (EPDM) Compatibilidad: Dracko - Tyfon	Grael	100	0,59
	CM 1	0138048070	8426871027489	Junta de Conexión para Manguitos "CM1" Junta Estriada de Conexión para Manguitos - Caucho - Ø 90 a 110 mm Compatibilidad:	Grael	36	1,65
	CM 2	0138048090	8426871073271	Junta de Conexión para Manguitos "CM2" Junta Conexión Tubería Bajante - Caucho - Ø 90 a 110 mm Compatibilidad:	Grael	36	1,82



IMAGEN	MOD.	REF.	EAN	DESCRIPCIÓN	PACK		PVP
	JD1	0138050010	8426871004930	Junta Descargador / Cisterna "JD1" Arandela Polipropileno Blanca - Ø 74,5x59,5 mm Compatibilidad: Universal	Grael	50	0,47
	JD2	0138049010	8426871004909	Junta Descargador / Cisterna "JD2" Caucho Natural Negro - Ø 81 x 55 mm Compatibilidad: Universal	Grael	50	1,53
	JD3	0138049020	8426871004916	Junta Descargador / Cisterna "JD3" Caucho SBS Negro - Ø 82 x 56 mm Compatibilidad: Universal	Grael	50	0,76
	J11	0138048040	8426871004886	Junta Cisterna / Inodoro "J11" Caucho Celular - Ø 105 x 85 mm. Espesor: 12 mm Compatibilidad: Domo-Therma-Acuaria-Trio	Grael	50	1,12
	J13	0138048010	8426871004855	Junta Cisterna / Inodoro "J13" Caucho Celular Negro - Cónica - Ø 100 x 59 mm Compatibilidad: Capri-Olimpia-Regia-Confor-Belinda-Atlanta-Amadeus Lara-Cannes-Venus-Aquiline-Topacio-Stilo-Gala 2000 Granda-Monte Bianco-Ivelinas	Grael	50	1,76
	J15	0138048030	8426871004879	Junta Cisterna / Inodoro "J15" Caucho Celular Negro - Cónica - Ø 110 x 58 mm Compatibilidad: Apolo-Cuadraco-Lisboa-Miguel Ángel-Victoria Mural-Colonia-Algarbe-Sintesi-Época-Atenea	Grael	50	1,94
	KJ1	0138548010	8426871055789	Kit de Juntas Cisterna / Inodoro "KJ1" Caucho Celular - Espesor 20 mm - Ø 56 mm (Cisterna alta) - Ø 82 mm (Base-Mecanismo) - Ø 111 mm (Cisterna-Inodoro) Compatibilidad: Cisterna baja + Cisterna alta	Grael	50	2,24
	KJ2	0138548020	8426871110112	Kit de Juntas Cisterna / Inodoro "KJ2" Caucho Celular - Espesor 15 mm - Ø 56 mm (Cisterna alta) - Ø 82 mm (Base-Mecanismo) - Ø 111 mm (Cisterna-Inodoro) Compatibilidad: Cisterna baja + Cisterna alta	Grael	50	1,88
	KJT1	0138576010	8426871055826	Conjunto Kit de Juntas + Tornillos TC1 "KJT1" Kit Juntas Caucho Celular 15 mm + Conjunto Tornillos TC1 (INOX) Compatibilidad:	Bolsa	10	3,76
	KJT2	0138576020	8426871099875	Conjunto Kit de Juntas + Tornillos TC3 "KJT2" Kit Juntas Caucho Celular 15 mm + Conjunto Tornillos TC3 (Plástico POM) Compatibilidad:	Bolsa	10	2,71

IMAGEN	MOD.	REF.	EAN	DESCRIPCIÓN	PACK		PVP
	MXDUO	0138543020	8426871094634	Manguito Conexión Inodoro "MX DÚO" Excéntrico - Ø 90 a 110 mm - Polietileno y Caucho Compatibilidad:	Bolsa	15	5,60
	M9	0138043010	8426871004817	Manguito Conexión Inodoro "M9" Recto - Ø90 mm - ABS y Caucho	Granel	36	4,78
	M11	0138043020	8426871004824	Manguito Conexión Inodoro "M11" Recto - Ø110 mm - ABS y Caucho	Granel	36	4,95
	MX9	0138043030	8426871004831	Manguito Conexión Inodoro "MX9" Excéntrico - Ø90 mm - ABS y Caucho	Granel	36	4,78
	MX11	0138043040	8426871004848	Manguito Conexión Inodoro "MX11" Excéntrico - Ø110 mm - ABS y Caucho	Granel	36	4,95

IMAGEN	MOD.	REF.	EAN	DESCRIPCIÓN	PACK		PVP
	BL252	0153004607	8426871007009	Equipamiento Completo Cisterna Alta "BL252" Conjunto Descargador "DC252" + "Grifo "GC1" Compatibilidad: Universal: Todas las cisternas de tanque alto o suspendido	Bolsa	20	22,99
	BL263	0153014110	8426871007078	Equipamiento Completo Cisterna Alta "BL263" Conjunto Descargador "DC262" + "Grifo "GL1" (Lateral C/B) Compatibilidad: Universal: Todas las cisternas de tanque alto o suspendido	Bolsa	20	18,83
	BL254	0153004608	8426871007016	Equipamiento Completo Cisterna Alta "BL254" Conjunto Descargador "DC254" + "Grifo "GC1" Compatibilidad: Universal: Todas las cisternas de tanque alto o suspendido	Bolsa	20	16,22
	BL261	0153004609	8426871007023	Equipamiento Completo Cisterna Alta "BL261" Conjunto Descargador "DC261" + "Grifo "GC1" Compatibilidad: Universal: Todas las cisternas de tanque alto o suspendido	Bolsa	20	16,34
	BL262	0153004610	8426871007030	Equipamiento Completo Cisterna Alta "BL262" Conjunto Descargador "DC262" + "Grifo "GC1" Compatibilidad: Universal: Todas las cisternas de tanque alto o suspendido	Bolsa	20	21,69
	DC251	0156003510	8426871007481	Conjunto Descargador Cisterna Alta "DC251" + Base Mecanismo Completo Rebosadero Latón Ø12 mm + Base PS/SBR (Plástico). Longitud 175 mm Compatibilidad: Universal: Todas las cisternas de tanque alto o suspendido	Bolsa	25	5,24
	DC252	0156003610	8426871007498	Conjunto Descargador Cisterna Alta "DC252" + Base Mecanismo Completo Rebosadero Latón Ø12 mm + Base Metal. Longitud 175 mm Compatibilidad: Universal: Todas las cisternas de tanque alto o suspendido	Bolsa	25	10,44
	DC254	0156003720	8426871007504	Conjunto Descargador Cisterna Alta "DC254" + Base Mecanismo Completo Rebosadero PS/SBR (Plástico) Ø12 mm + Base Plástico. Longitud 175 mm Compatibilidad: Universal: Todas las cisternas de tanque alto o suspendido	Bolsa	25	3,67
	DC261	0156004810	8426871007511	Conjunto Descargador Cisterna Alta "DC261" + Base Mecanismo Completo Rebosadero Latón Ø5 mm + Base Plástico. Longitud 165 mm Compatibilidad: Universal: Todas las cisternas de tanque alto o suspendido	Bolsa	25	3,94
	DC262	0156004910	8426871007528	Conjunto Descargador Cisterna Alta "DC262" + Base Mecanismo Completo Rebosadero Latón Ø5 mm + Base Metal. Longitud 165 mm Compatibilidad: Universal: Todas las cisternas de tanque alto o suspendido	Bolsa	25	9,29
	D25	0155003320	8426871007429	Campana Cisterna Alta "D25" Para Base Ø 65 mm. Campana Rebosadero Poliestireno Ø12 + Ganchillo Compatibilidad: DC254	Bolsa	25	1,92











IMAGEN	MOD.	REF.	EAN	DESCRIPCIÓN	PACK		PVP
	D025	0155003310	8426871007412	Campana Cisterna Alta "D025" Para Base Ø 65 mm. Campana Rebosadero Latón Ø12 + Ganchillo Compatibilidad: DC251 - DC252	Bolsa	25	3,46
	D026	0155004410	8426871007436	Campana Cisterna Alta "D026" Para Base Ø 57 mm. Campana Rebosadero Latón Ø5 + Ganchillo Compatibilidad: DC261 - DC262	Bolsa	25	2,22
	GC1	0151600630	8426871006842	Grifo Cazoleta Lateral "GC1" 3/8" LATÓN Conexión 3/8" LATÓN - Cierre Resina Acetalica Compatibilidad: Universal: Todas las cisternas de tanque alto o suspendido	Granel	25	6,63
	GCB1	0151650630	8426871034241	Conjunto Grifo Cazoleta Lateral "GCB1" 3/8" LATÓN + Boya Conexión 3/8" LATÓN - Cierre Resina Acetalica Compatibilidad: Universal: Todas las cisternas de tanque alto o suspendido	Bolsa	25	8,02
	GP2	0151501530	8426871006811	Grifo Pistón Silencioso "GP2" 3/8" LATÓN Cierre Pistón - Conexión 3/8" LATÓN Compatibilidad: Universal: Todas las cisternas de tanque alto o suspendido	Granel	25	10,34
	GPB2	0151551530	8426871034289	Conjunto Grifo Pistón Silencioso "GP2" 3/8" LATÓN + Boya Cierre Pistón - Conexión 3/8" LATÓN [Bolsa individual equipada con Grifo+Boya] Compatibilidad: Universal: Todas las cisternas de tanque alto o suspendido	Bolsa	25	11,52
	BY1	0151700740	8426871006866	Boya 3/8" Poliestireno Expandido - Ø85 mm Compatibilidad: Grifo 3/8"	Granel	25	1,37
	BY2	0151701740	8426871006873	Boya 1/2" Poliestireno Expandido - Ø115 mm Compatibilidad: Grifo 1/2"	Granel	25	2,36
	BY3	0151702740	8426871006880	Boya 3/4" Poliestireno Expandido - Ø115 mm Compatibilidad: Grifo 3/4"	Granel	25	2,36
	BY4	0151703740	8426871006897	Boya 1" Poliestireno Expandido - Ø160 mm Compatibilidad: Grifo 1"	Granel	25	4,18







IMAGEN	MOD.	REF.	EAN	DESCRIPCIÓN	PACK		PVP
	DC52	0153004101	8426871500029	Conjunto Descargador Hidroneumático "DC52" Mecanismo Completo (Descargador+Pulsador+Juntas+Tubos+Grifo) - Ø21 x 200 mm. No incluye cisterna Compatibilidad: Universal: Todas las cisternas de tanque alto o suspendido	Bolsa	10	31,98
	D5M	0156005020	8426871028974	Descargador Hidroneumático "D5M" Campana Hidroneumática (Descargador+Juntas+Grifo) - Ø21 x 200 mm Compatibilidad: Mecanismos: DC52	Bolsa	15	16,37
	CQ2	0153002608	8426871006958	Cisterna de 15 Litros con Equipamiento Completo "CQ2" 15 litros - Polipropileno de Alta Densidad - Equipada con mecanismo completo BL254 Compatibilidad: Nueva Instalación	Bolsa	8	31,14
	CQ3	0153002101	8426871006941	Cisterna de 15 Litros con Equipamiento Completo "CQ3" 15 litros - Polipropileno de Alta Densidad - Equipada con mecanismo completo DC52 Compatibilidad: Nueva Instalación	Caja	1	42,45
	C2	0153002011	8426871027465	Cisterna de 15 Litros con Base sin Equipar 15 litros - Polipropileno de Alta Densidad - Sin equipar Compatibilidad: Nueva Instalación	Bolsa	8	15,60
	CA1	0154005010	8426871007252	Tirador WC Cadenilla "Básico" Hierro Galvanizado - Longitud 800 mm Compatibilidad: Universal: Todas las cisternas de tanque alto o suspendido	Bolsa	25	3,12
	CA2	0154005020	8426871075121	Tirador WC Cadenilla "Pro" Aluminio Anodizado - Longitud 800 mm Compatibilidad: Universal: Todas las cisternas de tanque alto o suspendido	Bolsa	20	5,65
	PA27	0154007020	8426871007290	Palanca WC "PA27" Hierro Galvanizado - Longitud 275 mm Compatibilidad: Universal: Todas las cisternas de tanque alto o suspendido	Granel	25	1,23
	PA30	0154007030	8426871007306	Palanca WC "PA30" Hierro Galvanizado - Longitud 300 mm Compatibilidad: Universal: Todas las cisternas de tanque alto o suspendido	Granel	25	1,14







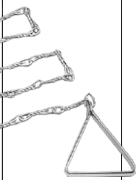
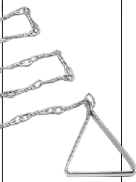

IMAGEN	MOD.	REF.	EAN	DESCRIPCIÓN	PACK		PVP
	HA1	0154004010	8426871007238	Ganchillo reposición en Acero Inoxidable Ø2 x 134 mm Compatibilidad: Descargadores: DC62 - DC71 - DC72 - DC74 - DC261 - DC262	Grael	25	0,44
	HA2	0154004020	8426871007245	Ganchillo reposición en Acero Inoxidable Ø2 x 166 mm Compatibilidad: Descargadores: DC251 - DC252 - DC254	Grael	25	0,44
	TU7	0154002010	8426871007177	Tubo Rebosadero "TU7" Latón con Tope de Caucho -Ø7x165 mm Compatibilidad: Descargadores: DC71 - DC72	Grael	25	1,04
	TU12	0154002020	8426871007184	Tubo Rebosadero "TU12" Latón con Tope de Caucho -Ø12x175 mm Compatibilidad: Descargadores: DC251 - DC252	Grael	25	2,03
	TU5	0154002030	8426871007191	Tubo Rebosadero "TU5" Latón con Tope de Caucho -Ø5x165 mm Compatibilidad: Descargadores: DC62 - DC261 - DC262	Grael	25	1,15
	TP1	0154564010	8426871007375	Tornillo de Fijación Palanca a Cisterna Alta Hierro Galvanizado - Tornillo + Arandelas (2 Uds.) + Tuerca Compatibilidad: Universal: Todas las cisternas de tanque alto o suspendido	Grael	100	0,35
	TP2	0154564030	8426871034098	Kit Sujeción Palanca y Cisterna Alta Tornillos (2 Uds.) + Tacos (2 Uds.) + Escarpas (2 Uds.) Compatibilidad: Universal: Todas las cisternas de tanque alto o suspendido	Bolsa	50	1,23
	TA1	0153600010	8426871007108	Tapa Inodoro Básica Polipropileno Blanco	Bolsa	12	13,46
	TA2	0153600020	8426871007115	Tapa Inodoro Especial ABS Blanco Compatibilidad:	Caja	10	31,43
	TO2	0153564010	8426871007085	Tornillo Cabeza Redonda (1 Ud.) Poliamida PA6	Grael	50	1,30

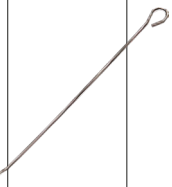
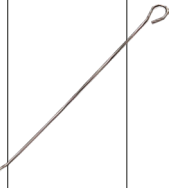
IMAGEN	MOD.	REF.	EAN	DESCRIPCIÓN	PACK		PVP
	BI1	0154067010	8426871007368	Bajante en dos piezas de Diámetro 32 x 175 cm PVC Blanco	Granel	10	7,69
	EG1	0154043020	8426871007320	Conexión de bajante a inodoro. Especial LUCERNA Ø25-30/53 mm Enchufe de Caucho Natural - Compatible LUCERNA Compatibilidad: Cisternas Modelo Lucerna de Roca*	Granel	25	1,48
	EG2	0154043030	8426871007337	Conexión de bajante a inodoro. Especial VICTORIA Ø25/63 mm Enchufe de Caucho Natural - Compatible VICTORIA Compatibilidad: Cisternas Modelo Victoria de Roca*	Granel	25	1,54
	EG3	0154043010	8426871007313	Conexión de bajante a inodoro. Especial PENINSULAR Ø28/53 mm Enchufe de Caucho Natural - Compatible PENINSULAR Compatibilidad: Cisternas Modelo Peninsular de Roca*	Granel	25	1,32
	R1	0154006010	8426871007269	Racor en latón liso para soldar a tubo de Plomo Racor liso D.32 CuZnPb	Granel	25	1,26
	PE5	0158001100	8426871007535	Pulsador Empotrado ABS Cromado + Tubo conexión Compatibilidad: Mecanismos: DC52 - D5M	Caja	10	11,81
	CJP	0158002300	8426871039741	Cajetín Pulsador Empotrado PS/SBR Compatibilidad: Adaptable: PE5	Granel	5	2,64
	RT7	0154003010	8426871007207	Goma Tope "RT7" EPDM Caucho Sintético - Para Rebosadero Ø7 mm Compatibilidad: Descargadores: DC71 - DC72	Granel	100	0,29
	RT12	0154003020	8426871007214	Goma Tope "RT12" EPDM Caucho Sintético - Para Rebosadero Ø12 mm Compatibilidad: Descargadores: DC251 - DC252	Granel	100	0,29
	RT5	0154003030	8426871007221	Goma Tope "RT5" EPDM Caucho Sintético - Para Rebosadero Ø5 mm Compatibilidad: Descargadores: DC62 - DC261 - DC262	Granel	100	0,29

IMAGEN	MOD.	REF.	EAN	DESCRIPCIÓN	PACK		PVP
	RO6	0154001010	8426871007139	Goma Obturadora "RO6" EPDM Caucho Sintético - Ø5 x 28 mm Compatibilidad: Descargadores: DC5 - DC62	Granel	100	0,71
	RO7	0154001020	8426871007146	Goma Obturadora "RO7" EPDM Caucho Sintético - Ø7 x 44 mm Compatibilidad: Descargadores: DC71 - DC72 - DC74	Granel	100	0,71
	RO25	0154001030	8426871007153	Goma Obturadora "RO25" EPDM Caucho Sintético - Ø12 x 49 mm Compatibilidad: Descargadores: DC251 - DC252 - DC254	Granel	100	0,71
	RO26	0154001040	8426871007160	Goma Obturadora "RO26" EPDM Caucho Sintético - Ø5 x 44 mm Compatibilidad: Descargadores: DC261 - DC262	Granel	100	0,71
	ME16E	0114001291	8426871001755	Membrana Caldera-Calentador a gas "ME16E" Membrana Mod. Corbero	Granel	12	1,23
	JA1	0154006020	8426871007276	Junta para la Tuerca Polipropileno Blanco - 55x39x3	Granel	50	0,29
	JA2	0154050010	8426871007344	Junta para la Base Caucho Celular Negro - 55x35x10	Granel	50	0,53
	JA3	0154051010	8426871007351	Junta Cónica para la Bajante PVC Transparente - 30x35x8	Granel	50	0,41
	T1	0114002011	8426871001793	Tope Flotador Ciego de Ø9 x 5 Grosor	Bolsa	100	0,21
	T2	0114002021	8426871001809	Tope Flotador Ciego de Ø10 x 5 Grosor	Bolsa	100	0,21
	T3	0114002031	8426871001816	Tope Flotador Ciego de Ø13 x 5 Grosor	Bolsa	100	0,21
	T4	0114002041	8426871001823	Tope Flotador Ciego de Ø14 x 5 Grosor	Bolsa	100	0,22
	T5	0114002051	8426871001830	Tope Flotador Ciego de Ø15 x 5 Grosor	Bolsa	100	0,22
	T6	0114002061	8426871001847	Tope Flotador Ciego de Ø16 x 5 Grosor	Bolsa	100	0,22
	T7	0114002071	8426871001854	Tope Flotador Ciego de Ø17 x 5 Grosor	Bolsa	100	0,23





IMAGEN	MOD.	REF.	EAN	DESCRIPCIÓN	PACK		PVP
	S1	0114003012	8426871001861	Soleta Cierre Grifo Ø Exterior 13	Bolsa	100	0,22
	S2	0114003022	8426871001878	Soleta Cierre Grifo Ø Exterior 14	Bolsa	100	0,22
	S3	0114003032	8426871001885	Soleta Cierre Grifo Ø Exterior 15	Bolsa	100	0,22
	S4	0114003042	8426871001892	Soleta Cierre Grifo Ø Exterior 16	Bolsa	100	0,23
	S5	0114003052	8426871001908	Soleta Cierre Grifo Ø Exterior 17	Bolsa	100	0,23
	S6	0114003062	8426871001915	Soleta Cierre Grifo Ø Exterior 20	Bolsa	100	0,28
	S7	0114003072	8426871001922	Soleta Cierre Grifo Ø Exterior 25	Bolsa	100	0,32
	S8	0114003082	8426871001939	Soleta Cierre Grifo Ø Exterior 30	Bolsa	100	0,60
	EC1	0114004011	8426871001946	Enlace Cónico Ø 10 x 3/8" (15) para Tubo Ø 8/10	Bolsa	100	0,22
	EC2	0114004021	8426871001953	Enlace Cónico Ø 10 x 1/2" (18) para Tubo Ø 8/10	Bolsa	100	0,23
	EC3	0114004031	8426871001960	Enlace Cónico Ø 12 x 1/2" (18) para Tubo Ø 10/12	Bolsa	100	0,23
	EC4	0114004041	8426871001977	Enlace Cónico Ø 14 x 1/2" (18) para Tubo Ø 12/14	Bolsa	100	0,25
	JPT1	0114005015	8426871100687	Arandela Plana 3/8" Ancha (Ø Int. 8xØ Ext. 15x1,5)	Bolsa	100	0,34
	JPT2	0114005025	8426871100731	Arandela Plana 3/8" Estrecha (Ø Int. 10xØ Ext. 15x1,5)	Bolsa	100	0,34
	JPT3	0114005035	8426871100700	Arandela Plana 1/2" Ancha (Ø Int. 11xØ Ext. 18x1,5)	Bolsa	100	0,35
	JPT4	0114005045	8426871100717	Arandela Plana 1/2" Racor Loco (Ø Int. 14xØ Ext. 19x1,5)	Bolsa	100	0,34
	JPT5	0114005055	8426871100724	Arandela Plana 3/4" Ancha (Ø Int. 13,5xØ Ext. 23x1,5)	Bolsa	100	0,36
	JPT6	0114005065	8426871100748	Arandela Plana 3/4" Estrecha (Ø Int. 18xØ Ext. 24x1,5)	Bolsa	100	0,36
	JPT7	0114005075	8426871100755	Arandela Plana 7/8" Estrecha (Ø Int. 22xØ Ext. 27x1,5)	Bolsa	100	0,38
	JPT8	0114005085	8426871100793	Arandela Plana 1" Ancha (Ø Int. 20xØ Ext. 30x1,5)	Bolsa	100	0,39
	JPT9	0114005095	8426871100779	Arandela Plana 1" Estrecha (Ø Int. 24,2xØ Ext. 30x1,5)	Bolsa	100	0,39
	JPT10	0114005105	8426871100786	Arandela Plana 1" 1/4 (Ø Int. 30xØ Ext. 39x1,5)	Bolsa	50	0,50
	JPT11	0114005115	8426871100809	Arandela Plana 1" 1/2 (Ø Int. 37xØ Ext. 45x1,5)	Bolsa	50	0,61
	JPT12	0114005125	8426871100816	Arandela Plana 2" (Ø Int. 46xØ Ext. 57x1,5)	Bolsa	50	0,79
	JC1	0114007013	8426871002561	Junta Cónica 3/8" (Ø Int. 15 x Ø Ext. 56 x 14 espesor)	Bolsa	25	1,67
	JC2	0114007023	8426871002578	Junta Cónica 1/2" (Ø Int. 20 x Ø Ext. 56 x 14 espesor)	Bolsa	25	0,91
	JC3	0114007033	8426871002585	Junta Cónica 3/4" (Ø Int. 24 x Ø Ext. 56 x 14 espesor)	Bolsa	25	0,94
	JC4	0114007043	8426871002592	Junta Cónica 1" (Ø Int. 28 x Ø Ext. 56 x 14 espesor)	Bolsa	25	0,94
	JM1	0114008033	8426871100625	Junta 1/2" (Ø Int. 20 x Ø Ext. 56 x 6)	Bolsa	25	0,87
	JM2	0114008043	8426871100632	Junta 3/4" (Ø Int. 24 x Ø Ext. 56 x 6)	Bolsa	25	0,87
	JM3	0114008053	8426871100649	Junta 1" (Ø Int. 27 x Ø Ext. 56 x 6)	Bolsa	25	0,87
	JM4	0114008013	8426871002608	Junta Bidet 1 1/4" (Ø Int. 33 x Ø Ext. 65)	Bolsa	25	1,09
	JM5	0114008023	8426871002615	Junta Fregadero 1 1/2" (Ø Int. 39 x Ø Ext. 64)	Bolsa	25	0,66
	JM6	0114008063	8426871100663	Junta Bañera 1 1/2" (Ø Int. 39 x Ø Ext. 64)	Bolsa	25	1,58
	JM7	0114008073	8426871100670	Junta 2" (Ø Int. 56 x Ø Ext. 81 x 8,5)	Bolsa	25	1,53

IMAGEN	MOD.	REF.	EAN	DESCRIPCIÓN	PACK		PVP
	J1	0114006011	8426871002059	Junta Plana 1/4" (ØInt. 8xØExt. 12)	Bolsa	100	0,21
	J2	0114006021	8426871002073	Junta Plana 3/8" (ØInt. 8xØExt. 14,5)	Bolsa	100	0,21
	J3	0114006031	8426871002097	Junta Plana 3/8" (ØInt. 10xØExt. 14)	Bolsa	100	0,21
	J4	0114006041	8426871002110	Junta Plana 3/8" (ØInt. 10xØExt. 15)	Bolsa	100	0,21
	J5	0114006051	8426871002134	Junta Plana 1/2" (ØInt. 10xØExt. 19)	Bolsa	100	0,21
	J6	0114006061	8426871002158	Junta Plana 1/2" (ØInt. 11xØExt. 18)	Bolsa	100	0,22
	J7	0114006071	8426871002172	Junta Plana 1/2" (ØInt. 11xØExt. 19)	Bolsa	100	0,22
	J8	0114006081	8426871002196	Junta Plana 1/2" (ØInt. 12xØExt. 18)	Bolsa	100	0,22
	J9	0114006091	8426871002219	Junta Plana 1/2" Racor Cobre (ØInt. 13xØExt. 18)	Bolsa	100	0,21
	J10	0114006101	8426871002233	Junta Plana 3/4" (ØInt. 13xØExt. 24)	Bolsa	100	0,23
	J11	0114006111	8426871002257	Junta Plana 1/2" (ØInt. 14xØExt. 18)	Bolsa	100	0,21
	J12	0114006121	8426871002271	Junta Plana 5/8" (ØInt. 15xØExt. 21)	Bolsa	100	0,23
	J13	0114006131	8426871002295	Junta Plana 3/4" Racor Gas(ØInt. 16xØExt. 23)	Bolsa	100	0,23
	J14	0114006141	8426871002318	Junta Plana 3/4" (ØInt. 16xØExt. 24)	Bolsa	100	0,25
	J15	0114006151	8426871002332	Junta Plana 3/4" R. Gas Cobre (ØInt. 18xØExt. 23)	Bolsa	100	0,23
	J16	0114006161	8426871002356	Junta Plana 7/8" R. Gas (ØInt. 22xØExt. 27)	Bolsa	100	0,26
	J17	0114006171	8426871002370	Junta Plana 1" R. Gas Cobre (ØInt. 23xØExt. 29)	Bolsa	100	0,26
	J18	0114006181	8426871002394	Junta Plana 1" R. Gas (ØInt. 23xØExt. 30)	Bolsa	100	0,23
	J20	0114006211	8426871002455	Junta Plana 1 1/4" (ØInt. 32xØExt. 38)	Bolsa	100	0,38
	J21	0114006221	8426871002479	Junta Plana 1 1/2" (ØInt. 36xØExt. 44)	Bolsa	100	0,48
	J22	0114006241	8426871002516	Junta Plana 2" (ØInt. 47xØExt. 54)	Bolsa	100	0,65
	J23	0114006251	8426871002530	Junta Plana 1" (ØInt. 20xØExt. 30)	Bolsa	100	0,27
		JK1	0114006014	8426871002066	Junta Plana 1/4" (ØInt. 8xØExt. 12)	Bolsa	100
JK2		0114006024	8426871002080	Junta Plana 3/8" (ØInt. 8xØExt. 14,5)	Bolsa	100	0,21
JK3		0114006034	8426871002103	Junta Plana 3/8" (ØInt. 10xØExt. 14)	Bolsa	100	0,21
JK4		0114006044	8426871002127	Junta Plana 3/8" (ØInt. 10xØExt. 15)	Bolsa	100	0,21
JK5		0114006054	8426871002141	Junta Plana 1/2" (ØInt. 10xØExt. 19)	Bolsa	100	0,21
JK6		0114006064	8426871002165	Junta Plana 1/2" (ØInt. 11xØExt. 18)	Bolsa	100	0,22
JK7		0114006074	8426871002189	Junta Plana 1/2" (ØInt. 11xØExt. 19)	Bolsa	100	0,22
JK8		0114006084	8426871002202	Junta Plana 1/2" (ØInt. 12xØExt. 19)	Bolsa	100	0,22
JK9		0114006094	8426871002226	Junta Plana 1/2" Racor Cobre (ØInt. 13xØExt. 18)	Bolsa	100	0,21
JK10		0114006104	8426871002240	Junta Plana 3/4" (ØInt. 13xØExt. 23)	Bolsa	100	0,23
JK11		0114006114	8426871002264	Junta Plana 1/2" (ØInt. 14xØExt. 18)	Bolsa	100	0,21
JK12		0114006124	8426871002288	Junta Plana 5/8" (ØInt. 15xØExt. 20)	Bolsa	100	0,23
JK13		0114006134	8426871002301	Junta Plana 3/4" Racor Gas(ØInt. 16xØExt. 23)	Bolsa	100	0,23
JK14		0114006144	8426871002325	Junta Plana 3/4" (ØInt. 16xØExt. 24)	Bolsa	100	0,25
JK15		0114006154	8426871002349	Junta Plana 3/4" R. Gas Cobre (ØInt. 18xØExt. 23)	Bolsa	100	0,23
JK16		0114006164	8426871002363	Junta Plana 7/8" R. Gas (ØInt. 22xØExt. 27)	Bolsa	100	0,26
JK17		0114006174	8426871002387	Junta Plana 1" R. Gas Cobre (ØInt. 23xØExt. 30)	Bolsa	100	0,26
JK18		0114006184	8426871002400	Junta Plana 1" R. Gas (ØInt. 24xØExt. 30)	Bolsa	100	0,23
JK19		0114006264	8426871002554	Junta Plana 1" (ØInt. 24xØExt. 30)	Bolsa	100	0,26
JK20		0114006214	8426871002462	Junta Plana 1 1/4" (ØInt. 32xØExt. 38)	Bolsa	100	0,38
JK21		0114006224	8426871002486	Junta Plana 1 1/2" (ØInt. 36xØExt. 44)	Bolsa	100	0,48
JK22		0114006244	8426871002523	Junta Plana 2" (ØInt. 47xØExt. 54)	Bolsa	100	0,65
JK23		0114006254	8426871002547	Junta Plana 1" (ØInt. 20xØExt. 30)	Bolsa	100	0,27

CSA 28
Klingerit

IMAGEN	MOD.	REF.	EAN	DESCRIPCIÓN	PACK		PVP
	JT1	0114009011	8426871002622	Tórica 1/2" (10x16x3) - Para Tubo de 8/10 - 3/8"	Bolsa	100	0,21
	JT2	0114009021	8426871002639	Tórica 1/2" (10x19x4,5) - Para Tubo de 8/10 - 1/2"	Bolsa	100	0,23
	JT3	0114009031	8426871002646	Tórica 1/2" (12x19x3,5) - Para Tubo de 10/12 - 1/2"	Bolsa	100	0,23
	JT4	0114009041	8426871002653	Tórica 3/4" (16x24x4) - Para Tubo de 14/16 - 3/4"	Bolsa	100	0,28
	JT5	0114009051	8426871002660	Tórica 3/4" (18x24x3) - Para Tubo de 16/18 - 3/4"	Bolsa	100	0,31
	JT6	0114009061	8426871002677	Tórica 1" (22x29x3,5) - Para Tubo de 20/22 - 1"	Bolsa	100	0,30
	JT7	0114009071	8426871002684	Tórica 2,90x1,78	Bolsa	100	0,18
	JT8	0114009081	8426871002691	Tórica 3,68x1,78	Bolsa	100	0,18
	JT9	0114009091	8426871002707	Tórica 4,47x1,78	Bolsa	100	0,18
	JT10	0114009101	8426871002714	Tórica 5,28x1,78	Bolsa	100	0,18
	JT11	0114009111	8426871002721	Tórica 6,07x1,78	Bolsa	100	0,18
	JT12	0114009121	8426871002738	Tórica 7,65x1,78	Bolsa	100	0,19
	JT13	0114009131	8426871002745	Tórica 9,25x1,78	Bolsa	100	0,19
	JT14	0114009141	8426871002752	Tórica 9,19x2,62	Bolsa	100	0,21
	JT15	0114009151	8426871002769	Tórica 10,77x2,62	Bolsa	100	0,21
	JT16	0114009161	8426871002776	Tórica 12,37x2,62	Bolsa	100	0,21
	JT17	0114009171	8426871002783	Tórica 13,95x2,62	Bolsa	100	0,22
	JT18	0114009181	8426871002790	Tórica 15,54x2,62	Bolsa	100	0,23
	JT19	0114009191	8426871002806	Tórica 17,12x2,62	Bolsa	100	0,23
	JT20	0114009201	8426871002813	Tórica 18,72x2,62	Bolsa	100	0,23
	JT21	0114009211	8426871002820	Tórica 18,64x3,53	Bolsa	100	0,28
	JT22	0114009221	8426871002837	Tórica 20/22x3,53	Bolsa	100	0,28
	JT23	0114009231	8426871002844	Tórica 21,82x3,53	Bolsa	100	0,30
	JT24	0114009241	8426871002851	Tórica 23,39x3,53	Bolsa	100	0,31
	JT25	0114009251	8426871002868	Tórica 24,99x3,53	Bolsa	100	0,32
	JT26	0114009261	8426871002875	Tórica 26,57x3,53	Bolsa	100	0,34
	JT27	0114009271	8426871002882	Tórica 28,17x3,53	Bolsa	100	0,34
	JT28	0114009281	8426871002899	Tórica 29,74x3,53	Bolsa	100	0,35
	JT29	0114009291	8426871002905	Tórica 31,34x3,53	Bolsa	100	0,36
	JT30	0114009301	8426871002912	Tórica 32,92x3,53	Bolsa	100	0,38
	JT31	0114009311	8426871002929	Tórica 34,52x3,53	Bolsa	100	0,40
	JT32	0114009321	8426871002936	Tórica 36,09x3,53	Bolsa	100	0,40
	JT33	0114009331	8426871002943	Tórica 37,69x3,53	Bolsa	100	0,43
	JT34	0114009341	8426871002950	Tórica 37,47x5,33	Bolsa	100	0,70
	JT35	0114009351	8426871002967	Tórica 40,64x5,33	Bolsa	100	0,70
	JT36	0114009361	8426871002974	Tórica 43,81x5,33	Bolsa	100	0,71



Despiece Caja K2

IMAGEN	MOD.	REF.	EAN	DESCRIPCIÓN	PACK		PVP
	A1	0114005013	8426871001984	Arandela Plana 3/8" (ØInt. 16xØExt. 30)	Bolsa	50	0,25
	A2	0114005023	8426871001991	Arandela Plana 1/2" (ØInt. 20xØExt. 45)	Bolsa	50	0,26
	A3	0114005033	8426871002004	Arandela Plana 3/4" (ØInt. 25xØExt. 62)	Bolsa	50	0,34
	A4	0114005043	8426871002011	Arandela Plana 1" (ØInt. 30xØExt. 70)	Bolsa	50	0,35
	A5	0114005053	8426871002028	Arandela Plana 1 1/4" (ØInt. 36xØExt. 67)	Bolsa	50	0,34
	A6	0114005063	8426871002035	Arandela Plana 1 1/2" (ØInt. 40xØExt. 77)	Bolsa	50	0,40
	Caucho Blanco	A7	0114005073	8426871002042	Arandela Fregadero (ØInt. 46xØExt. 70)	Bolsa	50
	JR1	0114006281	8426871034319	Junta para radiador 1" (32,5x42,5x1.5)	Bolsa	100	0,41
	JR3	0114006291	8426871100823	Junta para radiador 1" (32,5x42,5x1)	Bolsa	100	0,38
	JR2	0114006284	8426871034326	Junta para radiador 1" (32,5x42,5x1.5)	Bolsa	100	0,40
	CSA-25	JR4	0114006294	8426871100830	Junta para radiador 1" (32,5x42,5x1)	Bolsa	100
	JCS1	0114007101	8426871100847	Junta Cónica para Sifón Plástico (ØInt. 32x1" 1/4)	Bolsa	50	0,54
	JCS2	0114007111	8426871100854	Junta Cónica para Sifón Plástico (ØInt. 32x1" 1/2)	Bolsa	50	0,54
	JCS3	0114007121	8426871100861	Junta Cónica para Sifón Plástico (ØInt. 40x1" 1/2)	Bolsa	50	0,54
	JFS1	0114011011	8426871100878	Junta Sombrerete con Filtro INOX. 3/8" (ØInt. 10xØExt. 15x1,8)	Bolsa	25	0,71
	JFS2	0114011021	8426871100885	Junta Sombrerete con Filtro INOX. 1/2" (ØInt. 14,4xØExt. 18x2,5)	Bolsa	25	0,80
	JFS3	0114011031	8426871100892	Junta Sombrerete con Filtro INOX. 3/4" (ØInt. 17,5xØExt. 24x3,2)	Bolsa	25	0,82
	JFP1	0114012011	8426871100908	Junta Plana con Filtro INOX. 3/8" (ØInt. 10xØExt. 15x1,8)	Bolsa	25	0,71
	JFP2	0114012021	8426871100915	Junta Plana con Filtro INOX. 1/2" (ØInt. 14,4xØExt. 18x2,5)	Bolsa	25	0,80
	JFP3	0114012031	8426871100922	Junta Plana con Filtro INOX. 3/4" (ØInt. 17,5xØExt. 24x3,2)	Bolsa	25	0,82
	K1	0114010021	8426871002998	Caja Tóricas 1.470 Unidades varios tamaños	Caja	1	74,79
	K2	0114010031	8426871003001	Caja Tóricas 382 Unidades varios tamaños Ver despiece en página anterior	Caja	1	46,23
	K3	0114010011	8426871002981	Caja Especial para Fontanería 715 Unidades varios tamaños	Caja	1	76,60
	K4	0114010041	8426871003018	Caja Arandelas Planas de Caucho 925 Unidades varios tamaños	Caja	1	85,88
	K5	0114010054	8426871003025	Caja Arandelas Planas de CSA-28 925 Unidades varios tamaños	Caja	1	85,88

fominaya[®]
Original *Since 1939*



Ctra. del Pla, s/n • Apdo. Correos, 62
46117 Bétera • Valencia • Spain
N° 39,59831 • W° 0,45501
T. +34 961 600 651 • F. +34 961 601 351
correo@fominaya.com
www.fominaya.com

