

EIDER BIOMASA

JUNIO
2024



EIDER BIOMASA

Aportando calor a su hogar desde 1934

Contenido

Novedades	3
New Products / Novos produtos	
Censat	4
Iconografía	6
Icons / Ícones	
Estufas de Pellets de Aire	7
Pellet stoves / Salamandras a pellets	
Estufas de Pellets Canalizadas	19
Ducted / Dutados	
Estufas de Pellets Hidro y Calderas	25
Hydro and Boilers / Hydro e Caldeiras	
Estufas de Leña	32
Wood fireplaces / Salamandras a lenha	
Estufas de Leña en Fundición	38
Cast Iron / De Ferro Fundido	
Estufas de Leña Ventiladas	41
Ventilated / Ventilados	
Insertables de Leña	46
Inserts/Insert	
Estufas de Leña Hidro y Calderas	51
Hydro and Boilers / Hydro e Caldeiras	
Lista de Precios	54
Price List / Lista de preços	
Fumistería, Combustibles y accesorios	60
Stove pipes, Fuels, etc. / Fumisteria, Combustíveis, etc.	

BLOQUES DE VAPOR DE AGUA

NOVEDAD

- Bloques de Vapor de Agua con llama efecto 3D.
- Efecto humidificador.
- Con capacidad de ajustar el color a 7 tonalidades distintas
- No emiten ningún tipo de calor



BLOQUE DE VAPOR DE AGUA 70cm ESV642001

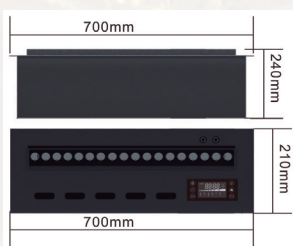

- .Consumo eléctrico: 220 V 160W
- Frecuencia: 50/60Hz
- Capacidad del tanque de agua: 4 l.
- Autonomía: 4 horas

BLOQUE DE VAPOR DE AGUA 100cm ESV642002

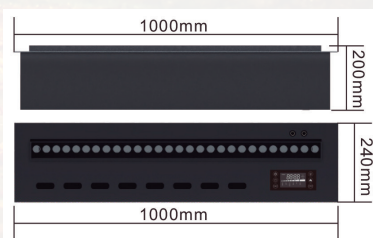

- .Consumo eléctrico: 220 V 200W
- Frecuencia: 50/60Hz
- Capacidad del tanque de agua: 5 l.
- Autonomía: 4 horas

BLOQUE DE VAPOR DE AGUA 150cm ESV642003

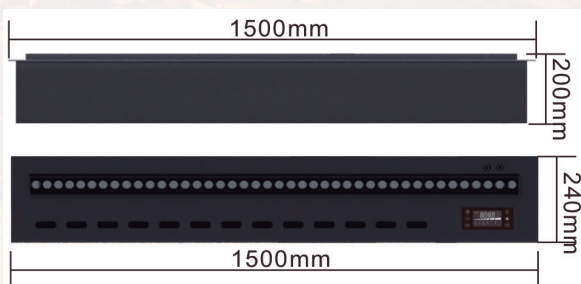

- .Consumo eléctrico: 220 V 360W
- Frecuencia: 50/60Hz
- Capacidad del tanque de agua: 5 l.
- Autonomía: 4 horas

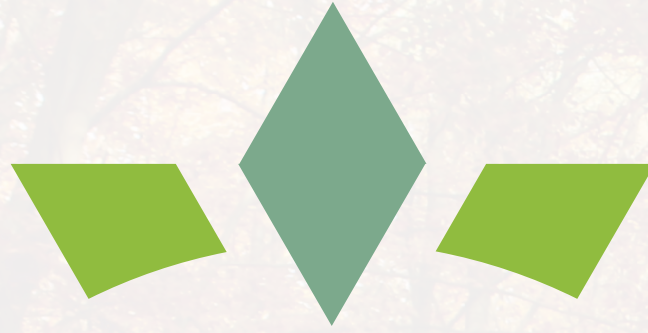

Censat

CENTRAL NACIONAL DE ASISTENCIA TÉCNICA

Servicio de Asistencia Técnica Postventa CENSAT

Durante la vida útil de nuestros equipos, queremos que los usuarios disfruten de los mejores servicios de garantía y asistencia. Nuestra gestión de esos servicios está centralizada en Eider a través de CENSAT. Un colectivo de más de 250 puntos de asistencia en todo el territorio a los que procuramos formación permanente.

Desde nuestra central controlamos y gestionamos todas las acciones necesarias para la puesta en marcha, garantías o reparaciones de todos nuestros productos en tiempo real, actuando en caso de carencias sobrevenidas en cualquier parte. Suministramos por mensajería urgente todos los repuestos y componentes de la manera más rápida posible.

Este servicio es único en su concepción y desarrollo, se ha ido depurando y mejorando a lo largo de los años, incorporándole nuevas herramientas informáticas y de soporte para hacerlo lo más eficaz posible.

Censat es un canal de prestaciones, comunicación y soporte postventa con los clientes y usuarios, desarrollado para poder responder a cualquier necesidad de asistencia técnica, petición de distintas informaciones o consultas, que está a su servicio.

www.censat.es

ESTUFAS + TECNOLOGÍA

TU EQUIPO AL ALCANCE DE TU MANO

Controla y regula la temperatura de tu equipo desde tu teléfono móvil con el módulo WiFi compatible para tu estufa o caldera, siempre que se disponga de acceso a internet.



Google Home



ICONOGRAFÍA DATOS TÉCNICOS



Potencia Global
Global Power
Potência Total

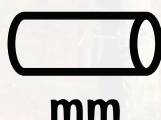

Salida de Humos
Diameter of Chimney
Diâmetro de Chaminé



Potencia Nominal
Nominal Power
Potência Nominal



Capacidad Tolva
Fuel Loading Capacity
Capacidade de carregamento



Rendimiento
Efficiency
Rendimento



Consumo Horario
Hourly Consumption
Consumo por Hora



Alimentación Eléctrica
Power Supply
Alimentação elétrica



Peso
Weight
Peso



Volumen Calefactable
Heatable Volume
Volume Aquecível



Alto / High / Alto
Profundo / Deep / Profundidade
Ancho / Width / Largo

FUNCIONALIDADES PELLETS



Encendido rápido.

El encendido eficaz y rápido es una garantía de fiabilidad y ahorro de energía consumida.



Canalización de Aire Caliente.

La mejor opción para calentar varias estancias con una sola estufa, canalizar a voluntad cuanto se quiera del aire caliente.



Programable semanal y diariamente.

Programador integrado que permite apagados y encendidos en horarios diferentes y distintos días de la semana.

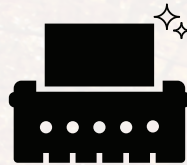

Sistema de autolimpieza del quemador.

Quemador autolimpiante de manera automática, que minimiza la necesidad de limpieza y facilita una mejor conservación.



Sistemas de seguridad activa.

Protegemos los equipos con sistemas antideflagración, control de carga, estanqueidad de los componentes y otros para garantizar una protección integral.

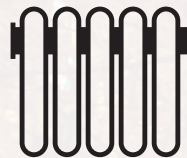

Calefacción Central.

Sistema de calefacción al agua para radiadores o suelo radiante.



Protección por sobrecarga eléctrica.

Protegemos nuestros productos ante eventuales alteraciones del suministro eléctrico que podrían dañar la electrónica de la pieza.



Válvula de anticondensados incluida.

Incluye válvula anti-retorno para evitar condensación en el equipo.



Easy Clean.

Fácil limpieza del producto para hacerlo más cómodo y accesible.



Limpieza de tubuladores automática.

De manera automática, los turbuladores del intercambiador de calor quedarán limpios siempre sin ningún esfuerzo.



Sistema de cristal limpio.

Una cortina de aire mantendrá el cristal sin impurezas ni inquemados que ensucian la visión del fuego.



Limpieza de tubuladores semiautomática.

Una simple maniobra permite la limpieza del intercambiador de calor para mantener siempre su óptimo rendimiento.



Brasero en Fundición

La fundición de hierro aporta la prestancia de las cosas bien hechas, robustas y duraderas.

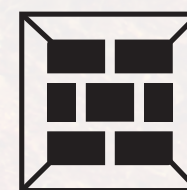

Cámara de combustión refractaria.

Con vermiculita o bricks térmicos conseguimos aumentar la temperatura del hogar, optimizar la combustión y ahorrar en combustible.

FUNCIONALIDADES LEÑA

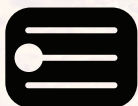

Aire Primario

Primary Air

Ar Primário



Horno

Oven

Forno



Aire Secundario

Secondary Air

Ar Secundário



Ventilada

Ventilated

Ventilado



Partes en Fundición

Cast Iron Parts

Peças Fundidas

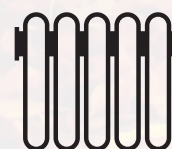

Calefacción Central

Central Heat

Aquecimento Central



PETIT 6



PASILLO 8



ALFA 12



TOSCANA



ESFERA



AUTOLIMPIEZA 12



KING 10



CANADÁ 11

ESTUFAS PELLETS AIRE

Estufa de Pellets

PETIT 6



 CONSULTAR

 CONSULTAR

Referencia
ESA3066





A+

 7,01 kW

 88,5%

 110 m³

 13 kg

 65 kg

 6,2 kW

 220 V

 80 mm

 0,57 - 1,09 kg/h

 77 cm
43 cm
43 cm

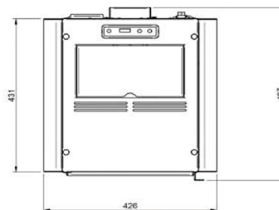
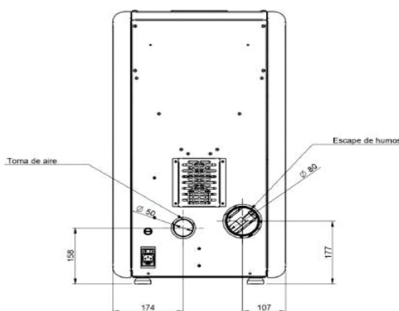
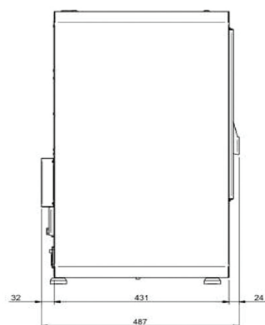
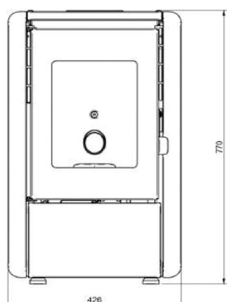
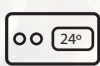

Estufa de Pellets

POWER 8



 RE69001

 RE610002
Wi-Fi

Referencias

ESA61023

ESA61029



A+

 8,74
kW

 90,6%

 150 m³

 15 kg

 81 kg

 7,92
+ kW

 220 V

 80 mm

 0,57 -
1,85

 91 cm
44 cm
43 cm

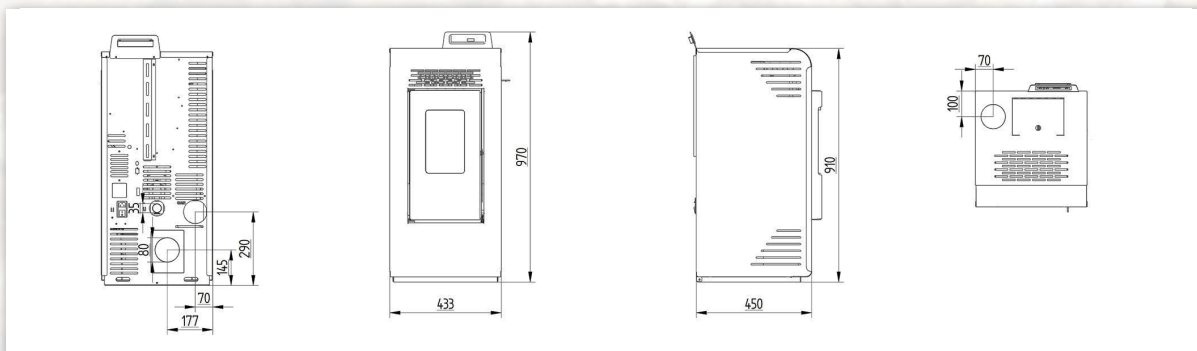

Estufa de Pellets

ESFERA



 RE69001

 RE610002
Wi-Fi

Referencias

ESA61027

ESA61024



A+

 8,74
kW

 90,7%

 150 m³

 15 kg

 91 kg

 7,93
kW

 220 V

 80 mm

 0,57 -
1,80
kg/h

 91 cm
49 cm
52 cm

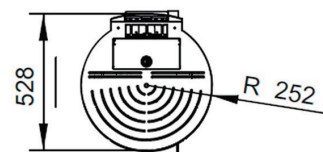
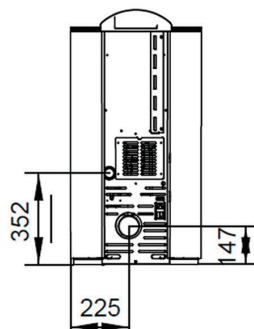
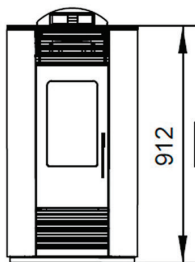

Estufa de Pellets

PASILLO 8 FUTURA



 CONSULTAR

 CONSULTAR

Referencias
ESA67089





A+

 7,85
kW

 90%

 150 m³

 13 kg

 65 kg

 7,06
kW

 220 V

 80 mm

 0,61 - 2,7
kg/h

 91 cm
24 cm
93 cm

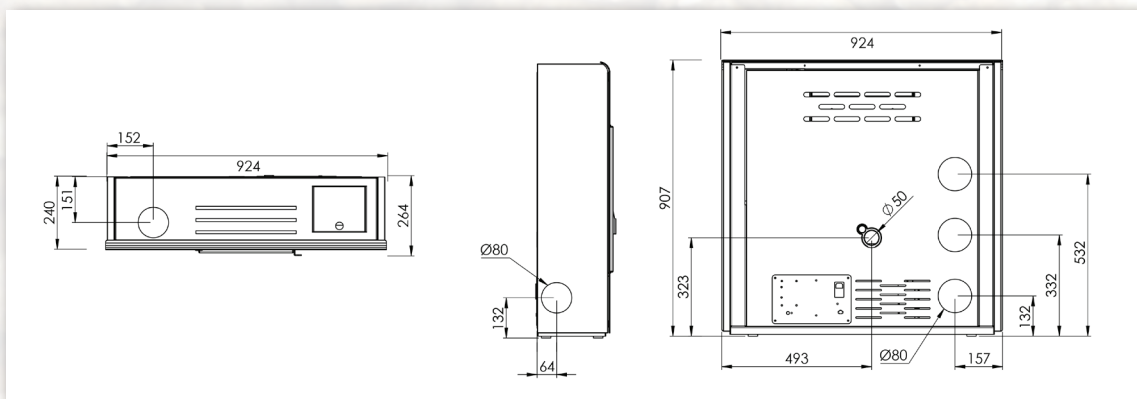

Estufa de Pellets

TOSCANA



 CONSULTAR

 CONSULTAR

Referencia
ESA67064





A+

 10,61
kW

 90%

 200 m³

 15 kg

 95 kg

 9,55
kW

 220 V

 80 mm

 0,90 -
2,06
kg/h

 95 cm
51 cm
52 cm

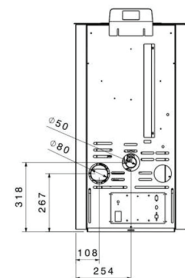
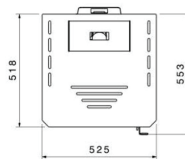
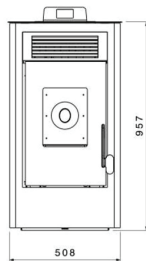
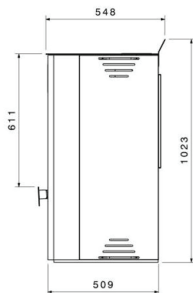

Estufa de Pellets

KING 10



RE69001



RE610002

Referencias

ESA61030

ESA61032



A+

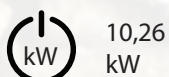

10,26
kW



92,3%



180 m³



15 kg



98 kg



9,47
kW



220 V



80 mm



0,56 -
2,02



94 cm
45 cm
44 cm

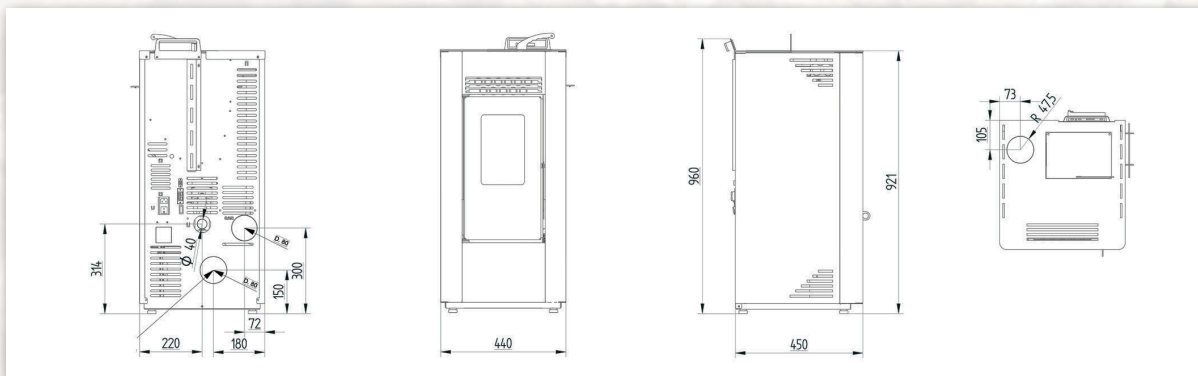

Estufa de Pellets

ALFA 12



 RE104022

 RC104031
Wi-Fi

Referencias

ESA67080

ESA67025



A+

 12,82
kW

 90%

 240 m³

 15 kg

 105 kg

 11,54
kW

 220 V

 80 mm

 0,90 -
2,50
kg/h

 105 cm
51 cm
54 cm

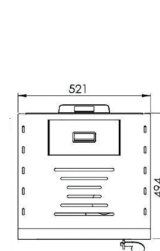
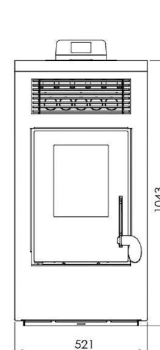
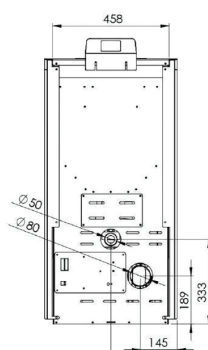
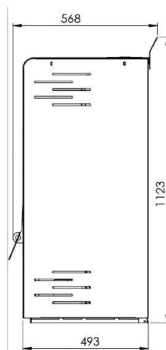

Estufa de Pellets

AUTOLIMPIEZA 12



Referencia
ESA22001





A+

 11,67
kW

 88,1%

 240 m³

 18,5 kg

 113 kg

 10,28
kW

 220 V

 80 mm

 0,90 -
2,06
kg/h

 100 cm
56 cm
50 cm

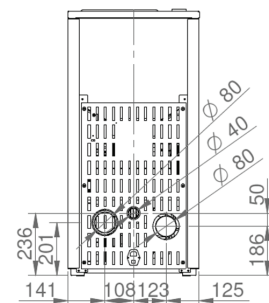
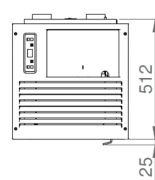
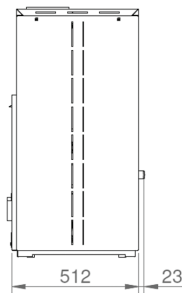
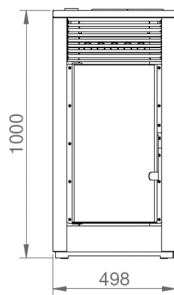

Insertable de Pellets

INSERT 8



 RP138009

 RP138004

Referencia
ESA67082



A+

 7,98 kW

 94%

 175 m³

 13 kg

 50 kg

 7,5 kW

 220 V

 80 mm

 0,6 - 1,8 kg/h

 70 cm
47 cm
58 (+15) cm

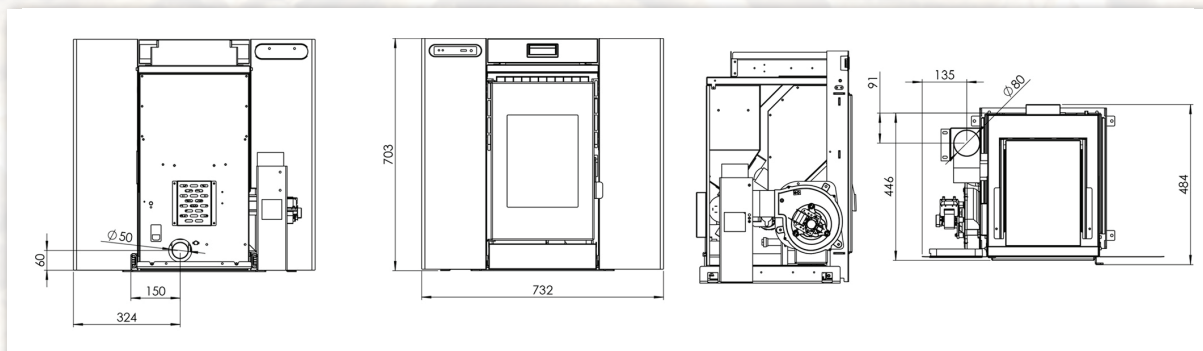

Insertable de Pellets

INSERT CANADÁ 11



 CONSULTAR

 CONSULTAR

Referencia
ESA234001





A+

 10,9
kW

 87%

 200 m³

 13 kg

 87 kg

 9,48
kW

 220 V

 80 mm

 0,57 -
2,20
kg/h

 59 cm
51 cm
72 cm

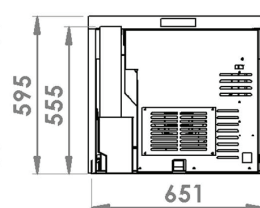
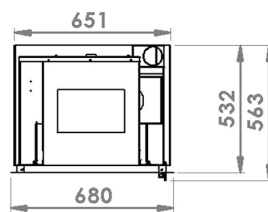
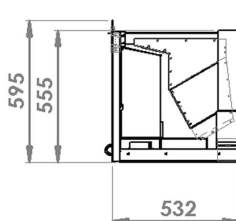
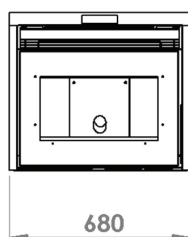

Estufa de Pellets

CERO REM



CERO REM*
ESA67085



CERO REM
VENTILADA
ESA67086



A+

* No necesita corriente eléctrica



11 kW



75%



200 m³



15 kg



120 kg



8,25
kW



220 V



100
mm



1,40 -
1,90
kg/h



97 cm
51 cm
47 cm

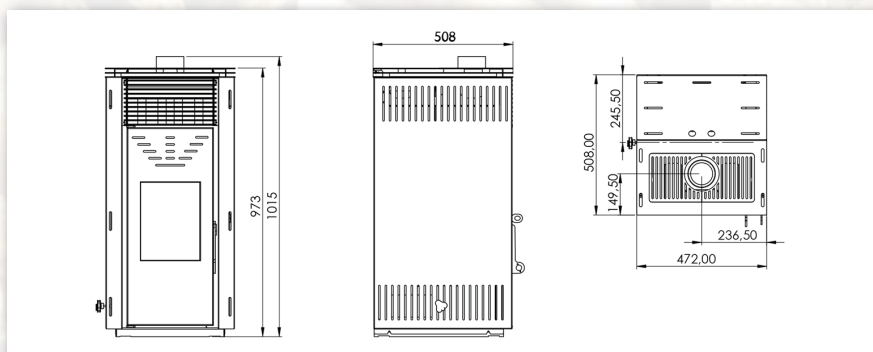



**KING 10
CANALIZADA**



**PASILLO 10
CANALIZADA**



**ENERGY FIRE 15
CANALIZADA**



**TOSCANA
CANALIZADA**



**INSERT 12
CANALIZADA**



**ESTUFAS PELLETS
CANALIZADAS**

Estufa de Pellets Canalizada

KING 10 CANALIZADA

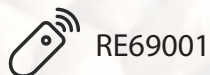

RE69001



RE610002

Referencias

ESC61007

ESC61006

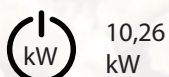

10,26
kW



92,3%



180 m³



15 kg



98 kg



9,47
kW



220 V



80 mm



0,56 -
2,02



93 cm
45 cm
44 cm

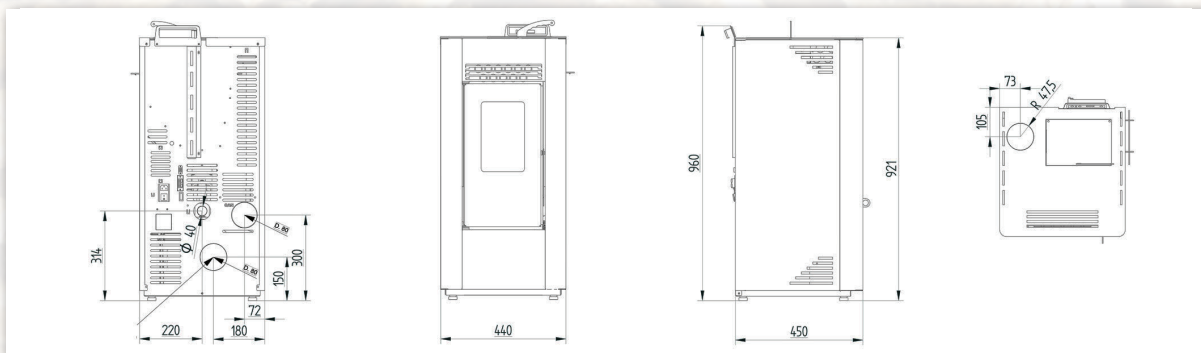
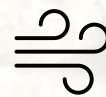

Estufa de Pellets Canalizada

TOSCANA CANALIZADA



Referencia
ESC67014



A+

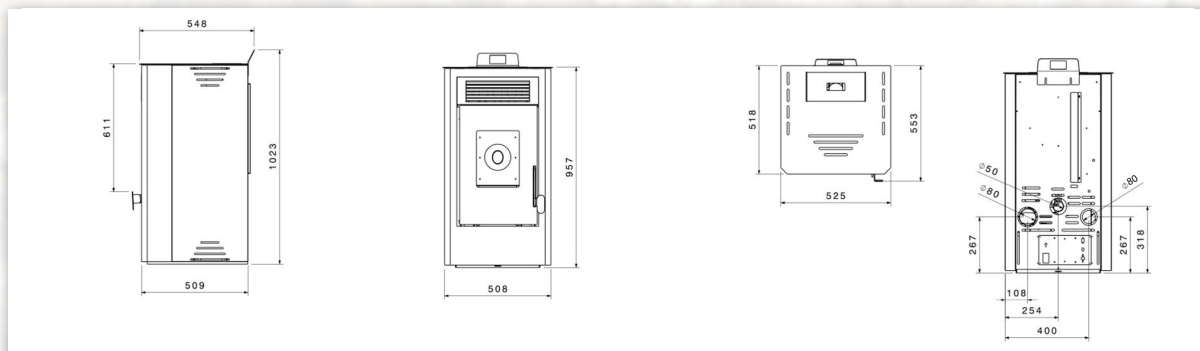
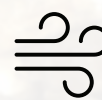
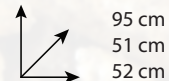
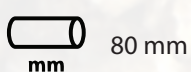
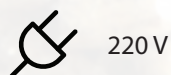
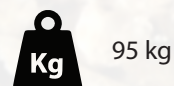
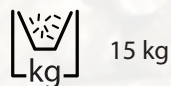
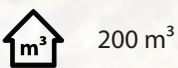
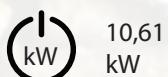

Estufa de Pellets Canalizada

PASILLO 10 CANALIZADA



 RE104022

 RC104031
Wi-Fi

Referencia
ESC67011



A+

 11,12
kW

 90%

 220 m³

 13 kg

 109 kg

 10,01
kW

 220 V

 80 mm

 0,90 -
2,20
kg/h

 102 cm
34 cm
104 cm

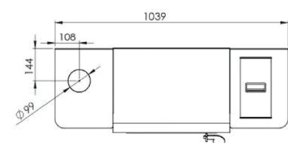
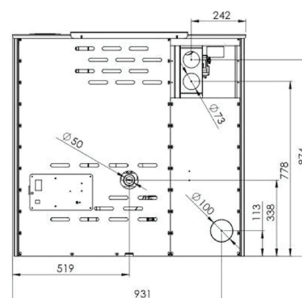
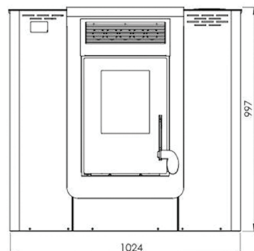
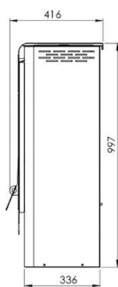
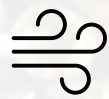
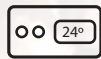

Insertable de Pellets Canalizada

INSERT 12 CANALIZADA



 RE104022

 RC104031
Wi-Fi

Referencia
ESC67002



A+

 13,06
kW

 88,8%

 220 m³

 15 kg

 99 kg

 11,6
kW

 220 V

 80 mm

 0,60 -
1,90
kg/h

 70 cm
70 cm
81 cm

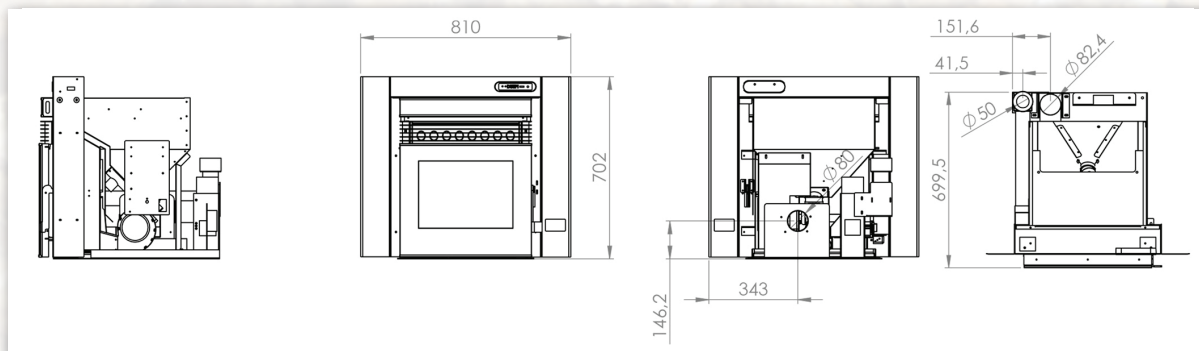
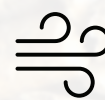

Estufa de Pellets Canalizada

ENERGY FIRE 15 CANALIZADA



 RE104022

 RC104031
Wi-Fi

Referencias

ESC67008

ESC67009

ESC67016





A+

 14,3
kW

 86%

 320 m³

 15 kg

 120 kg

 12,3
kW

 220 V

 80 mm

 0,90 -
2,60

 114 cm
51 cm
54 cm

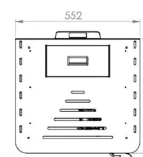
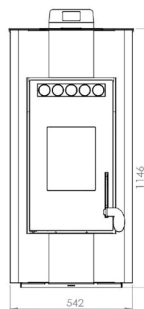
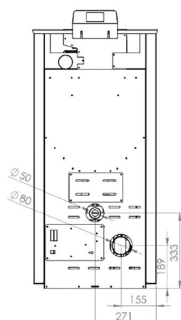
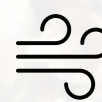
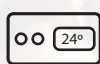



GAIA 16



LEONORA 24



INSERT HIDRO 20

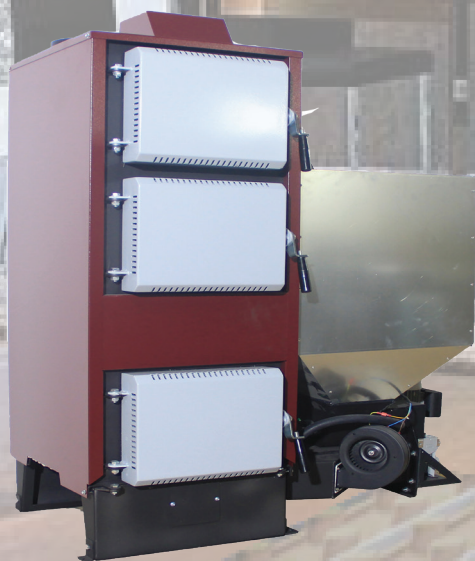

BOILER 34

ESTUFAS y CALDERAS PELLETS HIDRO

Caldera Hidro de Pellets

GAIA HIDRO 16 / COMPACT HIDRO 16

Referencia
ESH197001

Referencia
ESH197003



A+

RE104022

RC104031

16,98 kW

94,2%

150 m³

20 kg

160 kg

16 kW

220 V

80 mm

2,05 - 3,38

113 cm
55 cm
48 cm

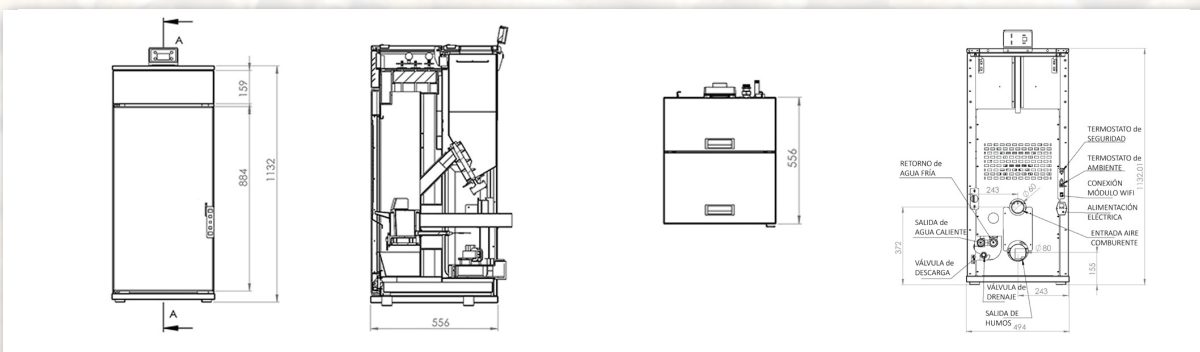

Caldera Hidro de Pellets

LEONORA HIDRO 24 / COMPACT HIDRO 24

Referencia
ESH197002

Referencia
ESH197004



A+  RE104022

 RC104031

 21,88 kW	 93,7%	 220 m ³	 25 kg	 204 kg
 20,50 kW	 220 V	 80 mm	 2,57 - 5,07	 113 cm 58 cm 56 cm

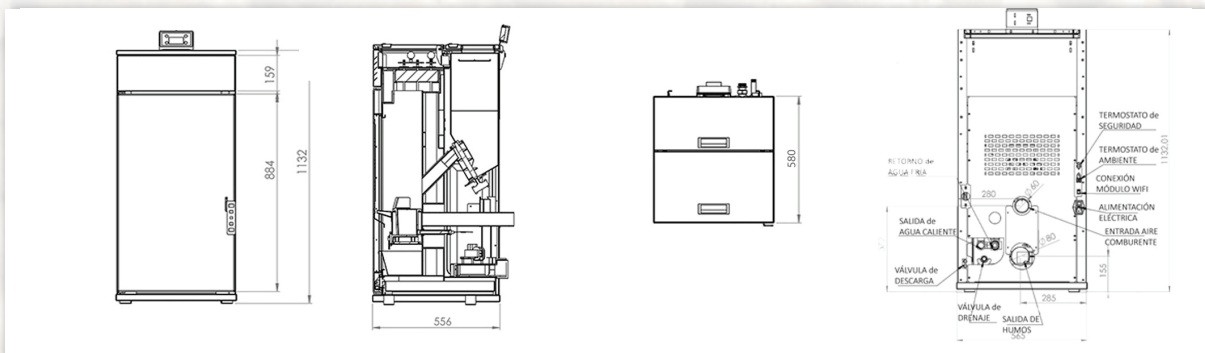

Insertable Hidro de Pellets

INSERT HIDRO 20

RE69001



Referencia
ESH22001



A+

19,34
kW

89%

200 m³

32 kg

150 kg

17,21
kW

220 V

80 mm

0,98 -
3,95
kg/h

72 cm
73 cm
83 cm

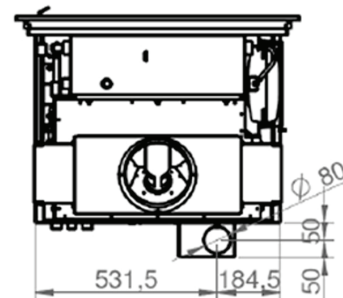
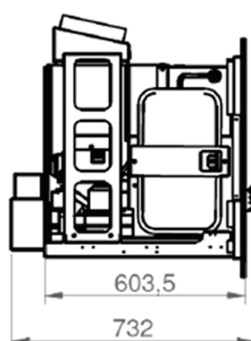
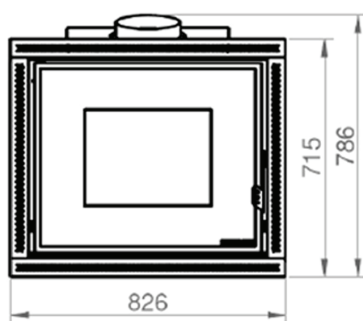
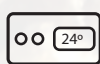

GRUPO TÉRMICO AUTOMÁTICO PARA PELLETS

TOTALPOWER 27 / 35 / 50



Quemador con sistema de autolimpieza automático



Sistema de limpieza de tubulares automático



Válvula de anticondensados incluida

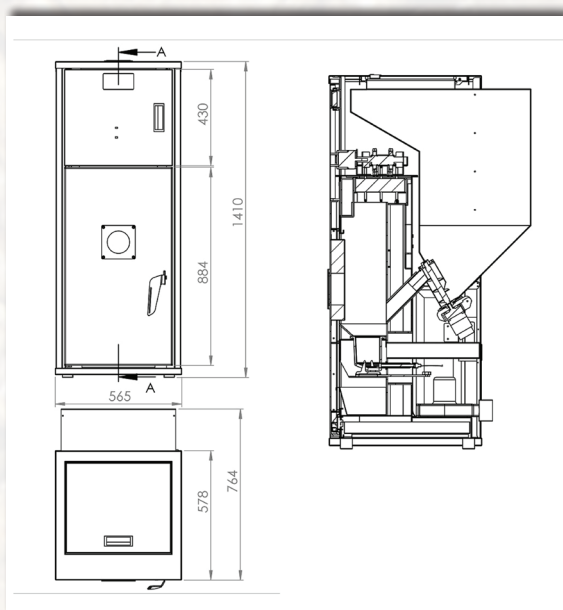

TOTALPOWER 27 Ref: CAL197001

TOTALPOWER 35 Ref: CAL197002

TOTALPOWER 50 Ref: CAL197003

A+

Potencia	kW	27	35	50
Rendimiento	%	92	92	92
Ancho	mm	565	565	631
Altura	mm	1410	1410	1368
Fondo	mm	578	578	931
Presión de funcionamiento	bar	1-1,5	1-1,5	1-1,5
Salida de humos	mm	100	100	100
Entrada caldera	pulg	1 - 3/4	1 - 3/4	1 - 3/4
Presión	bar	1 - 1,5	1 - 1,5	1 - 1,5
Capacidad de la Tolva	Kg	60	60	100
Capacidad del depósito de agua	L	50	50	70
Peso	Kg	270	270	342

CALDERA POLICOMBUSTIBLE PARA PELLETS O HUESO DE ACEITUNA



DELTA 30 / 50 / 100

A+

DELTA 30 Ref: CAL39001

DELTA 50 Ref: CADELTA50

DELTA 100 Ref: CADELTA100



OPCIONALES

MANTENIMIENTO DE LLAMA

Ref: ACTERMPEMP

CUADRO DE MANTENIMIENTO DE LLAMA



A - Interruptor General D - Termostato Seguridad
B - Termostato Circulador E - Termómetro
C - Termostato Quemador F - Temporizador

DOBLE SINFÍN

Ref: ACDOBLESF



ENCENDIDO ELÉCTRICO *

Ref: ACENCENELEC

LIMPIEZA MANUAL de TUBULADORES

Ref: ACDOMLIMPDELTA

			DELTA 30	DELTA 50	DELTA 100
Potencia térmica	Potencia Nominal	kW	25.8	45,5	85
	Potencia reducida	kW	7	21	25
Rendimiento	Potencia Nominal	%	81.5	85	90
	Potencia reducida	%	75.66	80	85
Clase de caldera			3		
Emisión CO (10% Oxígeno)	Potencia Nominal	%	0.211	0.245	0.273
	Potencia reducida	%	0.08	0.120	0.132
Temperatura de salida de gases	Potencia Nominal	°C	176	150	131
	Potencia reducida	°C	120	122	124
Requisitos mínimos de depresión de chimenea		Pa	11	12	16
Caudal volumétrico de los gases de combustión		g/s	34.9	34.1	34.4
Contenido de agua		l	85	100	125
Presión máxima admisible del agua de funcionamiento		bar	1.5		
Temperatura máxima de trabajo admisible		°C	85		
Temperatura mínima de retorno a nivel de accesorio de retorno de la caldera		°C	56.8	57	58.2
Caída de presión de agua		mbar	80	80	82
Peso		kg	300	350	416
Tipo de combustible			PelletS de madera		
Período de combustión	Potencia térmica nominal	h	>6		
Dimensiones del equipo (LxPxH)		mm	1430x800x1320	1430x1010x1320	1430x1260x1320
Dimensiones de puerta de carga (LxPxH)		mm	610x610x985		
Diámetro de salida de humos		mm	200		
Distancia mínima de seguridad de materiales inflamables		mm	500		
Esta luminaria se puede utilizar en chimenea compartida			NO		
Potencia eléctrica nominal		w	250		

CALDERA POLICOMBUSTIBLE PARA PELLETS, HUESO Y LEÑA

BOILER 34



Puertas recubiertas de piedra refractaria



Válvula anti-retorno de llama



Programable



Alimentación automática de Pellets o Hueso de Aceituna



Alimentación manual de Leña

A+



BOILER 34 Ref: CAL209001

ESPECIFICACIONES TÉCNICAS	UNIDADES	BOILER 34
Potencia	kW	34
	kcal/h	29000
Eficiencia directa a carga completa	%	78,40%
Clase	-	EN 303-5
Límite de seguridad de temperatura	°C	95
Rango de temperatura de operación	°C	80 - 65
Presión de operación	bar	1,5
Presión de operación máxima	bar	3
Conexión eléctrica	-	230V - 50Hz
Ancho	mm	1280
Altura	mm	1530
Profundidad	mm	907
Diámetro de salida de humos, Φ	mm	200
Altura de conexión a salida de humos, H2	mm	1530
Peso del equipo	kg	400
Volumen aproximado de capacidad de combustible	lt	120
Ancho - Profundo, W2, L2	mm	570 - 550

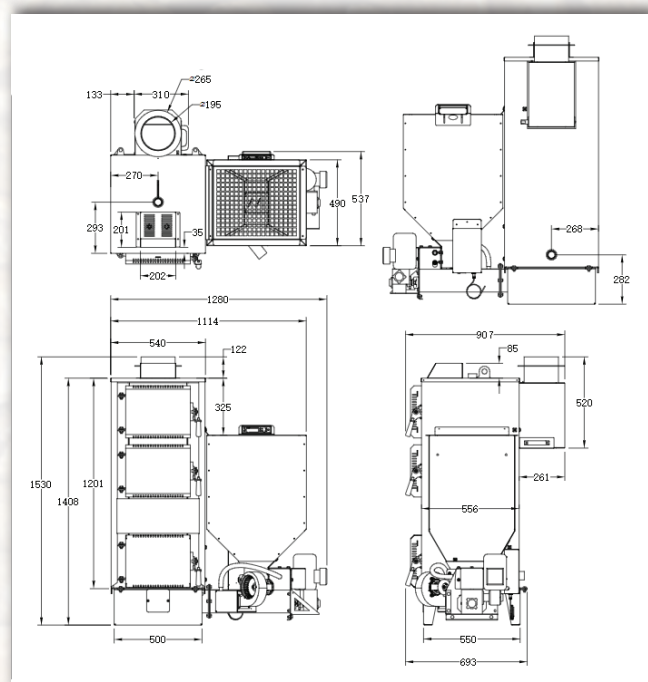

ESTUFAS de LEÑA



ASTON



LUX



MAXI CALOR



RÚSTICA



ROYCE



QUARTZ



CAPRI



COCINA IRON CLASSIC



FORTE

Estufa de Leña para Exteriores

RÚSTICA EXTERIORES



BASE y TOP
de FUNDICION

Referencia
ESL481002

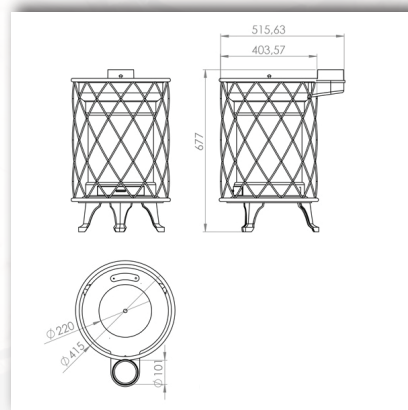

Global 13,05 kW
Nominal 8,53 kW

68 cm
52 cm
41 cm

120 mm

65,4%

190 m³

30 kg



Estufa de Leña

MAXI CALOR



Referencia
ESL211025

A

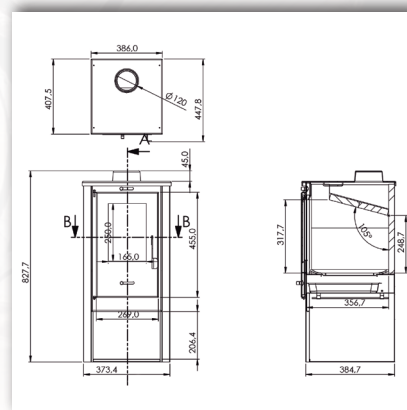

Global 6,64 kW
Nominal 5,4 kW

79 cm
41 cm
39 cm

120 mm

81,4%

120 m³

58 kg



Estufa de Leña
FORTE



FRENTE y TOP
de FUNDICION

Referencia
ESL211023

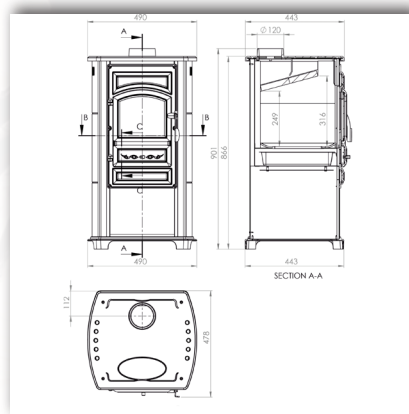

Global 6,64 kW
Nominal 5,4 kW

87 cm
49 cm
41 cm

120 mm
mm

81,4%

120 m³

68 kg
Kg



Estufa de Leña
CAPRI



Referencia
ESL246002

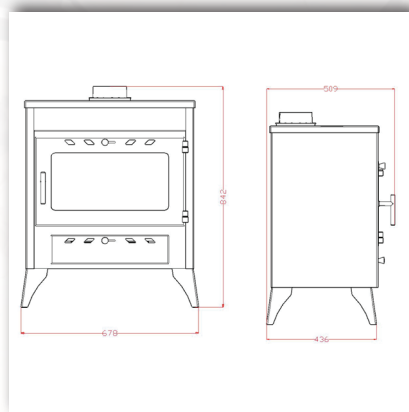

Global 17,05 kW
Nominal 13,2 kW

89 cm
44 cm
68 cm

130/150 mm
mm

77,4%

297 m³

87 kg
Kg



Estufa de Leña
RONDE



Referencia
ESL211018

A

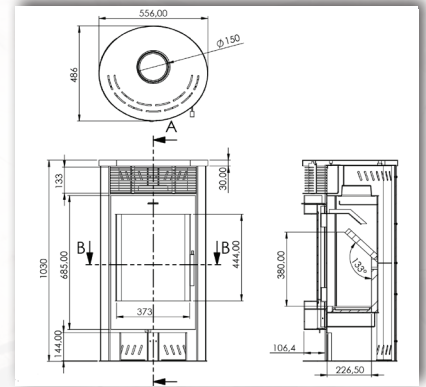

Global 7,79 kW
Nominal 6,3 kW

102 cm
49 cm
56 cm

150 mm
mm

80,9%

140 m³

85 kg



Estufa de Leña con Horno
QUARTZ



FRENTE y TOP
de FUNDICION

Referencia
ESL211024

A

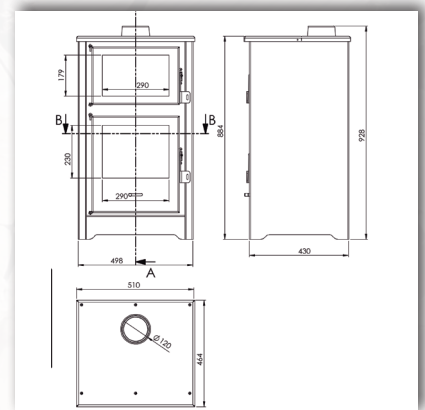

Global 12,4 kW
Nominal 9,7 kW

89 cm
47 cm
52 cm

120 mm
mm

78%

210 m³

75 kg

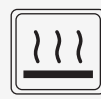

Estufa de Leña con Horno en Inox

LUX



Referencia
ESL211027

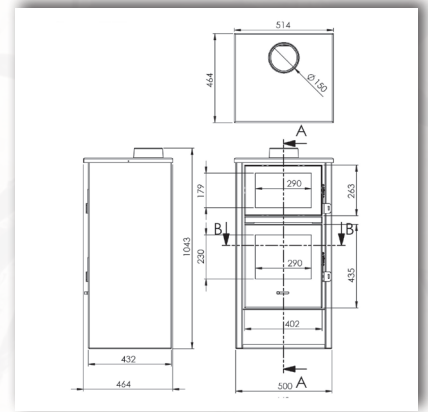

Global 12,4 kW
Nominal 9,7 kW

104,3 cm
46,4 cm
50 cm

150 mm

78%

210 m³

85 kg



Estufa de Leña con Horno en Inox

ASTON



Referencia
ESL619006

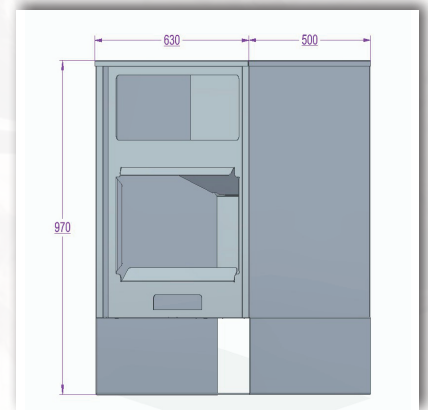

Global 13,1 kW
Nominal 10,2 kW

97 cm
50 cm
63 cm

150 mm

78%

225 m³

98 kg



Cocina de Leña

COCINA IRON CLASSIC



Referencia
ESL487001

A+



Global

10,08 kW

Nominal

8,31 kW



89 cm
61 cm
85 cm



120 mm



82,4%



187 m³



110 kg

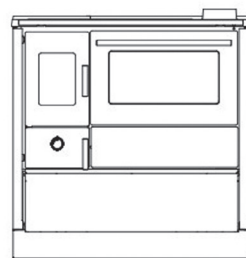

887

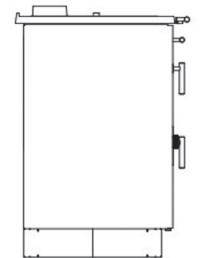

613

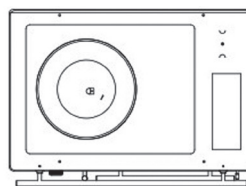

850

ESTUFAS LEÑA FUNDICIÓN



ROYCE



CUÉLLAR



ANTARES

Estufa de Leña en Fundición

ROYCE



COMPLETA en
FUNDICION

Referencia
ESL141003



Global 11,8 kW

Nominal 9,2 kW



97 cm
49 cm
48 cm



150 mm
mm



78%



205 m³



152 kg

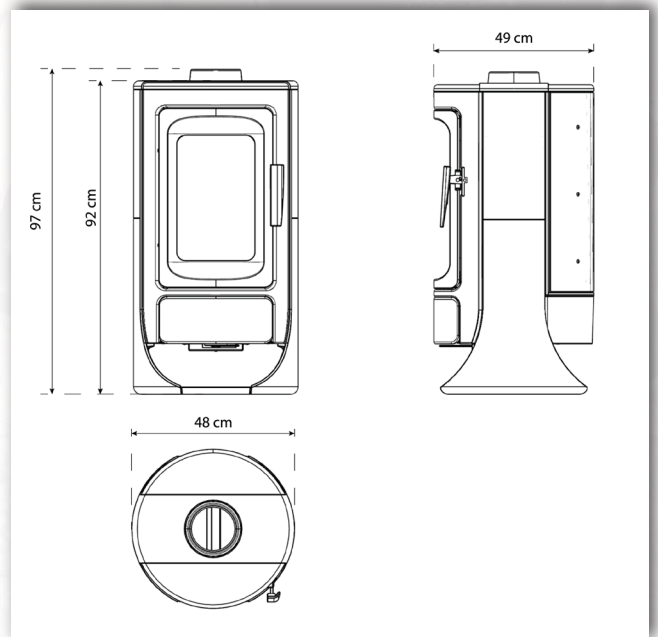

Estufa de Leña con Horno

CUÉLLAR IRON HORNO









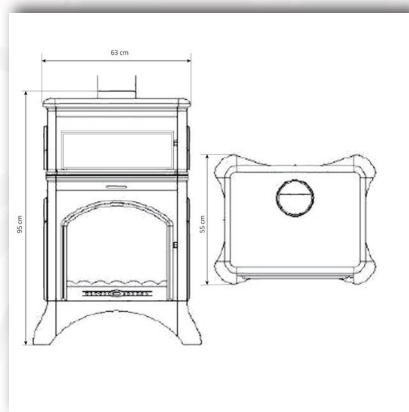



COMPLETA en FUNDICION

Referencia
ESL249004

A



 Global 18,33 kW		100 cm 44 cm 55 cm	 130 mm	
Nominal 13,78 kW				mm
 75,4%	 277 m ³	 104 kg		
				

Estufa de Leña con Horno

ANTARES IRON HORNO









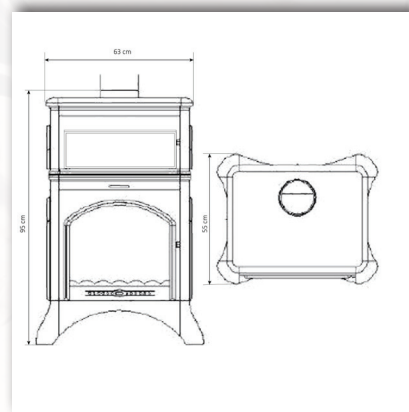



COMPLETA en FUNDICION

Referencia
ESL249002

A



 Global 24,28 kW		95 cm 55 cm 63 cm	 130 mm	
Nominal 18,26 kW				mm
 75,2%	 305 m ³	 152 kg		
				



**PISANO VISIÓN
VENTILADA**



ÉLIDE VENTILADA



TOKIO VENTILADA



TAKASHI VENTILADA

ESTUFAS de LEÑA VENTILADAS

Estufa de Leña Ventilada

PISANO VISIÓN VENTILADA

Referencia
ESL211022



Global

8,64 kW



83 cm
50 cm
56 cm



150 mm



78,7%



152 m³



105 kg

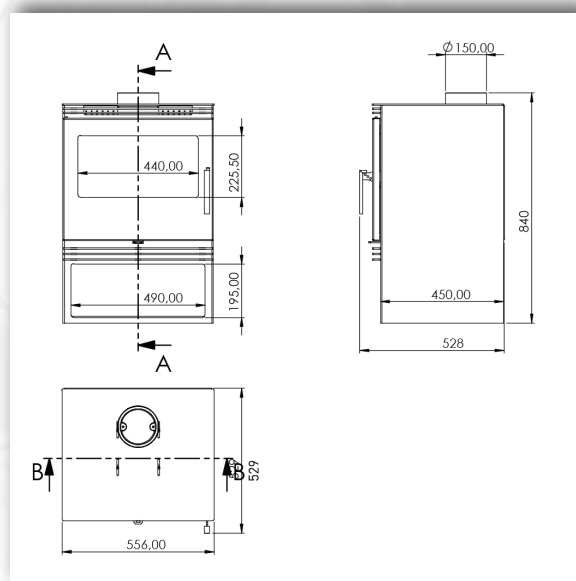

Estufa de Leña Ventilada

ÉLIDE VENTILADA



Referencia
ESL211019



Global 7,79 kW

Nominal 6,3 kW



102 cm
49 cm
56 cm



150 mm
150 mm



80,9%



140 m³



115 kg

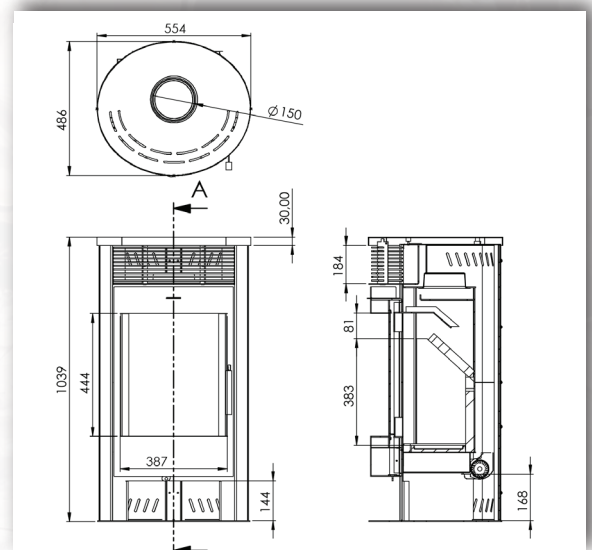
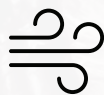

Estufa de Leña Ventilada con Horno

TOKIO VENTILADA VISIÓN HORNO



Referencia
ESL197004

A

Global
Nominal

14,99 kW

12,84 kW



97 cm
52 cm
61 cm



150 mm



85,6%



290 m³



85 kg

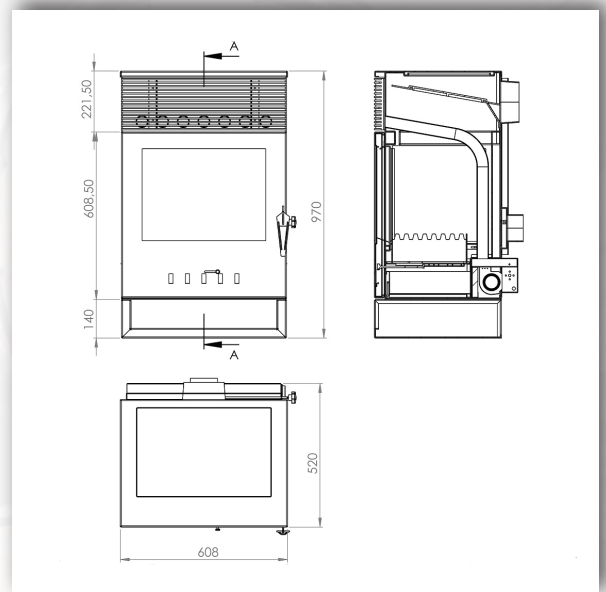

Estufa de Leña Ventilada con Horno

TAKASHI VENTILADA VISION HORNO



Referencia
ESL197002



Global 14,99 kW
Nominal 12,84 kW



121 cm
49 cm
61 cm



150 mm
mm



85,6%



290 m³



100 kg

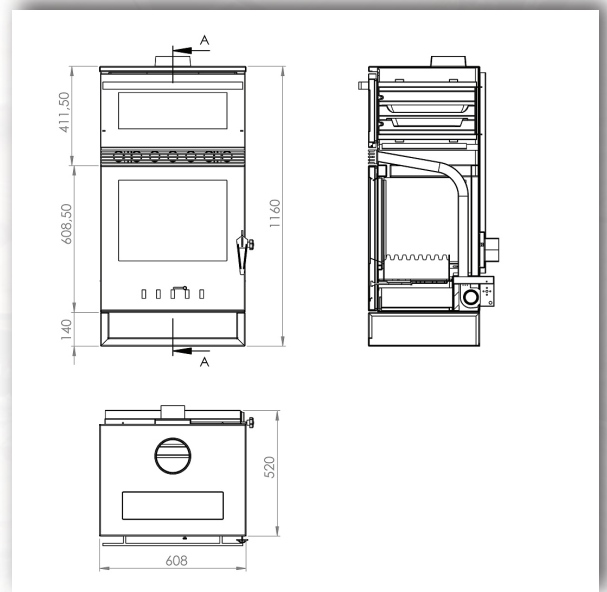

INSERT y HOGARES de LEÑA



AURORA ECO 70 VENTILADA



INSERT ASTON con HORNO

Insertable de Leña con Horno

INSERT ASTON



Referencia
ESL619007



Global
Nominal

13,1 kW

10,2 kW



89,3 cm
50 cm
73,5 cm



mm

150
mm



78%



225 m³



Kg

98 kg

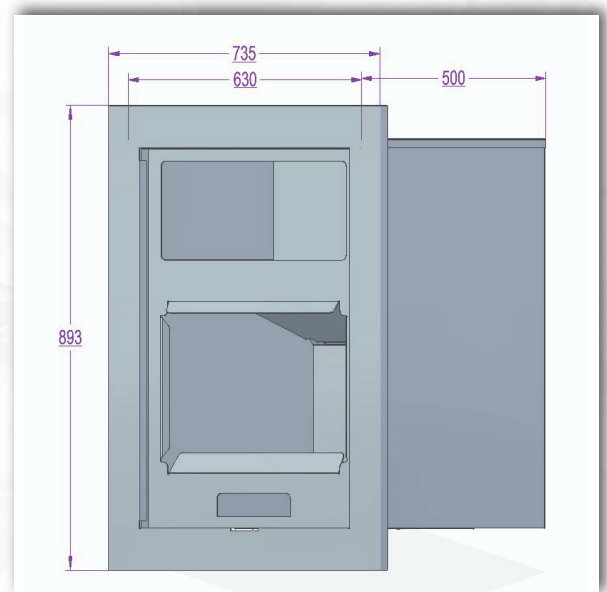

Insertable de Leña Ventilado

INSERT INUK IRON 70 VENTILADA

COMPLETA en FUNDICION



Referencia
ESL252001



Global 8 kW
Nominal 6 kW

52 cm
45 cm
69 cm

200 mm
mm

75%

135 m³

144 kg
Kg

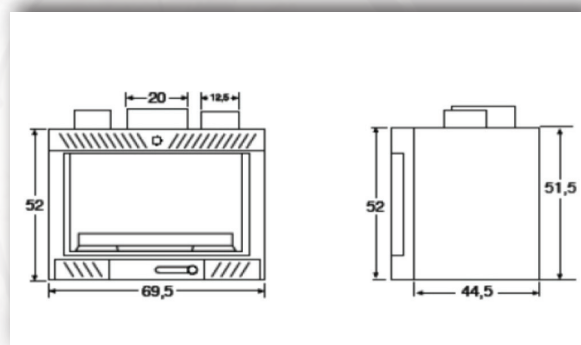

Insertable de Leña Ventilado

INSERT AURORA ECO IRON 70 VENTILADA

COMPLETA en
FUNDICION



Referencia
ESL233006



Global
Nominal

13,33 kW

10,4 kW



65 cm
43 cm
70 cm



180 mm



78%



225 m³



145 kg

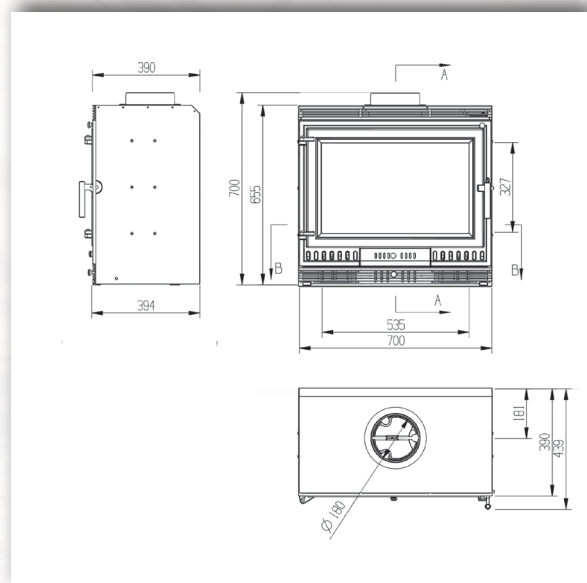

Hogar de Leña

HOGAR 90 - 2 CARAS

COMPLETA en FUNDICION

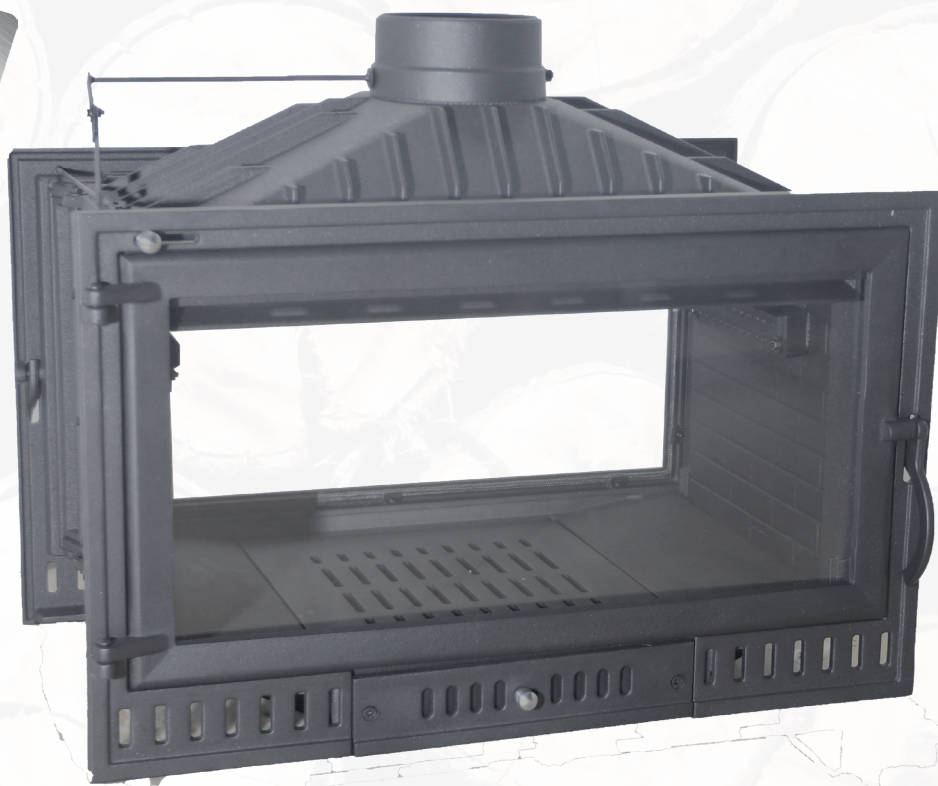

Referencia
ESL233003



Global
Nominal

16,28 kW
12,7 kW



67 cm
43 cm
90 cm



180 mm
mm



78%



337 m³



185 kg

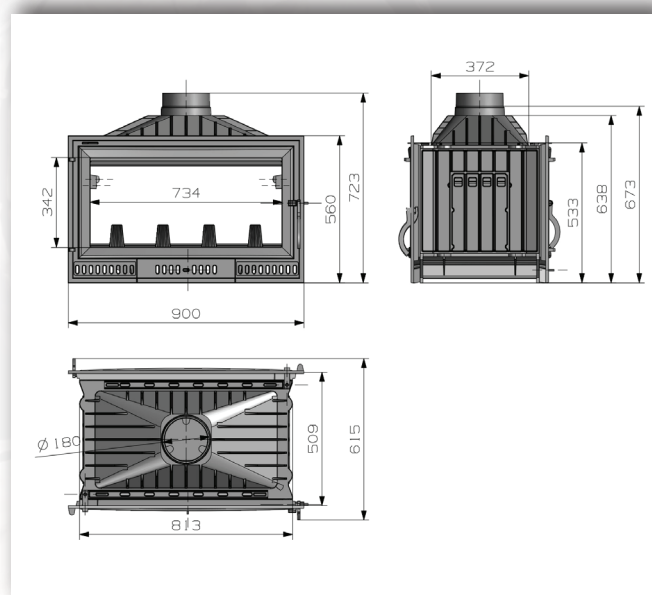



BOILER 34



ODESA



**HOGAR FUNDICIÓN
HIDRO 12**

ESTUFAS y CALDERAS LEÑA HIDRO

Hidro de Leña

ESTUFA LEÑA HIDRO ODESA 24



Referencia
ESL234002

A

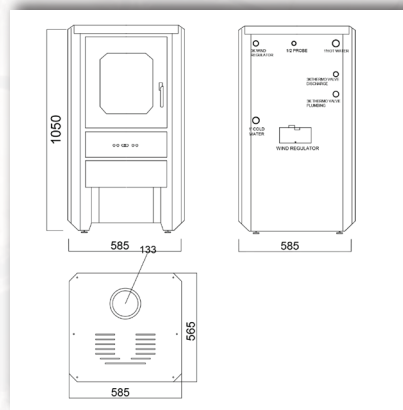

35,21 kW

Nominal

27,53 kW



105 cm

57 cm

58 cm



130

mm



78,2%



620 m³



118 kg



Hogar en Fundición Hidro

HOGAR FUNDICIÓN HIDRO 12



Referencia
ESL632001

A

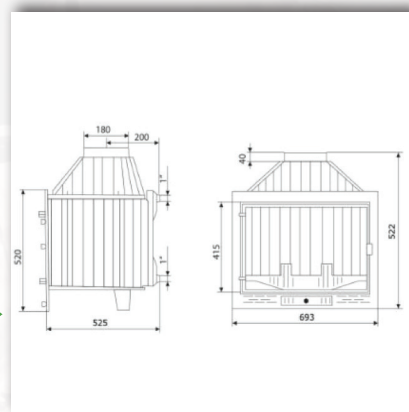

Global

21,18 kW

Nominal

16,2 kW



53 cm

53 cm

69 cm



180

mm



76,5%



365 m³



120 kg



CALDERA POLICOMBUSTIBLE PARA PELLETS, HUESO Y LEÑA

BOILER 34



Puertas recubiertas de piedra refractaria



Válvula anti-retorno de llama



Programable



Alimentación manual de Leña



Alimentación automática de Pellets o Hueso de Aceituna



A+



BOILER 34 Ref: CAL209001

ESPECIFICACIONES TÉCNICAS	UNIDADES	BOILER 34
Potencia	kW	34
	kcal/h	29000
Eficiencia directa a carga completa	%	78,40%
Clase	-	EN 303-5
Límite de seguridad de temperatura	°C	95
Rango de temperatura de operación	°C	80 - 65
Presión de operación	bar	1,5
Presión de operación máxima	bar	3
Conexión eléctrica	-	230V - 50Hz
Ancho	mm	1280
Altura	mm	1530
Profundidad	mm	907
Diámetro de salida de humos, Φ	mm	200
Altura de conexión a salida de humos, H2	mm	1530
Peso del equipo	kg	400
Volumen aproximado de capacidad de combustible	lt	120
Ancho - Profundo, W2, L2	mm	570 - 550

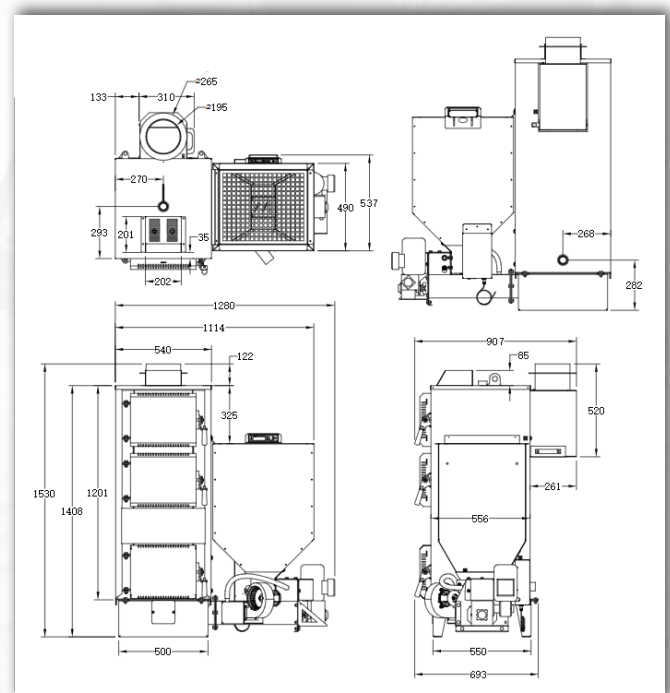

TARIFA DE PRECIOS

SEPTIEMBRE 2024



REFERENCIA

PRECIO



PETIT 6

7,01
kW

6,2 kW

88,5%

110 m³

77 cm
43 cm
43 cm



ESA3066

1.017 €



POWER 8

8,74
kW

7,92
kW

90,6%

150 m³

97 cm
44 cm
43 cm



ESA61023

1.259 €



ESA61029



PASILLO 8 FUTURA

7,85
kW

7 kW

90%

150 m³

91 cm
24 cm
93 cm



ESA67089

1.450 €



ESFERA

8,74
kW

7,93
kW

90,7%

150 m³

91 cm
49 cm
47 cm



ESA61027

1.570 €



ESA61024



KING 10

10,26
kW

9,47
kW

92,3%

180 m³

94 cm
45 cm
44 cm



ESA61030

1.329 €



ESA61032



TOSCANA

10,61
kW

9,55
kW

90%

200 m³

96 cm
52 cm
53 cm



ESA67064

1.810 €



ALFA 12

12,82
kW

11,54
kW

90%

240 m³

105 cm
50 cm
52 cm



ESA67080

1.578 €



ESA67025



AUTOLIMPIEZA 12

11,67
kW

10,28
kW

88,1%

240 m³

100 cm
56 cm
50 cm



ESA22001

2.063 €



CERO REM

11 kW

8,25
kW

75%

200 m³

102 cm
51 cm
47 cm



ESA67085

1.249 €



**CERO REM
VENTILADA**

11 kW

8,25
kW

75%

200 m³

102 cm
51 cm
47 cm



ESA67086

1.420 €



REFERENCIA

PRECIO

**INSERT 8**7,98
kW

7,5 kW

94%

175 m³70 cm
49 cm
73 cm ESA67082

1.558 €

**INSERT
CANADÁ 11**10,9
kW9,48
kW



87%

200 m³59 cm
54 cm
72 cm ESA234001

1.816 €

**KING 10
CANALIZADA**10,26
kW9,47
kW

92,3%

180 m³96 cm
45 cm
44 cm ESC61007
 ESC61006

1.624 €

**TOSCANA
CANALIZADA**10,61
kW9,55
kW

90%

200 m³96 cm
52 cm
51 cm ESC67014

2.047 €

**PASILLO 10
CANALIZADA**11,12
kW10,01
kW

90%

220 m³100 cm
34 cm
103 cm ESC67011

2.252 €

**ENERGY FIRE 15
CANALIZADA**14,3
kW12,3
kW

86%

320 m³105 cm
50 cm
52 cm ESC67008
 ESC67009
 ESC67016

2.151 €

**INSERT 12
CANALIZADA**13,06
kW11,6
kW

88,8%

220 m³70 cm
71 cm
80 cm ESC67002

2.391 €



REFERENCIA

PRECIO

**GAIA 16**16,98
kW

16 kW

94,2%

150 m³113 cm
56 cm
57 cm

ESH197001

2.698 €

**COMPACT 16**16,98
kW

16 kW

94%

150 m³113 cm
56 cm
57 cm

ESH197003

2.698 €

**LEONORA 24**21,88
kW20,50
kW

93,7%

220 m³113 cm
58 cm
57 cm

ESH197002

3.071 €

**COMPACT 24**21,88
kW20,50
kW

93,7%

220 m³113 cm
58 cm
57 cm

ESH197004

3.071 €

**TOTALPOWER
27 / 35 / 50**27 kW
35 kW
50 kW

~92%

220 -
420 m³<141 cm
<93 cm
<63 cm

CAL197001

4.500 €

CAL197002

4.800 €

CAL197003

5.300 €

**INSERT HIDRO 20**19,34
kW17,21
kW

89%

200 m³79 cm
73 cm
83 cm

ESH22001

4.673 €

**BOILER 34**

34 kW

27,8
kW

78,4%

480 m³153 cm
91 cm
128 cm

CAL209001

3.519 €

**REFERENCIA****PRECIO****RÚSTICA EXTERIORES**

13,05 kW

65,4%

192 m³

68 cm

52 cm

41 cm

ESL481002

236 €

8,53 kW

**MAXI CALOR**

6,64 kW

81,4%

120 m³

79 cm

41 cm

38,5 cm

ESL211025

465 €

5,4 kW

**FORTE**

6,64 kW

81,4%

120 m³

87 cm

41 cm

49 cm

ESL211023

615 €

5,4 kW

**CAPRI**

17,05 kW

77,4%

297 m³

89 cm

44 cm

68 cm

ESL246002

808 €

13,2 kW

**RONDE**

7,79 kW

80,9%

140 m³

102 cm

49 cm

56 cm

ESL211018

930 €

6,3 kW

**QUARTZ**

12,44 kW

78%

210 m³

89 cm

47 cm

52 cm

ESL211024

627 €

9,7 kW

**LUX**

12,44 kW

78%

210 m³

105 cm

46 cm

48 cm

ESL211027

734 €

9,7 kW

**ASTON**

13,08 kW

78%

225 m³

97 cm

50 cm

63 cm

ESL619006

890 €

10,2 kW

**COCINA IRON CLASSIC**

10,08 kW

82,4%

187 m³

89 cm

61 cm

85 cm

ESL487001

1.685 €

8,31 kW

Global
Nominal



REFERENCIA

PRECIO



ANTARES

24,28 kW

75,2%

305 m³

95 cm

55 cm

63 cm

ESL249002

1.508 €

18,26 kW



CUÉLLAR VISIÓN

24,28 kW

75,2%

305 m³

95 cm

55 cm

63 cm

ESL249004

1.598 €

18,26 kW



ROYCE

11,8 kW

78%

205 m³

97 cm

49 cm

48 cm

ESL141003

721 €

9,2 kW



**PISANO VISIÓN
VENTILADA**

8,64 kW

78,7%

152 m³

84 cm

48 cm

56 cm

ESL211022

831 €

6,8 kW



ÉLIDE VENTILADA

7,79 kW

80,9%

142 m³

102 cm

49 cm

56 cm

ESL211019

989 €

6,3 kW



TOKIO VENTILADA

14,99 kW

85,6%

290 m³

96,5 cm

53 cm

61 cm

ESL197004

1.410 €

12,84 kW



**TAKASHI HORNO
VENTILADA**

14,99 kW

85,6%

290 m³

121 cm

49 cm

61 cm

ESL197002

1.475 €

12,84 kW



**INUK 70
VENTILADA**

8 kW

75%

135 m³

52 cm

45 cm

69 cm

ESL252001

1.061 €

6 kW



**AURORA ECO 70
VENTILADA**

13,33 kW

78%

225 m³

65 cm

43 cm

70 cm

ESL233006

1.065 €



10,4 kW

Global
Nominal



REFERENCIA

PRECIO

	INSERT ASTON	13,08 kW 10,2 kW	78%	225 m ³	89,3 cm 50 cm 73,5 cm	ESL619007	990 €
	HOGAR 90 2 CARAS	16,28 kW 12,7 kW	78%	337 m ³	72 cm 62 cm 90 cm	ESL233003	1.150 €
	ODESA 24	35,21 kW 27,53 kW	78,2%	620 m ³	105 cm 57 cm 58 cm	ESL234002	1.243 €
	HOGAR FUNDICIÓN HIDRO	21,18 kW 16,2 kW	76,5%	365 m ³	52 cm 53 cm 79 cm	ESL632001	2.527 €
	BOILER 34	27,8 kW	78,4%	480 m ³	153 cm 91 cm 128 cm	CAL209001	3.519 €

ACCESORIOS

MÓDULO PROTECTOR
AE67001

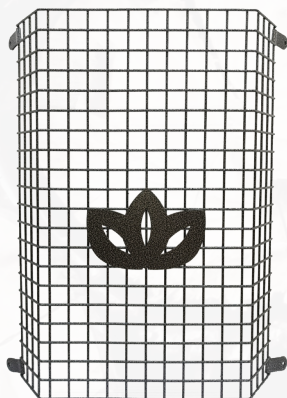

PIE DE ESTUFA
AE67021



QUEMADOR DE PELLETS
RE67023



COMBUSTIBLES



PELLETS



Saco plástico
• Fireplus - 15 kg



Saco plástico
• Nº 1 - 15 kg



Saco plástico
• Biofire - 15 kg



Saco papel
• Fireplus - 15 kg

Big Bags A1 y A2
• 500 kg y 1000 kg



LEÑA



Saco leña
• Biofire 18 L
• Biofire 30 L
• Saco Astillas 6 kg

Briquetas de madera
Biofire



• 4 piezas
7 kg

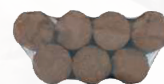

• 7 piezas
11 kg



• 11 piezas
15 kg



ALMENDRA



Biomasa de
Almendra 45 L



CARBÓN



Carbón Vegetal
• 10 L (~2 kg)
• 15.5 L (2.8 - 3 kg)
• 35 L (6 - 7 kg)

GAMA FUEGO

**PASTILLAS DE ENCENDIDO
32 UNIDADES**

CB640002



**LANA DE ENCENDIDO
24 UNIDADES**

CB640003



**LÍQUIDO DE ENCENDIDO
1 L.**

CB640001



**LIMPIACRISTALES
500 ML**

AL643001



**BIOETANOL
1 L.**

CB641001



**BIOETANOL
5 L.**

CB641002



FUMISTERIA PELLETS - VITRIFICADO (80mm)*

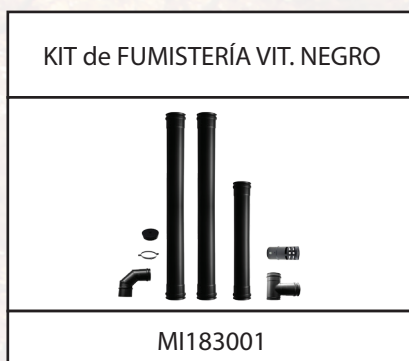

* También disponible fumistería de pellets en INOX 316 de doble pared (80 mm)

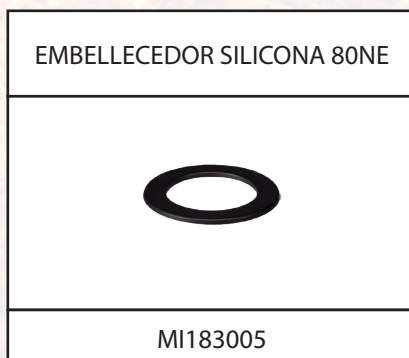
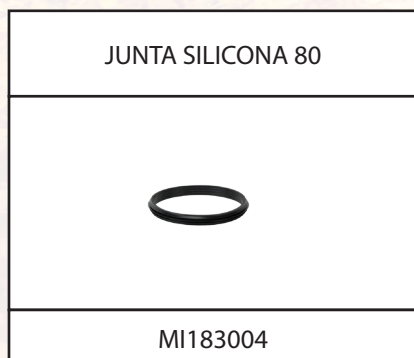
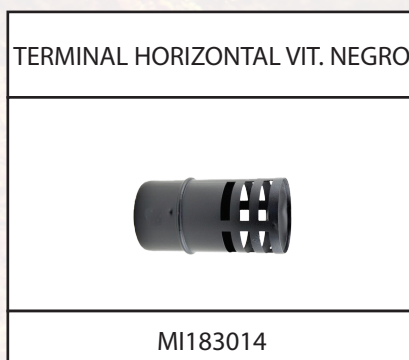

FUMISTERIA LEÑA - VITRIFICADO 130 mm*

* También disponible fumistería de leña en vitrificado en 150 mm ó 200 mm y en INOX 316 de doble pared en 150 mm ó 200 mm

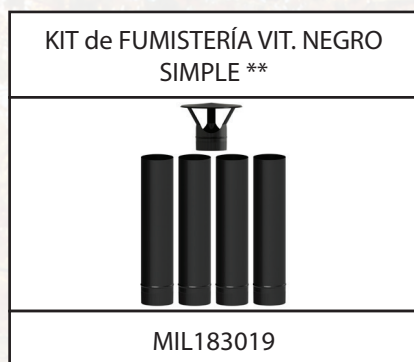

** Kits también disponibles en vitrificado en 150 mm ó 200 mm



Módulo adaptable para chimeneas con diámetros desde 120 mm. hasta 130 mm. Sistema antigoteo para un sellado óptimo.

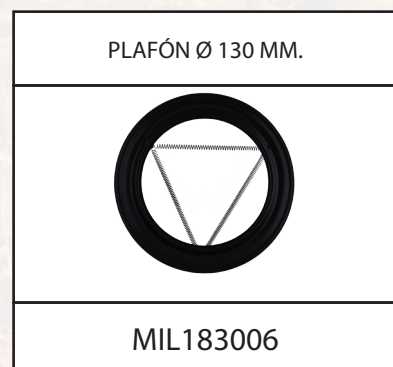

LISTADO MANDOS

	RE3021	RP138009	RE69001	RE104022
PETIT 6 (CONSULTAR)	●	●		●
POWER 8			●	
PEGASO 8			●	
ESFERA			●	
KING 10			●	
TOSCANA (CONSULTAR)		●		●
AUTOLIMPIEZA 12			●	
ALFA 12				●
PASILLO 8			●	
KING 10 CANALIZADA			●	
TOSCANA 10 CANALIZADA				●
PASILLO 10 CANALIZADA				●
ENERGY FIRE 15 CANALIZADA				●
INSERT 8		●		
INSERT CANADÁ 11		●		●
INSERT 12 CANALIZADA				●
GAIA, LEONORA COMPACT 16 y 24				●
INSERT HIDRO 20			●	

LISTADO MODULOS WiFi						
	DPREMOTE RP138004	4HEAT RC104031	AQUA AE3065	AQUA RE169045	AQUA RE610002	AQUA RE220002
PETIT 6 (CONSULTAR)	●	●	●			
POWER 8					●	
ESFERA					●	
KING 10					●	
TOSCANA (CONSULTAR)	●	●				
AUTOLIMPIEZA 12						
ALFA 12		●				
PASILLO 8				●		
KING 10 CANALIZADA					●	
TOSCANA 10 CANALIZADA		●				
PASILLO 10 CANALIZADA		●				
ENERGY FIRE 15 CANALIZADA		●				
INSERT 8	●					
INSERT CANADÁ 11	●	●				
INSERT 12 CANALIZADA		●				
GAIA, LEONORA COMPACT 16 y 24		●				
INSERT HIDRO 20						

* El precio de los repuestos, accesorios, módulos WiFi y mandos a distancia puede variar. Ya que se consideran recambios y no se atienden a las condiciones generales de descuento del resto de productos.

Términos y condiciones

Términos y condiciones generales

1. Información sobre la empresa y datos de contacto

1.1 Los presentes términos y condiciones generales hacen referencia a las ventas realizadas por Vertex Life s.l. a sus distribuidores, en adelante los clientes. Dichas condiciones también se aplican siempre que se efectúe un pedido bonificado a través del Sitio web. Vertex Life es una empresa sita en calle Pago de los Cahíces s/n de Padul Granada, con código postal 18640. Inscrita en el Registro Mercantil de Granada Tomo 1401, Folio 42, Hoja GR-38751 y su NIF es B18942581

1.2 Los clientes pueden ponerse en contacto con nosotros por correo postal en la dirección fiscal señalada. Por teléfono en el número 958847667 o a través de la dirección de email info@vertexlife.com

1.4 Vertex Life solamente suministra los productos y servicios que se ofrecen a los clientes para uso doméstico y privado, salvo las calderas industriales. Todo aquel que efectúe un pedido por cualquier medio, acepta que dicha compra está destinada a un uso doméstico.

1.5 Si necesitamos ponernos en contacto con cualquier cliente, lo haremos por teléfono o mediante la dirección de correo electrónico o la dirección postal que figure en la ficha de apertura de cuenta del cliente o en su defecto a través de información proporcionada en el pedido.

2. Aplicabilidad

2.1 Cada uno de los párrafos de estos términos se aplica de forma independiente. Si uno de los párrafos resultase en algún momento legalmente no válido o se considera ilícito por cualquier motivo, el resto de párrafos permanecerán en plena vigencia.

3. Catálogo y Tarifa

3.1 El catálogo y tarifa vigentes en cada momento contienen una descripción completa y precisa de los productos y/o servicios disponibles. Siempre que Vertex Life utilice imágenes, estas tendrán un propósito meramente ilustrativo. A pesar de poner el mayor esfuerzo posible en mostrar los colores exactos, es posible que el producto difiera ligeramente de las imágenes debido a la visualización de los colores en todos los dispositivos.

3.2 Cada oferta o pedido emitidos contiene la información necesaria para que los clientes tengan claro qué derechos y obligaciones van asociadas a la aceptación de la oferta o pedido. Además, Vertex Life podrá implementar cambios en el producto o servicio para rectificar un error, una omisión o un problema con el suministro; no obstante, de hacerlo, se notificará al cliente y se le dará la oportunidad de rescindir el pedido antes de que los cambios surtan efecto y de recibir un reembolso por cualquier producto o servicio pagado y no recibido.

3.3 Ante la posibilidad de que se detectase alguna incongruencia de precios debido a errores humanos u otros. Si el precio correcto en la fecha del pedido es inferior al precio indicado en la fecha del pedido, Vertex Life facturará el importe menor. Si el precio correcto en la fecha del pedido es superior al precio indicado, Vertex Life se pondrá en contacto con el cliente para proporcionarle instrucciones antes de aceptar el pedido. Si se aceptara y procesase un pedido con un precio obviamente erróneo que razonablemente se haya podido reconocer como un precio incorrecto, Vertex Life no estará obligado a suministrarlo hasta tanto no se haya subsanado la errata y admitido la corrección por el cliente. En caso contrario Vertex Life podrá rescindir el contrato, reembolsar cualquier importe abonado y exigir la devolución de los bienes suministrados

4. Nuestro compromiso con los clientes

4.1 La aceptación del pedido por parte de Vertex Life se producirá cuando éste envíe un correo electrónico al cliente para aceptar el pedido, momento en el que se podrían subsanar los posibles errores en el mismo. Vertex Life solamente puede procesar pedidos para clientes que figuren en nuestra base de datos profesional y estén en ejercicio.

4.2 Vertex Life se reserva el derecho de rechazar pedidos en caso de sospecha de abuso de autoridad, mala voluntad, fraude o propósitos comerciales inaceptables. Si Vertex Life no puede aceptar el pedido, deberá informar al cliente y no le cobrará por el producto o servicio. Asimismo, rechazará cualquier pedido con destino a cualquier territorio donde no exista la cobertura postventa CENSAT.

5. Precios.

5.1 El precio válido será el precio indicado en las tarifas PVP en el momento en el que se realice el pedido. Todos los precios indicados NO incluyen el IVA. Vertex Life podrá establecer bonificaciones particulares a cada cliente mediante acuerdos de compra venta específicos.

5.2 El pago debe efectuarse antes de despachar los productos o de iniciar los servicios. Vertex Life podrá establecer otros modos de pago particulares a cada cliente mediante acuerdos de compra venta específicos.

6. Facturación

6.1 Tras la recepción del pedido y en su caso el pago, Vertex Life procederá al envío de la mercancía en el plazo convenido y realizará la factura correspondiente. Para tal fin, el cliente final acepta recibir todas las facturas en formato electrónico. El cliente tendrá derecho a revocar su consentimiento para recibir facturas electrónicas y, en cualquier momento, podrá solicitar la recepción de facturas en papel sin cargo alguno si envía un correo electrónico a facturas@vertexlife.com

7. Envío

7.1 Los costes de envío se especificarán en el proceso de compra a través del pedido. Si los productos consisten en servicios continuos o suscripciones, durante el proceso de compra también le indicará cuándo y cómo rescindir el contrato.

7.2 Vertex Life pondrá en práctica toda la diligencia necesaria para agilizar los envíos y mantener informado al cliente por los medios a su alcance.

8. Problemas con los productos

8.1 Si el cliente tiene preguntas o quejas sobre los productos, puede ponerse en contacto por correo postal en la dirección fiscal señalada. Por teléfono en el número 958847667 o a través de la dirección de email info@vertexlife.com

8.2 Vertex Life tiene la obligación legal de suministrar productos que cumplan las exigencias europeas y las condiciones de estos términos y condiciones. Somos responsables ante usted por pérdidas y daños previsibles que hayamos causado. Si incumplimos los presentes términos, nos responsabilizaremos de las pérdidas o los daños que sufra siempre que constituyan una consecuencia previsible de nuestro incumplimiento o de nuestra ineficacia en la prestación.

No nos responsabilizamos de las pérdidas comerciales. Nosotros solamente suministramos productos para uso doméstico y privado. Si utiliza el producto para cualquier propósito comercial, empresarial o de reventa, no tendremos responsabilidad alguna ante usted por pérdidas de beneficios, pérdidas comerciales, interrupciones comerciales o pérdidas de oportunidades comerciales.

9. Tratamiento de datos.

Toda la información proporcionada durante el proceso de compra venta será almacenada por Vertex Life S.L, en su calidad de responsable y gestor, así como encargado de tratamiento de los datos del cliente. Será el responsable del Fichero con los datos personales de los clientes que efectivamente operen comercialmente. Los datos recabados serán puestos a disposición del departamento correspondiente de Vertex Life, de la empresa de transporte y logística encargada de hacer la entrega del artículo adquirido, de la entidad encargada de la financiación indicada en las presentes condiciones, así como de cualquier otro operador que intervenga en el proceso de compra, financiación y/o entrega, a los efectos del cumplimiento de los pedidos realizados por el cliente y las relaciones derivadas de los mismos. Salvo que el cliente haya mostrado su oposición expresa, consiente expresamente el tratamiento de sus datos personales para remitir información de interés, novedades y ofertas sobre los productos y servicios de Vertex Life a través de cualquier medio, incluyendo correo, correo electrónico, SMS o similar. Para darse de baja del servicio de envíos de comunicaciones publicitarias puede hacerlo a través de la dirección de email info@vertexlife.com solicitarlo según lo dispuesto en la Política de Privacidad de Vertex Life. Asimismo, el usuario puede dirigirse para ejercer sus derechos de acceso, rectificación, cancelación y oposición a Vertex Life S.L. con los datos aquí expuestos, adjuntando fotocopia de su DNI en ambos casos.

10. Propiedad intelectual

Los diseños y soluciones técnicas exclusivas, los catálogos y todas las partes del mismo, incluidos los materiales y contenidos (como imágenes y textos), así como la tecnología utilizada, son propiedad exclusiva de Vertex Life.

Vertex Life es el propietario de todos los derechos de propiedad intelectual que protegen los trabajos y las marcas. Dichos trabajos están protegidos por leyes y tratados sobre los derechos de autor en todo el mundo. Todos esos derechos están reservados. Los distribuidores que deseen utilizar estos recursos o que tengan su propio sitio web y deseen, aunque sea para uso meramente personal, establecer un enlace automático entre su sitio web y la página de inicio del Sitio web de Vertex Life o sus marcas, deberán solicitar a Vertex Life su consentimiento explícito para hacerlo. El cliente final no deberá utilizar el contenido del sitio para propósitos comerciales en ningún caso.

11. Autoridad y legislación aplicable

Las presentes Condiciones Generales de Venta se regirán e interpretarán de acuerdo con las Leyes de España. Para la resolución de cualquier disputa o discrepancia que pudiera surgir en cuanto a la interpretación, ejecución, cumplimiento y/o incumplimiento de la Condiciones Generales de Venta, las partes, con renuncia a cualquier otro fuero que pudiera corresponderles, se someten a la jurisdicción y competencia de los Juzgados y Tribunales de la ciudad de Granada (España).



EIDER BIOMASA

Aportando calor a su hogar desde 1934

