



Componenti per la ventilazione permanente in ambienti domestici e industriali

Componentes para la ventilación permanente en ambientes domésticos e industriales

Components for permanent ventilation in domestic and industrial environments

GRIGLIE IN MATERIALE TERMOPLASTISCO | Rejillas en material termoplástico | Grilles in thermoplastic material

GRIGLIE METALLICHE | Rejillas metálicas | Metal grilles

GRIGLIE PER CAMINETTI | Rejillas para chimenea | Fireplace grilles

TUBI DI CONNESSIONE IN ALLUMINIO | Tubos de conexión de aluminio | Aluminum connection pipes



COVENT

Indice prodotti

Indice de productos | Products index



230

Griglie circolari universali

Rejillas redondas universales
Round universal grilles



232

Griglie circolari chiudi e apri

Rejilla redonda con apertura y cierre
Round open-close grille



233

Griglie circolari ad incasso

Rejillas redondas empotradas
Round recessed grilles



236

Griglie quadrate universali

Rejillas cuadradas universales
Square universal grilles



237

Griglie quadrate ad incasso

Rejillas cuadradas empotradas
Square recessed grilles



239

Griglie modulari e componibili

Rejillas modulares y componibles
Modular grilles



241

Coppia di griglie

Par de rejillas
Pair of grilles



243

Griglie a flusso regolabile

Rejillas de flujo regulable
Grilles with adjustable air-flow



246

Aeratori per finestra

Airadores para ventana
Window ventilator

COVENT
air ventilation



247

Griglie per porte e mobili

Rejillas para puertas y muebles
Grilles for doors and furniture

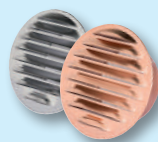

250

Griglie in metallo da incasso

Rejillas de metal empotradas
Metal recessed grilles

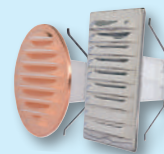

250

Griglie universali in metallo

Rejillas universales de metal
Universal metal grilles



256

Griglie da appoggio in metallo

Rejillas de apoyo de metal
Free standing grilles



258

Griglie Pop-Line

Rejillas Pop-line
Pop-line grilles



261

Griglie "Style"

Rejillas "Style"
"Style" grilles



263

Griglie per caminetto

Rejillas para chimenea
Fireplace grilles



265

Espositori

Expositores
Display



267

Confezionamento

Embalaje
Packaging

Legenda: molle pieghevoli per griglie

Leyenda: muelles para rejillas

Legend: foldable springs for grilles

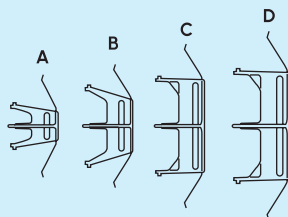
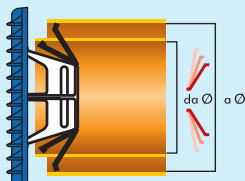

A	Ø 80/125
B	Ø 125/160
C	Ø 160/200
D	Ø 200/260

GRIGLIE CIRCOLARI UNIVERSALI in materiale termoplastico con molle reclinabili a 90°
REJILLAS REDONDAS UNIVERSALES de termoplástico con muelles reclinables a 90°
ROUND UNIVERSAL GRILLES in thermoplastic with reclining springs at 90°

Molle universali: con sole 4 misure coprono un'estensione applicativa variabile da un Ø min. di 80 mm ad un Ø max. di 260 mm. La caratteristica più rilevante è la possibilità di piegare la molla a 90° (brevetto industriale ed europeo) con una considerevole riduzione dello spazio necessario per l'immagazzinamento.

Muelles universales: con solo 4 diferentes medidas cubren una gama de aplicación variable que va desde un diámetro mínimo de 80 mm hasta un máximo de 260 mm. La característica relevante es la posibilidad de doblar los muelles a 90° (patente industrial y europea) que permite una importante reducción del espacio de almacenamiento.

Universal grilles: with 4 different measures only, it is possible to fit any Ø ranging from 80 to 260 mm. The most relevant feature lies in the possibility of folding the spring of the grille at 90° (Italian and European patent), reducing stock volume considerably.

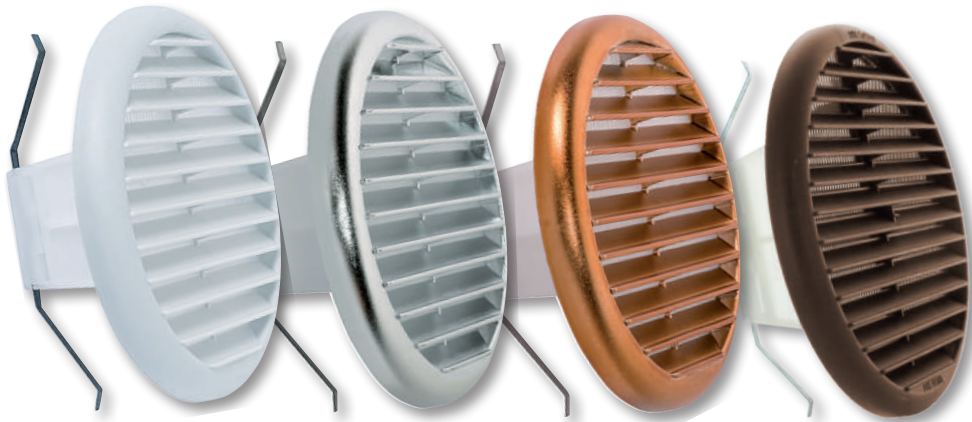

COD.	Ø					€
9611-006-06/60	Ø 145	Ø 80/125	-	100 pz	✓	
9611-006-40	Ø 145	Ø 80/125	-	100 pz	✓	
9611-006-50	Ø 145	Ø 80/125	-	100 pz	✓	
9615-006-06/60	Ø 180	Ø 125/160	-	48 pz	✓	
9615-006-40	Ø 180	Ø 125/160	-	48 pz	✓	
9615-006-50	Ø 180	Ø 125/160	-	48 pz	✓	
9611-002-06/60	Ø 145	Ø 80/125	100	100 pz	✗	
9611-002-40	Ø 145	Ø 80/125	100	100 pz	✗	
9611-002-50	Ø 145	Ø 80/125	100	100 pz	✗	
9615-002-06/60	Ø 180	Ø 125/160	100	48 pz	✗	
9615-002-40	Ø 180	Ø 125/160	100	48 pz	✗	
9615-002-50	Ø 180	Ø 125/160	100	48 pz	✗	

COD.	COL.	RAL
06	<input type="checkbox"/>	9002 Bianco ghiaccio
		9002 Blanco hielo
		9002 Grey white
40	<input type="checkbox"/>	Cromata
		Cromada
		Chrome-colored
50	<input type="checkbox"/>	Ramata
		De cobre
		Copper-colored
60	<input type="checkbox"/>	8017 Marrone
		8017 Marrón
		8017 Brown



Alette inclinate
Lamas inclinadas
Inclined fins

COD.	Ø					€
9604-006-06	Ø 166	Ø 80/125	-	48 pz	✓	
9603-006-06	Ø 190	Ø 125/160	-	48 pz	✓	
9616-006-06	Ø 220	Ø 160/200	-	48 pz	✓	
9616-006-40	Ø 220	Ø 160/200	-	48 pz	✓	
9616-006-50	Ø 220	Ø 160/200	-	48 pz	✓	
9605-006-06	Ø 262	Ø 200/260	-	48 pz	✓	
9604-002-06	Ø 166	Ø 80/125	100	48 pz	✗	
9603-002-06	Ø 190	Ø 80/125	130	48 pz	✗	
9616-002-06	Ø 220	Ø 80/125	210	48 pz	✗	
9616-002-40	Ø 220	Ø 125/160	210	48 pz	✗	
9616-002-50	Ø 220	Ø 125/160	210	48 pz	✗	
9605-002-06	Ø 262	Ø 125/160	300	48 pz	✗	

COD.	COL. RAL
06	<input type="checkbox"/> 9002 Bianco ghiaccio <input type="checkbox"/> 9022 Blanco hielo <input type="checkbox"/> 9002 Grey white
40	<input type="checkbox"/> Cromata <input type="checkbox"/> Cromada <input type="checkbox"/> Chrome-colored
50	<input type="checkbox"/> Ramata <input type="checkbox"/> De cobre <input type="checkbox"/> Copper-colored



Alette dritte
Lamas rectas
Straight fins



Patented System

COD.	Ø					€
9604-252-06	Ø 166	Ø 80/125	80	48 pz	✓	
9603-252-06	Ø 190	Ø 125/160	100	48 pz	✓	



GRIGLIA CIRCOLARE CHIUDI E APRI in materiale termoplastico con molla e rete reclinabile a 90°

REJILLA REDONDA CON ABERTURA Y CIERRE en material termoplastico con muelle reclinable a 90° y red

ROUND OPEN-CLOSE GRILLE in thermoplastic with 90° reclining spring and mesh

La griglia "CHIUDI e APRI" consente l'applicazione in opera dall'interno senza l'utilizzo di scale o ponteggi. È dotata di un filo che permette di eseguire il posizionamento all'esterno in totale sicurezza.

La rejilla con "abertura y cierre" permite la instalación desde el interior sin utilizar andamiaje. Suministrada con hilo que permite el posicionamiento al exterior en total seguridad.

The "open-close" grille allows the installation from inside the building without using scaffolds. Provided with a thread to facilitate the installation, it can be safely positioned externally.



Squadretta di sicurezza ferma filo in dotazione

Escuadra de seguridad para detener el hilo en dotación

Thread-fixing safety square provided

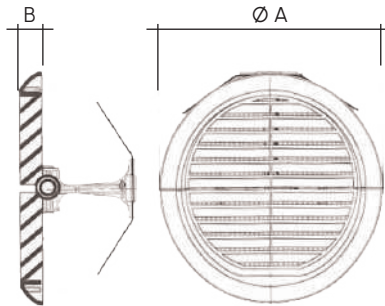

COD.	Ø	A	B				€
9829-006-06	Ø 170	Ø 170	15	Ø 100/140	36 pz	✓	

Adattabile per fori da Ø 100 a Ø 140 mm

Adaptable para agujeros de Ø 100 a Ø 140

Suitable for bounds from Ø 100 a Ø 140

MONTAGGIO | MONTAJE | ASSEMBLY



Fissare la squadretta di sicurezza
Asegure el soporte de seguridad
Secure the safety bracket

GRIGLIE CIRCOLARI DA INCASSO in materiale termoplastico con telaio
REJILLAS REDONDAS EMPOTRADAS de termoplástico con marco
RECESSED ROUND GRILL in thermoplastic with frame

Griglie circolari in materiale termoplastico. Il telaio viene fissato a muro tramite viti. La griglia viene inserita ad incastro. Con o senza rete.

Rejillas redondas de termoplástico. El marco va fijado a la pared por medio de tornillos y la rejilla se encaja. Con o sin red.

Round thermoplastic grilles. The frame is fixed on the wall by screws. The grill is inserted into the frame. With or without mesh.

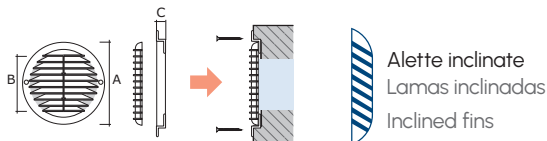

Alette inclinate
Lamas inclinadas
Inclined fins



COD.	Ø	A	B	C				€
9604-005-06	Ø 166	Ø 195	Ø 168	20	-	52 pz	✓	
9603-005-06	Ø 190	Ø 217	Ø 194	20	-	40 pz	✓	
9604-003-06	Ø 166	Ø 195	Ø 168	20	100	52 pz	✗	
9603-003-06	Ø 190	Ø 217	Ø 194	20	130	40 pz	✗	

GRIGLIE CIRCOLARI DA INCASSO in materiale termoplastico con telaio - DA INTERNI
REJILLAS REDONDAS EMPOTRADAS de termoplástico con marco - DE INTERIOR
RECESSED ROUND GRILL in thermoplastic with frame - INDOOR USE

Griglie circolari da interni in materiale termoplastico ad alette dritte e rete stampata. Il telaio viene fissato a muro tramite viti. La griglia viene inserita ad incastro.

Rejillas redondas de interior de termoplástico con lamas rectas y red estampada. El marco va fijado a la pared por medio de tornillos y la rejilla se encaja.

Round thermoplastic grilles with straight fins and injected mesh for indoor use. The frame is fixed on the wall by screws. The grill is inserted into the frame.

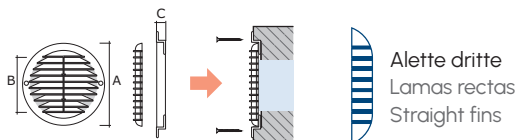



Alette dritte
Lamas rectas
Straight fins







COD.	Ø	A	B	C				€
9604-253-06	Ø 166	Ø 195	Ø 168	20	80	52 pz	✓	
9603-253-06	Ø 190	Ø 217	Ø 168	20	100	40 pz	✓	

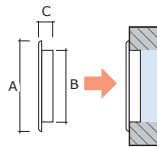
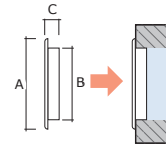

GRIGLIE CIRCOLARI DA INCASSO in materiale termoplastico con e senza rete applicata
REJILLAS REDONDAS EMPOTRADAS de termoplástico con o sin red aplicada
RECESSED ROUND GRILL in thermoplastic with or without applied mesh

COD.	Ø	A	B	C				€
9614-004-06	Ø 60	Ø 70	Ø 57	20	-	102 pz	✓	
9609-004-06	Ø 80	Ø 90	Ø 75	20	-	102 pz	✓	
9608-004-06	Ø 100	Ø 120	Ø 95	20	-	102 pz	✓	
9610-004-06	Ø 125	Ø 145	Ø 121	20	-	102 pz	✓	
9617-004-06	Ø 160	Ø 190	Ø 156	17	-	50 pz	✓	
9618-004-06	Ø 200	Ø 238	Ø 200	23	-	30 pz	✓	
9614-001-06	Ø 60	Ø 70	Ø 57	20	20	102 pz	X	
9609-001-06	Ø 80	Ø 90	Ø 75	20	30	102 pz	X	
9608-001-06	Ø 100	Ø 120	Ø 95	20	40	102 pz	X	
9610-001-06	Ø 125	Ø 145	Ø 121	20	65	102 pz	X	
9617-001-06	Ø 160	Ø 190	Ø 156	17	135	50 pz	X	
9618-001-06	Ø 200	Ø 238	Ø 200	23	220	30 pz	X	



COD.	Ø	A	B	C				€
9611-005-06	Ø 120	Ø 145	Ø 118	20	-	52 pz	✓	
9611-003-06	Ø 120	Ø 145	Ø 118	20	100	52 pz	X	

GRIGLIE CIRCOLARI in materiale termoplastico senza rete
REJILLAS REDONDAS EMPOTRADAS de termoplástico sin red
RECESSED ROUND GRILL in thermoplastic without mesh

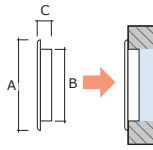

COD.	Ø	A	B	C		€
9750-081-01	Ø 100	Ø 124	Ø 100	27	50 pz	
9750-082-01	Ø 120	Ø 148	Ø 127	27	24 pz	

GRIGLIE TONDE DA SOFFITTO IN ABS CON RETE
REJILLAS REDONDAS DE ABS CON RED PARA TECHO
ROUND ABS CEILING MOUNTING GRILLES WITH MESH

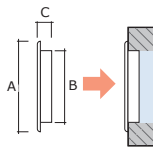

COD.	Ø	A	B	C		€
9751-060-01	Ø 100	Ø 144	Ø 99	58	24 pz	
9751-061-01	Ø 125	Ø 165	Ø 124	62	24 pz	
9751-062-01	Ø 150	Ø 188	Ø 149	65	24 pz	

GRIGLIE QUADRATE DA SOFFITTO IN ABS CON IMBOCCO E RETE
REJILLAS CUADRADAS DE ABS PARA TECHO CON ENTRADA REDONDA Y RED
SQUARE ABS CEILING MOUNTING GRILLES WITH ROUND ENTRANCE AND MESH

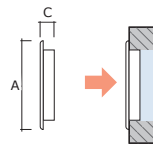

COD.	Ø	A	C		€
9751-070-01	Ø 100	150x150	25	24 pz	
9751-071-01	Ø 125	150x150	25	24 pz	
9751-072-01	Ø 150	150x150	25	24 pz	



GRIGLIE QUADRATE UNIVERSALI in materiale termoplastico con molle reclinabili a 90°
REJILLAS CUADRADAS UNIVERSALES de termoplástico con muelles reclinables a 90°
SQUARE UNIVERSAL GRILLES in thermoplastic with reclining springs at 90°



COD.						€
9602-006-06	166x166	Ø 80/125	-	48 pz	✓	
9601-006-06	190x190	Ø 125/160	-	48 pz	✓	
9600-006-06	238x238	Ø 160/200	-	48 pz	✓	
9602-002-06	166x166	Ø 80/125	120	48 pz	X	
9601-002-06	190x190	Ø 125/160	160	48 pz	X	
9600-002-06	238x238	Ø 160/200	270	48 pz	X	



COD.						€
9602-252-06	166x166	Ø 80/125	120	48 pz	✓	
9601-252-06	190x190	Ø 125/160	160	48 pz	✓	
9600-252-06	238x238	Ø 160/200	270	48 pz	✓	

GRIGLIE QUADRATE AD INCASSO in materiale termoplastico con telaio REJILLAS CUADRADAS EMPOTRADAS de termoplástico con marco RECESSED ROUND GRILL in thermoplastic with frame

Griglie quadrate in materiale termoplastico. Il telaio viene fissato a muro tramite viti. La griglia viene inserita ad incastro. Con o senza rete.

Rejilla cuadrada de termoplástico. El marco va fijado a la pared por medio de tornillos y la rejilla se encaja. Con o sin red.

Square thermoplastic grilles. The frame is fixed on the wall by screws. The grill is inserted into the frame. With or without mesh.

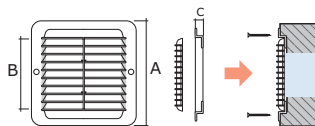
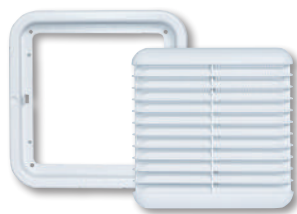

Alette inclinate
Lamas inclinadas
Inclined fins



COD.		A	B	C				€
9602-005-06	166x166	193x193	170x170	20	-	52 pz	✓	
9601-005-06	190x190	217x217	194x194	20	-	40 pz	✓	
9600-005-06	238x238	265x265	242x242	20	-	48 pz	✓	
9602-003-06	166x166	193x193	170x170	20	120	52 pz	✗	
9601-003-06	190x190	217x217	194x194	20	160	40 pz	✗	
9600-003-06	238x238	265x265	242x242	20	270	48 pz	✗	

Griglie quadrate in materiale termoplastico da interni con alette dritte e rete stampata. Il telaio viene fissato a muro tramite viti. La griglia viene inserita ad incastro.

Rejillas cuadradas de termoplástico para interiores con lamas rectas y red estampada. El marco va fijado a la pared por medio de tornillos y la rejilla se encaja.

Square thermoplastic grilles with straight fins and injected mesh for indoor use. The frame is fixed on the wall by screws. The grill is inserted into the frame.

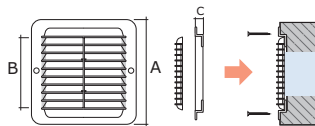
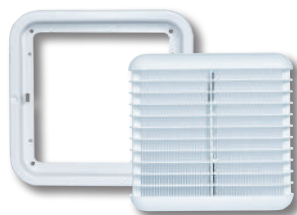

Alette dritte
Lamas rectas
Straight fins





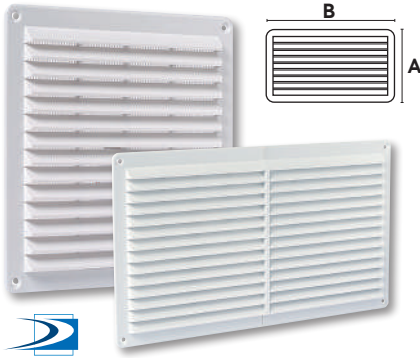

COD.		A	B	C				€
9602-253-06	166x166	193x193	170x170	20	100	52 pz	✓	
9601-253-06	190x190	217x217	194x194	20	120	40 pz	✓	
9600-253-06	238x238	265x265	242x242	20	210	48 pz	✓	

GRIGLIE QUADRATE E RETTANGOLARI DA APPOGGIO in materiale termoplastico REJILLAS CUADRADAS Y RECTANGULARES DE APOYO de termoplástico SQUARE AND RECTANGULAR FREE-STANDING GRILLES in thermoplastic

Griglie in materiale termoplastico quadrate e rettangolari da appoggio. Con e senza rete.
Rejillas de termoplástico cuadradas y rectangulares de apoyo. Con o sin red.
Square and rectangular thermoplastic free-standing grilles. With or without mesh.



COD.	 AxB				€
9619-004-06	150x200	-	52 pz	✓	
9620-004-06	230x230	-	60 pz	✓	
9621-004-06	230x430	-	27 pz	✓	
9622-004-06	230x620	-	16 pz	✓	
9619-001-06	150x200	140	52 pz	✗	
9620-001-06	230x230	210	60 pz	✗	
9621-001-06	230x430	420	27 pz	✗	
9622-001-06	230x620	630	16 pz	✗	





Griglie quadrate in materiale termoplastico, da appoggio, per interni, con alette dritte. Con rete stampata e predisposizione foro viti.

Rejillas cuadradas de termoplástico de apoyo con lammas rectas y red. Con red estampada y predisposición agujeros para los tornillos.

Square thermoplastic free-standing grilles for indoor use with straight fins. With injected mesh and pre-marked screw holes.



Predisposizione foro viti
Predisposición agujeros para los tornillos
Pre-marked screw holes

COD.					€
9602-251-06	166x166	100	64 pz	✓	
9601-251-06	190x190	120	60 pz	✓	
9600-251-06	238x238	210	60 pz	✓	





Griglie quadrate in materiale termoplastico da appoggio con predisposizione foro viti. Con e senza rete.

Rejillas cuadradas de termoplástico de apoyo con predisposición agujeros para los tornillos. Con o sin red.

Square thermoplastic free-standing grilles with pre-marked screw holes. With or without mesh.



Predisposizione foro viti
Predisposición agujeros para los tornillos
Pre-marked screw holes



COD.					€
9602-004-06	166x166	-	64 pz	✓	
9601-004-06	190x190	-	60 pz	✓	
9600-004-06	238x238	-	60 pz	✓	
9602-001-06	166x166	120	64 pz	✗	
9601-001-06	190x190	160	60 pz	✗	
9600-001-06	238x238	270	60 pz	✗	

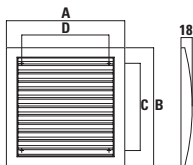

GRIGLIE QUADRATE E RETTANGOLARI DA APPOGGIO IN ABS REJILLAS CUADRADAS Y RECTANGULARES DE ABS DE APOYO SQUARE AND RECTANGULAR ABS FREE-STANDING GRILLES

Fissaggio tramite viti.
Fijación por medio de tornillos.
To be fixed by screws.



COD.	 AxB	 CxD		€
9751-001-01	150x150	95x110	85 pz	
9751-002-01	190x190	140x140	65 pz	
9751-003-01	170x250	220x150	50 pz	
9751-004-01	140x300	260x120	60 pz	

GRIGLIE COMPONIBILI CON MODULI 100X100 MM REJILLAS COMPONIBLES CON MÓDULOS 100X100 MM MODULAR GRILLES WITH 100X100 MM MODULES

Sistema di incastro a coda di rondine. Altezza (230 mm). Lunghezza a moduli con rete applicata.
Enclavamiento de cola de milano. Altura (230mm). Longitud a módulo con red aplicada.
Lock dovetail system. Height (230 mm). Module length with applied mesh.

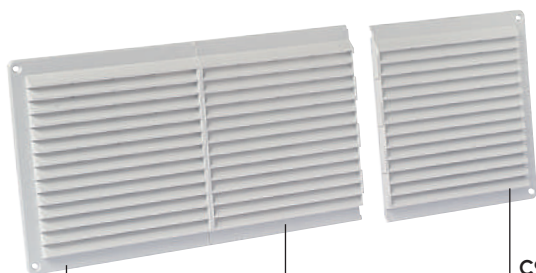



C96.011.06 (sx)
Modulo Sinistro
Módulo izquierdo
L module

C96.012.06 (ce)
Modulo centrale
Módulo central
Central module

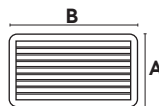
C96.010.06 (dx)
Modulo Destro
Módulo derecho
R module



	COD.	 AxB			€
DX	C96.010.06	230x210	210	4 pz	
SX	C96.011.06	230x210	210	4 pz	
CE	C96.012.06	230x200	210	4 pz	





installation example



COPPIE DI GRIGLIE CIRCOLARI in materiale termoplastico con molle
PAR DE REJILLAS REDONDAS de termoplástico con muelles
PAIR OF ROUND GRILLES in thermoplastic with springs

Esterna con rete ed alette inclinate, interna senza rete e con alette dritte.
 Externa con red y lamaz inclinadas, interna sin red y con lamaz rectas.
 External with mesh and inclined fins, internal without mesh and with straight fins.



COD.	Ø				€
9604-752-06	Ø 166	Ø 80/125	100/80	25 cp	
9603-752-06	Ø 190	Ø 125/160	130/100	25 cp	

COPPIE DI GRIGLIE CIRCOLARI ESTERNA-INTERNA in materiale termoplastico con telaio
PAR DE REJILLAS REDONDAS EXTERNA-INTERNA de termoplástico con marco
PAIR OF ROUND EXTERNAL-INTERNAL GRILLES in thermoplastic with frame

Il telaio viene fissato a muro tramite viti. La griglia viene inserita ad incastro.
 El marco va fijado a la pared por medio de tornillos y la rejilla se encaja.
 The frame is fixed on the wall by screws. The grill is inserted into the frame.

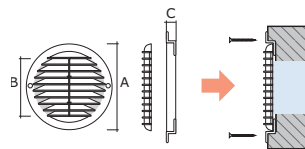

COD.	Ø	A	B	C			€
9604-753-06	Ø 166	Ø 195	Ø 168	20	100/80	25 cp	
9603-753-06	Ø 190	Ø 217	Ø 194	20	130/100	25 cp	

COPPIE DI GRIGLIE QUADRATE ESTERNE-INTERNE in materiale termoplastico con molle
PAR DE REJILLAS CUADRADAS EXTERNA-INTERNA de termoplástico con muelles
PAIR OF SQUARE EXTERNAL-INTERNAL GRILLES in thermoplastic with springs



COD.					€
9602-752-06	166x166	Ø 80/125	120/100	25 cp	
9601-752-06	190x190	Ø 125/160	160/120	25 cp	
9600-752-06	238x238	Ø 160/200	270/210	25 cp	

COPPIE DI GRIGLIE QUADRATE ESTERNA - INTERNA DA APPOGGIO in materiale termoplastico
PAR DE REJILLAS CUADRADAS DE APOYO EXTERNA - INTERNA de termoplástico
PAIR OF FREE-STANDING EXTERNAL - INTERNAL GRILLES in thermoplastic

Con predisposizione foro viti.
 Predisposición agujeros para los tornillos.
 Pre-marked screw holes.

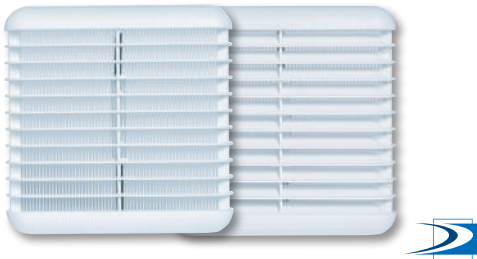

COD.				€
9602-751-06	166x166	120/100	32 cp	
9601-751-06	190x190	160/120	32 cp	
9600-751-06	238x238	270/210	32 cp	

Il telaio viene fissato a muro tramite viti. La griglia viene inserita ad incastro.
 El marco va fijado a la pared por medio de tornillos y la rejilla se encaja.
 The frame is fixed on the wall by screws. The grill is inserted into the frame.

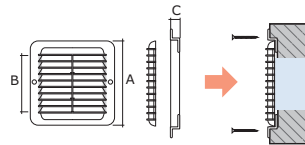

COD.		A	B	C			€
9602-753-06	166x166	193x193	170x170	20	120/100	25 cp	
9601-753-06	190x190	217x217	194x194	20	160/120	25 cp	
9600-753-06	238x238	265x265	242x242	20	270/210	25 cp	





GRIGLIE QUADRATE E RETTANGOLARI IN ABS REJILLAS CUADRADAS Y RECTANGULARES DE ABS SQUARE AND RECTANGULAR ABS GRILLES

Apribile-chiudibile, con rete e fori per il fissaggio tramite viti. Disponibili in versione semplice o con imbocco tondo da incasso.

Con regulación, con red y agujeros para fijación por medio de tornillos. Se suministra en una versión simple o con entrada redonda empotrada.

Open-close system, with mesh and pre-marked holes to fix the grill with screws. Available both in standard version and with recessed round entrance.



COD.	 AxB	 CxD			€
9751-020-01	150x150	95x110	-	85 pz	
9751-021-01	190x190	140x140	-	65 pz	
9751-040-01	150x150	95x110	100	100 pz	
9751-041-01	190x190	140x140	125	30 pz	
9751-042-01	190x190	140x140	150	30 pz	

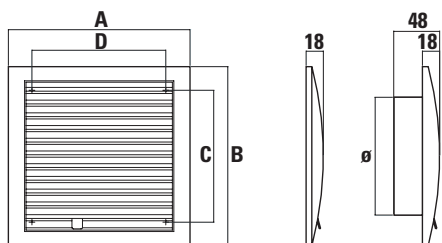



Apribile-chiudibile, con rete e fori per il fissaggio tramite viti.

Con regulación, con red y agujeros para fijación por medio de tornillos.

Open-close system, with mesh and pre-marked holes to fix the grill with screws.



COD.	 AxB	 CxD		€
9751-022-01	170x250	220x150	50 pz	
9751-023-01	140x300	260x120	50 pz	

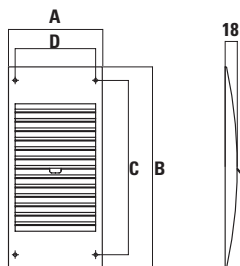

GRIGLIE A GRAVITÀ IN ABS REJILLAS DE GRAVEDAD DE ABS ABS GRAVITY GRILLES

Disponibile in versione semplice per fissaggio tramite viti o con imbocco tondo da incasso. Colori disponibili: Bianco, Avorio, Antracite e Marrone.



Se suministran con fijación por medio de tornillos o entrada redonda empotrada. Colores disponibles: Blanco, Marfil, Antracita y Marrón.

Available both in standard version to be fitted with screws and with round recessed entrance. Available colors: White, Ivory, Anthracite and Brown.

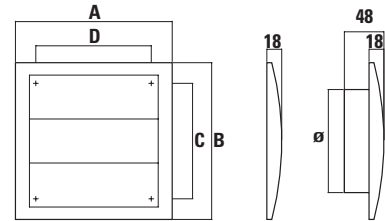

COD.	COL.	RAL
01	<input type="checkbox"/>	9003 Bianco 9003 Blanco 9003 White





COD.	 AxB	 CxD			€
9751-080-01	150x150	95x110	-	50 pz	
9751-081-01	190x190	140x140	-	50 pz	
9751-011-01	150x150	95x110	100	30 pz	
9751-010-01	190x190	140x140	125	30 pz	
9751-009-01	190x190	140x140	150	30 pz	

GRIGLIE A FLUSSO REGOLABILE QUADRATE REJILLAS CUADRADAS DE FLUJO REGLABLE GRILLES WITH ADJUSTABLE AIR-FLOW

Con fissaggio tramite viti. Apribile/chiudibile con cordino.
Senza rete.

Fijación por medio de tornillos. Posibilidad de abrir/cerrar por medio de cordón. Sin red..

Fixing by screws. Pull-cord operated. Without mesh.

COD.			€
9750-031-01	160x160	24 pz	
9750-032-01	200x200	24 pz	
9750-033-01	200x250	24 pz	



VALVOLE A FLUSSO REGOLABILE DI ESTRAZIONE ARIA IN ABS
VÁLVULAS DE FLUJO REGULABLES PARA EXTRACCIÓN DEL AIRE DE ABS
ABS DUCT VALVES WITH ENTRANCE

COD.	Ø		€
9750-061-01	Ø 100	6 pz	
9750-063-01	Ø 125	6 pz	
9750-062-01	Ø 150	6 pz	
9750-065-01	Ø 200	6 pz	



GRIGLIA CIRCOLARE DA INCASSO in materiale termoplastico
REJILLA REDONDA EMPOTRADAS de termoplástico
ROUND RECESSED GRILL in thermoplastic

Il collare posteriore è formato da 3 elementi posizionabili su qualsiasi diametro compreso tra Ø 100 e Ø 150 mm.

El collar posterior está formado por tres elementos adaptables a cualquier diámetro entre Ø 100 y Ø 150 mm.



The back entrance is composed of three parts which can be adjusted to fit any diameters from Ø 100 to Ø 150 mm.

COD.		€
9750-079-01	48 pz	

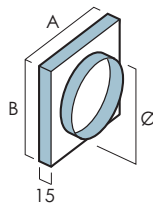

BOCCHETTA ANTIVENTO CON DISPOSITIVO A GRAVITÀ AD IMBOCCO CIRCOLARE
REJILLA ANTI-VIENTO CON DISPOSITIVO DE GRAVEDAD CON ENTRADA CIRCULAR
WINDPROOF GRILL WITH GRAVITY DEVICE AND CIRCULAR ENTRANCE



COD.	 AxB	Ø		€
9750-001-01	190x190	100	10 pz	







COPPIA DI GRIGLIE IN MATERIALE TERMOPLASTICO TRASPARENTE PAR DE REJILLAS DE TERMOPLÁSTICO TRANSPARENTE PAIR OF THERMOPLASTIC TRANSPARENT GRILLES

Fornite con rete anti insetti, specifica per installazione su vetro.

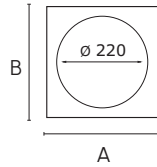
Se suministran con red anti-mosquito, específicas para instalación en la ventana

Supplied with mosquito-net, specific for windows installation.





COD.	 AxB	 Ø		€
9799-070	240x240	Ø 220	260	

Fornite con rete anti insetti, specifica per installazione su vetro.

Se suministran con red anti-mosquito, específicas para instalación en la ventana

Supplied with mosquito-net, specific for windows installation.



COD.	 Ø		€
9799-060	Ø 160	138	

AERATORI TERMICI AIREADORES TÉRMICOS THERMAL VENTILATORS

Con griglia anti-pioggia con o senza ventola, con chiusura a cordicella, con rete di protezione.

Con rejilla anti-lluvia con o sin hélices, con cierre tirador, con red de protección.

With anti-rain grill with or without fan, pullcord operated, with or without flyscreen.



COD.	 Ø	INFO.	€
9799-025	Ø 160	Con ventola Con ventilador	
9799-026	Ø 200	With fan	
9799-030	Ø 160	Senza ventola con retina di protezione	
9799-032	Ø 200	Sin ventilador; con red de protección	
		Without fan with flyscreen	
9799-002	Ø 120	Con chiusura a cordicella	
9799-004	Ø 160	Cierre mediante tirador	
9799-006	Ø 200	Pullcord operated	

AERATORI CIRCOLARI DA INCASSO in materiale termoplastico per interno mobili
AIREADORES EMPOTRADOS CIRCULARES de termoplástico para muebles
CIRCULAR RECESSED AERATORS in thermoplastic for furniture

Disponibili in vari colori.
 Disponibles en varios colores.
 Available in different colors.

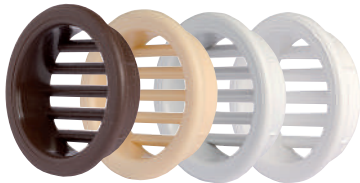
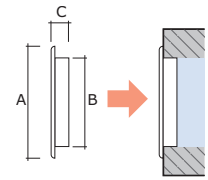

COD.	Ø	A	B	C			€
22129-☐	Ø 32	Ø 39	Ø 32	8	5	100 pz	



COD.	Ø	A	B	C			€
22128-☐	Ø 60	Ø 67	Ø 61	10	10	100 pz	
22127-☐	Ø 70	Ø 77	Ø 71	10	15	100 pz	

GRIGLIE DA INCASSO IN MATERIALE TERMOPLASTICO PER ANTE CUCINA
AIREADORES EMPOTRADOS DE TERMOPLÁSTICO PARA PUERTAS DE COCINA
RECESSED GRILLES IN THERMOPLASTIC FOR KITCHEN DOORS

Ventilazione frigorifero.
 Ventilación del frigorífico.
 Fridge ventilation.

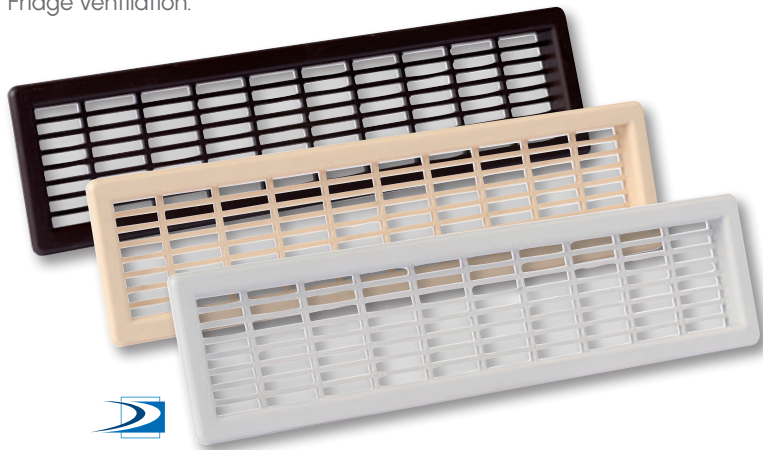

COD.	COL. RAL
01	☐ 9003 Bianco 9003 Blanco 9003 White
11	☐ 1013 Bianco perla 1013 Blanco ostra 1013 Oyster white
06	■ 9002 Bianco ghiaccio 9002 Blanco hielo 9002 Grey White
07	☐ 9010 Bianco puro 9010 Blanco puro 9010 Pure White
60	■ 8017 Marrone 8017 Marrón 8017 Brown

COD.			C		€
20755-☐	180x45	170x35	8	50 pz	

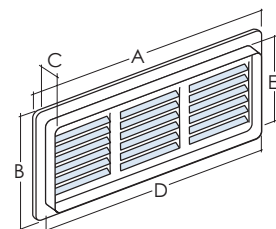







GRIGLIE RETTANGOLARI DA INCASSO in materiale termoplastico
REJILLAS RECTANGULARES EMPOTRADAS de termoplástico
RECTANGULAR RECESSED GRILLES in thermoplastic

Griglie rettangolari in materiale termoplastico da incasso. Con o senza rete.
 Disponibile in vari colori. Fissaggio tramite viti.

Rejillas rectangulares empotradas de termoplástico. Con o sin red.
 Se suministran en varios colores. Fijación por medio de tornillos.

Rectangular recessed grilles in thermoplastic. With or without mesh.
 Available in different colors. Fixing with screws.



COD.	 AxB	 CxD	 C				€
9613-004- <input checked="" type="checkbox"/>	270x120	254x104	20	-	60 pz	✓	
9606-004- <input checked="" type="checkbox"/>	370x123	335x95	20	-	60 pz	✓	
9612-004- <input checked="" type="checkbox"/>	370x223	335x185	20	-	30 pz	✓	
9613-001- <input checked="" type="checkbox"/>	270x120	254x104	20	150	60 pz	✗	
9606-001- <input checked="" type="checkbox"/>	370x123	335x95	20	170	60 pz	✗	
9612-001- <input checked="" type="checkbox"/>	370x223	335x185	20	400	30 pz	✗	

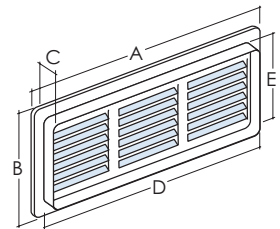



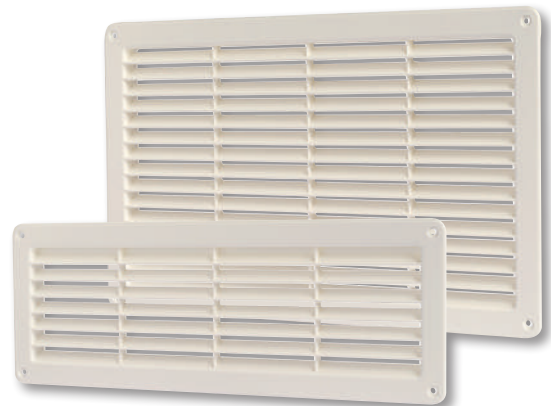

COD.	COL. RAL
06	<input checked="" type="checkbox"/> 9002 Bianco ghiaccio 9002 Blanco hielo 9002 Grey White
07	<input type="checkbox"/> 9010 Bianco puro 9010 Blanco puro 9010 Pure White
60	<input checked="" type="checkbox"/> 8017 Marrone 8017 Marrón 8017 Brown
95	<input checked="" type="checkbox"/> 9011 Nero grafite 9011 Nero grafito 9011 Graphite Black



GRIGLIE DA APPOGGIO in materiale termoplastico REJILLAS DE APOYO de termoplástico FREE-STANDING GRILLES in thermoplastic

Con e senza rete. Fissaggio tramite viti.
Con o sin red. Fijación con tornillos.
With or without mesh. Fixing with screws.





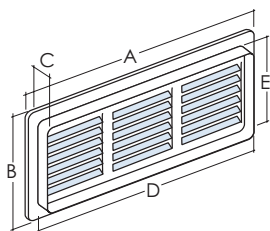
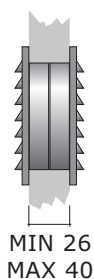

COD.					€
9607-004-06	230x80	-	102 pz	✓	
9607-001-06	230x80	35	102 pz	✗	

GRIGLIE TELESCOPICHE in materiale termoplastico REJILLAS TELESCÓPICAS de termoplástico TELESCOPIC GRILLES in thermoplastic

Per porte adattabili a diversi spessori. Disponibili in vari colori.
Para puertas, ajustables a espesores distintos. Se suministran en varios colores.
For doors, adjustable to different thickness. Available in different colors.



COD.	 AxB	 CxD			€
9613-050-☐	270x120	254x104	150	30 pz	
9750-050-☐	453x90	430x70	200	40 pz	
9750-051-☐	480x98	445x80	250	40 pz	

COD.	COL. RAL
06	☐ 9002 Bianco ghiaccio 9002 Blanco hielo 9002 Grey White
07	☐ 9010 Bianco puro 9010 Blanco puro 9010 Pure White
60	■ 8017 Marrone 8017 Marrón 8017 Brown
95	■ 9011 Nero grafite 9011 Nero grafito 9011 Graphite Black



GRIGLIE IN ACCIAIO INOX | GRIGLIE IN RAME | GRIGLIE IN ALLUMINIO
REJILLAS DE ACERO INOX | REJILLAS DE COBRE | REJILLAS DE ALUMINIO
STAINLESS STEEL GRILLES | ROUND COPPER GRILLES | ROUND ALUMINIUM GRILLES

Da incasso, fornite con pellicola protettiva antigraffio sul frontale. Con o senza rete in fibra di vetro.
 Empotradas se suministran con película de protección antirañazo. Con o sin red de fibra de vidrio.
 Recessed grilles, with anti-scratch and protective film. With or without in glass fiber mesh.



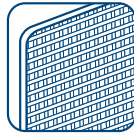

Con pellicola protettiva antigraffio
 Con película de protección antirañazo
 With anti-scratch and protective film

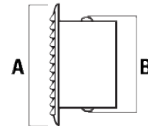

Rete in fibra di vetro
 Red de fibra de vidrio
 Glass fiber mesh



CARATTERISTICHE TECNICHE
CARACTERÍSTICAS TÉCNICAS
TECHNICAL FEATURES

COD.	Ø	A	B			
9700-004-☑	Ø 80	Ø 110	Ø 77/80	-	24 pz	✓
9701-004-☑	Ø 100	Ø 130	Ø 96/100	-	24 pz	✓
9702-004-☑	Ø 120	Ø 150	Ø 116/120	-	24 pz	✓
9703-004-☑	Ø 140	Ø 180	Ø 138/142	-	24 pz	✓
9704-004-☑	Ø 150	Ø 180	Ø 146/150	-	24 pz	✓
9710-004-☑	Ø 160	Ø 180	Ø 156/160	-	24 pz	✓
9705-004-☑	Ø 200	Ø 240	Ø 190/194	-	24 pz	✓
9700-001-☑	Ø 80	Ø 110	Ø 77/80	35	24 pz	✗
9701-001-☑	Ø 100	Ø 130	Ø 96/100	50	24 pz	✗
9702-001-☑	Ø 120	Ø 150	Ø 116/120	60	24 pz	✗
9703-001-☑	Ø 140	Ø 180	Ø 138/142	75	24 pz	✗
9704-001-☑	Ø 150	Ø 180	Ø 146/150	80	24 pz	✗
9710-001-☑	Ø 160	Ø 180	Ø 156/160	85	24 pz	✗
9705-001-☑	Ø 200	Ø 240	Ø 190/194	130	24 pz	✗

ACCIAIO INOX | ACERO INOX
STAINLESS STEEL

COD.	€
9700-004-400	
9701-004-400	
9702-004-400	
9703-004-400	
9704-004-400	
9710-004-400	
9705-004-400	
9700-001-400	
9701-001-400	
9702-001-400	
9703-001-400	
9704-001-400	
9710-001-400	
9705-001-400	

RAME | COBRE | COPPER

COD.	€
9700-004-500	
9701-004-500	
9702-004-500	
9703-004-500	
9704-004-500	
9710-004-500	
9705-004-500	
9700-001-500	
9701-004-500	
9702-004-500	
9703-004-500	
9704-004-500	
9710-004-500	
9705-001-500	

ALLUMINIO | ALUMINIO
ALUMINIUM

COD.	€
9700-004-600	
9701-004-600	
9702-004-600	
9703-004-600	
9704-004-600	
9710-004-600	
9705-004-600	
9700-001-600	
9701-004-600	
9702-004-600	
9703-004-600	
9704-004-600	
9710-004-600	
9705-001-600	



GRIGLIE CIRCOLARI UNIVERSALI IN ACCIAIO INOX REJILLAS REDONDAS UNIVERSALES DE ACERO INOX ROUND UNIVERSAL STAINLESS STEEL GRILLES

Con molle, fornite con pellicola protettiva antigraffio sul frontale. Con o senza rete in fibra di vetro.
Con muelles, se suministran con película de protección antirañazo. Con o sin red de fibra de vidrio.
With springs and anti-scratch protective film. With or without glass fiber mesh.

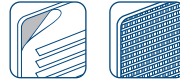

COD.	Ø					€
9699-806-400	Ø 130	Ø 80/125	-	25 pz	✓	
9692-806-400	Ø 150	Ø 80/125	-	25 pz	✓	
9698-806-400	Ø 180	Ø 125/160	-	25 pz	✓	
9697-806-400	Ø 240	Ø 160/200	-	20 pz	✓	
9699-802-400	Ø 130	Ø 80/125	80	25 pz	✗	
9692-802-400	Ø 150	Ø 80/125	110	25 pz	✗	
9698-802-400	Ø 180	Ø 125/160	150	25 pz	✗	
9697-802-400	Ø 240	Ø 160/200	250	20 pz	✗	

GRIGLIE CIRCOLARI UNIVERSALI IN RAME REJILLAS REDONDAS UNIVERSALES DE COBRE ROUND UNIVERSAL COPPER GRILLES

Con molle, fornite con pellicola protettiva antigraffio sul frontale. Con o senza rete in fibra di vetro.
Con muelles, se suministran con película de protección antirañazo. Con o sin red de fibra de vidrio.
With springs and anti-scratch protective film. With or without glass fiber mesh.



COD.	Ø					€
9699-806-500	Ø 130	Ø 80/125	-	25 pz	✓	
9692-806-500	Ø 150	Ø 80/125	-	25 pz	✓	
9698-806-500	Ø 180	Ø 125/160	-	25 pz	✓	
9697-806-500	Ø 240	Ø 160/200	-	20 pz	✓	
9699-802-500	Ø 130	Ø 80/125	80	25 pz	✗	
9692-802-500	Ø 150	Ø 80/125	110	25 pz	✗	
9698-802-500	Ø 180	Ø 125/160	150	25 pz	✗	
9697-802-500	Ø 240	Ø 160/200	250	20 pz	✗	

GRIGLIE CIRCOLARI UNIVERSALI IN ALLUMINIO

REJILLAS REDONDAS UNIVERSALES DE ALUMINIO

ROUND UNIVERSAL ALUMINIUM GRILLES

Con molle, fornite con pellicola protettiva antigraffio sul frontale. Con o senza rete in fibra di vetro.
 Con muelles, se suministran con película de protección antirrañazo. Con o sin red de fibra de vidrio.
 With springs and anti-scratch protective film. With or without glass fiber mesh.



COD.	Ø					€
9699-806-600	Ø 130	Ø 80/125	-	25 pz	✓	
9692-806-600	Ø 150	Ø 80/125	-	25 pz	✓	
9698-806-600	Ø 180	Ø 125/160	-	25 pz	✓	
9697-806-600	Ø 240	Ø 160/200	-	20 pz	✓	
9699-802-600	Ø 130	Ø 80/125	80	25 pz	✗	
9692-802-600	Ø 150	Ø 80/125	110	25 pz	✗	
9698-802-600	Ø 180	Ø 125/160	150	25 pz	✗	
9697-802-600	Ø 240	Ø 160/200	250	20 pz	✗	

GRIGLIE CIRCOLARI UNIVERSALI SMALTATE BIANCHE

REJILLAS REDONDAS UNIVERSALES ESMALTADAS COLOR BLANCO

ROUND UNIVERSAL STAINLESS STEEL GRILLES WHITE PAINTED

Con molle, fornite con pellicola protettiva antigraffio sul frontale. Con o senza rete in fibra di vetro.
 Con muelles, se suministran con película de protección antirrañazo. Con o sin red de fibra de vidrio.
 With springs and anti-scratch protective film. With or without glass fiber mesh.







COD.	Ø					€
9699-806-501	Ø 130	Ø 80/125	-	25 pz	✓	
9692-806-501	Ø 150	Ø 80/125	-	25 pz	✓	
9698-806-501	Ø 180	Ø 125/160	-	25 pz	✓	
9697-806-501	Ø 240	Ø 160/200	-	20 pz	✓	
9699-802-501	Ø 130	Ø 80/125	80	25 pz	✗	
9692-802-501	Ø 150	Ø 80/125	110	25 pz	✗	
9698-802-501	Ø 180	Ø 125/160	150	25 pz	✗	
9697-802-501	Ø 240	Ø 160/200	250	20 pz	✗	



GRIGLIE IN ACCIAIO INOX | REJILLAS DE ACERO INOX | STAINLESS STEEL GRILLES

Con molle, fornite con pellicola protettiva antigraffio sul frontale. Con o senza rete in fibra di vetro.
 Con muelles, se suministran con película de protección antirañazo. Con o sin red de fibra de vidrio.
 With springs and anti-scratch protective film. With or without glass fiber mesh.







COD.						€
9696-806-400	150x150	Ø 80/125	-	25 pz	✓	
9693-806-400	230x230	Ø 160/200	-	20 pz	✓	
9696-802-400	150x150	Ø 80/125	140	25 pz	✗	
9693-802-400	230x230	Ø 160/200	280	20 pz	✗	



Versione da appoggio senza molla, con predisposizione foro viti.
 Versión de apoyo sin muelles, con predisposición agujeros para los tornillos.
 Free-standing version without springs, with pre-marked screw holes.







COD.					€
9696-804-400	150x150	-	25 pz	✓	
9693-804-400	230x230	-	20 pz	✓	
9696-801-400	150x150	140	25 pz	✗	
9693-801-400	230x230	280	20 pz	✗	

GRIGLIE IN RAME | REJILLAS DE COBRE | COPPER GRILLES

Con molle, fornite con pellicola protettiva antigraffio sul frontale. Con o senza rete in fibra di vetro.
 Con muelles, se suministran con película de protección antirañazo. Con o sin red de fibra de vidrio.
 With springs and anti-scratch protective film. With or without glass fiber mesh.







COD.						€
9696-806-500	150x150	Ø 80/125	-	25 pz	✓	
9693-806-500	230x230	Ø 160/200	-	20 pz	✓	
9696-802-500	150x150	Ø 80/125	140	25 pz	✗	
9693-802-500	230x230	Ø 160/200	280	20 pz	✗	



Versione da appoggio senza molla, con predisposizione foro viti.
 Versión de apoyo sin muelles, con predisposición agujeros para los tornillos.
 Free-standing version without springs, with pre-marked screw holes.



COD.					€
9696-804-500	150x150	-	25 pz	✓	
9693-804-500	230x230	-	20 pz	✓	
9696-801-500	150x150	140	25 pz	✗	
9693-801-500	230x230	280	20 pz	✗	

GRIGLIE SMALTATE BIANCHE | REJILLAS ESMALTADAS COLOR BLANCO WHITE PAINTED GRILLES



Con molle, fornite con pellicola protettiva antigraffio sul frontale. Con o senza rete in fibra di vetro.
Con muelles, se suministran con película de protección antirañazo. Con o sin red de fibra de vidrio.
With springs, supplied with anti-scratch protective film. With or without glass fiber mesh.

COD.						€
9696-806-501	150x150	Ø 80/125	-	25 pz	✓	
9693-806-501	230x230	Ø 160/200	-	20 pz	✓	
9696-802-501	150x150	Ø 80/125	140	25 pz	✗	
9693-802-501	230x230	Ø 160/200	280	20 pz	✗	



Versione da appoggio senza molla, con predisposizione foro viti.
Versión de apoyo sin muelles, con predisposición agujeros para los tornillos.
Free-standing version without springs, with pre-marked screw holes.



COD.					€
9696-804-501	150x150	-	25 pz	✓	
9693-804-501	230x230	-	20 pz	✓	
9696-801-501	150x150	140	25 pz	✗	
9693-801-501	230x230	280	20 pz	✗	



GRIGLIE IN ALLUMINIO | REJILLAS DE ALUMINIO | ALUMINIUM GRILLES



Con molle, fornite con pellicola protettiva antigraffio sul frontale. Con o senza rete in fibra di vetro.
Con muelles, se suministran con película de protección antirañazo. Con o sin red de fibra de vidrio.
With springs, supplied with anti-scratch protective film. With or without glass fiber mesh.

COD.						€
9696-806-600	150x150	Ø 80/125	-	25 pz	✓	
9693-806-600	230x230	Ø 160/200	-	20 pz	✓	
9696-802-600	150x150	Ø 80/125	140	25 pz	✗	
9693-802-600	230x230	Ø 160/200	280	20 pz	✗	



Versione da appoggio senza molla, con predisposizione foro viti.
Versión de apoyo sin muelles, con predisposición agujeros para los tornillos.
Free-standing version without springs, with pre-marked screw holes.



COD.					€
9696-804-600	150x150	-	25 pz	✓	
9693-804-600	230x230	-	20 pz	✓	
9696-801-600	150x150	140	25 pz	✗	
9693-801-600	230x230	280	20 pz	✗	



GRIGLIE QUADRATE E RETTANGOLARI IN ACCIAIO INOX REJILLAS CUADRADAS Y RECTANGULARES DE ACERO INOX SQUARE AND RECTANGULAR STAINLESS STEEL GRILLES

Da appoggio, fornite con pellicola protettiva antigraffio sul frontale. Con o senza rete in fibra di vetro.

De apoyo, se suministran con película de protección antirañazo. Con o sin red de fibra de vidrio.

Free-standing, supplied with anti-scratch protective film. With or without glass fiber mesh.

140x140 mm

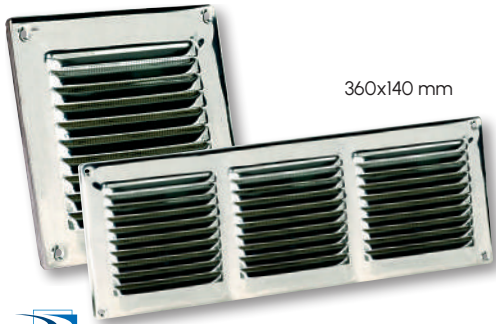

360x140 mm

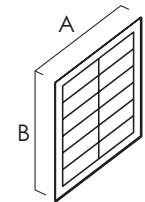

COD.	AxB				€
9691-804-400	140x140	-	50 pz	✓	
9695-804-400	250x140	-	25 pz	✓	
9694-804-400	360x140	-	25 pz	✓	
9690-804-400	470x140	-	25 pz	✓	
9691-801-400	140x140	100	50 pz	X	
9695-801-400	250x140	145	25 pz	X	
9694-801-400	360x140	215	25 pz	X	
9690-801-400	470x140	240	25 pz	X	

GRIGLIE QUADRATE E RETTANGOLARI IN RAME REJILLAS CUADRADAS Y RECTANGULARES DE COBRE SQUARE AND RECTANGULAR COPPER GRILLES

Da appoggio, fornite con pellicola protettiva antigraffio sul frontale. Con o senza rete in fibra di vetro.

De apoyo, se suministran con película de protección antirañazo. Con o sin red de fibra de vidrio.

Free-standing, supplied with anti-scratch protective film. With or without glass fiber mesh.

140x140 mm

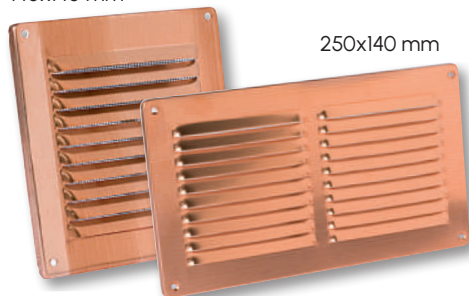

250x140 mm

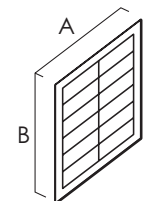

COD.	AxB				€
9691-804-500	140x140	-	50 pz	✓	
9695-804-500	250x140	-	25 pz	✓	
9694-804-500	360x140	-	25 pz	✓	
9690-804-500	470x140	-	25 pz	✓	
9691-801-500	140x140	100	50 pz	X	
9695-801-500	250x140	145	25 pz	X	
9694-801-500	360x140	215	25 pz	X	
9690-801-500	470x140	240	25 pz	X	

GRIGLIE QUADRATE E RETTANGOLARI IN ALLUMINIO

REJILLAS CUADRADAS Y RECTANGULARES DE ALUMINIO

SQUARE AND RECTANGULAR ALUMINIUM GRILLES

Da appoggio, fornite con pellicola protettiva antigraffio sul frontale. Con o senza rete in fibra di vetro.
 De apoyo, se suministran con película de protección antirañazo. Con o sin red de fibra de vidrio.
 Free-standing, supplied with anti-scratch protective film. With or without glass fiber mesh.

140x140 mm

250x140 mm

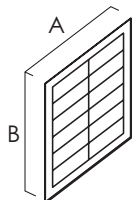

COD.	AxB				€
9691-804-600	140x140	-	50 pz	✓	
9695-804-600	250x140	-	25 pz	✓	
9694-804-600	360x140	-	25 pz	✓	
9690-804-600	470x140	-	25 pz	✓	
9691-801-600	140x140	100	50 pz	X	
9695-801-600	250x140	145	25 pz	X	
9694-801-600	360x140	215	25 pz	X	
9690-801-600	470x140	240	25 pz	X	

GRIGLIE QUADRATE E RETTANGOLARI SMALTATE BIANCHE

REJILLAS CUADRADAS Y RECTANGULARES ESMALTADAS COLOR BLANCO

SQUARE AND RECTANGULAR STAINLESS STEEL GRILLES WHITE PAINTED

Da appoggio, fornite con pellicola protettiva antigraffio sul frontale. Con o senza rete in fibra di vetro.
 De apoyo, se suministran con película de protección antirañazo. Con o sin red de fibra de vidrio.
 Free-standing, supplied with anti-scratch protective film. With or without glass fiber mesh.

140x140 mm

250x140 mm

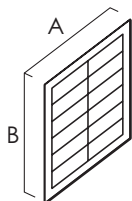

COD.	AxB				€
9691-804-501	140x140	-	50 pz	✓	
9695-804-501	250x140	-	25 pz	✓	
9694-804-501	360x140	-	25 pz	✓	
9690-804-501	470x140	-	25 pz	✓	
9691-801-501	140x140	100	50 pz	X	
9695-801-501	250x140	145	25 pz	X	
9694-801-501	360x140	215	25 pz	X	
9690-801-501	470x140	240	25 pz	X	

GRIGLIE IN MATERIALE TERMOPLASTICO
REJILLAS REDONDAS DE TERMOPLÁSTICO
ROUND GRILLES IN THERMOPLASTIC

POP-LINE
 by Vecamco

Griglie tonde universali in materiale termoplastico con rete stampata, fornite con molle da montare.
 Rejillas universales de termoplástico con muelles y red estampada; se suministran con muelles desmontados.
 Round universal grilles in thermoplastic with springs and injected mesh. Supplied with springs to be fitted by the customer.



COD.	Ø				€
9501-006-01	Ø 140	Ø 80/125	110	100 pz	
9502-006-01	Ø 175	Ø 125/160	150	50 pz	
9503-006-01	Ø 220	Ø 160/200	250	25 pz	

Griglie tonde da incasso in materiale termoplastico con rete stampata.
 Rejillas empotradas de termoplástico con red estampada.
 Round recessed grilles in thermoplastic with injected mesh.

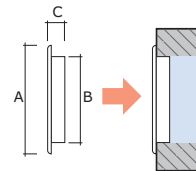

COD.	Ø	A	B	C			€
9520-004-01	Ø 60	Ø 70	Ø 57	20	20	102 pz	
9521-004-01	Ø 80	Ø 90	Ø 75	20	30	102 pz	
9522-004-01	Ø 100	Ø 120	Ø 95	20	40	102 pz	
9523-004-01	Ø 125	Ø 145	Ø 121	20	65	102 pz	
9524-004-01	Ø 160	Ø 190	Ø 156	17	135	100 pz	
9525-004-01	Ø 220	Ø 238	Ø 200	23	220	50 pz	

Griglie quadrate e rettangolari da appoggio in materiale termoplastico con rete stampata, fissaggio tramite viti.
 Rejillas cuadradas y rectangulares de termoplástico de apoyo con red estampada, fijación por medio de tornillos.
 Square and rectangular recessed grilles in thermoplastic with injected mesh, fixing with screws.



COD.				€
9505-004-01	150x200	140	50 pz	
9506-004-01	230x230	210	80 pz	
9507-004-01	230x430*	420	25 pz	
9508-004-01	230x620*	630	20 pz	





Fornite da assemblare | Se suministran desmontadas | Modules to be assembled



GRIGLIE IN METALLO
REJILLAS DE METAL
METAL GRILLES

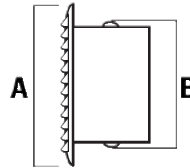

Griglie in rame da incasso fornite senza pellicola protettiva sul frontale. Con rete in metallo.
 Rejillas de cobre empotradas suministradas sin película de protección en el frente. Con red de metal.
 Recessed copper grilles supplied without protective film. With metal mesh.

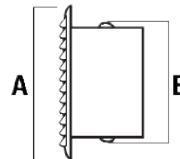

COD.	Ø	A	B			€
9700-004-500P	Ø 80	Ø 110	Ø 77/80	24 pz	✓	
9701-004-500P	Ø 100	Ø 130	Ø 96/100	24 pz	✓	
9702-004-500P	Ø 120	Ø 150	Ø 116/120	24 pz	✓	
9704-004-500P	Ø 150	Ø 180	Ø 146/150	24 pz	✓	

Griglie in alluminio da incasso fornite senza pellicola protettiva sul frontale. Con rete in metallo.
 Rejillas de aluminio empotradas suministradas sin película de protección en el frente. Con red de metal.
 Recessed aluminium grilles supplied without protective film. With metal mesh.



COD.	Ø	A	B			€
9700-004-600P	Ø 80	Ø 110	Ø 77/80	24 pz	✓	
9701-004-600P	Ø 100	Ø 130	Ø 96/100	24 pz	✓	
9702-004-600P	Ø 120	Ø 150	Ø 116/120	24 pz	✓	
9704-004-600P	Ø 150	Ø 180	Ø 146/150	24 pz	✓	



GRIGLIE IN METALLO
REJILLAS DE METAL
METAL GRILLES

POP-LINE
 by Vecamco

Griglie da appoggio quadrate e rettangolari in alluminio con fissaggio tramite viti. Con e senza rete in fibra di vetro.
 Rejillas de aluminio cuadradas y rectangulares de apoyo, con fijación por medio de tornillos. Con o sin red de fibra de vidrio.
 Aluminium square and rectangular free-standing grilles, fixing with screws. With or without glass fiber mesh.



Su richiesta disponibili in rame o acciaio inox con quantitativi minimi.

Disponibles bajo pedido y cantidad mínima de cobre o acero inox.

Available on request and with a minimum quantity in copper and stainless steel.

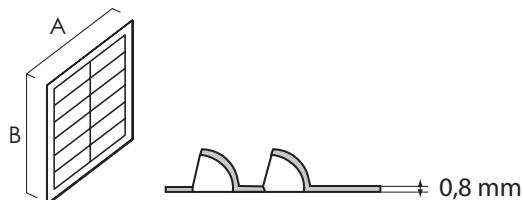

CON RETE | CON RED | WITH MESH

COD.	AxB	pz	€
9670-806-600	100x100	20 pz	
9671-806-600	100x200	20 pz	
9672-806-600	100x300	20 pz	
9673-806-600	100x400	20 pz	
9674-806-600	150x150	20 pz	
9675-806-600	150x200	10 pz	
9676-806-600	150x300	10 pz	
9677-806-600	150x400	10 pz	
9678-806-600	200x200	5 pz	
9679-806-600	200x300	5 pz	
9680-806-600	200x400	5 pz	
9681-806-600	250x250	5 pz	
9682-806-600	250x400	5 pz	
9683-806-600	300x300	5 pz	
9684-806-600	300x400	5 pz	

SENZA RETE | SIN RED | WITHOUT MESH

COD.	AxB	pz	pz	€
9670-806-600	100x100	16	20 pz	
9671-806-600	100x200	33	20 pz	
9672-806-600	100x300	50	20 pz	
9673-806-600	100x400	65	20 pz	
9674-806-600	150x150	25	20 pz	
9675-806-600	150x200	50	10 pz	
9676-806-600	150x300	74	10 pz	
9677-806-600	150x400	98	10 pz	
9678-806-600	200x200	65	5 pz	
9679-806-600	200x300	98	5 pz	
9680-806-600	200x400	130	5 pz	
9681-806-600	250x250	82	5 pz	
9682-806-600	250x400	163	5 pz	
9683-806-600	300x300	147	5 pz	
9684-806-600	300x400	196	5 pz	



GRIGLIE STYLE IN ABS
REJILLAS STYLE DE ABS
ABS STYLE GRILLES



Con imbocco tondo e rete anti-insetto. Fornito con una livella di posizionamento e viti per il fissaggio a muro. Il frontale si applica a incastro sul telaio della griglia. Adatta per ambienti esterni e interni.

Con entrada redonda y red anti-insectos. Suministradas con nivel para un perfecto posicionamiento y tornillos para la fijación a pared. El frontal se aplica a encastre en el marco de la rejilla. Adapta para interior y exterior.

Circular recessed grill with mesh. It is supplied with a positioning level and screws for the fixation on the wall. The frontal plate is fit on the frame of the grill. Suitable for internal and external applications.

COD.	Ø			€
9655-004-03	Ø 100	126	1 pz	
9656-004-03	Ø 120	126	1 pz	
9657-004-03	Ø 100	126	1 pz	
9658-004-03	Ø 120	126	1 pz	

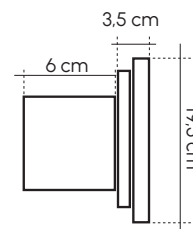
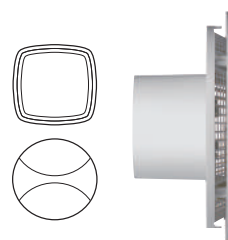

*Disponibili in blister. Prezzi su richiesta.

*Disponibles en blister. Precios bajo pedido.

*Available in blister. Prices on request.







GRIGLIE QUADRATE E RETTANGOLARI IN METALLO DA INTERNI REJILLAS CUADRADAS Y RECTANGULARES DE METAL PARA INTERIOR SQUARE AND RECTANGULAR METAL GRILLES FOR INDOOR USE

Smaltate bianche, apribili-chiudibili, da appoggio, a flusso regolabile. Senza rete.

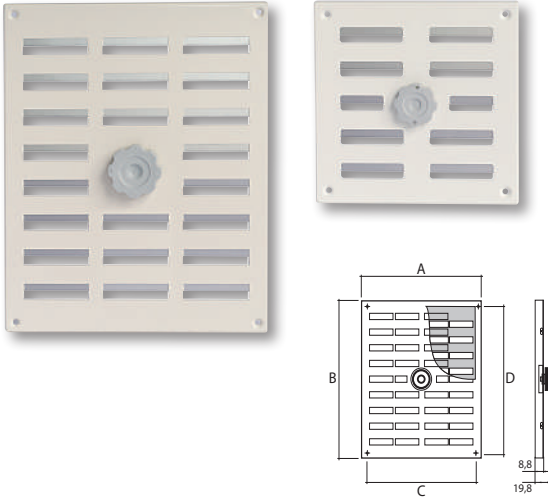
Esmaltadas color blanco, con sistema para abrir/cerrar, de apoyo, de flujo regulable. Sin red



White painted, with open/close system, free-standing, with adjustable air flow. Without mesh.

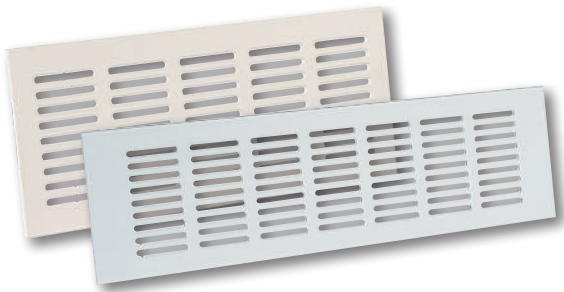

COD.	 Ax/B			€
9752-053-501	150x150	50	25 pz	
9752-052-501	150x200	70	25 pz	
9752-056-501	200x150	60	25 pz	
9752-051-501	200x200	100	25 pz	
9752-055-501	200x250	135	25 pz	
9752-057-501	250x200	110	25 pz	
9752-058-501	250x300	170	25 pz	
9752-059-501	300x200	170	25 pz	

PROFILI RETTANGOLARI DI AERAZIONE DA INCASSO PERFILES RECTANGULARES DE AIREACIÓN EMPOTRADOS RECTANGULAR RECESSED VENTILATION PROFILES



COD.	 Ax/B		€
9752-081-600	200x80	30 pz	
9752-082-600	300x80	50 pz	
9752-083-600	300x100	65 pz	
9752-080-600	400x60	50 pz	
9752-084-600	400x100	80 pz	

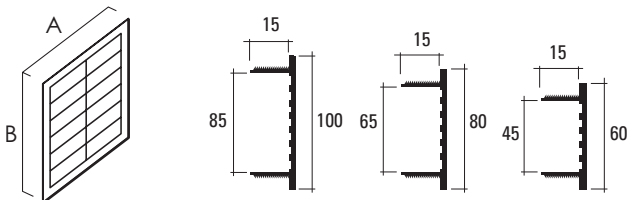

Senza rete | Sin red | Without mesh





COD.	COL.
600	 Alluminio Aluminio Aluminium

GRIGLIE CON TELAIO
REJILLAS CON MARCO
GRILLES WITH FRAME





COD.	 AxB		€
9721-001-641	160x160	6 pz	
9722-001-641	180x180	6 pz	
9721-001-900	160x160	6 pz	
9722-001-900	180x180	6 pz	
9721-001-607	160x160	6 pz	
9722-001-607	180x180	6 pz	



COD.	COL.	
641		Alluminio Aluminio Aluminium
900		Bronzo Bronce Bronze
607		Bianco Blanco White

GRIGLIE REGOLABILI CON TELAIO E SERRANDA
REJILLAS REGULABLES CON MARCO Y COMPUERTA
ADJUSTABLE GRILLES WITH FRAME AND AIR LOCK



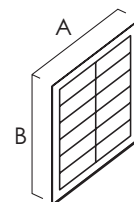

COD.	 AxB		€
9721-003-641	160x160	6 pz	
9722-003-641	180x180	6 pz	
9721-003-900	160x160	6 pz	
9722-003-900	180x180	6 pz	
9721-003-607	160x160	6 pz	
9722-003-607	180x180	6 pz	

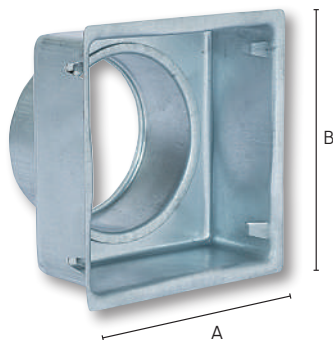

COD.	COL.	
641		Alluminio Aluminio Aluminium
900		Bronzo Bronce Bronze
607		Bianco Blanco White

ADATTATORI PER GRIGLIE REGOLABILI
ADAPTADORES PARA REJILLAS REGULABLES
ADAPTER FOR ADJUSTABLE GRILLES



COD.	 AxB	Ø	€
9721-049-100	160x160	Ø 80	
9721-048-100	160x160	Ø 100	
9722-049-100	180x180	Ø 120	
9722-048-100	180x180	Ø 140	

TUBO IN ALLUMINIO ESTENSIBILE
TUBO DE ALUMINIO EXTENSIBLE
EXTENSIBLE ALUMINIUM PIPE

Tubo in alluminio estensibile da 0,5 mt a 3 mt. Applicabile a impianti di riscaldamento, condizionamento, sistemi di ventilazione, aspirazione e fumi.

Tubo de aluminio extensible desde 0,5 metros hasta 3 metros. Aplicable a la calefacción, refrigeración, ventilación, aspiración y humos.

Extendible aluminium pipe 0,5-3 mt. Suitable for heating, air-conditioning installations, ventilation and aspiration systems.



COD.	Ø	€
6000-500-600	Ø 80	
6000-501-600	Ø 100	
6000-502-600	Ø 125	
6000-503-600	Ø 150	

Prezzo per singolo pezzo
 Precio por pieza
 Price per piece



ESPOSITORE DA TERRA
EXPOSITOR DE PISO
GROUND DISPLAY



POSSIBILI PERSONALIZZAZIONI
POSIBLES PERSONALIZACIONES
SPECIAL CUSTOMIZATIONS ARE
AVAILABLE ON REQUEST

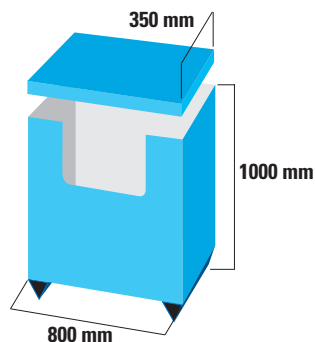

EXPO50 - composto da | compuesto por | made of

COD.		INFO.	NUN. MAX.		€
9611-006-06	Ø 145	Con molle e rete Con muelles y red With springs and mesh	100	264 pz	
9602-004-06	166x166	Da appoggio con rete De apoyo con red Free-standing with mesh	88		
9603-006-06	Ø 190	Con molle e rete Con muelles y red With springs and mesh	76		



9611-006-06

EXPO51 - composto da | compuesto por | made of

COD.		INFO.	NUN. MAX.		€
9611-006-06	Ø 145	Con molle e rete Con muelles y red With springs and mesh	180	288 pz	
9603-006-06	Ø 190	Con molle e rete Con muelles y red With springs and mesh	108		



9602-004-06

EXPO52 - composto da | compuesto por | made of

COD.		INFO.	NUN. MAX.		€
9611-006-06	Ø 145	Con molle e rete Con muelles y red With springs and mesh	-	360 pz	



9603-006-06



EXPO2 1000X500 MM

Espositore griglie da parete per negozi e showroom.
Expositor rejillas de pared para tiendas y salas de exposición.
Wall grilles display for shops and showrooms.



Griglie in plastica quadrate e rettangolari da appoggio
Rejillas de plástico cuadradas y rectangulares de apoyo
Square and rectangular plastic free-standing grilles



Griglie quadrate e rettangolari in alluminio
Rejillas cuadradas y rectangulares de aluminio
Square and rectangular aluminium grilles



Griglie in rame
Rejillas de cobre
Copper grilles



Griglie circolari universali in plastica con molle reclinabili a 90°
Rejillas redondas universales de plástico con muelles a 90°
Round universal plastic grilles with springs at 90°



Griglie quadrate universali in plastica con molle reclinabili a 90°
Rejillas cuadradas universales de plástico con muelles a 90°
Square universal plastic grilles with springs at 90°



Griglie circolari universali in plastica con molle reclinabili a 90°
Rejillas redondas universales de plástico con muelles a 90°
Round universal plastic grilles with springs at 90°



DISPONIBILE CON GANCETTO PER SELF-SERVICE
 DISPONIBLES CON GANCHO PARA AUTOSERVICIO
 AVAILABLE WITH ADHESIVE HOOK SUITABLE FOR SELF-SERVICE USE

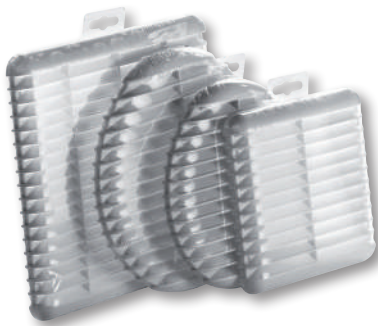

Prezzi su richiesta
 Precios bajo pedido
 Prices on request

CREAZIONE CODICE | CREACIÓN DE CÓDIGO | CODE CREATION:



DISPONIBILE CON SACCHETTO CAVALIERE
 DISPONIBLES CON BOLSILLO
 AVAILABLE WITH PLASTIC BAG



Prezzi su richiesta
 Precios bajo pedido
 Prices on request

CREAZIONE CODICE | CREACIÓN DE CÓDIGO | CODE CREATION:

