

Hidrotren[®]

NETVITC
SYSTEM

Sistemas y Tecnología del agua / Water-System Technology

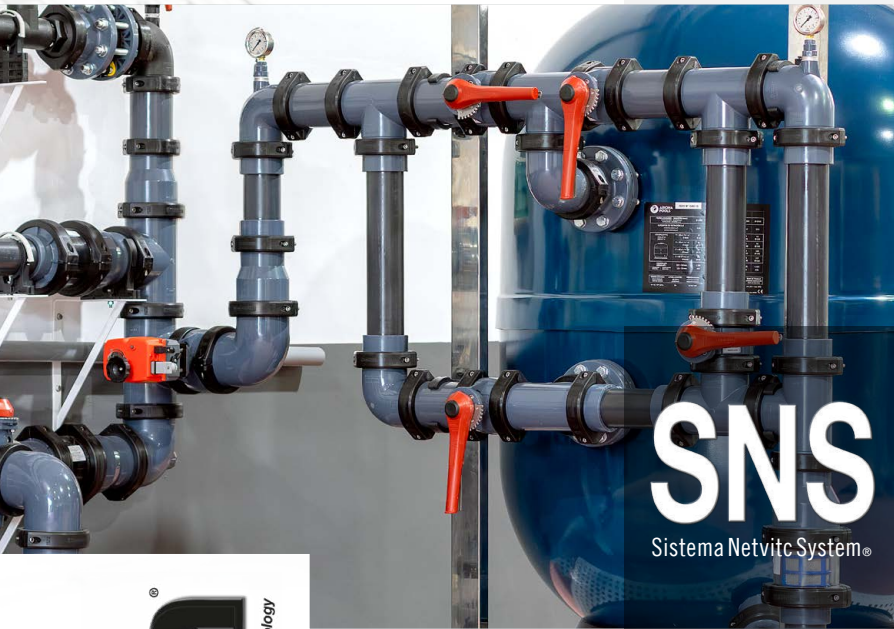

SNS

Sistema Netvitic System[®]

07

EDICIÓN MARZO 2024

Edition March 2024
Édition mars 2024

TARIFA DE PRECIOS
NETVITC SYSTEM[®]

PRICE LIST-LISTE DE PRIX



Building trust together

AENOR

Confía

Certificado del Sistema de Gestión de la Calidad



ER-1862/2000

AENOR certifica que la organización

HIDROTEN, S.A.

dispone de un sistema de gestión de la calidad conforme con la Norma ISO 9001:2015

para las actividades: El diseño, la producción y comercialización de accesorios y válvulas de plástico para la conducción de fluidos hasta PN 16, filtros, goteros y accesorios de microirrigación.

que se realizan en: PLA DE LA VALLONGA, C/ AGUA, 28. 03006- ALICANTE
PI PLA DE LA VALLONGA, CALLE AGUA, 21. 03006- ALICANTE (ALICANTE)
PI PLA DE LA VALLONGA, CALLE AGUA, 24. 03006- PLA DE LA VALLONGA (ALICANTE)
PI PLA DE LA VALLONGA, CALLE ALISEOS, 83. 03006- ALICANTE

Primera emisión: 2000-12-27
Expiración: 2026-05-03

Última emisión: 2023-05-03

Rafael GARCÍA MEIRO
CEO



AENOR INTERNACIONAL S.A.U.
Génova, 8. 28004 Madrid, España
Tel. 91 432 60 00 - www.aenor.com



Building trust together

AENOR

Confía

Certificado del Sistema de Gestión Ambiental



GA-2012/0026

AENOR certifica que la organización

HIDROTEN, S.A.

dispone de un sistema de gestión ambiental conforme con la Norma ISO 14001:2015

para las actividades: El diseño, la producción y comercialización de accesorios y válvulas de plástico para la conducción de fluidos hasta PN 16, filtros, goteros y accesorios de microirrigación.

que se realizan en: PLA DE LA VALLONGA, C/ AGUA, 28. 03006- ALICANTE
PI PLA DE LA VALLONGA, CALLE AGUA, 21. 03006- ALICANTE (ALICANTE)
PI PLA DE LA VALLONGA, CALLE AGUA, 24. 03006- PLA DE LA VALLONGA (ALICANTE)
PI PLA DE LA VALLONGA, CALLE ALISEOS, 83. 03006- ALICANTE

Primera emisión: 2012-02-26
Expiración: 2026-05-15

Última emisión: 2023-05-15

Rafael GARCÍA MEIRO
CEO



AENOR INTERNACIONAL S.A.U.
Génova, 8. 28004 Madrid, España
Tel. 91 432 60 00 - www.aenor.com

AENOR

Confía

Certificado del Sistema de Gestión Seguridad y Salud en el Trabajo



SST-0178/2018

AENOR certifica que la organización

HIDROTEN, S.A.

dispone de un sistema de gestión de Seguridad y Salud en el Trabajo conforme con la norma ISO 45001:2018

para las actividades: El diseño, la producción y comercialización de accesorios y válvulas de plástico para la conducción de fluidos hasta pn 16, filtros, goteros y accesorios de microirrigación.

que se realizan en: PI PLA DE LA VALLONGA, C/ AGUA, 28. 03006- ALICANTE

Fecha de primera emisión: 2018-12-28
Fecha de última emisión: 2021-12-28
Fecha de expiración: 2024-12-28

Rafael GARCÍA MEIRO
Director General

AENOR INTERNACIONAL S.A.U.
Génova, 8. 28004 Madrid, España
Tel. 91 432 60 00 - www.aenor.com



AENOR

Confía

Certificado de Sistema de Gestión de Compliance Penal



GCP-2017/0012

AENOR certifica que la organización

HIDROTEN, S.A.

dispone de un Sistema de Gestión de Compliance Penal conforme con la norma UNE 19601:2017

para las actividades: Actividad de diseño, la producción y comercialización de accesorios y válvulas de plástico para la conducción de fluidos hasta pn 16, filtros, goteros y accesorios de microirrigación.

que se realizan en: PLA DE LA VALLONGA, C/ AGUA, 28. 03006- ALICANTE

Primera emisión: 2017-01-01

Expiración: 2025-01-01

Rafael GARCÍA MEIRO
CEO

Este certificado previene de uno no autorizado de fecha: 05/12/20



AENOR INTERNACIONAL S.A.U.
Génova, 8. 28004 Madrid, España
Tel. 91 432 60 00 - www.aenor.com

Estimado cliente:

Nos complace presentarle la sexta edición de nuestro catálogo/tarifa de precios exclusivo del “**Sistema Netvitec System®**”, un **revolucionario Sistema modular de unión de bridas** desarrollado y fabricado por Hidrotén íntegramente en materiales plásticos.

El Sistema Netvitec System® es el resultado de muchos años de I+D+i invertidos por Hidrotén, que siempre ha tenido claro el compromiso con sus clientes, ofreciéndoles sistemas siempre a la vanguardia del mercado capaces de cubrir sus necesidades con las máximas garantías.

El Sistema Netvitec System® engloba siete familias de productos, cuya calidad está avalada por nuestro Sistema de gestión de calidad conforme a la ISO 9001:2015 y certificado por AENOR. Dichas familias, podrán encontrarse también en nuestra nueva **tarifa de precios general nº 29**, así como en formato digital en nuestra web **www.hidrotén.es**.

En Hidrotén somos conscientes de que **la innovación constante en nuestros productos es la única vía para continuar siendo un líder mundial** en el sector de la conducción de fluidos, por ello plasmamos esta inquietud en sistemas de productos como el Netvitec System®.

Recordarle que **todo el equipo humano de Hidrotén está a su entera disposición** y que para cualquier duda o consulta técnica acerca de nuestros productos y sistemas puede resolverla a través de nuestro **departamento técnico comercial (S.A.T.C.)**.

Dear customer:

We are honored to present the sixth edition of our exclusive “**Netvitec System®**” catalogue/price list, a **revolutionary modular flange connection system** developed and manufactured by Hidrotén entirely in plastic materials.

The Netvitec System® is the result of many years of R+D+i invested by Hidrotén, which has always had a clear commitment to its customers, offering systems always at the forefront of the market able to meet their needs with maximum guarantees.

The Netvitec System® comprises seven product families, whose quality is guaranteed by our Quality Management System in accordance with ISO 9001:2015 and certified by AENOR. These families can also be found in our new general **price list No. 29**, as well as in digital format on our website **www.hidrotén.es**.

In Hidrotén we are aware that **constant innovation in our products is the only way to keep being a world leader** in the fluid handling sector, so we translate this concern into product systems such as the Netvitec System®.

Remind you that **the whole team of Hidrotén is at your disposal** and that for any doubt or technical question about our products and systems you can solve it through our **commercial technical department (S.A.T.C.)**.

HIDROTEN, S.A.

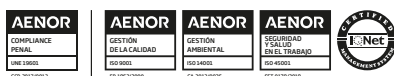



05 **Introducción**
Introduction



07 **FAMILIA/FAMILY 01N**
Accesorios presión Netvite System®
Netvite System® pressure fittings



25 **FAMILIA/FAMILY 18**
Visor de líquidos Netvite System®
Netvite System® fluids display



31 **FAMILIA/FAMILY 09N**
Válvulas de mariposa Netvite System®
Netvite System® butterfly valves



43 **FAMILIA/FAMILY 14**
Válvulas de aspiración Netwell®
Netwell® foot valves



51 **FAMILIA/FAMILY 15**
Válvulas retención lineal Netvite System®
Netvite System® lineal check valves



57 **FAMILIA/FAMILY 08N**
Filtros Netvite System®
Netvite System® filters



69 **FAMILIA/FAMILY 1NH**
Hidrantes Netvite System®
Netvite System® hydrants

75 **Ejemplos instalaciones SNS®**
SNS® installations examples

80 **Nuestros vídeos**
Our videos

81 **Webinars**
Webinars

82 **Catálogo Presto / BIM**
Presto Catalog / BIM

83 **S.A.T.C / U.T.M**
S.A.T.C / U.T.M

84 **Directorio**
Directory

88 **Normas generales de venta**
Sales terms

Sistema **SNS**
Netvite System

SNS
Netvitic System®

ÚNICO
en el mercado **um**



FAMILIA / FAMILY 15

DTO. %



FAMILIA / FAMILY 14

DTO. %



FAMILIA / FAMILY 01N

DTO. %



FAMILIA / FAMILY 01N

DTO. %



FAMILIA / FAMILY 09N

DTO. %



FAMILIA / FAMILY 18

DTO. %



FAMILIA / FAMILY 08N

DTO. %



FAMILIA / FAMILY 1NH

DTO. %

VENTAJAS NETVITIC SYSTEM® // ADVANTAGES NETVITIC SYSTEM®

- El Sistema Netvitic System® se caracteriza por su **ligereza**, lo cual lo hace más versátil y dúctil a la hora de manipular las piezas, ganando siempre en comodidad. // The Netvitic System® is characterized by its **lightness**, which makes it more versatile and ductile when handling parts, always gaining in comfort.
- Su **operatividad y polivalencia** le permite unir productos de diferentes materiales, realizar modificaciones o la posibilidad de realizar giros en la instalación que por lo general un sistema tradicional no puede hacer. // Its **operability and versatility** allows it to join different materials, carry out modifications or the possibility of making turns in the installation that usually a traditional system can not permit.
- El **ahorro de tiempo** debido a la reducción de la mano de obra se traduce en beneficios económicos. // The **saving of time** as a result of the reduction of labor translates into **economic** benefits.
- Su **agilidad** en los tiempos de montaje y desmontaje lo convierten en un sistema idóneo para instalaciones modulares de tratamiento de aguas, colectores de distribución para sistemas de riego e industrias agroalimentarias. Además, facilita las labores de limpieza y mantenimiento. // Its **agility** in times of assembly and disassembly make it an ideal system for modular water treatment plants, distribution manifolds for irrigation systems and agro-food industries. In addition, it facilitates the cleaning and maintenance tasks.

CARACTERÍSTICAS // FEATURES



Materiales homologados para uso en aplicaciones de agua potable.
Materials certified for potable drinking water.

Netvite System®, es un sistema de unión mecánica basado en la junta “J-Bil” y la brida Netvite System®, que permite unir entre sí elementos de forma rápida. Su modularidad permite combinar directamente accesorios, válvulas y hacer transiciones de material con importantes ahorros y con las máximas garantías.

La junta “J-Bil” es el alma del Netvite System® y como tal, está especialmente creada para trabajar en cualquier condición. Su alma de acero le confiere estabilidad a altas presiones, su diseño bilabial aumenta la estanqueidad con la presión y su superficie con nervios perimetrales asegura un óptimo funcionamiento a bajas presiones.

Netvite System® is a mechanical connection system based on the “J-Bil” joint and the Netvite System® flange, which allows you to easily join elements to each other with little work. As it is a mechanical system, it allows you to combine different models and materials saving a great deal of time and with an improvement of working processes.

“J-Bil” joint is Netvite System®’s core and was especially created to be used in any condition. Its metallic core makes it stable on high pressures. Its bilabial design increases the sealing as pressure increases and its surface with perimeter nerves ensures an optimal performance on low pressures.

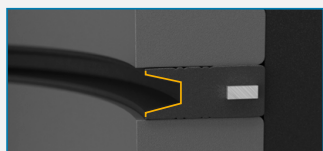

Detalle de junta bilabial “J-BIL” sin presión.
Detail of the “J-BIL” o-ring without internal pressure.

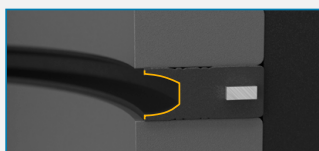

Detalle de junta bilabial “J-BIL” con presión.
Detail of the “J-Bil” o-ring with internal pressure.



Acero Inox A-4
Stainless steel A-4

RECOMENDACIONES DE INSTALACIÓN // INSTALLATION RECOMMENDATIONS



Las instalaciones realizadas con el Sistema Netvite System®, como cualquier instalación convencional, **deben ir fijadas y ancladas** teniendo en cuenta los esfuerzos y empujes que vaya a soportar, por su propio peso, por las presiones internas del fluido, o por fuerzas externas como las producidas por asentamientos en el terreno. **De esta manera se evitan desplazamientos que puedan terminar en roturas o fugas.**

Installations made with SNS®, like any conventional installation, **must be fixed and anchored** taking into account the stress and thrust that they will withstand, due to their own weight, the internal pressures of the fluid, or external forces such as those produced by settlements in the ground. **This prevents displacements that could lead to ruptures or leaks.**



USO-APRIETE TORNILLOS // USE-TIGHTENING SCREWS

Para el montaje correcto de elementos de fijación en acero inoxidable con antigripante, **se recomienda enroscar de manera continua y alternativa, con un número de vueltas reducido**, evitando el uso de atornilladoras automáticas de impacto. En caso contrario, la fricción entre componentes aumenta el riesgo de gripaje.

Se recomienda el uso de un lubricante antigripaje y aplicar el par recomendado.

For the correct assembly of stainless steel components with anti-seize, it is recommended to screw in continuously and alternately, with a reduced number of turns, avoiding the use of automatic impact screwdrivers. Otherwise, friction between components increases the risk of seizure.

The use of an anti-seize lubricant and the application of the recommended torque is recommended.

Rosca / Thread	Par. máximo (N-m) / Max torque (N-m)
M-6	7
M-8	16
M-10	32

Tabla realizada con coeficiente de fricción de 0.12-0.16.
Recomendaciones en base a fabricantes de tornillería.

Table based on a friction coefficient of 0.12-0.16.
Recommendations based on fastener manufacturers.



SNS
Netvitc System®



ACCESORIOS PRESIÓN SNS®
SNS® PRESSURE FITTINGS

FAMILIA
01N FAMILY



CARACTERÍSTICAS // FEATURES

Los accesorios del Sistema Netvic System® son totalmente necesarios para poder **dar continuidad, enlazar y direccionar las tuberías** en PVC-U o PE, ayudando a dar forma a la instalación deseada. Estos accesorios están fabricados tanto en PVC-U como en PPFV, lo que les hace idóneos para poder operar en distintos sistemas de trabajo.

Una de sus principales características es la **posibilidad de rotación 360°** en sus piezas sin necesidad de tener que desmontar por completo las bridas. Su gama de accesorios PVC-U está diseñada para tener la posibilidad de encolar el accesorio (según la normativa UNE EN 1452) permitiendo hacer conexiones mixtas Netvic System®-encolar. Así mismo, los accesorios Netvic System® PPFV se adecuan perfectamente a los sistemas actuales de unión de tubería de PE, como la soldadura a tope o la electrofusión.

The Netvic System® fittings are totally necessary to be able to **give continuity, connect and direct the pipes** in PVC-U or PE, helping to create the desired installation. These fittings are made of PVC-U and GRPP, which makes them suitable to operate in different working conditions.

One of its main features is the **possibility of 360° rotation** in its parts without the need to completely disassemble the flanges. Its range of PVC-U fittings is designed to have the possibility of gluing the fitting (according to the UNE EN 1452 norm) allowing to make mixed connections Netvic System®-gluing. Likewise, the Netvic System® GRPP fittings are perfectly suited to current PE pipe joining systems, such as electro and thermo welding.

SISTEMA DE BRIDAS NETVITC SYSTEM® // NETVITC SYSTEM® FLANGES SYSTEM

Posibilidad de giro / Turn possibility
Unión directa de dos codos / Direct connection of two elbows
Posibilidad de desmontaje / Dismountable

2 Modelos en 1, retención y visor.
○ Combinación de salidas PVC-U - PE.
○ Ligereza en sus modelos.
○ Resistencia ambientes corrosivos.

Two models in one, check valve and fluid display.
○ Outlet combinations PVC-U - PE.
○ Lightness.
○ High resistance corrosive atmosphere.

1. Tubo de Ø110
2, 3, 5, 6. Codo 90° Netvic System®
4. Válvula Mariposa Netvic System® Ø110
7. Reducción cónica Netvic System® Ø125-110
8. Válvula de retención cuerpo visor S/termofusión
9. Tubo PE Ø110

1. Pipe Ø110
2, 3, 5, 6. Netvic System® 90° Elbow solvent socket outlet
4. Netvic System® butterfly valve Ø110
7. Netvic System® conical reduction Ø125-110
8. Netvic System® transparent check valve with thermo fusion outlet
9. PE pipe Ø110

SECTOR	Piscina, tratamiento de agua, agricultura e industria / <i>Swimming pool, water treatment, agriculture and industry</i>
MATERIAL	PVC-U y PPFV / <i>PVC-U & GRPP</i>
JUNTA / GASKET	EPDM / INOX A-4
PN	PN 10
MEDIDAS CONEXIONES / CONNECTION SIZES	Rosca hembra Ø1" a 4" / <i>Female threaded outlet from Ø1" to 4"</i> Encolar Ø40 a 225 / <i>Solvent socket outlet from Ø40 to 225</i> PE Ø50 a 225 / <i>PE outlet from Ø50 to 225</i> Sistema ranurado Ø2" a 4" / <i>Grooved system outlet from Ø2" to 4"</i> Bridas Ø90 a 160 / <i>Flange outlet from Ø90 to 160</i>

MONTAJE NETVITC SYSTEM® // NETVITC SYSTEM® ASSEMBLY

- Colocar la junta bilabial Netvitc System® en la cara exterior del accesorio. / Place the double lipped joint in the outside part of the fitting.
- Presentar los elementos Netvitc System® uno frente a otro siempre que la medida de la brida sea común. / Situate the Netvitc System® parts face to face, the measure of the flange must always be common.
Por ejemplo: codo "Air" Netvitc System® Ø90 con válvula de mariposa Netvitc System® Ø90.
For example: "Air" Netvitc System® Ø90 elbow with butterfly valve Netvitc System® Ø90.
- 3, 4 y 5.** Colocar brida Netvitc System® inferior entre alojamientos del sistema y a continuación la brida superior. / Place the lower Netvitc System® flange between the bedding of the system and then the upper flange.
- 6.** Colocar tornillería y apretar de manera alterna y progresiva los tornillos, de forma que la brida quede equilibrada. / Position the screws, tight them up in a gradual and alternative way in order to keep the flange balanced.

RECOMENDACIONES DE INSTALACIÓN // INSTALLATION RECOMMENDATIONS

Las instalaciones realizadas con el Sistema Netvitc System®, como cualquier instalación convencional, **deben ir fijadas y ancladas** teniendo en cuenta los esfuerzos y empujes que vaya a soportar, por su propio peso, por las presiones internas del fluido, o por fuerzas externas como las producidas por asentamientos en el terreno. **De esta manera se evitan desplazamientos que puedan terminar en roturas o fugas.** // Installations made with Netvitc System®, like any conventional installation, **must be fixed and anchored** taking into account the stress and thrust that they will withstand, due to their own weight, the internal pressures of the fluid, or external forces such as those produced by settlements in the ground. **This prevents displacements that could lead to ruptures or leaks.**



Para recomendaciones de uso y apriete del tornillo, ver pg. 05.
 For recommendations for use and tightening of the bolt, see pg. 05.



ACCESORIOS PRESIÓN NETVITC SYSTEM®

NETVITC SYSTEM® PRESSURE FITTINGS

15N

Brida Netvitc System®



Netvitc System® clamp
Bride Netvitc System®

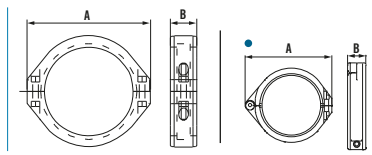

Ref.	€	Ø Tubo / Pipe	Peso / Wt (g)	Uds. Lote/Batch	A	B
1N909	5,61	50*	110	8	110	36
1N910	5,61	63	150	8	125	36
1N911	6,68	75	173	8	138	36
1N912	17,14	90	350	4	164	39
1N913	18,03	110	389	4	188	39
1N914	20,30	125	520	4	203	44
• 1N865	20,30	125	499	4	215	45
1N915	24,56	140	569	4	224	48
1N916	32,93	160	925	2	251	54
1N917	33,55	200	1.195	2	297	59
• 1N868	33,55	200	1.158	2	315	61

Con tornillos. / With screws.

- Brida Netvitc System® abisagrada. / Netvitc System® hinged flange. Solo en artículos indicados. / Only items indicated.

16N

Juntas Netvitc System® "J-BIL"



Netvitc System® "J-BIL" O-ring
Joint Netvitc System® "J-BIL"



Materiales homologados para uso en aplicaciones de agua potable.
Materials certified for potable drinking water.

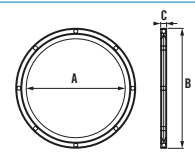

Ref.	€	Ø Junta / O-Ring	Peso / Wt (g)	Uds. Lote/Batch	A	B	C
98384	15,57	50* ■	22	100	50	74	5
98355	3,70	63	5	100	74	88	5
98385	15,57	63* ■	30	100	67	92	5
98356	3,70	75	6	100	82	97	4
98387	25,35	90 ■	53	100	98	121	6
98388	27,12	110 ■	66	100	120	144	6
98389	34,53	125 ■	70	100	132	159	6
98390	35,71	140 ■	92	100	148	176	6
98391	37,73	160 ■	109	100	173	201	7
98357	38,09	200 ■	155	100	217	248	8

- Con alma de acero en su interior A-4. / Inner inox A-4 ring.

01N

26N

Codo 90° Netvitc System®



Netvitc System® 90° elbow
Coude 90° Netvitc System®

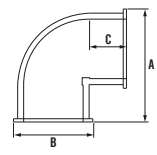

Ref.	Peso/Wt (g)	€	Ref.	Peso/Wt (g)	€	Ø Tubo/Pipe	Brida/Clamp	Uds. Lote/Batch	A	B	C
1N005	337	13,19	1N205	247	15,83	63	63	10	122	92	43
1N007	788	17,72	1N207	600	21,22	90	90	8	160	121	50
1N008	1.292	33,54	1N208	890	40,25	110	110	8	191	144	61
1N009	1.701	46,35	1N209	1.218	54,68	125	125	6	219	160	70
1N010	2.435	79,00	1N210	1.705	94,82	140	140	2	243	176	76
1N011	2.910	91,80	1N211	2.242	110,15	160	160	2	274	182	87
1N012	5.077	139,33	1N212	3.305	166,97	200	200	2	333	251	106

*Sólo para conexión de colectores SNS®. / Only for SNS® manifolds.

02N
Codo 90° Netvitc System® C/B

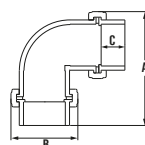
 Netvitc System® 90° elbow W/F
 Coude 90° Netvitc System® A/B

Ref.	€	∅ Tubo/Pipe	Brida/Clamp	Peso/Wt (g)	Uds. Lote/Batch	A	B	C
1N015	37,12	63	63	854	4	180	125	36
1N017	74,89	90	90	2.116	4	242	164	52
1N018	98,22	110	110	3.050	4	286	188	61
1N019	125,38	125	125	3.875	2	326	203	69
1N020	219,61	140	140	5.405	1	360	224	77
1N021	230,88	160	160	7.560	1	410	251	86
1N022	339,27	200	200	10.400	1	482	297	107

24N
28N
Codo 90° Netvitc System® "AIR" salida R/H

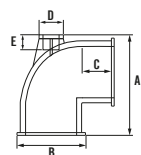
 "AIR" Netvitc System® 90° elbow
 Coude 90° Netvitc System® "AIR"

Ref.	Peso/Wt (g)	€	Ref.	Peso/Wt (g)	€	∅ Tubo/Pipe	Brida/Clamp	Uds. Lote/Batch	A	B	C	D	E
1N115	345	17,02	1N305	260	20,40	63	63	10	128	92	43	1/2"	17
1N117	814	21,98	1N307	604	26,36	90	90	8	174	121	50	3/4"	21
1N119	1.325	39,74	1N309	1.019	47,66	110	110	8	204	144	61	1"	31
1N121	1.775	51,50	1N310	1.300	60,78	125	125	6	245	159	70	2"	36
1N123	3.140	102,74	1N312	2.510	123,09	160	160	2	299	201	87	2"	36
1N124	5.370	148,11	1N313	3.925	178,27	200	200	2	347	251	106	2"	36

 Refuerzo en acero inoxidable A-2. / *Stainless steel reinforcement A-2.*
23N
Codo 90° Netvitc System® "AIR" C/B salida R/H

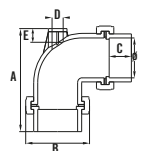
 "AIR" Netvitc System® 90° elbow W/F
 Coude 90° Netvitc System® "AIR" A/B

Ref.	€	∅ Tubo/Pipe	Brida/Clamp	Peso/Wt (g)	Uds. Lote/Batch	A	B	C	D	E
1N105	46,01	63	63	618	4	169	125	36	1/2"	17
1N107	79,22	90	90	2.031	4	234	164	52	3/4"	21
1N109	104,42	110	110	3.092	4	277	188	61	1"	31
1N111	130,45	125	125	4.146	2	330	203	69	2"	36
1N113	242,37	160	160	7.110	1	400	251	86	2"	36
1N114	348,51	200	200	11.175	1	473	297	107	2"	36

 Refuerzo en acero inoxidable A-2. / *Stainless steel reinforcement A-2.*
55N
Codo 90° Netvitc System® "AIR" S/Encolar

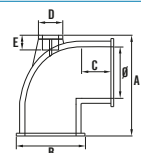
 "AIR" Netvitc System® 90° elbow s/socket outlet
 Coude 90° Netvitc System® "AIR" s/femelle à collar

Ref.	€	∅ Tubo/Pipe	Brida/Clamp	Peso/Wt (g)	Uds. Lote/Batch	A	B	C	D	E
1N590	22,67	90	90	828	8	174	121	50	25	21
1N592	44,14	110	110	1.347	8	204	144	61	32	31
1N594	55,40	125	125	1.775	6	245	159	70	63	36
1N596	109,67	160	160	3.430	2	299	201	87	63	36
1N597	155,79	200	200	5.345	2	347	251	106	63	36



ACCESORIOS PRESIÓN NETVITC SYSTEM®
NETVITC SYSTEM® PRESSURE FITTINGS

56N

Codo 90° Netvitc System® "AIR" C/B S/Encolar



"AIR" Netvitc System® 90° elbow W/F s/socket outlet
Coude 90° Netvitc System® "AIR" A/B s/femelle à coller

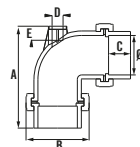

Ref.	€	∅ Tubo/Pipe	Brida/Clamp	Peso/Wt (g)	Uds. Lote/Batch	A	B	C	D	E
1N610	82,25	90	90	2.031	4	234	164	52	25	21
1N612	108,03	110	110	2.981	4	277	188	61	32	31
1N614	139,44	125	125	3.995	2	330	203	69	63	36
1N616	253,30	160	160	7.110	1	400	251	86	63	36
1N617	355,82	200	200	11.175	1	473	297	107	63	36

60N

62N

Codo 90° Netvitc System® "AIR L" Salida R/H



"AIR L" Netvitc System® 90° elbow
Coude 90° Netvitc System® "AIR L"

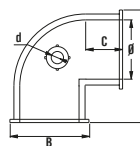

Ref.	Peso/Wt (g)	€	Ref.	Peso/Wt (g)	€	∅ Tubo/Pipe	Brida/Clamp	Uds. Lote/Batch	A	B	C	d
1N810	788	21,93	1N830	600	26,33	90	90	8	160	121	50	3/4"
1N812	1.292	44,14	1N832	890	53,00	110	110	8	191	144	61	1"

Refuerzo en acero inoxidable A-2. / Stainless steel reinforcement A-2.

61N

Codo 90° Netvitc System® "AIR L" C/B Salida R/H



"AIR L" Netvitc System® 90° elbow W/F
Coude 90° Netvitc System® "AIR L" A/B

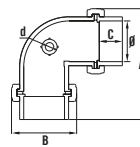

Ref.	€	∅ Tubo/Pipe	Brida/Clamp	Peso/Wt (g)	Uds. Lote/Batch	A	B	C	d
1N820	81,56	90	90	2.116	4	242	164	52	3/4"
1N822	108,03	110	110	3.050	4	286	188	61	1"

Refuerzo en acero inoxidable A-2. / Stainless steel reinforcement A-2.

27N

Codo 90° Netvitc System® C/B salida PE



Netvitc System® 90° elbow W/F, PE outlet
Coude 90° Netvitc System® A/B

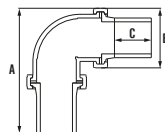

Ref.	€	∅ Tubo/Pipe	Brida/Clamp	Peso/Wt (g)	Uds. Lote/Batch	A	B	C
1N215	92,79	63	63	878	4	260	125	88
1N217	149,81	90	90	2.021	4	325	164	103
1N218	207,31	110	110	2.848	4	367	188	112
1N219	222,75	125	125	3.700	2	391	203	108
1N220	356,87	140	140	4.805	1	442	224	124
1N221	377,92	160	160	6.587	1	485	251	127
1N222	597,82	200	200	11.310	1	548	297	130

Valona larga válida para soldadura a tope y electrofusión. / Long PE outlet for thermo and electro welding.

29N
Codo 90° Netvitc System® "AIR" C/B salida PE

"AIR" Netvitc System® 90° elbow W/F, PE outlet
Coude 90° Netvitc System® "AIR" A/B

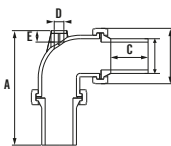

Ref.	€	Ø Tubo/Pipe	Brida/Clamp	Peso/Wt (g)	Uds. Lote/Batch	A	B	C	D	E
1N315	115,04	63	63	890	4	249	125	88	1/2"	17
1N317	154,91	90	90	2.083	4	317	164	103	3/4"	21
1N319	214,82	110	110	2.906	4	358	188	112	1"	31
1N320	236,62	125	125	4.140	2	395	203	108	2"	36
1N322	293,56	160	160	7.005	1	475	251	127	2"	36
1N323	639,56	200	200	11.930	1	539	297	130	2"	36

Refuerzo en acero inoxidable A-2. / *Stainless steel reinforcement A-2.*

Valona larga válida para soldadura a tope y electrofusión. / *Long PE outlet for thermo and electro welding.*

63N
Codo 90° Netvitc System® "AIR L" R/H, C/B salida PE

"AIR L" Netvitc System® 90° elbow W/F, PE outlet
Coude 90° Netvitc System® "AIR L" A/B

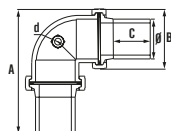

Ref.	€	Ø Tubo/Pipe	Brida/Clamp	Peso/Wt (g)	Uds. Lote/Batch	A	B	C	d
1N840	154,89	90	90	2.036	4	325	164	103	3/4"
1N842	220,13	110	110	2.906	4	367	188	112	1"

Refuerzo en acero inoxidable A-2. / *Stainless steel reinforcement A-2.*

Valona larga válida para soldadura a tope y electrofusión. / *Long PE outlet for thermo and electro welding.*

03N
30N
Codo 45° Netvitc System®

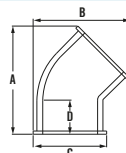

Netvitc System® 45° elbow
Coude 45° Netvitc System®



Ref.	Peso/Wt (g)	€	Ref.	Peso/Wt (g)	€	Ø Tubo/Pipe	Brida/Clamp	Uds. Lote/Batch	A	B	C	D
1N025	248	13,71	1N225	186	16,45	63	63	10	118	113	92	35
1N027	466	18,47	1N227	457	22,15	90	90	8	166	152	121	50
1N028	1.020	34,04	1N228	720	40,89	110	110	8	196	179	144	61

04N
Codo 45° Netvitc System® C/B

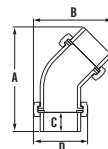
Netvitc System® 45° elbow W/F
Coude 45° Netvitc System® A/B



Ref.	€	Ø Tubo/Pipe	Brida/Clamp	Peso/Wt (g)	Uds. Lote/Batch	A	B	C	D
1N035	38,58	63	63	785	4	193	151	36	125
1N037	75,74	90	90	1.936	4	274	204	52	164
1N038	98,75	110	110	2.630	4	305	297	61	188



ACCESORIOS PRESIÓN NETVITC SYSTEM®

NETVITC SYSTEM® PRESSURE FITTINGS

31N



Codo 45° Netvitic System® C/B salida PE

Netvitic System® 45° elbow W/F, PE outlet
Coude 45° Netvitic System® A/B

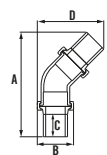

Ref.	€	∅ Tubo/Pipe	Brida/Clamp	Peso/Wt (g)	Uds. Lote/Batch	A	B	C	D
1N235	96,49	63	63	878	4	321	125	89	202
1N237	150,69	90	90	1.958	4	450	164	100	256
1N238	219,96	110	110	2.652	4	476	188	102	302

Valona larga válida para soldadura a tope y electrofusión. / Long PE outlet for thermo and electro welding.

05N



32N



Te 90° Netvitic System®

Netvitic System® 90° Tee
Té 90° Netvitic System®

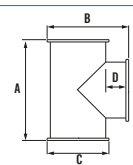

Ref.	Peso/Wt (g)	€	Ref.	Peso/Wt (g)	€	∅ Tubo/Pipe	Brida/Clamp	Uds. Lote/Batch	A	B	C	D
1N045	421	13,92	1N245	318	17,40	63	63	10	140	123	92	43
1N047	1.116	27,51	1N247	783	33,02	90	90	8	203	162	121	50
1N048	1.430	42,94	1N248	1.262	51,55	110	110	8	239	193	144	61
1N049	2.123	66,76	1N249	1.635	76,96	125	125	6	276	217	159	70
1N050	2.900	101,10	1N250	2.900	121,38	140	140	2	294	234	176	76
1N051	3.792	116,49	1N251	2.898	133,95	160	160	2	333	267	201	87
1N052	7.184	167,50	1N252	4.716	192,43	200	200	2	415	330	251	106

06N



Te 90° Netvitic System® C/B

Netvitic System® 90° Tee W/F
Té 90° Netvitic System® A/B

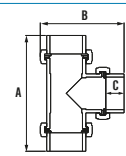

Ref.	€	∅ Tubo/Pipe	Brida/Clamp	Peso/Wt (g)	Uds. Lote/Batch	A	B	C
1N055	67,50	63	63	1.187	4	222	181	36
1N057	113,40	90	90	1.610	4	323	244	52
1N058	139,87	110	110	4.358	4	385	288	61
1N059	176,45	125	125	5.670	2	446	324	69
1N060	309,57	140	140	6.200	1	481	353	77
1N061	324,07	160	160	9.545	1	535	403	86
1N062	464,26	200	200	16.640	1	667	479	107

33N



Te 90° Netvitic System® C/B salida PE

Netvitic System® 90° tee W/F, PE outlet
Té 90° Netvitic System® A/B

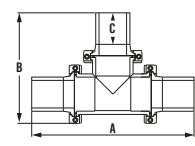

Ref.	€	∅ Tubo/Pipe	Brida/Clamp	Peso/Wt (g)	Uds. Lote/Batch	A	B	C
1N255	119,53	63	63	1.230	4	382	261	88
1N257	225,82	90	90	2.930	4	489	327	103
1N258	302,08	110	110	4.140	4	547	369	112
1N259	345,72	125	125	5.925	2	576	389	108
1N260	495,57	140	140	6.200	1	645	435	124
1N261	508,57	160	160	9.635	1	685	478	127
1N262	838,71	200	200	16.720	1	799	545	130

Valona larga válida para soldadura a tope y electrofusión. / Long PE outlet for thermo and electro welding.



50N

53N



Te corta R/H Netvitc System®

Netvitc System® female threaded short tee
Té court taraudé Netvitc System®

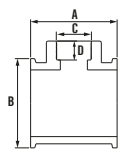

Ref.	Peso/Wt (g)	€	Ref.	Peso/Wt (g)	€	∅ Tubo/Pipe	Brida/Clamp	Uds. Lote/Batch	A	B	C	D
1N473	328	16,55	1N405	280	16,55	63-1 1/2"	63	10	140	92	1 1/2"	26
1N474	413	17,08	1N406	326	17,08	63-2"	63	10	140	92	2"	38
1N477	810	27,82	1N577	438	32,00	90-2"	90	4	137	121	2"	38
1N478	911	40,36	1N578	576	46,37	110-1"	110	4	137	144	1"	23
1N479	838	40,36	1N579	647	46,37	110-1 1/4"	110	4	137	144	1 1/4"	26
1N480	851	40,36	1N580	686	46,37	110-1 1/2"	110	4	137	144	1 1/2"	31
1N481	866	40,51	1N581	612	47,58	110-2"	110	4	137	144	2"	38

51N

Te corta encolar Netvitc System®



Netvitc System® solvent socket short tee
Té court à coller Netvitc System®

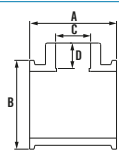

Ref.	€	∅ Tubo/Pipe	Brida/Clamp	Peso/Wt (g)	Uds. Lote/Batch	A	B	C	D
1N457	26,43	90-63	90	581	4	139	121	63	39
1N458	38,92	110-32	110	832	4	139	144	32	23
1N459	38,92	110-40	110	836	4	139	144	40	27
1N460	38,92	110-50	110	841	4	139	144	50	31
1N461	38,92	110-63	110	848	4	139	144	63	39

39N

48N



Te corta R/H Netvitc System® "AIR"

"AIR" Netvitc System® female threaded short tee
Té court taraudé Netvitc System® "AIR"

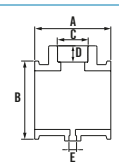

Ref.	Peso/Wt (g)	€	Ref.	Peso/Wt (g)	€	∅ Tubo/Pipe	Brida/Clamp	Uds. Lote/Batch	A	B	C	D	E
1N410	830	30,84	1N420	580	36,90	90-2"	90	4	137	121	2"	38	1/4"
1N411	826	30,84	1N421	575	36,90	90-2"	90	4	137	121	2"	38	1/2"
1N412	820	30,84	1N422	570	36,90	90-2"	90	4	137	121	2"	38	3/4"
1N413	1.088	45,93	1N423	765	52,69	110-2"	110	4	137	144	2"	38	1/4"
1N414	1.085	45,93	1N424	760	52,69	110-2"	110	4	137	144	2"	38	1/2"
1N415	1.080	45,93	1N425	755	52,69	110-2"	110	4	137	144	2"	38	3/4"

40N

47N



Te corta R/H Netvitc System® "AIR L"

"AIR L" Netvitc System® female threaded short tee
Té court taraudé Netvitc System® "AIR L"

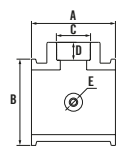

Ref.	Peso/Wt (g)	€	Ref.	Peso/Wt (g)	€	∅ Tubo/Pipe	Brida/Clamp	Uds. Lote/Batch	A	B	C	D	E
1N540	830	30,84	1N430	580	36,90	90-2"	90	4	137	121	2"	38	1/4"
1N541	826	30,84	1N431	575	36,90	90-2"	90	4	137	121	2"	38	1/2"
1N542	820	30,84	1N432	570	36,90	90-2"	90	4	137	121	2"	38	3/4"
1N543	1.088	45,93	1N433	765	52,69	110-2"	110	4	137	144	2"	38	1/4"
1N544	1.085	45,93	1N434	760	52,69	110-2"	110	4	137	144	2"	38	1/2"
1N545	1.080	45,93	1N435	755	52,69	110-2"	110	4	137	144	2"	38	3/4"

ACCESORIOS PRESIÓN NETVITC SYSTEM® NETVITC SYSTEM® PRESSURE FITTINGS

42N

49N



Te doble Netvitic System® salida R/H

Netvitic System® female threaded double tee
Te doble Netvitic System® taraudé

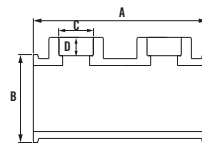

Ref.	Peso/Wt (g)	€	Ref.	Peso/Wt (g)	€	∅ Tubo/Pipe	Brida/Clamp	Uds. Lote/Batch	A	B	C	D
1N700	1.399	53,97	1N710	1.049	64,79	90-2"	90	2	283	121	2"	38
1N704	1.869	78,64	1N714	1.447	94,36	110-2"	110	2	280	144	2"	38

43N

Te doble Netvitic System® salida encolar



Netvitic System® solvent socket outlet double tee
Te doble Netvitic System® sortie à coller

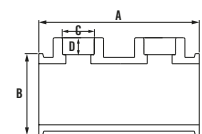

Ref.	€	∅ Tubo/Pipe	Brida/Clamp	Peso/Wt (g)	Uds. Lote/Batch	A	B	C	D
1N720	51,26	90-63	90	1.339	2	283	121	63	38
1N724	75,52	110-63	110	1.806	2	280	144	63	38

45N

57N



Te doble "AIR" Netvitic System® salida R/H

"AIR" Netvitic System® female threaded double tee
Te doble "AIR" Netvitic System® taraudé

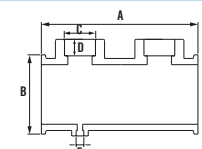

Ref.	Peso/Wt (g)	€	Ref.	Peso/Wt (g)	€	∅ Tubo/Pipe	Brida/Clamp	Uds. Lote/Batch	A	B	C	D	E
1N730	1.447	59,76	1N740	1.027	71,71	90-2"	90	2	283	121	2"	38	1/4"
1N731	1427	59,76	1N741	1.070	71,71	90-2"	90	2	283	121	2"	38	1/2"
1N732	1.510	59,76	1N742	1.121	71,71	90-2"	90	2	283	121	2"	38	3/4"
1N733	1.914	89,14	1N743	1.449	106,98	110-2"	110	2	280	144	2"	38	1/4"
1N734	1.597	89,14	1N744	1.500	106,98	110-2"	110	2	280	144	2"	38	1/2"
1N735	1.909	89,14	1N745	1.424	106,98	110-2"	110	2	280	144	2"	38	3/4"

46N

Te doble "AIR" Netvitic System® salida encolar



"AIR" Netvitic System® solvent socket outlet double tee
Te doble "AIR" Netvitic System® sortie à coller

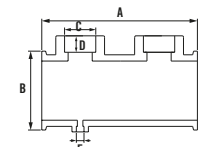

Ref.	€	∅ Tubo/Pipe	Brida/Clamp	Peso/Wt (g)	Uds. Lote/Batch	A	B	C	D	E
1N750	56,83	90-63	90	1.402	2	283	121	63	38	1/4"
1N751	56,83	90-63	90	1.382	2	283	121	63	38	1/2"
1N752	56,83	90-63	90	1.390	2	283	121	63	38	3/4"
1N753	85,62	110-63	110	1.940	2	280	144	63	38	1/4"
1N754	85,62	110-63	110	1.925	2	280	144	63	38	1/2"
1N755	85,62	110-63	110	1.952	2	280	144	63	38	3/4"

NEW PRICE MODIFICACIÓN PRECIO TARIFA ANTERIOR /
MODIFICATION PREVIOUS PRICE LIST



41N



44N



Cruz 90° Netvitc System®

90° Cross Netvitc System®
Croix 90° Netvitc System®

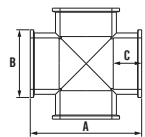

Ref.	Peso/Wt (g)	€	Ref.	Peso/Wt (g)	€	∅ Tubo/Pipe	Brida/Clamp	Uds. Lote/Batch	A	B	C
1N167	1.068	69,37	1N367	921	79,77	90	90	10	202	121	50
1N168	1.921	108,26	1N368	1.356	124,52	110	110	5	238	144	61
1N169	2.406	128,79	1N369	1.702	148,12	125	125	4	276	159	70
1N170	2.870	161,34	1N370	2.640	193,59	140	140	2	301	176	76
1N171	4.482	190,46	1N371	3.185	218,76	160	160	2	334	201	87
1N172	7.205	282,17	1N372	5.190	324,22	200	200	1	408	251	106

Este modelo se puede combinar con diferentes salidas PVC-U, PE, según necesidades de los proyectos. / This model can be combine with different PVC-U, PE outlets according to project requirements.

64N



Te Netvitc System® visor portasondas R/H

Sight glass Netvitc System® tee f/t
Té Netvitc System® avec regard porte sonde tar/fem

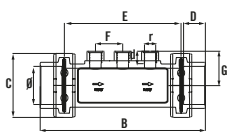

Ref.	€	∅ Tubo/Pipe	Brida/Clamp	Peso/Wt (g)	Uds. Lote/Batch	B	C	D	E	F	G	r	d
1N500	50,72	50	63	1.234	2	298	125	31	189	45	57	1/2"	16
1N501	50,72	63	63	1.180	2	272	125	36	189	45	57	1/2"	16
1N502	50,72	75	63	1.378	2	323	125	42	189	45	57	1/2"	16
1N503	137,32	90	90	2.177	2	377	164	52	260	55	76	1/2"	16

09N



34N



Manguito Netvitc System®

Netvitc System® coupling
Manchon Netvitc System®

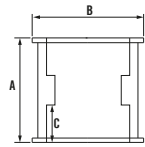

Ref.	Peso/Wt (g)	€	Ref.	Peso/Wt (g)	€	∅ Tubo/Pipe	Brida/Clamp	Uds. Lote/Batch	A	B	C
1N067	258	12,35	1N267	471	14,82	90	90	8	147	121	50
1N068	1.009	20,54	1N268	756	24,64	110	110	8	167	144	61

10N



Manguito Netvitc System® C/B

Netvitc System® coupling W/F
Manchon Netvitc System® A/B

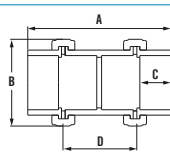

Ref.	€	∅ Tubo/Pipe	Brida/Clamp	Peso/Wt (g)	Uds. Lote/Batch	A	B	C	D
1N077	69,55	90	90	1.893	4	267	164	52	147
1N078	85,08	110	110	2.630	4	313	188	61	167

35N



Manguito Netvitc System® C/B salida PE

Netvitc System® coupling W/F, PE outlet
Manchon Netvitc System® A/B

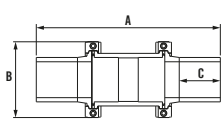

Ref.	€	∅ Tubo/Pipe	Brida/Clamp	Peso/Wt (g)	Uds. Lote/Batch	A	B	C
1N277	143,23	90	90	1.790	4	433	164	103
1N278	198,92	110	110	2.472	4	475	188	112

Valona larga válida para soldadura a tope y electrofusión. / Long PE outlet for thermo and electro welding.



ACCESORIOS PRESIÓN NETVITC SYSTEM®

NETVITC SYSTEM® PRESSURE FITTINGS

52N



PVC

54N



Reducción cónica Netvitic System®

Netvitic System® Conical reduction
Réduction conique Netvitic System®

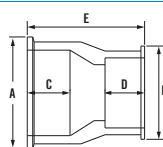

Ref.	Peso/Wt (g)	€	Ref.	Peso/Wt (g)	€	∅ Tubo/Pipe	Brida/Clamp	Uds. Lote/Batch	A	B	C	D	E
1N197	797	14,35	1N397	583	16,55	110-90	110-90	8	144	121	60	50	151
1N198	949	22,87	1N398	716	27,38	125-90	125-90	8	159	121	68	50	160
1N199	1.094	23,78	1N399	776	28,36	125-110	125-110	8	159	144	68	61	169

11N



PVC

13N



Enlace 3 piezas encolar Netvitic System®

Netvitic System® Union, solvent socket
Raccord 3 pièces Netvitic System® á collar

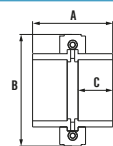

Ref.	∅ Tubo/Pipe	€	Ref. BS	∅ Tubo/Pipe	€	Brida/Clamp	Peso/Wt (g)	Uds. Lote/Batch	A	B	C
10371	40	20,13	10333	1 1/4"	27,62	63	347	8	105	125	28
10372	50	24,38	10334	1 1/2"	29,76	63	405	8	107	125	31
10373	63	31,74	10335	2"	36,92	63	361	8	81	125	36
10374	75	39,22	10336	2 1/2"	45,60	75	457	8	95	138	44
10327	90	50,89	10337	3"	59,65	90	883	4	114	164	52
10328	110	60,48	10338	4"	65,55	110	1.326	4	140	188	61
10329	125	78,17	-	-	-	125	1.689	2	164	203	69
10330	140	103,46	10340	5"	116,78	140	2.216	2	180	224	77
10331	160	125,05	10341	6"	137,97	160	3.199	2	195	251	86
10332	200	214,01	10342	8"	226,85	200	4.908	2	244	297	107
10375	225	216,01	-	-	-	200	5.647	2	330	297	120

12N



Enlace 3 piezas Netvitic System® PE-PE

Netvitic System® Union PE-PE
Raccord 3 pièces Netvitic System® PE-PE

PE

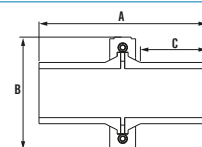

Ref.	€	∅ Tubo/Pipe	Brida/Clamp	Peso/Wt (g)	Uds. Lote/Batch	A	B	C
10344	49,13	50	63	447	4	239	125	55
10345	63,45	63	63	510	4	241	125	88
10346	79,67	75	75	655	4	257	138	99
10347	112,72	90	90	1.117	4	280	164	103
10348	128,16	110	110	1.940	4	302	188	112
10349	158,62	125	125	2.285	2	294	203	108
10350	170,21	140	140	2.795	2	344	224	124
10351	187,38	160	160	3.600	2	353	251	127
10352	350,16	200	200	5.709	1	376	297	130
10353	350,16	225	200	6.665	1	396	297	161

Valona larga válida para soldadura a tope y electrofusión. / Long PE outlet for thermo and electro welding.

14N
Enlace 3 piezas Netvitc System® PE-encolar

Netvitc System® Union PE-solvent socket
Raccord 3 pièces Netvitc System® PE- à coller

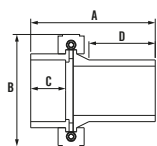

Ref.	€	∅ Tubo/Pipe	Brida/Clamp	Peso/Wt (g)	Uds. Lote/Batch	A	B	C	D
10354	33,71	50	63	420	4	173	125	31	55
10355	47,70	63	63	416	4	161	125	36	88
10356	69,93	75	75	559	4	176	138	44	99
10357	89,11	90	90	978	4	197	164	52	103
10358	118,58	110	110	1.461	4	221	188	61	112
10359	135,14	125	125	2.004	2	229	203	69	108
10360	159,21	140	140	2.368	2	262	224	77	124
10361	170,72	160	160	3.453	2	274	251	86	127
10362	267,04	200	200	5.497	1	310	297	107	130
10363	267,04	225	200	5.220	1	363	297	120	161

Valona larga válida para soldadura a tope y electrofusión. / Long PE outlet for thermo and electro welding.

07N
36N
Tapón Netvitc System®

Netvitc System® cap
Bouchon Netvitc System®

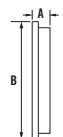

Ref.	Peso/Wt (g)	€	Ref.	Peso/Wt (g)	€	∅ Tubo/Pipe	Brida/Clamp	Uds. Lote/Batch	A	B
1N084	55	10,35	1N284	42	12,44	50*	50	8	19	74
-	-	-	1N285	76	12,44	63*	63	8	19	92
1N085	109	10,35	1N283	80	12,44	63	63	8	21	121
1N087	187	13,75	1N287	128	16,44	90	90	8	21	144
1N088	297	28,70	1N288	200	34,42	110	110	8	22	159
1N089	333	36,84	1N289	225	42,36	125	125	6	26	177
1N090	507	51,26	1N290	331	58,44	140	140	4	25	201
1N091	848	58,37	1N291	533	68,66	160	160	4	29	251
1N092	1.478	73,85	1N292	1.027	88,63	200	200	4	29	251

* Sólo para colectores SNS®. / Only for SNS® manifolds.

08N
Tapón Netvitc System® C/B

Netvitc System® cap W/F
Bouchon Netvitc System® A/B

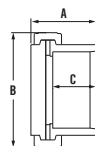

Ref.	€	∅ Tubo/Pipe	Brida/Clamp	Peso/Wt (g)	Uds. Lote/Batch	A	B	C
1N097	42,37	90	90	863	8	81	164	52
1N098	61,11	110	110	1.233	8	94	188	61
1N099	72,85	125	125	1.564	6	107	203	69
1N100	107,99	140	140	2.106	4	119	224	77
1N101	131,33	160	160	2.951	2	126	251	86
1N102	203,33	200	200	4.470	2	155	297	107
1N103	203,33	225	200	4.941	2	198	297	120



ACCESORIOS PRESIÓN NETVITC SYSTEM® NETVITC SYSTEM® PRESSURE FITTINGS

37N

Tapón Netvitic System® C/B salida PE



Netvitic System® cap W/F, PE outlet
Bouchon Netvitic System® A/B

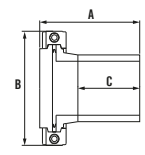

Ref.	€	∅ Tubo/Pipe	Brida/Clamp	Peso/Wt (g)	Uds. Lote/Batch	A	B	C
1N295	61,04	63	63	400	8	140	125	88
1N297	80,75	90	90	910	8	164	164	103
1N298	118,08	110	110	1.253	8	175	188	112
1N299	132,13	125	125	1.705	6	172	203	108
1N300	166,38	140	140	1.878	4	201	224	124
1N301	203,20	160	160	2.720	2	205	251	127
1N302	315,67	200	200	5.082	2	221	297	130
1N303	315,67	225	200	4.341	2	231	297	161

Valona larga válida para soldadura a tope y electrofusión. / Long PE outlet for thermo and electro welding.

65N

Conexión Netvitic System® con junta elástica



Netvitic System® rubber ring adaptor
Connexion Netvitic System® avec joint élastique

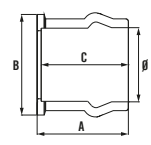

Ref.	€	∅ Tubo/Pipe	Brida/Clamp	Peso/Wt (g)	Uds. Lote/Batch	A	B	C
1N766	56,10	160	160	1.576	2	136	201	129
1N767	59,05	200	200	2.551	1	145	250	141

19N

Conexión encolar-Netvitic System®



Netvitic System® adaptor
Collet Netvitic System®

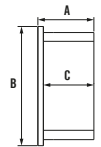

Ref.	€	∅ Tubo/Pipe	Brida/Clamp	Peso/Wt (g)	Uds. Lote/Batch	A	B	C
1N977	5,27	63	63	102	16	40	92	43
1N980	7,29	75	75	151	16	47	100	44
1N981	11,09	90	90	241	8	54	121	50
1N983	13,84	110	110	473	8	67	144	61
1N986	18,62	125	125	559	8	79	159	70
1N988	23,76	140	140	885	8	87	176	76
1N990	33,68	160	160	1.049	4	94	201	87
1N992	62,02	200	200	1.775	4	118	251	106

66N

Conexión encolar-Netvitic System® BS



Netvitic System® adaptor BS
Collet Netvitic System® BS

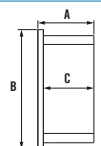

Ref.	€	∅ Tubo/Pipe	Brida/Clamp	Peso/Wt (g)	Uds. Lote/Batch	A	B	C
1N869	-	2"	63	114	16	40	92	36
1N980	-	2 1/2"	75	151	16	47	100	44
1N870	-	3"	90	241	8	54	121	52
1N871	-	4"	110	406	8	67	144	61
1N988	-	5"	140	513	8	79	159	69
14973	-	6"	160	855	4	87	176	77
1N873	Consultar/ To consult	8"	200	997	4	94	201	86

67N
Conexión encolar-Netvitc System® ANSI

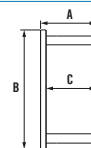
 Netvitc System® adaptor ANSI
 Collet Netvitc System® ANSI

Ref.	€	∅ Tubo/Pipe	Brida/Clamp	Peso/Wt (g)	Uds. Lote/Batch	A	B	C
1N877	-	63	63	114	16	40	92	36
1N878	-	75	75	151	16	47	100	44
1N879	-	90	90	241	8	54	121	52
1N880	-	110	110	406	8	67	144	61
1N881	-	125	125	513	8	79	159	69
1N882	-	140	140	855	4	87	176	77
1N883	Consultar/ To consult	160	160	997	4	94	201	86

20N
Conexión reducido enc. Netvitc System®

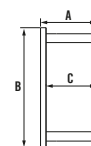
 Netvitc System® reducing adaptor
 Collet réduit Netvitc System®

Ref.	€	∅ Tubo/Pipe	Brida/Clamp	Peso/Wt (g)	Uds. Lote/Batch	A	B	C
1N975	5,27	40	63	90	16	51	92	28
1N976	5,27	50	63	118	16	60	92	31
1N979	5,27	75	63	186	16	65	100	39
1N978	7,29	63	75	148	16	65	92	42
1N982	18,62	90	125	456	8	58	159	52
1N984	18,62	110	125	522	8	67	159	62
1N985	33,68	110	160	757	4	70	201	61
1N987	33,68	125	160	817	4	80	201	69
1N989	33,68	140	160	871	4	87	201	78
1N991	62,02	200	160	1.876	4	150	201	107
1N993	62,02	225	200	2.200	4	161	251	120

21N
Conexión PE Netvitc System®

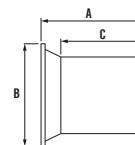
 Netvitc System® PE adaptor
 Collet PE Netvitc System®

Ref.	€	∅ Tubo/Pipe	Brida/Clamp	Peso/Wt (g)	Uds. Lote/Batch	A	B	C
1N951	34,69	63	63	164	16	120	92	88
1N953	46,38	75	75	227	16	128	100	99
1N954	46,38	90	90	348	8	137	120	103
1N956	64,52	110	110	538	8	148	144	112
1N958	68,20	125	125	832	8	144	159	108
1N959	79,45	140	140	917	8	169	176	124
1N961	96,94	160	160	1.540	4	173	201	124
1N962	190,49	200	200	2.755	4	184	250	130

Valona larga válida para soldadura a tope y electrofusión. / Long PE outlet for thermo and electro welding.



ACCESORIOS PRESIÓN NETVITC SYSTEM®

NETVITC SYSTEM® PRESSURE FITTINGS

22N

Conexión reducido PE Netvitic System®



Netvitic System® reducing adaptor PE
Collet réduit PE Netvitic System®

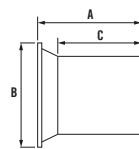

Ref.	€	∅ Tubo/Pipe	Brida/Clamp	Peso/Wt (g)	Uds. Lote/Batch	A	B	C
1N950	34,69	50	63	146	16	119	92	55
1N952	46,38	63	75	223	16	118	100	65
1N955	68,20	90	125	534	8	140	158	81
1N957	68,20	110	125	609	8	186	158	90
1N960	96,94	140	160	1.368	4	190	201	98
1N963	190,49	225	200	2.014	4	194	250	161

Valona larga válida para soldadura a tope y electrofusión. / Long PE outlet for thermo and electro welding.

69N

Conexión Netvitic System® con válvula de bola



Netvitic System® ball valve outlet
Sortie Netvitic System® vanne à boisseau

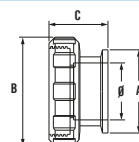

Ref.	€	∅ Tubo/Pipe	Brida/Clamp	Peso/Wt (g)	Uds. Lote/Batch	A	B	C
11N816	17,52	63	63	282	20	92	116	62
11N817	64,26	75	75	575	10	104	150	70
11N818	69,24	90	90	981	5	121	178	83
11N809	83,78	110	110	1.346	2	144	210	89
11N810	100,37	125	125	1.480	2	159	230	81

25N

38N

Conexión bridas Netvitic System®



Netvitic System® transition flange
Bride de transition Netvitic System®

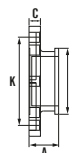

Ref.	Peso/Wt (g)	€	Ref.	Peso/Wt (g)	€	∅ Tubo/Pipe	Brida/Clamp	Uds. Lote/Batch	A	B	C	K
1N137	1.040	25,44	1N337	117	30,53	90	90	8	89	121	24	146-160
1N138	1.178	32,19	1N338	989	38,65	110	110	8	92	144	26	178-190
1N139	1.521	36,82	1N339	1.103	44,21	125	125	8	95	159	27	190
1N140	1.615	36,82	1N340	1.375	44,21	125-140	140	8	98	159	29	210-216
1N141	2.560	59,69	1N341	1.695	70,17	160	160	8	102	201	30	235-241

k= Distancia entre tornillos (mm). / Distance between bolts (mm). / Distance entre les vis (mm).

17N

Conexión sistema ranurado Netvitic System®



Netvitic System® adaptor
Collet Netvitic System®

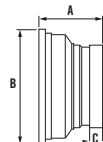

Ref.	€	∅ Tubo/Pipe	Brida/Clamp	Peso/Wt (g)	Uds. Lote/Batch	A	B	C
1N936	26,51	2"	63	155	8	45	94	16
1N938	29,81	3"	90	165	4	64	121	16
1N940	34,26	3"	125	320	4	86	159	16
1N939	32,78	4"	110	404	4	90	121	18
1N941	38,53	4"	125	417	4	94	159	18

Conexión sistema ranurado. / Grooved system connection.

18N
Conexión R/H- Netvitc System®

Netvitc System® adaptor female threaded
Collet taraudée Netvitc System®

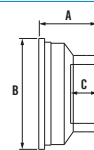

Ref.	€	Ø Tubo/Pipe	Brida/Clamp	Peso/Wt (g)	Uds. Lote/Batch	A	B	C
1N918	32,35	2"	63	107	4	40	92	37
1N919	41,91	1"	90	143	4	56	121	22
1N920	41,91	2"	90	193	4	50	121	38
1N921	44,61	3"	90	233	4	70	121	51
1N924	44,14	2"	110	192	4	65	144	38
1N926	46,32	3"	110	263	4	78	144	51
1N927	46,40	4"	110	396	4	86	144	62
1N929	50,95	2"	125	500	4	82	159	38
1N930	50,95	2 1/2"	125	460	4	86	159	44
1N931	50,95	3"	125	396	4	86	159	51
1N932	54,68	4"	125	477	4	86	159	62
1N933	63,18	3"	140	647	2	84	177	37
1N934	70,97	3"	160	990	2	86	201	51

Refuerzo en acero inoxidable A-2. / *Stainless steel reinforcement A-2.*

68N
Conexión espiga

Spigot connection
Raccord à embout

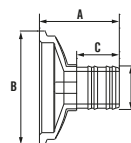

Ref.	€	Ø Tubo/Pipe	Brida/Clamp	Peso/Wt (g)	Uds. Lote/Batch	A	B	C	D
1N771	50,95	2"	125	258	4	112	159	60	61
1N773	50,95	3"	125	350	4	134	159	86	100

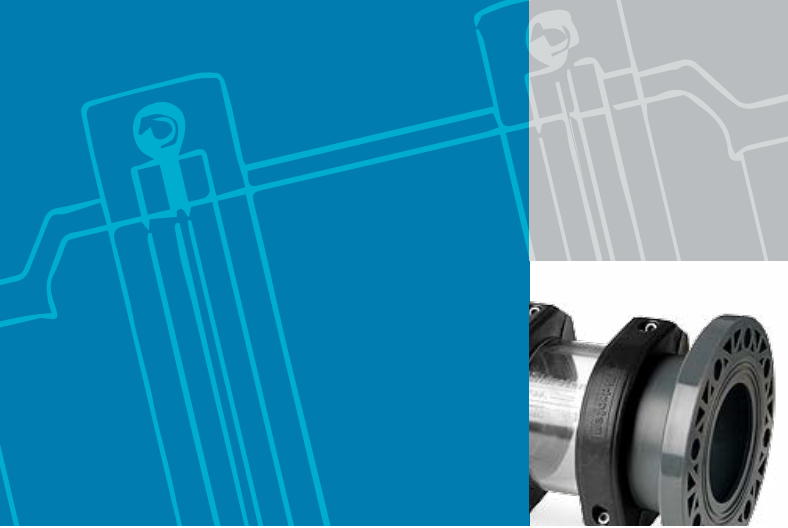



VISOR DE LÍQUIDOS SNS®
SNS® FLUIDS DISPLAY

FAMILIA
18 FAMILY



CARACTERÍSTICAS // FEATURES

El visor de líquidos Netvitic System® es el único elemento para visualización de los fluidos obtenido mediante inyección directa de policarbonato, no siendo un simple trozo de tubo transparente, consiguiendo así una **perfecta integración en la instalación** y una resistencia mecánica superior.

Gracias a la conexión Netvitic System®, se consigue **el visor más ligero y rápido de montar** del mercado, aportando un gran ahorro de tiempo en la instalación gracias a la reducción en la tornillería necesaria para su montaje.

La conexión mediante el sistema Netvitic System® aporta gran versatilidad gracias a sus **múltiples opciones de salidas**, aportando una enorme facilidad en el montaje. Dispone de salidas PVC-U, PE, RH, sistema ranurado y bridas, teniendo siempre la adecuada para su instalación.

Netvitic System® liquid fluid display is the only fluid display in the market made by direct injection of polycarbonate, and it is not just a piece of transparent tube. Thus, a **perfect integration in the installation** is achieved, with optimal transparency and a higher mechanical resistance.

Thanks to the Netvitic System® connection, a **lighter fluid display** is obtained, which is also the **quickest to be assembled** in the market. It saves you lots of installation time due to a reduction of the screws to be used to assemble it.

Connection made with the Netvitic System® provides a great versatility, with **many outlet options**, adding an enormous ease in the assembling. It has PVC-U, PE, FT outlets, grooved system and flanges, always with the one suitable for installation.

COMPONENTES // COMPONENTS



1. Enlace conexión PVC-U
2. Junta Netvitic System® EPDM
3. Visor policarbonato
4. Alma de junta en Inox A-4
5. Brida Netvitic System® PA

1. PVC-U union connection
2. EPDM Netvitic System® gasket
3. Polycarbonate visor
4. Inox A-4 joint inner ring
5. PA flange Netvitic System®

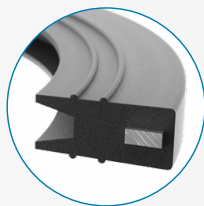
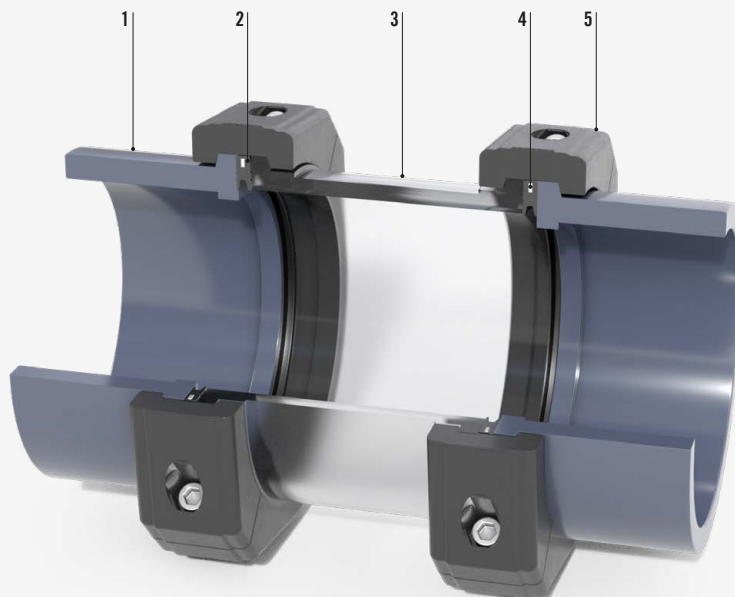

Detalle junta "J-Bil"
"J-Bil" o-ring detail

SECTOR	Piscina, tratamiento de agua, agricultura e industria / <i>Swimming pool, water treatment, agriculture and industry</i>
MATERIAL	PVC-U y PE 100 / <i>PVC-U & PE 100</i>
MAT. VISOR/DISPLAY	Policarbonato / <i>Polycarbonate</i>
TORNILLERÍA/SCREWS	Tornillo en Inox A-2, tuerca en Inox A-4 / <i>SS A2 bolt and SS A4 nut</i>
PN	PN 10
MEDIDAS/MEASURES	Salida encolar Ø40-225 / <i>Solvent socket outlet from Ø40 to 225</i> Salida rosca/hembra Ø2"-4" / <i>Female threaded outlet from Ø2" to 4"</i> Salida sistema ranurado Ø2"-3"-4" / <i>Grooved system outlet from Ø2"-3"-4"</i> Salida PE Ø50-225 / <i>PE outlet from Ø50 to 225</i> Salida bridas Ø125-160 / <i>Flange outlet from Ø125 to 160</i>

SECUENCIA DE MONTAJE // ASSEMBLY SEQUENCE



- | | |
|--|---|
| <ol style="list-style-type: none"> 1. Encolar el portabridas. 2. Colocar junta y cuerpo frente al portabridas, en el sentido del flujo. 3. Colocar la brida y la fijamos con su tornillería. 4. Repetimos la operación en la otra parte del visor. 5. Visor instalado y lista para su funcionamiento. | <ol style="list-style-type: none"> 1. Glue the adaptor. 2. Place the gasket and body against the adaptor, in flow direction. 3. Place the flange and fix screws. 4. Repeat the operation on the other side of the fluid display. 5. Fluid display installed and ready for operation. |
|--|---|

INSTALACIÓN VISOR DE LÍQUIDOS SNS® // INSTALLATION SNS® FLUIDS DISPLAY

En la imagen podemos apreciar como el cuerpo transparente del visor de líquidos Netvitc System® aporta una visión nítida del fluido, lo que permite tener información directa de la limpieza y calidad del mismo. Esto es especialmente útil tras los equipos de filtración, al ver directamente el resultado de su funcionamiento. // In the image we can see a Netvitc System® sight glass for liquids which give us a clear sight of the fluid, providing direct information of its cleanliness and quality. This is specially useful behind filtration equipments, because we can see directly their performance.

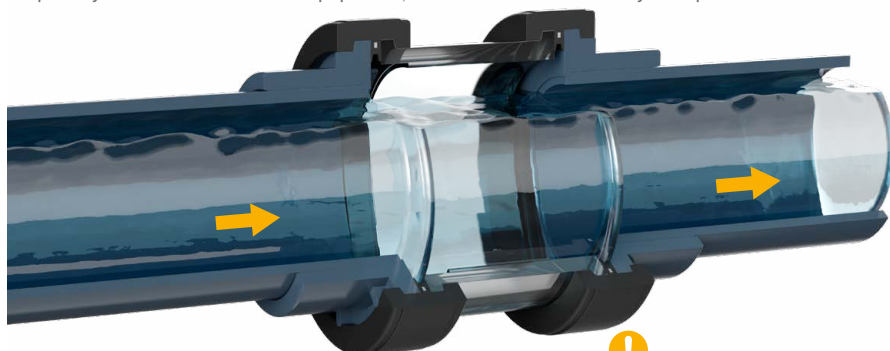

Para recomendaciones de uso y apriete del tornillo, ver pg. 05.
 For recommendations for use and tightening of the bolt, see pg. 05.

VISOR DE LÍQUIDOS NETVITC SYSTEM®

NETVITC SYSTEM® FLUIDS DISPLAY

88

Salida encolar VISOR



Fluids display solvent socket outlet
Voyant de controle à coller

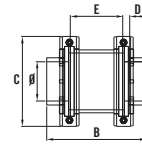

Ref.	€	∅ Tubo/Pipe	Brida/Clamp	Peso/Wt (g)	Uds. Lote/Batch	B	C	D	E
18004	43,86	40	63	738	10	182	134	28	76
18005	43,86	50	63	789	10	184	134	31	76
18006	52,98	63	63	750	10	158	134	36	76
18007	65,05	75	63	931	10	208	134	39	76
18008	85,30	90	125	2.820	4	248	215	52	120
18009	95,95	110	125	2.985	4	266	215	62	120
18010	107,26	125	125	3.049	2	290	215	69	120
18011	148,07	140	160	5.300	2	327	264	78	139
18012	176,78	160	160	5.540	2	341	264	86	139
● 18014	397,00	200	200	9.170	1	468	315	107	216
● 18015	421,82	225	200	14.481	1	554	315	120	216

Opción / Optional "BS", "ASTM", "JIS"

89

Salida sistema ranurado Netvitc® VISOR



Fluids display Netvitc® grooved system outlet
Voyant de controle Netvitc®

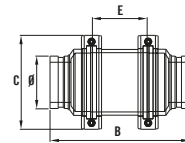

Ref.	€	∅ Tubo/Pipe	Brida/Clamp	Peso/Wt (g)	Uds. Lote/Batch	B	C	D
18016	54,50	2"	63	750	4	174	134	76
18018	57,74	3"	125	1.992	4	292	215	120
18019	71,21	4"	125	2.730	4	308	215	120

Conexión sistema ranurado. / Grooved system connection.

90

Salida PE/PE VISOR



PE outlet
Sortie PE

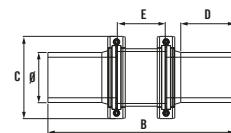

Ref.	€	∅ Tubo/Pipe	Brida/Clamp	Peso/Wt (g)	Uds. Lote/Batch	B	C	D	E
18045	63,80	50	63	840	10	316	134	55	76
18046	63,80	63	63	852	10	318	134	88	76
18048	102,08	90	125	3.619	4	412	215	81	120
18049	112,17	110	125	2.953	4	504	215	90	120
18050	130,02	125	125	3.390	2	420	215	108	120
18051	167,81	140	160	5.995	2	533	264	98	139
18052	212,67	160	160	5.963	2	491	264	127	139
● 18053	496,26	200	200	10.078	1	600	315	130	216
● 18054	512,82	225	200	10.555	1	620	315	161	216

Valona larga válida para soldadura a tope y electrofusión. / Long PE outlet for thermo and electro welding.

● Brida Netvitc System® abisagrada. / Netvitc System® hinged flange.

91
Salida rosca hembra VISOR

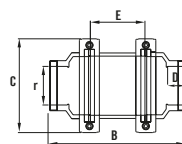
 Fluids display female threaded outlet
 Voyant de controle taraudé

Ref.	€	∅ Tubo/Pipe r	Brida/Clamp	Peso/Wt (g)	Uds. Lote/Batch	B	C	D	E
18026	78,75	2"	125	711	10	178	125	38	70
18027	87,34	2 1/2"	125	2.931	4	292	215	38	120
18028	87,34	3"	125	2.600	4	292	215	34	120
18029	100,07	4"	125	2.800	4	292	215	44	120

513
Salida brida VISOR

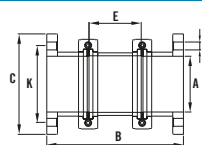
 Fluids display flange outlet
 Voyant de controle bride

Ref.	€	∅ Tubo/Pipe A	Brida/Clamp	Peso/Wt (g)	Uds. Lote/Batch	B	C	D	E	K
18069	143,99	125	125	5.145	1	322	230	18	120	190
18070	143,99	125-140	125	3.100	1	322	250	18	120	210-216
18071	221,94	160	160	8.180	1	355	285	18	139	235-241

K= Distancia entre tornillos (mm). / Distance between bolts (mm).

SCREEN PLUS

El filtro Screen Plus, es el resultado de la **integración de una válvula de retención con un medio filtrante**, para protegerla de los sólidos y evitar así obstrucciones de esta. Ver pg. 52.

The Screen filter Plus is the **integration of a check valve with a filter medium**, to protect it from solids and thus prevent clogging. See pg. 52.



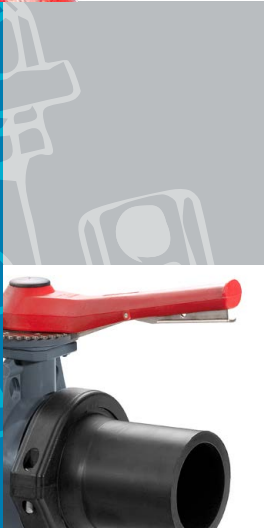



VÁLVULAS DE MARIPOSA SNS®
SNS® BUTTERFLY VALVES

FAMILIA
09N FAMILY



VÁLVULAS DE MARIPOSA NETVITC SYSTEM®

NETVITC SYSTEM® BUTTERFLY VALVES



CARACTERÍSTICAS // FEATURES

La válvula de mariposa Netvitc System® se beneficia de una **ligereza, modularidad y facilidad de montaje** sin igual en el mercado. Aporta independencia en el cierre de los dos lados de la válvula, pudiendo quedar en carga en operaciones de mantenimiento de la instalación, algo que no se podría hacer con las válvulas tradicionales.

El uso del conjunto gatillo-corona dentada de la válvula de mariposa, ofrecen una gran robustez en su manipulación y definición en su posicionamiento. Esto permite una **excelente regulación de la apertura** y una gran seguridad en la operación, conociendo siempre con precisión la posición de la maneta.

La válvula de mariposa Netvitc System®, tiene como estándar el sistema de apertura manual, pero siempre podremos montar sobre cualquier válvula un reductor manual o un actuador eléctrico o neumático.

The Netvitc System® butterfly valve is unequally **lightness, modular and assembly ease**. The closing of the two sides of the valve is independent and it can be on charge during maintenance operations of the installation, which cannot be done with traditional valves.

The use of the set trigger-toothed crown of the butterfly valve offers a great robustness at handling and definition at its placement. It allows an **excellent regulation of the opening** and a great safety in the operation, being always aware of the precision of the handle location.

The Netvitc System® butterfly valve has the manual opening system as a standard, but we can always set on any valve a manual gearbox or an actuator pneumatic and electric.

COMPONENTES // COMPONENTS

1. Maneta PPFV
2. Gatillo Inox A-2
3. Tapón superior PP
4. Brida Netvitc System® PA
5. Junta Netvitc System® EPDM
6. Mariposa PVC-U
7. Junta cierre mariposa EPDM
8. Cuerpo mariposa PVC-U
9. Aro acero inoxidable A-4
10. Conexión encolar PVC-U Netvitc System®
11. Casquillo guía eje POM
12. Eje acero zincado
13. Junta tórica EPDM
14. Corona dentada INOX A-2

1. GRPP lever
2. Stainless steel A-2 trigger
3. PP upper cap
4. PA flange Netvitc System®
5. EPDM Netvitc System® gasket
6. PVC-U butterfly
7. EPDM closing seal
8. PVC-U valve body
9. SS A-4 ring
10. PVC-U Netvitc System® connection
11. POM guideway axis
12. Zinc plated steel shaft
13. EPDM O-ring
14. Stainless steel A-2 crown

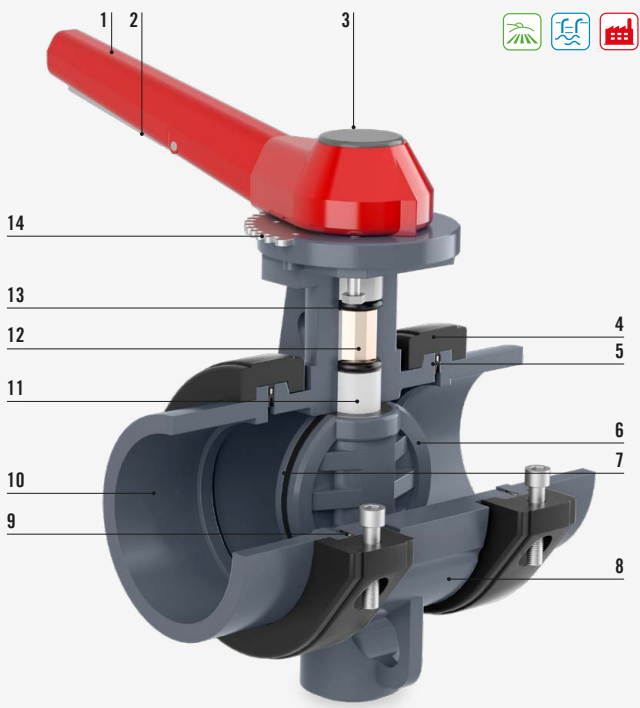

Para recomendaciones de uso y apriete del tornillo, ver pg. 05.
For recommendations for use and tightening of the bolt, see pg. 05.

SECTOR	Agricultura, acuicultura, piscinas, obras públicas e industria / <i>Agriculture, fish farming, swimming pool, civil engineering and industry</i>
MATERIAL	PVC-U / <i>PVC-U</i>
MAT. JUNTA / CLOSING SEAL	EPDM
MANETA / HANDLE	Gatillo, con once posiciones / <i>Trigger with eleven positions</i>
MOTORIZACIÓN / ACTUATION	Actuador eléctrico y neumático de simple o doble efecto / <i>Electric actuator and pneumatic simple or doubling acting</i>
SALIDAS / OUTLETS	Encolar, PE / <i>Solvent socket outlet, PE outlet</i>
PN	PN 10 desde Ø63 a 160 / <i>PN 10 from Ø63 to 160</i> PN 6 desde Ø200/225 / <i>PN 6 from Ø200/225</i>
MEDIDAS / MEASURES	Desde Ø63 a 225 / <i>From Ø63 to 225</i>



MONTAJE VÁLVULA DE MARIPOSA SNS® // SNS® BUTTERFLY VALVE ASSEMBLY

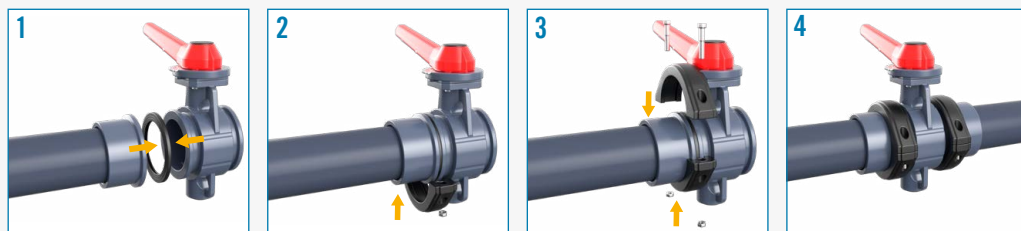

1. Encolado el adaptador, colocar la válvula quedando la junta entre las dos partes.
2. Colocar la brida, asegurando que asienta debidamente en las dos partes.
3. A continuación, colocar la parte opuesta de la brida y la tornillería, apretando de forma alternativa.
4. Se repite la operación en la otra salida, quedando la válvula instalada.

VENTAJAS SISTEMA TRADICIONAL-SNS® // ADVANTAGES TRADITIONAL SYSTEM-SNS®

Las válvulas de mariposa Netvitc System® son más ligeras que el sistema tradicional, manteniendo todas sus garantías y mejorando sus prestaciones. Son válvulas que gracias a su sistema son más compactas, lo que le confiere una mayor versatilidad para montajes en lugares de difícil instalación.

Netvitc System® butterfly valves are lighter than the traditional system, keeping all their guarantees and improving performance. These valves are more compact thanks to their system, which gives them greater versatility for installation in places where installation is difficult.

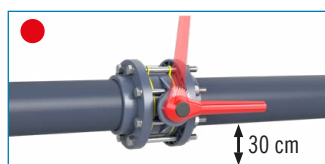

Válvula de mariposa sistema tradicional
Traditional system butterfly valve

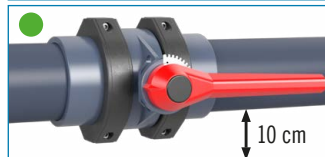

Válvula de mariposa SNS®
SNS® butterfly valve



CARACTERÍSTICAS ACTUADOR ELÉCTRICO // ELECTRIC ACTUATORS FEATURES

ESPECIFICACIONES / SPECIFICATIONS	B35	S35	B55	S55	B85	S85	B140	S140
VOLTAJE (V) / VOLTAGE (V)	12 VDC/VAC	24-240 VDC/VAC	12 VDC/VAC	24-240 VDC/VAC	12 VDC/VAC	24-240 VDC/VAC	12 VDC/VAC	24-240 VDC/VAC
FRECUENCIA (Hz) / FRECUENCE (Hz)	50/60 HZ -0/+5%							
TIEMPO MANIOBRA SIN CARGA / OPERATION TIME UNLOAD (s)	9 sec/90°		13 sec/90°		29 sec/90°		34 sec/90°	
PAR MÁXIMO OPERACIONAL / MAXIMUM OPERATIONAL TORQUE	35 Nm/309 lb/in		55 Nm/486 lb/in		85 Nm/752 lb/in		140 Nm/1239 lb/in	
PAR MÁXIMO ARRANQUE / MAXIMUM TORQUE BREAK	38 Nm/359,3 lb/in		60 Nm/530 lb/in		90 Nm/796,3 lb/in		170 Nm/1504,5 lb/in	
TIEMPO BAJO TENSIÓN / DUTY RATING	75%							
GRADO PROTECCIÓN IEC 60529 / PROTECTION IEC 60529 RATING	IP67							
ÁNGULO MÁXIMO DE MANIOBRA / MAX. WORKING ANGLE	0° - 270°							
TEMPERATURA / TEMPERATURE	-20°C + 70°C / -4°F + 158°F							
INTERRUPTORES FINAL CARRERA / LIMIT SWITCH	4 SPST NO micro (2 motor stop and 2 confirmations)							
RESISTENCIA CALEFACTORA / AUTOMATIC HEATER	3,5 W							
CONECTORES / CONNECTORS	Conector grande EN 175301-803 FORM A. Conector pequeño DIN 43650/C.							
BRIDA ISO 5211 / ISO 5211 PLATE	Standard F03/F04/F05 Optional: F07*17mm		F05/F07				Standard F07/F10 Optional: F12	
SALIDA DOBLE CUADRADO DIN 3337 / DIN 3337 FEMALE OUTPUT DRIVE	Standard: *14mm Optional: *9, *11mm		Standard: *17mm Optional: *11, *14mm		Standard: *17mm Optional: *14mm		Standard: *22mm Optional: *17mm	
PESO / WEIGHT	1,9 Kg		2,4 Kg		3 Kg		5,2 Kg	

- Actuadores eléctricos multivoltaje rotativos de 1/4" de vuelta.
- Control electrónico del par para obtener un funcionamiento suave.
- Control visual de operación mediante un led externo indicador del estado del actuador.
- Mando manual de emergencia.
- Control automático de la temperatura.
- Materiales anticorrosivos para un funcionamiento óptimo en cualquier ambiente.
- Opción de posicionador digital DPS: 4-20mA, 0-20mA, 0-10V o 1-10V.
- Opción cierre de seguridad mediante baterías, sistema BSR.
- Electric multi-voltage actuator, rotation of 1/4" revolution.
- Electronic control of the coupling in order to ensure a smooth functioning.
- Visual control of the operation by means of an external LED showing the actuator state.
- Emergency manual command.
- Automatic temperature control.
- Anticorrosive materials for an optimal functional in any environment.
- Option of DPS digital positioner: 4-20mA, 0-20mA, 0-10V or 1-10V.
- Option of security closing using batteries, BSR system.

CARACTERÍSTICAS ACTUADOR NEUMÁTICO // PNEUMATIC ACTUATORS FEATURES

MODELO MODEL	CONSUMO CONSUMPTION (Lt/ciclo)	PAR MUELLES (Nm) SPRING TORQUE		PAR ALIMENTADOR (Nm) FEEDER TORQUE		PESO (Kg) WEIGHT	Presión aire 6 bar tiempo maniobra (sec.) / Air pressure 6 bar maneuver time	
		0°	90°	0°	90°		APERTURA OPENING	CIERRE CLOSING
H075 SE	0,61	45,1	25,3	45,1	25,3	3,370	0,7	1
H100 SE	1,8	106,4	60,0	106,4	60,0	6,820	1,1	1,3
H115 SE	2,8	168,5	106,0	168,5	106,6	10,3	1,2	1,6
H125 SE	3,7	233,6	127,5	233,6	127,5	14,2	1,3	2,1

MODELO MODEL	CONSUMO CONSUMPTION (Lt/ciclo)	PAR ACTUADOR MODEL	PESO ACTUADOR(Kg) ACTUATOR WEIGHT	Presión aire 6 bar tiempo maniobra (sec.) / Air pressure 6 bar maneuver time	
				APERTURA OPENING	CIERRE CLOSING
H075 DE	0,61	70,2 Nm	2,900	0,6	0,7
H085 DE	0,98	106,9 Nm	4,200	0,6	0,9
H100 DE	1,80	166,4 Nm	5,800	0,8	0,9

- Los actuadores de Simple efecto son aquellos que realizan la apertura mediante aire y el cierre mediante unos muelles de seguridad.
- Single effect ensures the opening by means of air and the closing by means of security springs.
- Los actuadores de Doble efecto son aquellos que tanto para el movimiento de apertura como para el de cierre lo realizan mediante aire.
- Double effect ensures both opening and closing movement using air.

- Acabado de la superficie inferior del cuerpo (Ra 0,4-0.6 um) para reducir al mín. la fricción y maximizar la vida del actuador. Protección externa cuerpo: anodizado duro. 500 Hrs. Cámara Niebla salina según ASTM B117-73. Protección externa tapas: recubrimiento epoxy-poliester.
- Patines deslizantes, material de bajo cociente de fricción (LAT LUB) evitando contacto metal-metal, fácilmente reemplazable, para su mantenimiento con doble taladro inferior para el anclaje y centraje de la válvula según norma ISO 5211 y DIN 3337.
- Conexión inferior eje cuadrado hembra según ISO 5211/ DIN 3337 para el montaje a 45° o 90° indistintamente.
- Montaje directo electroválvula NORMA NAMUR. / Montaje accesorios según norma NAMUR VDI/DE 3845.
- Temperatura de trabajo -20°C a +80°C.
- Limitador de carrera a la apertura y al cierre; control de funcionamiento y estanqueidad 100% a través del sistema electrónico. Certificación individual.
- Finish of the body lower surface (Ra 0.4-0.6 um) to reduce at min. the friction and maximize the actuator life. Body external protection: strong anodized 500Hrs. Salt fog chamber according to ASTM B117 -73. Lid external protection: epoxy-polyester coating.
- Slipping skates, low friction quotient material (LAT LUB) avoiding metal-metal contact, easily replaceable, for its maintenance with lower double hole for anchoring and centering of the valve according to ISO 5211 and DIN 3337 standards.
- Lower connection with female square shape axis according to ISO 5211/DIN 3337 for 45° or 90° assembly, without distinction.
- Direct assembly of electrovalve NAMUR STANDARD / Fitting assembly according to NAMUR VDI/DE 3845.
- Working temperature from -20°C to +80°C.
- Motion limiter for opening and closing; Control of functioning and impermeability 100% through the electronic system. Individual certification.



VÁLVULAS DE MARIPOSA NETVITC SYSTEM®

NETVITC SYSTEM® BUTTERFLY VALVES

169

Válvula Netvitc System®



Netvitc System® Valve
Vanne Netvitc System®

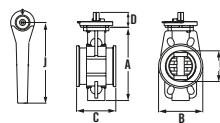

Ref.	€	Ø Tubo/Pipe	DN	Brida/Clamp	Peso/Wt (g)	Uds. Lote/Batch	A	B	C	D	J
9N001	145,61	63-75	65	75	1.820	4	189	126	86	45	235
• 9N002	160,83	90	80	90	2.137	4	213	130	97	45	235
• 9N003	176,93	110	100	110	2.634	4	233	152	98	45	235
• 9N004	202,96	125	110	125	2.895	4	244	170	108	45	270
• 9N005	209,11	140	125	140	3.270	4	264	187	110	45	270
• 9N006	241,26	160	150	160	4.624	4	286	214	121	45	270
• 9N007	351,62	200-225	200	200	7.336	1	360	271	138	45	270

• Modelo con junta Netvitc System® con alma de acero inox A-4. / Model with Netvitc System® joint with stainless steel A-4 inner.

171

Salida encolar



Solvent socket outlet
Sortie à collar

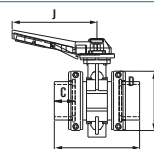

Ref.	€	Ø Tubo/Pipe	DN	Brida/Clamp	Peso/Wt (g)	Uds. Lote/Batch	A	B	C	D	J
9N020	161,43	63	65	75	2.136	2	138	218	42	235	235
9N021	161,43	75	65	75	2.116	2	138	192	44	235	235
• 9N022	222,11	90	80	90	3.376	2	164	219	52	235	235
• 9N023	253,72	110	100	110	4.196	2	188	244	61	235	235
• 9N024	302,96	125	110	125	5.451	2	203	282	70	270	270
• 9N025	332,10	140	125	140	6.493	2	224	298	78	270	270
• 9N026	440,47	160	150	160	8.591	2	251	315	86	270	270
• 9N027	596,48	200	200	200	13.395	1	297	390	106	270	270
• 9N028	596,48	225	200	200	14.106	1	297	476	120	270	270

Opción / optional "BS", "ANSI"

• Modelo con junta Netvitc System® con alma de acero inox A-4. / Model with Netvitc System® joint with stainless steel A-4 inner.

170

Salida PE/encolar



Thermo fusion outlet with flanges, solvent socket outlet
Thermofusion/sortie à collar PVC

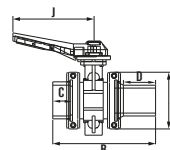

Ref.	€	Ø Tubo/Pipe	DN	Brida/Clamp	Peso/Wt (g)	Uds. Lote/Batch	A	B	C	D	J
9N060	200,42	63	65	75	2.472	2	138	288	42	64	235
9N061	200,42	75	65	75	2.201	2	138	270	44	91	235
• 9N062	255,82	90	80	90	3.813	2	164	310	52	100	235
• 9N063	301,12	110	100	110	4.388	2	188	321	61	102	235
• 9N064	362,45	125	110	125	5.715	2	203	373	70	135	270
• 9N065	397,59	140	125	140	6.783	2	224	383	78	125	270
• 9N066	527,48	160	150	160	8.738	2	251	398	86	122	270
• 9N067	673,82	200	200	200	13.813	1	297	471	106	132	270
• 9N068	673,82	225	200	200	14.606	1	297	515	120	143	270

Valona larga válida para soldadura a tope y electrofusión. / Long PE outlet for thermo and electro welding.

• Modelo con junta Netvitc System® con alma de acero inox A-4. / Model with Netvitc System® joint with stainless steel A-4 inner.

172
Salida PE/PE

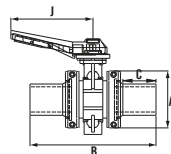
 Thermo fusion outlet
 Sortie à thermo fusion

Ref.	€	∅ Tubo/Pipe	DN	Brida/Clamp	Peso/Wt (g)	Uds. Lote/Batch	A	B	C	J
9N030	216,79	63	65	75	2.010	2	138	358	64	235
9N031	218,85	75	65	75	2.350	2	138	348	91	235
• 9N032	264,22	90	80	90	3.498	2	164	385	100	235
• 9N033	310,64	110	100	110	4.835	2	188	395	102	235
• 9N034	373,61	125	110	125	5.731	2	203	464	135	270
• 9N035	409,63	140	125	140	6.947	2	224	468	125	270
• 9N036	544,82	160	150	160	9.464	2	251	481	122	270
• 9N037	705,81	200	200	200	15.311	1	297	552	132	270
• 9N038	705,81	225	200	200	15.000	1	297	554	143	270

Valona larga válida para soldadura a tope y electrofusión. / Long PE outlet for thermo and electro welding.

- Modelo con junta Netvitc System® con alma de acero inox A-4. / Model with Netvitc System® joint with stainless steel A-4 inner.

683
Mixta acodada "AIR"

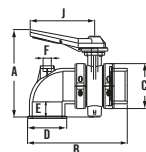
 "AIR" plain/threaded outlet
 Mixte sorties coudée "AIR"

Ref.	€	∅ Tubo/Pipe	DN	Brida/Clamp	Peso/Wt (g)	Uds. Lote/Batch	A	B	C	D	E	F	J
• 9N132	237,90	90	80	90	3.930	2	288	334	164	121	51	3/4"	230
• 9N133	270,36	110	100	110	5.060	2	308	376	188	144	61	1"	230
• 9N135	332,07	125	110	125	6.255	2	344	411	203	159	69	2"	270
• 9N140	468,70	160	150	160	10.344	1	386	498	251	201	86	2"	270
• 9N142	621,54	200	200	200	13.825	1	460	601	297	251	106	2"	270

Opción / optional "BS", "ANSI"

- Modelo con junta Netvitc System® con alma de acero inox A-4. / Model with Netvitc System® joint with stainless steel A-4 inner.

622
Válvula Netvitc System® acodada

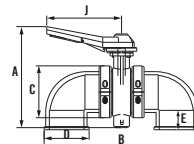
 Plain outlet
 Sortie coudée à coller

Ref.	€	∅ Tubo/Pipe	DN	Brida/Clamp	Peso/Wt (g)	Uds. Lote/Batch	A	B	C	D	E	J
• 9N102	240,76	90	80	90	4.482	2	288	433	164	121	51	230
• 9N103	282,11	110	100	110	5.839	2	308	505	188	144	61	230
• 9N104	354,17	125	110	125	7.157	2	344	540	203	159	69	270
• 9N105	385,24	140	140	140	9.947	1	356	595	200	176	75	270
• 9N106	512,18	160	150	160	11.737	1	386	683	251	201	86	270
• 9N107	670,49	200	200	200	16.344	1	460	816	297	251	106	270

- Modelo con junta Netvitc System® con alma de acero inox A-4. / Model with Netvitc System® joint with stainless steel A-4 inner.

VÁLVULAS DE MARIPOSA NETVITC SYSTEM® NETVITC SYSTEM® BUTTERFLY VALVES

173



Motor eléctrico salida encolar

Electrically operated
Moteur électrique/Sortie à collar

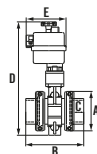

Ref.	€	∅ Tubo/Pipe	Motor/Actuator	DN	Brida/Clamp	Peso/Wt (g)	Uds. Lote/Batch	A	B	C	D	E
9N300	1.426,78	63	S35	65	75	4.272	1	138	218	42	449	177
9N301	1.437,03	75	S35	65	75	4.230	1	138	192	44	453	177
• 9N302	1.542,38	90	S55	80	90	6.118	1	164	235	52	477	177
• 9N303	1.556,18	110	S55	100	110	5.919	1	188	247	61	497	177
• 9N304	2.730,05	125	S85	110	125	10.293	1	203	282	70	563	177
• 9N305	2.742,78	140	S140	125	140	11.372	1	224	298	78	583	230
• 9N306	2.784,28	160	S140	150	160	13.111	1	251	315	86	605	230
• 9N307	2.991,42	200	S140	200	200	17.591	1	297	390	106	679	230
• 9N308	2.991,42	225	S140	200	200	18.968	1	297	476	120	679	230

• Modelo con junta Netvitic System® con alma de acero inox A-4. / Model with Netvitic System® joint with stainless steel A-4 inner.

175



Mano reductor salida encolar

Manually operated
Réducteur manuel

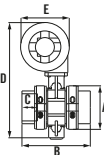

Ref.	€	∅ Tubo/Pipe	DN	Brida/Clamp	Peso/Wt (g)	Uds. Lote/Batch	A	B	C	D	E
9N330	475,73	63	65	75	4.222	1	138	218	42	362	172
9N331	487,95	75	65	75	4.222	1	138	192	44	362	172
• 9N332	522,28	90	80	90	5.086	1	164	235	52	386	172
• 9N333	539,66	110	100	110	5.869	1	188	247	61	406	172
• 9N334	557,12	125	110	125	6.843	1	203	282	70	417	172
• 9N335	570,99	140	125	140	7.922	1	224	298	78	488	250
• 9N336	612,79	160	150	160	9.661	1	251	315	86	510	250
• 9N337	1.077,94	200	200	200	12.294	1	297	390	106	584	250
• 9N338	1.077,94	225	200	200	13.314	1	297	476	120	584	250

• Modelo con junta Netvitic System® con alma de acero inox A-4. / Model with Netvitic System® joint with stainless steel A-4 inner.

174



Actuador neumático salida encolar simple efecto

Pneumatically operated, single acting
Pneumatique, simple effet

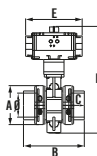

Ref.	€	∅ Tubo/Pipe	Motor/Actuator	DN	Brida/Clamp	Peso/Wt (g)	Uds. Lote/Batch	A	B	C	D	E
9N310	1.131,31	63	H075SE	65	75	5.412	1	138	218	42	376	205
9N311	1.143,22	75	H075SE	65	75	5.372	1	138	192	44	376	205
• 9N312	1.330,02	90	H075SE	80	90	6.236	1	164	235	52	400	205
• 9N313	1.399,65	110	H100SE	100	110	9.919	1	188	247	61	420	205
• 9N314	1.970,64	125	H100SE	110	125	10.893	1	203	282	70	431	205
• 9N315	1.998,49	140	H115SE	125	140	15.372	1	224	298	78	451	310
• 9N316	2.597,36	160	H115SE	150	160	17.111	1	251	315	86	473	310
• 9N317	2.839,32	200	H125SE	200	200	22.444	1	297	390	106	547	310
• 9N318	2.839,32	225	H125SE	200	200	23.464	1	297	476	120	547	310

• Modelo con junta Netvitic System® con alma de acero inox A-4. / Model with Netvitic System® joint with stainless steel A-4 inner.

176

Actuador neumático salida encolar doble efecto

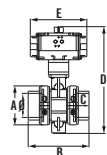
 Pneumatically operated, double acting
 Pneumatique, double effet

Ref.	€	∅ Tubo/Pipe	Motor/Actuator	DN	Brida/Clamp	Peso/Wt (g)	Uds. Lote/Batch	A	B	C	D	E
9N320	739,10	63	H075DE	65	75	5.372	1	138	218	42	376	205
9N321	749,25	75	H075DE	65	75	4.074	1	138	192	44	376	205
• 9N322	793,82	90	H075DE	80	90	6.309	1	164	235	52	400	205
• 9N323	814,71	110	H075DE	100	110	7.325	1	188	247	61	420	205
• 9N324	1.065,34	125	H075DE	110	125	8.225	1	203	282	70	431	205
• 9N325	1.093,26	140	H085DE	125	140	10.372	1	224	298	78	451	310
• 9N326	1.107,19	160	H085DE	150	160	12.755	1	251	315	86	473	310
• 9N327	1.466,25	200	H100DE	200	200	19.222	1	297	390	106	547	310
• 9N328	1.466,25	225	H100DE	200	200	17.364	1	297	476	120	547	310

• Modelo con junta Netvitc System® con alma de acero inox A-4. / Model with Netvitc System® joint with stainless steel A-4 inner.

177

Enlace brida válvula mariposa Netvitc System® S/E

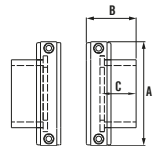
 Netvitc System® flange set, glued
 Union brides Netvitc System® à coller

Ref.	€	∅ Tubo/Pipe	DN	Brida/Clamp	Peso/Wt (g)	Uds. Lote/Batch	A	B	C
9N410	32,32	63	65	75	627	1	138	58	42
9N411	32,32	75	65	75	1.883	1	138	65	44
9N412	71,63	90	80	90	1.328	1	164	80	52
9N413	84,42	110	100	110	1.669	1	188	86	61
9N414	109,96	125	110	125	2.213	1	203	103	70
9N415	135,25	140	125	140	2.848	1	224	112	78
9N416	219,06	160	150	160	4.148	1	251	117	86
9N417	264,35	200	200	200	5.937	1	297	148	106
9N418	264,35	225	200	200	6.868	1	297	161	120

Sin junta. / Without O-Ring.

180

Conjunto brida y portabrida reducido S/E

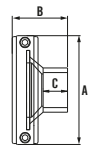
 Netvitc System® clamp and adaptor, glued reducer
 Union brides Netvitc System® réductrice à coller

Ref.	€	∅ Tubo/Pipe	DN	Brida/Clamp	Peso/Wt (g)	Uds. Lote/Batch	A	B	C
9N456	60,50	90	110	125	945	4	203	81	52
9N457	60,50	110	110	125	1.060	4	203	89	62
9N458	60,50	125	110	125	1.020	4	203	103	70
9N460	116,30	110	150	160	1.800	4	251	93	66
9N461	116,30	125	150	160	1.802	4	251	102	75
9N462	116,30	140	150	160	1.686	4	251	107	80
9N463	116,30	160	150	160	1.812	4	251	117	86
9N464	155,69	200	150	160	2.829	4	251	177	107

Sin junta. / Without o-ring.

VÁLVULAS DE MARIPOSA NETVITC SYSTEM® NETVITC SYSTEM® BUTTERFLY VALVES

181

Conjunto brida y portabrida reducido salida R/H



Netvitic System® clamp and adaptor female thread
Union brides Netvitic System® réduit sortie taraudée

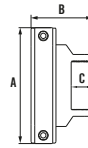

Ref.	€	∅ Tubo/Pipe	DN	Brida/Clamp	Peso/Wt (g)	Uds. Lote/Batch	A	B	C
9N486	64,75	2 1/2"	110	125	1.046	4	203	108	44
9N487	64,75	3"	110	125	982	4	203	108	51
9N488	64,75	4"	110	125	1.063	4	203	108	62

Sin junta. / Without o-ring.

637

Conjunto codo 90° Netvitic System®/brida



Assembly flange Netvitic System®, 90° elbow
Ensemble coude a 90° Netvitic System® /bride

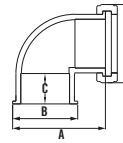

Ref.	€	∅ Tubo/Pipe	DN	Brida/Clamp	Peso/Wt (g)	Uds. Lote/Batch	A	B	C	D
9N400	37,26	90	80	90	1.118	4	159	121	51	164
9N401	55,03	110	100	110	1.611	4	195	144	61	188
9N403	71,16	125	110	125	2.052	4	210	159	69	203
9N404	93,19	140	140	140	3.238	2	242	177	76	224
9N405	133,20	160	150	160	3.725	2	275	201	86	251
9N406	189,57	200	200	200	7.045	2	333	251	106	297

Sin junta. / Without o-ring.

684

Conjunto codo 90° "AIR" Netvitic System®/brida



Assembly flange "AIR" Netvitic System®, 90° elbow
Ensemble coude "AIR" a 90° Netvitic System® /bride

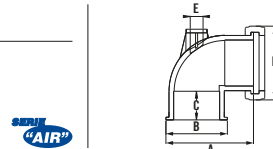

Ref.	€	∅ Tubo/Pipe	DN	Brida/Clamp	Peso/Wt (g)	Uds. Lote/Batch	A	B	C	D	E
9N421	41,79	90	80	90	1.140	4	159	121	51	164	3/4"
9N422	61,64	110	100	110	1.695	4	195	144	61	188	1"
9N423	76,65	125	110	125	2.182	4	210	159	69	203	2"
9N424	144,87	160	125	160	4.026	2	275	201	86	251	2"
9N425	194,04	200	150	200	5.977	2	333	251	106	297	2"

Sin junta. / Without o-ring.

814

Maneta gatillo



Catch handle
Poignée à détente

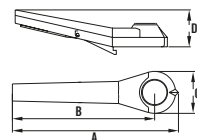

Ref.	€	∅ Tubo/Pipe	DN	Brida/Clamp	Peso/Wt (g)	Uds. Lote/Batch	A	B	C	D
09904	29,38	63-75	80	90	336	2	275	235	70	75
09905	29,49	90-110	100	110	347	2	275	235	70	75
09906	29,72	125-160	110	125	370	2	310	270	70	85
09907	41,59	200-225	125	160	554	2	310	270	74	85



REPARACIONES EN CARGA

LOAD REPAIRS



En este ejemplo podemos ver como gracias al Sistema Netvitc System®, se puede proceder a la reparación de una tubería dañada, para sustituirla estando la instalación en carga evitando todos los problemas existentes en una instalación tradicional.

In this example we can see how thanks to the Netvitc System®, a damaged pipe can be repaired and replaced with the load installation in operation, avoiding then all the relevant troubles in the traditional assembly.



1.

Se produce rotura de tubería en una instalación.
In case of broken pipe.



2.

En una instalación tradicional, deberíamos vaciar la tubería y desmontar la válvula.
In a traditional installation, pipe should be emptied and disassembled the valve.



4.

Una vez reparada y ensamblada la tubería, la instalación vuelve a funcionar correctamente.
As soon as the pipe has been repaired and assembled, the installation is working properly again.



3.

Gracias al sistema Netvitc System®, podemos proceder al desmontaje de la tubería dañada, para sustituirla, estando la instalación en carga.
Thanks to the Netvitc System®, we can disassemble the damaged pipe with the installation in charged.

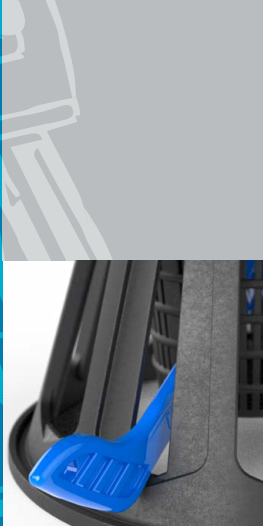

VÁLVULAS DE ASPIRACIÓN NETWELL®
NETWELL® FOOT VALVES



FAMILIA
14 FAMILY

VÁLVULAS DE ASPIRACIÓN NETWELL®

NETWELL® FOOT VALVES

SNS
Netvic System

UNICO
en el mercado



CARACTERÍSTICAS // FEATURES

La nueva y mejorada válvula de aspiración Netwell® sistema de pie, está pensada para estar colocada en el fondo del depósito, pozo o balsa de riego **incorporando un nuevo brazo descarga más ergonómico que facilita las operaciones de mantenimiento y un asidero creado para enlazarlo con una boya y facilitar su manipulación.** El uso del SNS® en sus conexiones permite que las operaciones de mantenimiento sean más rápidas. Por otro lado la válvula de flotación está ideada para trabajar cerca de la superficie y gracias al nuevo diseño de su cesta, maximiza el caudal de aspiración y reduce la pérdida de carga.

El sistema de clapeta abatible permite un elevado paso de agua, baja pérdida de carga y una perfecta estanqueidad a baja presión, garantizada con presiones superiores a 0.1 bar. **El uso de un muelle doble de acero Springflex aporta una gran durabilidad.**

The new and improved Netwell® foot valve is designed to be placed at the bottom of a tank, well or irrigation pool. **Incorporating a much more ergonomic discharge arm that eases maintenance work and a handle created to connect it with a buoy and facilitate its handling.** Using SNS® in your connections allows for faster maintenance operations. On the other hand, the float valve is designed to work close to the surface. Thanks to its design, it maximizes the suction flow and reduces pressure loss.

The folding flap system allows a high-water flow, low pressure drop and perfect tightness at low pressure, guaranteed with pressures higher than 0.1 bar. **The use of a double Springflex steel spring provides great durability.**

COMPONENTES SISTEMA DE PIE // FOOT SYSTEM COMPONENTS

1. Refuerzo boca Inox A-2
2. Nervaduras de seguridad, sujeción y apriete
3. Cuerpo PPFV
4. Clapeta PA
5. Muelle doble springflex
6. Cuerpo asiento clapeta PA
7. Junta tórica EPDM
8. Tornillo Inox A-2
9. Cesta/filtro contra áridos y algas PP
10. Rejilla soporte y protección algas PP
11. Base reforzada de apoyo y protección
12. Palanca descarga apertura manual PP
13. Brida Netvic System® abisagrada PA
14. Junta de cierre estanqueidad EPDM
15. Tornillo clapeta Inox A-2
16. Asidero

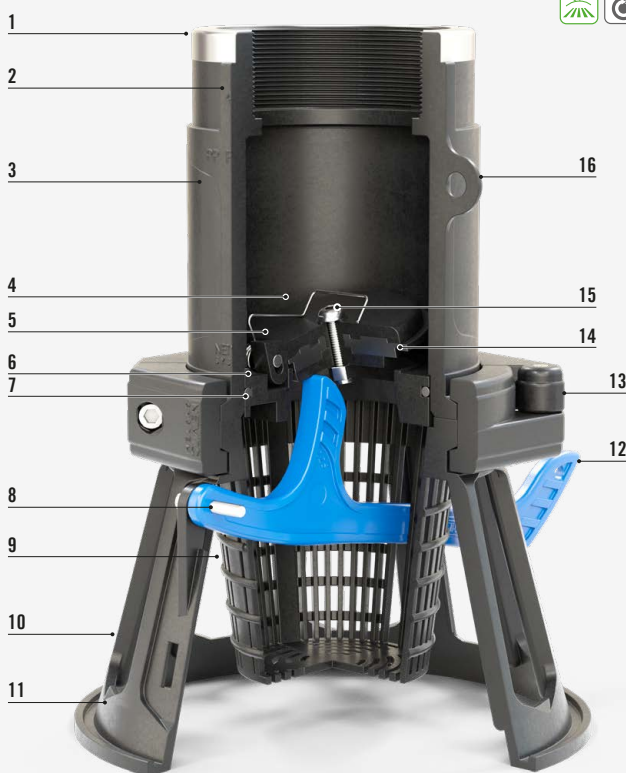

1. SS A-2 reinforcement
2. Security nerver for tightening
3. GRPP body
4. PA closing flap
5. Springflex double spring
6. Basket / filter against arid and seaweed
7. EPDM o-ring
8. Stainless steel A-2 bolt
9. PP basket filter against dirtiness
10. PP Support and protection grid seaweed
11. Reinforced base
12. Manual discharge handle
13. PA Netvic System® hinged flange
14. EPDM closing gasket
15. Closing disc bolt SS A-2
16. Handle

SECTOR	Agricultura y tratamientos de aguas / <i>Agriculture and water treatments</i>
MATERIAL	PPFV / GRPP
MAT. JUNTA / CLOSING SEAL	EPDM
TORNILLERÍA / BOLTS	Inox A-2 / A-4
SISTEMAS / SYSTEMS	Pie y flotante / <i>Foot and floating</i>
PRESIÓN CIERRE / CLOSING PRESSURE	0.1 bar
PN	PN 10
MEDIDAS / MEASURES	Pie desde Ø90-225. Flotante desde Ø40-225 / <i>Foot from Ø90-225. Floating from Ø40-225</i>



COMPONENTES SISTEMA FLOTACIÓN // FLOATING SYSTEM COMPONENTS

1. Refuerzo boca Inox A-2
2. Nervaduras de seguridad, sujeción y apriete
3. Asidero
4. Cuerpo central PPFV
5. Tapa superior clapeta PA
6. Junta clapeta EPDM
7. Soporte clapeta PPFV
8. Cesta protección PPFV
9. Brida Netvitc System® abisagrada PA
10. Tornillo sujeción Inox A-2
11. Tapa inferior clapeta PA
12. Eje clapeta Inox A-2
13. Muelle doble Inox Springflex

1. SS A-2 reinforcement
2. Security nerver for tightening
3. Handle
4. GRPP body
5. PA flap upper lid
6. EPDM flap gasket
7. GRPP flap support
8. GRPP protection basket
9. PA Netvitc System® hinged flange
10. Stainless steel fastening screw A-2
11. PA flap bottom cover
12. Stainless steel clamp shaft A-2
13. Inox Springflex double spring

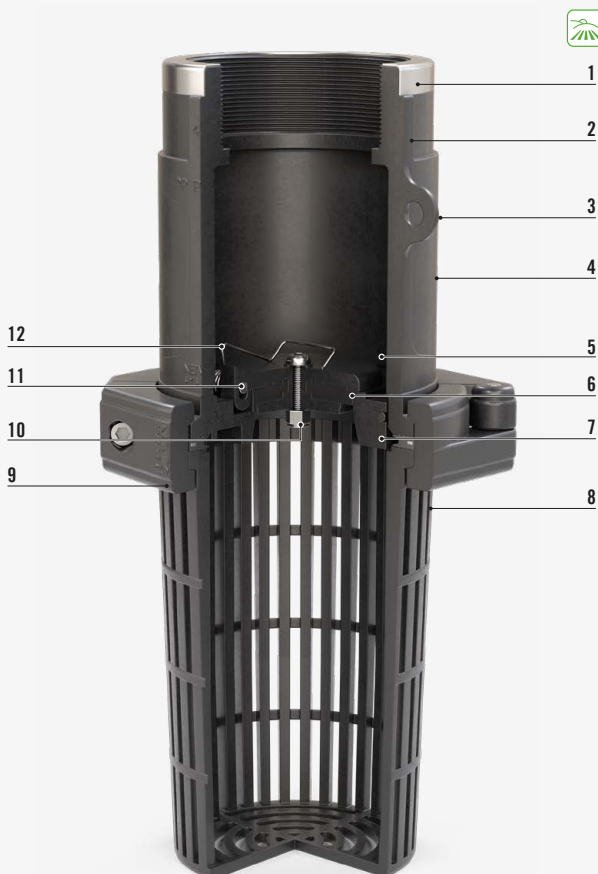

Diámetro equivalente cesta		
Diámetro nominal cuerpo válvula	A _{peso} (cm ²)	Ø _{eq} (mm)
110	400	226
150	725	304
200	460	242



Para recomendaciones de uso y apriete del tornillo, ver pg. 05.
For recommendations for use and tightening of the bolt, see pg. 05.

VÁLVULAS DE ASPIRACIÓN NETWELL®

NETWELL® FOOT VALVES

SISTEMA DE PIE // FOOT SYSTEM

956

Descarga espiga



Delivery with spigot connection
Evacuateur cannelé fileté

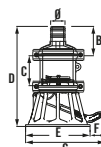

Ref.	€	∅ Tubo/Pipe	Brida/Clamp	DN cuerpo/body	Peso/Wt (g)	Uds. Lote/Batch	B	C	D	E	F	G
14073	222,47	2"	125	110	2.956	1	112	122	403	259	53	311
14075	222,47	3"	125	110	3.041	1	134	122	425	259	53	311

291

Descarga con salida encolar



Delivery with solvent socket outlet
Evacuateur à sortie à coller

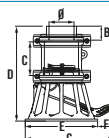

Ref.	€	∅ Tubo/Pipe	Brida/Clamp	DN cuerpo/body	Peso/Wt (g)	Uds. Lote/Batch	B	C	D	E	F	G
14207	152,05	90	125	110	3.167	1	58	122	349	259	53	311
14208	172,74	110	125	110	3.197	1	67	122	357	259	53	311
14235	202,01	125	125	110	3.257	1	79	122	371	259	53	311
14220	362,14	110	160	150	5.277	1	70	137	356	280	74	354
14209	382,38	125	160	150	5.277	1	80	137	365	280	74	354
14210	402,89	140	160	150	5.282	1	87	137	370	280	74	354
14211	445,87	160	160	150	5.457	1	94	137	380	280	74	354
● 14213	550,20	200	200	200	10.137	1	118	210	644	360	60	420
● 14214	554,75	225	200	200	10.942	1	161	210	687	360	60	420

Opción en "BS", "ASTM" / "BS" optional.

290

Descarga con salida R/Hembra



Delivery with thread female outlet
Evacuateur à sortie à taraudée

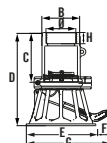

Ref.	€	∅ Tubo/Pipe	Brida/Clamp	DN cuerpo/body	Peso/Wt (g)	Uds. Lote/Batch	B	C	D	E	F	G	H
● 14005	127,30	2"	125	110	2.304	1	143	184	352	259	53	329	38
● 14006	127,30	2 1/2"	125	110	2.382	1	143	184	352	259	53	329	30
● 14007	132,18	3"	125	110	2.382	1	143	184	352	259	53	329	36
● 14008	150,24	4"	125	110	2.444	1	143	184	352	259	53	329	41

● Brida Netvitc System® abisagrada. / Netvitc System® hinged flange.

293

Descarga con salida PE



Delivery with PE outlet
Evacuateur à sortie PE

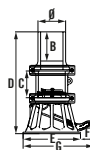

Ref.	€	∅ Tubo/Pipe	Brida/Clamp	DN cuerpo/body	Peso/Wt (g)	Uds. Lote/Batch	B	C	D	E	F	G
14055	195,91	90	125	110	3.269	1	81	122	430	259	53	311
14056	219,44	110	125	110	3.565	1	90	122	476	259	53	311
14057	245,18	125	125	110	3.517	1	108	122	434	259	53	311
14058	405,05	140	160	150	5.400	1	98	137	480	280	74	354
14059	506,33	160	160	150	5.775	1	108	137	459	280	74	354
• 14060	616,36	200	200	200	10.353	1	130	210	695	360	60	420
• 14061	623,56	225	200	200	10.823	1	161	210	720	360	60	420

Valona larga válida para soldadura a tope y electrofusión. / Long PE outlet for thermo and electro welding.

603

Descarga con salida bridas



Delivery with flange outlet
Evacuateur à sortie bridas



Ref.	€	∅ Tubo/Pipe	Brida/Clamp	DN cuerpo/body	Peso/Wt (g)	Uds. Lote/Batch	C	D	E	F	G	K
14249	217,23	125	125	110	4.187	1	122	377	259	53	311	190
14250	217,23	125-140	125	110	4.242	1	122	377	259	53	311	210-216
14252	462,65	160	160	150	6.827	1	137	387	280	74	354	235-241

Normativa bridas: DIN 2576, UNE-EN 1452 (PVC-U), ANSI 16.5, BS 10 tabla D/E.

K= Distancia entre tornillos (mm). / Distance between bolts (mm).

292

Descarga con salida Netvitc® sistema ranurado



Delivery with Netvitc® outlet grooved system
Evacuateur à sortie Netvitc® système rainuré

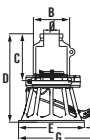

Ref.	€	∅ Tubo/Pipe	Brida/Clamp	DN cuerpo/body	Peso/Wt (g)	Uds. Lote/Batch	B	C	D	E	F	G
• 14045	134,92	2"	125	115	2.354	1	143	184	352	259	53	329
• 14047	134,92	3"	125	110	2.463	1	143	184	352	259	53	329
• 14048	152,94	4"	125	110	2.294	1	143	184	352	259	53	329

Conexión sistema ranurado. / Grooved system connection.

VÁLVULAS DE ASPIRACIÓN NETWELL®

NETWELL® FOOT VALVES

SISTEMA DE FLOTACIÓN // FLOATING SYSTEM

957

Descarga espiga



Delivery with spigot connection
Evacuateur cannelé fileté

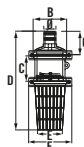

Ref.	€	∅ Tubo/Pipe	Brida/Clamp	DN cuerpo/body	Peso/Wt (g)	Uds. Lote/Batch	B	C	D	E	F	G
14173	222,47	2"	125	110	2.288	1	160	122	472	118	203	112
14175	222,47	3"	125	110	2.289	1	160	122	494	118	203	134

295

Salida encolar



Floating with solvent socket outlet
Flotteur à sortie à collar

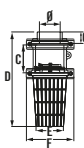

Ref.	€	∅ Tubo/Pipe	Brida/Clamp	DN cuerpo/body	Peso/Wt (g)	Uds. Lote/Batch	C	D	E	F	G
14303	59,88	40	63	50	773	4	70	186	37	125	28
14304	62,26	50	63	50	764	4	70	189	37	125	31
14305	66,64	63	63	50	712	4	70	199	37	125	41
14306	83,79	75	63	50	835	4	70	200	37	125	42
14307	152,05	90	125	110	3.050	1	122	419	118	203	51
14308	172,74	110	125	110	2.785	1	122	427	118	203	60
14335	202,01	125	125	110	2.805	1	122	441	118	203	69
14320	362,14	110	160	150	4.675	1	138	527	152	251	60
14309	382,38	125	160	150	4.917	1	138	536	152	251	69
14310	402,89	140	160	150	3.097	1	138	541	152	251	76
14311	445,87	160	160	150	5.187	1	138	551	152	251	86
● 14313	550,20	200	200	200	8.733	1	210	534	160	297	106
● 14314	554,75	225	200	200	9.540	1	210	577	160	297	120

Opción en "BS", "ASTM" / "BS" optional.

294

Salida R/Hembra



Floating threaded female outlet
Flotteur sortie à taraudée

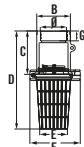

Ref.	€	∅ Tubo/Pipe	Brida/Clamp	DN cuerpo/body	Peso/Wt (g)	Uds. Lote/Batch	B	C	D	E	F	G
● 14105	127,30	2"	125	110	2.288	1	143	184	432	118	203	38
● 14106	127,30	2 1/2"	125	110	2.268	1	143	184	432	118	203	30
● 14107	132,18	3"	125	110	2.289	1	143	184	432	118	203	36
● 14108	150,24	4"	125	110	2.319	1	143	184	432	118	203	41

● Brida Netvitec System® abisagrada. / Netvitec System® hinged flange.

Las válvulas de sistema flotante en las medidas ∅40, 50 y 63 se sirven con cesta roja. / Floating system valves in sizes ∅40, 50 and 63 are available with red screen.

297**Salida PE**

Floating with PE outlet
Flotteur sortie à PE

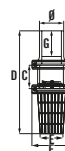

Ref.	€	∅ Tubo/Pipe	Brida/Clamp	DN cuerpo/body	Peso/Wt (g)	Uds. Lote/Batch	C	D	E	F	G
14153	88,36	50	63	50	760	4	70	209	37	125	55
14154	92,79	63	63	50	780	4	70	248	37	125	88
14155	195,91	90	125	110	3.504	1	122	500	118	203	81
14156	219,44	110	125	110	3.680	1	122	546	118	203	90
14157	245,18	125	125	110	3.027	1	122	504	118	203	108
14158	405,05	140	160	150	5.030	1	138	651	152	251	98
14159	506,33	160	160	150	5.556	1	138	630	152	251	108
• 14160	616,36	200	200	200	9.668	1	210	585	160	297	130
• 14161	623,56	225	200	200	10.268	1	210	610	160	297	161

Valona larga válida para soldadura a tope y electrofusión. / Long PE outlet for thermo and electro welding.

604**Salida con bridas**

Floating with flange outlet
Flotteur à sortie brides

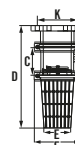

Ref.	€	∅ Tubo/Pipe	Brida/Clamp	DN cuerpo/body	Peso/Wt (g)	Uds. Lote/Batch	C	D	E	F	K
14349	214,20	125	125	110	3.572	1	122	448	118	203	190
14350	214,20	125-140	125	110	3.907	1	122	448	118	203	210-216
14352	462,90	160	160	150	6.487	1	137	552	152	251	235-241

Normativa bridas: DIN 2576, UNE-EN 1452 (PVC-U), ANSI 16.5, BS 10 tabla D/E.

K= Distancia entre tornillos (mm). / Distance between bolts (mm).

296**Salida Netvitc® sistema ranurado**

Floating with Netvitc® outlet grooved system
Flotteur sortie Netvitc® système rainuré

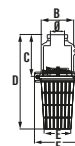

Ref.	€	∅ Tubo/Pipe	Brida/Clamp	DN cuerpo/body	Peso/Wt (g)	Uds. Lote/Batch	B	C	D	E	F
• 14145	134,92	2"	125	110	2.471	1	143	184	432	118	203
• 14147	134,92	3"	125	110	2.185	1	143	184	432	118	203
• 14148	152,94	4"	125	110	2.133	1	143	184	432	118	203

Conexión sistema ranurado. / Grooved system connection.

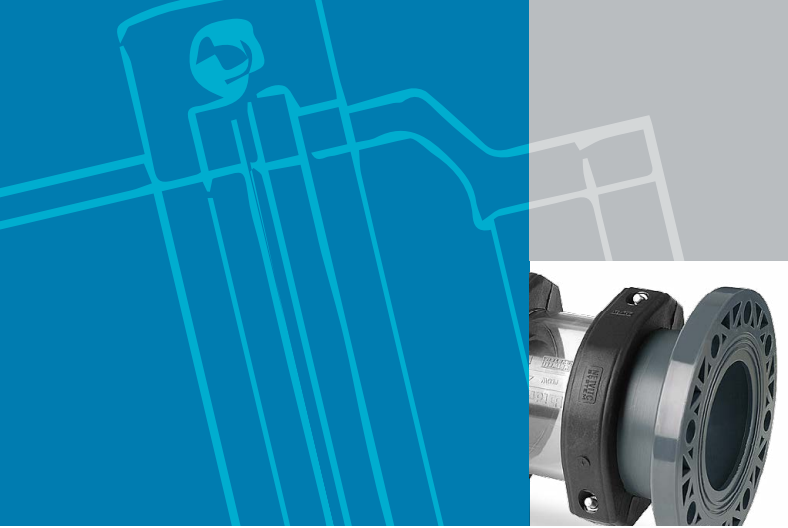

VÁLV. RETENCIÓN LINEAL SNS®
SNS® LINEAL CHECK VALVES



FAMILIA
15 FAMILY

VÁLVULAS DE RETENCIÓN LINEAL NETVITC SYSTEM®

NETVITC SYSTEM® LINEAL CHECK VALVES



CARACTERÍSTICAS // FEATURES

La válvula de retención lineal Netvitic System® ofrece una solución única en sus instalaciones, evitando los contraflujos indeseados y aportando gran protección frente a fenómenos de golpe de ariete, todo ello con una **mínima pérdida de carga y una estanqueidad** garantizada con presión 1 mca.

La gama consta de dos posibles materiales para el cuerpo, el estándar en PPFV y el modelo visor en policarbonato, que añade a las características de la válvula la función de visor, aportando un **enorme valor añadido en instalaciones** como las de piscina o tratamiento de agua.

Las válvulas de retención lineal Netvitic System®, gracias a su exclusivo cuerpo central con conexiones SNS®, permite una **gran diversidad de combinaciones en sus salidas**.

The Netvitic System® lineal check valve offers a unique solution in its installations, avoiding undesired counterflows and providing a great protection against water hammering, and all this with a **minimum loss of charge and guaranteed water tightness** with 1mwp pressure.

The range offers two possible body materials, the standard in GRPP and the polycarbonate fluid display which adds to the valve characteristics a fluid display function, providing a **high added value in installations** such as swimming-pool or water treatment.

The Netvitic System® lineal check valve provides a **great diversity of outlet combinations** due to its exclusive central body with SNS® unions.

COMPONENTES // COMPONENTS

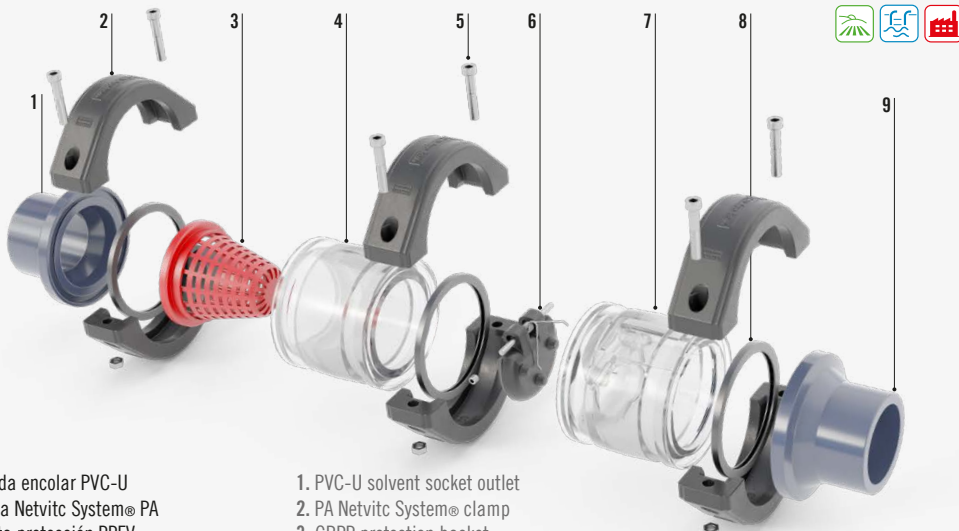

1. Salida encolar PVC-U
2. Brida Netvitic System® PA
3. Cesta protección PPFV
4. Cuerpo visor transparente PC
5. Tornillo Inox A-4
6. Clapeta PA
7. Cuerpo visor transparente PC
8. Junta Netvitic System® EPDM/Inox A-4
9. Salida encolar PVC-U

1. PVC-U solvent socket outlet
2. PA Netvitic System® clamp
3. GRPP protection basket
4. PC transparent body
5. Stainless steel screw A-4
6. PA closing flap
7. PC transparent body
8. EPDM/Inox A-4 Netvitic System® gasket
9. PVC-U solvent socket outlet

SECTOR	Riego, piscina y tratamiento de aguas / <i>Irrigation, swimming pool and water treatments</i>
MATERIAL	PPFV y serie visor en PP / <i>GRPP and display series in PP</i>
MAT. JUNTA / CLOSING SEAL	EPDM
MUELLE	Ø40 a 75 acero inoxidable A-2. Ø90-225 Springflex / <i>Ø40 to 75 stainless steel A-2. Ø90-225 Springflex</i>
MODELOS / MODELS	Retención lineal y retención lineal visor / <i>Lineal check valve and lineal check valve with transparent body</i>
MONTAJE / ASSEMBLY	Se pueden usar en vertical u horizontal / <i>May be used either vertically and horizontal</i>
PN	PN 10
MEDIDAS / MEASURES	Desde Ø40 a 225 / <i>From Ø40 to 225</i>

MONTAJE VÁLVULA RETENCIÓN LINEAL SNS® // ASSEMBLY SNS® LINEAL CHECK VALVE

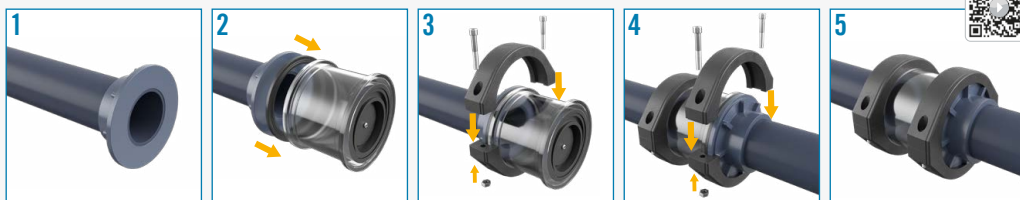

1. Encolar el adaptador.
2. Situar la junta y el cuerpo frente al portabridas, haciendo coincidir el cuerpo y la guía de apoyo, siempre en la dirección del flujo.
3. Colocar la brida y la fijamos con su tornillería.
4. Repetir la operación en la otra parte de la válvula.
5. Válvula instalada en línea lista para su funcionamiento.

INSTALACIÓN VÁLV. RETENCIÓN LINEAL SNS® // INSTALLATION SNS® LINEAL CHECK VALVE

En la imagen vemos una válvula de retención lineal visor Netvitc System®. Podemos apreciar el cuerpo transparente que permite la visión perfecta del fluido, además el uso del Netvitc System® aporta modularidad, permitiendo un montaje rápido y su uso con distintos materiales simplemente cambiando la salida. // In the image we can see a Netvitc System® lineal check valve. We can appreciate the transparent body that allows the perfect vision of the fluid, in addition the use of the Netvitc System® brings modularity, allowing a fast assembly and its use with different materials simply changing the outlet.

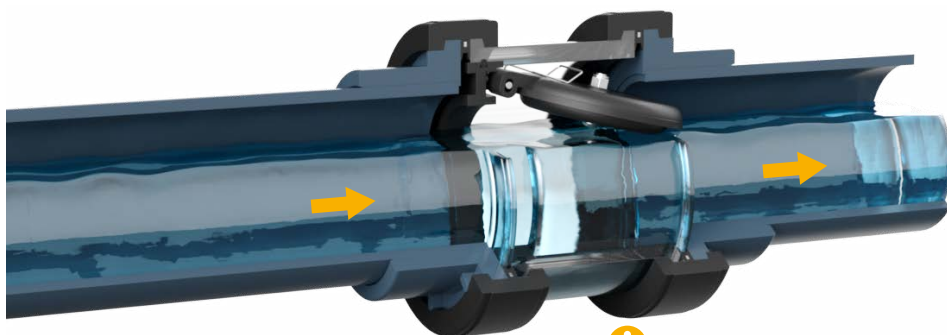

Para recomendaciones de uso y apriete del tornillo, ver pg. 05.
For recommendations for use and tightening of the bolt, see pg. 05.

VÁLVULAS DE RETENCIÓN LINEAL NETVITC SYSTEM®

NETVITC SYSTEM® LINEAL CHECK VALVES

300

305

Salida encolar

Solvent socket outlet
Sortie à coller

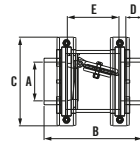

Ref.	Peso/Wt (g)	€	Ref.	Peso/Wt (g)	€	β Tubo/Pipe	Brida/Clamp	DN cuerpo/body	Uds. Lote/Batch	B	C	D	E
15010	775	44,32	15310	835	53,17	40	63	50	4	182	134	28	76
15011	818	48,65	15311	896	58,40	50	63	50	4	184	134	31	76
15012	774	57,38	15312	847	68,90	63	63	50	4	158	134	36	76
15013	958	70,50	15313	1.028	83,32	75	63	50	4	208	134	39	76
15020	3.053	165,55	15320	3.210	198,70	90	125	110	1	248	215	52	120
15021	3.175	185,07	15321	3.347	222,15	110	125	110	1	266	215	62	120
15032	3.270	222,74	15322	3.467	267,21	125	125	110	1	290	215	69	120
15031	5.364	268,78	15323	5.695	322,59	110	160	150	1	293	264	61	139
15022	5.485	389,74	15324	5.785	467,65	125	160	150	1	313	264	69	139
15023	5.712	410,63	15325	5.919	492,71	140	160	150	1	327	264	78	139
15024	5.962	454,44	15326	6.252	545,29	160	160	150	1	341	264	86	139
●15026	9.780	570,03	15328	10.348	662,67	200	200	200	1	468	315	107	216
●15027	11.385	574,61	15329	11.951	667,24	225	200	200	1	554	315	120	216

Opción en "BS", "ASTM" / "BS" optional

298

302

Salida R/Hembra

Threaded female outlet
Sortie à taraudée

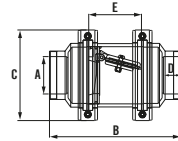

Ref.	Peso/Wt (g)	€	Ref.	Peso/Wt (g)	€	β Tubo/Pipe	Brida/Clamp	DN cuerpo/body	Uds. Lote/Batch	B	C	D	E
15067	795	63,08	15367	760	76,06	2"	63	50	1	184	134	38	76
15069	3.098	133,03	15369	3.098	161,76	2"	125	110	1	292	215	38	120
15059	3.254	137,53	15359	2.960	165,01	2 1/2"	125	110	1	292	215	30	120
15060	2.890	148,97	15360	3.201	178,75	3"	125	110	1	292	215	34	120
15061	3.120	166,61	15361	3.185	199,94	4"	125	110	1	292	215	44	120

Reforzado. / Reinforced.

299

303

Salida PE-PE

Thermo fusion outlet
Sortie thermofusion

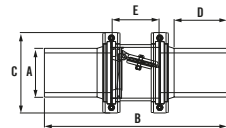

Ref.	Peso/Wt (g)	€	Ref.	Peso/Wt (g)	€	β Tubo/Pipe	Brida/Clamp	DN cuerpo/body	Uds. Lote/Batch	B	C	D	E
15052	899	64,75	15352	950	78,92	50	63	50	2	318	134	56	76
15053	926	64,75	15353	982	78,92	63	63	50	2	308	134	89	76
15055	3.012	201,28	15355	3.441	241,58	90	125	110	1	402	215	100	120
15056	3.190	222,15	15356	3.669	266,56	110	125	110	1	404	215	101	120
15057	5.712	251,75	15357	5.990	308,74	125	125	110	1	466	215	135	120
15058	6.454	453,49	15358	6.732	553,08	140	160	150	1	517	264	98	139
15062	6.823	501,67	15362	7.015	612,32	160	160	150	1	483	264	122	139
●15063	8.845	662,67	15363	9.075	755,31	200	200	200	1	620	315	132	216
●15064	9.905	669,87	15364	10.135	762,51	225	200	200	1	622	315	143	216

Valona larga válida para soldadura a tope y electrofusión. / Long PE outlet for thermo and electro welding.

● Brida Netvitc System® abisagrada. / Netvitc System® hinged flange.

949
Screen Plus

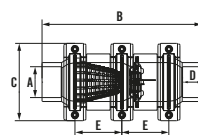
 Screen Plus
 Screen Plus

Ref.	€	∅ Tubo/Pipe	Brida/Clamp	DN cuerpo/body	Peso/Wt (g)	Uds. Lote/Batch	B	C	D	E
15710	106,58	40	63	50	1.436	2	260	134	28	76
15711	106,58	50	63	50	1.975	2	260	134	31	76
15712	106,58	63	63	50	1.280	2	240	134	36	76
15713	107,64	75	63	50	1.424	2	240	134	39	76

Opción en "BS", "ASTM" / "BS" optional

FILTRO SCREEN PLASTIC

El filtro Screen Plastic aporta una utilidad extra a los visores con la inclusión de un **medio filtrante**, siendo una nueva opción para **proteger los sistemas hidráulicos** de los sólidos que puede arrastrar el fluido. Ver pg. 59.

The Screen Plastic filter adds a new utility to the sight glasses with the inclusion of a **filter medium**, offering a **new option to protect the hydraulic systems** from solids that can be carried by the fluid. See pg. 59.



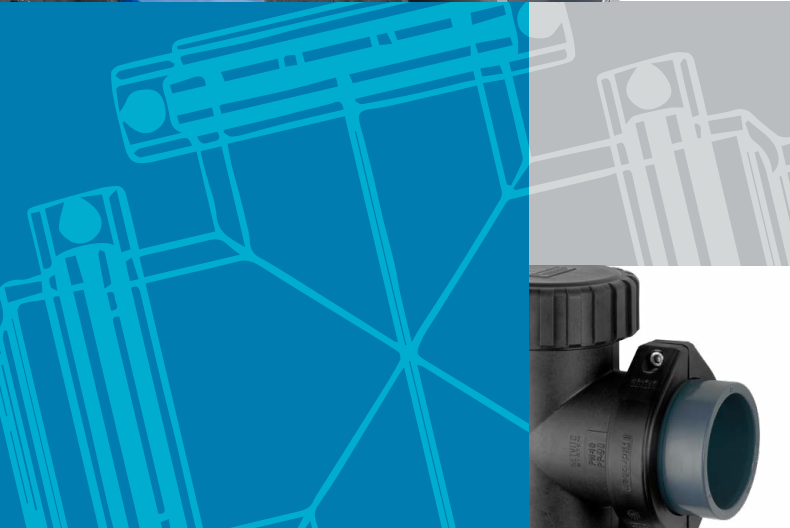



FILTROS NETVITC SYSTEM®
NETVITC SYSTEM® FILTERS

FAMILIA
08N FAMILY



CARACTERÍSTICAS // FEATURES

El filtro “SCREEN” es un elemento que **aporta la protección necesaria en instalaciones** de cualquier tipo, puesto que retiene los sólidos que pueda arrastrar el agua y que podrían dañar otros elementos, tales como contadores, sondas, válvulas, etc.

El medio filtrante es una malla integrada en una estructura plástica, que **aporta mayor agilidad en la limpieza del cartucho** así como un grado de filtración totalmente estable y homogéneo. Ésta podrá variar su micraje en función del tamaño de partículas a retener. El diseño de la junta permite un **fácil montaje** y ofrece una perfecta estanqueidad a baja presión.

Dentro de la gama disponemos de un nuevo modelo, el filtro **Screen Plastic**, diseñado específicamente para ser un prefiltro en línea. Con este modelo, añadimos una **nueva utilidad a los visores con la inclusión de un medio filtrante**, una malla totalmente inyectada en plástico la cual asegura una **protección eficaz frente a sólidos de gran tamaño** en instalaciones como por ejemplo las piscinas, que están muy expuestas a entrada de sólidos en el circuito hidráulico.

The “SCREEN” filter provides the necessary protection in any kind of installation, as it eliminates any solid which may be dragged by water and which may damage other elements such as meters, probes, valves, etc.

The filtering media, a mesh integrated in a plastic structure, provides a greater agility in the cleaning of the cartridge as well as a totally stable and homogeneous filtering level. Its micronage may vary as to the size of the particles to be kept. The joint design makes assembling easier and offers perfect water tightness at a low pressure.

Within the range we have a new model, the **Screen Plastic** filter, specifically designed to be an in-line pre-filter. With this model, we add a new utility to the viewers with the inclusion of a filtering medium, a mesh totally injected in plastic which ensures effective protection against large solids in facilities such as swimming pools, which are highly exposed to the entry of solids in the hydraulic circuit.

COMPONENTES // COMPONENTS



1. Tornillo acero Inox A-2
2. Brida Netvitic System® PA
3. Cesta cartucho PP con malla acero Inox A-2
4. Cuerpo visor SNS® PC
5. Junta Netvitic System® EPDM/Inox A4
6. Tuerca Inox A-4
7. Conexión encolar PVC-U Netvitic System®

1. Screw stainless steel A-2
2. PA Netvitic System® clamp
3. PP cartridge basket with stainless steel net
4. PC main body viewer Netvitic System®
5. EPDM/Inox A4 Netvitic System® gasket
6. Stainless steel A-4 nut
7. PVC-U connection solvent socket Netvitic System®



Para recomendaciones de uso y apriete del tornillo, ver pg. 05.
For recommendations for use and tightening of the bolt, see pg. 05.

SECTOR	Agricultura, piscina e industria / Agriculture, swimming pool and industry
MATERIAL	Policarbonato / Polycarbonate
MAT. MALLA / NET	Ø90-200 Acero Inox A-2. Ø40-75 PP / Ø90-200 Stainless steel A-2. Ø40-75 PP
PN	PN 10
MEDIDAS / MEASURES	Desde Ø40-200 / From Ø40-200

EJEMPLO DE APLICACIÓN FILTRO SCREEN // APPLICATION EXAMPLE SCREEN FILTER

A continuación apreciamos la aplicación del **modelo SCREEN** como filtro de seguridad después de la filtración principal. La malla de acero inoxidable del **filtro SCREEN** protegerá la instalación frente a cualquier problema que se pudiese dar en el equipo de filtración, evitando que la suciedad entre en el resto del sistema y los daños que estos pudiesen ocasionar.

Below we appreciate the application of the **SCREEN model** as a security filter after the main filtration. The stainless steel net of the **SCREEN filter** will protect the installation against any problem in the filtration equipment, avoiding the dirtiness to enter in the system and the damages that it may cause.



El detalle muestra como el cartucho retiene en su interior la suciedad gracias a su malla de acero inoxidable.

The detail shows how the cartridge retains the dirtiness thanks to its stainless steel net.

EJEMPLO DE APLICACIÓN FILTRO SCREEN PLASTIC // APPLICATION EXAMPLE SCREEN PLASTIC FILTER

En la imagen podemos ver el filtro modelo **SCREEN PLASTIC** como prefiltro en la aspiración de una bomba de instalación de filtrado de una piscina doméstica. La malla filtrante protege la instalación frente sólidos de gran tamaño; al estar fabricada en PP ofrece una resistencia óptima frente al cloro o el agua salada, que son los productos químicos más habituales en el tratamiento de agua en piscinas.

In the image we can see the filter model **SCREEN PLASTIC** as a pre-filter in the suction of a pump installation of a domestic swimming pool. The filtering mesh protects the installation against big size solids; as it is made of PP it offers an optimal resistance against chlorine or salt water, which are the most common chemical products in swimming pool water treatment.

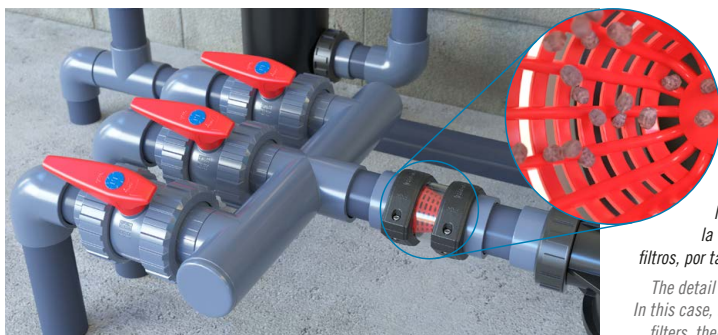

El detalle muestra como retiene en su interior la suciedad gracias a su malla de PP. En este caso, la función que se busca es la protección de bombas y filtros, por tanto las partículas retenidas son mayores de 4mm.

The detail shows how it retains dirt inside using its PP mesh. In this case, the function sought is the protection of pumps and filters, therefore the particles retained are greater than 4mm.

CARACTERÍSTICAS // FEATURES

Los filtros cazapiedras Hidroten, son la opción perfecta por su resistencia a la corrosión, ligereza y comodidad en las operaciones de limpieza y mantenimiento. Disponemos de dos modelos, "STONE" y **vertical**, que **ofrecen una perfecta protección** de los elementos de su instalación frente a los sólidos que pueda arrastrar el fluido. El modelo "STONE" está diseñado para trabajar en horizontal, mientras que el modelo vertical, posee una configuración que lo hace único para trabajar en vertical.

Gracias al sistema Netvitic System® y su versatilidad, se adaptan a cualquier instalación. La inclusión de la **nueva tapa NuTen**, hace que las **operaciones de limpieza resulten más rápidas y sencillas**.

The Hidroten strainer filters are the perfect option due to their corrosion resistance, lightness and convenience in cleaning and maintenance works. We have two models, "STONE" and **vertical**, that **offer a perfect protection** to the elements of the installation against the solids which may be dragged in the fluid. The "STONE" model has been designed to work horizontally, while the vertical model, has a configuration that makes it unique for work vertically.

Thanks to its Netvitic System® and its versatility, they can be adapted to any installation. The inclusion of the **new NuTen cap**, cover makes cleaning tasks are faster and easier.

COMPONENTES // COMPONENTS

- 1. Conexión encolar PVC-U SNS®
- 2. Junta Netvitic System® Inox A-4
- 3. Brida Netvitic System® PA
- 4. Tapa Nuten PA
- 5. Malla PPFV
- 6. Junta Netvitic System® EPDM
- 7. Tornillo Inox A-2
- 8. Cuerpo inferior PPFV o Policarbonato
- 9. Cuerpo central PPFV

- 1. Connection solvent socket SNS®
- 2. Inox A-4 Netvitic System® o-ring
- 3. PA Netvitic System® clamp
- 4. PA upper cap
- 5. GRPP Net
- 6. EPDM Netvitic System® seal
- 7. Screw stainless steel A-2
- 8. GRPP or Polycarbonate lower body
- 9. GRPP central body

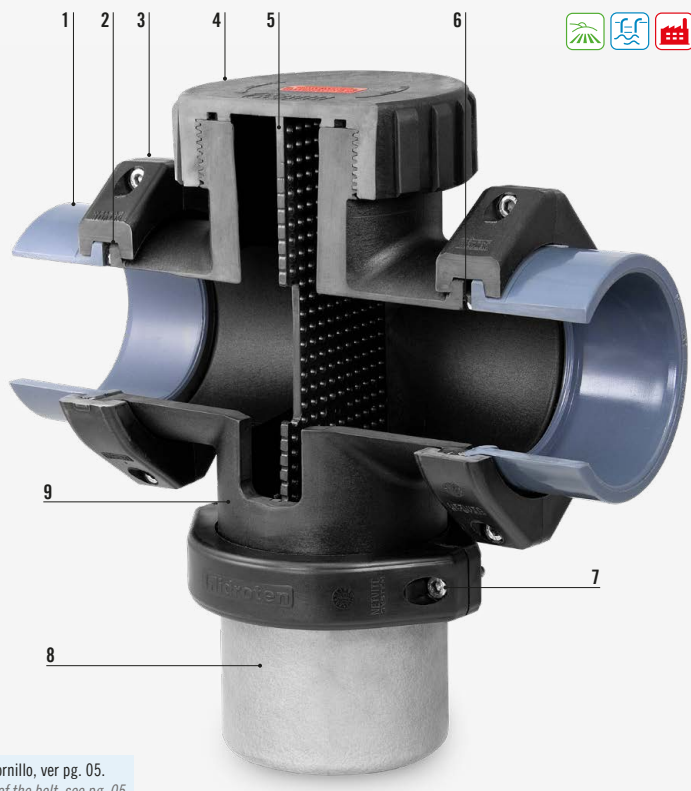

! Para recomendaciones de uso y apriete del tornillo, ver pg. 05.
For recommendations for use and tightening of the bolt, see pg. 05.

SECTOR	Agricultura, piscina, obras públicas e industria / Agriculture, swimming pool, civil engineering and industry
MATERIAL	PPFV-PA / GRPP-PA
MAT. MALLA / NET	PPFV / GRPP
Ø MALLA / NET	Stone 3 o 5 mm - Vertical 4mm / Stone 3 or 5 mm - Vertical 4 mm
PN	PN 10
MEDIDAS / MEASURES	Desde Ø90-200 - Ø2 1/2" a 4" / From Ø90-200 - Ø2 1/2" to 4"

LIMPIEZA // CLEANING

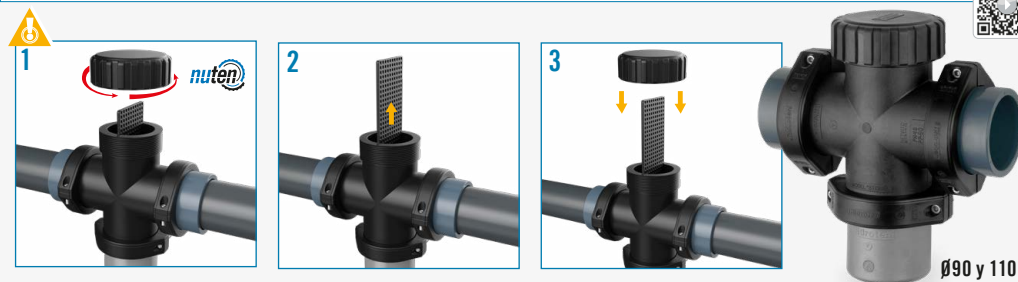

1. Desmontar la tapa superior NuTen.
2. Extraer la malla y limpiar.
3. Insertar de nuevo la malla, colocar la tapa y ajustar las bridas.

1. Disassembling the upper cover NuTen.
2. Removing the screen and cleaning.
3. Introducing the screen, assembling the upper access cap and adjust flanges.



Se debe eliminar la presión del sistema antes de abrir la tapa.

Remove pressure from the system before opening the cap.

EJEMPLO DE APLICACIÓN FILTRO CAZAPIEDRAS // APPLICATION EXAMPLE STONE STRAINER



La imagen muestra el uso de un filtro cazapiedras "STONE" como elemento de seguridad en una conexión parcelaria, eliminando los sólidos de gran tamaño que podrían dañar seriamente elementos de la instalación como contadores o válvulas hidráulicas. Su fabricación en plástico lo convierte en la opción perfecta por su resistencia a la corrosión, ligereza y comodidad en las operaciones de limpieza y mantenimiento.

The picture shows the use of the "STONE" strainer as security element in a ground connection, removing the big size solids that may damage flowmeters or hydraulic valves. Its production in plastic make it the perfect option for its corrosion resistance, lightness and comfort in maintenance operations.

MODELO SCREEN // SCREEN MODEL
515
Salida encolar

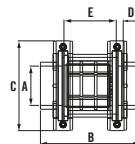
 Solvent socket outlet
 Sortie à coller

Ref.	€	∅ Tubo-A/Pipe	Brida/Clamp	Peso/Wt (g)	Uds. Lote/Batch	B	C	D	E
8N008	201,97	90	125	2.990	4	248	215	52	120
8N009	226,63	110	125	3.176	4	266	215	62	120
8N010	270,84	125	125	3.180	2	290	215	69	120
8N011	500,55	140	160	5.370	2	327	264	78	139
8N012	554,92	160	160	5.700	2	341	264	86	139
8N013	659,21	200	160	7.650	2	468	264	107	139

517
Salida PE - PE

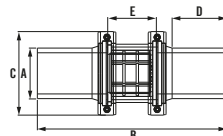
 Thermo fusion outlet
 Sortie thermofusion

Ref.	€	∅ Tubo-A/Pipe	Brida/Clamp	Peso/Wt (g)	Uds. Lote/Batch	B	C	D	E
8N048	246,42	90	125	3.185	4	412	215	103	120
8N049	270,76	110	125	3.818	4	504	215	112	120
8N050	314,97	125	125	3.709	2	420	215	108	120
8N051	563,10	140	160	6.650	2	533	264	124	139
8N052	622,11	160	160	6.705	2	491	264	124	139

Valona larga válida para soldadura a tope y electrofusión. / Long PE outlet for thermo and electro welding.

518
Salida R/Hembra

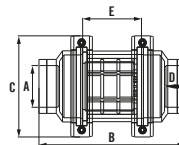
 Female threaded outlet
 Sortie à taraudée

Ref.	€	∅ Tubo-A/Pipe	Brida/Clamp	Peso/Wt (g)	Uds. Lote/Batch	B	C	D	E
8N027	167,83	2 1/2"	125	3.151	4	292	215	30	120
8N028	180,55	3"	125	2.997	4	292	215	34	120
8N029	203,87	4"	125	3.222	4	292	215	44	120

516
Salida Netvitc®

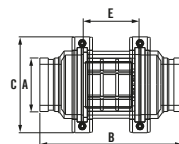
 Netvitc® outlet
 Sortie Netvitc®

Ref.	€	∅ Tubo-A/Pipe	Brida/Clamp	Peso/Wt (g)	Uds. Lote/Batch	A	B	C	E
8N018	182,32	3"	125	2.844	4	3"	292	215	120
8N019	204,39	4"	125	2.870	4	4"	308	215	120

Conexión sistema ranurado. / Grooved system connection.

610
Salida con bridas

Flange outlet

Sortie à brides

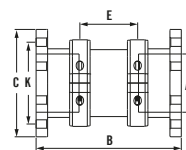

Ref.	€	∅ Tubo-A/Pipe	Brida/Clamp	Peso/Wt (g)	Uds. Lote/batch	B	C	E	K
8N060	296,93	125	125	5.011	1	322	230	120	190
8N061	296,93	125-140	125	6.070	1	322	250	120	210
8N062	608,25	160	160	8.945	1	355	285	139	235-241

K= Distancia entre tornillos (mm). / Distance between bolts (mm).

Normativa bridas: DIN 2576, UNE-EN 1452 (PVC-U), ANSI 16.5, BS 10 tabla D/E

936
Screen Plastic

Screen Plastic

Screen Plastic

AMPLIACIÓN GAMA

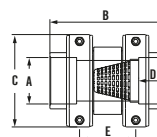

Ref.	€	∅ Tubo-A/Pipe	Brida/Clamp	∅ Agujero/Hole	Peso/Wt (g)	Uds. Lote/Batch	B	C	D	E
8N169	53,91	40	63	4 mm	750	4	182	134	28	76
8N170	58,77	50	63	4 mm	806	4	184	134	31	76
8N171	69,63	63	63	4 mm	758	4	158	134	36	76
8N172	83,89	75	63	4 mm	940	4	208	134	39	76
✓ 8N173	171,88	90	125	4 mm	3.746	4	327	264	78	139
✓ 8N174	175,96	110	125	4 mm	3.863	4	341	264	86	139
✓ 8N175	188,27	125	125	4 mm	3.817	4	468	264	107	139

Opción en "BS", "ASTM" / "BS" optional

519
Cartucho filtro

Cartridge filter

Cartouche filtre

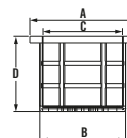

Ref.	€	Cuerpo/Body	Brida/Clamp	Peso/Wt (g)	Uds. Lote/Batch	A	B	C	E
8N089	-	125	125	250	4	140	114	100	112
8N091	Consultar/ To consult	160	160	356	4	171	143	131	126

Opcional malla de 50 y 100 MESH. / 50 & 100 MESH in option.

937
Cesta Screen Plastic

Screen

Maille

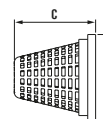

Ref.	€	∅/	∅ Agujero/Hole	Peso/Wt (g)	Uds. Lote/Batch	B	C
8N180	8,36	63	4 mm	23	2	72	77
16417	14,41	125	4 mm	210	4	121	120



FILTROS NETVITC SYSTEM®

NETVITC SYSTEM® FILTER

MODELO STONE // STONE MODEL

520



Ø90-110

Ø125-200

Salida encolar

Solvent socket outlet
Sortie à coller

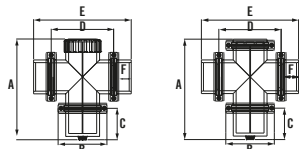

Ref.	€	Ø Tubo/Pipe	Ø Agujero/Hole	Brida/Clamp	Peso/Wt (g)	Uds. Lote/Batch	A	B	C	D	E	F
8N608	254,19	90	5 mm.	90	4.434	2	347	164	110	200	332	52
8N609	353,17	110	5 mm.	110	5.181	2	391	188	120	234	378	61
8N610	413,29	125	5 mm.	125	7.150	1	447	203	153	266	446	70
8N611	479,38	140	5 mm.	140	12.920	1	477	251	153	288	476	78
8N612	506,60	160	5 mm.	160	10.367	1	505	251	153	304	496	86
8N613	565,79	200	5 mm.	200	17.959	1	555	297	153	360	609	106

Opción en "BS", "ASTM" / "BS" optional

521



Ø3"-90 - 4"-110

Ø3"-125 - 4"-125

Salida Netvitc®

Netvitc® outlet
Sortie Netvitc®

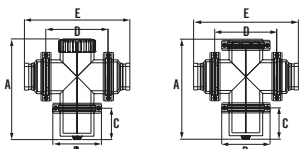

Ref.	€	Ø Tubo/Pipe	Ø Agujero/Hole	Brida/Clamp	Peso/Wt (g)	Uds. Lote/Batch	A	B	C	D	E
8N616	254,61	3"	5 mm.	90	3.840	2	347	164	110	200	328
8N617	332,10	4"	5 mm.	110	4.720	2	391	188	120	234	368
8N618	351,36	3"	5 mm.	125	5.711	1	447	203	153	266	456
8N619	358,72	4"	5 mm.	125	5.743	1	447	203	153	266	472

Conexión sistema ranurado. / Grooved system connection.

522



Ø90-110

Ø125-160

Salida PE - PE

Thermo fusion outlet
Sortie thermofusion

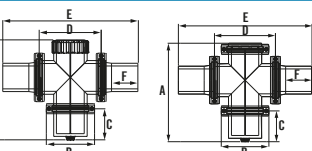

Ref.	€	Ø Tubo/Pipe	Ø Agujero/Hole	Brida/Clamp	Peso/Wt (g)	Uds. Lote/Batch	A	B	C	D	E	F
8N648	280,30	90	5 mm	90	3.598	2	347	164	110	200	482	100
8N649	383,02	110	5 mm	110	5.209	2	391	188	120	234	526	102
8N650	488,81	125	5 mm	125	7.293	1	447	203	153	266	628	135
8N651	551,50	140	5 mm	160	7.763	1	505	251	153	304	670	125
8N652	668,20	160	5 mm	160	12.577	1	505	251	153	304	662	122
8N653	755,75	200	5 mm	200	18.438	1	555	297	153	360	771	132

Valona larga válida para soldadura a tope y electrofusión. / Long PE outlet for thermo and electro welding.

523



Ø90-110

Ø125-160

Salida R/Hembra

Female threaded outlet
Sortie à taraudée

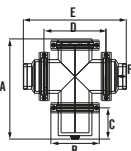

Ref.	€	Ø Tubo/Pipe	Ø Agujero/Hole	Brida/Clamp	Peso/Wt (g)	Uds. Lote/Batch	A	B	C	D	E	F
8N627	351,36	2 1/2"	5 mm	125	5.905	2	447	203	153	266	472	44
8N628	358,72	3"	5 mm	125	6.476	2	447	203	153	266	472	51
8N629	358,72	4"	5 mm	125	5.939	2	447	203	153	266	472	62

Ø de agujero 5 mm de serie, opcional 3 mm. / Hole Ø 5 mm standard, optional 3 mm.

524

Ø90-110

Ø125-160

Salida Bridas

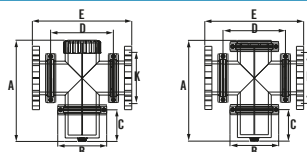
 Flange outlet
Sortie à brides

Ref.	€	Ø Tubo/Pipe	Ø Agujero/Hole	Brida/Clamp	Peso/Wt (g)	Uds. Lote/Batch	A	B	C	D	E	K
8N668	272,90	90	5 mm	90	5.600	2	347	164	110	200	390	146-160
8N669	358,72	110	5 mm	110	5.393	2	391	188	120	234	430	178-190
8N670	440,18	125	5 mm	125	7.075	1	447	203	153	266	474	190
8N671	440,18	125-140	5 mm	125	9.300	1	447	203	153	266	474	210
8N672	538,50	160	5 mm	160	10.919	1	505	251	153	304	520	235-241

K= Distancia entre tornillos (mm). / Distance between bolts (mm).

Normativa bridas: DIN 2576, UNE-EN 1452 (PVC-U), ANSI 16.5, BS 10 tabla D/E

611

Ø90-110

Ø125-200

Cuerpo cazapiedras

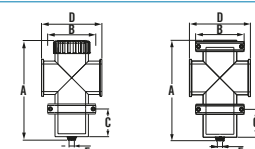
 Body strainer
Corps seul

Ref.	€	Ø Tubo/Pipe	Ø Agujero/Hole	Brida/Clamp	Peso/Wt (g)	Uds. Lote/Batch	A	B	C	D	E
8N688	161,78	90	5 mm	90	3.726	2	347	164	110	200	1/2"
8N689	269,13	110	5 mm	110	3.723	2	391	188	120	234	1/2"
8N690	341,41	125	5 mm	125	3.813	1	447	203	153	266	1/2"
8N692	427,89	160	5 mm	160	6.515	1	505	251	153	304	1/2"
8N693	485,02	200	5 mm	200	11.280	1	555	297	153	360	1/2"

612
Malla cazapiedras

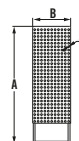
 Screen
Maille

Ref.	€	Ø Tubo/Pipe	Ø Agujero/Hole	Brida/Clamp	Peso/Wt (g)	Uds. Lote/Batch	A	B
8N188	32,51	90	5 mm	90	198	4	302	92
8N189	36,50	110	5 mm	110	262	4	346	108
8N190	45,12	125	5 mm	125	230	2	384	128
8N192	54,58	160	5 mm	160	698	2	456	158
8N193	76,84	200	5 mm	200	475	2	518	196

Bajo pedido podemos suministrar la malla con un diámetro de agujero de 3 mm. / On order we can supply the mesh with a hole diameter of 3 mm.

MODELO VERTICAL // VERTICAL MODEL
929
Salida encolar

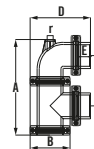
 Solvent socket outlet
Sortie à collar

Ref.	€	Ø Tubo/Pipe	Brida/Clamp	Peso/Wt (g)	Uds. Lote/Batch	A	B	C	D	E	r
8N901	296,14	90	90	3.990	2	397	164	210	254	52	3/4"
8N902	411,45	110	110	5.450	1	456	188	245	283	61	1"

Opción en "BS", "ASTM" / "BS" optional

FILTROS NETVITC SYSTEM®
NETVITC SYSTEM® FILTER
930
Salida PE - PE

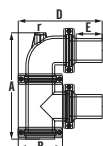
 Thermo fusion outlet
 Sortie thermofusion

Ref.	€	∅ Tubo/Pipe	Brida/Clamp	Peso/Wt (g)	Uds. Lote/Batch	A	B	C	D	E	r
8N911	326,56	90	90	4.220	2	397	164	210	329	100	3/4"
8N912	446,22	110	110	5.600	1	456	188	245	357	102	1"

Valona larga válida para soldadura a tope y electrofusión / Long PE outlet for thermo and electro welding

931
Salida Netvitc®

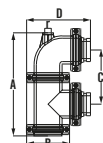
 Netvitc® outlet
 Sortie Netvitc®

Ref.	€	∅ Tubo/Pipe	Brida/Clamp	Peso/Wt (g)	Uds. Lote/Batch	A	B	C	D	r
8N951	296,62	3"	90	3.869	2	397	164	210	258	3/4"
8N952	417,93	4"	110	5.036	1	456	188	245	307	1"

Conexión sistema ranurado / Grooved system connection

932
Salida R/hembra

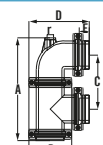
 Female threaded outlet
 Sortie taraudée

Ref.	€	∅ Tubo/Pipe	Brida/Clamp	Peso/Wt (g)	Uds. Lote/Batch	A	B	C	D	E	r
8N921	296,62	3"	90	3.930	2	397	164	210	264	51	3/4"
8N922	409,36	4"	110	5.268	1	456	188	245	303	62	1"

933
Salida Brida

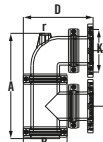
 Flange outlet
 Sortie à brides

Ref.	€	∅ Tubo/Pipe	Brida/Clamp	Peso/Wt (g)	Uds. Lote/Batch	A	B	C	D	K	r
8N931	317,94	90	90	5.867	2	397	164	210	283	146-160	3/4"
8N932	417,93	110	110	7.336	1	456	188	245	309	178-190	1"

K= Distancia entre tornillos (mm) / Distance between bolts (mm)

Normativa bridas; DIN 2576, UNE-EN 1452 (PVC-U), ANSI 16.5, BS 10 tabla D/E

934
Cuerpo cazapiedras

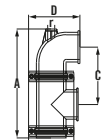
 Body strainer
 Corps seul

Ref.	€	∅ Tubo/Pipe	Brida/Clamp	Peso/Wt (g)	Uds. Lote/Batch	A	B	C	D	r
8N941	188,48	90	90	2.623	2	397	164	210	188	3/4"
8N942	313,56	110	110	4.486	2	456	188	245	211	1"

935
Cesta cazapiedras

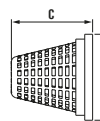
 Screen
Maille

Ref.	€	∅ Tubo/Pipe	∅ Agujero/Hole	Peso/Wt (g)	Uds. Lote/Batch	B	C
8N961	13,99	90	4 mm	37	2	88	93
8N962	16,67	110	4 mm	81	2	120	121

LIMPIEZA CAZAPIEDRAS VERTICAL // VERTICAL STONE CLEANING

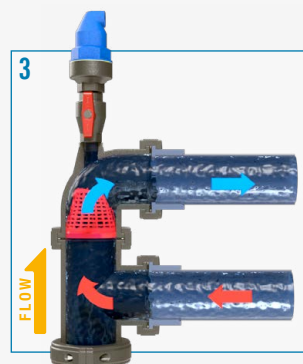
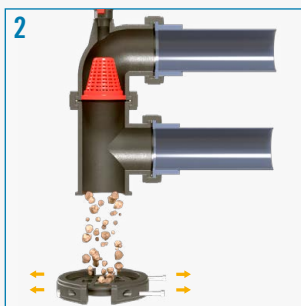

El filtro cazapiedras vertical Netvitc System® es único en el mercado por su diseño específico para ser instalado en vertical. Se trata de una optimización frente a los cazapiedras tradicionales en forma de Y, que son diseños horizontales que al utilizarse de forma vertical provocan que los sólidos queden en circulación.

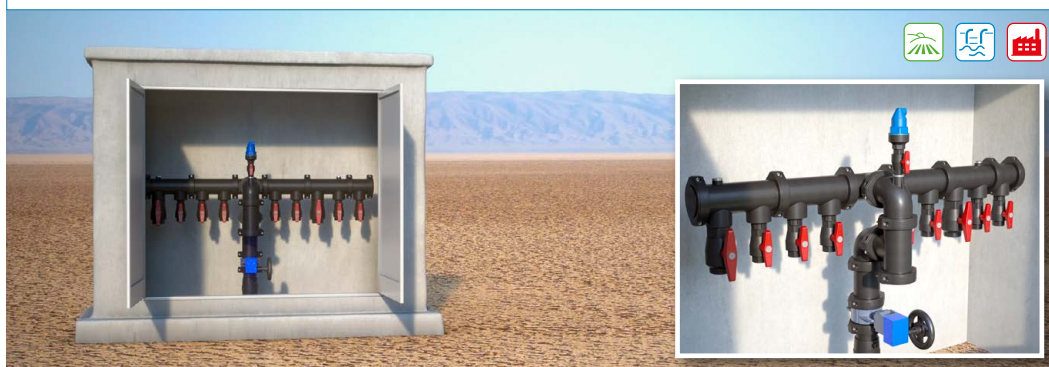

1. El cazapiedras vertical retiene los sólidos de gran tamaño, que quedan atrapados en la parte inferior, quedando fuera del flujo, evitando arrastres sucesivos.
 2. Desmontar el tapón inferior para eliminar la suciedad.
 3. Montar nuevamente el tapón SNS® y seguir trabajando.
1. The vertical strainer retains large solids, being trapped in the lower part, staying out of the flow, avoiding successive trawls.
 2. Disassembling the below access cap to remove dirt.
 3. Reassemble the SNS® cap and continue working.

EJEMPLO DE APLICACIÓN CAZAPIEDRAS VERTICAL // APPLICATION EXAMPLE VERTICAL STRAINER

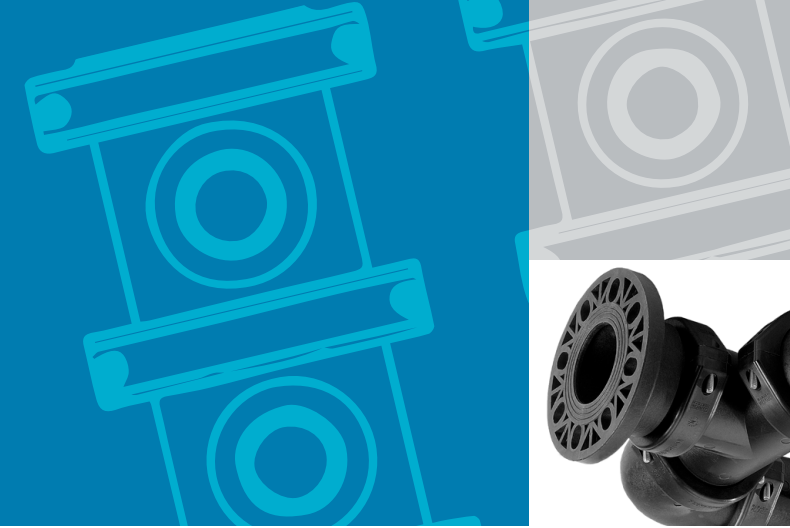
Ejemplo de hidrante de riego multiusuario modular Netvitc System®. Las características del sistema Netvitc System® permiten una perfecta adaptación para cada instalación. En primer término vemos el cazapiedras vertical, que nos permite optimizar el diseño buscando el máximo aprovechamiento del espacio y la máxima facilidad en el mantenimiento.



SNS
Netvitc System®



HIDRANTES NETVITC SYSTEM®
NETVITC SYSTEM® HYDRANTS

FAMILIA
1NH FAMILY



CARACTERÍSTICAS // FEATURES

La modularidad convierte al sistema Netvitic System® en la solución ideal a la hora de plantear el diseño e instalación de hidrantes. Las posibilidades de modificaciones en la estructura de los diseños son prácticamente infinitas, pudiendo adecuarse a las características específicas de cada instalación.

La elección del PPFV como material para los accesorios Netvitic System® responde a las necesidades de las instalaciones, aportando un **magnífico comportamiento químico**, una **óptima resistencia** frente a las radiaciones solares y las heladas, así como una **gran ligereza** que permiten grandes ahorros en tiempos de instalación.

La perfecta unión mecánica del sistema Netvitic System® asegura la máxima estanqueidad y su diseño de bridas con 2 tornillos permite una enorme velocidad de instalación. **Gran flexibilidad para cambiar la configuración de la instalación** según las necesidades, con una facilidad y rapidez inalcanzable para cualquier otro sistema.

Modularity makes the Netvitic System® the ideal solution in the process of design and installation of hydrants. The possibilities of modifications in the structure of the designs are almost unlimited and they can adapt to the specific characteristics of any installation.

The election of GRPP as the material used in Netvitic System® accessories meets the needs of the installations and provides a **great chemical performance**, an **optimal resistance** to solar radiation and frosts, as well as a **great lightness** which save installation time.

The perfect mechanical connection of Netvitic System® guarantees maximum water tightness and its design of flanges with two screws speeds up the installation. It offers a **great flexibility to change the setting of the installation** according to your needs, as well as an unachievable ease and speed for any other system.

NOMENCLATURA // NOMENCLATURE



- 1. Válvula de mariposa SNS® red. manual
- 2. Codo "Air" Netvitic System®
- 3. Ventosa Net®
- 4. Filtro cazapiedras modelo Stone
- 5. Brida Netvitic System® PA
- 6. Te doble R/H Netvitic System®
- 7. Válvula de bola "Compact"

- 1. SNS® butterfly valve manually operated
- 2. "Air" Netvitic System® 90° elbow
- 3. Net® air release valve
- 4. Netvitic System® filter Stone model
- 5. PA Netvitic System® clamp
- 6. SNS® female threaded double tee
- 7. "Compact" ball valve

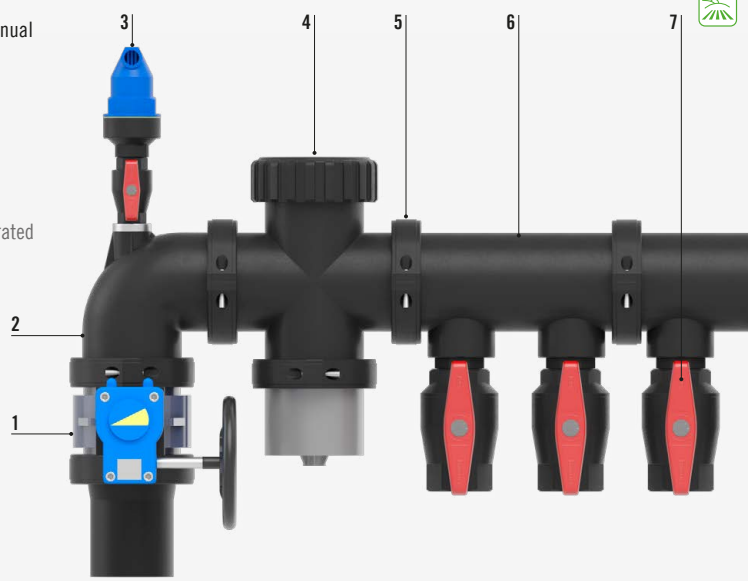

Para recomendaciones de uso y apriete del tornillo, ver pg. 05.
For recommendations for use and tightening of the bolt, see pg. 05.



DESCÁRGATE el dossier de hidrantes SNS®

COMBINACIÓN DE GAMA // COMBINATION RANGE

Válvula Netvitc System® SNS® butterfly valve Ø90 - Ø110	Codo 90° Netvitc System® SNS® 90° elbow Ø90 - Ø110	Cazapiedras Netvitc System® SNS® Stone strainer filter Ø90 - Ø110	Brida Netvitc System® SNS® flange Ø90 - Ø110



La variedad de **TES** con salida roscada, permiten realizar **innumerables configuraciones**, adaptándonos a las necesidades de cada instalación y permitiendo ampliaciones y modificaciones con la máxima sencillez.

The variety of tees with threaded outlet, allow for countless configurations, adapting to the needs of each facility and allowing extensions and modifications with the utmost simplicity.

Te corta R/H SNS® SNS® F/T short tee Ø90-2" - Ø110-2"	Te corta R/H SNS® "AIR L" "AIR L" SNS® F/T short tee Ø90-2" - Ø110-2"	Te corta R/H SNS® "AIR" "AIR" SNS® F/T short tee Ø90-2" - Ø110-2"	Te doble "AIR" SNS® R/H "AIR" SNS® F/T double tee Ø90-2" - Ø110-2"	Te doble SNS® R/H SNS® F/T double tee Ø90-2" - Ø110-2"

--	--	--	--



HIDRANTES NETVITC SYSTEM®
NETVITC SYSTEM® HYDRANTS

613

Hidrante simple entrada lateral

Simple hydrant side entry
Extincteur simple entrée latérale

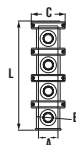

Ref.	€	∅ Entrada/Inlet A	∅ Salida/Outlet B	Salidas/Outlets Max.	Peso/Wt (g)	C	L
1NH007	226,54	90	2"	3	2.945	164	463
1NH008	551,23	110	1"	6	6.158	188	901
1NH009	551,23	110	1 1/4"	6	6.278	188	901
1NH010	551,23	110	1 1/2"	6	6.536	188	901
1NH011	382,92	110	2"	4	4.662	188	609

614

Hidrante doble entrada lateral

Double hydrant side entry
Extincteur double entrée latérale

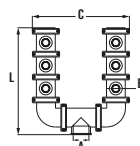

Ref.	€	∅ Entrada/Inlet A	∅ Salida/Outlet B	Salidas/Outlets Max.	Peso/Wt (g)	C	L
1NH027	473,50	90	2"	3	6.509	542	525
1NH028	878,86	110	1"	6	11.130	672	707
1NH029	878,86	110	1 1/4"	6	11.250	672	707
1NH030	878,86	110	1 1/2"	6	11.508	672	707
1NH031	710,57	110	2"	4	9.634	672	561

615

Hidrante simple entrada central

Simple hydrant central entry
Extincteur simple entrée centrale

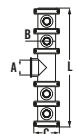

Ref.	€	∅ Entrada/Inlet A	∅ Salida/Outlet B	Salidas/Outlets Max.	Peso/Wt (g)	C	L
1NH107	353,31	90	2"	3	4.617	164	702
1NH108	717,64	110	1"	6	8.476	188	1.177
1NH109	717,64	110	1 1/4"	6	8.596	188	1.177
1NH110	717,64	110	1 1/2"	6	8.854	188	1.177
1NH111	549,36	110	2"	4	6.980	188	885

616

Hidrante doble entrada central

Double hydrant central entry
Extincteur double entrée centrale

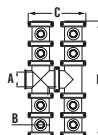

Ref.	€	∅ Entrada/Inlet A	∅ Salida/Outlet B	Salidas/Outlets Max.	Peso/Wt (g)	C	L
1NH128	1.028,48	110	1"	6	11.870	442	739
1NH129	1.028,48	110	1 1/4"	6	11.990	442	739
1NH130	1.028,48	110	1 1/2"	6	12.248	442	739
1NH131	615,38	110	2"	4	10.266	442	593

• Entrada principal. / Main entrance.

617
Hidrante simple entrada lateral conexión brida

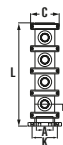

Simple hydrant side entry flange connection
Extincteur simple entrée latérales connexion bride



Ref.	€	∅ Entrada/Inlet A	∅ Salida/Outlet B	Salidas/Outlets Max.	Peso/Wt (g)	C	L	K
1NH307	295,40	90	2"	3	3.947	164	523	146-160
1NH308	630,31	110	1"	6	7.449	188	971	178-190
1NH309	630,31	110	1 1/4"	6	7.569	188	971	178-190
1NH310	630,31	110	1 1/2"	6	7.827	188	971	178-190
1NH311	462,02	110	2"	4	5.953	188	679	178-190

618
Hidrante doble entrada lateral conexión brida

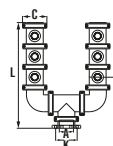

Double hydrant side entry flange connection
Extincteur double entrée latérale connexion bride



Ref.	€	∅ Entrada/Inlet A	∅ Salida/Outlet B	Salidas/Outlets Max.	Peso/Wt (g)	C	L	K
1NH327	542,38	90	2"	3	7.511	542	585	146-160
1NH328	957,91	110	1"	6	12.421	672	777	178-190
1NH329	957,91	110	1 1/4"	6	12.541	672	777	178-190
1NH330	957,91	110	1 1/2"	6	12.799	672	777	178-190
1NH331	789,66	110	2"	4	10.925	672	631	178-190

619
Hidrante simple de entrada central conexión brida

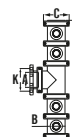

Simple hydrant central entry flange connection
Extincteur simple entrée centrale connexion bride



Ref.	€	∅ Entrada/Inlet A	∅ Salida/Outlet B	Salidas/Outlets Max.	Peso/Wt (g)	C	L	K
1NH407	422,19	90	2"	3	5.619	164	702	146-160
1NH408	796,73	110	1"	6	9.767	188	1177	178-190
1NH409	796,73	110	1 1/4"	6	9.887	188	1177	178-190
1NH410	796,73	110	1 1/2"	6	10.145	188	1177	178-190
1NH411	628,40	110	2"	4	8.271	188	885	178-190

620
Hidrante doble de entrada central conexión brida

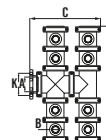
Double hydrant central entry flange connection
Extincteur double entrée centrale connexion bride



Ref.	€	∅ Entrada/Inlet A	∅ Salida/Outlet B	Salidas/Outlets Max.	Peso/Wt (g)	C	L	K
1NH428	1.107,54	110	1"	6	13.161	512	739	178-190
1NH429	1.107,54	110	1 1/4"	6	13.281	512	739	178-190
1NH430	1.107,54	110	1 1/2"	6	13.539	512	739	178-190
1NH431	939,22	110	2"	4	11.557	512	593	178-190

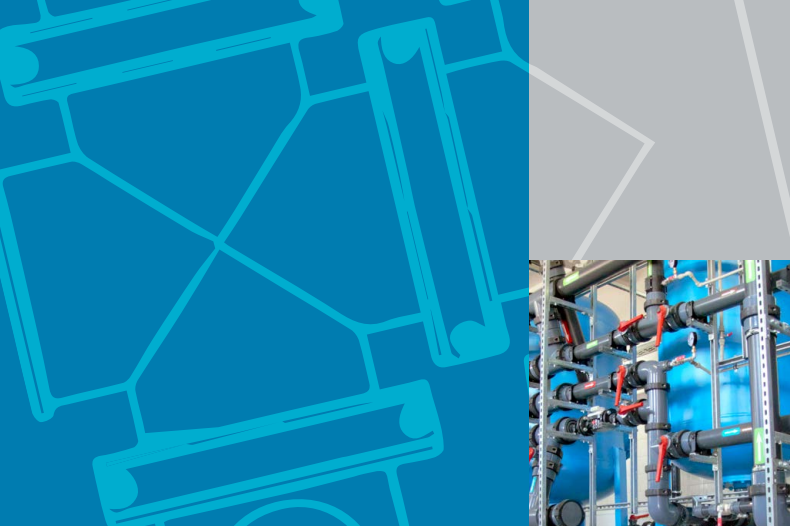



**EJEMPLOS INSTALACIONES
NETVITC SYSTEM®**
INSTALLATIONS EXAMPLES

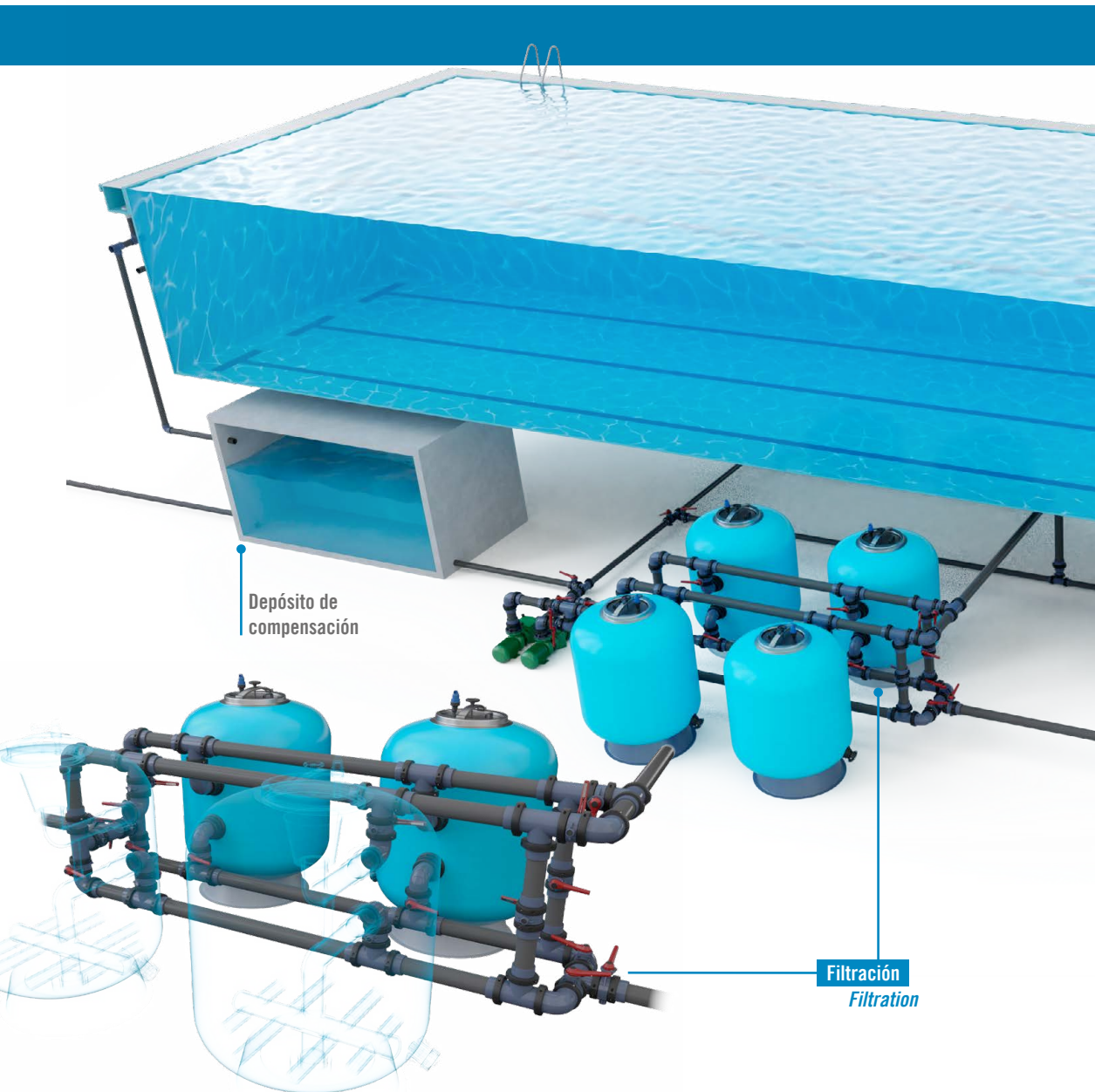

Depósito de
compensación

Filtración
Filtration

El tratamiento del agua de las piscinas tiene dos etapas fundamentales: la **filtración** y la desinfección. En la instalación de filtros de arena, realizada íntegramente con SNS®, se han dispuesto los **filtros trabajando dos a dos, utilizando un único colector de válvulas** para cada pareja de filtros.

La versatilidad y modularidad del SNS® ha permitido realizar la instalación reduciendo encoladuras y las características de las **válvulas de mariposa SNS®** permiten una automatización posterior del sistema, rápida y sin tener que hacer modificaciones en la instalación. La **ausencia de la tradicional tornillería** mejora visualmente la instalación, pero sobre todo, **elimina los problemas de corrosión y alarga la vida útil** de la instalación.

*Swimming pool water treatment has two fundamental stages: **filtration** and disinfection. In the installation of sand filters, made entirely with SNS®, the filters have been arranged in pairs, using a single valve manifold for each couple of filters.*

*The versatility and modularity of the SNS® facilitates the installation process by reducing the number of gluing and SNS® butterfly valves allow subsequent automation of the system, quickly and without having to make changes to the assembly. The **absence of screws** visually improves the installation, but more importantly, it **eliminates corrosion problems and increases the lifetime** of the system.*

Netvitc System® sector piscina

ÚNICO
en el mercado **um**

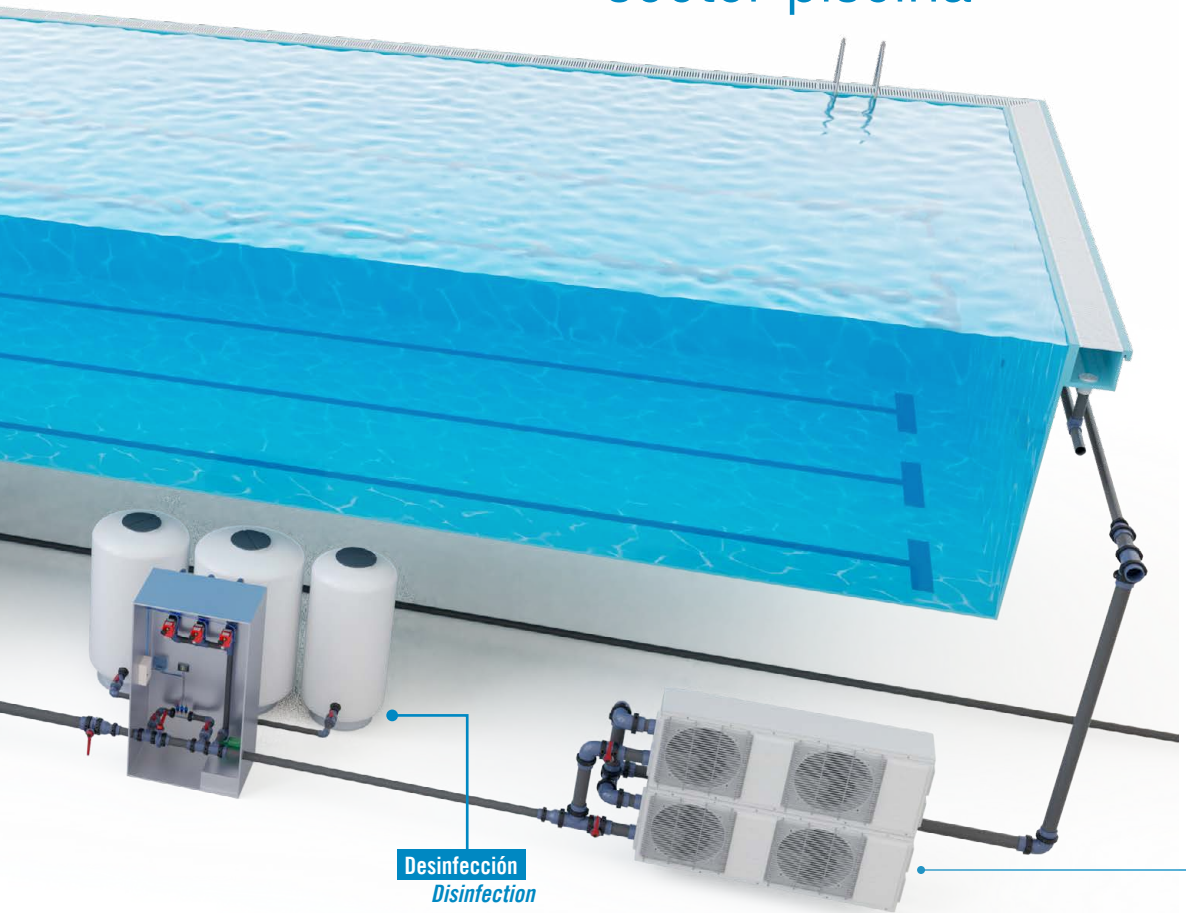

Desinfección Disinfection



Tras la filtración es imprescindible la **desinfección del agua**, tradicionalmente la manera más común de desinfección es el cloro, que se va inyectando según las necesidades junto con correctores de pH. Cada vez están más presentes los **sistemas de electrólisis salina**, que permiten la generación in situ del cloro y sistemas de ultravioleta.

En la imagen podemos ver la inyección de los productos químicos gobernada por **válvulas automatizadas** que varían su apertura en función de las necesidades.

*After the filtration process, the water must be **disinfected**. Traditionally, the most common method of disinfection is chlorine, which is injected as required together with pH regulators. **Salt electrolysis systems**, which allow chlorine to be generated in situ, and ultraviolet systems are becoming more and more common.*

*In the picture we can see the injection of the chemical products controlled by **automated valves** which change their opening according to the needs.*

Climatización Heating

De cara a incrementar la usabilidad de las piscinas, cada vez es más habitual la inclusión de **bombas de calor** para obtener una temperatura que permita el baño durante más meses en el año.

*The inclusion of heat pumps allows to obtain a **temperature suitable** for swimming during more months of the year.*

SISTEMA DE FILTRACIÓN // FILTRATION SYSTEM



PRODUCTOS HIDROTEN // HIDROTEN PRODUCTS

Collarín bisagra salida encolar, válvula de mariposa SNS® manual y neumática, válvula retención lineal Netvitec System® cuerpo visor, válvula de mariposa Implex®, válvula retención System®.

Hinged sleeve solvent socket outlet, manual and pneumatic SNS® butterfly valve, Netvitec System® sight glass lineal check valve, Implex® butterfly valve, System® check valve.

DESCRIPCIÓN DEL PROYECTO // PROJECT DESCRIPTION

Por tratarse de una instalación expuesta a un ambiente clorado se ha prescrito la utilización de válvulas con sistema Netvitec System®, ya que reducen la tornillería y minimizan los problemas ocasionados por la corrosión. Para obtener los colectores más compactos que con cualquier otra solución del mercado, se ha optado por la utilización del collarín bisagra.

Being an installation exposed to a chlorinated environment, the use of valves with Netvitec System® has been prescribed, because they reduce the screws and minimize the problems due to corrosion. To make the manifolds more compact than with any other solution on the market, the hinged sleeve has been used.

SISTEMA FILTRACIÓN DE REFRIGERACIÓN // FILTRATION IN INDUSTRIAL REFRIGERATION



PRODUCTOS HIDROTEN // HIDROTEN PRODUCTS

Válvulas mariposa SNS®, accesorios SNS®: codo 90°, codo "Air", te 90°, tapón.

Netvitec System® butterfly valves, SNS® fittings: 90° elbow, "Air" elbow, 90° tee, plug.

DESCRIPCIÓN DEL PROYECTO // PROJECT DESCRIPTION

La aplicación del Sistema Netvitec System® en el circuito de refrigeración industrial de alta capacidad, aporta flexibilidad a la instalación, reduce peso y permite un mantenimiento mucho más rápido que los sistemas tradicionales.

The application of the Netvitec System® in the high-capacity industrial refrigeration circuit, provides installation flexibility, reduces weight and allows for much faster maintenance than traditional systems.

SISTEMA DE FILTRACIÓN // FILTRATION SYSTEM

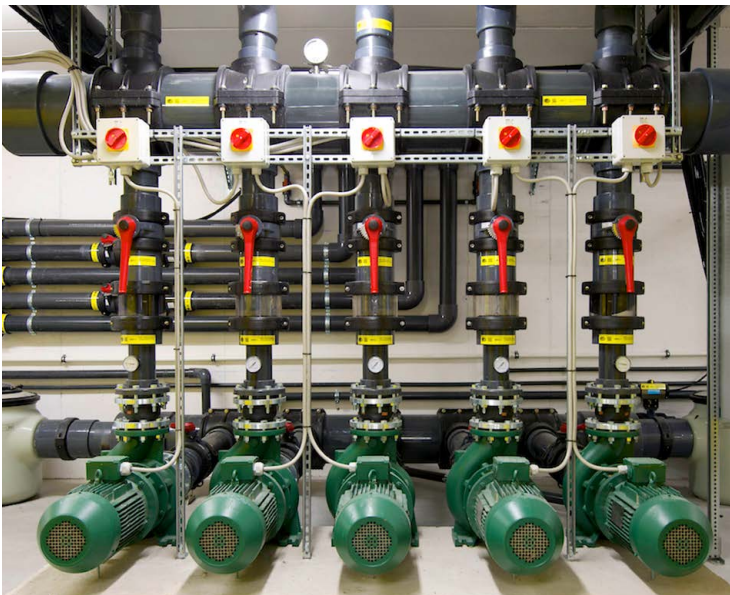

PRODUCTOS HIDROTEN // HIDROTEN PRODUCTS

Collarín bisagra salida encolar, válvula de mariposa Netvitic System®, válvula retención lineal Netvitic System® cuerpo visor, válvula de mariposa Implex®, válvula retención System®.

Hinged sleeve solvent socket outlet, Netvitic System® butterfly valve, Netvitic System® sight glass lineal check valve, Implex® butterfly valve, System® check valve.

DESCRIPCIÓN DEL PROYECTO // PROJECT DESCRIPTION

Instalación del sistema de filtrado de las piscinas y parque acuático del Camping Lido, situado en la población italiana de Lazise. Destaca el uso de válvulas de mariposas y retención con sistema Netvitic System®, así como collarines bisagra. Ambos sistemas aportan las más altas prestaciones en instalaciones con ambientes agresivos.

Installation of filtering system in the swimming pools and water park Camping Lido, located in the Italian town of Lazise. It emphasizes the use of butterfly and check valves with Netvitic System®, as well as collarines bisagra. Both systems provide the highest performance in aggressive environments.

SNS[®]

Netvitc System

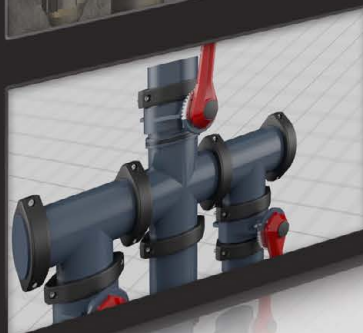

Visite nuestra página web www.hidroten.es donde podrá disponer de los videos de nuestro sistema Netvitc System[®].

- ▶ Netvitc System[®]
- ▶ Instalación del sistema Netvitc System[®]
- ▶ Instalación de válvula de retención lineal SNS[®]
- ▶ Válvula de mariposa Netvitc System[®]
- ▶ Hidrantes Netvitc System[®]
- ▶ Filtro cazapiedras "Stone" Netvitc System[®]
- ▶ Únicos en el mercado
- ▶ Válvula de aspiración Netwell[®]
- ▶ Filtro cazapiedras "Stone" vertical
- ▶ Productos para piscina doméstica

A través de nuestros videos mostramos sus diferentes aplicaciones en sectores, procesos de montaje y desmontaje, materiales...



WEBINARS

formación técnica
a distancia

Ventajas de los webinars

- ✓ Compartir contenido de valor en formato dinámico.
- ✓ El contenido interactivo es fácil de compartir de forma online.
- ✓ Escuchar a la audiencia, creando un vínculo con los clientes, suscriptores y seguidores de las redes sociales.
- ✓ Permite crear temas nuevos a partir de la participación activa en el evento, resolución de dudas e inquietudes.

Contacta con
nuestro S.A.T.C.

965 105 888

www.hidroten.com/formacion



Siempre hemos apostado por la formación técnica, para ello ofrecemos asesoramiento y soporte técnico a profesionales a través del S.A.T.C (Servicio de Atención Técnica Comercial). Pero en lo que concierne a la formación técnica presencial se ha visto alterada, y por esto se han sustituido los seminarios presenciales por webinars.

Este método ofrece más comodidades para todos, sobretodo para los asistentes, ya que ante la imposibilidad de asistir, si se han registrado previamente en la sesión, recibirán el video del webinar a través de su correo.



HIDROTEN, pensando siempre en facilitarle sus actividades profesionales, presenta su nueva Tarifa de precios número 29 en formato PRESTO (programa de gestión de costes para Edificación y Obra civil más difundido) y BC3 (formato de Intercambio Estándar de Bases de Datos de Construcción), necesario para proyectistas, arquitectos, ingenieros... a la hora de realizar sus proyectos, compatible con los principales

programas de mediciones y presupuestos: Presto, Menfis, Cype (Arquímedes)... PRESTO es un programa de presupuestos que ya es utilizado por infinidad de profesionales de proyectos para calcular costes.

La TARIFA 29 en formato PRESTO de HIDROTEN, facilita la búsqueda y la consulta a los proyectistas de nuestros productos, ayudando a la elaboración de presupuestos o memorias técnicas.

La tarifa de Hidroten en versión de formato presto, está desglosada en 5 apartados:



Hidroten se suma a la metodología de trabajo BIM

En Hidroten nos sumamos a la metodología de trabajo colaborativo BIM.

Se trata de una herramienta tecnológica para la gestión de proyectos, a través de un modelo digital 3D, que reduce costes, acorta tiempos de diseño y producción y mejora la calidad de los proyectos de ingeniería, arquitectura y construcción.

En Hidroten hemos generado familias BIM en formato Revit® para aquellos profesionales que ya trabajan con esta metodología.

Nuestro departamento de Prescripción le podrá asesorar a la hora de descargar y utilizar dichas familias en sus proyectos, así como de las ventajas que representa su uso.

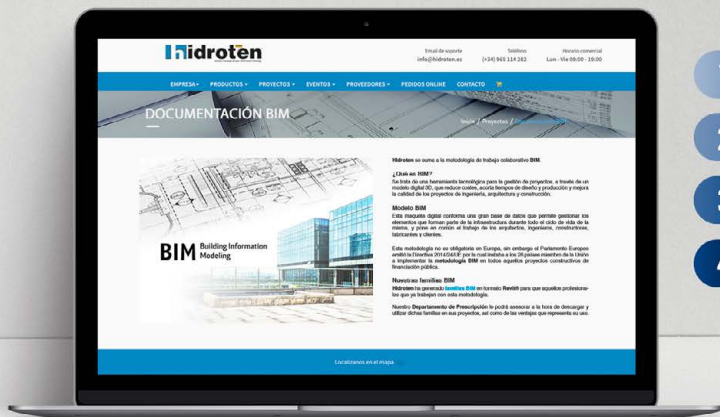

- 1 Modelo digital 3D
- 2 Reduce costes
- 3 Acorta tiempos en diseño
- 4 Calidad en proyectos

Documentación
BIM



Servicio de atención técnica comercial

El **S.A.T.C.** (Servicio Atención Técnica Comercial) de **HIDROTEN**, nace con el propósito de asesorar y dar soporte técnico a todos los profesionales del sector que trabajan con sus productos, ya sean instaladores, ingenieros o distribuidores.

Nuestro equipo de profesionales le orientará para que logre siempre obtener la mayor optimización a la hora de aplicar nuestros productos en sus instalaciones.

Para obtener asesoramiento técnico-comercial o cualquier tipo de información adicional, no dude en ponerse en contacto con nuestro S.A.T.C. sin ningún tipo de compromiso o coste telefónico:

 (+34) 966 105 888

También puede contactar por medio del e-mail tecnicocomercial@hidroten.es



Con el fin de dar respuesta y satisfacción a nuestros clientes, ponemos a vuestra disposición un nuevo servicio (**UTM**), **UNIDAD TÉCNICA MÓVIL** con la finalidad de apoyar y fomentar el conocimiento de nuestros sistemas de productos. La Unidad Técnica se desplazará donde nos necesite, realizando jornadas informativas y explicativas con demostraciones y productos reales.

Apoymos y reforzamos la confianza de nuestros clientes



Asesoramiento

Te asesoramos técnicamente y te ofrecemos la mejor solución para tus instalaciones.



Desplazamiento

Te mostraremos nuestros sistemas de productos allá donde nos necesites.



info@hidroten.es

ITEM	DESCRIPCIÓN / DESCRIPTION	DIÁMETRO / DIAMETER	PAG.
88	Visor líquidos salida encolar // Fluids display solvent socket outlet	40 – 225	28
89	Visor líquidos salida Netvitc® // Fluids display Netvitc® outlet	2" – 4"	28
90	Visor líquidos salida PE-PE // Fluids display PE outlet	50 – 225	28
91	Visor líquidos salida rosca hembra // Fluids display female threaded outlet	2" – 4"	29
169	Válvula mariposa SNS® // SNS® Valve	63-75 – 200/225	36
170	V. mariposa SNS® salida PE/enc. // SNS® valve thermo fusion outlet with flanges, s/s	63 – 225	36
171	V. mariposa SNS® salida encolar // SNS® valve solvent socket outlet with flanges	63 – 225	36
172	V. mariposa SNS® salida PE/PE // SNS® valve thermo fusion outlet	63 – 225	37
173	V. mariposa SNS® motor eléctrico s/encolar // SNS® valve electrically operated	63 – 225	38
174	V. mariposa SNS® act. neumático s/enc. S/E // SNS® valve pneumatically operated, simple act.	63 – 225	38
175	V. mariposa SNS® mano reductor. S/encolar // SNS® Valve manually operated	63 – 225	38
176	V. mariposa SNS® act. neumático s/enc. D/E // SNS® Valve pneumatically operated, double act.	63 – 225	39
177	Enlace brida VM SNS® salida encolar // SNS® flange set, glued	63 – 225	39
180	Conjunto brida y portabrida reducido salida enc. // Clamp and adaptor, glued reducer	90 – 200	39
181	Conjunto brida y portabrida reducido salida r-h // Clamp and adaptor, f/f outlet reducer	2 1/2" – 4"	40
290	V. Pie descarga con salida rosca hembra // Foot valve delivery with thread female outlet	2" – 4"	46
291	V. Pie descarga con salida encolar // Foot valve delivery with solvent socket outlet	90 – 225	46
292	V. Pie descarga con salida Netvitc® // Foot valve delivery with Netvitc® outlet grooved system	2"-4"	47
293	V. Pie descarga con salida PE // Foot valve delivery with PE outlet	90 – 225	47
294	V. Pie flotante salida rosca hembra // Floating valve threaded female outlet	2" – 4"	48
295	V. Pie flotante salida encolar // Floating valve with solvent socket outlet	40 – 225	48
296	V. Pie flotante salida Netvitc® // Floating valve with Netvitc® outlet grooved system	2" – 4"	49
297	V. Pie flotante salida PE // Floating valve with PE outlet	50 – 225	49
298	V. Ret. Lineal salida rosca hembra // Lineal check valve threaded female outlet	2 – 4"	54
299	V. Ret. Lineal salida PE-PE // Lineal check valve thermo fusion outlet	50 – 225	54
300	V. Ret. Lineal salida encolar // Lineal check valve solvent socket outlet	40 – 225	54
302	V. Ret. Lineal visor salida rosca hembra // Lineal check valve threaded female outlet	2" – 4"	54
303	V. Ret. Lineal visor salida PE-PE // Lineal check valve thermo fusion outlet	50 – 225	54
305	V. Ret. Lineal visor salida encolar // Lineal check valve solvent socket outlet	40 – 225	54
513	Visor líquidos salida brida // Fluids display flange outlet	125 – 160	29
515	Filtro SNS® s/enc. // SNS® filter solvent socket outlet	90 – 200	62
516	Filtro SNS® s/Netvitc® // SNS® filter Netvitc® outlet	3" – 4"	62
517	Filtro SNS® s/PE-PE // SNS® filter thermo fusion outlet	90 – 160	62
518	Filtro SNS® s/r-h // SNS® filter threaded female outlet	2 1/2" – 4"	62
519	Cartucho filtro SNS® // SNS® filter cartridge	125 – 165	63
520	Filtro cazapiedras s/enc. // "Stone" model filter solvent socket outlet	90 – 200	64
521	Filtro cazapiedras s/Netvitc® // "Stone" model filter Netvitc® outlet	3" – 4"	64
522	Filtro cazapiedras s/PE-PE // "Stone" model filter thermo fusion outlet	90 – 200	64

ITEM	DESCRIPCIÓN / DESCRIPTION	DIÁMETRO / DIAMETER	PAG.
523	Filtro cazapiedras s/r-h // "Stone" model filter threaded female outlet	2 1/2" – 4"	64
524	Filtro cazapiedras s/brida // "Stone" model filter flange outlet	90 – 160	65
603	Descarga con salida brida // Foot valve delivery with flange outlet	125 – 160	47
604	Sistema flotación salida bridas // Floating system with flange outlet	125 – 160	49
610	Filtro SNS® modelo screen salida bridas // SNS® filter flange outlet	125 – 160	63
611	Cuerpo cazapiedras // Body strainer	90 – 200	65
612	Malla cazapiedras // Screen	90 – 200	65
613	Hidrante simple entrada lateral // Simple hydrant side entry	90-2" – 110-2"	72
614	Hidrante doble entrada lateral // Double hydrant side entry	90-2" – 110-2"	72
615	Hidrante simple entrada central // Simple hydrant central entry	90-2" – 110-2"	72
616	Hidrante doble entrada central // Double hydrant central entry	110-1" – 110-2"	72
617	Hidrante simple entrada lateral conex. brida // Simple hydrant side entry flange connection	90-2" – 110-2"	73
618	Hidrante doble entrada lateral conex. brida // Double hydrant side entry flange connection	90-2" – 110-2"	73
619	Hidrante simple entrada central conex. brida // Simple hydrant central entry flange connection	90-2" – 110-2"	73
620	Hidrante doble entrada central conex. brida // Double hydrant central entry flange connection	110-1" – 110-2"	73
622	Válv. SNS® acodada encolar // SNS® Valve elbow plain outlet	90 – 200	37
637	Conjunto codo 90° SNS® / brida // Assembly flange SNS®, 90° elbow	90 – 200	40
683	Valv. SNS® acodada "Air" // "Air" SNS® Valve elbow plain/threaded outlet	90 – 200	37
684	Conjunto codo 90° "Air" SNS®/ brida // Assembly flange "Air" SNS®, 90° elbow	90 – 200	40
814	Maneta gatillo // Catch handle	63-75 – 250	40
929	Cazapiedras vertical salida encolar // Vertical strainer solvent socket outlet	90-110	65
930	Cazapiedras vertical salida PE-PE // Vertical strainer PE outlet	90-110	66
931	Cazapiedras vertical salida Netvitc® // Vertical strainer Netvitc® outlet	90-110	66
932	Cazapiedras vertical salida r/h // Vertical strainer female threaded outlet	90-110	66
933	Cazapiedras vertical salida brida // Vertical strainer flange outlet	90-110	66
934	Cuerpo cazapiedras vertical // Vertical strainer body	90-110	66
935	Cesta cazapiedras modelo vertical // Screen vertical strainer	90-110	67
936	Filtro Screen Plastic // Screen Plastic filter	40-110	63
937	Cesta Screen Plastic // Screen	63	63
949	Filtro screen Plus // Screen Plastic filter	40-75	55
956	Válvula aspiración sistema de pie salida espiga // Delivery with spigot connection	2"-3"	46
957	Válvula aspiración sistema flotación salida espiga // Delivery with spigot connection	2"-3"	48
01N	Codo 90° SNS® // SNS® 90° elbow	63 – 200	10
02N	Codo 90° SNS® c/b // SNS® 90° elbow w/f	63 – 200	11
03N	Codo 45° SNS® // SNS® 45° elbow	63 – 110	13
04N	Codo 45° SNS® c/b // SNS® 45° elbow w/f	63 – 110	13
05N	Te 90° SNS® // SNS® 90° Tee	63 – 200	14
06N	Te 90° SNS® c/b // SNS® 90° Tee w/f	63 – 200	14

ITEM	DESCRIPCIÓN / DESCRIPTION	DIÁMETRO / DIAMETER	PAG.
07N	Tapón SNS® // SNS® cap	50 – 200	19
08N	Tapón SNS® c/b // SNS® cap w/f	90 – 225	19
09N	Manguito SNS® // SNS® coupling	90 – 110	17
10N	Manguito SNS® c/b // SNS® coupling w/f	90 – 110	17
11N	Enl. 3 Piezas encolar SNS® // SNS® Union, solvent socket	40 – 225	18
12N	Enl. 3 Piezas PE-PE SNS® // SNS® Union PE-PE	50 – 225	18
13N	Enl. 3 Piezas “BS” encolar SNS® // SNS® Union, solvent socket	1 1/4” – 8”	18
14N	Enl. 3 Piezas PE-encolar SNS® // SNS® Union PE-solvent socket	50 – 225	19
15N	Brida SNS® // SNS® clamp	50 – 200	10
16N	Juntas SNS® // SNS® “J-BIL” O-ring	50 – 200	10
17N	Portabridas SNS® // SNS® adaptor	2” – 4”	22
18N	Portabridas r/h SNS® // SNS® adaptor female threaded	2” – 4”	23
19N	Portabridas PVC-U SNS® enc. // SNS® adaptor	63 – 200	20
20N	Portabridas reducido PVC-U SNS® enc. // SNS® reducing adaptor	40 – 225	21
21N	Portabridas PE SNS® // SNS® PE adaptor	63 – 200	21
22N	Portabridas reducido PE SNS® // SNS® reducing adaptor PE	50-63 – 225-200	22
23N	Codo 90° SNS® “Air” c/b salida r/h // “Air” SNS® 90° elbow w/f	63-1/2” – 200-2”	11
24N	Codo 90° SNS® “Air” // “Air” SNS® 90° elbow	63-1/2” – 200-2”	11
25N	Brida transición SNS® PVC-U // SNS® transition flange	90 – 160	22
26N	Codo 90° SNS® PP // SNS® 90° elbow	63 – 200	10
27N	Codo 90° SNS® c/b PP, salida PE // SNS® 90° elbow w/f, PE outlet	63 – 200	12
28N	Codo 90° SNS® “Air” PP // “Air” SNS® 90° elbow	63-1/2” – 200-2”	11
29N	Codo 90° SNS® “Air” c/b PP, salida PE // “Air” SNS® 90° elbow w/f, PE outlet	63-1/2” – 200-2”	13
30N	Codo 45° SNS® PP // SNS® 45° elbow	63 – 110	13
31N	Codo 45° SNS® c/b PP, salida PE // SNS® 45° elbow w/f, PE outlet	63 – 110	14
32N	Te 90° SNS® PP // SNS® 90° Tee	63 – 200	14
33N	Te 90° SNS® PP, salida PE // SNS® 90° tee w/f, PE outlet	63 – 200	14
34N	Manguito SNS® PP // SNS® coupling	90 – 110	17
35N	Manguito SNS® c/b PP, salida PE // SNS® coupling w/f, PE outlet	90 – 110	17
36N	Tapón SNS® PP // SNS® cap	50 – 200	19
37N	Tapón SNS® c/b PP, salida PE // SNS® cap w/f, PE outlet	63 – 225	20
38N	Brida transición SNS® PP // SNS® transition flange	90 – 160	22
39N	Te corta r/h SNS® “Air” PVC-U // “Air” SNS® 90° female threaded short tee	90-2” – 110-2”	15
40N	Te corta r/h SNS® “Air L” PVC-U // “Air L” SNS® 90° female threaded short tee	90-2” – 110-2”	15
41N	Cruz 90° SNS® PVC-U // 90° Cross SNS®	90 – 200	17
42N	Te doble SNS® salida r/h PVC-U // SNS® female threaded double tee	90-2” – 110-2”	16
43N	Te doble SNS® salida encolar PVC-U // SNS® solvent socket outlet double tee	90-63 – 110-63	16
44N	Cruz 90° SNS® PP // 90° Cross SNS®	90 – 200	17

ITEM	DESCRIPCIÓN / DESCRIPTION	DIÁMETRO / DIAMETER	PAG.
45N	Te doble "Air" SNS® salida r/h PVC-U // "Air" SNS® female threaded double tee	90-2" – 110-2"	16
46N	Te doble "Air" SNS® salida enc. PVC-U // "Air" SNS® solvent socket outlet double tee	90-63 – 110-63	16
47N	Te corta r/h SNS® "Air L" PPFV // "Air L" SNS® 90° female threaded short tee	90-2" – 110-2"	15
48N	Te corta r/h SNS® "Air" PPFV // "Air" SNS® 90° female threaded short tee	90-2" – 110-2"	15
49N	Te doble SNS® salida r/h PPFV // SNS® female threaded double tee	90-2" – 110-2"	16
50N	Te corta r/h SNS® // SNS® female threaded short tee	63-1 1/2" – 110-2"	15
51N	Te corta encolar SNS® // SNS® solvent socket short tee	90-63 – 110-63	15
52N	Reducción cónica SNS® // SNS® conical reduction	110-90 – 125-110	18
53N	Te corta r/h SNS® PPFV // SNS® female threaded short tee	63-1 1/2" – 110-2"	15
54N	Reducción cónica SNS® PPFV // SNS® conical reduction	110-90 – 125-110	18
55N	Codo 90° SNS® "Air" salida encolar // "Air" SNS® 90° elbow s/socket outlet	90-200 – 25-63	11
56N	Codo 90° SNS® "Air" c/b salida encolar // "Air" SNS® 90° elbow w/f s/socket outlet	90-200 – 25-63	12
57N	Te doble "Air" SNS® salida r/h PPFV // "Air" SNS® female threaded double tee	90-2" – 110-2"	16
60N	Codo 90° SNS® "Air L" sal. r/h // "Air L" SNS® 90° elbow	90-3/4" – 110-1"	12
61N	Codo 90° SNS® "Air L" sal. r/h c/b // "Air L" SNS® 90° elbow w/f	90-3/4" – 110-1"	12
62N	Codo 90° SNS® "Air L" salida r/h // "Air L" SNS® 90° elbow	90-3/4" – 110-1"	12
63N	Codo 90° SNS® "Air L" r/h c/b, salida PE // "Air L" SNS® 90° elbow w/f, PE outlet	90-3/4" – 110-1"	13
64N	Te SNS® visor portasondas R/H // Electrodes holder sight glass SNS® tee f/t	50 – 90	17
65N	Conexión SNS® con junta elástica // SNS® rubber ring adaptor	160 – 200	20
66N	Conexión encolar SNS® BS // SNS® adaptor BS	2" – 8"	20
67N	Conexión encolar SNS® ANSI // SNS® adaptor ANSI	63 – 200	21
68N	Conexión espiga // Spigot connection	2" – 3"	23
69N	Portabridas salida SNS® con válvula de bola // SNS® ball valve outlet	63 – 125	22

NORMAS GENERALES DE VENTA

Las especificaciones de venta contenidas en este documento son referentes a cualquier pedido. Las modificaciones deben contar con la aceptación de Hidroten, S.A. por escrito.

Las especificaciones y tarifas pueden revisarse en cualquier momento, para la totalidad o parcialidad de las operaciones cursadas en la fecha de revisión.

Pedidos: Los pedidos se realizarán por escrito, en el que figurarán referencias y especificaciones contenidas en la tarifa oficial de Hidroten, S.A. y manteniendo las cantidades que en ella figuran.

Entrega: La fecha de salida de los pedidos de nuestros almacenes fijará la fecha de entrega.

Los pedidos podrán ser suministrados, en parte, sin que ello suponga la anulación de los mismos.

Precios: Los precios indicados en la tarifa de Hidroten, S.A. son franco fábrica, incluyen los embalajes, siendo por cuenta del comprador otros gastos como impuestos o arbitrios.

Las facturas se realizarán a la entrega de los pedidos con los precios vigentes en la fecha de salida.

Transporte: El transporte de mercancías es responsabilidad total del comprador, aún en aquellos casos en que se realice a portes pagados.

Otros gastos no especificados en nuestra tarifa (embalajes marítimos, avión, etc) irán a cuenta del comprador.

Garantía: Los productos Hidroten, S.A. están garantizados por un año desde la fecha

de salida de mercancía, contra cualquier problema que pudiera surgir por un defecto de fabricación. Nuestra garantía única y exclusivamente comprende la reparación o sustitución en nuestras instalaciones de las piezas defectuosas, no atendiendo a indemnizaciones ni a otros gastos. La garantía no será válida cuando los defectos sean consecuencia de un trato incorrecto o bien que hayan sido manipulados, reparados o modificados fuera de nuestras instalaciones, igualmente, la garantía no será válida cuando el producto haya sido instalado con materiales o métodos fuera de NORMAS.

La garantía de nuestros materiales queda limitada a la reposición del producto, modelo o pieza que sea reconocida como defectuosa.

Los gastos ocasionados por la devolución y reenvío van a cuenta del comprador.

Pago: Todos los pagos serán efectuados al contado, excepto en aquellos casos en que haya un convenio escrito. Las modificaciones en el vencimiento del pago, en la forma o en la fecha, deberán contar con nuestra autorización por escrito.

Cualquier gasto, impuesto o tasa efectivo a partir del pedido irá por cuenta del comprador.

El comprador reembolsará al vendedor en concepto de daños y perjuicios las cargas bancarias y judiciales devengables a causa de la devolución de efectos impagados.

Reclamaciones y devoluciones: No se admitirán devoluciones ni reclamaciones después de 10 días de la recepción del pedido. Si la reclamación es aceptada por Hidroten, S.A., deberá remitir el material perfectamente embalado, siendo a cargo del comprador los costos de envío. Así como

se aplicará un incremento de un 10% en concepto de manipulación. Los abonos de devoluciones admitidas se deducirán de próximas facturas, tras su anotación en cuenta.

Anulación: Hidroten, S.A. se reserva el derecho de anular o rescindir cualquier acción de venta en caso de no cumplirse cualquiera de las condiciones expuestas en este documento, así como en situaciones de impago, total o parcial, de un pedido, o retraso en el pago de un pedido anterior, así como en el caso de emprender contra el comprador procedimientos ejecutivos o éste se declarara en suspensión de pagos o quiebra.

Reserva de propiedad: Los materiales suministrados serán propiedad de Hidroten, S.A. hasta que no se haya realizado el pago de los mismos.

Hidroten, S.A. se reserva el derecho de retirar la mercancía, total o parcialmente, del domicilio del comprador, si este no hace efectivo algún pago.

Competencia judicial: Para resolver las cuestiones que puedan derivarse de la aplicación de estas normas, tanto Hidroten, S.A. como el comprador, convienen en someterse a los Juzgados y Tribunales de Alicante, renunciando a su propio fuero si fuese otro.

El contenido de este documento y las características de nuestros productos, puede ser modificado total o parcialmente sin previo aviso por Hidroten, S.A.

Sales Terms

The specifications contained in this document are applicable to any order. Any modifications will require the written acceptance of Hidrotén S.A. The specifications and rates may be revised at any time with respect to all or any of the orders in progress at the date of revision.

Orders: Orders must be placed in writing and indicate the references and specifications contained in the official price list of Hidrotén S.A., maintaining the amounts shown therein.

Delivery: The date of despatch of the orders from our warehouses will be the date of delivery. Orders may be partly filled without this implying their cancellation.

Prices: The prices shown on the price list of Hidrotén S.A. include packaging; any other expenses, such as taxes or local assessments, will be for the account of the purchaser. Invoices will be issued upon delivery at the prices applicable on the date of despatch.

Transport: The transport of goods is the entire responsibility of the purchaser, even in those cases in which it is carried out on a carriage paid basis. Other expenses not specified in our price list (packing for transport by sea or air, etc.) shall be for the account of the purchaser.

Warranty: Hidrotén S.A.'s products are warranted for one year from the date of despatch of the goods against any problem deriving from a defect of manufacture. The warranty of our materials is limited to the

replacement of the product, model or component recognized as defective. The expenses of return and reshipment shall be for the account of the purchaser.

Payment: All payments shall be made in cash, except in those cases in which a written agreement exists. Modifications in the term of payment, or in the form or date thereof, must have our written authorization. Any expense, tax or local levy applicable after the order has been placed shall be for the account of the purchaser.

The purchaser shall reimburse to the seller by way of damages any bank and judicial charges incurred as a result of the return of dishonoured drafts.

Claims and returns: No returns or claims shall be admitted after 10 days from the receipt of your order. If your claim is accepted by Hidrotén S.A. you should send us the defective material properly packed, the expenses of shipment being for your account.

If a return is not approved by Hidrotén S.A., any risk or expenses shall be for the account of the purchaser. A 10% handling cost will be applicable.

Cancellation: Hidrotén, S.A. reserves the right to cancel or terminate any sales operation in the event that any of the conditions set out herein is not fulfilled, as well as in the event of non-payment, in whole or in part, of any order or any delay in payment of any previous order, or if it is necessary to bring executive proceedings against the purchaser or if the purchaser is declared in suspension of payments or bankruptcy.

Reservation of the title: The materials supplied shall remain the property of Hidrotén S.A. until they have been paid for.

Hidrotén S.A. reserves the right to remove the goods, in whole or in part, from the premises of the purchaser if the purchaser fails to make any payment.

Competent jurisdiction: For the settlement of any disputes that may arise in connection with the application of these conditions, both Hidrotén S.A. and the purchaser agree to submit to the Courts and Tribunals of Alicante, waiving their right to any other jurisdiction to which they may be entitled.

The contents of this document and the specifications of our products may be modified, in whole or in part, by Hidrotén S.A. without prior notice.

Conditions générales de vente

Les conditions générales de vente (CGV) décrites ci-après s'appliquent à toute les commandes. Toute modification doit être faite par écrit et doit être soumise à l'approbation d'Hidrotén S.A. Hidrotén S.A. s'accorde le droit de modifier ses tarifs à tout moment. Toutefois, elle s'engage à facturer les marchandises commandées aux prix indiqués lors de l'enregistrement de la commande.

Commandes: Les commandes se réaliseront par écrit, en y indiquant les références et les spécifications contenues dans la liste de prix officielle d'Hidrotén, S.A. et devront maintenir les quantités indiquées.

Livraison: La date de sortie des commandes de nos magasins fixera la date de livraison. Les commandes pourront être fournies partiellement, sans que cela représente leur annulation.

Prix: Les prix indiqués dans la liste d'Hidrotén, S.A. sont franc fabrique, et incluent les emballages. Les autres frais, tels qu'impôts ou taxes, sont au compte de l'acheteur. Les factures seront dressées au moment de la livraison des commandes avec les prix en vigueur à la date de sortie.

Transport: Le transport de marchandises est sous la totale responsabilité de l'acheteur, même dans le cas du transport à port payé. Les autres frais non spécifiés dans notre liste (emballages maritimes, avion, etc.) seront au compte de l'acheteur.

Garantie: Les produits Hidrotén, S.A. sont garantis pour un an à partir de la date de sortie de la

merchandise, contre quel que soit le problème qui puisse apparaître par suite d'un défaut de fabrication.

Notre garantie comprend uniquement et exclusivement la réparation ou la substitution dans nos fabriques des pièces défectueuses, et n'assume pas ni indemnisations ni autres dépenses.

La garantie ne sera pas valide quand les défauts seront la conséquence d'une utilisation incorrecte ou quand les produits auront été manipulés, réparés ou modifiés hors de nos usines. Également, la garantie ne sera pas valide quand le produit aura été installé avec des matériaux ou méthodes hors des NORMES.

La garantie de nos matériaux reste limitée au remplacement du produit, du modèle ou de la pièce reconnu comme défectueux.

Les frais engagés par le retour et la restitution sont au compte de l'acheteur.

Paiement: Tous les paiements se feront au comptant, sauf dans le cas qu'il y ait un accord écrit.

Les modifications d'échéance de paiement, de modalité ou de la date devront avoir notre autorisation par écrit.

Tous les frais, taxes ou impôts effectifs à partir du moment de la commande seront au compte de l'acheteur.

L'acheteur remboursera au vendeur à titre de dommages et intérêts les charges bancaires et judiciaires produites à cause du retour d'effets impayés.

Réclamations et retours: Ne seront pas admis les réclamations ni les retours faits 10 jours après

la réception de la commande. Si la réclamation est acceptée par Hidrotén, S.A. l'acheteur devra renvoyer le matériel parfaitement emballé et les frais de renvoi seront à son compte.

De sorte nous appliquerons un accroissement d'un 10% de manipulation.

Annulation: Hidrotén, S.A. se réserve le droit d'annuler ou rescinder tout acte de vente dans le cas de ne pas accomplir quelque condition exposée dans ce document, ainsi que dans le cas de non-paiement, total ou partiel, d'une commande ou de délais dans le paiement d'une commande antérieure, ainsi que dans le cas d'entreprendre contre l'acheteur des procédures exécutoires ou que celui-ci se déclare en cessation de paiements ou en faillite.

Réserve de propriété: Les matériaux fournis seront propriété d'Hidrotén, S.A. jusqu'au moment du paiement. Hidrotén S.A. se réserve le droit de retirer la marchandise, totalement ou partiellement, du domicile de l'acheteur si l'un des paiements n'est pas réalisé.

Compétence judiciaire: Pour résoudre les questions qui peuvent se dériver de l'application de ces normes, tant Hidrotén comme l'acheteur, s'engage à se soumettre au Tribunal d'Alicante, et renonce à leur propre juridiction si elle en était différente.

Le contenu de ce document et les caractéristiques de nos produits peuvent être modifiés totalement ou partiellement sans avis préalable par Hidrotén, S.A.



Accesorios presión Netvite System®
 Visor de líquidos Netvite System®
 Válvulas de mariposa Netvite System®
 Válvulas de aspiración Netwell®
 Válvulas de retención lineal Netvite System®
 Filtros Netvite System®
 Hidrantes Netvite System®



Netvite System® pressure fittings
Netvite System® Fluids display
Netvite System® Butterfly valves
Netwell®, Foot valves
Netvite System® lineal check valves
Netvite System® Filters
Netvite System® Hydrants



Raccords pression Netvite System®
 Voyant de contrôle Netvite System®
 Vannes à papillon Netvite System®
 Clapets crépine Netwell®
 Clapet anti-retour linéaire Netvite System®
 Filtres Netvite System®
 Extincteurs Netvite System®

SNS®

HIDROTEN, S.A.

Pol. Ind. Plá Vallonga, c/ Agua, 28
 03006 ALICANTE (España)
 Tel. 965 11 42 82
 Fax: 965 11 48 62

INTERNACIONALES

Tel. +34 965 11 42 82
 Fax: + 34 965 11 48 62
 Tel. Información Técnica: +34 966 105 888

www.hidroten.es

e-mails:

comercial@hidroten.es
export@hidroten.es
administracion@hidroten.es
tecnico@hidroten.es
publicidad@hidroten.es
prescripcion@hidroten.es



¡Síguenos en redes sociales!

