

# CATÁLOGO 2021

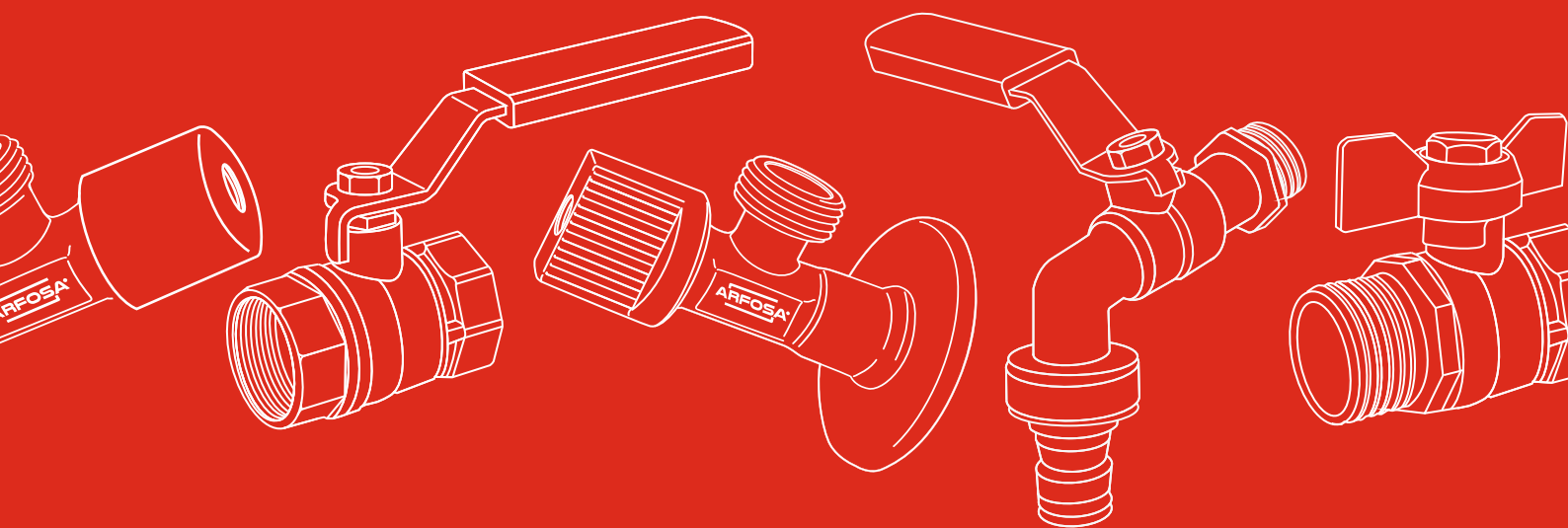

**ARFOSA®**



## La Compañía

Grifos y Válvulas, S.L. es una compañía dedicada a la fabricación, importación y comercialización de valvulería, bajo la marca ARFOSA.

Nuestra empresa ubicada en Burriana (Castellón), apuesta por la innovación y mejora adaptando su gama a las necesidades del cliente.

Nuestro catálogo constantemente actualizado, ofrece una variedad de productos con una excelente calidad-precio, lo que nos posiciona como una de las mejores marcas del mercado en la actualidad.

## The Company

*Grifos y Valvulas,sl based in Burriana (Castellón) Spain, is a company dedicated to the manufacturing and the distribution of all types of valves, under the band ARFOSA.*

*We are committed to constant innovation and improvement by expanding and adapting our products range to meet market needs.*

*Our regularly updated catalog offers a variety of products with an excellent quality-price ratio, positioning us as one of the best brands in the today's market.*



PRODUCCIÓN



ESTACIÓN COMPROBADO



ALMACÉN STOCK



FABRICACIÓN HOMOLOGADA



ESTACIÓN ENSAMBLADO



24H SERVICIO

# Nuestro Producto

Dedicamos un gran esfuerzo a asegurar la calidad de todos los productos, fabricados bajo nuestro estándar de calidad más riguroso. Buscando siempre la excelencia y la total satisfacción de nuestros clientes.

Nuestra calidad, el impecable servicio post-venta y la atención al cliente en todo momento, nos permiten mantener un crecimiento constante, con el fin de ser su proveedor de confianza .

# Our Product

We are dedicated to the quality of our products, which are manufactured under our rigorous quality standards. We are always striving for the excellence in our products and the satisfaction of our customers.

Our quality together with our impeccable post-sales customer service, always attentive to our customers feedback and needs, allow us to be a trusted and reliable provider.

 DESCARGUE NUESTRAS FICHAS TÉCNICAS EN:  
 DOWNLOAD OUR TECHNICAL SHEET:  
[www.arfosa.es](http://www.arfosa.es)

# Certificados / Certificates



CE

ISO



# VÁLVULAS DE ESFERA

## BALL VALVES

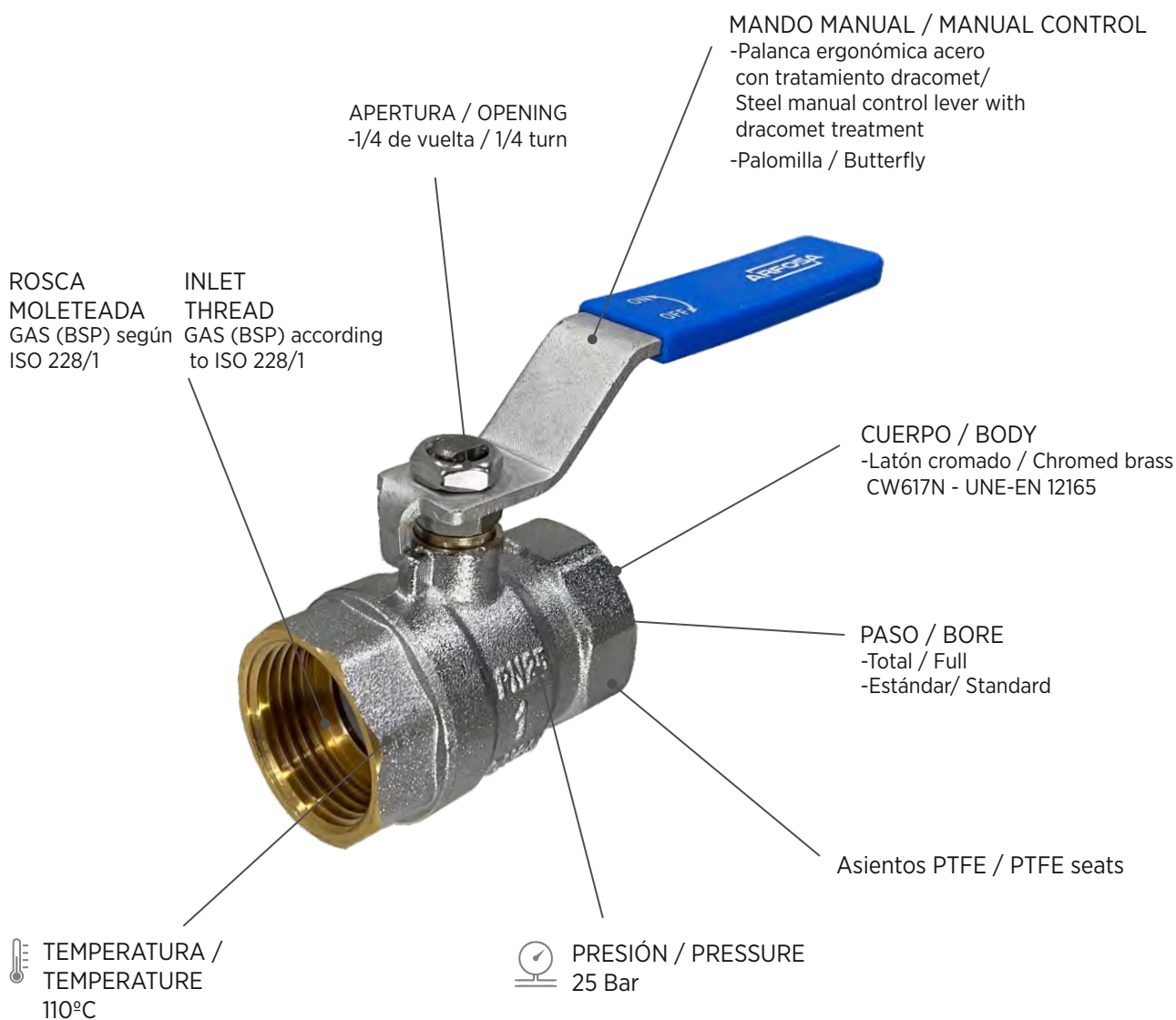

### MARCADO



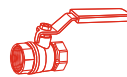

REF. AR100-HH

SERIE LIGERA

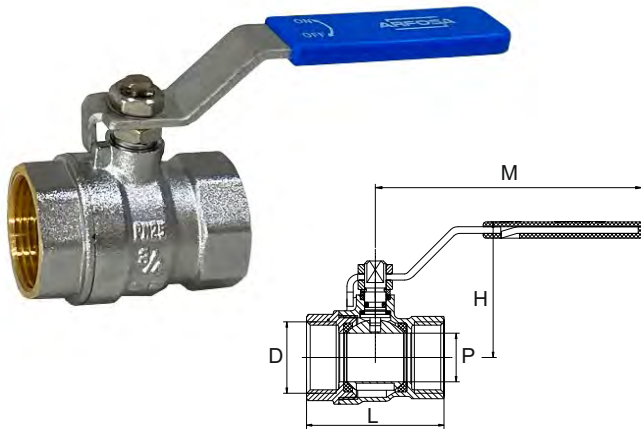

VÁLVULA DE ESFERA PN25 H-H PASO ESTÁNDAR  
MANDO PALANCA ERGONÓMICO

BALL VALVE PN25 H-H STANDARD BORE  
ERGONOMIC MANUAL CONTROL LEVER

- |                                 |  |
|---------------------------------|--|
| -PN25                           | -PN25                                  |
| -Paso estándar                  | -Standard bore                         |
| -Palanca ergonómica color azul  | -Steel manual control lever color blue |
| -Cuerpo de latón CW617N cromado | -Body chromed brass CW617N             |
| UNE-EN 228/1                    | UNE-EN 228/1                           |
| -Asientos de PTFE               | -PTFE seats                            |
| -Rosca de entrada gas (BSP)     | -Inlet thread gas (BSP) according      |
| según ISO 228/1                 | to ISO 228/1                           |

Ref.	D	Peso			€
AR100-12HH	1/2" HH	130g	8	96	3,06
AR100-34HH	3/4" HH	205g	6	72	4,44
AR100-1HH	1" HH	330g	4	48	6,91
AR100-114HH	1¼" HH	435g	6	36	9,57
AR100-112HH	1½" HH	751g	4	16	15,38
AR100-2HH	2" HH	1050g	2	16	22,55
AR100-212HH	2½" HH	1906g	2	16	46,75
AR100-3HH	3" HH	3118g	1	4	77,11
AR100-4HH	4" HH	4815g	1	4	119,90

D	L	M	P	H	EAN
1/2" HH	43,5	98	13	47	8436591570561
3/4" HH	52	98	18	50	8436591570608
1" HH	60,4	116	22	57	8436591570646
1¼" HH	70,2	115	27	60,5	8436591570684
1½" HH	80,5	157	34	70	8436591570707
2" HH	93	155,5	42,5	76	8436591570721
2½" HH	118	173	52	85	8436591570745
3" HH	137	238,5	65	110	8436591570752
4" HH	162,5	238,5	79	121	8436591570769

REF. AR100-MH

SERIE LIGERA

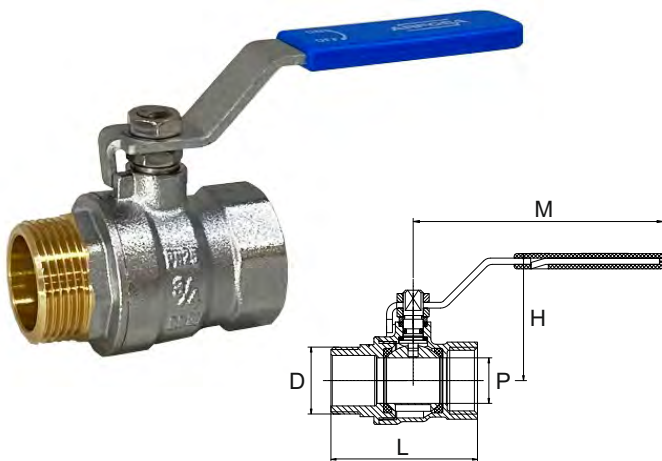

VÁLVULA DE ESFERA PN25 M-H PASO ESTÁNDAR  
MANDO PALANCA ERGONÓMICO

BALL VALVE PN25 M-H STANDARD BORE  
ERGONOMIC MANUAL CONTROL LEVER

- |                                 |  |
|---------------------------------|--|
| -PN25                           | -PN25                                  |
| -Paso estándar                  | -Standard bore                         |
| -Palanca ergonómica color azul  | -Steel manual control lever color blue |
| -Cuerpo de latón CW617N cromado | -Body chromed brass CW617N             |
| UNE-EN 228/1                    | UNE-EN 228/1                           |
| -Asientos de PTFE               | -PTFE seats                            |
| -Rosca de entrada gas (BSP)     | -Inlet thread gas (BSP) according      |
| según ISO 228/1                 | to ISO 228/1                           |

Ref.	D	Peso			€
AR100-12MH	1/2" MH	140g	8	96	3,19
AR100-34MH	3/4" MH	220g	6	72	4,77
AR100-1MH	1" MH	346g	4	48	7,17
AR100-114MH	1¼" MH	468g	6	36	9,88
AR100-112MH	1½" MH	765g	4	16	15,95
AR100-2MH	2" MH	1071g	2	16	22,99

D	L	M	P	H	EAN
1/2" MH	50	98	13	47	8436591570578
3/4" MH	58,5	98	18	50	8436591570615
1" MH	68	116	22	57	8436591570653
1¼" MH	78	115	27	60,5	8436591570691
1½" MH	85,5	157	34	70	8436591570714
2" MH	98,5	155,5	42,5	76	8436591570738

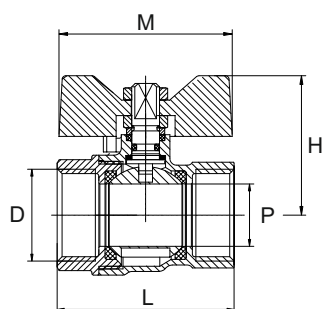
**REF. AR101-HH**
**SERIE LIGERA**

Ref.	D	Peso			€
AR101-12HH	1/2" HH	110g	8	96	3,06
AR101-34HH	3/4" HH	183g	6	72	4,44
AR101-1HH	1" HH	286g	8	96	6,91

D	L	M	P	H	EAN
1/2" HH	43,5	50	13	36,5	8436591570585
3/4" HH	52	50	18	39,5	8436591570622
1" HH	60,4	62	22	44,5	8436591570660

**VÁLVULA DE ESFERA PN25 H-H PASO ESTÁNDAR  
MANDO PALOMILLA**
**BALL VALVE PN25 H-H STANDARD BORE  
BUTTERFLY HANDLE**

- |                                 |  |
|---------------------------------|--|
| -PN25                           | -PN25  |
| -Paso estándar                  | -Standard bore                                 |
| -Mando palomilla aluminio       | -Aluminium butterfly handle                    |
| -Cuerpo de latón CW617N cromado | -Body chromed brass CW617N                     |
| UNE-EN 228/1                    | UNE-EN 228/1                                   |
| -Asientos de PTFE               | -PTFE seats                                    |
| -Rosca de entrada gas (BSP)     | -Inlet thread gas (BSP) according to ISO 228/1 |
| según ISO 228/1                 |  |

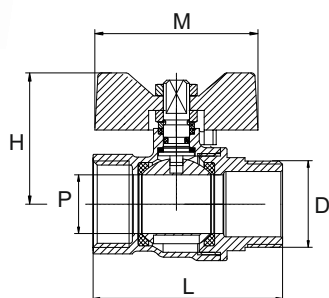
**REF. AR101-MH**
**SERIE LIGERA**

Ref.	D	Peso			€
AR101-12MH	1/2" MH	118g	8	96	3,19
AR101-34MH	3/4" MH	191g	6	72	4,77
AR101-1MH	1" MH	300g	4	48	7,17

D	L	M	P	H	EAN
1/2" MH	50	50	13	36,5	8436591570592
3/4" MH	58,5	50	18	39,5	8436591570639
1" MH	68	62	22	44,5	8436591570677

**VÁLVULA DE ESFERA PN25 M-H PASO ESTÁNDAR  
MANDO PALOMILLA**
**BALL VALVE PN25 M-H STANDARD BORE  
BUTTERFLY HANDLE**

- |                                 |  |
|---------------------------------|--|
| -PN25                           | -PN25  |
| -Paso estándar                  | -Standard bore                                 |
| -Mando palomilla aluminio       | -Aluminium butterfly handle                    |
| -Cuerpo de latón CW617N cromado | -Body chromed brass CW617N                     |
| UNE-EN 228/1                    | UNE-EN 228/1                                   |
| -Asientos de PTFE               | -PTFE seats                                    |
| -Rosca de entrada gas (BSP)     | -Inlet thread gas (BSP) according to ISO 228/1 |
| según ISO 228/1                 |  |



## REF. AR200-HH

## SERIE PASO TOTAL

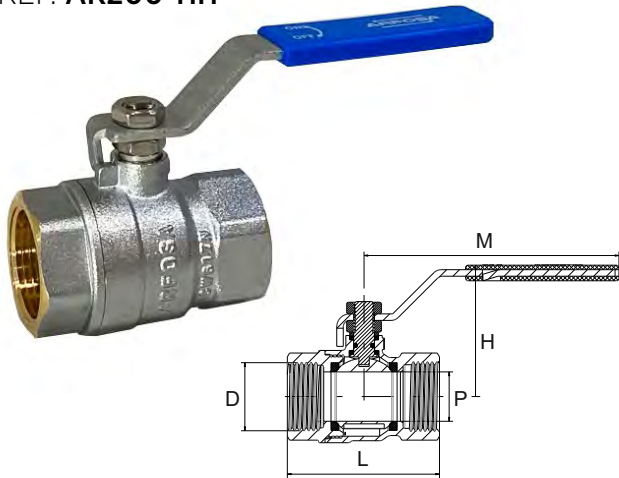

### VÁLVULA DE ESFERA PN25 H-H PASO TOTAL MANDO PALANCA ERGONOMICO

BALL VALVE PN25 H-H FULL BORE  
ERGONOMIC MANUAL CONTROL LEVER

- |                                 |  |
|---------------------------------|--|
| -PN25                           | -PN25                                  |
| -Paso total                     | -Full bore                             |
| -Palanca ergonómica color azul  | -Steel manual control lever color blue |
| -Cuerpo de latón CW617N cromado | -Body chromed brass CW617N             |
| UNE-EN 228/1                    | UNE-EN 228/1                           |
| -Asientos de PTFE               | -PTFE seats                            |
| -Rosca de entrada gas (BSP)     | -Inlet thread gas (BSP) according      |
| según ISO 228/1                 | to ISO 228/1                           |

Ref.	D	Peso			€
AR200-12HH	1/2" HH	159,2g	8	96	3,45
AR200-34HH	3/4" HH	245g	6	72	5,68
AR200-1HH	1" HH	387,7g	4	48	8,47
AR200-114HH	1¼" HH	634g	6	24	13,75
AR200-112HH	1½" HH	867,4g	4	16	18,81
AR200-2HH	2" HH	1295,3g	2	18	29,15
AR200-212HH	2½" HH	2481g	2	8	54,89
AR200-3HH	3" HH	3936g	1	6	86,90
AR200-4HH	4" HH	5991g	1	4	131,89

D	L	M	P	H	EAN
1/2" HH	48	98	14	47	8436591570776
3/4" HH	58,5	98	19	51	8436591570813
1" HH	67	115	24	58	8436591570851
1¼" HH	79,5	155,5	30	66	8436591570899
1½" HH	88,5	155,5	37	72	8436591570912
2" HH	104	173	46,5	81	8436591570936
2½" HH	137	173	58,5	90	8436591570950
3" HH	157	238,5	72	116	8436591570967
4" HH	182	238,5	90	129	8436591570974

## REF. AR200-MH

## SERIE PASO TOTAL

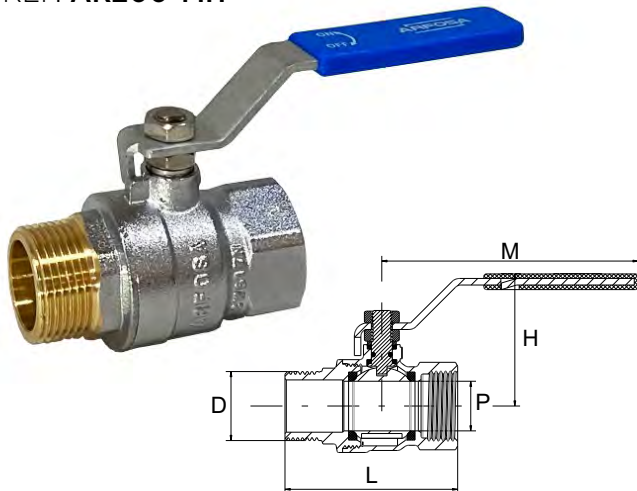

### VÁLVULA DE ESFERA PN25 M-H PASO TOTAL MANDO PALANCA ERGONOMICO

BALL VALVE PN25 M-H FULL BORE  
ERGONOMIC MANUAL CONTROL LEVER

- |                                 |  |
|---------------------------------|--|
| -PN25                           | -PN25                                  |
| -Paso total                     | -Full bore                             |
| -Palanca ergonómica color azul  | -Steel manual control lever color blue |
| -Cuerpo de latón CW617N cromado | -Body chromed brass CW617N             |
| UNE-EN 228/1                    | UNE-EN 228/1                           |
| -Asientos de PTFE               | -PTFE seats                            |
| -Rosca de entrada gas (BSP)     | -Inlet thread gas (BSP) according      |
| según ISO 228/1                 | to ISO 228/1                           |

Ref.	D	Peso			€
AR200-12MH	1/2" MH	165g	8	96	3,61
AR200-34MH	3/4" MH	253g	6	72	6,01
AR200-1MH	1" MH	406g	4	48	8,78
AR200-114MH	1¼" MH	668,3g	6	24	14,30
AR200-112MH	1½" MH	880,8g	4	16	19,25
AR200-2MH	2" MH	1308,3g	2	18	29,59

D	L	M	P	H	EAN
1/2" MH	54	98	14	47	8436591570783
3/4" MH	66	98	19	51	8436591570820
1" MH	75	115	24	58	8436591570868
1¼" MH	87,5	155,5	30	66	8436591570905
1½" MH	94,5	155,5	37	72	8436591570929
2" MH	108,5	173	46,5	81	8436591570943

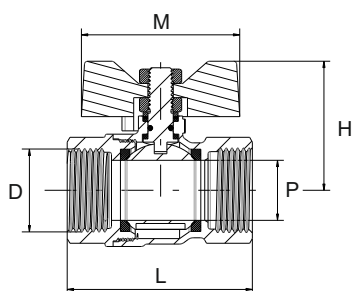
**REF. AR201-HH**
**SERIE PASO TOTAL**

Ref.	D	Peso			€
AR201-12HH	1/2" HH	135,1g	8	96	3,45
AR201-34HH	3/4" HH	220,9g	6	72	5,68
AR201-1HH	1" HH	343g	4	48	8,47

D	L	M	P	H	EAN
1/2" HH	48	50	14	37	8436591570790
3/4" HH	58,5	50	19	41	8436591570837
1" HH	67	62	24	46	8436591570875

**VÁLVULA DE ESFERA PN25 H-H PASO TOTAL  
MANDO PALOMILLA**
**BALL VALVE PN25 H-H FULL BORE  
BUTTERFLY HANDLE**

- |   |   |
|---|---|
| -PN25   | -PN25   |
| -Paso total                                     | -Full bore  |
| -Mando palomilla aluminio                       | -Aluminium butterfly handle                       |
| -Cuerpo de latón CW617N cromado<br>UNE-EN 228/1 | -Body chromed brass CW617N<br>UNE-EN 228/1        |
| -Asientos de PTFE                               | -PTFE seats                                       |
| -Rosca de entrada gas (BSP)<br>según ISO 228/1  | -Inlet thread gas (BSP) according<br>to ISO 228/1 |

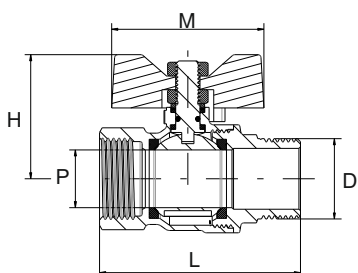
**REF. AR201-MH**
**SERIE PASO TOTAL**

Ref.	D	Peso			€
AR201-12MH	1/2" MH	141,8g	8	96	3,61
AR201-34MH	3/4" MH	229,6g	6	72	6,01
AR201-1MH	1" MH	263,5g	4	48	8,78

D	L	M	P	H	EAN
1/2" MH	54	50	14	37	8436591570806
3/4" MH	66	50	19	41	8436591570844
1" MH	75	62	24	46	8436591570882

**VÁLVULA DE ESFERA PN25 M-H PASO TOTAL  
MANDO PALOMILLA**
**BALL VALVE PN25 M-H FULL BORE  
BUTTERFLY HANDLE**

- |   |   |
|---|---|
| -PN25   | -PN25   |
| -Paso total                                     | -Full bore  |
| -Mando palomilla aluminio                       | -Aluminium butterfly handle                       |
| -Cuerpo de latón CW617N cromado<br>UNE-EN 228/1 | -Body chromed brass CW617N<br>UNE-EN 228/1        |
| -Asientos de PTFE                               | -PTFE seats                                       |
| -Rosca de entrada gas (BSP)<br>según ISO 228/1  | -Inlet thread gas (BSP) according<br>to ISO 228/1 |



# VÁLVULAS CLICK-CLACK

## CLICK-CLACK WASTES

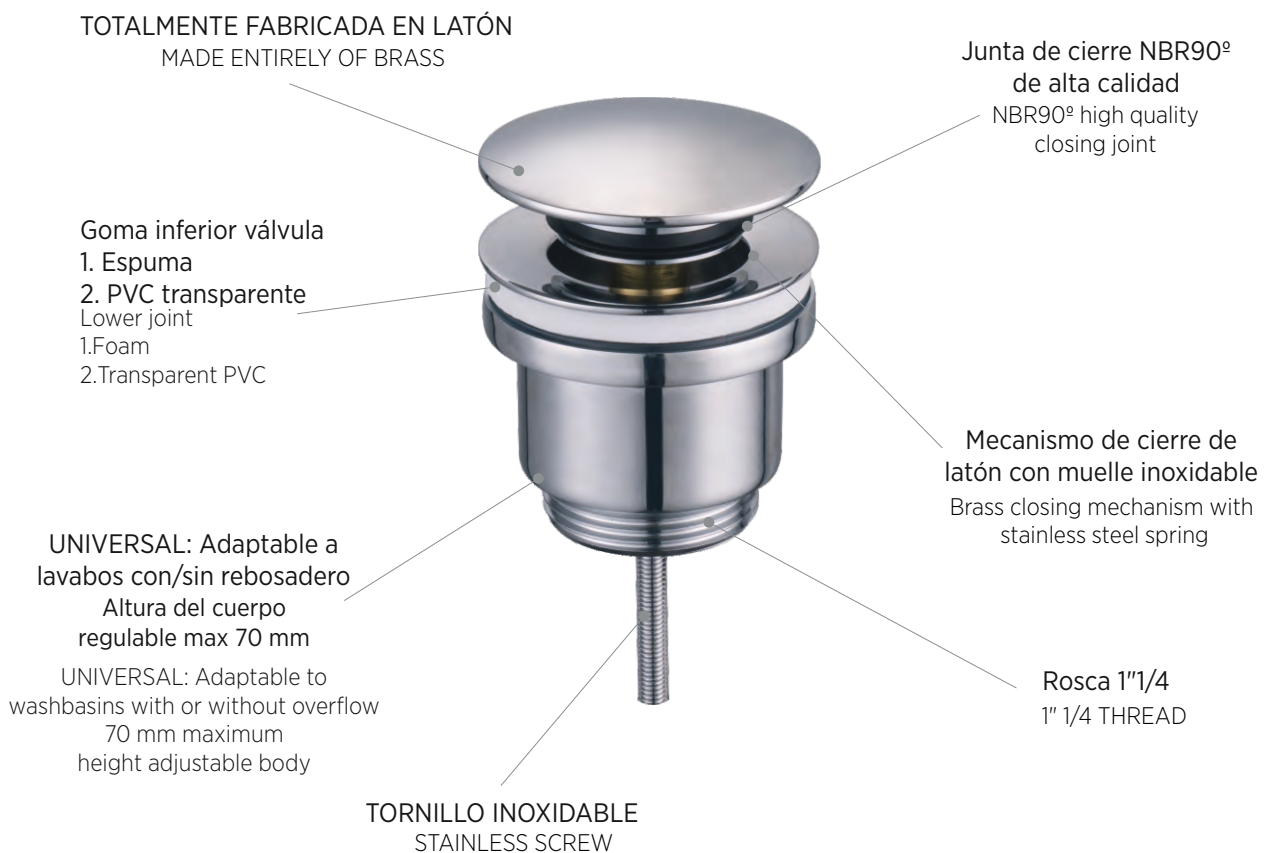

REF. AR019

VÁLVULA CLICK CLACK

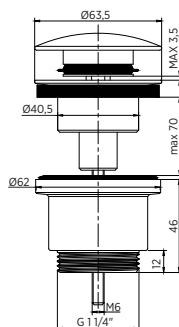

Ref.			€
AR019	1	50	10,75

Latón cromado  
Tapón exterior Ø63  
Junta de cierre NBR90°  
Universal, adaptable a lavabos  
con o sin rebosadero

Chromed brass  
Ø63 big external plug  
NBR90° closing joint  
Universal, adaptable to  
washbasin with o without overflow

EAN 8436591570530

# GRIFOS DE ESFERA DE JARDÍN

## BALL BIBCOCK GARDEN

### MANDO MANUAL / MANUAL CONTROL

- Palanca ergonómica acero con tratamiento dracomet/ Steel manual control lever with dracomet treatment
- Palomilla / Butterfly

### APERTURA / OPENING

- 1/4 de vuelta / 1/4 turn

ROSCA MOLETEADA  
GAS (BSP) según ISO 228/1

INLET THREAD  
GAS (BSP) according to ISO 228/1

PASO / BORE  
-Total / Full  
-Estándar / Standard

Asientos PTFE / PTFE seats  
Asientos de PTFE / PTFE seats

TEMPERATURA / TEMPERATURE  
100°C

Fabricación un solo cuerpo/  
Single body manufacturing

CUERPO / BODY  
-Latón cromado / Chromed brass  
CW617N - UNE-EN 12165

PRESIÓN / PRESSURE  
16 Bar





### CIERRE PRECINTABLE DE SEGURIDAD SECURITY LOCKING SYSTEM

Tanto en posición de apertura como de cierre  
Opening and closing position

REF. AR300

SERIE PASO TOTAL



Ref.	D	d	Peso			€
AR300-1234	1/2"	3/4"	162g	10	90	3,98
AR300-341	3/4"	1"	216g	6	54	5,21

D	d	L	M	P	H	EAN
1/2"	3/4"	85	89	10	88	8436591570981
3/4"	1"	95	89	12	95	8436591570998

**GRIFO DE ESFERA PARA MANGUERA PN16 PASO TOTAL  
MANDO PALANCA ERGONÓMICO**

BIBCOCK BALL VALVE PN16 FULL BORE  
ERGONOMIC MANUAL CONTROL LEVER

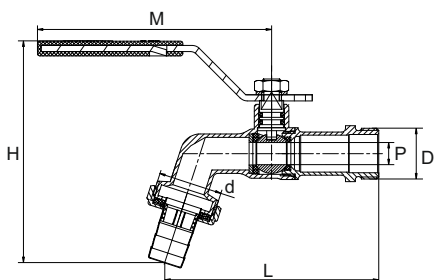



- PN16
  - Paso total
  - Palanca ergonómica color azul
  - Cuerpo de latón CW617N cromado UNE-EN 228/1
  - Cierre de seguridad
  - Asientos de PTFE
  - Rosca de entrada gas (BSP) según ISO 228/1
- PN16
  - Full bore
  - Steel manual control lever color blue
  - Body chromed brass CW617N UNE-EN 228/1
  - PTFE seats
  - Safety lock system
  - Inlet thread gas (BSP) according to ISO 228/1

REF. AR301

SERIE PASO TOTAL



Ref.	D	d	Peso			€
AR301-1234	1/2"	3/4"	134g	10	90	3,98
AR301-341	3/4"	1"	187g	6	54	5,21

D	d	L	M	P	H	EAN
1/2"	3/4"	85	50	10	82	8436591571032
3/4"	1"	95	50	12	88	8436591571049

**GRIFO DE ESFERA PARA MANGUERA PN16 PASO TOTAL  
MANDO PALOMILLA**

BIBCOCK BALL VALVE PN16 FULL BORE  
BUTTERFLY CONTROL

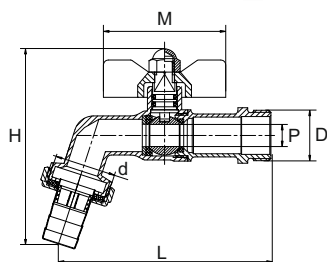

- PN16
  - Paso total
  - Mando palomilla aluminio
  - Cuerpo de latón CW617N cromado UNE-EN 228/1
  - Cierre de seguridad
  - Asientos de PTFE
  - Rosca de entrada gas (BSP) según ISO 228/1
- PN16
  - Full bore
  - Aluminium butterfly handle
  - Body chromed brass CW617N UNE-EN 228/1
  - PTFE seats
  - Safety lock system
  - Inlet thread gas (BSP) according to ISO 228/1

REF. AR400

SERIE LIGERA



Ref.	D	d	Peso			€
AR400-1212	1/2"	1/2"	162g	10	90	3,94
AR400-3434	3/4"	3/4"	170g	6	54	4,30

D	d	L	M	P	H	EAN
1/2"	1/2"	85	89	9,5	88	8436591571001
3/4"	3/4"	86	89	9,5	88	8436591571018

**GRIFO DE ESFERA PARA MANGUERA PN16 PASO ESTÁNDAR  
MANDO PALANCA ERGONÓMICO**

BIBCOCK BALL VALVE PN16 STANDARD BORE  
ERGONOMIC MANUAL CONTROL LEVER

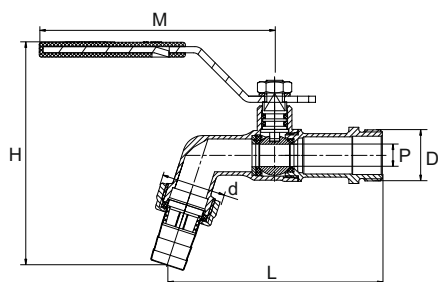

- |                                 |  |
|---------------------------------|--|
| -PN16                           | -PN16                                  |
| -Paso estándar                  | -Standard bore                         |
| -Palanca ergonómica color azul  | -Steel manual control lever color blue |
| -Cuerpo de latón CW617N cromado | -Body chromed brass CW617N             |
| UNE-EN 228/1                    | UNE-EN 228/1                           |
| -Cierre de seguridad            | -PTFE seats                            |
| -Asientos de PTFE               | -Safety lock system                    |
| -Rosca de entrada gas (BSP)     | -Inlet thread gas (BSP) according      |
| según ISO 228/1                 | to ISO 228/1                           |

REF. AR401

SERIE LIGERA



Ref.	D	d	Peso			€
AR401-1212	1/2"	1/2"	135g	10	90	3,94
AR401-3434	3/4"	3/4"	145g	6	54	4,30

D	d	L	M	P	H	EAN
1/2"	1/2"	85	50	9,5	82	8436591571056
3/4"	3/4"	86	50	9,5	82	8436591571063

**GRIFO DE ESFERA PARA MANGUERA PN16 PASO ESTÁNDAR  
MANDO PALOMILLA**

BIBCOCK BALL VALVE PN16 STANDARD BORE  
BUTTERFLY CONTROL

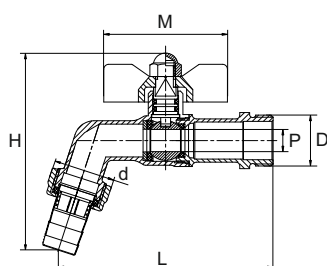

- |                                 |                                   |
|---------------------------------|-----------------------------------|
| -PN16                           | -PN16                             |
| -Paso estándar                  | -Standard bore                    |
| -Mando palomilla aluminio       | -Aluminium butterfly handle       |
| -Cuerpo de latón CW617N cromado | -Body chromed brass CW617N        |
| UNE-EN 228/1                    | UNE-EN 228/1                      |
| -Cierre de seguridad            | -PTFE seats                       |
| -Asientos de PTFE               | -Safety lock system               |
| -Rosca de entrada gas (BSP)     | -Inlet thread gas (BSP) according |
| según ISO 228/1                 | to ISO 228/1                      |

REF. AR500

SERIE PASO TOTAL

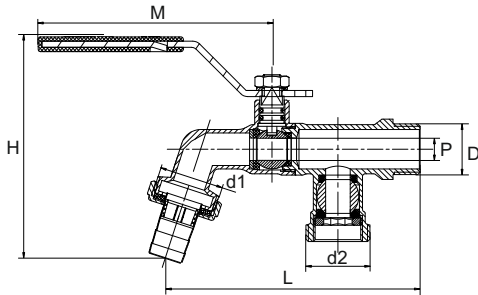

Ref.	D	d1	d2	Peso			€
AR500-123434	1/2"	3/4"	3/4"	162g	8	128	7,15

D	d1	d2	L	M	P	H	EAN
1/2"	3/4"	3/4"	104	89	10	88	8436591571025

GRIFO DE ESFERA PARA MANGUERA PN16 PASO TOTAL  
MANDO PALANCA ERGONÓMICO CON DOS SALIDAS

BIBCOCK BALL VALVE PN16 FULL BORE  
ERGONOMIC MANUAL CONTROL LEVER WITH TWO OUTLETS

- PN16
- Paso total
- Palanca ergonómica color azul
- Cuerpo de latón CW617N cromado
- Cierre de seguridad
- Asientos de PTFE
- Rosca de entrada gas(BSP) según ISO 228/1
- PN16
- Full bore
- Lever manual control color blue
- Body chromed brass CW617N
- PTFE seats
- Safety lock system
- Inlet thread gas(BSP) according to ISO 228/1

REF. AR501

SERIE PASO TOTAL

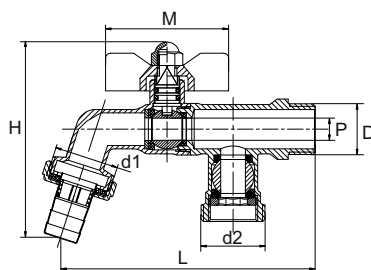

Ref.	D	d1	d2	Peso			€
AR501-123434	1/2"	3/4"	3/4"	162g	8	128	7,25

D	d1	d2	L	M	P	H	EAN
1/2"	3/4"	3/4"	104	50	10	82	8436591571070

GRIFO DE ESFERA PARA MANGUERA PN16 PASO TOTAL  
MANDO PALOMILLA CON DOS SALIDAS

BIBCOCK BALL VALVE PN16 FULL BORE  
BUTTERFLY CONTROL WITH TWO OUTLETS

- PN16
- Paso total
- Mando palomilla aluminio
- Cuerpo de latón CW617N cromado
- Cierre de seguridad
- Asientos de PTFE
- Rosca de entrada gas(BSP) según ISO 228/1
- PN16
- Full bore
- Aluminium butterfly handle
- Body chromed brass CW617N
- PTFE seats
- Safety lock system
- Inlet thread gas(BSP) according to ISO 228/1

# VÁLVULAS DE ESCUADRA

## ANGLE VALVES

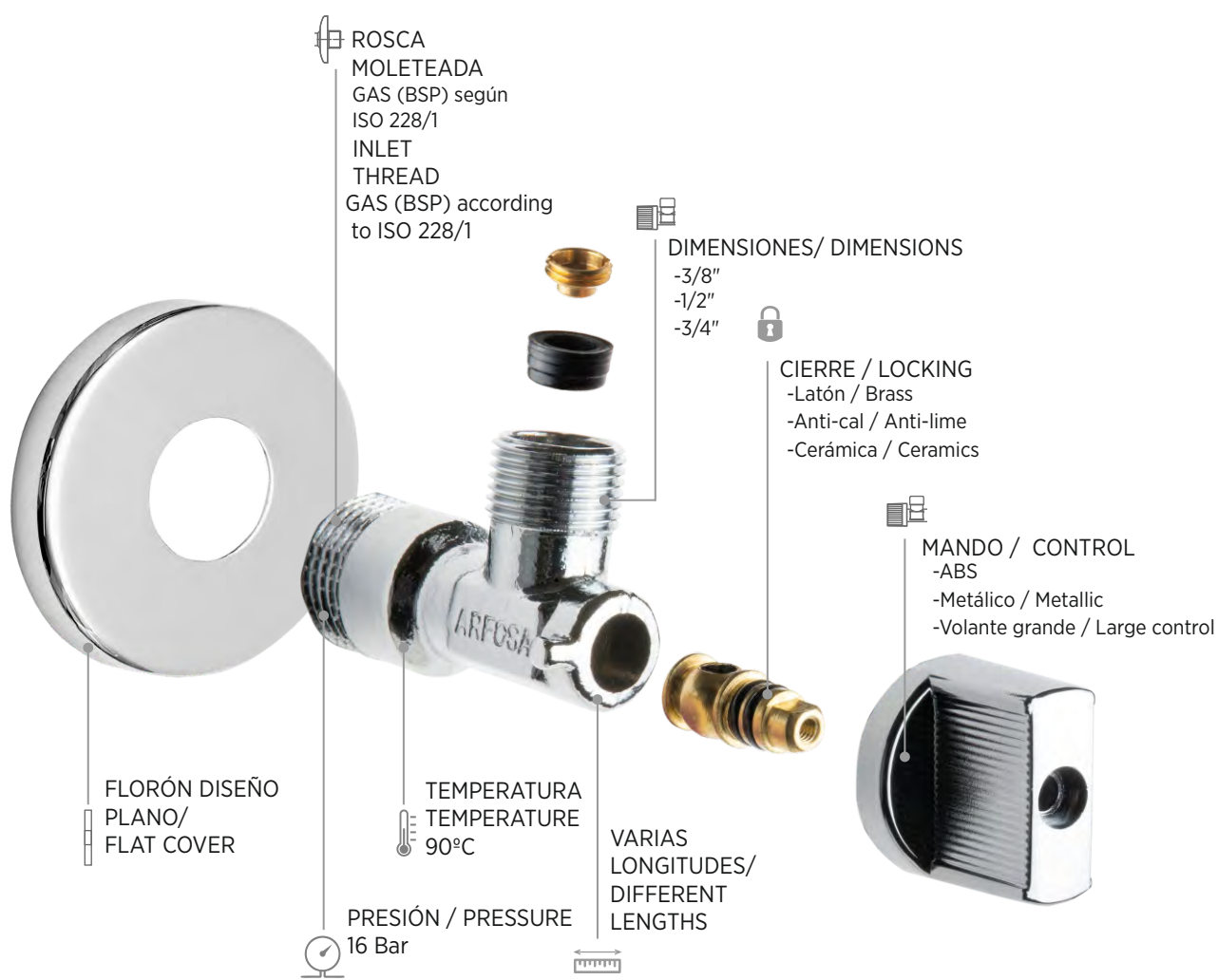



### Simbología

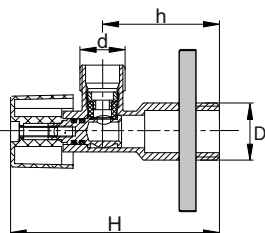

REF. AR002

MODELO CLASSIC



D	d	Tuerca	h	H			€
1/2"	3/8"	NO	41,3	75	2	200	2,24

Cierre y apertura ¼ de vuelta PN16	Closing and opening ¼ turn PN16
Eje interior de latón con juntas EPDM	Brass stem and EPDM joint
Rosca de entrada gas (BSP) según ISO 228/1	Inlet thread gas (BSP) according to ISO 228/1

EAN 8436591570028

REF. AR002-1

MODELO CLASSIC

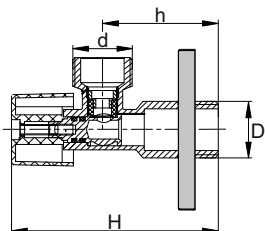

D	d	Tuerca	h	H			€
1/2"	1/2"	NO	41,3	75	2	200	2,40



Cierre y apertura ¼ de vuelta PN16	Closing and opening ¼ turn PN16
Eje interior de latón con juntas EPDM	Brass stem and EPDM joint
Rosca de entrada gas (BSP) según ISO 228/1	Inlet thread gas (BSP) according to ISO 228/1

EAN 8436591570035

REF. AR004

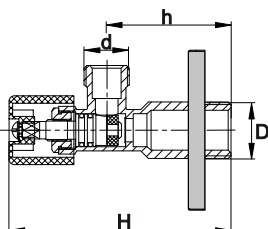
MODELO PISTÓN



D	d	Tuerca	h	H			€
1/2"	3/8"	NO	44,5	82,5	1	100	3,00



Cierre y apertura PISTÓN REGULABLE PN16	Closing and opening adjustable piston PN16
Eje interior de latón con juntas EPDM	Brass stem and EPDM joint
Rosca de entrada gas (BSP) según ISO 228/1	Inlet thread gas (BSP) according to ISO 228/1

EAN 8436591570080

REF. AR005

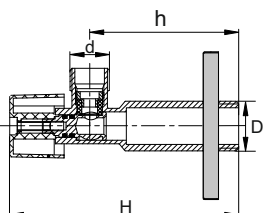
MODELO MAXI



D	d	Tuerca	h	H			€
1/2"	3/8"	NO	61,3	95	2	200	2,62

Cierre y apertura ¼ de vuelta PN16	Closing and opening ¼ turn PN16
Eje interior de latón con juntas EPDM	Brass stem and EPDM joint
Rosca de entrada gas (BSP) según ISO 228/1	Inlet thread gas (BSP) according to ISO 228/1

EAN 8436591570097

## VÁLVULAS DE ESCUADRA LAVADORA / WASHING MACHINE ANGLE VALVES

REF. AR009

MODELO CLASSIC

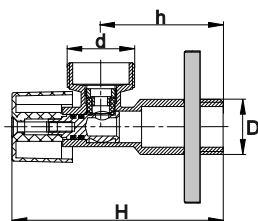

D	d	Tuerca	h	H			€
1/2"	3/4"	NO	44,5	78	1	160	2,84
Cierre y apertura ¼ de vuelta PN16				Closing and opening ¼ turn PN16			
Eje interior de latón con juntas EPDM				Brass stem and EPDM joint			
Rosca de entrada gas (BSP) según ISO 228/1				Inlet thread gas (BSP) according to ISO 228/1			

EAN 8436591570158



REF. AR010

MODELO VOLANTE GRANDE

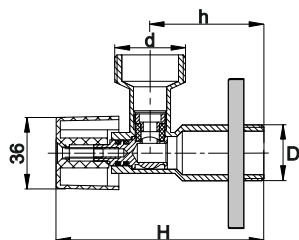

D	d	Tuerca	h	H			€
1/2"	3/4"	NO	45	80	1	160	3,64
Cierre y apertura ¼ de vuelta PN16				Closing and opening ¼ turn PN16			
Eje interior de latón con juntas EPDM				Brass stem and EPDM joint			
Rosca de entrada gas (BSP) según ISO 228/1				Inlet thread gas (BSP) according to ISO 228/1			

EAN 8436591570189



REF. AR018

MODELO VERTICAL

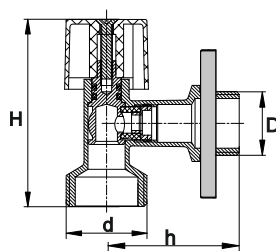

D	d	Tuerca	h	H			€
1/2"	3/4"	NO	50,7	60,3	1	100	2,66
Cierre y apertura ¼ de vuelta PN16				Closing and opening ¼ turn PN16			
Eje interior de latón con juntas EPDM				Brass stem and EPDM joint			
Rosca de entrada gas (BSP) según ISO 228/1				Inlet thread gas (BSP) according to ISO 228/1			

EAN 8436591570295





VÁLVULAS DE ESCUADRA ANTI-CAL / ANTI-LIME ANGLE VALVES

REF. AR002-2

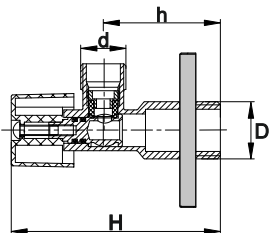

MODELO CLASSIC ANTICAL

D	d	Tuerca	h	H			€
1/2"	3/8"	NO	41,3	75	2	200	2,24

Cierre y apertura ¼ de vuelta PN16	Closing and opening ¼ turn PN16
Eje interior de TEFLON con juntas EPDM	TEFLON stem and EPDM joint
Rosca de entrada gas (BSP) según ISO 228/1	Inlet thread gas (BSP) according to ISO 228/1

EAN 8436591570042

REF. AR002-1A

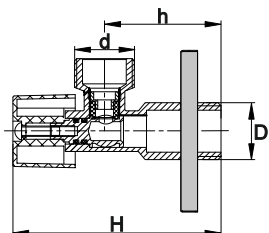

MODELO CLASSIC ANTICAL

D	d	Tuerca	h	H			€
1/2"	1/2"	NO	41,3	75	2	200	2,40

Cierre y apertura ¼ de vuelta PN16	Closing and opening ¼ turn PN16
Eje interior de TEFLON con juntas EPDM	TEFLON stem and EPDM joint
Rosca de entrada gas (BSP) según ISO 228/1	Inlet thread gas (BSP) according to ISO 228/1

EAN 8436591570523

REF. AR005-2

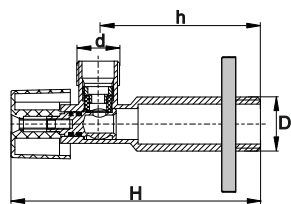

MODELO MAXI ANTICAL

D	d	Tuerca	h	H			€
1/2"	3/8"	NO	61,3	93	2	200	2,62



Cierre y apertura ¼ de vuelta PN16	Closing and opening ¼ turn PN16
Eje interior de TEFLON con juntas EPDM	TEFLON stem and EPDM joint
Rosca de entrada gas (BSP) según ISO 228/1	Inlet thread gas (BSP) according to ISO 228/1

EAN 8436591570103

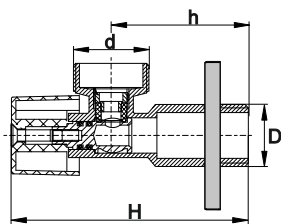
REF. AR009-2



MODELO CLASSIC ANTICAL

D	d	Tuerca	h	H			€
1/2"	3/4"	NO	45	78	1	160	2,84

Cierre y apertura ¼ de vuelta PN16	Closing and opening ¼ turn PN16
Eje interior de TEFLON con juntas EPDM	TEFLON stem and EPDM joint
Rosca de entrada gas (BSP) según ISO 228/1	Inlet thread gas (BSP) according to ISO 228/1

EAN 8436591570165

REF. AR018-2

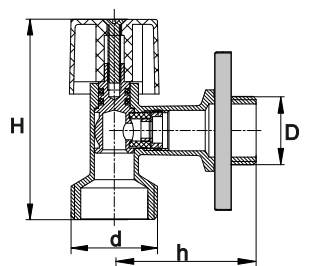

MODELO VERTICAL ANTICAL

D	d	Tuerca	h	H			€
1/2"	3/4"	NO	50,7	60,3	1	100	2,66

Cierre y apertura ¼ de vuelta PN16	Closing and opening ¼ turn PN16
Eje interior de TEFLON con juntas EPDM	TEFLON stem and EPDM joint
Rosca de entrada gas (BSP) según ISO 228/1	Inlet thread gas (BSP) according to ISO 228/1

EAN 8436591570301

# VÁLVULAS DE ESCUADRA MANDO METÁLICO / ZINC HANDLE ANGLE VALVES

REF. AR002-3

MODELO CLASSIC METAL

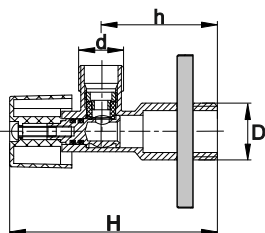

D	d	Tuerca	h	H			€
1/2"	3/8"	NO	41,3	75	2	200	2,68

Cierre y apertura ¼ de vuelta PN16 Eje interior de TEFLON con juntas EPDM Mando metálico cromado Rosca de entrada gas (BSP) según ISO 228/1	Closing and opening ¼ turn PN16 TEFLON stem and EPDM joint Chromed brass handle Inlet thread gas (BSP) according to ISO 228/1
--	--

EAN 8436591570059



REF. AR002-1AM

MODELO CLASSIC METAL

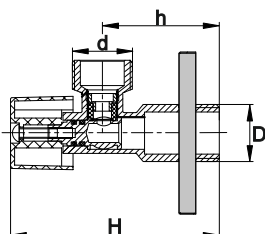

D	d	Tuerca	h	H			€
1/2"	1/2"	NO	41,3	75	2	200	2,96

Cierre y apertura ¼ de vuelta PN16 Eje interior de TEFLON con juntas EPDM Mando metálico cromado Rosca de entrada gas (BSP) según ISO 228/1	Closing and opening ¼ turn PN16 TEFLON stem and EPDM joint Chromed brass handle Inlet thread gas (BSP) according to ISO 228/1
--	--

EAN 8436591570554



REF. AR005-3

MODELO MAXI METAL

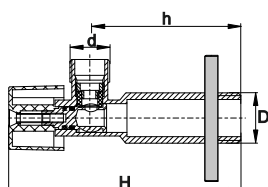

D	d	Tuerca	h	H			€
1/2"	3/8"	NO	61,3	93	2	200	3,12

Cierre y apertura ¼ de vuelta PN16 Eje interior de TEFLON con juntas EPDM Mando metálico cromado Rosca de entrada gas (BSP) según ISO 228/1	Closing and opening ¼ turn PN16 TEFLON stem and EPDM joint Chromed brass handle Inlet thread gas (BSP) according to ISO 228/1
--	--

EAN 8436591570110



REF. AR009-3

MODELO CLASSIC METAL

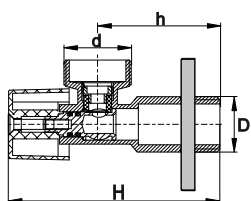

D	d	Tuerca	h	H			€
1/2"	3/4"	NO	45	78	1	160	2,80

Cierre y apertura ¼ de vuelta PN16 Eje interior de TEFLON con juntas EPDM Mando metálico cromado Rosca de entrada gas (BSP) según ISO 228/1	Closing and opening ¼ turn PN16 TEFLON stem and EPDM joint Chromed brass handle Inlet thread gas (BSP) according to ISO 228/1
--	--

EAN 8436591570172





VÁLVULAS DE ESCUADRA DE DISEÑO / DESIGN ANGLE VALVES

REF. AR011

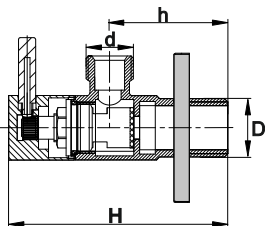
MODELO LINE



D	d	Tuerca	h	H			€
1/2"	3/8"	NO	41,5	77	1	120	5,25
Cierre y apertura ¼ de vuelta con montura cerámica PN16				Closing and opening ¼ turn with ceramic mount PN16			
Mando metálico cromado				Chromed brass handle			
Rosca de entrada gas (BSP) según ISO 228/1				Inlet thread gas (BSP) according to ISO 228/1			

EAN 8436591570196



ACABADO CROMADO PULIDO EXTRA / EXTRA POLISHED CHROME FINISH

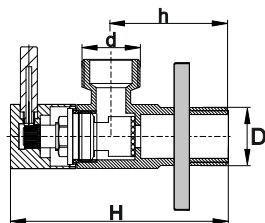

REF. AR011-1

MODELO LINE



D	d	Tuerca	h	H			€
1/2"	1/2"	NO	41,5	77	1	120	5,45
Cierre y apertura ¼ de vuelta con montura cerámica PN16				Closing and opening ¼ turn with ceramic mount PN16			
Mando metálico cromado				Chromed brass handle			
Rosca de entrada gas (BSP) según ISO 228/1				Inlet thread gas (BSP) according to ISO 228/1			

EAN 8436591570202



ACABADO CROMADO PULIDO EXTRA / EXTRA POLISHED CHROME FINISH

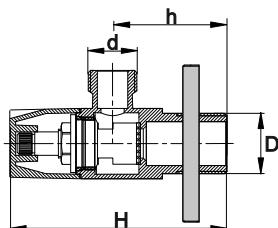

REF. AR014

MODELO TRÉBOL



D	d	Tuerca	h	H			€
1/2"	3/8"	NO	40	74,1	1	120	5,25
Cierre y apertura ¼ de vuelta con montura cerámica PN16				Closing and opening ¼ turn with ceramic mount PN16			
Mando metálico cromado				Chromed brass handle			
Rosca de entrada gas (BSP) según ISO 228/1				Inlet thread gas (BSP) according to ISO 228/1			

EAN 8436591570240



ACABADO CROMADO PULIDO EXTRA / EXTRA POLISHED CHROME FINISH

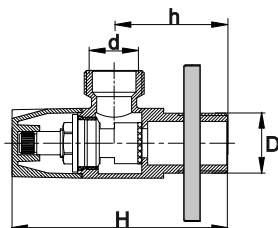

REF. AR014-1

MODELO TRÉBOL



D	d	Tuerca	h	H			€
1/2"	1/2"	NO	40	74,1	1	120	5,45
Cierre y apertura ¼ de vuelta con montura cerámica PN16				Closing and opening ¼ turn with ceramic mount PN16			
Mando metálico cromado				Chromed brass handle			
Rosca de entrada gas (BSP) según ISO 228/1				Inlet thread gas (BSP) according to ISO 228/1			

EAN 8436591570257

ACABADO CROMADO PULIDO EXTRA / EXTRA POLISHED CHROME FINISH

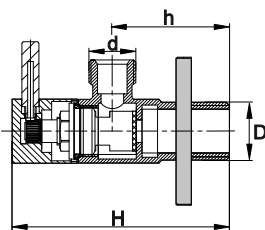

**REF. AR013**
**MODELO BLACK**

D	d	Tuerca	h	H			€
1/2"	3/8"	NO	41,5	77	1	100	7,25
Cierre y apertura ¼ de vuelta con montura cerámica PN16 Mando metálico Rosca de entrada gas (BSP) según ISO 228/1				Closing and opening ¼ turn with ceramic mount PN16 Brass handle Inlet thread gas (BSP) according to ISO 228/1			

**EAN 8436591570226**

ACABADO NEGRO MATE / MATT BLACK FINISH

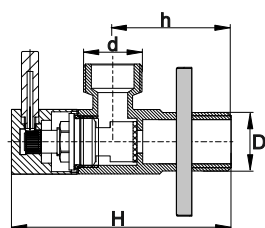
**REF. AR013-1**
**MODELO BLACK**

D	d	Tuerca	h	H			€
1/2"	1/2"	NO	41,5	77	1	100	7,55
Cierre y apertura ¼ de vuelta con montura cerámica PN16 Mando metálico Rosca de entrada gas (BSP) según ISO 228/1				Closing and opening ¼ turn with ceramic mount PN16 Brass handle Inlet thread gas (BSP) according to ISO 228/1			

**EAN 8436591570233**

ACABADO NEGRO MATE / MATT BLACK FINISH

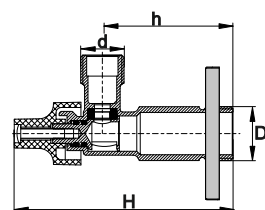
**VÁLVULAS DE ESCUADRA LUX / LUX ANGLE VALVES**
**REF. AR003**
**MODELO LUX**

D	d	Tuerca	h	H			€
1/2"	3/8"	NO	50	83,7	2	200	2,70
Cierre y apertura ¼ de vuelta PN16 Eje interior de latón con juntas EPDM Rosca de entrada gas (BSP) según ISO 228/1				Closing and opening ¼ turn PN16 Brass stem and EPDM joint Inlet thread gas (BSP) according to ISO 228/1			

**EAN 8436591570066**

ACABADO CROMADO PULIDO EXTRA / EXTRA POLISHED CHROME FINISH

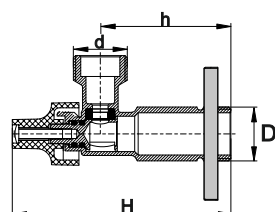
**REF. AR003-1**
**MODELO LUX**

D	d	Tuerca	h	H			€
1/2"	1/2"	NO	50	83,7	2	200	2,80
Cierre y apertura ¼ de vuelta PN16 Eje interior de latón con juntas EPDM Rosca de entrada gas (BSP) según ISO 228/1				Closing and opening ¼ turn PN16 Brass stem and EPDM joint Inlet thread gas (BSP) according to ISO 228/1			

**EAN 8436591570073**



ACABADO CROMADO PULIDO EXTRA / EXTRA POLISHED CHROME FINISH

## VÁLVULAS DE ESCUADRA DUPLO / DOUBLE ANGLE VALVES

REF. AR012

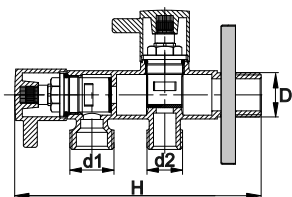
MODELO LINE DUPLO



D	d1	d2	Tuerca	H			€
1/2"	1/2"	3/8"	NO	115	1	100	10,20
Cierre y apertura ¼ de vuelta Dos salidas independientes PN16 Mando metálico cromado Rosca de entrada gas (BSP) según ISO 228/1 Instalación sin necesidad de obra Sustituye llaves de paso ya instaladas en el inodoro				Closing and opening ¼ turn Two independent outlet PN16 Chromed brass handle Inlet thread gas (BSP) according to ISO 228/1 Installation without construction job Replaces shut-off valve already installed in the toilet			





EAN 8436591570219

ACABADO CROMADO PULIDO EXTRA / EXTRA POLISHED CHROME FINISH

REF. AR015

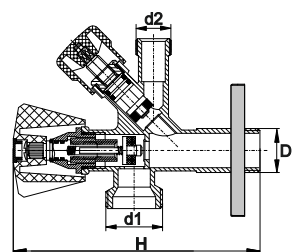
MODELO COMBI



D	d1	d2	Tuerca	H			€
1/2"	3/4"	3/8"	SI	137	1	100	7,75
Cierre y apertura mediante volantes Dos salidas independientes PN16 Mando metálico cromado Rosca de entrada gas (BSP) según ISO 228/1 Instalación sin necesidad de obra Instalación con tuerca bicono o roscado				Closing and opening hand wheel Two independent outlet PN16 Chromed brass handle Inlet thread gas (BSP) according to ISO 228/1 Installation without construction job Installation with bicone or threaded nut			





EAN 8436591570264

ACABADO CROMADO PULIDO EXTRA / EXTRA POLISHED CHROME FINISH

REF. AR016

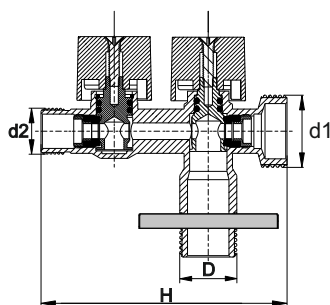
VÁLVULA CON DOBLE SALIDA



D	d1	d2	Tuerca	H			€
1/2"	3/4"	3/8"	NO	89	1	100	5,90
Cierre y apertura ¼ de vuelta Dos salidas independientes PN16 Rosca de entrada gas (BSP) según ISO 228/1 Cuerpo compacto de una sola pieza Eje interior de latón con junta EPDM				Closing and opening ¼ turn Two independent outlet PN16 Inlet thread gas (BSP) according to ISO 228/1 One-piece compact body Brass stem and EPDM joint			





EAN 8436591570271

REF. AR017

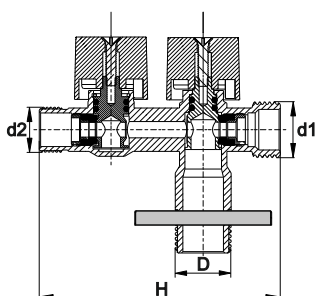
VÁLVULA CON DOBLE SALIDA



D	d1	d2	Tuerca	H			€
1/2"	1/2"	3/8"	NO	89	1	100	5,90
Cierre y apertura ¼ de vuelta Dos salidas independientes PN16 Rosca de entrada gas (BSP) según ISO 228/1 Cuerpo compacto de una sola pieza Eje interior de latón con junta EPDM				Closing and opening ¼ turn Two independent outlet PN16 Inlet thread gas (BSP) according to ISO 228/1 One-piece compact body Brass stem and EPDM joint			



EAN 8436591570288

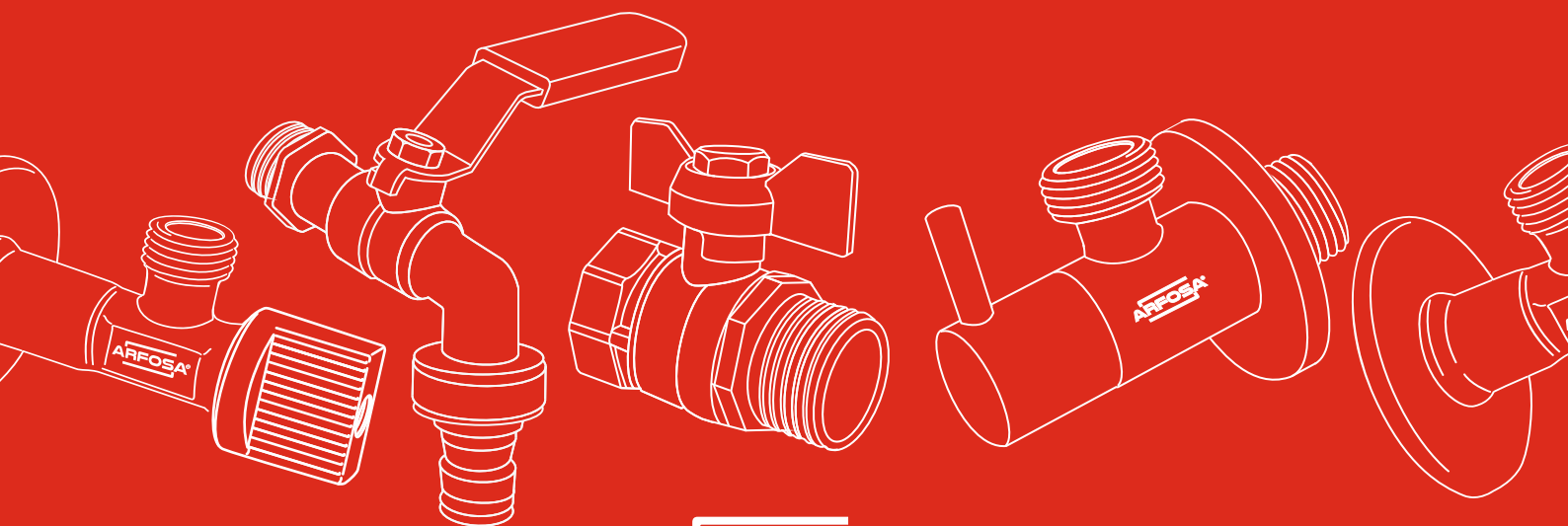

**ARFOSA®**

 **FISCAL Y ALMACÉN**

C/Silici 5, 12530, Burriana, Castellón  
España/Spain

 **CONTACTO**

+34 964 918 188

arfosa@arfosa.es - www.arfosa.es

 **CORRESPONDENCIA**

Apto. Correos 036  
Burriana, Castellón  
España/Spain