

EFFAPPEL

A G E N D A
2023

EFAPEL[®]

NUEVO

TOMA SCHUKO
CON USB A+C



INDICE

01 SISTEMA **mec 21**

LOGUS 90	8
APOLO 5000	25
SIRIUS 70	39

02 SISTEMA MEC **Q45**

<i>Siza</i>	58
QUADRA	60
LATINA	62

03 SONIDO AMBIENTE

JAZZ LIGHT	80
------------	----

04 MECANISMOS ESTANCOS

ESTANCA 48	88
------------	----

05 MECANISMOS DE SUPERFICIE

3700	96
47	101
2600	105

06 BURÓTICA

CAJAS DE SUELO	110
PUESTOS DE TRABAJO	110
TORRETAS DE MESA	111
COLUMNAS	112

07 CANALES TÉCNICOS

ETS 10 - INSTALACIONES ELÉCTRICAS Y DE TELECOMUNICACIONES	118
ETS 13 - PROTECCIÓN DE CABLES Y TUBOS	126
ETS 14 - CUADROS ELÉCTRICOS	127

08 DVI - DATOS, VOZ E IMAGEN

CONECTORES Y ADAPTADORES	128
--------------------------	-----

09 CUADROS ELÉCTRICOS Y DE TELECOMUNICACIONES

OMEGA	138
BETA	145
GAMMA	151

10 APARELLAJE MODULAR PARA CUADROS ELÉCTRICOS

MODUS 55	160
----------	-----

ACCESORIOS PARA INSTALACIONES ELÉCTRICAS	174
---	------------

SISTEMA **mec 21**

LOGUS 90	8
APOLO 5000	25
SIRIUS 70	39

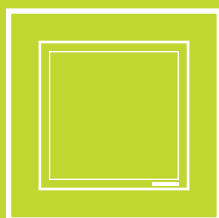

01

mec 21

Sistema de **mecanismo único**, que es un universo de 3 series, se puede optar por diferentes funciones.

Diseño diverso, para una amplia gama de funciones y acabados.

Una vez definidas las funciones, es fácil elegir, colores y acabados.

I. REFERENCIA

- del **mecanismo** de la función;
- del **marco** de la serie seleccionada;
- de la **tecla/centro** correspondiente de la serie.

2. ACABADO

- agregar a la referencia del marco y de la tecla/centro, las **sigla** correspondiente del **acabado** elegido.



MECANISMO ÚNICO, compatible con la libertad de elección.

MECANISMO

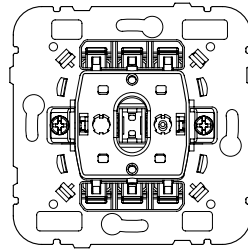

MARCO

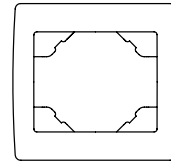
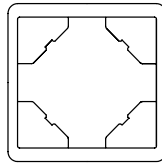
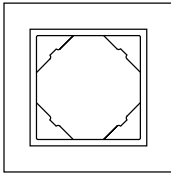

TECLA / TAPA

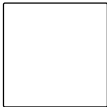

PRODUCTO COMPLETO

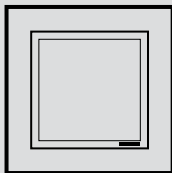

LOGUS⁹⁰

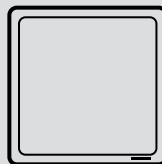

APOLO 5000

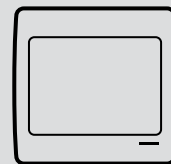

sirius70



LOGUS⁹⁰

ACABADOS	10
FUNCIONES	
– MECANISMOS DE MANDO	12
– DETECTORES DE MOVIMIENTO	16
– CONTROL DE TEMPERATURA	16
– SEÑALIZADORES Y ORIENTACIÓN	16
– TOMAS DE DATOS, VOZ E IMAGEN	17
– CARGADOR USB	19
– TOMAS DE CORRIENTE	20
ACCESORIOS	21
MECANISMOS COMPLETOS	23
MARCOS	24

STANDARD

AQUARELLA

ANIMATO

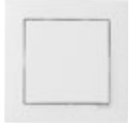

BR
Blanco



GE
Hielo



BB
Blanco/Blanco



JG
Naranja/Hielo



PG
Negro Mate/Hielo



MF
Marfil



PE
Perla



MM
Marfil/Marfil



VG
Rojo/Hielo



PA
Negro Mate/Aluminio



AL
Aluminio



EE
Hielo/Hielo



TS
Naranja Intenso/Gris



PS
Negro Mate/Gris



IS
Gris



PP
Perla/Perla



BS
Rojo Intenso/Gris



RR
Negro Mate/Negro Mate



PM
Negro Mate



RG
Amarillo/Hielo



AA
Aluminio/Aluminio



UG
Dorado/Hielo



DU
Dorado



DG
Verde/Hielo



AS
Aluminio/Gris



UU
Dorado/Dorado



ZG
Azul/Hielo



SS
Gris/Gris

ACABADOS

METALLO



TP
Titanio/Perla



IA
Inox/Aluminio



OP
Oro/Perla



QS
Niquel/Gris



US
Aluminio/Gris



RS
Cromo/Gris

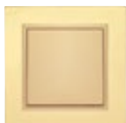

OU
Oro/Dorado

CRYSTAL



CG
Cristal/Hielo



CP
Cristal/Perla



CA
Cristal/Aluminio



CS
Cristal/Gris

ARBORE



FP
Haya/Perla



JP
Cerezo/Perla



MS
Caoba/Gris



NA
Nogal/Aluminio

PETRA



GG
Granito/Hielo



GP
Granito/Perla



GA
Granito/Aluminio

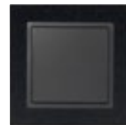



















GS
Granito/Gris

MECANISMOS DE MANDO



		Ref.
	Interruptor Unipolar 10 AX - 250 V ~	21011
	Interruptor Luminoso 10 AX - 250 V ~	21012
	Interruptor con Piloto de Señalización 10 AX - 250 V ~	21013
	Interruptor Bipolar 10 AX - 250 V ~	21021
	Interruptor Bipolar con Piloto de Señalización 10 AX - 250 V ~	21023
	Interruptor Horario Digital de 1 Circuito 16 A (cos fi=1) - 230 V ~ - 50/60 Hz	ECO 21041
	Interruptor Horario Digital de 2 Circuitos 6 A + 6 A (cos fi=1) - 230 V ~ - 50/60 Hz	ECO 21042
	Interruptor Temporizado 16 A (cos fi=1) - 100 - 240 V ~ - 50/60 Hz	ECO 21040
	Interruptor para Tarjeta Card-system Temporizado 16 A (cos fi=1) - 100 - 240 V ~ - 50/60 Hz	ECO 21033
	Interruptor para Tarjeta Card-system 10 AX - 250 V ~	ECO 21031
	Doble Interruptor 10 AX - 250 V ~	21061
	Doble Interruptor Luminoso 10 AX - 250 V ~	21066
	Doble Interruptor con Piloto de Señalización 10 AX - 250 V ~	21067
	Triple Interruptor 10 AX - 250 V ~	21088
	Conmutador 10 AX - 250 V ~	21071

TECLAS / TAPAS

		Ref.	Color
	Tecla Simple	90601 T	BR MF GE PE AL IS PM DU
	Tecla para Mecanismo Luminoso o con Piloto de Señalización	90602 T	BR MF GE PE AL IS PM DU
	Tecla para Mecanismo Luminoso o con Piloto de Señalización con Símbolo Luz	90797 T	BR MF GE PE AL IS PM DU
	Tecla Simple	90601 T	BR MF GE PE AL IS PM DU
	Tecla para Interruptor Bipolar	90608 T	
	Tecla para Mecanismo Luminoso o con Piloto de Señalización	90602 T	
	Tecla para Mecanismo Luminoso o Señal "HEIZUNG NOTSCHALTER"	90798 T	BR MF GE PE AL IS PM DU
	Tecla para Mecanismo Luminoso o con Piloto de Señalización con Símbolo Luz	90797 T	
	Tapa para Interruptor Horario Digital de 1 Circuito	90743 T	BR MF GE PE AL IS PM DU
	Tapa para Interruptor Horario Digital de 2 Circuitos	90744 T	BR MF GE PE AL IS PM DU
	Tecla para Interruptor Temporizado	90745 T	BR MF GE PE AL IS PM DU
	Tapa para Interruptor para Tarjeta Card-system Temporizado	90733 T	BR MF GE PE AL IS PM DU
	Tapa para Interruptor para Tarjeta Card-system	90731 T	BR MF GE PE AL IS PM DU
	Tecla Doble	90611 T	BR MF GE PE AL IS PM DU
	Tecla para Mecanismo Doble Función Luminoso	90615 T	BR MF GE PE AL IS PM DU
	Tecla Triple	90661 T	BR MF GE PE AL IS PM DU
	Tecla Simple	90601 T	BR MF GE PE AL IS PM DU
	Tecla Simple con Dos Símbolos Ventilador	90609 T	

T - Tecla, Tapa o Marco. | BR - Blanco; MF - Marfil; GE - Hielo; PE - Perla; AL - Aluminio; IS - Gris; PM - Negro Mate; DU - Dorado.















 - Ahorro energético y aporte energético del inmueble.

 /  - Conexión tuerca tornillo

MECANISMOS DE MANDO

	Ref.
 Conmutador Luminoso 10 AX - 250 V ~	21072
 Conmutador con Piloto de Señalización 10 AX - 250 V ~	21073
 Doble Conmutador 10 AX - 250 V ~	21101
 Doble Conmutador Luminoso 10 AX - 250 V ~	21202
 Doble Conmutador con Piloto de Señalización 10 AX - 250 V ~	21203
 Conmutador de Cruce 10 AX - 250 V ~	21051
 Doble Conmutador de Cruce 10 AX - 250 V ~	21204
 Conmutador de Cruce Luminoso 10 AX - 250 V ~	21052
 Doble Conmutador de Cruce Luminoso 10 AX - 250 V ~	21205
 Pulsador 10 A - 250 V ~	21151
 Pulsador (NA+NC) 10 A - 250 V ~	21150
 Pulsador Luminoso de 250 V ~ 10 A - 250 V ~	21152
Pulsador Independiente 10 A - 250 V ~	21153
Pulsador Luminoso de 12 V 6 A - 12 V	21162
Pulsador con Luminoso para Tecla Porta-rótulos de 250 V ~ 10 A - 250 V ~	21155
Pulsador con Luminoso para Tecla Porta-rótulos de 12 V 6 A - 12 V	21165

TECLAS / TAPAS











	Ref.	Color
 Tecla para Mecanismo Luminoso o con Piloto de Señalización	90602 T	BR MF GE PE AL IS PM DU
 Tecla Doble	90611 T	BR MF GE PE AL IS PM DU
 Tecla Doble para Conmutador Ventilador	90616 T	
 Tecla para Mecanismo Doble Función Luminoso	90615 T	BR MF GE PE AL IS PM DU
 Tecla Simple	90601 T	BR MF GE PE AL IS PM DU
 Tecla para Mecanismo de Doble Función	90614 T	BR MF GE PE AL IS PM DU
 Tecla para Mecanismo Luminoso o con Piloto de Señalización	90602 T	BR MF GE PE AL IS PM DU
 Tecla para Mecanismo Doble Función Luminoso	90615 T	BR MF GE PE AL IS PM DU
Tecla Simple	90601 T	
Tecla con Símbolo Llave 	90604 T	
 Tecla con Símbolo de Campana 	90605 T	BR MF GE PE AL IS PM DU
 Tecla con Símbolo de Asistenta 	90606 T	
Tecla con Símbolo Luz 	90607 T	
Tecla para Mecanismo Luminoso o con Piloto de Señalización	90602 T	
Tecla para Mecanismo Luminoso o con Piloto de Señalización con Símbolo Llave 	90794 T	
 Tecla para Mecanismo Luminoso o con Piloto de Señalización con Símbolo Campana 	90795 T	BR MF GE PE AL IS PM DU
Tecla para Mecanismo Luminoso o con Piloto de Señalización con Símbolo Asistenta 	90796 T	
Tecla para Mecanismo Luminoso o con Piloto de Señalización con Símbolo Luz 	90797 T	
 Tecla con Porta-rótulos	90603 T	BR MF GE PE AL IS PM DU

T - Tecla, Tapa o Marco. | BR - Blanco; MF - Marfil; GE - Hielo; PE - Perla; AL - Aluminio; IS - Gris; PM - Negro Mate; DU - Dorado.

MECANISMOS DE MANDO

	Ref.
 Doble Pulsador 10 A - 250 V ~	21156
 Doble Pulsador (2NA+2NC) 10 A - 250 V ~	21154
 Doble Pulsador Luminoso 250 V ~ 10 A - 250 V ~	21206
 Doble Pulsador Luminoso 12 V 6 A - 12 V	21207
 Conmutador / Pulsador 10 AX - 250 V ~	21158
 Pulsador / Conmutador 10 AX - 250 V ~	21159
 Conmutador Luminoso / Pulsador Luminoso 10 AX - 250 V ~	21208
 Pulsador Luminoso / Conmutador Luminoso 10 AX - 250 V ~	21209
 Pulsador Cuádruple (Muy Baja Tensión) 12 V ~ - 50 mA / 32 V ~ - 18 mA	21164
 Interruptor Rotativo 10 AX - 250 V ~	21306
 Conmutador Rotativo 10 AX - 250 V ~ ON - OFF - ON.	21307
Conmutador Rotativo de 3 Posiciones 16(4) A - 250 V ~	21300
Conmutador Rotativo de 4 Posiciones 16(4) A - 250 V ~	21305
Conmutador con Llave 10 AX - 250 V ~ ON - OFF - ON.	21352
Pulsador con Llave 10 A - 250 V ~ ON - OFF - ON.	21351
Conmutador con Tirador 10 AX - 250 V ~ NA+NC.	21092
Pulsador con Tirador 10 A - 250 V ~ NA.	21091
Pulsador con Tirador (NA+NC) 10 A - 250 V ~ NA+NC.	21090

TECLAS / TAPAS

	Ref.	Color
 Tecla Doble	90611 T	BR MF GE PE AL IS PM DU
 Tecla para Mecanismo Doble Función Luminoso	90615 T	BR MF GE PE AL IS PM DU
 Tecla Doble	90611 T	BR MF GE PE AL IS PM DU
 Tecla para Mecanismo Doble Función Luminoso	90615 T	BR MF GE PE AL IS PM DU
 Tecla Cuádruple	90600 T	BR MF GE PE AL IS PM DU
 Tapa para Interruptor Rotativo (ON/OFF)	90762 T	BR MF GE PE AL IS PM DU
 Tapa para Pulsador / Conmutador Rotativo para Persiana	90761 T	BR MF GE PE AL IS PM DU
 Tapa para Conmutador Rotativo con Marcación (I, 0, II)	90760 T	
 Tapa para Conmutador Rotativo de 3 Posiciones	90765 T	BR MF GE PE AL IS PM DU
 Tapa para Conmutador Rotativo de 4 Posiciones	90766 T	
 Tapa para Pulsador / Conmutador con Llave	90351 T	BR MF GE PE AL IS PM DU
Tapa para Conmutador / Pulsador con Tirador Aproximadamente 65 cm de Tirador.	90741 T	BR MF GE PE AL IS PM DU

T - Tecla, Tapa o Marco. | BR - Blanco; MF - Marfil; GE - Hielo; PE - Perla; AL - Aluminio; IS - Gris; PM - Negro Mate; DU - Dorado.

⊗ / ⊕ / ⊖ - Conexión tuerca tornillo







MECANISMOS DE MANDO

MANDOS PARA PERSIANAS		Ref.
	Interruptor para Persiana 10 A - 250 V ~	21290
	Interruptor para Persiana con Enclavamiento Mecánico 10 A - 250 V ~	21291
	Mando General de Persiana con Sensor IR 5 A (cos φ=1) - 100 - 240 V ~ - 50/60 Hz	 21311
	Mando Local de Persiana con Sensor IR 5 A (cos φ=1) - 100 - 240 V ~ - 50/60 Hz	 21312
	Doble Pulsador para Persiana 10 A - 250 V ~	21281
	Doble Pulsador Conmutador para Persiana 10 A - 250 V ~	21283
	Pulsador Rotativo para Persiana 10 A - 250 V ~ ON - OFF - ON.	21303

REGULADORES/CONMUTADORES DE LUZ



	Regulador de Luz RLC de Teclas 100 - 240 V ~ - 50/60 Hz 5 - 250 W/VA. 5 - 75 W LED's.	 21218
	Regulador/Conmutador de Luz Rotativo Ferromagnético de 500 VA R, L 20 - 500 W/VA.	 21211
	Regulador/Conmutador de Luz Rotativo Electrónico de 550 W R, C 20 - 550 W/VA.	 21213
	Regulador/Conmutador de Luz Rotativo Ferromagnético para Lámparas de Bajo Consumo de 110 VA R, L 7 - 110 W/VA. 3 - 35 W LED's.	 21214
	Regulador/Conmutador de Luz Rotativo Electrónico para Lámparas de Bajo Consumo de 150 W R, C 15 - 150 W/VA. 3 - 50 W LED's.	 21215
	Regulador/Conmutador de Luz Rotativo Ferromagnético para Lámparas de Bajo Consumo de 250 W/VA R, L 20 - 250 W/VA. 3 - 85 W LED's.	 21216
	Regulador/Conmutador de Luz Rotativo Electrónico para Lámparas de Bajo Consumo de 450 W/VA R, C 15 - 450 W/VA. 5 - 150 W LED's.	 21217

TECLAS / TAPAS

	Ref.	Color
	Tecla para Interruptor para Persiana	90613 T BR MF GE PE AL IS PM DU
	Tapa para Mando General de Persiana con Sensor IR	90311 T BR MF GE PE AL IS PM DU
	Tapa para Mando Local de Persiana con Sensor IR	90312 T BR MF GE PE AL IS PM DU
	Tecla para Doble Pulsador Conmutador para Persiana	90612 T BR MF GE PE AL IS PM DU
	Tapa para Pulsador / Conmutador Rotativo para Persiana	90761 T BR MF GE PE AL IS PM DU
	Tecla para Regulador de Luz	90747 T BR MF GE PE AL IS PM DU
	Tapa para Regulador/Conmutador de Luz Rotativo	90721 T BR MF GE PE AL IS PM DU

T - Tecla, Tapa o Marco. | BR - Blanco; MF - Marfil; GE - Hielo; PE - Perla; AL - Aluminio; IS - Gris; PM - Negro Mate; DU - Dorado.

 - Ahorro energético y aporte energético del inmueble.

 /  - Conexión tuerca tornillo

MECANISMOS DE MANDO

REGULADORES/CONMUTADORES DE LUZ

Ref.



Regulador/Interruptor de Luz Rotativo para Lámparas Fluorescentes con Balasto Electrónico 1-10 V



21210

Imáx - 40 mA.



Regulador/Conmutador Rotativo de Velocidad para Motores de 600 VA



21219

25 - 600 VA.

DETECTORES DE MOVIMIENTO



Detector de Movimiento de 1000 W
100 - 240 V ~ - 50/60 Hz



21401

Detector de Movimiento de 400 W
100 - 240 V ~ - 50/60 Hz



21402



Detector de Movimiento Instalación Mural de 1000 W
100 - 240 V ~ - 50/60 Hz



21403

Detector de Movimiento Instalación Mural de 400 W
100 - 240 V ~ - 50/60 Hz



21404

CONTROL DE TEMPERATURA



Termostato Rotativo
16 A (cos fi=1) - 100 - 240 V ~ - 50/60 Hz



21234



Termostato Multifuncional
16 A (cos fi=1) - 100 - 240 V ~ - 50/60 Hz



21236



Cronotermostato Multifuncional
16 A (cos fi=1) - 100 - 240 V ~ - 50/60 Hz



21235



Sensor de Temperatura de Suelo para Termostato y Cronotermostato
Longitud: 4 m.
-10 °C a 50 °C.
IP67.
NTC 12 K/25 °C.

81950

-

SEÑALIZADORES Y ORIENTACIÓN



Luz de Orientación Blanca
230 V ~ - 50/60 Hz
L1 - 0,2 W; L2 - 0,4 W (4000 K)

21388

Luz de Orientación Blanca con Batería
230 V ~ - 50/60 Hz
L1 - Señalización OFF; L2 - Señalización ON.

21389



Señalizador Luminoso
230 V ~ - 50/60 Hz
L1 - 0,2 W; L2 - 0,4 W (4000 K)

NUEVO

21361



Timbre
250 V ~ - 50 Hz
Tipo D.
5/15 seg..

21990

TECLAS / TAPAS

Ref.

Color



Tapa para Regulador/
Conmutador de Luz Rotativo

90721 T

BR MF
GE PE AL
IS PM DU

Tapa para Detector de Movimiento

90401 T

BR MF
GE PE AL
IS PM DU

Tapa para Detector de Movimiento
Instalación Mural

90403 T

BR MF
GE PE AL
IS PM DU

Tapa para Termostato Rotativo

90746 T

BR MF
GE PE AL
IS PM DU

Tapa para Termostato Multifuncional

90749 T

BR MF
GE PE AL
IS PM DU

Tapa para Cronotermostato
Multifuncional

90748 T

BR MF
GE PE AL
IS PM DU

Tapa para Luz de Orientación

90782 T

BR MF
GE PE AL
IS PM DU

Difusor para Señalizador Luminoso

90781 T

IC LR VD VM



Tapa para Altavoz de 2" - 32 Ohm /
Timbre

90710 T

BR MF
GE PE AL
IS PM DU

T - Tecla, Tapa o Marco. | BR - Blanco; MF - Marfil; GE - Hielo; PE - Perla; AL - Aluminio; IS - Gris; PM - Negro Mate; DU - Dorado; IC - Transparente; LR - Naranja; VD - Verde; VM - Rojo.

- Ahorro energético y aporte energético del inmueble.

/ - Conexión tuerca tornillo









TOMAS DE DATOS, VOZ E IMAGEN

TECLAS / TAPAS

TOMAS INFORMÁTICAS		Ref.
	Toma Informática RJ45 Cat. 6A UTP	21590
	Toma Informática RJ45 Cat. 6 UTP	21455
	Toma Informática RJ45 Cat. 6 STP	21445
	Toma Informática RJ45 Cat. 5e UTP	21453
	Toma Informática RJ45 Cat. 5e STP	21443
	Adaptador para Toma RJ45 (Sin conector)	21976



Ref.	Color		
	Tapa para Toma Informática RJ45	90751 T	BR MF GE PE AL IS PM DU



CONECTORES RJ45



	Conector Hembra RJ45 Cat. 6A UTP (500 MHz)		82021
	Conector Hembra RJ45 Cat. 6 UTP (250 MHz)		21978
	Conector Hembra RJ45 Cat. 6 UTP (250 MHz) - Montaje Rack		82020
	Conector Hembra RJ45 Cat. 5e UTP (100 MHz)		21975
	Conector Hembra RJ45 Cat. 6 STP (250 MHz)		21988
	Conector Hembra RJ45 Cat. 5e STP (100 MHz)		21985

	Tapa con Soporte para Un Conector RJ45	90441 S	
	Tapa con Soporte para Dos Conectores RJ45	90442 S	BR MF GE PE AL IS PM DU

ADAPTADORES PARA CONECTORES DE FIBRA ÓPTICA

	Adaptador para Conectores de Fibra Óptica SC APC Duplex	82211
	Adaptador para Conectores de Fibra Óptica SC APC Simplex	82210
	Adaptador para Conectores de Fibra Óptica LC Duplex	82213

	Tapa para Adaptador para Conectores de Fibra Óptica SC APC Duplex	90448 S	BR MF GE PE AL IS PM DU
	Tapa para Adaptador para Conectores de Fibra Óptica SC APC Simplex / LC Duplex	90449 S	BR MF GE PE AL IS PM DU



	Tapa de Protección para Adaptador de Fibra Óptica SC APC Simplex	82970	-
	Tapa de Protección para Adaptador de Fibra Óptica SC APC Duplex	82971	-

S - Semi-montado; T - Tecla, Tapa o Marco. | BR - Blanco; MF - Marfil; GE - Hielo; PE - Perla; AL - Aluminio; IS - Gris; PM - Negro Mate; DU - Dorado.

 - Power over Ethernet

TOMAS DE DATOS, VOZ E IMAGEN

TECLAS / TAPAS

TOMAS TELEFÓNICAS		Ref.	Color
50 V ~ 70 V -			
	Toma Telefónica (4 conductores para Conector RJ11)	21252 S	BR MF CZ AT PT
	Toma Telefónica Gel (4 conductores para Conector RJ11)	21255 S	BR MF CZ AT PT

	Ref.	Color	
	Tapa para Toma Telefónica	90712 T *	BR MF GE PE AL IS PM DU

* Para usar las Tapas para Toma Telefónica con Acabado AQUARELLA, utilizar los mecanismos con los siguientes colores:
GE (Hielo) - **BR** (Blanco); **PE** (Perla) - **MF** (Marfil); **AL** (Aluminio) - **CZ** (Gris)
IS (Gris) - **AT** (Antracita); **PM** (Negro Mate) - **PT** (Negro); **DU** (Dorado) - **MF** (Marfil).



8 CONTACTOS



	Toma Telefónica Francesa T8	21411	
--	-----------------------------	--------------	--

	Tapa para Toma Telefónica Francesa T8	90718 T	BR MF GE PE AL IS PM DU
---	---------------------------------------	----------------	-------------------------------

TOMAS DE RADIO, TELEVISIÓN Y SATÉLITE



ESTRELLA

	Toma R - TV - SAT Estrella 4 - 862 MHz: < 2 dB. 950 - 2400 MHz: < 3 dB. Paso de corriente 500 mA [DC].	21543	
	Toma R - TV Estrella 4 - 82 MHz: < 1 dB. 84 - 108 MHz: < 2 dB. 112 - 1000 MHz: < 1 dB.	21533	

	Tapa para Toma R - TV - SAT	90775 T	BR MF GE PE AL IS PM DU
	Tapa para Toma R - TV	90776 T	





CONEXIÓN EN SERIE

	Toma R - TV - SAT Final 4 - 446 MHz: < 6 dB. 470 - 862 MHz: < 9 dB. 950 - 2400 MHz: < 6 dB. Paso de corriente 500 mA [DC].	21555	
	Toma R - TV - SAT Intermedia 4 - 862 MHz: < 10 dB. 950 - 2150 MHz: < 11 dB. 2150 - 2400 MHz: < 9 dB. Paso de corriente 500 mA [DC]. Pérdidas de inserción: 3 dB.	21565	
	Toma R - TV Final 4 - 82 MHz: < 6 dB. 84 - 108 MHz: < 8 dB. 112 - 1000 MHz: < 7dB.	21554	
	Toma R - TV Intermedia 4 - 1000 MHz: < 9 dB. Pérdidas de inserción: 2 dB.	21564	

	Tapa para Toma R - TV - SAT	90775 T	BR MF GE PE AL IS PM DU
	Tapa para Toma R - TV	90776 T	BR MF GE PE AL IS PM DU



TOMAS MÚLTIPLES

ESTRELLA

	Toma Múltiple R - TV - SAT - RJ45 Cat. 6A UTP - FO SC-APC Estrella 4 - 862 MHz: < 2 dB. 950 - 2400 MHz: < 3 dB. Paso de corriente 500 mA [DC].		21548
	Toma Múltiple R - TV - SAT - RJ45 Cat. 6 UTP - FO SC-APC Estrella 4 - 862 MHz: < 2 dB. 950 - 2400 MHz: < 3 dB. Paso de corriente 500 mA [DC].		21545

	Tapa para Tomas Múltiples R - TV - SAT - RJ45 / R - TV - SAT - RJ45 - FO	90770 T	BR MF GE PE AL IS PM DU
---	--	----------------	-------------------------------

S - Semi-montado; T - Tecla, Tapa o Marco. | BR - Blanco; MF - Marfil; GE - Hielo; PE - Perla; AL - Aluminio; IS - Gris; PM - Negro Mate; DU - Dorado; CZ - Gris; AT - Antracita; PT - Negro.

  - Conexión tuerca tornillo

 - Power over Ethernet

TOMAS DE DATOS, VOZ E IMAGEN

TOMAS MÚLTIPLES

Ref.

ESTRELLA



Toma Múltiple R - TV - SAT - RJ45 Cat. 6A UTP Estrella

Puede ser equipado con 1 conector FO del tipo SC APC Simplex o LC Duplex - pág. 132.

4 - 862 MHz: < 2 dB.

950 - 2400 MHz: < 3 dB.

Paso de corriente 500 mA (DC).



21547



Toma Múltiple R - TV - SAT - RJ45 Cat. 6 UTP Estrella

Puede ser equipado con 1 conector FO del tipo SC APC Simplex o LC Duplex - pág. 132.

4 - 862 MHz: < 2 dB.

950 - 2400 MHz: < 3 dB.

Paso de corriente 500 mA (DC).



21544



Toma Múltiple R - TV - SAT - 2 x RJ45 Cat. 6 UTP Estrella

4 - 862 MHz: < 2 dB.

950 - 2400 MHz: < 3 dB.

Paso de corriente 500 mA (DC).

21546



Toma Múltiple R - TV - RJ45 Cat. 6A UTP - FO SC-APC Estrella

4 - 82 MHz: < 1 dB.

84 - 108 MHz: < 2 dB.

112 - 1000 MHz: < 1 dB.



21537



Toma Múltiple R - TV - RJ45 Cat. 6 UTP - FO SC-APC Estrella

4 - 82 MHz: < 1 dB.

84 - 108 MHz: < 2 dB.

112 - 1000 MHz: < 1 dB.



21535



Toma Múltiple R - TV - RJ45 Cat. 6A UTP Estrella

Puede ser equipado con 1 conector FO del tipo SC APC Simplex o LC Duplex - pág. 132.

4 - 82 MHz: < 1 dB.

84 - 108 MHz: < 2 dB.

112 - 1000 MHz: < 1 dB.



21536



Toma Múltiple R - TV - RJ45 Cat. 6 UTP Estrella

Puede ser equipado con 1 conector FO del tipo SC APC Simplex o LC Duplex - pág. 132.

4 - 82 MHz: < 1 dB.

84 - 108 MHz: < 2 dB.

112 - 1000 MHz: < 1 dB.



21534

TECLAS / TAPAS

Ref.

Color



Tapa para Tomas Múltiples R - TV - SAT - RJ45 / R - TV - SAT - RJ45 - FO

90770 T

BR MF
GE PE AL
IS PM DU

Tapa para Toma Múltiple R - TV - SAT - 2xRJ45

90773 T

BR MF
GE PE AL
IS PM DU

Tapa para Tomas Múltiples R - TV - RJ45 / R - TV - RJ45 - FO

90774 T

BR MF
GE PE AL
IS PM DU

CARGADOR USB



Doble Cargador USB con Salidas a 20° Tipo A

100 - 240 V ~ - 50/60 Hz - 5 V = 2.4 A

21384



Tapa para Doble Cargador USB con Salidas a 20° Tipo A

90673 T

BR MF
GE PE AL
IS PM DU

T - Tecla, Tapa o Marco; | BR - Blanco; MF - Marfil; GE - Hielo; PE - Perla; AL - Aluminio; IS - Gris; PM - Negro Mate; DU - Dorado.





















- Conexión tuerca tornillo

- Power over Ethernet

TOMAS DE CORRIENTE

		Ref.
	Toma Schuko con Terminales de Conexión Rápida 16 A - 250 V~	21130
	Toma Schuko 16 A - 250 V~	21131
	Toma Schuko con Cargador USB 100 - 240 V ~ - 50/60 Hz - 5 V = 3.0 A	NUEVO 21137
	Toma 2P 16 A - 250 V~	21121
	Toma Francesa con Terminales de Conexión Rápida 16 A - 250 V~	21110
	Toma Francesa 16 A - 250 V~	21111
	Doble Toma Francesa 16 A - 250 V~	21470
	Toma Francesa con Cargador USB 100 - 240 V ~ - 50/60 Hz - 5 V = 3.0 A	NUEVO 21117
	Toma Euro-americana 15 A - 127 V ~ / 16 A - 250 V~	21140
	Toma Americana NEMA 15 A - 127 V~ SASO 2204 NEMA 5-15	21143
	Toma Inglesa con Protección 13 A - 250 V~	21185
	Toma Schuko con Terminales de Conexión Rápida con Protección (Mecanismo + Tapa) 16 A - 250 V~	90133 W
	Toma Schuko con Terminales de Conexión Rápida (Mecanismo + Tapa) 16 A - 250 V~	90130 W
	Toma Schuko con Terminales de Conexión Rápida con Tapa Articulada con Protección (Mecanismo + Tapa) - (IP44) 16 A - 250 V~	90496 W

TECLAS / TAPAS

		Ref.	Color
	Tapa con Protección para Toma Schuko	90632 T	BR MF GE PE AL IS PM DU LR VD VM
	Tapa para Toma Schuko	90631 T	
	Tapa Articulada con Protección para Toma Schuko (IP44)	90634 T	BR MF GE PE AL IS PM DU VD VM
	Marco Monobloc con Protección para Toma Schuko	90903 T	BR MF GE PE AL IS PM DU
	Marco Monobloc para Toma Schuko	90902 T	
	Tapa para Toma Schuko + USB Tipo A y Tipo C	NUEVO 90630 T	BR MF GE PE AL IS PM DU
	Tapa con Protección para Toma 2P	90622 T	BR MF GE PE AL IS PM DU
	Tapa para Toma 2P	90621 T	
	Tapa con Protección para Toma Francesa	90652 T	BR MF GE PE AL IS PM DU LR VD VM
	Tapa Articulada con Protección para Toma Francesa (IP44)	90654 T	BR MF GE PE AL IS PM DU VD VM
	Marco Monobloc con Protección para Toma Francesa	90904 T	BR MF GE PE AL IS PM DU
	Tapa con Protección para Doble Toma Francesa	90656 T	BR MF GE PE AL IS PM DU
	Tapa para Toma Francesa + USB Tipo A y Tipo C	NUEVO 90650 T	BR MF GE PE AL IS PM DU
	Tapa con Protección para Toma Euro-americana	90842 T	BR MF GE PE AL IS PM DU LR VD VM
	Tapa para Toma Euro-americana	90841 T	
	Tapa con Protección para Toma Americana NEMA	90843 T	BR MF GE PE AL IS PM DU LR VD VM
	Tapa para Toma Inglesa con Protección	90642 T	BR MF GE PE AL IS PM DU
	Toma Schuko con Terminales de Conexión Rápida con Protección (Mecanismo + Tapa)	90133 W	BR MF LR VD VM GE PE AL IS PM DU
	Toma Schuko con Terminales de Conexión Rápida (Mecanismo + Tapa)	90130 W	
	Toma Schuko con Terminales de Conexión Rápida con Tapa Articulada con Protección (Mecanismo + Tapa) - (IP44)	90496 W	BR MF GE PE AL IS PM DU





T - Tecla, Tapa o Marco; W - Semi-montado embalado en Film. | BR - Blanco; MF - Marfil; GE - Hielo; PE - Perla; AL - Aluminio; IS - Gris; PM - Negro Mate; DU - Dorado; LR - Naranja; VD - Verde; VM - Rojo.

⊗x / ⊖ - Conexión tuercas tornillo

ACCESORIOS













SALIDA DE CABLES		Ref.
	Salida de Cables con 3 Terminales 3x2,5 mm ² - 250 V ~	21173
	Salida de Cables con 4 Terminales 4x1,5 mm ² - 250 V ~	21174
VARIOS		
	Toma de Altavoz	21220
	Soporte para Tapa Ciega	21222
	Kit IP44 para MEC 21 - Tecla Simple	21981
	Kit IP44 para MEC 21 - Tecla Doble	21982
	Tapa para Protección de Mecanismos MEC 21	21971
	Nivel para Montaje MEC 21	21989
	Tarjeta para Interruptor Card-system	21999
	Garra larga para Mecanismos Mec21 Compatible con Mecanismos de Mando.	 21998
	Tecla Doble para Mecanismos Electrónicos	90610 T
	Tapa para Toma Multimarcas R - TV de 2 Salidas Distancia entre orificios: 30 mm.	90685 T
	Tapa para Toma Multimarcas R TV - SAT de 2 Salidas Distancia entre orificios: 30 mm.	90686 T
	Tapa para Toma Multimarcas R - TV - SAT de 3 Salidas Distancia entre orificios: 30 mm.	90680 T
	Tapa para Toma Telefónica Alemana Tipo TAE	90714 T
	Tapa para Toma Telefónica Alemana Tipo UAE (45°)	90716 T

TECLAS / TAPAS



	Ref.	Color
	90671 T	BR MF GE PE AL IS PM DU
	90713 T	BR MF GE PE AL IS PM DU
	90677 T	BR MF GE PE AL IS PM DU
	21981	—
	21982	—
	21971	—
	21989	—
	21999	—
	 21998	—
	90610 T	BR MF GE PE AL IS PM DU
	90685 T	BR MF GE PE AL IS PM DU
	90686 T	BR MF GE PE AL IS PM DU
	90680 T	BR MF GE PE AL IS PM DU
	90714 T	BR MF GE PE AL IS PM DU
	90716 T	BR MF GE PE AL IS PM DU

T - Tecla, Tapa o Marco. | BR - Blanco; MF - Marfil; GE - Hielo; PE - Perla; AL - Aluminio; IS - Gris; PM - Negro Mate; DU - Dorado.





















ACCESORIOS

VARIOS		Ref.	Color
	Tapa Central Universal Q45	90881 T	BR MF GE PE AL IS PM DU VM
	Adaptador 50x50	90882 T	BR MF GE PE AL IS PM DU
	LED para la Serie MEC 21 y Serie 48 - 250 V~	81019	—
	LED para la Serie MEC 21 y Serie 48 - 12 V	81018	—
	Mando a Distancia Multifunciones Control Termostato Multifuncional. Control de Mandos de Persiana. Control de instalaciones de sonido. Funciona con pila CR 2032, no incluida.	81900	—
CAJAS DE SUPERFICIE Y DE EMPOTRAR			
	Caja de Superficie para Serie LOGUS 90 Serie QUADRO 45 En la Serie MEC Q45, solo aplicable con Marcos Simple.	10976 A	BR MF GE PE AL IS PM DU
	Doble Caja de Superficie para Serie LOGUS 90	10994 A	BR MF GE PE AL IS PM DU
	Triple Caja de Superficie para Serie LOGUS 90	10995 A	BR MF GE PE AL IS PM DU
	Caja de Empotrar Para ser usado con canales con Tapas L75.	10984 A	BR
	Caja Semi Empotrable Para ser usado con canales con Tapas L75.	10985 A	BR
RELÉS PARA PERSIANAS			
	Relé Interruptor de Persiana 6 A - 230 V ~ - 50 Hz Temporizado. Conectar a Dobles Pulsadores y a Dobles Pulsadores de Persianas.	81512	—
	Relé Pulsador de Persiana 6 A - 230 V ~ - 50 Hz No temporizado. Conectar localmente a Doble Pulsador Conmutador para Persiana (Ref.º 21283 / 45283 S).	81511	—



T - Tecla, Tapa o Marco; A - Accesorio. | BR - Blanco; MF - Marfil; GE - Hielo; PE - Perla; AL - Aluminio; IS - Gris; VM - Rojo; PM - Negro Mate; DU - Dorado.

 /  - Conexión tuerca tornillo

MECANISMOS COMPLETOS







		Ref.	Color
	Interruptor para Persiana 10 A - 250 V ~	90290 C	BR
	Doble Pulsador para Persiana 10 A - 250 V ~	90281 C	BR
	Toma Informática RJ45 Cat. 6A UTP (Incluye conector)	 90590 C	BR
	Toma Monobloc Schuko con Protección y Terminales de Conexión Rápida 16 A - 250 V ~	90139 C	
	Toma Monobloc Schuko con Protección 16 A - 250 V ~	90138 C	BR MF GE PE AL IS PM DU
 	Toma Monobloc Schuko 16 A - 250 V ~	90135 C	
	Doble Toma Monobloc Schuko con Protección 16 A - 250 V ~	90332 C	BR MF GE PE AL IS PM DU
 	Doble Toma Monobloc Schuko 16 A - 250 V ~	90331 C	
	Toma de Empotrar Schuko para Recarga VE 16 A - 250 V ~	 81132	
 	Toma de Empotrar Francesa para Recarga VE 16 A - 250 V ~	 81112	
	Toma de Superficie Schuko para Recarga VE 16 A - 250 V ~	 81751	
 	Toma de Superficie Francesa para Recarga VE 16 A - 250 V ~	 81752	

C - Producto Completo. | BR - Blanco; MF - Marfil; GE - Hielo; PE - Perla; AL - Aluminio; IS - Gris; PM - Negro Mate; DU - Dorado.

  - Conexión tuerca tornillo

 - Power over Ethernet

MARCOS - MONTAJE HORIZONTAL O VERTICAL

 <p>Simple 90910 T</p>	 <p>Doble 90920 T</p>	 <p>Triple 90930 T</p>	 <p>Cuádruple 90940 T</p>	 <p>Quíntuple 90950 T</p>	 <p>Estanco 90961 T</p>
---	--	---	--	--	--

IP44

ACABADOS

<p>STANDARD AQUARELLA ANIMATO CRYSTAL METALLO ARBORE PETRA</p>	<p>STANDARD AQUARELLA ANIMATO CRYSTAL METALLO ARBORE PETRA</p>	<p>STANDARD AQUARELLA ANIMATO CRYSTAL METALLO ARBORE PETRA</p>	<p>STANDARD AQUARELLA ANIMATO CRYSTAL METALLO ARBORE PETRA</p>	<p>STANDARD AQUARELLA</p>	<p>STANDARD AQUARELLA</p>
--	--	--	--	-------------------------------	-------------------------------

COLORES

<p>STANDARD</p> <p>BR - Blanco MF - Marfil</p> <p>AQUARELLA</p> <p>GE - Hielo PE - Perla AL - Aluminio IS - Gris PM - Negro Mate DU - Dorado</p>	<p>ANIMATO</p> <p>BB - Blanco/Blanco MM - Marfil/Marfil EE - Hielo/Hielo PP - Perla/Perla RG - Amarillo/Hielo DG - Verde/Hielo ZG - Azul/Hielo JG - Naranja/Hielo VG - Rojo/Hielo TS - Naranja Intenso/Gris BS - Rojo Intenso/Gris AA - Aluminio/Aluminio AS - Aluminio/Gris SS - Gris/Gris PG - Negro Mate/Hielo PA - Negro Mate/Aluminio PS - Negro Mate/Gris RR - Negro Mate/Negro Mate UG - Dorado/Hielo UU - Dorado/Dorado</p>	<p>CRYSTAL</p> <p>CG - Cristal/Hielo CP - Cristal/Perla CA - Cristal/Aluminio CS - Cristal/Gris EG - Cristal Negro/Hielo EA - Cristal Negro/Aluminio ES - Cristal Negro/Gris EP - Cristal Negro/Negro Mate</p>	<p>METALLO</p> <p>TP - Titanio/Perla IA - Inox/Aluminio OP - Oro/Perla OS - Níquel/Gris US - Aluminio/Gris RS - Cromo/Gris OU - Oro/Dorado</p>	<p>ARBORE</p> <p>FP - Haya/Perla JP - Cereza/Perla MS - Caoba/Gris NA - Nogal/Aluminio</p>	<p>PETRA</p> <p>GG - Granito/Hielo GP - Granito/Perla GA - Granito/Aluminio GS - Granito/Gris</p>
--	---	--	---	--	---

T - Tecla, Tapa o Marco.

Los acabados ANIMATO, CRYSTAL, METALLO, ARBORE y PETRA, utilizan las teclas y las tapas de la línea AQUARELLA.

APOLO 5000

ACABADOS	26
FUNCIONES	
- MECANISMOS DE MANDO	27
- DETECTORES DE MOVIMIENTO	31
- CONTROL DE TEMPERATURA	31
- SEÑALIZADORES Y ORIENTACIÓN	31
- TOMAS DE DATOS, VOZ E IMAGEN	32
- CARGADOR USB	34
- TOMAS DE CORRIENTE	35
ACCESORIOS	36
MECANISMOS COMPLETOS	37
MARCOS	38

STANDARD



BR
Blanco

MATE



BM
Blanco Mate



MF
Marfil



PM
Negro Mate

METALIZADA



PR
Plata



PL
Platino



GR
Grafito





















CH
Champán

MECANISMOS DE MANDO



		Ref.
	Interruptor Unipolar 10 AX - 250 V ~	21011
	Interruptor Luminoso 10 AX - 250 V ~	21012
	Interruptor con Piloto de Señalización 10 AX - 250 V ~	21013
	Interruptor Bipolar 10 AX - 250 V ~	21021
	Interruptor Bipolar con Piloto de Señalización 10 AX - 250 V ~	21023
	Interruptor Horario Digital de 1 Circuito 16 A (cos fi=1) - 230 V ~ - 50/60 Hz	 21041
	Interruptor Horario Digital de 2 Circuitos 6 A + 6 A (cos fi=1) - 230 V ~ - 50/60 Hz	 21042
	Interruptor Temporizado 16 A (cos fi=1) - 100 - 240 V ~ - 50/60 Hz	 21040
	Interruptor para Tarjeta Card-system Temporizado 16 A (cos fi=1) - 100 - 240 V ~ - 50/60 Hz	 21033
	Interruptor para Tarjeta Card-system 10 AX - 250 V ~	 21031
	Doble Interruptor 10 AX - 250 V ~	21061
	Doble Interruptor Luminoso 10 AX - 250 V ~	21066
	Doble Interruptor con Piloto de Señalización 10 AX - 250 V ~	21067
	Triple Interruptor 10 AX - 250 V ~	21088
	Conmutador 10 AX - 250 V ~	21071

TECLAS / TAPAS

		Ref.	Color
	Tecla Simple	50601 T	BR MF BM PM PR GR PL CH
	Tecla para Mecanismo Luminoso o con Piloto de Señalización	50602 T	BR MF BM PM PR GR PL CH
	Tecla para Mecanismo Luminoso o con Piloto de Señalización con Símbolo Luz	50797 T	BR MF BM PM PR GR PL CH
	Tecla Simple	50601 T	BR MF BM PM PR GR PL CH
	Tecla para Interruptor Bipolar	50608 T	
	Tecla para Mecanismo Luminoso o con Piloto de Señalización	50602 T	
	Tecla para Mecanismo Luminoso o Señal "HEIZUNG NOTSCHALTER"	50798 T	BR MF BM PM PR GR PL CH
	Tecla para Mecanismo Luminoso o con Piloto de Señalización con Símbolo Luz	50797 T	
	Tapa para Interruptor Horario Digital de 1 Circuito	50743 T	BR MF BM PM PR GR PL CH
	Tapa para Interruptor Horario Digital de 2 Circuitos	50744 T	BR MF BM PM PR GR PL CH
	Tecla para Interruptor Temporizado	50745 T	BR MF BM PM PR GR PL CH
	Tapa para Interruptor para Tarjeta Card-system Temporizado	50733 T	BR MF BM PM PR GR PL CH
	Tapa para Interruptor para Tarjeta Card-system	50731 T	BR MF BM PM PR GR PL CH
	Tecla Doble	50611 T	BR MF BM PM PR GR PL CH
	Tecla para Mecanismo Doble Función Luminoso	50615 T	BR MF BM PM PR GR PL CH
	Tecla Triple	50661 T	BR MF BM PM PR GR PL CH
	Tecla Simple	50601 T	BR MF BM PM PR GR PL CH
	Tecla Simple con Dos Símbolos Ventilador	50609 T	

T - Tecla, Tapa o Marco. | BR - Blanco; MF - Marfil; BM - Blanco Mate; PM - Negro Mate; PR - Plata; GR - Grafito; PL - Platino; CH - Champán.

 - Ahorro energético y aporte energético del inmueble.

 /  - Conexión tuerca tornillo

MECANISMOS DE MANDO

TECLAS / TAPAS

	Ref.
 Conmutador Luminoso 10 AX - 250 V ~	21072
 Conmutador con Piloto de Señalización 10 AX - 250 V ~	21073
 Doble Conmutador 10 AX - 250 V ~	21101
 Doble Conmutador Luminoso 10 AX - 250 V ~	21202
 Doble Conmutador con Piloto de Señalización 10 AX - 250 V ~	21203
 Conmutador de Cruce 10 AX - 250 V ~	21051
 Doble Conmutador de Cruce 10 AX - 250 V ~	21204
 Conmutador de Cruce Luminoso 10 AX - 250 V ~	21052
 Doble Conmutador de Cruce Luminoso 10 AX - 250 V ~	21205
 Pulsador 10 A - 250 V ~	21151
 Pulsador (NA+NC) 10 A - 250 V ~	21150
 Pulsador Luminoso de 250 V ~ 10 A - 250 V ~	21152
Pulsador Independiente 10 A - 250 V ~	21153
Pulsador Luminoso de 12 V 6 A - 12 V	21162
Pulsador con Luminoso para Tecla Porta-rótulos de 250 V ~ 10 A - 250 V ~	21155
Pulsador con Luminoso para Tecla Porta-rótulos de 12 V 6 A - 12 V	21165









	Ref.	Color
 Tecla para Mecanismo Luminoso o con Piloto de Señalización	50602 T	BR MF BM PM PR GR PL CH
 Tecla Doble	50611 T	BR MF BM PM PR GR PL CH
 Tecla Doble para Conmutador Ventilador	50616 T	
 Tecla para Mecanismo Doble Función Luminoso	50615 T	BR MF BM PM PR GR PL CH
 Tecla Simple	50601 T	BR MF BM PM PR GR PL CH
 Tecla para Mecanismo de Doble Función	50614 T	BR MF BM PM PR GR PL CH
 Tecla para Mecanismo Luminoso o con Piloto de Señalización	50602 T	BR MF BM PM PR GR PL CH
 Tecla para Mecanismo Doble Función Luminoso	50615 T	BR MF BM PM PR GR PL CH
 Tecla Simple	50601 T	
 Tecla con Símbolo Llave	50604 T	
 Tecla con Símbolo de Campana	50605 T	BR MF BM PM PR GR PL CH
 Tecla con Símbolo de Asistenta	50606 T	
 Tecla con Símbolo Luz	50607 T	
 Tecla para Mecanismo Luminoso o con Piloto de Señalización	50602 T	
 Tecla para Mecanismo Luminoso o con Piloto de Señalización con Símbolo Llave	50794 T	
 Tecla para Mecanismo Luminoso o con Piloto de Señalización con Símbolo Campana	50795 T	BR MF BM PM PR GR PL CH
 Tecla para Mecanismo Luminoso o con Piloto de Señalización con Símbolo Asistenta	50796 T	
 Tecla para Mecanismo Luminoso o con Piloto de Señalización con Símbolo Luz	50797 T	
 Tecla con Porta-rótulos	50603 T	BR MF BM PM PR GR PL CH

T - Tecla, Tapa o Marco. | BR - Blanco; MF - Marfil; BM - Blanco Mate; PM - Negro Mate; PR - Plata; GR - Grafito; PL - Platino; CH - Champán.



MECANISMOS DE MANDO

	Ref.
 Doble Pulsador 10 A - 250 V ~	21156
 Doble Pulsador (2NA+2NC) 10 A - 250 V ~	21154
 Doble Pulsador Luminoso 250 V ~ 10 A - 250 V ~	21206
 Doble Pulsador Luminoso 12 V 6 A - 12 V	21207
 Conmutador / Pulsador 10 AX - 250 V ~	21158
 Pulsador / Conmutador 10 AX - 250 V ~	21159
 Conmutador Luminoso / Pulsador Luminoso 10 AX - 250 V ~	21208
 Pulsador Luminoso / Conmutador Luminoso 10 AX - 250 V ~	21209
 Pulsador Cuádruple (Muy Baja Tensión) 12 V ~ - 50 mA / 32 V ~ - 18 mA	21164
 Interruptor Rotativo 10 AX - 250 V ~	21306
 Conmutador Rotativo 10 AX - 250 V ~ ON - OFF - ON.	21307
 Conmutador Rotativo de 3 Posiciones 16(4) A - 250 V ~	21300
Conmutador Rotativo de 4 Posiciones 16(4) A - 250 V ~	21305
Conmutador con Llave 10 AX - 250 V ~ ON - OFF - ON.	21352
Pulsador con Llave 10 A - 250 V ~ ON - OFF - ON.	21351
Conmutador con Tirador 10 AX - 250 V ~ NA+NC.	21092
Pulsador con Tirador 10 A - 250 V ~ NA.	21091
Pulsador con Tirador (NA+NC) 10 A - 250 V ~ NA+NC.	21090

TECLAS / TAPAS

	Ref.	Color
 Tecla Doble	50611 T	BR MF BM PM PR GR PL CH
 Tecla para Mecanismo de Doble Función Luminosa	50615 T	BR MF BM PM PR GR PL CH
 Tecla Doble	50611 T	BR MF BM PM PR GR PL CH
 Tecla para Mecanismo de Doble Función Luminosa	50615 T	BR MF BM PM PR GR PL CH
 Tecla Cuádruple	50600 T	BR MF BM PM PR GR PL CH
 Tapa para Interruptor Rotativo (ON/OFF)	50762 T	BR MF BM PM PR GR PL CH
 Tapa para Pulsador / Conmutador Rotativo para Persiana	50761 T	BR MF BM PM PR GR PL CH
 Tapa para Conmutador Rotativo con Marcación (I, O, II)	50760 T	
 Tapa para Conmutador Rotativo de 3 Posiciones	50765 T	BR MF BM PM PR GR PL CH
 Tapa para Conmutador Rotativo de 4 Posiciones	50766 T	
 Tapa para Pulsador / Conmutador con Llave	50351 T	BR MF BM PM PR GR PL CH
 Tapa para Conmutador / Pulsador con Tirador Aproximadamente 65 cm de Tirador.	50741 T	BR MF BM PM PR GR PL CH

T - Tecla, Tapa o Marco. | BR - Blanco; MF - Marfil; BM - Blanco Mate; PM - Negro Mate; PR - Plata; GR - Grafito; PL - Platino; CH - Champán.

 /  - Conexión tuerca tornillo

MECANISMOS DE MANDO

MANDOS PARA PERSIANAS		Ref.
	Interruptor para Persiana 10 A - 250 V ~	21290
	Interruptor para Persiana con Enclavamiento Mecánico 10 A - 250 V ~	21291
	Mando General de Persiana con Sensor IR 5 A (cos φ=1) - 100 - 240 V ~ - 50/60 Hz	ECO 21311
	Mando Local de Persiana con Sensor IR 5 A (cos φ=1) - 100 - 240 V ~ - 50/60 Hz	ECO 21312
	Doble Pulsador para Persiana 10 A - 250 V ~	21281
	Doble Pulsador Conmutador para Persiana 10 A - 250 V ~	21283
	Pulsador Rotativo para Persiana 10 A - 250 V ~ ON - OFF - ON.	21303

REGULADORES/CONMUTADORES DE LUZ

	Regulador de Luz RLC de Teclas 100 - 240 V ~ - 50/60 Hz 5 - 250 W/VA. 5 - 75 W LED's.	ECO 21218
	Regulador/Conmutador de Luz Rotativo Ferromagnético de 500 VA R, L 20 - 500 W/VA.	21211
	Regulador/Conmutador de Luz Rotativo Electrónico de 550 W R, C 20 - 550 W/VA.	21213
	Regulador/Conmutador de Luz Rotativo Ferromagnético para Lámparas de Bajo Consumo de 110 VA R, L 7 - 110 W/VA. 3 - 35 W LED's.	ECO 21214
	Regulador/Conmutador de Luz Rotativo Electrónico para Lámparas de Bajo Consumo de 150 W R, C 15 - 150 W/VA. 3 - 50 W LED's.	ECO 21215
	Regulador/Conmutador de Luz Rotativo Ferromagnético para Lámparas de Bajo Consumo de 250 W/VA R, L 20 - 250 W/VA. 3 - 85 W LED's.	ECO 21216
	Regulador/Conmutador de Luz Rotativo Electrónico para Lámparas de Bajo Consumo de 450 W/VA R, C 15 - 450 W/VA. 5 - 150 W LED's.	ECO 21217

TECLAS / TAPAS

	Ref.	Color
	Tecla para Interruptor para Persiana	50613 T BR MF BM PM PR GR PL CH
	Tapa para Mando General de Persiana con Sensor IR	50311 T BR MF BM PM PR GR PL CH
	Tapa para Mando Local de Persiana con Sensor IR	50312 T BR MF BM PM PR GR PL CH
	Tecla para Doble Pulsador Conmutador para Persiana	50612 T BR MF BM PM PR GR PL CH
	Tapa para Pulsador / Conmutador Rotativo para Persiana	50761 T BR MF BM PM PR GR PL CH
	Tecla para Regulador de Luz	50747 T BR MF BM PM PR GR PL CH
	Tapa para Regulador / Conmutador de Luz	50721 T BR MF BM PM PR GR PL CH

T - Tecla, Tapa o Marco. | BR - Blanco; MF - Marfil; BM - Blanco Mate; PM - Negro Mate; PR - Plata; GR - Grafito; PL - Platino; CH - Champán.

ECO - Ahorro energético y aporte energético del inmueble.

722 / 723 - Conexión tuerca tornillo

MECANISMOS DE MANDO

REGULADORES/CONMUTADORES DE LUZ

Ref.

Regulador/Interruptor de Luz Rotativo para Lámparas Fluorescentes con Balasto Electrónico 1-10 V **21210**
 Imáx - 40 mA.

Regulador/Conmutador Rotativo de Velocidad para Motores de 600 VA **21219**
 25 - 600 VA.

DETECTORES DE MOVIMIENTO

Detector de Movimiento de 1000 W **21401**
 100 - 240 V ~ - 50/60 Hz

Detector de Movimiento de 400 W **21402**
 100 - 240 V ~ - 50/60 Hz

Detector de Movimiento Instalación Mural de 1000 W **21403**
 100 - 240 V ~ - 50/60 Hz

Detector de Movimiento Instalación Mural de 400 W **21404**
 100 - 240 V ~ - 50/60 Hz

CONTROL DE TEMPERATURA

Termostato Rotativo **21234**
 16 A (cos fi = 1) - 100 - 240 V ~ - 50/60 Hz

Termostato Multifuncional **21236**
 16 A (cos fi = 1) - 100 - 240 V ~ - 50/60 Hz

Cronotermostato Multifuncional **21235**
 16 A (cos fi = 1) - 100 - 240 V ~ - 50/60 Hz

Sensor de Temperatura de Suelo para Termostato y Cronotermostato
 Longitud: 4m.
 -10 °C a 50 °C.
 IP67.
 NTC 12 K/25 °C.

SEÑALIZADORES Y ORIENTACIÓN

Luz de Orientación Blanca **21388**
 230 V ~ - 50/60 Hz
 L1 - 0,2 W; L2 - 0,4 W (4000 K)

Luz de Orientación Blanca con Batería **21389**
 230 V ~ - 50/60 Hz
 L1 - Señalización OFF; L2 - Señalización ON.

Señalizador Luminoso **21361**
 230 V ~ - 50/60 Hz
 L1 - 0,2 W; L2 - 0,4 W (4000 K)

Timbre **21990**
 250 V ~ - 50 Hz
 Tipo D.
 5/15 seg..

TECLAS / TAPAS

Ref.

Color

Tapa para Regulador / Conmutador de Luz **50721 T** BR MF BM PM PR GR PL CH

Tapa para Detector de Movimiento **50401 T** BR MF BM PM PR GR PL CH

Tapa para Detector de Movimiento Instalación Mural **50403 T** BR MF BM PM PR GR PL CH

Tapa para Termostato Rotativo **50746 T** BR MF BM PM PR GR PL CH

Tapa para Termostato Multifuncional **50749 T** BR MF BM PM PR GR PL CH

Tapa para Cronotermostato Multifuncional **50746 T** BR MF BM PM PR GR PL CH

81950 -

Tapa para Luz de Orientación **50782 T** BR MF BM PM PR GR PL CH

Difusor para Señalizador Luminoso **50781 T** IC LR VD VM

Tapa para Altavoz de 2" - 32 Ohm / Timbre **50710 T** BR MF BM PM PR GR PL CH

T - Tecla, Tapa o Marco. | BR - Blanco; MF - Marfil; BM - Blanco Mate; PM - Negro Mate; PR - Plata; GR - Grafito; PL - Platino; CH - Champán; IC - Transparente; LR - Naranja; VD - Verde; VM - Rojo.

- Ahorro energético y aporte energético del inmueble.

/ - Conexión tuerca tornillo

TOMAS DE DATOS, VOZ E IMAGEN

TOMAS TELEFÓNICAS

50 V ~ 70 V ~



Toma Telefónica
(4 conductores para Conector RJ11)

Ref. Color
21252 S BR MF
CZ AT
PT



Toma Telefónica Gel
(4 conductores para Conector RJ11)

Ref. Color
21255 S BR MF
CZ AT
PT

8 CONTACTOS



Toma Telefónica Francesa T8

21411

TOMAS DE RADIO, TELEVISIÓN Y SATÉLITE

ESTRELLA



Toma R - TV - SAT Estrella
4 - 862 MHz: < 2 dB.
950 - 2400 MHz: < 3 dB.
Paso de corriente 500 mA (DC).

21543



Toma R - TV Estrella
4 - 82 MHz: < 1 dB.
84 - 108 MHz: < 2 dB.
112 - 1000 MHz: < 1 dB.

21533

CONEXIÓN EN SERIE



Toma R - TV - SAT Final
4 - 446 MHz: < 6 dB.
470 - 862 MHz: < 9 dB.
950 - 2400 MHz: < 6 dB.
Paso de corriente 500 mA (DC).

21555



Toma R - TV - SAT Intermedia
4 - 862 MHz: < 10 dB.
950 - 2150 MHz: < 11 dB.
2150 - 2400 MHz: < 9 dB.
Paso de corriente 500 mA (DC).
Pérdidas de inserción: 3 dB.

21565



Toma R - TV Final
4 - 82 MHz: < 6 dB.
84 - 108 MHz: < 8 dB.
112 - 1000 MHz: < 7 dB.

21554



Toma R - TV Intermedia
4 - 1000 MHz: < 9 dB.
Pérdidas de inserción: 2 dB.

21564

TOMAS MÚLTIPLES

ESTRELLA



Toma Múltiple R - TV - SAT - RJ45 Cat. 6A UTP - FO SC-APC Estrella

4 - 862 MHz: < 2 dB.
950 - 2400 MHz: < 3 dB.
Paso de corriente 500 mA (DC).



21548



Toma Múltiple R - TV - SAT - RJ45 Cat. 6 UTP - FO SC-APC Estrella

4 - 862 MHz: < 2 dB.
950 - 2400 MHz: < 3 dB.
Paso de corriente 500 mA (DC).



21545

TECLAS / TAPAS

Ref. Color



Tapa para Toma Telefónica

50712 T * BR MF
BM PM PR
GR PL CH

* Nos TAPAS para Toma Telefónica da Linha **MATE** e **METALIZADA**, utilizar os mecanismos nas seguintes cores: **BM** (Blanco Mate) - **BR** (Blanco); **PM** (Negro Mate); **PR** (Plata) - **CZ** (Gris); **GR** (Grafito) - **AT** (Antracita); **PL** (Platino) - **MF** (Marfil); **CH** (Champán) - **MF** (Marfil).



Tapa para Toma Telefónica Francesa T8

50718 T BR MF
BM PM PR
GR PL CH



Tapa para Toma R - TV - SAT

50775 T BR MF
BM PM PR
GR PL CH



Tapa para Toma R - TV

50776 T



Tapa para Toma R - TV - SAT

50775 T BR MF
BM PM PR
GR PL CH



Tapa para Toma R - TV

50776 T BR MF
BM PM PR
GR PL CH



Tapa para Tomas Múltiples R - TV - SAT - RJ45 / R - TV - SAT - RJ45 - FO

50770 T BR MF
BM PM PR
GR PL CH

S - Semi-montado; **T** - Tecla, Tapa o Marco. | **BR** - Blanco; **MF** - Marfil; **BM** - Blanco Mate; **PM** - Negro Mate; **PR** - Plata; **GR** - Grafito; **PL** - Platino; **CH** - Champán; **CZ** - Gris; **AT** - Antracita.

/ - Conexión tuerca tornillo

- Power over Ethernet

TOMAS DE DATOS, VOZ E IMAGEN

TOMAS MÚLTIPLES

Ref.

ESTRELLA



Toma Múltiple R - TV - SAT - RJ45 Cat. 6A UTP Estrella 

Puede ser equipado con 1 conector FO del tipo SC APC Simplex o LC Duplex - pág. 132.

4 - 862 MHz: < 2 dB.
950 - 2400 MHz: < 3 dB.
Paso de corriente 500 mA (DC).

21547



Toma Múltiple R - TV - SAT - RJ45 Cat. 6 UTP Estrella 

Puede ser equipado con 1 conector FO del tipo SC APC Simplex o LC Duplex - pág. 132.

4 - 862 MHz: < 2 dB.
950 - 2400 MHz: < 3 dB.
Paso de corriente 500 mA (DC).

21544



Tomada Mista R - TV - SAT - 2xRJ45 Cat. 6 UTP Estrella

4 - 862 MHz: < 2 dB.
950 - 2400 MHz: < 3 dB.
Paso de corriente 500 mA (DC).

21546



Toma Múltiple R - TV - RJ45 Cat. 6A UTP - FO SC-APC Estrella 

4 - 82 MHz: < 1 dB.
84 - 108 MHz: < 2 dB.
112 - 1000 MHz: < 1 dB.

21537



Toma Múltiple R - TV - RJ45 Cat. 6 UTP - FO SC-APC Estrella 

4 - 82 MHz: < 1 dB.
84 - 108 MHz: < 2 dB.
112 - 1000 MHz: < 1 dB.

21535



Toma Múltiple R - TV - RJ45 Cat. 6A UTP Estrella 

Puede ser equipado con 1 conector FO del tipo SC APC Simplex o LC Duplex - pág. 132.

4 - 82 MHz: < 1 dB.
84 - 108 MHz: < 2 dB.
112 - 1000 MHz: < 1 dB.

21536



Toma Múltiple R - TV - RJ45 Cat. 6 UTP Estrella 

Puede ser equipado con 1 conector FO del tipo SC APC Simplex o LC Duplex - pág. 132.

4 - 82 MHz: < 1 dB.
84 - 108 MHz: < 2 dB.
112 - 1000 MHz: < 1 dB.

21534

TECLAS / TAPAS

Ref.

Color



Tapa para Tomas Múltiples R - TV - SAT - RJ45 / R - TV - SAT - RJ45 - FO

50770 T BR MF
BM PM PR
GR PL CH



Tapa para Toma Múltiple R - TV - SAT - 2xRJ45

50773 T BR MF
BM PM PR
GR PL CH



Tapa para Tomas Múltiples R - TV - RJ45 / R - TV - RJ45 - FO

50774 T BR MF
BM PM PR
GR PL CH

CARGADORES USB



Doble Cargador USB con Salidas a 20° Tipo A

100 - 240 V ~ - 50/60 Hz - 5 V = 2.4 A



21384



Tapa para Doble Cargador USB con Salidas a 20° Tipo A

50673 T BR MF
BM PM PR
GR PL CH

T - Tecla, Tapa o Marco. | BR - Blanco; MF - Marfil; BM - Blanco Mate; PM - Negro Mate; PR - Plata; GR - Grafito; PL - Platino; CH - Champán.



















 /  - Conexión tuercas tornillo

 - Power over Ethernet

TOMAS DE CORRIENTE

	Ref.
 Toma Schuko con Terminales de Conexión Rápida 16 A - 250 V ~	21130
 Toma Schuko 16 A - 250 V ~	21131
 Toma Schuko con Cargador USB 100 - 240 V ~ - 50/60 Hz - 5 V = 3.0 A	NUEVO 21137
 Toma 2P 16 A - 250 V ~	21121
 Toma Francesa con Terminales de Conexión Rápida 16 A - 250 V ~	21110
 Toma Francesa 16 A - 250 V ~	21111
 Toma Francesa con Cargador USB 100 - 240 V ~ - 50/60 Hz - 5 V = 3.0 A	NUEVO 21117
 Toma Euro-americana 15 A - 127 V ~ / 16 A - 250 V ~	21140
 Toma Americana NEMA 15 A - 127 V ~ SASO 2204 NEMA 5-15	21143
 Toma Inglesa con Protección 13 A - 250 V ~	21185
 Toma Schuko con Terminales de Conexión Rápida con Protección (Mecanismo + Tapa) 16 A - 250 V ~	50133 W
 Toma Schuko con Terminales de Conexión Rápida (Mecanismo + Tapa) 16 A - 250 V ~	50130 W
 Toma Schuko con Terminales de Conexión Rápida con Tapa Articulada con Protección (Mecanismo + Tapa) - (IP44) 16 A - 250 V ~	50496 W

TECLAS / TAPAS



















	Ref.	Color
 Tapa con Protección para Toma Schuko	50632 T	BR MF BM PM PR GR PL CH LR VD VM
 Tapa para Toma Schuko	50631 T	
 Tapa Articulada con Protección para Toma Schuko (IP44)	50634 T	BR MF BM PM PR GR PL CH VD VM
 Marco Monobloc con Protección para Toma Schuko	50903 T	BR MF BM PM PR GR PL CH
 Marco Monobloc para Toma Schuko	50902 T	
 Tapa para Toma Schuko + USB Tipo A y Tipo C	NUEVO 50630 T	BR MF BM PM PR GR PL CH
 Tapa con Protección para Toma 2P	50622 T	
 Tapa para Toma 2P	50621 T	BR MF BM PM PR GR PL CH
 Marco Monobloc para Toma Schuko para Toma 2P	50901 T	
 Tapa con Protección para Toma Francesa	50652 T	BR MF BM PM PR GR PL CH LR VD VM
 Tapa Articulada con Protección para Toma Francesa (IP44)	50654 T	BR MF BM PM PR GR PL CH VD VM
 Tapa para Toma Francesa + USB Tipo A y Tipo C	NUEVO 50650 T	BR MF BM PM PR GR PL CH
 Tapa con Protección para Toma Euro-americana	50842 T	BR MF BM PM PR GR PL CH LR VD VM
 Tapa para Toma Euro-americana	50841 T	
 Tapa con Protección para Toma Americana NEMA	50843 T	BR MF BM PM PR GR PL CH LR VD VM
 Tapa para Toma Inglesa con Protección	50642 T	BR MF BM PM PR GR PL CH
 Tapa para Toma Schuko con Terminales de Conexión Rápida con Protección (Mecanismo + Tapa)	50133 W	BR MF BM PM PR GR PL CH LR VD VM
 Tapa para Toma Schuko con Terminales de Conexión Rápida (Mecanismo + Tapa)	50130 W	
 Tapa para Toma Schuko con Terminales de Conexión Rápida con Tapa Articulada con Protección (Mecanismo + Tapa) - (IP44)	50496 W	BR MF BM PM PR GR PL CH

T - Tecla, Tapa o Marco; | W - Semi-montado embalado en Film. | BR - Blanco; MF - Marfil; BM - Blanco Mate; PM - Negro Mate; PR - Plata; GR - Grafito; PL - Platino; CH - Champán; LR - Naranja; VD - Verde; VM - Rojo.

⊗ / ⊕ - Conexión tuerca tornillo









ACCESORIOS

TECLAS / TAPAS







SALIDA DE CABLES		Ref.		Ref.	Color
	Salida de Cables con 3 Terminales 3x2,5 mm ² - 250 V ~.	21173			
	Salida de Cables con 4 Terminales 4x1,5 mm ² - 250 V ~.	21174			
VARIOS					
	Toma de Altavoz	21220			Tapa para Toma de Altavoz 50713 T BR MF BM PM PR GR PL CH
	Soporte para Tapa Ciega	21222			Tapa Ciega 50677 T BR MF BM PM PR GR PL CH
	Kit IP44 para MEC 21 - Tecla Simple		21981	-	
	Kit IP44 para MEC 21 - Tecla Doble		21982	-	
	Tapa para Protección de Mecanismos MEC 21		21971	-	
	Nivel para Montaje MEC 21		21989	-	
	Tarjeta para Interruptor Card-system		21999	-	
	Garra larga para Mecanismos Mec21 Compatible con Mecanismos de Mando.		 21998	-	
	Tecla Doble para Mecanismos Electrónicos		50610 T	BR MF BM PM PR GR PL CH	
	Tapa para Toma Multimarcas R - TV de 2 Salidas Distancia entre orificios: 30 mm.		50685 T	BR MF BM PM PR GR PL CH	
	Tapa para Toma Multimarcas R TV - SAT de 2 Salidas Distancia entre orificios: 30 mm.		50686 T	BR MF BM PM PR GR PL CH	
	Tapa para Toma Multimarcas R - TV - SAT de 3 Salidas Distancia entre orificios: 30 mm.		50680 T	BR MF BM PM PR GR PL CH	
	Tapa Central Universal Q45		50881 T	BR MF BM PM PR GR PL CH VM	
	Adaptador 50x50		50882 T	BR MF BM PM PR GR PL CH	

T - Tecla, Tapa o Marco. | BR - Blanco; MF - Marfil; BM - Blanco Mate; PM - Negro Mate; PR - Plata; GR - Grafito; PL - Platino; CH - Champán; VM - Rojo.



ACCESORIOS

VARIOS		Ref.	Color
	LED para la Serie MEC 21 y Serie 48 - 250 V~	81019	—
	LED para la Serie MEC 21 y Serie 48 - 12 V	81018	—
	Mando a Distancia Multifunciones Control Termostato Multifuncional. Control de Mandos de Persiana. Control de instalaciones de sonido. Funciona con pila CR 2032, no incluida.	81900	—
CAJAS DE SUPERFICIES Y DE EMPOTRAR			
	Caja de Superficie para Serie APOLO 5000	10981 A	BR MF
	Caja de Empotrar Para ser usado con canales con Tapas L75.	10984 A	BR
	Caja Semi Empotrable Para ser usado con canales con Tapas L75.	10985 A	BR
RELÉS PARA PERSIANAS			
	Relé Interruptor de Persiana 6 A - 230 V ~ - 50 Hz Temporizado. Conectar a Dobles Pulsadores y a Dobles Pulsadores de Persianas.	81512	—
	Relé Pulsador de Persiana 6 A - 230 V ~ - 50 Hz No temporizado. Conectar localmente a Doble Pulsador Conmutador para Persiana (Ref.º 21283 / 45283 S).	81511	—

MECANISMOS COMPLETOS

		Ref.	Color
	Interruptor para Persiana 10 A - 250 V~	50290 C	BR
	Doble Pulsador para Persiana 10 A - 250 V~	50281 C	BR
	Toma Monobloc Schuko con Protección y Terminales de Conexión Rápida 16 A - 250 V~	50139 C	
	Toma Monobloc Schuko con Protección 16 A - 250 V~	50138 C	BR MF BM PM PR GR PL CH
	Toma Monobloc Schuko 16 A - 250 V~	50135 C	
	Doble Toma Monobloc Schuko con Protección 16 A - 250 V~	50332 C	BR MF BM PM PR GR PL CH
	Doble Toma Monobloc Schuko 16 A - 250 V~	50331 C	









A - Accesorio; C - Producto Completo. | BR - Blanco; MF - Marfil; BM - Blanco Mate; PM - Negro Mate; PR - Plata; GR - Grafito; PL - Platino; CH - Champán.

 /  - Conexión tuerca tornillo

MECANISMOS COMPLETOS

		Ref.	Color
	Toma Doble Monobloc 2P con Protección 16 A - 250 V ~	50322 C	BR MF BM PM PR GR PL CH
	Toma Doble Monobloc 2P 16 A - 250 V ~	50321 C	
	Toma de Empotrar Schuko para Recarga VE 16 A - 250 V ~	NUEVO 81132	
	Toma de Empotrar Francesa para Recarga VE 16 A - 250 V ~	NUEVO 81112	
	Toma de Superficie Schuko para Recarga VE 16 A - 250 V ~	NUEVO 81751	
	Toma de Superficie Francesa para Recarga VE 16 A - 250 V ~	NUEVO 81752	

MARCOS

								IP44
Simple 50910 T	Doble Horizontal 50921 T	Doble Vertical 50922 T	Triple Horizontal 50931 T	Triple Vertical 50932 T	Cuádruple Horizontal 50941 T	Cuádruple Vertical 50942 T	Estanco 50961 T	



ACABADOS

STANDARD | MATE | METALIZADA

COLORES

STANDARD BR - Blanco MF - Marfil	MATE BM - Blanco Mate PM - Negro Mate	METALIZADA PR - Plata GR - Grafite PL - Platino CH - Champán
---	--	---

C - Producto Completo; T - Tecla, Tapa o Marco. | BR - Blanco; MF - Marfil; BM - Blanco Mate; PM - Negro Mate; PR - Plata; GR - Grafite; PL - Platino; CH - Champán.

 /  - Conexión tuerca tornillo

sirius70

ACABADOS	39
FUNCIONES	
– MECANISMOS DE MANDO	40
– DETECTORES DE MOVIMIENTO	44
– CONTROL DE TEMPERATURA	44
– SEÑALIZADORES Y ORIENTACIÓN	44
– TOMAS DE DATOS, VOZ E IMAGEN	45
– CARGADOR USB	47
– TOMAS DE CORRIENTE	48
ACCESORIOS	48
MECANISMOS COMPLETOS	50
MARCOS	50

CLASSIC



BR
Blanco



















MF
Marfil

MECANISMOS DE MANDO

		Ref.
	Interruptor Unipolar 10 AX - 250 V ~	21011
	Interruptor Luminoso 10 AX - 250 V ~	21012
	Interruptor con Piloto de Señalización 10 AX - 250 V ~	21013
	Interruptor Bipolar 10 AX - 250 V ~	21021
	Interruptor Bipolar con Piloto de Señalización 10 AX - 250 V ~	21023
 ⊖	Interruptor Horario Digital de 1 Circuito 16 A (cos φ=1) - 230 V ~ - 50/60 Hz	ECO 21041
 ⊖	Interruptor Horario Digital de 2 Circuitos 6 A + 6 A (cos φ=1) - 230 V ~ - 50/60 Hz	ECO 21042
 ⊖	Interruptor Temporizado 16 A (cos φ=1) - 100 - 240 V ~ - 50/60 Hz	ECO 21040
	Interruptor para Tarjeta Card-system Temporizado 16 A (cos φ=1) - 100 - 240 V ~ - 50/60 Hz	ECO 21033
 P22	Interruptor para Tarjeta Card-system 10 AX - 250 V ~	ECO 21031
	Doble Interruptor 10 AX - 250 V ~	21061
	Doble Interruptor Luminoso 10 AX - 250 V ~	21066
	Doble Interruptor con Piloto de Señalización 10 AX - 250 V ~	21067
 P22	Triple Interruptor 10 AX - 250 V ~	21088
	Conmutador 10 AX - 250 V ~	21071

TECLAS / TAPAS

		Ref.	Color
	Tecla Simple	70601 T	BR MF
	Tecla para Mecanismo Luminoso o con Piloto de Señalización	70602 T	BR MF
	Tecla para Mecanismo Luminoso o con Piloto de Señalización con Símbolo Luz	70797 T	BR MF
	Tecla Simple	70601 T	BR MF
	Tecla para Interruptor Bipolar	70608 T	
	Tecla para Mecanismo Luminoso o con Piloto de Señalización	70602 T	
	Tecla para Mecanismo Luminoso o con Piloto de Señalización con Tampografía "HEIZUNG NOTSCHALTER"	70798 T	BR MF
	Tecla para Mecanismo Luminoso o con Piloto de Señalización con Símbolo Luz	70797 T	
	Tapa para Interruptor Horario Digital de 1 Circuito	70743 T	BR MF
	Tapa para Interruptor Horario Digital de 2 Circuitos	70744 T	BR MF
	Tecla para Interruptor Temporizado	70745 T	BR MF
	Tapa para Interruptor para Tarjeta Card-system Temporizado	70733 T	BR MF
	Tapa para Interruptor para Tarjeta Card-system	70731 T	BR MF
	Tecla Doble	70611 T	BR MF
	Tecla para Mecanismo Doble Función Luminoso	70615 T	BR MF
	Tecla Triple	70661 T	BR MF
	Tecla Simple	70601 T	BR MF
	Tecla Simple con Dos Símbolos Ventilador	70609 T	

T - Tecla, Tapa o Marco. | BR - Blanco; MF - Marfil.

















ECO - Ahorro energético y aporte energético del inmueble.

P22 / ⊖ - Conexión tuerca tornillo

MECANISMOS DE MANDO

	Ref.
 Conmutador Luminoso 10 AX - 250 V ~	21072
 Conmutador con Piloto de Señalización 10 AX - 250 V ~	21073
 Doble Conmutador 10 AX - 250 V ~	21101
 Doble Conmutador Luminoso 10 AX - 250 V ~	21202
 Doble Conmutador con Piloto de Señalización 10 AX - 250 V ~	21203
 Conmutador de Cruce 10 AX - 250 V ~	21051
 Doble Conmutador de Cruce 10 AX - 250 V ~	21204
 Conmutador de Cruce Luminoso 10 AX - 250 V ~	21052
 Doble Conmutador de Cruce Luminoso 10 AX - 250 V ~	21205
 Pulsador 10 A - 250 V ~	21151
 Pulsador (NA+NC) 10 A - 250 V ~	21150
 Pulsador Luminoso de 250 V ~ 10 A - 250 V ~	21152
 Pulsador Independiente 10 A - 250 V ~	21153
 Pulsador Luminoso de 12 V 6 A - 12 V	21162
 Pulsador con Luminoso para Tecla Porta-rótulos de 250 V ~ 10 A - 250 V ~	21155
 Pulsador con Luminoso para Tecla Porta-rótulos de 12 V 6 A - 12 V	21165

TECLAS / TAPAS

	Ref.	Color
 Tecla para Mecanismo Luminoso o con Piloto de Señalización	70602 T	BR MF
 Tecla Doble	70611 T	BR MF
 Tecla Doble para Conmutador Ventilador	70616 T	
 Tecla para Mecanismo Doble Función Luminoso	70615 T	BR MF
 Tecla Simple	70601 T	BR MF
 Tecla para Mecanismo de Doble Función	70614 T	BR MF
 Tecla para Mecanismo Luminoso o con Piloto de Señalización	70602 T	BR MF
 Tecla para Mecanismo Doble Función Luminoso	70615 T	BR MF
Tecla Simple	70601 T	
Tecla con Símbolo Llave 	70604 T	
Tecla con Símbolo de Campana 	70605 T	BR MF
Tecla con Símbolo de Asistente 	70606 T	
Tecla con Símbolo Luz 	70607 T	
Tecla para Mecanismo Luminoso o con Piloto de Señalización	70602 T	
Tecla para Mecanismo Luminoso o con Piloto de Señalización con Símbolo Llave 	70794 T	
Tecla para Mecanismo Luminoso o con Piloto de Señalización con Símbolo Campana 	70795 T	BR MF
Tecla para Mecanismo Luminoso o con Piloto de Señalización con Símbolo Asistente 	70796 T	
Tecla para Mecanismo Luminoso o con Piloto de Señalización con Símbolo Luz 	70797 T	
 Tecla con Porta-rótulos	70603 T	BR MF

T - Tecla, Tapa o Marco. | BR - Blanco; MF - Marfil.

MECANISMOS DE MANDO

	Ref.
 Doble Pulsador 10 A - 250 V ~	21156
 Doble Pulsador (2NA+2NF) 10 A - 250 V ~	21154
 Doble Pulsador Luminoso 250 V ~ 10 A - 250 V ~	21206
 Doble Pulsador Luminoso 12 V 6 A - 12 V	21207
 Conmutador / Pulsador 10 AX - 250 V ~	21158
 Pulsador / Conmutador 10 AX - 250 V ~	21159
 Conmutador Luminoso / Pulsador Luminoso 10 AX - 250 V ~	21208
 Pulsador Luminoso / Conmutador Luminoso 10 AX - 250 V ~	21209
 Pulsador Cuádruple (Muy Baja Tensión) 12 V ~ - 50 mA / 32 V ~ - 18 mA	21164
 Interruptor Rotativo 10 AX - 250 V ~	21306
 Conmutador Rotativo 10 AX - 250 V ~ ON - OFF - ON.	21307
 Conmutador Rotativo de 3 Posiciones 16(4) A - 250 V ~	21300
 Conmutador Rotativo de 4 Posiciones 16(4) A - 250 V ~	21305
Conmutador con Llave 10 AX - 250 V ~ ON - OFF - ON.	21352
Pulsador con Llave 10 A - 250 V ~ ON - OFF - ON.	21351
Conmutador con Tirador 10 AX - 250 V ~ NA+NC.	21092
Pulsador con Tirador 10 A - 250 V ~ NA.	21091
Pulsador con Tirador (NA+NC) 10 A - 250 V ~ NA+NC.	21090

TECLAS / TAPAS

	Ref.	Color
 Tecla Doble	70611 T	BR MF
 Tecla para Mecanismo Doble Función Luminoso	70615 T	BR MF
 Tecla Doble	70611 T	BR MF
 Tecla para Mecanismo Doble Función Luminoso	70615 T	BR MF
 Tecla Cuádruple	70600 T	BR MF
 Tapa para Interruptor Rotativo (ON/OFF)	70762 T	BR MF
 Tapa para Pulsador / Conmutador Rotativo para Persiana	70761 T	BR MF
 Tapa para Conmutador Rotativo con Marcación (I, 0, II)	70760 T	
 Tapa para Conmutador Rotativo de 3 Posiciones	70765 T	BR MF
 Tapa para Conmutador Rotativo de 4 Posiciones	70766 T	
 Tapa para Pulsador / Conmutador con Llave	70351 T	BR MF
 Tapa para Conmutador / Pulsador con Tirador Aproximadamente 65 cm de Tirador.	70741 T	BR MF







T - Tecla, Tapa o Marco. | BR - Blanco, MF - Marfil.

⊗/⊕ / ⊖ - Conexión tuerca tornillo



MECANISMOS DE MANDO

MANDOS PARA PERSIANAS		Ref.
	Interruptor para Persiana 10 A - 250 V ~	21290
	Interruptor para Persiana con Enclavamiento Mecánico 10 A - 250 V ~	21291
	Mando General de Persiana con Sensor IR 5 A (cos φ=1) - 100 - 240 V ~ - 50/60 Hz	 21311
	Mando Local de Persiana con Sensor IR 5 A (cos φ=1) - 100 - 240 V ~ - 50/60 Hz	 21312
	Doble Pulsador para Persiana 10 A - 250 V ~	21281
	Doble Pulsador Conmutador para Persiana 10 A - 250 V ~	21283
	Pulsador Rotativo para Persiana 10 A - 250 V ~ ON - OFF - ON.	21303
REGULADORES/CONMUTADORES DE LUZ		
	Regulador de Luz RLC de Teclas 100 - 240 V ~ - 50/60 Hz 5 - 250 W/VA. 5 - 75 W LED's.	 21218
	Regulador/Conmutador de Luz Rotativo Ferromagnético de 500 VA R, L 20 - 500 W/VA.	 21211
	Regulador/Conmutador de Luz Rotativo Electrónico de 550 W R, C 20 - 550 W/VA.	 21213
	Regulador/Conmutador de Luz Rotativo Ferromagnético para Lámparas de Bajo Consumo de 110 VA R, L 7 - 110 W/VA. 3 - 35 W LED's.	 21214
	Regulador/Conmutador de Luz Rotativo Electrónico para Lámparas de Bajo Consumo de 150 W R, C 15 - 150 W/VA. 3 - 50 W LED's.	 21215
	Regulador/Conmutador de Luz Rotativo Ferromagnético para Lámparas de Bajo Consumo de 250 W/VA R, L 20 - 250 W/VA. 3 - 85 W LED's.	 21216
	Regulador/Conmutador de Luz Rotativo Electrónico para Lámparas de Bajo Consumo de 450 W/VA R, C 15 - 450 W/VA. 5 - 150 W LED's.	 21217

TECLAS / TAPAS

	Ref.	Color
	Tecla para Interruptor para Persiana	70613 T BR MF
	Tapa para Mando General de Persiana con Sensor IR	70311 T BR MF
	Tapa para Mando Local de Persiana con Sensor IR	70312 T BR MF
	Tecla para Doble Pulsador Conmutador para Persiana	70612 T BR MF
	Tapa para Pulsador / Conmutador Rotativo para Persiana	70761 T BR MF
	Tecla para Regulador de Luz	70747 T BR MF
	Tapa para Regulador / Conmutador de Luz	70721 T BR MF

T - Tecla, Tapa o Marco. | BR - Blanco; MF - Marfil.

 - Ahorro energético y aporte energético del inmueble. /  - Conexión tuerca tornillo

MECANISMOS DE MANDO

REGULADORES/CONMUTADORES DE LUZ

Ref.

	Regulador/Interruptor de Luz Rotativo para Lámparas Fluorescentes con Balasto Electrónico 1-10 V Imáx - 40 mA.		21210
	Regulador/Conmutador Rotativo de Velocidad para Motores de 600 VA 25 - 600 VA.		21219

DETECTORES DE MOVIMIENTO

	Detector de Movimiento de 1000 W 100 - 240 V ~ - 50/60 Hz		21401
	Detector de Movimiento de 400 W 100 - 240 V ~ - 50/60 Hz		21402
	Detector de Movimiento Instalación Mural de 1000 W 100 - 240 V ~ - 50/60 Hz		21403
	Detector de Movimiento Instalación Mural de 400 W 100 - 240 V ~ - 50/60 Hz		21404

CONTROL DE TEMPERATURA

	Termostato Rotativo 16 A (cos fi = 1) - 100 - 240 V ~ - 50/60 Hz		21234
	Termostato Multifuncional 16 A (cos fi = 1) - 100 - 240 V ~ - 50/60 Hz		21236
	Cronotermostato Multifuncional 16 A (cos fi = 1) - 100 - 240 V ~ - 50/60 Hz		21235
	Sensor de Temperatura de Suelo para Termostato y Cronotermostato Longitud: 4 m. -10 °C a 50 °C. IP67. NTC 12 K/25 °C.		81950

SEÑALIZADORES Y ORIENTACIÓN

	Luz de Orientación Blanca 230 V ~ - 50/60 Hz L1 - 0,2 W; L2 - 0,4 W (4000 K)		21388
	Luz de Orientación Blanca con Batería 230 V ~ - 50/60 Hz L1 - Señalización OFF; L2 - Señalización ON.		21389
	Señalizador Luminoso 230 V ~ - 50/60 Hz L1 - 0,2 W; L2 - 0,4 W (4000 K)		21361
	Timbre 250 V ~ - 50 Hz Tipo D. 5/15 seg..		21990

TECLAS / TAPAS

Ref.

Color

	70721 T	BR MF
--	----------------	-------

	70401 T	BR MF
--	----------------	-------

	70403 T	BR MF
--	----------------	-------

	70746 T	BR MF
--	----------------	-------

	70749 T	BR MF
--	----------------	-------

	70748 T	BR MF
--	----------------	-------

	70782 T	BR MF
--	----------------	-------

	70781 T	IC LR VD VM
--	----------------	-------------

	70710 T	BR MF
--	----------------	-------

T - Tecla, Tapa o Marco. | BR - Blanco; MF - Marfil; IC - Transparente; LR - Naranja; VD - Verde; VM - Rojo.

- Ahorro energético y aporte energético del inmueble.

- Conexión tuerca tornillo

TOMAS DE DATOS, VOZ E IMAGEN

TECLAS / TAPAS

TOMAS TELEFÓNICAS		Ref.	Color
50 V ~ 70 V -			
	Toma Telefónica (4 conductores para Conector RJ11)	21252 S	BR MF
	Toma Telefónica Gel (4 conductores para Conector RJ11)	21255 S	BR MF

	Ref.	Color	
	Tapa para Toma Telefónica	70712 T	BR MF

8 CONTACTOS



	Toma Telefónica Francesa T8	21411	
--	-----------------------------	--------------	--

	Tapa para Toma Telefónica Francesa T8	70718 T	BR MF
---	---------------------------------------	----------------	-------





TOMAS DE RADIO, TELEVISIÓN Y SATÉLITE



ESTRELLA

	Toma R - TV - SAT Estrella 4 - 862 MHz: < 2 dB. 950 - 2400 MHz: < 3 dB. Paso de corriente 500 mA [DC].	21543	
	Toma R - TV Estrella 4 - 82 MHz: < 1 dB. 84 - 108 MHz: < 2 dB. 112 - 1000 MHz: < 1 dB.	21533	

	Tapa para Toma R - TV - SAT	70775 T	BR MF
	Tapa para Toma R - TV	70776 T	

CONEXIÓN EN SERIE

	Toma R - TV - SAT Final 4 - 446 MHz: < 6 dB. 470 - 862 MHz: < 9 dB. 950 - 2400 MHz: < 6 dB. Paso de corriente 500 mA [DC].	21555	
	Toma R - TV - SAT Intermedia 4 - 862 MHz: < 10 dB. 950 - 2150 MHz: < 11 dB. 2150 - 2400 MHz: < 9 dB. Paso de corriente 500 mA [DC]. Pérdidas de inserción: 3 dB.	21565	
	Toma R - TV Final 4 - 82 MHz: < 6 dB. 84 - 108 MHz: < 8 dB. 112 - 1000 MHz: < 7 dB.	21554	
	Toma R - TV Intermedia 4 - 1000 MHz: < 9 dB. Pérdidas de inserción: 2 dB.	21564	

	Tapa para Toma R - TV - SAT	70775 T	BR MF
	Tapa para Toma R - TV	70776 T	BR MF



TOMAS MÚLTIPLES

ESTRELLA

	Toma Múltiple R - TV - SAT - RJ45 Cat. 6A UTP - FO SC-APC Estrella 4 - 862 MHz: < 2 dB. 950 - 2400 MHz: < 3 dB. Paso de corriente 500 mA [DC].	 21548	
	Toma Múltiple R - TV - SAT - RJ45 Cat. 6 UTP - FO SC-APC Estrella 4 - 862 MHz: < 2 dB. 950 - 2400 MHz: < 3 dB. Paso de corriente 500 mA [DC].	 21545	

	Tapa para Tomas Múltiples R - TV - SAT - RJ45 / R - TV - SAT - RJ45 - FO	70770 T	BR MF
---	--	----------------	-------

S - Semi-montado; T - Tecla, Tapa o Marco. | BR - Blanco; MF - Marfil.

 /  - Conexión tuerca tornillo - Power over Ethernet

TOMAS DE DATOS, VOZ E IMAGEN

TOMAS MÚLTIPLES

Ref.

ESTRELLA



Toma Múltiple R - TV - SAT - RJ45 Cat. 6A UTP Estrella

Puede ser equipado con 1 conector FO del tipo SC APC Simplex o LC Duplex - pág. 132.

4 - 862 MHz: < 2 dB.

950 - 2400 MHz: < 3 dB.

Paso de corriente 500 mA (DC).



21547



Toma Múltiple R - TV - SAT - RJ45 Cat. 6 UTP Estrella

Puede ser equipado con 1 conector FO del tipo SC APC Simplex o LC Duplex - pág. 132.

4 - 862 MHz: < 2 dB.

950 - 2400 MHz: < 3 dB.

Paso de corriente 500 mA (DC).



21544



Toma Múltiple R - TV - SAT - 2 x RJ45 Cat. 6 UTP Estrella

4 - 862 MHz: < 2 dB.

950 - 2400 MHz: < 3 dB.

Paso de corriente 500 mA (DC).

21546



Toma Múltiple R - TV - RJ45 Cat. 6A UTP - FO SC-APC Estrella

4 - 82 MHz: < 1 dB.

84 - 108 MHz: < 2 dB.

112 - 1000 MHz: < 1 dB.



21537



Toma Múltiple R - TV - RJ45 Cat. 6 UTP - FO SC-APC Estrella

4 - 82 MHz: < 1 dB.

84 - 108 MHz: < 2 dB.

112 - 1000 MHz: < 1 dB.



21535



Toma Múltiple R - TV - RJ45 Cat. 6A UTP Estrella

Puede ser equipado con 1 conector FO del tipo SC APC Simplex o LC Duplex - pág. 132.

4 - 82 MHz: < 1 dB.

84 - 108 MHz: < 2 dB.

112 - 1000 MHz: < 1 dB.



21536



Toma Múltiple R - TV - RJ45 Cat. 6 UTP Estrella

Puede ser equipado con 1 conector FO del tipo SC APC Simplex o LC Duplex - pág. 132.

4 - 82 MHz: < 1 dB.

84 - 108 MHz: < 2 dB.

112 - 1000 MHz: < 1 dB.



21534

TECLAS / TAPAS

Ref.

Color



Tapa para Tomas Múltiples R - TV - SAT - RJ45 / R - TV - SAT - RJ45 - FO

70770 T

BR MF



Tapa para Toma Múltiple R - TV - SAT - 2xRJ45

70773 T

BR MF



Tapa para Tomas Múltiples R - TV - RJ45 / R - TV - RJ45 - FO

70774 T

BR MF

CARGADOR USB



Doble Cargador USB con Salidas a 20° Tipo A

100 - 240 V ~ - 50/60 Hz - 5 V = 2.4 A

21384



Tapa para Doble Cargador USB con Salidas a 20° Tipo A

70673 T

BR MF

T - Tecla, Tapa o Marco. | BR - Blanco; MF - Marfil.

/ - Conexión tuerca tornillo





- Power over Ethernet

TOMAS DE CORRIENTE















		Ref.
	Toma Schuko con Terminales de Conexión Rápida 16 A - 250 V ~	21130
	Toma Schuko 16 A - 250 V ~	21131
	Toma 2P 16 A - 250 V ~	21121
	Toma Francesa con Terminales de Conexión Rápida 16 A - 250 V ~	21110
	Toma Francesa 16 A - 250 V ~	21111
	Toma Euro-americana 15 A - 127 V ~ / 16 A - 250 V ~	21140
	Toma Americana NEMA 15 A - 127 V ~ SASO 2204 NEMA 5-15	21143
	Toma Inglesa con Protección 13 A - 250 V ~	21185

ACCESORIOS

SALIDA DE CABLES

		Ref.
	Salida de Cables con 3 Terminales 3x2,5 mm ² - 250 V ~	21173
	Salida de Cables con 4 Terminales 4x1,5 mm ² - 250 V ~	21174
VARIOS		
	Toma de Altavoz	21220
	Soporte para Tapa Ciega	21222

TECLAS / TAPAS

		Ref.	Color
	Tapa con Protección para Toma Schuko	70632 T	BR MF LR VD VM
	Tapa para Toma Schuko	70631 T	
	Tapa Articulada con Protección para Toma Schuko (IP44)	70634 T	BR MF VD VM
	Marco Monobloc con Protección para Toma Schuko	70903 T	BR MF
	Marco Monobloc para Toma Schuko	70902 T	
	Tapa con Protección para Toma 2P	70622 T	
	Tapa para Toma 2P	70621 T	BR MF
	Marco Monobloc para Toma Schuko para Toma 2P	70901 T	
	Tapa con Protección para Toma Francesa	70652 T	BR MF LR VD VM
	Tapa Articulada con Protección para Toma Francesa (IP44)	70654 T	BR MF VD VM
	Tapa con Protección para Toma Euro-americana	70842 T	BR MF LR VD VM
	Tapa para Toma Euro-americana	70841 T	
	Tapa con Protección para Toma Americana NEMA	70843 T	BR MF LR VD VM
	Tapa para Toma Inglesa con Protección	70642 T	BR MF





















TECLAS / TAPAS

		Ref.	Color
	Tapa para Salida de Cables	70671 T	BR MF
	Tapa para Toma de Altavoz	70713 T	BR MF
	Tapa Ciega	70677 T	BR MF

T - Tecla, Tapa o Marco. | BR - Blanco; MF - Marfil; LR - Naranja; VD - Verde; VM - Rojo.



















⊕/⊖ / ⊕ - Conexión tuerca tornillo

ACCESORIOS









VARIOS		Ref.	Color
	Kit IP44 para MEC 21 - Tecla Simple	21981	-
	Kit IP44 para MEC 21 - Tecla Doble	21982	-
	Tapa para Protección de Mecanismos MEC 21	21971	-
	Nivel para Montaje MEC 21	21989	-
	Tarjeta para Interruptor Card-system	21999	-
	Garra larga para Mecanismos Mec21 Compatible con Mecanismos de Mando.	 21998	-
	Tecla Doble para Mecanismos Electrónicos	70610 T	BR MF
	Tapa para Toma Multimarcas R - TV de 2 Salidas Distancia entre orificios: 30 mm.	70685 T	BR MF
	Tapa para Toma Multimarcas R TV - SAT de 2 Salidas Distancia entre orificios: 30 mm.	70686 T	BR MF
	Tapa para Toma Multimarcas R - TV - SAT de 3 Salidas Distancia entre orificios: 30 mm.	70680 T	BR MF
	Tapa Central Universal Q45	70881 T	BR MF VM
	LED para la Serie MEC 21 y Serie 48 - 250 V~	81019	-
	LED para la Serie MEC 21 y Serie 48 - 12 V	81018	-
	Mando a Distancia Multifunciones Control Termostato Multifuncional. Control de Mandos de Persiana. Control de instalaciones de sonido. Funciona con pila CR 2032, no incluida.	81900	-
CAJAS DE SUPERICIES Y DE EMPOTRAR			
	Caja de Superficie para Serie Sirius 70	10975 A	BR MF
	Caja de Empotrar Para ser usado con canales con Tapas L75.	10984 A	BR
	Caja Semi Empotrable Para ser usado con canales con Tapas L75.	10985 A	BR
RELÉS PARA PERSIANAS			
	Relé Interruptor de Persiana 6 A - 230 V ~ - 50 Hz Temporizado. Conectar a Dobles Pulsadores y a Dobles Pulsadores de Persianas.	81512	-
	Relé Pulsador de Persiana 6 A - 230 V ~ - 50 Hz No temporizado. Conectar localmente a Doble Pulsador Conmutador para Persiana (Ref.º 21283 / 45283 S).	81511	-

T - Tecla, Tapa o Marco; A - Accesorio. | BR - Blanco; MF - Marfil; VM - Rojo.

MECANISMOS COMPLETOS

		Ref.	Color
	Interruptor para Persiana 10 A - 250 V ~	70290 C	BR
	Doble Pulsador para Persiana 10 A - 250 V ~	70281 C	BR
	Toma Monobloc Schuko con Protección y Terminales de Conexión Rápida 16 A - 250 V ~	70139 C	
	Toma Monobloc Schuko con Protección 16 A - 250 V ~	70138 C	BR MF
 	Toma Monobloc Schuko 16 A - 250 V ~	70135 C	
	Doble Toma Monobloc Schuko con Protección 16 A - 250 V ~	70332 C	BR MF
 	Doble Toma Monobloc Schuko 16 A - 250 V ~	70331 C	
	Toma Doble Monobloc 2P con Protección 16 A - 250 V ~	70322 C	BR MF
 	Toma Doble Monobloc 2P 16 A - 250 V ~	70321 C	
	Toma de Empotrar Schuko para Recarga VE 16 A - 250 V ~	NUEVO 81132	
 	Toma de Empotrar Francesa para Recarga VE 16 A - 250 V ~	NUEVO 81112	
	Toma de Superficie Schuko para Recarga VE 16 A - 250 V ~	NUEVO 81751	
 	Toma de Superficie Francesa para Recarga VE 16 A - 250 V ~	NUEVO 81752	

MARCOS

								IP44
Simple 70910 T	Doble Horizontal 70921 T	Doble Vertical 70922 T	Triple Horizontal 70931 T	Triple Vertical 70932 T	Cuádruple Horizontal 70941 T	Cuádruple Vertical 70942 T	Estanco 70961 T	

ACABADOS

CLASSIC

COLORES

BR - Blanco
MF - Marfil

C - Producto Completo, T - Tecla, Tapa o Marco, | BR - Blanco; MF - Marfil.

 - Conexión tuerca tornillo

mec 21

Diseño diverso,
en un solo mecanismo para una variada
opción de funciones y acabados.



SISTEMA MEC Q45

Siza

58

QUADRA

60

LATINA

62

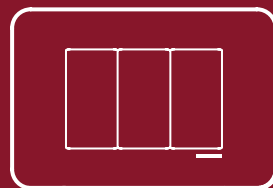
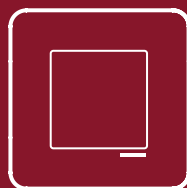
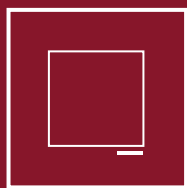
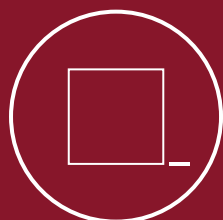

02

MEC Q45

Mecanismos semi-montados, que permiten un fácil montaje y la elección de funciones y acabados.

Sistema con el que se puede elegir entre 3 series (una de éstas con diferentes matrices, la serie LATINA).

Una vez definidas las funciones, es fácil escoger los marcos, colores y acabados de cada una de las series.

1. REFERENCIA

- referencia del **producto semi-montado**;
- del **adaptador** correspondiente;
- del **marco** de la serie seleccionada.

2. ACABADO

- agregar a la referencia del marco y del producto semi-montado, la **sigla** del **acabado** elegido.

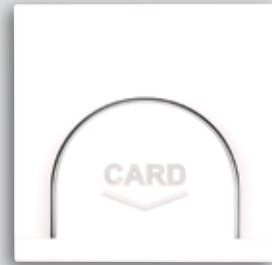

MECANISMO SEMI-MONTADO,
haciendo que el montaje sea fácil y la elección simple.

MECANISMO SEMI-MONTADO

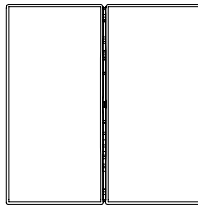

SOPORTE

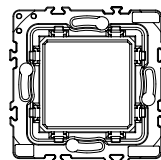
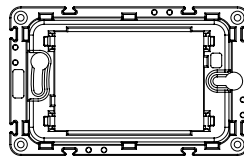
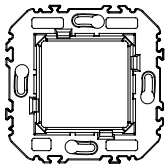

MARCO

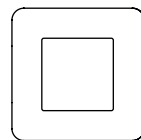
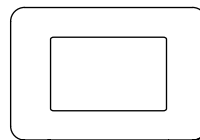
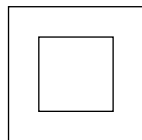
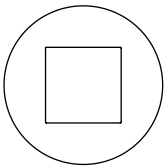

PRODUCTO COMPLETO

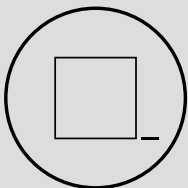

Siza

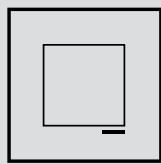

QUADRA

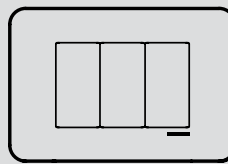

LATINA

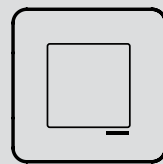

MEC Q45



MEC Q45

ACABADOS

- SIZA 58
- QUADRA 60
- LATINA 62

FUNCIONES

- MECANISMOS DE MANDO 64
- DETECTORES DE MOVIMIENTO 67
- CONTROL DE TEMPERATURA 67
- SEÑALIZADORES Y ORIENTACIÓN 68
- TOMAS DE DATOS, VOZ E IMAGEN 68
- CARGADORES USB 70
- TOMAS DE CORRIENTE 70

ACCESORIOS 73

MECANISMOS COMPLETOS 75

MARCOS 76

STANDARD

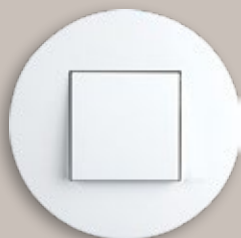

BR
Blanco

MATE Y ALUMINIO



BM
Blanco Mate



PM
Negro Mate



AL
Aluminio



STANDARD



BR
Blanco

MATE Y ALUMINIO



BM
Blanco Mate



PM
Negro Mate



AL
Aluminio



STANDARD



BR
Blanco

LYRA

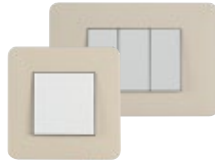

CE
Crema

LIGNA



RO
Roble

AQUARELLA

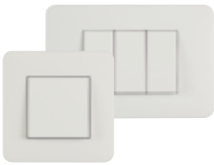

BM
Blanco Mate

AZ
Azul

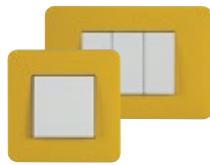

AM
Amarillo

FA
Haya

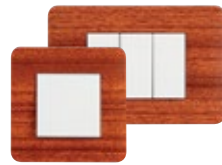

MG
Caoba



AL
Aluminio



VR
Verde



WG
Wengé



PM
Negro Mate



LR
Naranja

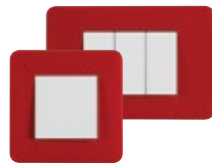

RJ
Rojo

ACABADOS

METALLUM



LU
Aluminio



RB
Rubro



CO
Cobre



OR
Oro



CR
Cromo

CROMA



BH
Blanco Mate / Cromo



AH
Aluminio / Cromo



PH
Negro Mate / Cromo

CRYSTAL



CB
Cristal / Blanco Mate



CA
Cristal / Aluminio



CK
Cristal / Negro Mate



EB
Cristal Negro / Blanco Mate

























EA
Cristal Negro / Aluminio





EP
Cristal Negro / Negro Mate

MECANISMOS DE MANDO























		Ref.	Color
	Interruptor Unipolar - 2 Módulos 10 AX - 250 V ~	45011 S	
	Interruptor Unipolar - 1 Módulo 10 AX - 250 V ~	45010 S	
	Interruptor Luminoso - 2 Módulos 10 AX - 250 V ~	45012 S	
	Interruptor Luminoso - 1 Módulo 10 AX - 250 V ~	45015 S	
	Interruptor con Piloto de Señalización - 2 Módulos 10 AX - 250 V ~	45013 S	
	Interruptor con Piloto de Señalización - 1 Módulo 10 AX - 250 V ~	45016 S	
	Interruptor Bipolar - 2 Módulos 10 AX - 250 V ~	45021 S	
	Interruptor Bipolar - 1 Módulo 10 AX - 250 V ~	45020 S	
	Interruptor Bipolar con Piloto de Señalización - 2 Módulos 10 AX - 250 V ~	45023 S	
	Interruptor Bipolar con Piloto de Señalización - 1 Módulo 10 AX - 250 V ~	45026 S	BR BM PM AL
 ⊖	Interruptor Horario Digital de 1 Circuito - 2 Módulos 16 A (cos φ = 1) - 230 V ~ - 50/60 Hz	 45041 S	
 ⊖	Interruptor Horario Digital de 2 Circuitos - 2 Módulos 6 A + 6 A (cos φ = 1) - 230 V ~ - 50/60 Hz	 45042 S	
 ⊖	Interruptor para Tarjeta Card-system Temporizado - 2 Módulos 16 A (cos φ = 1) - 100 - 240 V ~ - 50/60 Hz	 45033 S	
 ⊖	Interruptor Temporizado - 2 Módulos 16 A (cos φ = 1) - 100 - 240 V ~ - 50/60 Hz	 45040 S	
	Doble Interruptor - 2 Módulos 10 AX - 250 V ~	45061 S	
	Conmutador - 2 Módulos 10 AX - 250 V ~	45071 S	
	Conmutador - 1 Módulo 10 AX - 250 V ~	45070 S	
	Conmutador Luminoso - 2 Módulos 10 AX - 250 V ~	45072 S	
	Conmutador Luminoso - 1 Módulo 10 AX - 250 V ~	45074 S	

S - Semi-montado. | BR - Blanco; BM - Blanco Mate; PM - Negro Mate; AL - Aluminio.

 - Ahorro energético y aporte energético del inmueble.























 / ⊖ - Conexión tuerca tornillo

MECANISMOS DE MANDO

	Ref.	Color
 Conmutador con Piloto de Señalización - 2 Módulos 10 AX - 250 V ~	45073 S	
 Conmutador con Piloto de Señalización - 1 Módulo 10 AX - 250 V ~	45076 S	
 Conmutador Bipolar - 2 Módulos 10 AX - 250 V ~	45077 S	
 Conmutador de Cruce - 2 Módulos 10 AX - 250 V ~	45051 S	
 Conmutador de Cruce - 1 Módulo 10 AX - 250 V ~	45050 S	
 Conmutador de Cruce Luminoso - 2 Módulos 10 AX - 250 V ~	45052 S	
 Conmutador de Cruce Luminoso - 1 Módulo 10 AX - 250 V ~	45053 S	
 Pulsador - 2 Módulos 10 A - 250 V ~	45151 S	
 Pulsador - 1 Módulo 10 A - 250 V ~	45161 S	
 Pulsador (NA+NC) - 2 Módulos 10 A - 250 V ~	45150 S	BR BM PM AL
 Pulsador (NA+NC) - 1 Módulo 10 A - 250 V ~	45166 S	
 Pulsador con Símbolo de Campana - 2 Módulos  10 A - 250 V ~	45177 S	
 Pulsador con Símbolo de Campana - 1 Módulo  10 A - 250 V ~	45167 S	
 Pulsador con Símbolo Luz - 2 Módulos  10 A - 250 V ~	45179 S	
 Pulsador con Símbolo Luz - 1 Módulo  10 A - 250 V ~	45169 S	
 Pulsador Luminoso (250 V ~) - 2 Módulos 10 A - 250 V ~	45152 S	
 Pulsador Luminoso (250 V ~) - 1 Módulo 10 A - 250 V ~	45160 S	
 Pulsador Luminoso (12 V) - 2 Módulos 6 A - 12 V	45162 S	
 Pulsador Luminoso (12 V) - 1 Módulo 6 A - 12 V	45163 S	

S - Semi-montado. | BR - Blanco; BM - Blanco Mate; PM - Negro Mate; AL - Aluminio.

MECANISMOS DE MANDO

	Ref.	Color
 Pulsador con Señalización Independiente (250 V ~) - 2 Módulos 10 A - 250 V ~	45154 S	
 Pulsador con Señalización Independiente (250 V ~) - 1 Módulo 10 A - 250 V ~	45153 S	
 Pulsador con Señalización Independiente (12 V) - 2 Módulos 6 A - 12 V	45158 S	
 Pulsador con Señalización Independiente (12 V) - 1 Módulo 6 A - 12 V	45157 S	
 Pulsador Luminoso con Símbolo Luz - 2 Módulos 10 A - 250 V ~	45172 S	
 Pulsador Luminoso con Símbolo Luz - 1 Módulo 10 A - 250 V ~	45171 S	
 Doble Pulsador - 2 Módulos 10 A - 250 V ~	45156 S	
 Pulsador/Conmutador - 2 Módulos 10 AX - 250 V ~	45159 S	
 Pulsador Cuádruple (Muy Baja Tensión) - 2 Módulos 12 V ~ - 50 mA / 32 V ~ - 18 mA	45164 S	
 Interruptor Rotativo - 2 Módulos 10 AX - 250 V ~	 45302 S	BR BM PM AL
 Conmutador Rotativo - 2 Módulos 10 AX - 250 V ~	 45301 S	
 Conmutador con Llave - 2 Módulos 10 AX - 250 V ~ ON - OFF - ON.	 45352 S	
 Pulsador con Llave - 2 Módulos 10 A - 250 V ~ ON - OFF - ON.	 45351 S	
 Conmutador con Tirador - 2 Módulos 10 AX - 250 V ~ NA + NC. Aproximadamente 65 cm de Tirador.	 45092 S	
 Pulsador con Tirador (NA+NC) - 2 Módulos 10 A - 250 V ~ NA + NC. Aproximadamente 65 cm de Tirador.	 45090 S	
MANDOS PARA PERSIANAS		
 Interruptor para Persiana - 2 Módulos 10 A - 250 V ~	45293 S	BR BM PM AL
 Interruptor para Persiana con Enclavamiento Mecánico - 2 Módulos 10 A - 250 V ~	45295 S	

S - Semi-montado. | BR - Blanco; BM - Blanco Mate; PM - Negro Mate; AL - Aluminio.









 - Conexión tuerca tornillo

MECANISMOS DE MANDO



MANDOS PARA PERSIANAS

		Ref.	Color
	Doble Pulsador para Persiana - 2 Módulos 10 A - 250 V ~	45281 S	
	Doble Pulsador Conmutador para Persiana - 2 Módulos 10 A - 250 V ~	45283 S	
	Conmutador Rotativo de Persiana - 2 Módulos 10 A - 250 V ~	 45305 S	
 PZZ	Pulsador Rotativo para Persiana - 2 Módulos 10 A - 250 V ~	 45303 S	BR BM PM AL
	Mando General de Persiana con Sensor IR - 2 Módulos 5 A (cos ϕ = 1) - 100 - 240 V ~ - 50/60 Hz	45311 S	
	Mando Local de Persiana con Sensor IR - 2 Módulos 5 A (cos ϕ = 1) - 100 - 240 V ~ - 50/60 Hz	45312 S	
REGULADORES/CONMUTADORES DE LUZ			
	Regulador de Luz RLC Rotativo - 2 Módulos 100 - 240 V ~ - 50/60 Hz 5 - 250 W/VA. 5 - 75 W LED's.	 45216 S	
	Regulador de Luz RLC de Teclas - 2 Módulos 100 - 240 V ~ - 50/60 Hz 5 - 250 W/VA. 5 - 75 W LED's.	 45218 S	BR BM PM AL

DETECTORES DE MOVIMIENTO



	Detector de Movimiento de 1000 W - 2 Módulos 100 - 240 V ~ - 50/60 Hz	 45401 S	
	Detector de Movimiento de 400 W - 2 Módulos 100 - 240 V ~ - 50/60 Hz	 45402 S	
	Detector de Movimiento Instalación Mural de 1000 W - 2 Módulos 100 - 240 V ~ - 50/60 Hz	 45403 S	BR BM PM AL
	Detector de Movimiento Instalación Mural de 400 W - 2 Módulos 100 - 240 V ~ - 50/60 Hz	 45404 S	

CONTROL DE TEMPERATURA





	Termostato Rotativo - 2 Módulos 16 A (cos ϕ = 1) - 100 - 240 V ~ - 50/60 Hz	 45234 S	
	Termostato Multifuncional - 2 Módulos 16 A (cos ϕ = 1) - 100 - 240 V ~ - 50/60 Hz	 45236 S	BR BM PM AL
	Cronotermostato Multifuncional - 2 Módulos 16 A (cos ϕ = 1) - 100 - 240 V ~ - 50/60 Hz	 45235 S	
	Sensor de Temperatura de Suelo para Termostato y Cronotermostato Longitud: 4m. -10 °C a 50 °C. IP67. NTC 12 K/25 °C.	81950	-

S - Semi-montado. | BR - Blanco; BM - Blanco Mate; PM - Negro Mate; AL - Aluminio.

 - Ahorro energético y aporte energético del inmueble.

 /  - Conexión tuerca tornillo









SEÑALIZADORES Y ORIENTACIÓN

	Ref.	Color
 <p>Señalizador Luminoso - 2 Módulos 230 V ~ - 50/60 Hz L1 - 0,2 W; L2 - 0,4 W (4000 K)</p>	45361 S	IC VD VM LR
 <p>Señalizador Luminoso Triangular - 2 Módulos 230 V ~ - 50/60 Hz L1 - 0,2 W; L2 - 0,4 W (4000 K)</p>	45362 S	
 <p>Luz de Orientación Blanca - 2 Módulos 230 V ~ - 50/60 Hz L1 - 0,2 W; L2 - 0,4 W (4000 K)</p>	45388 S	
 <p>Luz de Orientación Blanca con Batería - 2 Módulos 230 V ~ - 50/60 Hz L1 - Señalización OFF; L2 - Señalización ON.</p>	45389 S	BR BM PM AL
 <p>Timbre Electrónico - 1 Módulo 100 - 240 V ~ - 50/60 Hz</p>	45369 S	



TOMAS DE DATOS, VOZ E IMAGEN

 <p>Toma de Datos USB - 1 Módulo Toma que permite pasaje de información por conexión USB. Velocidad máxima: 12 Mbit/s.</p>	45437 S	
 <p>Toma HDMI con Conector - 1 Módulo Toma que permite pasaje de información audio y video en alta definición entre cualquier emisor (ordenador, DVD, ...) y un terminal (TV, LCD, Video proyector,...). Resolución máxima: 1080p.</p>	45435 S	
 <p>Toma HDMI Conexión Tornillo - 2 Módulos Toma que permite pasaje de información audio y video en alta definición entre cualquier emisor (ordenador, DVD, ...) y un terminal (TV, LCD, Video proyector,...). Resolución máxima: 1080p.</p>	45436 S	BR BM PM AL MF GE PE IS DU PR GR PL CH
 <p>Toma VGA HD15 - 2 Módulos Toma que permite pasaje de información video entre cualquier emisor (ordenador, DVD, ...) y un terminal (TV, LCD, Video proyector,...).</p>	45430 S	
 <p>Toma 3 RCA Hembra - 1 Módulo Toma que permite pasaje de información audio y video entre cualquier emisor (ordenador, DVD, ...) y un terminal (TV, LCD, Video proyector,...)</p>	45580 S	

MÓDULOS CON CONECTORES

 <p>Módulo con Conector Hembra RJ45 Cat. 6A UTP - 1 Módulo</p>	 45440 S	
 <p>Módulo con Conector Hembra RJ45 Cat. 6 UTP - 1 Módulo</p>	 45978 S	
 <p>Módulo con Conector Hembra RJ45 Cat. 5e UTP - 1 Módulo</p>	45975 S	
 <p>Módulo con Conector Hembra RJ11 Cat. 3 - 1 Módulo</p>	45972 S	BR BM PM AL
 <p>Módulo con Conector Hembra RJ45 Cat. 6 STP - 1 Módulo</p>	45988 S	
 <p>Módulo con Conector Hembra RJ45 Cat. 5e STP - 1 Módulo</p>	45985 S	
 <p>Módulo con Conector Coaxial Tipo F - 1 Módulo</p>	45979 S	



S - Semi-montado. | BR - Blanco; BM - Blanco Mate; PM - Negro Mate; AL - Aluminio; MF - Marfil; GE - Hielo; PE - Perla; IS - Gris; DU - Dorado; PR - Plata; GR - Grafito; PL - Platino; CH - Champán;
IC - Transparente; VD - Verde; VM - Rojo; LR - Naranja.

 /  - Conexión fuerza tornillo





 - Power over Ethernet

TOMAS DE DATOS, VOZ E IMAGEN

MÓDULOS CON CONECTORES

		Ref.	Color
	Módulo con Conector IEC Macho Tipo F - 1 Módulo	45982 S	BR BM PM AL
	Módulo con Conector IEC Hembra Tipo F - 1 Módulo	45983 S	





MÓDULOS PARA CONECTORES

	Doble Módulo para Conectores RJ45 - 2 Módulos (Conectores no incluidos) Apto para Conectores RJ de tipo Keystone.	45971 S	
	Módulo para Conector 1 Salida RJ45 - 2 Módulos (Conectores no incluidos) Apto para Conectores RJ de tipo Keystone.	45976 S	BR BM PM AL
	Módulo para Conector RJ45 - 1 Módulo (Conectores no incluidos) Apto para Conectores RJ de tipo Keystone.	45977 S	
	Módulo Máscara - 1 Módulo Apto para Conectores - pág. 132.	45970 S	BR BM PM AL MF GE PE IS PR GR PL CH



CONECTORES

	Conector Hembra RJ45 Cat. 6A UTP (500 MHz)		82021	
	Conector Hembra RJ45 Cat. 6 UTP (250 MHz)		21978	
	Conector Hembra RJ45 Cat. 6 UTP - Montaje Rack (250 MHz)		82020	
	Conector Hembra RJ45 Cat. 6 STP (250 MHz)		21988	—
	Conector Hembra RJ45 Cat. 5e UTP (100 MHz)		21975	
	Conector Hembra RJ45 Cat. 5e STP (100 MHz)		21985	
	Conector Hembra RJ11 Cat. 3		21972	

MÓDULOS CON ADAPTADORES DE FIBRA ÓPTICA

	Módulo con Adaptador para Conectores de Fibra Óptica SC APC Duplex - 2 Módulos		45448 S	
	Módulo con Adaptador para Conectores de Fibra Óptica SC APC Simplex - 2 Módulos		45447 S	BR BM PM AL
	Módulo con Adaptador para Conectores de Fibra Óptica LC Duplex - 2 Módulos		45449 S	
	Tapa de Protección para Adaptador de Fibra Óptica SC APC Simplex		82970	—
	Tapa de Protección para Adaptador de Fibra Óptica SC APC Duplex		82971	



S - Semi-montado. | BR - Blanco; BM - Blanco Mate; PM - Negro Mate; AL - Aluminio; MF - Marfil; GE - Hielo; PE - Perla; IS - Gris; PR - Plata; GR - Grafito; PL - Platino; CH - Champán.

 /  - Conexión tuercas tornillo



 - Power over Ethernet

TOMAS DE DATOS, VOZ E IMAGEN





TOMAS DE RADIO, TELEVISIÓN Y SATÉLITE

	Ref.	Color
ESTRELLA		
	Toma R - TV - SAT Estrella - 2 Módulos 4 - 862 MHz: < 2 dB. 950 - 2400 MHz: < 3 dB. Paso de corriente: 500mA (DC).	45543 S
		BR BM PM AL
	Toma R - TV Estrella - 2 Módulos 4 - 82 MHz: < 1 dB. 84 - 108 MHz: < 2 dB. 112 - 1000 MHz: < 1 dB.	45533 S
CONEXIÓN EN SERIE		
	Toma R - TV - SAT Final - 2 Módulos 4 - 446 MHz: < 6 dB. 470 - 862 MHz: < 9 dB. 950 - 2400 MHz: < 6 dB. Paso de corriente: 500mA (DC).	45555 S
	Toma R - TV - SAT Intermedia - 2 Módulos 4 - 862 MHz: < 10 dB. 950 - 2150 MHz: < 11 dB. 2150 - 2400 MHz: < 9 dB. Paso de corriente: 500mA (DC). Pérdidas de inserción: 3 dB.	45565 S
		BR BM PM AL
	Toma R - TV Final - 2 Módulos 4 - 82 MHz: < 6 dB. 84 - 108 MHz: < 8 dB. 112 - 1000 MHz: < 7dB.	45554 S
	Toma R - TV Intermedia - 2 Módulos 4 - 1000 MHz: < 9 dB. Pérdidas de inserción: 2 dB.	45564 S

CARGADORES USB

	Doble Cargador USB con Salidas a 20° Tipo A - 2 Módulos 100 - 240 V ~ - 50/60 Hz - 5 V = 2.4 A	45384 S	BR BM PM AL
	Doble Cargador USB Tipo A - 2 Módulos 100 - 240 V ~ - 50/60 Hz - 5 V = 2.1 A	45439 S	BR
	Cargador USB Tipo A - 1 Módulo 100 - 240 V ~ - 50/60 Hz - 5 V = 1.5 A	45383 S	BR BM PM AL MF GE PE IS DU PR GR PL CH

TOMAS DE CORRIENTE















	Toma Schuko con Terminales de Conexión Rápida y Protección - 2 Módulos 16 A - 250 V ~	45126 S	
	Toma Schuko con Terminales de Conexión Rápida con Tapa y Protección - 2 Módulos 16 A - 250 V ~	45127 S	BR BM PM AL LR VD VM
	Toma Schuko con Protección - 2 Módulos 16 A - 250 V ~	45129 S	
	Toma Schuko con Tapa y Protección - 2 Módulos 16 A - 250 V ~	45128 S	

S - Semi-montado. | BR - Blanco; BM - Blanco Mate; PM - Negro Mate; AL - Aluminio; MF - Marfil; GE - Hielo; PE - Perla; IS - Gris; DU - Dorado; PR - Plata; GR - Grafito; PL - Platino; CH - Champán;



LR - Naranja; VD - Verde; VM - Rojo.

⊗ / ⊕ - Conexión tuerca tornillo

















TOMAS DE CORRIENTE

SCHUKO		Ref.	Color
	Toma Schuko 45° con Protección - 2 Módulos 16 A - 250 V~ Alvéolos a 45°.	45132 S	BR BM PM AL LR VD VM
	Toma Schuko 45° - 2 Módulos 16 A - 250 V~ Alvéolos a 45°.	45131 S	
	Toma Schuko 45° con Enclavamiento - 2 Módulos 16 A - 250 V~ Alvéolos a 45°. Incluye Perno de Enclavamiento para Tomas MEC Q45 (Ref.º 45991).	45136 S	VM
	Toma Schuko 45° con Enclavamiento y Señalización - 2 Módulos 16 A - 250 V~ Alvéolos a 45°. Incluye Perno de Enclavamiento para Tomas MEC Q45 (Ref.º 45991).	45137 S	
FRANCESAS			
	Toma Francesa con Terminales de Conexión Rápida y Protección - 2 Módulos 16 A - 250 V~	45476 S	
	Toma Francesa con Terminales de Conexión Rápida con Tapa y Protección - 2 Módulos 16 A - 250 V~	45477 S	
	Toma Francesa con Protección - 2 Módulos 16 A - 250 V~	45479 S	BR BM PM AL LR VD VM
	Toma Francesa con Tapa y Protección - 2 Módulos 16 A - 250 V~	45475 S	
	Toma Francesa 45° con Protección - 2 Módulos 16 A - 250 V~ Alvéolos a 45°.	45112 S	
	Toma Francesa 45° - 2 Módulos 16 A - 250 V~ Alvéolos a 45°.	45111 S	
	Toma Francesa 45° con Enclavamiento - 2 Módulos 16 A - 250 V~ Alvéolos a 45°. Incluye Perno de Enclavamiento para Tomas MEC Q45 (Ref.º 45991).	45116 S	VM
	Toma Francesa 45° con Enclavamiento y Señalización - 2 Módulos 16 A - 250 V~ Alvéolos a 45°. Incluye Perno de Enclavamiento para Tomas MEC Q45 (Ref.º 45991).	45117 S	
EUROAMERICANAS			
	Toma Euro-americana con Protección - 2 Módulos 15 A - 127 V~/ 16 A - 250 V~	45142 S	BR BM PM AL
	Toma Euro-americana - 2 Módulos 15 A - 127 V~/ 16 A - 250 V~	45140 S	



S - Semi-montado. | BR - Blanco; BM - Blanco Mate; PM - Negro Mate; AL - Aluminio; LR - Naranja; VD - Verde; VM - Rojo.

 /  - Conexión tuerca tornillo

TOMAS DE CORRIENTE





AMERICANAS		Ref.	Color
	Toma Americana NEMA - 2 Módulos 15 A - 127 V ~ SASO 2204. NEMA 5-15.	45144 S	BR BM PM AL VM
	Toma Doble Americana 2P+T 127 V 15 A con Protección - 3 Módulos 15 A - 127 V ~	45147 S	BR BM PM AL VM
	Toma Doble Americana 2P+T 127 V 15 A - 3 Módulos 15 A - 127 V ~	45146 S	BR BM PM AL
	Toma Doble Americana 2P+T 127 V 20 A GFCI con Protección - 3 Módulos 20 A - 127 V ~ Incluye Soporte de Fijación.	41148 X	BL NG
	Toma Doble Americana 2P+T 127 V 15 A GFCI con Protección - 3 Módulos 15 A - 127 V ~ Incluye Soporte de Fijación.	41149 X	
ITALIANAS			
	Toma Italiana 10 A con Protección - 1 Módulo 10 A - 250 V ~	45423 S	
	Toma Italiana 16 A con Protección - 1 Módulo 16 A - 250 V ~	45425 S	BR BM PM AL VM
	Toma Italiana 10/16 A con Protección - 1 Módulo 16 A - 250 V ~	45421 S	
BRASILEÑAS			
	Toma Brasileña 10 A con Protección - 1 Módulo 10 A - 250 V ~	NUEVO 45413 S	BR BM PM AL VM
	Toma Brasileña 10 A - 1 Módulo 10 A - 250 V ~	NUEVO 45412 S	BR BM PM AL
	Toma Brasileña 20 A con Protección - 1 Módulo 20 A - 250 V ~	NUEVO 45415 S	BR BM PM AL VM
	Toma Brasileña 20 A - 1 Módulo 20 A - 250 V ~	NUEVO 45414 S	BR BM PM AL
DOBLES Y TRIPLES PRE-CABLEADAS PARA MONTAJE EN CANALES ETS IO - DISTRIBUCIÓN			
SCHUKO			
	Doble Toma Schuko con Protección - 4 Módulos 16 A - 250 V ~	45192 S	
	Doble Toma Schuko - 4 Módulos 16 A - 250 V ~	45190 S	BR VM
	Triple Toma Schuko con Protección - 6 Módulos 16 A - 250 V ~	45196 S	
	Triple Toma Schuko - 6 Módulos 16 A - 250 V ~	45194 S	

S - Semi-montado; X - Semi-montado con soporte de fijación | BR - Blanco; BM - Blanco Mate; PM - Negro Mate; AL - Aluminio; VM - Rojo; BL - Blanco; NG - Negro.

 /  - Conexión tuerca tornillo



TOMAS DE CORRIENTE

DOBLES Y TRIPLES PRE-CABLEADAS PARA MONTAJE EN CANALES ETS IO - DISTRIBUCIÓN











	Ref.	Color
FRANCESAS		
 Doble Toma Francesa con Protección - 4 Módulos 16 A - 250 V~	45193 S	
 Doble Toma Francesa - 4 Módulos 16 A - 250 V~	45191 S	
 Triple Toma Francesa con Protección - 6 Módulos 16 A - 250 V~	45197 S	BR VM
 Triple Toma Francesa - 6 Módulos 16 A - 250 V~	45195 S	

ACCESORIOS

SALIDA DE CABLES

	Ref.	Color
 Salida de Cables - 2 Módulos Con sistema de fijación de cables.	45170 S	
 Salida de Cables con 3 Terminales - 2 Módulos 3x2,5 mm ² - 250 V~	45173 S	BR BM PM AL
 Salida de Cables con 4 Terminales - 2 Módulos 4x1,5 mm ² - 250 V~	45174 S	















MEC Q45

 Caja Serie 48 con Tapa para MEC Q45 Otorga grado IP65 a los mecanismos MEC Q45 (Dispositivos Electrónicos, Tomas de Datos, etc).	 48998 C	CZ BR
 Adaptador Simple Q45 para Cuadros Eléctricos	45990 A	BR
 Tecla Doble para Mecanismos Electrónicos - 2 Módulos	45610 T	BR BM PM AL
 Tapa Ciega - 2 Módulos	45677 S	BR BM PM AL MF GE PE IS DU PR GR PL CH
 Tapa Ciega - 1 Módulo	45973 S	
 Perno de Enclavamiento para Tomas Q45	45991	
 Posicionador 90° para 2 Módulos Para utilizar con mecanismos de MEC Q45 en Torretas de Mesa, Columnas y Minicolumnas. Posibilidad de montar los mecanismos con rotación de 90°.	45992	
 Nivel de Montaje	81989	-
 Mando a Distancia Multifunciones Control Termostato Multifuncional. Control de Mandos de Persiana. Control de instalaciones de sonido. Funciona con pila CR 2032, no incluida.	81900	

S - Semi-montado; C - Producto Completo; A - Accesorio; T - Tecla, Tapa o Marco. | BR - Blanco; BM - Blanco Mate; PM - Negro Mate; AL - Aluminio; VM - Rojo; CZ - Gris; MF - Marfil; GE - Hielo; PE - Perla; IS - Gris; DU - Dorado; PR - Plata; GR - Grafita; PL - Platino; CH - Champán

 - Conexión tuerca tornillo

ACCESORIOS

SIZA Y QUADRA		Ref.	Color
	Tapa de Protección para Soporte y Mecanismos - 2 Módulos	45998	—
LATINA			
	Tapa de Protección para Soporte y Mecanismos - 2 Módulos	42980	
	Tapa de Protección para Soporte y Mecanismos hasta 3 Módulos	41984	—
	Posicionador 90° para Soportes de Fijación Posicionador vertical para montaje de módulos MEC Q45.	41992	
CAJAS DE SUPERFICIE			
SIZA			
	Caja de Superficie Q45 Siza Vieira	43996 A	BR BM PM AL
	Unión Paso Cables para Caja de Superficie Q45 Siza Vieira	43999 A	
QUADRA			
	Caja de Superficie Modular Q45	45996 A	BR BM PM AL
	Tapa para Caja de Superficie Modular Q45 Incluye División 10982 A.	45997 A	
	División para Caja de Superficie Modular Q45	10982 A	—
LATINA - MATRIZ EUROPEA			
	Caja de Superficie - 2 Módulos Soporte de Fijación a utilizar: 2 módulos (Ref. 42993).	42985 A	BR BM PM AL
LATINA - MATRIZ ITALIANA			
	Caja de Superficie - 3 Módulos Soporte de Fijación a utilizar: 3 módulos (Ref. 41994).	41986 A	
	Caja de Superficie - 3+3 Módulos Soporte de Fijación a utilizar: 3+3 módulos (Ref. 41995).	41987 A	
	Caja de Superficie - 4 Módulos Soporte de Fijación a utilizar: 4 módulos (Ref. 41996).	41988 A	BR BM PM AL
	Caja de Superficie - 6 Módulos Soporte de Fijación a utilizar: 6 módulos (Ref. 41997).	41989 A	

A - Accesorio. | BR - Blanco; BM - Blanco Mate; PM - Negro Mate; AL - Aluminio.





ACCESORIOS

RELÉS PARA PERSIANAS



	Ref.	Color
 <p>Relé Interruptor de Persiana 6 A - 230 V ~ - 50 Hz Temporizado. Conectar a Dobles Pulsadores y a Dobles Pulsadores de Persianas.</p>	81512	-
 <p>Relé Pulsador de Persiana 6 A - 230 V ~ - 50 Hz No temporizado. Conectar localmente a Doble Pulsador Conmutador para Persiana (Ref.º 21283 / 45283 S).</p>	81511	-

MECANISMOS COMPLETOS

TOMAS DE ENCHUFE DOBLES Y TRIPLES MODULARES PRE-CABLEADOS PARA CANALES CON TAPA DE 75MM (L75) DE ANCHO

SCHUKO		
 <p>Doble Toma Schuko Modular con Protección para Canales con Tapa L75 - 4 Módulos 16 A - 250 V ~</p>	45262 C	
 <p>Doble Toma Schuko Modular para Canales con Tapa L75 - 4 Módulos 16 A - 250 V ~</p>	45260 C	
 <p>Triple Toma Schuko Modular con Protección para Canales con Tapa L75 - 6 Módulos 16 A - 250 V ~</p>	45266 C	BR VM
 <p>Triple Toma Schuko Modular para Canales con Tapa L75 - 6 Módulos 16 A - 250 V ~</p>	45264 C	



TOMAS DE ENCHUFE DOBLES Y TRIPLES PRE-CABLEADOS PARA CANALES CON TAPA DE 75MM (L75) DE ANCHO

SCHUKO		
 <p>Doble Toma Schuko con Protección L75 - 4 Módulos 16 A - 250 V ~</p>	45262 C	
 <p>Doble Toma Schuko L75 - 4 Módulos 16 A - 250 V ~</p>	45260 C	
 <p>Triple Toma Schuko con Protección L75 - 6 Módulos 16 A - 250 V ~</p>	45266 C	BR VM
 <p>Triple Toma Schuko L75 - 6 Módulos 16 A - 250 V ~</p>	45264 C	

TOMAS PARA REGARGAS VE







 <p>Toma de Empotrar Schuko para Recarga VE 16 A - 250 V ~</p>	NUEVO	81132
 <p>Toma de Empotrar Francesa para Recarga VE 16 A - 250 V ~</p>	NUEVO	81112
 <p>Toma de Superficie Schuko para Recarga VE 16 A - 250 V ~</p>	NUEVO	81751
 <p>Toma de Superficie Francesa para Recarga VE 16 A - 250 V ~</p>	NUEVO	81752

C - Producto Completo. | BR - Blanco; VM - Rojo.

 /  - Conexión tuerca tornillo

MARCOS - MONTAJE HORIZONTAL O VERTICAL

SERIE SIZA - MARCOS Y RESPECTIVOS SOPORTES

 <p>Simple 43910 T</p>	 <p>Doble 43920 T</p>	 <p>Triple 43930 T</p>	 <p>Cuádruple 43940 T</p>	 <p>Soporte Q45 45993</p>	 <p>Soporte Q45 con Garras 45994</p>
--	---	--	---	---	--

ACABADOS







STANDARD
MATE Y ALUMINIO

COLORES

BR - Blanco
BM - Blanco Mate
PM - Negro Mate
AL - Aluminio

MARCOS - MONTAJE HORIZONTAL O VERTICAL

SERIE QUADRA - MARCOS Y RESPECTIVOS SOPORTES

 <p>Simple 45910 T</p>	 <p>Doble 45920 T</p>	 <p>Triple 45930 T</p>	 <p>Cuádruple 45940 T</p>	 <p>Soporte Q45 45993</p>	 <p>Soporte Q45 con Garras 45994</p>
--	---	--	---	---	--

ACABADOS

STANDARD
MATE Y ALUMINIO







COLORES

BR - Blanco
BM - Blanco Mate
PM - Negro Mate
AL - Aluminio

T - Tecla, Tapa o Marco.

MARCOS - MONTAJE HORIZONTAL O VERTICAL

SERIE LATINA - MARCOS Y RESPECTIVOS SOPORTES DE FIJACIÓN - MATRIZ EUROPEA

 <p>Simple 42910 T</p>	 <p>Doble 42920 T</p>	 <p>Triple 42930 T</p>	 <p>Cuádruple 42940 T</p>	 <p>Soporte de Fijación 42993</p>	 <p>Soporte de Fijación con Garras 42994</p>
--	---	--	---	---	--

ACABADOS

STANDARD
AQUARELLA
LYRA
LIGNA
METALLUM
CROMA

COLORES

STANDARD

BR - Blanco

AQUARELLA

BM - Blanco Mate
PM - Negro Mate
AL - Aluminio

LYRA

CE - Crema
AZ - Azul
AM - Amarillo
VR - Verde
LR - Naranja
RJ - Rojo

LIGNA

RO - Roble
FA - Haya
MG - Caoba
WG - Wengé

METALLUM

LU - Aluminio
RB - Rojo Intenso
CO - Cobre
OR - Oro
CR - Cromo

CROMA

BH - Blanco Mate/Cromo
AH - Aluminio/Cromo
PH - Negro Mate/Cromo

T - Tecla, Tapa o Marco.

MARCOS - MONTAJE HORIZONTAL O VERTICAL

SERIE LATINA - MARCOS Y RESPECTIVOS SOPORTES DE FIJACIÓN - MATRIZ ITALIANA

3 MÓDULOS



1 MÓDULO
41913 T



2 MÓDULOS
41914 T



1+1 MÓDULOS
41915 T



3 MÓDULOS
41916 T



SopORTE de Fijación
41994

ACABADOS

STANDARD
AQUARELLA

STANDARD
AQUARELLA

STANDARD
AQUARELLA

STANDARD
AQUARELLA
LYRA
LIGNA
METALLUM
CROMA
CRYSTAL

COLORES

BR - Blanco

BM - Blanco Mate
PM - Negro Mate
AL - Aluminio

BR - Blanco

BM - Blanco Mate
PM - Negro Mate
AL - Aluminio

BR - Blanco

BM - Blanco Mate
PM - Negro Mate
AL - Aluminio

BR - Blanco

BM - Blanco Mate
PM - Negro Mate
AL - Aluminio

CE - Crema
AZ - Azul
AM - Amarillo
VR - Verde
LR - Naranja
RJ - Rojo

RO - Roble
FA - Haya
MG - Caoba
WG - Wengé

LU - Aluminio
RB - Rojo Intenso
CO - Cobre
OR - Oro
CR - Cromo

BH - Blanco Mate/Cromo
AH - Aluminio/Cromo
PH - Negro Mate/Cromo







CB - Cristal/Blanco Mate
CA - Cristal/Aluminio
CK - Cristal/Negro Mate

EB - Cristal Negro/Blanco Mate
EA - Cristal Negro/Aluminio
EP - Cristal Negro/Negro Mate

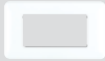
T - Tecla, Tapa o Marco.

MARCOS - MONTAJE HORIZONTAL O VERTICAL

SERIE LATINA - MARCOS Y RESPECTIVOS SOPORTES DE FIJACIÓN - MATRIZ ITALIANA

4 MÓDULOS		6 MÓDULOS		3+3 MÓDULOS	
					
4 MÓDULOS 41917 T	Soporte de Fijación 41916	6 MÓDULOS 41918 T	Soporte de Fijación 41997	3+3 MÓDULOS 41926 T	Soporte de Fijación 41995

ACABADOS

<p>STANDARD AQUARELLA LYRA LIGNA METALLUM CROMA</p>	<p>STANDARD AQUARELLA LYRA LIGNA METALLUM CROMA</p>	<p>STANDARD AQUARELLA LYRA LIGNA METALLUM CROMA CRYSTAL</p>
---	---	---

COLORES

<p>BR - Blanco BM - Blanco Mate PM - Negro Mate AL - Aluminio</p> <p>CE - Crema AZ - Azul AM - Amarillo VR - Verde LR - Naranja RJ - Rojo</p> <p>RO - Roble FA - Haya MG - Caoba WG - Wengé</p> <p>LU - Aluminio RB - Rojo Intenso CO - Cobre OR - Oro CR - Cromo</p> <p>BH - Blanco Mate/Cromo AH - Aluminio/Cromo PH - Negro Mate/Cromo</p>	<p>BR - Blanco BM - Blanco Mate PM - Negro Mate AL - Aluminio</p> <p>CE - Crema AZ - Azul AM - Amarillo VR - Verde LR - Naranja RJ - Rojo</p> <p>RO - Roble FA - Haya MG - Caoba WG - Wengé</p> <p>LU - Aluminio RB - Rojo Intenso CO - Cobre OR - Oro CR - Cromo</p> <p>BH - Blanco Mate/Cromo AH - Aluminio/Cromo PH - Negro Mate/Cromo</p>	<p>BR - Blanco BM - Blanco Mate PM - Negro Mate AL - Aluminio</p> <p>CE - Crema AZ - Azul AM - Amarillo VR - Verde LR - Naranja RJ - Rojo</p> <p>RO - Roble FA - Haya MG - Caoba WG - Wengé</p> <p>LU - Aluminio RB - Rojo Intenso CO - Cobre OR - Oro CR - Cromo</p> <p>BH - Blanco Mate/Cromo AH - Aluminio/Cromo PH - Negro Mate/Cromo</p> <p>CB - Cristal/Blanco Mate CA - Cristal/Aluminio CK - Cristal/Negro Mate</p> <p>EB - Cristal Negro/Blanco Mate EA - Cristal Negro/Aluminio EP - Cristal Negro/Negro Mate</p>
---	---	---

T - Tecla, Tapa o Marco.

SONIDO AMBIENTE

JAZZ LIGHT

82

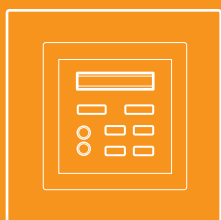

03



FUENTES DE ALIMENTACIÓN	84
CENTRALES DE SONIDO MODULARES	84
MANDOS DE SONIDO	85
ALTAVOCES DE EMPOTRAR DE 2"	86
ALTAVOCES DE EMPOTRAR DE 5"	86
ALTAVOCES DE EMPOTRAR DE 6,5"	87
ALTAVOCES DE SUPERFICIE DE 5"	87
ACCESORIOS	87

FUENTES DE ALIMENTACIÓN

	Ref.
 <p>Fuente de Alimentación Modular 15 V ∴ 5 W Entrada: 110/240 V ~ - 50/60 Hz. Salida: 15 V ∴ - 5 W - 0,33 A. Alimenta un Mando de Sonido Mono o Estéreo.</p>	21380
 <p>Fuente de Alimentación 15 V ∴ 5 W - 2 Módulos Entrada: 110/240 V ~ - 50/60 Hz. Salida: 15 V ∴ - 5 W - 0,33 A. Alimenta un Mando de Sonido Mono o Estéreo.</p>	45380 S
 <p>Fuente de Alimentación para Carril DIN 15 V ∴ 30 W Entrada: 110/240 V ~ - 50/60 Hz. Salida: 15 V ∴ - 30 W - 2 A. Alimenta 10 Mandos Estéreo o 20 Mandos Mono. Ocupa 2 módulos DIN.</p>	75052
 <p>Fuente de Alimentación para Falso Techo 15 V ∴ 12 W Entrada: 110/240 V ~ - 50/60 Hz. Salida: 15 V ∴ - 12 W - 0,8 A. Alimenta 4 Mandos Estéreo o 8 Mandos Mono. Posibilidad de instalación en una Caja de Empotrar Profunda para Amplificador y Altavoces de 5" (Ref.º 75984).</p>	75053

TAPAS

	Ref.	Color
	90670 T	BR MF GE PE AL IS PM DU
	50670 T	BR MF BM PM PR GR PL CH
	70670 T	BR MF

CENTRALES DE SONIDO MODULARES

 <p>Central Modular de 1 Canal Estéreo con Sintonizador FM Permite recibir una fuente externa, transformar y enviar una señal de audio a los Mandos de Sonido de toda la instalación. Compatible con los Mandos Mono y Estéreo. Dispone de sintonizador de radio FM.</p>	21392
 <p>Central Modular de 1 Canal Estéreo con Sintonizador FM - 2 Módulos Permite recibir una fuente externa, transformar y enviar una señal de audio a los Mandos de Sonido de toda la instalación. Compatible con los Mandos Mono y Estéreo. Dispone de sintonizador de radio FM.</p>	45392 S
 <p>Central Modular de 1 Canal Estéreo Permite recibir una fuente externa, transformar y enviar una señal de audio a los Mandos de Sonido de toda la instalación. Compatible con los Mandos Mono y Estéreo.</p>	21391
 <p>Central Modular de 1 Canal Estéreo - 2 Módulos Permite recibir una fuente externa, transformar y enviar una señal de audio a los Mandos de Sonido de toda la instalación. Compatible con los Mandos Mono y Estéreo.</p>	45391 S

TAPAS

	90852 T	BR MF GE PE AL IS PM DU
	50852 T	BR MF BM PM PR GR PL CH
	70852 T	BR MF
	90851 T	BR MF GE PE AL IS PM DU
	50851 T	BR MF BM PM PR GR PL CH
	70851 T	BR MF





















T - Tecla, Tapa o Marco; S - Semi-montado. | BR - Blanco; MF - Marfil; GE - Hielo; PE - Perla; AL - Aluminio; IS - Gris; BM - Blanco Mate; PM - Negro Mate; DU - Dorado; PR - Plata; GR - Grafito; PL - Platino; CH - Champán.

Marcos das Series **LOGUS 90** - pág. 10 | **APOLLO 5000** - pág. 26 | **SIRIUS** - pág. 39 | Marcos das Series **SIZA** - pág. 58 | **QUADRA** - pág. 60 | **LATINA** - pág. 62.

 /  - Conexión tuerca tornillo

MANDOS DE SONIDO

TAPAS

	Ref.		Ref.	Color
 <p>Mando de 1 Canal Estéreo con Sintonizador FM, Despertador y IR</p> <p>Permite recibir una señal de audio de la Central de Sonido, amplificarla y distribuirla a los altavoces. Sintonizador de radio FM. Entrada de audio vía Jack de 3,5mm. Radio Despertador. Timer programable hasta 90 min. Receptor IR. Impedancia por salida 32 Ohm (2 salidas).</p>	21370	   <p>Tapa para Mando de 1 Canal Estéreo con Sintonizador FM, Despertador y IR</p>	90715 T 50715 T 70715 T	BR MF GE PE AL IS PM DU BR MF BM PM PR GR PL CH BR MF
 <p>Mando de 1 Canal Estéreo con Sintonizador FM, Despertador y IR - 2 Módulos</p> <p>Permite recibir una señal de audio de la Central de Sonido, amplificarla y distribuirla a los altavoces. Sintonizador de radio FM. Entrada de audio vía Jack de 3,5mm. Radio Despertador. Timer programable hasta 90 min. Receptor IR. Impedancia por salida 32 Ohm (2 salidas).</p>			45370 S	BR BM PM AL
 <p>Mando de 1 Canal Estéreo con Sintonizador FM y Despertador</p> <p>Permite recibir una señal de audio de la Central de Sonido, amplificarla y distribuirla a los altavoces. Sintonizador de radio FM. Entrada de audio vía Jack de 3,5mm. Radio Despertador. Timer programable hasta 90 min. Salida de auriculares. Impedancia por salida 32 Ohm (2 salidas).</p>	21379	   <p>Tapa para Mando de 1 Canal Estéreo con Sintonizador FM y Despertador</p>	90709 T 50709 T 70709 T	BR MF GE PE AL IS PM DU BR MF BM PM PR GR PL CH BR MF
 <p>Mando de 1 Canal Estéreo con Sintonizador FM y Despertador - 2 Módulos</p> <p>Permite recibir una señal de audio de la Central de Sonido, amplificarla y distribuirla a los altavoces. Sintonizador de radio FM. Entrada de audio vía Jack de 3,5mm. Radio Despertador. Timer programable hasta 90 min. Salida de auriculares. Impedancia por salida 32 Ohm (2 salidas).</p>			45379 S	BR BM PM AL
 <p>Mando de 1 Canal Estéreo con Sintonizador FM</p> <p>Permite recibir una señal de audio de la Central de Sonido, amplificarla y distribuirla a los altavoces. Sintonizador de radio FM. Entrada de audio vía Jack de 3,5mm. Timer programable hasta 90 min. Salida de auriculares. Impedancia por salida 32 Ohm (2 salidas).</p>	21377	   <p>Tapa para Mando de 1 Canal Estéreo con Sintonizador FM</p>	90707 T 50707 T 70707 T	BR MF GE PE AL IS PM DU BR MF BM PM PR GR PL CH BR MF
 <p>Mando de 1 Canal Estéreo con Sintonizador FM - 2 Módulos</p> <p>Permite recibir una señal de audio de la Central de Sonido, amplificarla y distribuirla a los altavoces. Sintonizador de radio FM. Entrada de audio vía Jack de 3,5mm. Timer programable hasta 90 min. Salida de auriculares. Impedancia por salida 32 Ohm (2 salidas).</p>			45377 S	BR BM PM AL
 <p>Mando de 1 Canal Mono con Sintonizador FM</p> <p>Permite recibir una señal de audio de la Central de Sonido, amplificarla y distribuirla a los altavoces. Sintonizador de radio FM. Entrada de audio vía Jack de 3,5mm. Timer programable hasta 90 min. Impedancia por salida 32 Ohm (2 salidas).</p>	21373	   <p>Tapa para Mando de 1 Canal Mono con Sintonizador FM</p>	90703 T 50703 T 70703 T	BR MF GE PE AL IS PM DU BR MF BM PM PR GR PL CH BR MF
 <p>Mando de 1 Canal Mono con Sintonizador FM - 2 Módulos</p> <p>Permite recibir una señal de audio de la Central de Sonido, amplificarla y distribuirla a los altavoces. Sintonizador de radio FM. Entrada de audio vía Jack de 3,5mm. Timer programable hasta 90 min. Impedancia por salida 32 Ohm (2 salidas).</p>			45373 S	BR BM PM AL

T - Tecla, Tapa o Marco; S - Semi-montado. | BR - Blanco; MF - Marfil; GE - Hielo; PE - Perla; AL - Aluminio; IS - Gris; BM - Blanco Mate; PM - Negro Mate; DU - Dorado; PR - Plata; GR - Grafito; PL - Platino; CH - Champán.







Marcos das Series **LOGUS 90** - pág. 10 | **APOLO 5000** - pág. 26 | **SIRIUS** - pág. 39 | Marcos das Series **SIZA** - pág. 58 | **QUADRA** - pág. 60 | **LATINA** - pág. 62.

/ - Conexión tuerca tornillo

MANDOS DE SONIDO

	Ref.
 <p>Mando de 1 Canal Estéreo Permite recibir una señal de audio de la Central de Sonido, amplificarla y distribuirla a los altavoces. Entrada de audio vía Jack de 3,5mm. Timer programable hasta 90 min. Salida de auriculares. Impedancia por salida 32 Ohm (2 salidas).</p>	21372
 <p>Mando de 1 Canal Estéreo - 2 Módulos Permite recibir una señal de audio de la Central de Sonido, amplificarla y distribuirla a los altavoces. Entrada de audio vía Jack de 3,5mm. Timer programable hasta 90 min. Salida de auriculares. Impedancia por salida 32 Ohm (2 salidas).</p>	
 <p>Mando de 1 Canal Mono Permite recibir una señal de audio de la Central de Sonido, amplificarla y distribuirla a los altavoces. Timer programable hasta 90 min. Impedancia por salida 32 Ohm (1 salida).</p>	21371
 <p>Mando de 1 Canal Mono - 2 Módulos Permite recibir una señal de audio de la Central de Sonido, amplificarla y distribuirla a los altavoces. Timer programable hasta 90 min. Impedancia por salida 32 Ohm (1 salida).</p>	



TAPAS

	Ref.	Color
 <p>Tapa para Mando de 1 Canal Estéreo</p>	90702 T	BR MF GE PE AL IS PM DU
 <p>Tapa para Mando de 1 Canal Estéreo</p>	50702 T	BR MF BM PM PR GR PL CH
 <p>Tapa para Mando de 1 Canal Estéreo</p>	70702 T	BR MF
 <p>Tapa para Mando de 1 Canal Mono</p>	90700 T	BR MF GE PE AL IS PM DU
 <p>Tapa para Mando de 1 Canal Mono</p>	50700 T	BR MF BM PM PR GR PL CH
 <p>Tapa para Mando de 1 Canal Mono</p>	70700 T	BR MF
 <p>Tapa para Mando de 1 Canal Mono</p>	45371 S	BR BM PM AL



ALTAVOCES DE EMPOTRAR DE 2"

 <p>Altavoz de 2" - 32 Ohm Potencia máxima: 10 W. Respuesta de frecuencia: 450 - 5000 Hz.</p>	21581
--	--------------

TAPAS



 <p>Tapa para Altavoz de 2" - 32 Ohm / Timbre</p>	90710 T	BR MF GE PE AL IS PM DU
 <p>Tapa para Altavoz de 2" - 32 Ohm / Timbre</p>	50710 T	BR MF BM PM PR GR PL CH
 <p>Tapa para Altavoz de 2" - 32 Ohm / Timbre</p>	70710 T	BR MF

ALTAVOCES DE EMPOTRAR DE 5"

 <p>Altavoz de 5" - 32 Ohm Dimensiones exteriores (mm): ø 180. Potencia máxima: 30 W. Respuesta de frecuencia: 70 - 15000 Hz.</p>	75023 C	
 <p>Altavoz de 5" - 16 Ohm Dimensiones exteriores (mm): ø 180. Potencia máxima: 30 W. Respuesta de frecuencia: 70 - 15000 Hz.</p>	75022 C	BR MF
 <p>Altavoz de 5" - 8 Ohm Dimensiones exteriores (mm): ø 180. Potencia máxima: 30 W. Respuesta de frecuencia: 70 - 15000 Hz.</p>	75021 C	

T - Tecla, Tapa o Marco; S - Semi-montado. | BR - Blanco; MF - Marfil; GE - Hielo; PE - Perla; AL - Aluminio; IS - Gris; BM - Blanco Mate; PM - Negro Mate; DU - Dorado; PR - Plata; GR - Grafito; PL - Platino; CH - Champán.

Marcos das Series **LOGUS 90** - pág. 10 | **APOLLO 5000** - pág. 26 | **SIRIUS** - pág. 39 | Marcos das Series **SIZA** - pág. 58 | **QUADRA** - pág. 60 | **LATINA** - pág. 62.

 /  - Conexión tuerca tornillo









ALTAVOCES DE EMPOTRAR DE 6,5"

	Ref.	Color
 <p>Altavoz de 2 vías Cuadrado de 6,5" - 32 Ohm Dimensiones exteriores (mm): 220 x 220 x 93. Potencia máxima: 60 W. Respuesta de frecuencia: 60 - 20000 Hz.</p>	75083 C	
<p>Altavoz de 2 vías Cuadrado de 6,5" - 16 Ohm Dimensiones exteriores (mm): 220 x 220 x 93. Potencia máxima: 60 W. Respuesta de frecuencia: 60 - 20000 Hz.</p>	75082 C	BR MF
<p>Altavoz de 2 vías Cuadrado de 6,5" - 8 Ohm Dimensiones exteriores (mm): 220 x 220 x 93. Potencia máxima: 60 W. Respuesta de frecuencia: 60 - 20000 Hz.</p>	75081 C	



ALTAVOCES DE SUPERFICIE DE 5"

 <p>Altavoz de Superficie de 2 vías Extraplano de 5" - 32 Ohm Dimensiones exteriores (mm): 274 x 185 x 36,5. Potencia máxima: 15 W. Respuesta de frecuencia: 80 - 19000 Hz.</p>	75106 C	
<p>Altavoz de Superficie de 2 vías Extraplano de 5" - 16 Ohm Dimensiones exteriores (mm): 274 x 185 x 36,5. Potencia máxima: 15 W. Respuesta de frecuencia: 80 - 19000 Hz.</p>	75105 C	BR
<p>Altavoz de Superficie de 2 vías Extraplano de 5" - 8 Ohm Dimensiones exteriores (mm): 274 x 185 x 36,5. Potencia máxima: 15 W. Respuesta de frecuencia: 80 - 19000 Hz.</p>	75104 C	

ACCESORIOS

 <p>Soporte para Mecanismos de Empotrar Q45</p>	45993	-
 <p>Soporte de Fijación para Mecanismos de Empotrar LATINA - 2 módulos</p>	42993	-
 <p>Amplificador Estéreo/Mono Potencia de salida: Estéreo: 12W + 12W (4 o 8 Ohm); Mono: 12W (4 o 8 Ohm). Alimentación: 15 V ~. Función: Stand by. Posibilidad de instalación en una Caja de Empotrar Profunda para Amplificador y Altavoces de 5" (Ref.75984). Amplifica la señal de audio proveniente del Mando, de forma que permite instalar de 8 a 16 Altavoces a un Mando mono y 10 a 16 Altavoces a un Mando estéreo.</p>	75032	-
 <p>Caja de Empotrar para Altavoces de 5" Dimensiones exteriores (mm): ø 165, P = 64.</p>	75983	-
 <p>Caja de Empotrar Profunda para Amplificador y Altavoces de 5" Dimensiones exteriores (mm): ø 165, P = 92.</p>	75984	-
 <p>Caja de Empotrar para Altavoces Cuadrados Dimensiones exteriores (mm): 227,8 x 227,8 x 119.</p>	75986	-
 <p>Tapa para Pre-Instalación de Altavoces de 5" Dimensiones exteriores (mm): ø 173. Para ser usado con cajas Ref.º 75983 y Ref.º 75984.</p>	75999 A	BR
 <p>Mando a Distancia Multifunciones Control Termostato Multifuncional. Control de Mandos de Persiana. Control de instalaciones de sonido. Funciona con pila CR 2032, no incluida.</p>	81900	-

C - Producto Completo; A - Accesorio. | BR - Blanco; MF - Marfil.

 /  - Conexión tuerca tornillo

APARELLAJE ESTANCO

ESTANCO 48

90

















04





ESTANCA 48

MECANISMOS DE MANDO	92
TOMAS DE CORRIENTE	93
OTROS PRODUCTOS	93













MECANISMOS DE MANDO

		Ref.	Color
	Interruptor Unipolar 10 AX - 250 V ~	48011 C	CZ BR
	Interruptor Luminoso 10 AX - 250 V ~	48012 C	CZ BR
	Interruptor con Piloto de Señalización 10 AX - 250 V ~	48013 C	CZ BR
	Interruptor Bipolar 10 AX - 250 V ~	48021 C	CZ BR
	Interruptor Bipolar con Piloto de Señalización 10 AX - 250 V ~	48023 C	CZ BR
	Doble Interruptor 10 AX - 250 V ~	48061 C	CZ BR
	Conmutador 10 AX - 250 V ~	48071 C	
	Conmutador Luminoso 10 AX - 250 V ~	48072 C	CZ BR
	Conmutador con Piloto de Señalización 10 AX - 250 V ~	48073 C	
	Doble Conmutador 10 AX - 250 V ~	48101 C	CZ BR
	Conmutador de Cruce 10 AX - 250 V ~	48051 C	CZ BR
	Conmutador de Cruce Luminoso 10 AX - 250 V ~	48052 C	
	Pulsador 10 A - 250 V ~	48151 C	
	Pulsador Luminoso de 250 V ~ 10 A - 250 V ~	48152 C	CZ BR
	Pulsador Luminoso de 12 V 6 A - 12 V	48162 C	
	Interruptor para Persiana 10 A - 250 V ~	48290 C	CZ BR
	Doble Pulsador para Persiana 10 A - 250 V ~	48281 C	CZ BR
	Doble Pulsador Conmutador para Persiana 10 A - 250 V ~	48283 C	CZ BR





C - Producto Completo. | CZ - Gris; BR - Blanco.

 /  - Conexión tuerca tornillo

TOMAS DE CORRIENTE

	Ref.	Color
 Toma Schuko con Protección 16 A - 250 V~	48132 C	CZ BR
 Toma Schuko 16 A - 250 V~	48131 C	
 Toma Francesa con Protección 16 A - 250 V~	48112 C	CZ BR
 Toma 2P con Protección 16 A - 250 V~	48122 C	CZ BR
 Doble Toma Schuko Horizontal con Protección 16 A - 250 V~	48865 C	CZ BR
 Doble Toma Schuko Horizontal 16 A - 250 V~	48862 C	
 Doble Toma Schuko Vertical con Protección 16 A - 250 V~	48860 C	CZ BR
 Doble Toma Schuko Vertical 16 A - 250 V~	48868 C	
 Conmutador / Toma Schuko Vertical con Protección 10 AX - 250 V~ / 16 A - 250 V~	48866 C	CZ BR
 Conmutador / Toma Schuko Vertical 10 AX - 250 V~ / 16 A - 250 V~	48861 C	
 Toma de Superficie Schuko para Recarga VE 16 A - 250 V~	NUEVO 81751	—
 Toma de Superficie Francesa para Recarga VE 16 A - 250 V~	NUEVO 81752	—

OTROS PRODUCTOS

 Caja Serie 48 con Tapa para MEC Q45 Otorga grado IP65 a los mecanismos MEC Q45 [Dispositivos Electrónicos, Tomas de Datos, etc].	48998 C	CZ BR
 Señalizador Luminoso Alto Máx. 5 W / 250 V~ (E14) Para ser usado con la lámpara Ref. 81013.	48361 C	ZI ZR ZV ZM BI BJ BV BM
 Señalizador Luminoso Bajo Máx. 5 W / 250 V~ (E14) Para ser usado con la lámpara Ref. 81013.	48362 C	
 Caja para Botoneras ø 22 mm El INDICE de Protección (IP65) solo es garantizado con la utilización de elementos de mando y señalización con INDICES de protección no inferiores.	48992 A	CZ BR
 Doble Toma Horizontal	48994 A	CZ BR
 Doble Toma Vertical	48995 A	
 Lámpara LED E14 Baja 250 V~ - 0,3 W (3000 K)	81013	—
 LED para la Serie MEC 21 y Serie 48 - 250 V~	81019	—
 LED para la Serie MEC 21 y Serie 48 - 12 V	81018	—

C - Producto Completo; A - Accesorio. | CZ - Gris; BR - Blanco.

SEÑALIZADORES: ZI - Gris/Transparente; ZR - Gris/Naranja; ZV - Gris/Verde; ZM - Gris/Rojo; BI - Blanco/Transparente; BJ - Blanco/Naranja; BV - Blanco/Verde; BM - Blanco/Rojo.

⊕/⊖ / ⊕/⊖ - Conexión tuerca tornillo

MECANISMOS DE SUPERFICIE

3700

47

2600

96

101

105

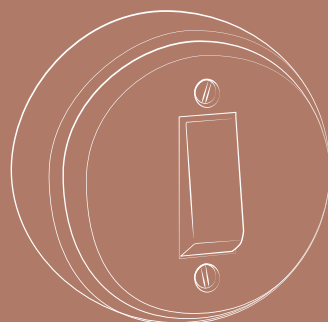
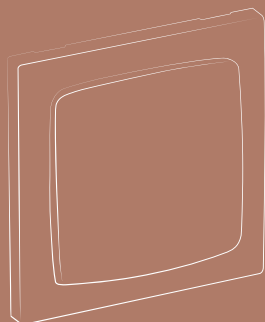
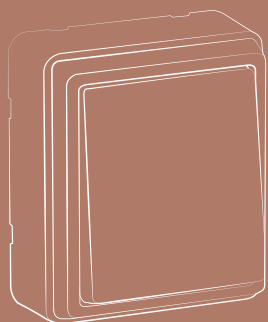

05

































3700





3700

MECANISMOS DE MANDO	98
TOMAS DE DATOS, VOZ E IMAGEN	99
TOMAS DE CORRIENTE	99
OTROS PRODUCTOS	100
ACCESORIOS PARA MONTAJE EN CANALES <i>ETS IO - MOLDURAS Y ZÓCALO</i>	100

MECANISMOS DE MANDO



	Ref.	Color
 Interruptor Unipolar 10 AX - 250 V ~ 	37011 C	
 Interruptor Luminoso 10 AX - 250 V ~ 	37012 C	
 Interruptor con Piloto de Señalización 10 AX - 250 V ~ 	37013 C	
 Doble Interruptor 10 AX - 250 V ~ 	37061 C	
 Conmutador 10 AX - 250 V ~ 	37071 C	
 Conmutador Luminoso 10 AX - 250 V ~ 	37072 C	
 Conmutador con Piloto de Señalización 10 AX - 250 V ~ 	37073 C	
 Doble Conmutador 10 AX - 250 V ~ 	37101 C	
 Conmutador de Cruce 10 AX - 250 V ~ 	37051 C	BR
 Pulsador 10 A - 250 V ~ 	37151 C	
 Pulsador Luminoso 10 A - 250 V ~ 	37152 C	
 Pulsador 2 A - 250 V ~ 	37157 C	
 Pulsador Luminoso de 250 V ~ 2 A - 250 V ~ 	37158 C	
 Pulsador Luminoso de 12 V 6 A - 12 V 	37168 C	
 Interruptor para Persiana 10 A - 250 V ~ 	37290 C	
 Doble Pulsador para Persiana 10 A - 250 V ~ 	37281 C	

C - Producto Completo. | BR - Blanco.

 /  - Conexión tuerca tornillo

TOMAS DE DATOS, VOZ E IMAGEN

TOMAS INFORMÁTICAS

	Ref.	Color
Toma Informática RJ45 Cat. 6 UTP	 37455 C	
 Toma Informática RJ45 Cat. 6 STP	37445 C	BR
Toma Informática RJ45 Cat. 5e UTP	37453 C	

TOMAS TELEFÓNICAS

50 V ~- 70 V ~-

 Toma Telefónica (4 conductores)	37252 C	BR
Toma Telefónica Gel (4 conductores)	37255 C	

8 CONTACTOS



 Toma Telefónica Francesa T8	37411 C	BR
--	---------	----

TOMAS DE RADIO, TELEVISIÓN Y SATÉLITE

RADIO Y TELEVISIÓN

 Toma R - TV Ecuilizada Final/Estrella Conector coaxial ø 9,5. 4 - 862 MHz: ≤ 1 dB.	37531 C	BR
 Toma R - TV Ecuilizada Intermedia/Serie Conector Coaxial ø 9,5. 4 - 862 MHz: ≤ 6 dB. Pérdidas de inserción: ≤ 2 dB.	37532 C	

RADIO, TELEVISIÓN Y SATÉLITE



 Toma R TV - SAT Estrella Conector coaxial ø 9,5. 4 - 470 MHz: ≤ 1 dB. 470 - 862 MHz: ≤ 3 dB. 950 - 2400 MHz: ≤ 6 dB. Paso de corriente: 500 mA (DC).	37550 C	BR
 Toma de Cable Coaxial Tipo F	37431 C	

TOMAS DE CORRIENTE



SCHUKO

 Toma Schuko con Protección 16 A - 250 V ~	37132 C	BR LR VM
 Toma Schuko 16 A - 250 V ~	37131 C	

C - Producto Completo. | BR - Blanco; LR - Naranja; VM - Rojo

 /  - Conexión tuerca tornillo - Power over Ethernet





TOMAS DE CORRIENTE

2 P		Ref.	Color
	Toma 2P con Protección 16 A - 250 V ~	37122 C	BR
	Toma 2P 16 A - 250 V ~	37121 C	

FRANCESAS

	Toma Francesa con Protección 16 A - 250 V ~	37112 C	BR
--	--	----------------	----



OTROS PRODUCTOS

	Caja para Salida de Cables sin Terminales Sin terminales de conexión.	37170 C	BR
	Caja de Derivación 4x2,5mm ² .	37201 C	
	Señalizador Máx. 5 W / 250 V ~ (E14). Para ser usado con la lámpara Ref. 81013.	37360 C	BI BJ BV BM
	Lámpara LED E14 Baja 250 V ~ - 0,3 W (3000 K)	81013	-

ACCESORIOS PARA MONTAJE EN CANALES ETS IO - MOLDURAS Y ZÓCALO

	Adaptador Lateral de la Serie 3700 para Canal 12x7	10017 A	
	Adaptador Lateral de la Serie 3700 para Canal 16x10	10027 A	
	Adaptador Lateral de la Serie 3700 para Canal 20x12,5	10037 A	
	Adaptador Lateral de la Serie 3700 para Canal 32x16	10047 A	
	Adaptador Lateral de la Serie 3700 para Canal 40x12,5	10057 A	
	Adaptador Lateral de la Serie 3700 para Canal 40x16	10067 A	BR
	Adaptador Lateral de la Serie 3700 para Canal 60x16	10077 A	
	Adaptador Lateral de la Serie 3700 para Canal de Zócalo 110x20	10107 A	
	Adaptador Lateral de la Serie 3700 para Canal 75x20	10147 A	

C - Producto Completo; A - Accesorio. | BR - Blanco; BI - Blanco/Transparente; BJ - Blanco/Naranja; BV - Blanco/Verde; BM - Blanco/Rojo.























 /  - Conexión tornillo

47

MECANISMOS DE MANDO	102
TOMAS DE DATOS, VOZ E IMAGEN	102
TOMAS DE CORRIENTE	103
OTROS PRODUCTOS	104
ACCESORIOS PARA MONTAJE DE SUPERFICIE	104
ACCESORIOS PARA MONTAJE EN CANALES <i>ETS IO - MOLDURAS</i>	104



MECANISMOS DE MANDO

	Ref.	Color
 Interruptor Unipolar 10 AX - 250 V ~ 	47011 S	
 Interruptor con Piloto de Señalización 10 AX - 250 V ~ 	47013 S	
 Doble Interruptor 10 AX - 250 V ~ 	47061 S	
 Conmutador 10 AX - 250 V ~ 	47071 S	
 Doble Conmutador 10 AX - 250 V ~ 	47101 S	
 Conmutador de Cruce 10 AX - 250 V ~ 	47051 S	BR
 Pulsador 10 A - 250 V ~ 	47151 S	
 Pulsador Luminoso de 250 V ~ 10 A - 250 V ~ 	47152 S	
 Pulsador con Porta-rótulos de 250 V ~ 10 A - 250 V ~ 	47155 S	
 Interruptor para Persiana 10 A - 250 V ~ 	47290 S	
 Doble Pulsador para Persiana 10 A - 250 V ~ 	47281 S	

TOMAS DE DATOS, VOZ E IMAGEN

TOMAS INFORMÁTICAS



Toma Informática RJ45 Cat. 6 UTP	 47455 S	
 Toma Informática RJ45 Cat. 6 STP	47445 S	BR
Toma Informática RJ45 Cat. 5e UTP	47453 S	

TOMAS TELEFÓNICAS

50 V ~ 70 V ~

 Toma Telefónica (4 conductores)	47252 S	BR
--	---------	----

S - Semi-montado. | BR - Blanco.

 /  - Conexión tuerca tornillo - Power over Ethernet

TOMAS DE DATOS, VOZ E IMAGEN

TOMAS TELEFÓNICAS

8 CONTACTOS



Toma Telefónica Francesa T8

47411 S BR

TOMAS DE RADIO, TELEVISIÓN Y SATÉLITE

RADIO Y TELEVISIÓN

Toma R - TV Ecuilizada Final/Estrella

Conector coaxial ø 9,5.

4 - 862 MHz: ≤ 1 dB.

47531 S



BR

Toma R - TV Ecuilizada Intermedia/Serie

Conector Coaxial ø 9,5.

4 - 862 MHz: ≤ 6 dB.

Pérdidas de inserción: ≤ 2 dB.

47532 S

RADIO, TELEVISIÓN Y SATÉLITE

Toma R TV - SAT Estrella

Conector coaxial ø 9,5.

4 - 470 MHz: ≤ 1 dB.

470 - 862 MHz: ≤ 3 dB.

950 - 2400 MHz: ≤ 6 dB.

Paso de corriente: 500 mA (DC).

47550 S



BR



Toma de Cable Coaxial Tipo F

47431 S

TOMAS DE CORRIENTE

SCHUKO

Toma Schuko con Protección

16 A - 250 V~

47132 S



Toma Schuko

16 A - 250 V~

47131 S

2 P

Toma 2P con Protección

16 A - 250 V~

47122 S



BR



Toma 2P

16 A - 250 V~

47121 S

FRANCESAS



Toma Francesa con Protección

16 A - 250 V~



47112 S



S - Semi-montado. | BR - Blanco; LR - Naranja; VM - Rojo.

/ - Conexión tuerca tornillo

OTROS PRODUCTOS

		Ref.	Color
	Caja para Salida de Cables sin Terminales Sin terminales de conexión.	47170 S	BR
	Caja de Derivación 4x2,5 mm ² .	47201 S	BR
	Señalizador Máx. 5 W / 250 V ~ (E14). Para ser usado con la lámpara Ref. 81013.	47360 S	BI BJ BV BM
	Lámpara LED E14 Baja 250 V ~ - 0,3 W (3000 K)	81013	—

ACCESORIO PARA MONTAJE DE SUPERFICIE



	Caja 60x60 mm	47993 A	BR
--	----------------------	----------------	----

ACCESORIOS PARA MONTAJE EN CANALES ETS IO - MOLDURAS



MONTAJE LATERAL

	Adaptador Lateral de la Serie 47 para Canal 12x7	10018 A	
	Adaptador Lateral de la Serie 47 para Canal 16x10	10028 A	
	Adaptador Lateral de la Serie 47 para Canal 20x12,5	10038 A	
	Adaptador Lateral de la Serie 47 para Canal 32x16	10048 A	
	Adaptador Lateral de la Serie 47 para Canal 40x12,5	10058 A	BR
	Adaptador Lateral de la Serie 47 para Canal 40x16	10068 A	
	Adaptador Lateral de la Serie 47 para Canal 60x16	10078 A	
	Adaptador Lateral de la Serie 47 para Canal 75x20	10148 A	

MONTAJE FRONTAL





	Adaptador Frontal de la Serie 47 para Canal 60x16 Para canales de la ETS 10 Ref. 10070 CBR.	10079 A	
	Adaptador Frontal de la Serie 47 para Canal 75x20 Para canales de la ETS 10 Ref. 10140 CBR.	10149 A	BR

S - Semi-montado; A - Accesorio. | BR - Blanco; BI - Blanco/Transparente; BJ - Blanco/Naranja; BV - Blanco/Verde; BM - Blanco/Rojo.





 /  - Conexión tuerca tornillo



MECANISMOS DE MANDO



		Ref.	Color
	Interruptor Unipolar 10 AX - 250 V ~	26011 C	MF
	Doble Interruptor 10 AX - 250 V ~	26061 C	MF
	Conmutador 10 AX - 250 V ~	26071 C	MF
	Doble Conmutador 10 AX - 250 V ~	26101 C	MF
	Conmutador de Cruce 10 AX - 250 V ~	26051 C	MF
	Pulsador 2 A - 250 V ~	26157 C	MF

TOMAS DE CORRIENTE

	Toma Schuko con Protección 16 A - 250 V ~	26132 C	MF
	Toma Schuko 16 A - 250 V ~	26131 C	MF
	Toma 2P con Protección 16 A - 250 V ~	26122 C	MF
	Toma 2P 16 A - 250 V ~	26121 C	MF

C - Producto Completo. | MF - Marfil.

La Serie 2600 debe ser siempre instalada sobre una base de material aislante.

 /  - Conexión tuerca tornillo

BURÓTICA

CAJAS DE SUELO

110

PUESTOS DE TRABAJO

110

TORRETAS DE MESA

111

COLUMNAS

112

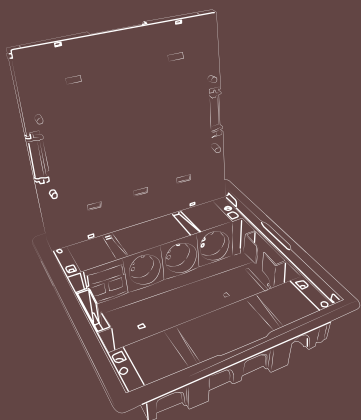





06



BUROTICA



CAJAS DE SUELO	110
PUESTOS DE TRABAJO	110
TORRETAS DE MESA	111
MINICOLUMNAS	112
COLUMNAS	112

CAJAS DE SUELO

		Ref.	Color
	Caja de Suelo - 4 Módulos	83002 C	CZ AT BR
	Caja de Empotrar para Caja de Suelo - 4 Módulos	83052	—
	Caja de Suelo - 16 Módulos	83008 C	CZ AT
	Caja de Suelo con Tapa Inox - 16 Módulos	83008 C	ZI AI
	Caja de Empotrar para Caja de Suelo - 16 Módulos	83058	—
	Bloc de Poliestireno	83190	—

PUESTOS DE TRABAJO

DE SUPERFICIE

	Puesto de Trabajo de Superficie - 2x4 + 4x4 Módulos	NUEVO 83410 S	
	Puesto de Trabajo de Superficie - 2x4 Módulos	NUEVO 83411 S	
	Puesto de Trabajo de Superficie - 3x4 Módulos	NUEVO 83412 S	BR BM PM AL
	Puesto de Trabajo de Superficie - 4x4 Módulos	NUEVO 83413 S	
	Puesto de Trabajo de Superficie 2x4 + 4x4 Módulos con 2 Schuko VM + 2 Schuko BR + 2 RJ	83410 C	BR
	Puesto de Trabajo de Superficie 2x4 + 4x4 Módulos con 2 Toma Francesa VM + 2 Toma Francesa BR + 2 RJ	83441 C	

EMPOTRAR

	Puesto de Trabajo de Empotrar - 2x4 Módulos	NUEVO 83401 S	
	Puesto de Trabajo de Empotrar - 3x4 Módulos	NUEVO 83402 S	BR BM PM AL
	Puesto de Trabajo de Empotrar - 4x4 Módulos	NUEVO 83403 S	

C - Producto Completo; S - Semi-montado. | BR - Blanco; CZ - Gris; AT - Antracita; ZI - Gris/Inox; AI - Antracita/Inox; BM - Blanco Mate; PM - Negro Mate; AL - Aluminio
Aplicable con mecanismos MEC Q45.

PUESTOS DE TRABAJO

EMPOTRAR

		Ref.	Color
	Puesto de Trabajo de Empotrar 3x4 Módulos con 2 Schuko VM + 2 Schuko BR + 2 RJ	83402 C	BR
	Puesto de Trabajo de Empotrar 3x4 Módulos con 2 Toma Francesa VM + 2 Toma Francesa BR + 2 RJ	83431 C	



Puesto de Trabajo de Empotrar con Puerta - 2x8 Módulos

83404 S BR

ACCESORIOS



Adaptador MODUS 55 para Puestos de Trabajo

83420



Tapa para Acceso de Canal a los Puestos de Trabajo

83421

TORRETAS DE MESA



Torreta de Mesa - 8+2 Módulos
Aluminio.

83201 S

BR



Torreta de Mesa - 12+2 Módulos
Aluminio.

83202 S



Parte Superior con Adaptador para Torreta de Mesa - 2 Módulos Q45

83230 A



Parte Superior Pasacables para Torreta de Mesa

83231 A

BR



Módulo para Conector Rápido 2P + T - 2 Módulos

NUEVO 45980 S



Módulo Doble para 2 Conectores Rápidos 2P + T - 2 Módulos

NUEVO 45981 S



Conector Rápido 2P + T Macho de Panel

NUEVO 83152



Conector Rápido 2P + T Hembra de Panel

NUEVO 83153



Conector Rápido 2P + T Macho para Cablear

NUEVO 83150

PT VM



Conector Rápido 2P + T Hembra para Cablear

NUEVO 83151











Derivación 1 Entrada / 3 Salidas

NUEVO 83154



A - Accesorio; C - Producto Completo; S - Semi-montado. | BR - Blanco; PT - Negro; VM - Rojo.
Aplicable con mecanismos MEC Q45.

TORRETAS DE MESA

ACCESORIOS

		Ref.	Color
	<p>Posicionador 90° para 2 Módulos Para utilizar con mecanismos da MEC Q4.5 en Torretas de Mesa, Columnas y Minicolumnas.. Posibilidad de montar los mecanismo con rotación de 90°.</p>	45992	—
	<p>Prensaestopas 3G 1,5mm</p>	81191	—
	<p>Prensaestopas 3G 2,5mm</p>	81192	—
	<p>Perfil de Torreta de Mesa Aluminio.</p>	83232	—
	<p>Adaptador para MODUS 55 en Torretas de Mesa y Columnas</p>	 83220	—
	<p>Kit de Fijación de Torretas de Mesa</p>	 83234	—

MINICOLUMNAS









	<p>Minicolumna - 2 faces 12+12 Módulos Aluminio. Altura (mm): 340.</p>	 83282	
	<p>Minicolumna - 2 faces 18+18 Módulos Aluminio. Altura (mm): 480.</p>	83281	—
	<p>Minicolumna - 2 faces 28+28 Módulos Aluminio. Altura (mm): 710.</p>	 83283	

COLUMNAS

	<p>Columna - 2 caras - 2850mm Aluminio.</p>	83241	—
	<p>Columna - 2 caras - 3300mm Aluminio.</p>	83242	—

MINICOLUMNAS Y COLUMNAS

ACCESORIOS

		Ref.	Color
	Adaptador para MODUS 55 en Torretas de Mesa y Columnas	 83220	—
	Posicionador 90° para 2 Módulos Para utilizar con mecanismos da MEC Q45 en Torretas de Mesa, Columnas y Minicolumnas. Posibilidad de montar los mecanismo con rotación de 90°.	45992	—
	Tope Columna	83250 A	CZ AL
	Base Columna/Minicolumna	83251 A	CZ AL
	Tope Minicolumna	83290 A	CZ AL
	Varilla Roscada Dimensión: 1,00 metro.	83252 A	—
	Perfil para Coluna/Minicolumna - 2 caras - 3180mm	83253	—
	Tapa para Perfil Dimensión: 2,10 metros.	83233	—

A - Accesorio. | CZ - Gris; AL - Aluminio.

CANALES TÉCNICOS

ETS 10 - INSTALACIONES ELÉCTRICAS Y DE TELECOMUNICACIONES 118

ETS 13 - PROTECCIÓN DE CABLES Y TUBOS 126

ETS 14 - CUADROS ELÉCTRICOS 127

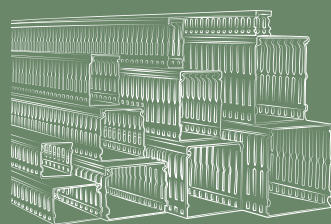
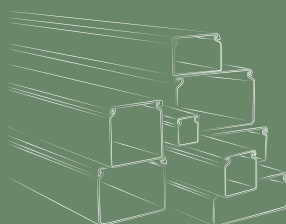
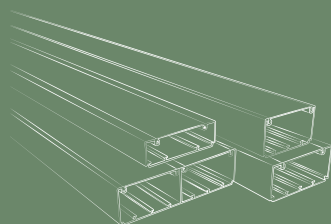

07



CANALES TÉCNICOS

ETS 10 - PARA INSTALACIONES ELÉCTRICAS Y DE TELECOMUNICACIONES

- MOLDURAS 118

- DISTRIBUCIÓN 120

• TAPA L45 - CLIPAJE DIRECTO  120

• TAPA L75 - UNIVERSAL 120























































































































































- ZÓCALO Y SUELO 123

- ACCESORIOS PARA MONTAJE DE MECANISMOS 124

ETS 13 - PARA PROTECCIÓN DE CABLES Y TUBOS 126

ETS 14 - PARA CUADROS ELÉCTRICOS 127







ACCESORIOS PARA MONTAJE DE CANALES

MOLDURAS																																																																																																																																						
AN x AL (mm)	Perfil	Ref.	Tope	Junta	Derivación																																																																																																																																	
12x7		10010 CBR	10015 ABR	10014 ABR	10011 ABR																																																																																																																																	
		10010 FBR				16x10		10020 CBR	10025 ABR	10024 ABR	10021 ABR	10020 FBR	20x12,5		10030 CBR	10035 ABR	10034 ABR	10031 ABR	10030 FBR	10030 HBR	10035 GBR	10034 GBR	10031 GBR	25x16		10450 CBR	10455 ABR	10454 ABR	10451 ABR	10450 FBR	32x12,5		10410 CBR	10405 ABR	10404 ABR	10401 ABR	10410 FBR	10410 HBR	10405 GBR	10404 GBR	10401 GBR	32x12,5		10400 CBR	10405 ABR	10404 ABR	10401 ABR	10400 FBR	10400 HBR	10405 GBR	10404 GBR	10401 GBR	32x16		10040 CBR	10045 ABR	10044 ABR	10041 ABR	10040 FBR	10040 HBR	10045 GBR	10044 GBR	10041 GBR	40x12,5		10050 CBR	10055 ABR	10054 ABR	10051 ABR	10050 FBR	10050 HBR	10055 GBR	10054 GBR	10051 GBR	40x12,5		10150 CBR	10055 ABR	10054 ABR	10051 ABR	10150 FBR	40x16		10060 CBR	10065 ABR	10064 ABR	10061 ABR	10060 FBR	10060 HBR	10065 GBR	10064 GBR	10061 GBR	40x16		10160 CBR	10065 ABR	10064 ABR	10061 ABR	10160 FBR	40x25		10480 CBR	10485 ABR	10484 ABR	10481 ABR	50x20		10500 CBR	10505 ABR	10504 ABR	10501 ABR	10500 HBR	10505 GBR	10504 GBR	10501 GBR	50x20		10510 CBR	10505 ABR	10504 ABR	10501 ABR	50x20		10520 CBR	60x16		10070 CBR	10075 ABR	10074 ABR	10071 ABR	60x16		10170 CBR	75x20
16x10		10020 CBR	10025 ABR	10024 ABR	10021 ABR																																																																																																																																	
		10020 FBR				20x12,5		10030 CBR	10035 ABR	10034 ABR	10031 ABR	10030 FBR			10030 HBR	10035 GBR	10034 GBR	10031 GBR	25x16		10450 CBR	10455 ABR	10454 ABR	10451 ABR	10450 FBR	32x12,5		10410 CBR	10405 ABR	10404 ABR			10401 ABR	10410 FBR	10410 HBR	10405 GBR	10404 GBR	10401 GBR	32x12,5		10400 CBR			10405 ABR	10404 ABR	10401 ABR	10400 FBR	10400 HBR	10405 GBR	10404 GBR	10401 GBR	32x16				10040 CBR	10045 ABR	10044 ABR	10041 ABR	10040 FBR	10040 HBR	10045 GBR	10044 GBR			10041 GBR	40x12,5		10050 CBR	10055 ABR	10054 ABR	10051 ABR	10050 FBR	10050 HBR	10055 GBR	10054 GBR	10051 GBR	40x12,5		10150 CBR	10055 ABR			10054 ABR	10051 ABR	10150 FBR	40x16		10060 CBR	10065 ABR	10064 ABR	10061 ABR	10060 FBR	10060 HBR	10065 GBR	10064 GBR	10061 GBR	40x16		10160 CBR	10065 ABR	10064 ABR	10061 ABR	10160 FBR	40x25		10480 CBR	10485 ABR	10484 ABR	10481 ABR	50x20		10500 CBR	10505 ABR	10504 ABR	10501 ABR	10500 HBR	10505 GBR	10504 GBR	10501 GBR	50x20		10510 CBR	10505 ABR	10504 ABR	10501 ABR	50x20		10520 CBR	60x16		10070 CBR	10075 ABR	10074 ABR
20x12,5		10030 CBR	10035 ABR	10034 ABR	10031 ABR																																																																																																																																	
		10030 FBR						10030 HBR	10035 GBR	10034 GBR	10031 GBR	25x16		10450 CBR	10455 ABR	10454 ABR	10451 ABR	10450 FBR	32x12,5		10410 CBR	10405 ABR	10404 ABR	10401 ABR	10410 FBR			10410 HBR	10405 GBR	10404 GBR	10401 GBR	32x12,5		10400 CBR	10405 ABR	10404 ABR	10401 ABR	10400 FBR			10400 HBR	10405 GBR	10404 GBR	10401 GBR	32x16		10040 CBR	10045 ABR	10044 ABR	10041 ABR	10040 FBR		10040 HBR	10045 GBR		10044 GBR	10041 GBR	40x12,5		10050 CBR	10055 ABR	10054 ABR	10051 ABR	10050 FBR	10050 HBR	10055 GBR			10054 GBR	10051 GBR	40x12,5		10150 CBR	10055 ABR	10054 ABR	10051 ABR	10150 FBR	40x16		10060 CBR	10065 ABR	10064 ABR	10061 ABR	10060 FBR	10060 HBR	10065 GBR			10064 GBR	10061 GBR	40x16		10160 CBR	10065 ABR	10064 ABR	10061 ABR	10160 FBR	40x25		10480 CBR	10485 ABR	10484 ABR	10481 ABR	50x20		10500 CBR	10505 ABR	10504 ABR	10501 ABR	10500 HBR	10505 GBR	10504 GBR	10501 GBR	50x20		10510 CBR	10505 ABR	10504 ABR	10501 ABR	50x20		10520 CBR	60x16		10070 CBR	10075 ABR	10074 ABR	10071 ABR	60x16		10170 CBR	75x20		10140 CBR
		10030 HBR	10035 GBR	10034 GBR	10031 GBR																																																																																																																																	
25x16		10450 CBR	10455 ABR	10454 ABR	10451 ABR																																																																																																																																	
		10450 FBR				32x12,5		10410 CBR	10405 ABR	10404 ABR	10401 ABR	10410 FBR	10410 HBR	10405 GBR	10404 GBR	10401 GBR	32x12,5		10400 CBR	10405 ABR	10404 ABR	10401 ABR	10400 FBR	10400 HBR	10405 GBR	10404 GBR	10401 GBR	32x16		10040 CBR	10045 ABR	10044 ABR	10041 ABR	10040 FBR	10040 HBR	10045 GBR	10044 GBR	10041 GBR	40x12,5		10050 CBR	10055 ABR	10054 ABR	10051 ABR	10050 FBR	10050 HBR	10055 GBR	10054 GBR	10051 GBR	40x12,5		10150 CBR	10055 ABR	10054 ABR	10051 ABR	10150 FBR	40x16		10060 CBR	10065 ABR	10064 ABR	10061 ABR	10060 FBR	10060 HBR	10065 GBR	10064 GBR	10061 GBR	40x16		10160 CBR	10065 ABR	10064 ABR	10061 ABR	10160 FBR	40x25		10480 CBR	10485 ABR	10484 ABR	10481 ABR	50x20		10500 CBR	10505 ABR	10504 ABR	10501 ABR	10500 HBR	10505 GBR	10504 GBR	10501 GBR	50x20		10510 CBR	10505 ABR	10504 ABR	10501 ABR	50x20		10520 CBR	60x16		10070 CBR	10075 ABR	10074 ABR	10071 ABR	60x16		10170 CBR	75x20		10140 CBR	10145 ABR	10144 ABR	10141 ABR																				
32x12,5		10410 CBR	10405 ABR	10404 ABR	10401 ABR																																																																																																																																	
		10410 FBR						10410 HBR	10405 GBR	10404 GBR	10401 GBR	32x12,5		10400 CBR	10405 ABR	10404 ABR			10401 ABR	10400 FBR	10400 HBR	10405 GBR	10404 GBR	10401 GBR	32x16		10040 CBR			10045 ABR	10044 ABR	10041 ABR	10040 FBR	10040 HBR	10045 GBR	10044 GBR	10041 GBR	40x12,5				10050 CBR	10055 ABR	10054 ABR	10051 ABR	10050 FBR	10050 HBR	10055 GBR	10054 GBR	10051 GBR	40x12,5		10150 CBR	10055 ABR	10054 ABR	10051 ABR			10150 FBR	40x16		10060 CBR	10065 ABR	10064 ABR	10061 ABR	10060 FBR	10060 HBR	10065 GBR	10064 GBR	10061 GBR	40x16		10160 CBR	10065 ABR	10064 ABR	10061 ABR	10160 FBR	40x25		10480 CBR	10485 ABR	10484 ABR	10481 ABR	50x20		10500 CBR	10505 ABR	10504 ABR	10501 ABR	10500 HBR	10505 GBR	10504 GBR	10501 GBR	50x20		10510 CBR	10505 ABR	10504 ABR	10501 ABR	50x20		10520 CBR	60x16		10070 CBR	10075 ABR	10074 ABR	10071 ABR	60x16		10170 CBR	75x20		10140 CBR	10145 ABR	10144 ABR	10141 ABR																	
		10410 HBR	10405 GBR	10404 GBR	10401 GBR																																																																																																																																	
32x12,5		10400 CBR	10405 ABR	10404 ABR	10401 ABR																																																																																																																																	
		10400 FBR				10400 HBR	10405 GBR	10404 GBR	10401 GBR	32x16		10040 CBR	10045 ABR	10044 ABR	10041 ABR	10040 FBR	10040 HBR	10045 GBR	10044 GBR	10041 GBR	40x12,5		10050 CBR	10055 ABR	10054 ABR	10051 ABR	10050 FBR	10050 HBR	10055 GBR	10054 GBR	10051 GBR	40x12,5		10150 CBR	10055 ABR	10054 ABR	10051 ABR	10150 FBR	40x16		10060 CBR	10065 ABR	10064 ABR	10061 ABR	10060 FBR	10060 HBR	10065 GBR	10064 GBR	10061 GBR	40x16		10160 CBR	10065 ABR	10064 ABR	10061 ABR	10160 FBR	40x25		10480 CBR	10485 ABR	10484 ABR	10481 ABR	50x20		10500 CBR	10505 ABR	10504 ABR	10501 ABR	10500 HBR	10505 GBR	10504 GBR	10501 GBR	50x20		10510 CBR	10505 ABR	10504 ABR	10501 ABR	50x20		10520 CBR	60x16		10070 CBR	10075 ABR	10074 ABR	10071 ABR	60x16		10170 CBR	75x20		10140 CBR	10145 ABR	10144 ABR	10141 ABR																																						
		10400 HBR	10405 GBR	10404 GBR	10401 GBR																																																																																																																																	
32x16		10040 CBR	10045 ABR	10044 ABR	10041 ABR																																																																																																																																	
		10040 FBR				10040 HBR	10045 GBR	10044 GBR	10041 GBR	40x12,5		10050 CBR	10055 ABR	10054 ABR	10051 ABR	10050 FBR	10050 HBR	10055 GBR	10054 GBR	10051 GBR	40x12,5		10150 CBR	10055 ABR	10054 ABR	10051 ABR	10150 FBR	40x16		10060 CBR	10065 ABR	10064 ABR	10061 ABR	10060 FBR	10060 HBR	10065 GBR	10064 GBR	10061 GBR	40x16		10160 CBR	10065 ABR	10064 ABR	10061 ABR	10160 FBR	40x25		10480 CBR	10485 ABR	10484 ABR	10481 ABR	50x20		10500 CBR	10505 ABR	10504 ABR	10501 ABR	10500 HBR	10505 GBR	10504 GBR	10501 GBR	50x20		10510 CBR	10505 ABR	10504 ABR	10501 ABR	50x20		10520 CBR	60x16		10070 CBR	10075 ABR	10074 ABR	10071 ABR	60x16		10170 CBR	75x20		10140 CBR	10145 ABR	10144 ABR	10141 ABR																																																	
		10040 HBR	10045 GBR	10044 GBR	10041 GBR																																																																																																																																	
40x12,5		10050 CBR	10055 ABR	10054 ABR	10051 ABR																																																																																																																																	
		10050 FBR				10050 HBR	10055 GBR	10054 GBR	10051 GBR	40x12,5		10150 CBR	10055 ABR	10054 ABR	10051 ABR	10150 FBR	40x16		10060 CBR	10065 ABR	10064 ABR	10061 ABR	10060 FBR	10060 HBR	10065 GBR	10064 GBR	10061 GBR	40x16		10160 CBR	10065 ABR	10064 ABR	10061 ABR	10160 FBR	40x25		10480 CBR	10485 ABR	10484 ABR	10481 ABR	50x20		10500 CBR	10505 ABR	10504 ABR	10501 ABR	10500 HBR	10505 GBR	10504 GBR	10501 GBR	50x20		10510 CBR	10505 ABR	10504 ABR	10501 ABR	50x20		10520 CBR	60x16		10070 CBR	10075 ABR	10074 ABR	10071 ABR	60x16		10170 CBR	75x20		10140 CBR	10145 ABR	10144 ABR	10141 ABR																																																												
		10050 HBR	10055 GBR	10054 GBR	10051 GBR																																																																																																																																	
40x12,5		10150 CBR	10055 ABR	10054 ABR	10051 ABR																																																																																																																																	
		10150 FBR				40x16		10060 CBR	10065 ABR	10064 ABR	10061 ABR	10060 FBR	10060 HBR	10065 GBR	10064 GBR	10061 GBR	40x16		10160 CBR	10065 ABR	10064 ABR	10061 ABR	10160 FBR	40x25		10480 CBR	10485 ABR	10484 ABR	10481 ABR	50x20		10500 CBR	10505 ABR	10504 ABR	10501 ABR	10500 HBR	10505 GBR	10504 GBR	10501 GBR	50x20		10510 CBR	10505 ABR	10504 ABR	10501 ABR	50x20		10520 CBR	60x16		10070 CBR	10075 ABR	10074 ABR	10071 ABR	60x16		10170 CBR	75x20		10140 CBR	10145 ABR	10144 ABR	10141 ABR																																																																							
40x16		10060 CBR	10065 ABR	10064 ABR	10061 ABR																																																																																																																																	
		10060 FBR						10060 HBR	10065 GBR	10064 GBR	10061 GBR	40x16		10160 CBR	10065 ABR	10064 ABR	10061 ABR	10160 FBR	40x25		10480 CBR	10485 ABR	10484 ABR	10481 ABR	50x20		10500 CBR	10505 ABR	10504 ABR	10501 ABR	10500 HBR	10505 GBR	10504 GBR	10501 GBR	50x20		10510 CBR	10505 ABR	10504 ABR	10501 ABR	50x20		10520 CBR	60x16		10070 CBR	10075 ABR	10074 ABR	10071 ABR	60x16		10170 CBR	75x20		10140 CBR	10145 ABR	10144 ABR	10141 ABR																																																																												
		10060 HBR	10065 GBR	10064 GBR	10061 GBR																																																																																																																																	
40x16		10160 CBR	10065 ABR	10064 ABR	10061 ABR																																																																																																																																	
		10160 FBR				40x25		10480 CBR	10485 ABR	10484 ABR	10481 ABR	50x20		10500 CBR	10505 ABR	10504 ABR	10501 ABR	10500 HBR	10505 GBR	10504 GBR	10501 GBR	50x20		10510 CBR	10505 ABR	10504 ABR	10501 ABR	50x20		10520 CBR	60x16		10070 CBR	10075 ABR	10074 ABR	10071 ABR	60x16		10170 CBR	75x20		10140 CBR	10145 ABR	10144 ABR	10141 ABR																																																																																									
40x25		10480 CBR	10485 ABR	10484 ABR	10481 ABR																																																																																																																																	
50x20		10500 CBR	10505 ABR	10504 ABR	10501 ABR																																																																																																																																	
		10500 HBR	10505 GBR	10504 GBR	10501 GBR																																																																																																																																	
50x20		10510 CBR	10505 ABR	10504 ABR	10501 ABR																																																																																																																																	
50x20		10520 CBR																																																																																																																																				
60x16		10070 CBR	10075 ABR	10074 ABR	10071 ABR																																																																																																																																	
60x16		10170 CBR																																																																																																																																				
75x20		10140 CBR	10145 ABR	10144 ABR	10141 ABR																																																																																																																																	

CBR - Completo Blanco; FBR - Completo Adhesivo Blanco; HBR - Completo Blanco Libre de Halógeno; ABR - Accesorio Blanco; GBR - Accesorio Blanco Libre de Halógeno.

 LIBRE DE HALÓGENO  PVC

PARA INSTALACIONES ELÉCTRICAS Y DE TELECOMUNICACIONES









								
Ángulo Exterior Variable	Ángulo Interior Variable	Ángulo Plano Variable	Caja de Derivación 80x80x20	Caja de Derivación 80x80x30	Caja de Derivación 110x110x50			
10016 ABR (No Variable)	10012 ABR (No Variable)	10013 ABR (No Variable)	10991 ABR	10998 ABR	10993 ABR			
10026 ABR (No Variable)	10022 ABR (No Variable)	10023 ABR (No Variable)						
10036 ABR	10032 ABR	10033 ABR						
10036 GBR	10032 GBR	10033 GBR						
10456 ABR	10452 ABR	10453 ABR						
10406 ABR	10402 ABR	10403 ABR						
10406 GBR	10402 GBR	10403 GBR						
10406 ABR	10402 ABR	10403 ABR						
10406 GBR	10402 GBR	10403 GBR						
10046 ABR	10042 ABR	10043 ABR						
10046 GBR	10042 GBR	10043 GBR						
10056 ABR	10052 ABR	10053 ABR						
10056 GBR	10052 GBR	10053 GBR						
10056 ABR	10052 ABR	10053 ABR						
10066 ABR	10062 ABR	10063 ABR						
10066 GBR	10062 GBR	10063 GBR						
10066 ABR	10062 ABR	10063 ABR						
10486 ABR	10482 ABR	10483 ABR						
10506 ABR	10502 ABR	10503 ABR						
10506 GBR	10502 GBR	10503 GBR						
10506 ABR	10502 ABR	10503 ABR						
10076 ABR	10072 ABR	10073 ABR						
10146 ABR	10142 ABR	10143 ABR				—	—	

ABR - Accesorio Blanco; GBR - Accesorio Blanco Libre de Halógeno.

 LIBRE DE HALÓGENO
 PVC

NUEVO

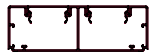

ACCESORIOS PARA MONTAJE DE CANALES

TAPA L45 - CLIPAJE DIRECTO								
AN x AL (mm)	Perfil	Ref.	Tope	Junta	Ángulo Exterior Variable	Ángulo Interior Variable	Ángulo Plano Variable	Derivación
100x50 (1 Tapa)		11020 CBR	11025 ABR	11024 ABR	11026 ABR	11022 ABR	11023 ABR	11021 ABR
155x50 (2 Tampas)		11030 CBR	11035 ABR	11034 ABR	11036 ABR	11032 ABR	11033 ABR	11031 ABR
195x50 (2 Tampas)		11040 CBR	11045 ABR	11044 ABR	11046 ABR	11042 ABR	11043 ABR	11041 ABR

CBR - Completo Blanco; ABR - Accesorio Blanco.

 PVC



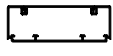
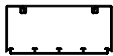
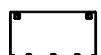
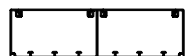

ACCESORIOS PARA MONTAJE DE CANALES

TAPA L75 - UNIVERSAL					
AN x AL (mm)	Perfil	Ref.	Tope	Junta	Ángulo Exterior Variable
110x34		10080 RBR	10085 RBR	10084 RBR	10086 RBR
		10080 HBR	10085 GBR	10084 GBR	10086 GBR
110x50		10090 RBR	10095 RBR	10094 RBR	10096 RBR
		10090 HBR	10085 GBR	10094 GBR	10086 GBR
90x50		10180 RBR	10185 RBR	10184 RBR	10186 RBR
		10180 HBR	10085 GBR	10184 GBR	10086 GBR
180x50		10290 RBR	10295 RBR	10294 RBR	10296 RBR
		10290 HBR	10295 GBR	10294 GBR	10296 GBR







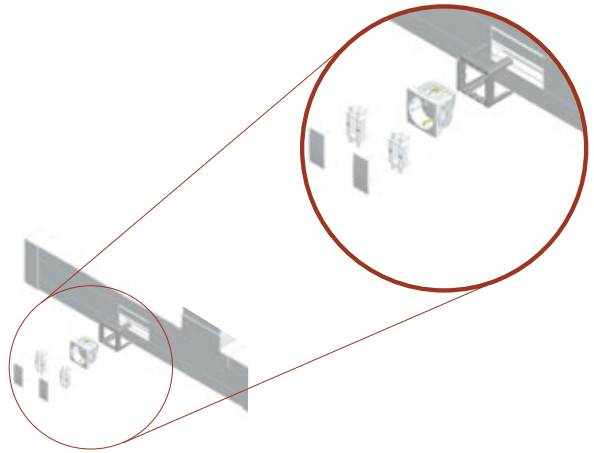

RBR - Canal o Accesorio Blanco; HBR - Completo Blanco Libre de Halógeno; GBR - Accesorio Blanco Libre de Halógeno; ABR - Accesorio Blanco.

 LIBRE DE HALÓGENO PVC

PARA INSTALACIONES ELÉCTRICAS Y DE TELECOMUNICACIONES

			
Derivación con Reducción	División H34	Clip Tapa-Mecanismo	Posicionador 90° para Canal Clipaje Directo
11028 ABR	10089 R	11991 A	11990 A
11038 ABR			
11048 ABR			



								
Ángulo Interior Variable	Ángulo Plano Variable	Derivación	Derivación con Reducción para Canal 110x50	Derivación con Reducción	División H34	División H50	Clip para Soporte de Cables	
10082 RBR	10083 RBR	10081 RBR	-	10088 ABR	10089 R	-	10987 ABR	
10082 GBR	10083 GBR	10081 GBR		10088 GBR	10089 G		10987 GBR	
10092 RBR	10093 RBR	10091 RBR		10098 ABR	-	10099 R	10987 ABR	
10092 GBR	10093 GBR	10091 GBR		10098 GBR		10099 G	10987 GBR	
10182 RBR	10183 RBR	10181 RBR		-		-	10099 R	10987 ABR
10182 GBR	10183 GBR	10181 GBR			10099 G		10987 GBR	
10292 RBR	10293 RBR	10291 RBR		10298 RBR	-	-	10099 R	10987 ABR
10292 GBR	10293 GBR	10291 GBR		10298 GBR			10099 G	10987 GBR

RBR - Canal o Accesorio Blanco; HBR - Completo Blanco Libre de Halógeno; GBR - Accesorio Blanco Libre de Halógeno; ABR - Accesorio Blanco.

 LIBRE DE HALÓGENO  PVC

EFAPEL®











Siza

—



PARA INSTALACIONES ELÉCTRICAS Y DE TELECOMUNICACIONES









ACCESORIOS PARA MONTAJE DE CANALES

ZÓCALO										
AL x AN (mm)	Perfil	Ref.	Tope Izquierdo	Tope Derecho	Junta	Ángulo Exterior Variable	Ángulo Interior Variable	Derivación para 60x16	Adaptador Lateral	Clip para Soporte de Cables
110x20		10100 CBR	10105 ABR	10108 ABR	10104 ABR	10106 ABR	10102 ABR	10101 ABR	10107 ABR	10109 ABR

CBR - Completo Blanco; ABR - Accesorio Blanco.

 PVC

ACCESORIOS PARA MONTAJE DE CANALES

SUELO								
AN x AL (mm)	Perfil	Ref.	Tope / Adaptador	Junta	Ángulo Plano	Adaptador Canal de Suelo 50x12 a Canal 40x12,5	Adaptador Canal de Suelo 75x17 a Canal 60x16	Caja de Derivación
50x12		10110 CCZ	10115 ACZ	10114 ACZ	10113 ACZ	10117 ACZ	—	10999 ACZ
75x17		10120 CCZ	10125 ACZ	10124 ACZ	10123 ACZ	—	10127 ACZ	

CCZ - Completo Gris; ACZ - Accesorio Gris.







 PVC

PARA INSTALACIONES ELÉCTRICAS Y DE TELECOMUNICACIONES

MOLDURAS • ZÓCALO • SUELO

	Serie	Descripción	Ref.	Color
	QUADRA	Caja de Superficie Modular	45996 A	BR AL BM PM
		Tapa para Caja de Superficie Modular	45997 A	BR AL BM PM
	LATINA	Caja de Superficie para 2 Módulos	42985 A	BR AL BM PM
		Caja de Superficie para 3 Módulos	41986 A	BR AL BM PM
		Caja de Superficie para 3+3 Módulos	41987 A	BR AL BM PM
		Caja de Superficie para 4 Módulos	41988 A	BR AL BM PM
		Caja de Superficie para 6 Módulos	41989 A	BR AL BM PM
	LOGUS^{SD}	Caja de Superficie	10976 A	BR MF GE PE AL IS PM DU
		Doble Caja de Superficie	10994 A	BR MF GE PE AL IS PM DU
		Triple Caja de Superficie	10995 A	BR MF GE PE AL IS PM DU
	APOLO 5000	Caja de Superficie	10981 A	BR MF
	sirius70	Caja de Superficie	10975 A	BR MF
		Caja de Superficie para Mecanismos Tipo Italiano	10972 A	BR

TAPA L75 - UNIVERSAL



	Sistema	Descripción	Ref.	Color
	MEC Q45	Adaptador Q45 Tapas 75 - 2 Módulos	10986 A	BR
		Adaptador Q45 Tapas L75 - 4 Módulos	10952 A	BR
		Adaptador Q45 Tapas L75 - 6 Módulos	10954 A	BR
	mec 21	Caja de Empotrar	10984 G	BR
			10984 A	
		Caja Semi Empotrable	10985 G	BR
		10985 A		
		Caja de Empotrar para Mecanismos Tipo Italiano	10971 A	BR

A - Accesorio; G - Accesorio Libre de Halógeno. | BR - Blanco; BM - Blanco Mate; MF - Marfil; GE - Hielo; PE - Perla; AL - Aluminio; IS - Gris; PM - Negro Mate; DU - Dorado.

 LIBRE DE HALÓGENO  PVC

PARA INSTALACIONES ELÉCTRICAS Y DE TELECOMUNICACIONES

TAPA L75 - UNIVERSAL

	Sistema	Descripción	Ref.	Color
	MEC Q45	Adaptador Modular Q45 Tapas L75 - 2 Módulos	10950 A	BR
		Tapa para Adaptador Modular Q45 Tapas L75 - 2 Módulos	10959 A	BR



MONTAJE SIMPLE

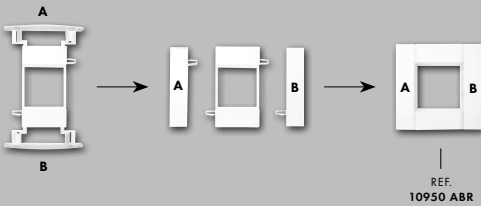

REF. 10950 ABR

ADAPTADOR MODULAR Q45 PARA CANALES
CON TAPAS L75

2 MÓDULOS

MONTAJE MÚLTIPLE

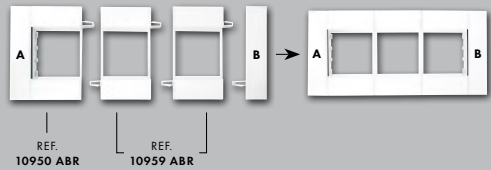

REF. 10959 ABR





















TAPA PARA ADAPTADOR MODULAR Q45 PARA CANALES
CON TAPAS L75

2 MÓDULOS + REF. 10950 ABR

A - Accesorio; G - Accesorio Libre de Halógeno. | BR - Blanco.



















 LIBRE DE HALÓGENO
  PVC

ACCESORIOS PARA MONTAJE DE CANALES

PROTECCIÓN DE CABLES Y TUBOS									
Altura (mm)	AN x AL (mm)	Perfil	Ref.	Tope	Junta	Ángulo Exterior Variable	Ángulo Interior Variable	Ángulo Plano	Derivación
10	10x10		13100 CBR	13105 ABR	13104 ABR	13106 ABR	13102 ABR	13103 ABR	13101 ABR
			13100 FBR						
15	15x15		13110 CBR	13115 ABR	13114 ABR	13116 ABR	13112 ABR	13113 ABR	13111 ABR
			13110 FBR						
20	20x20		13120 CBR	13125 ABR	13124 ABR	13126 ABR	13122 ABR	13123 ABR	13121 ABR
			13120 FBR						
25	25x25		13140 CBR	13145 ABR	13144 ABR	13146 ABR	13142 ABR	13143 ABR	13141 ABR
			13140 FBR						
30	25x30		13010 CBR	13015 ABR	13014 ABR	13016 ABR	13012 ABR	13013 ABR	13011 ABR
	30x30		13150 CBR	13155 ABR	13154 ABR	13156 ABR	13152 ABR	13153 ABR	13151 ABR
	13150 FBR								
40	40x40		13020 CBR	13025 ABR	13024 ABR	13026 ABR	13022 ABR	13023 ABR	13021 ABR
	60x40		13030 CBR	13035 ABR	13034 ABR	13036 ABR	13032 ABR	13033 ABR	13031 ABR
	60x40								
	80x40		13050 CBR	13055 ABR	13054 ABR	13056 ABR	13052 ABR	13053 ABR	13051 ABR
	100x40		13070 CBR	13075 ABR	13074 ABR	13076 ABR	13072 ABR	13073 ABR	13071 ABR
60x60		13040 CBR	13045 ABR	13044 ABR	13046 ABR	13042 ABR	13043 ABR	13041 ABR	
60	80x60		13060 CBR	13065 ABR	13064 ABR	13066 ABR	13062 ABR	13063 ABR	13061 ABR
	100x60		13080 CBR	13085 ABR	13084 ABR	13086 ABR	13082 ABR	13083 ABR	13081 ABR

CBR - Completo Blanco; FBR - Completo Adhesivo Blanco; ABR - Accesorio Blanco.

 PVC

CUADROS ELÉCTRICOS			
Altura (mm)	AN x AL (mm)	Perfil	Ref.
30	25x30		14010 CCZ
			14010 HCZ
40	25x40		14100 CCZ
			14100 HCZ
	40x40		14020 CCZ
			14020 HCZ
	60x40		14030 CCZ
			14030 HCZ
80x40		14050 CCZ	
		14050 HCZ	
100x40		14070 CCZ	
60	25x60		14090 CCZ
			14090 HCZ
	40x60		14110 CCZ
			14110 HCZ
	60x60		14040 CCZ
			14040 HCZ
80x60		14060 CCZ	
		14060 HCZ	
100x60		14080 CCZ	
80	40x80		14120 CCZ
			14120 HCZ
	60x80		14130 CCZ
			14130 HCZ
	80x80		14140 CCZ
14140 HCZ			
100x80		14150 CCZ	
100	60x100		14160 CCZ
			14160 HCZ
	80x100		14170 CCZ
			14170 HCZ
	100x100		14180 CCZ
			14180 HCZ

CCZ - Completo Gris; HCZ - Completo Gris Libre de Halógeno.

 LIBRE DE HALÓGENO  PVC

DVI - DATOS, VOZ E IMAGEN

CONECTORES Y ADAPTADORES

130

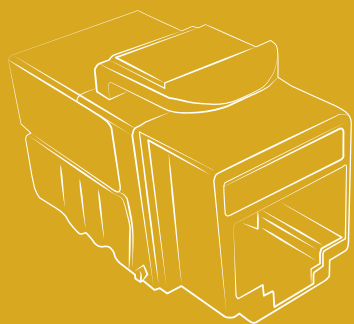

08

DVI

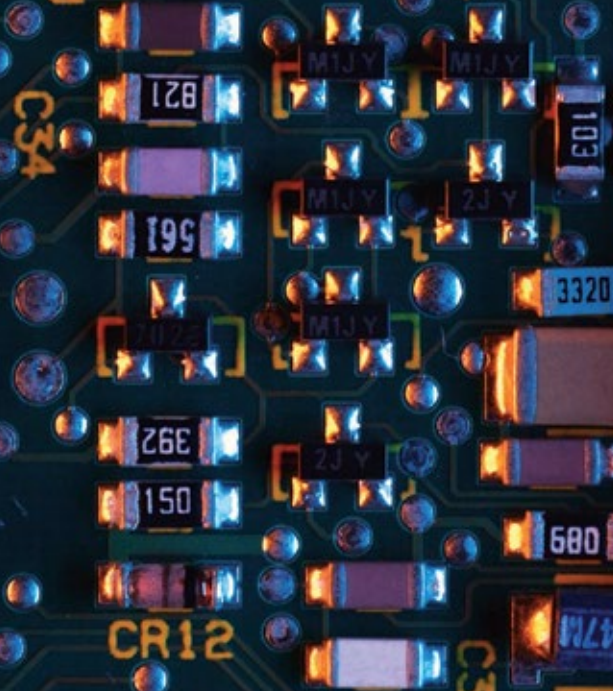
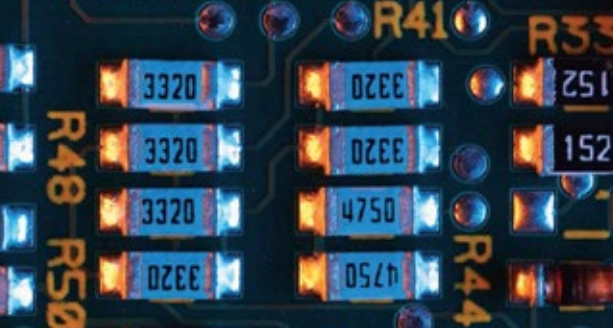
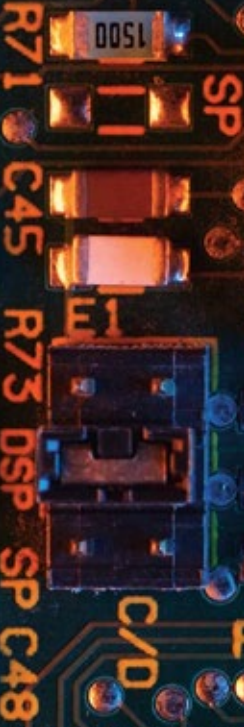













DVI





CONECTORES	132
ADAPTADORES PARA CONECTORES DE FIBRA ÓPTICA	132
DISPOSITIVOS DE CONEXIÓN, DISTRIBUCIÓN Y ACCESORIOS	132
LATIGUILLOS	133
HERRAMIENTAS	133

CONNER
61106-001
GC27E
Δ9013 ACUMOS







CONECTORES

			Ref.	Color
	Conector Hembra RJ45 Cat. 6A UTP (500 MHz)		82021	-
	Conector Hembra RJ45 Cat. 6 UTP (250 MHz)		21978	-
	Conector Hembra RJ45 Cat. 6 UTP - Montaje Rack (250 MHz)		82020	-
	Conector Hembra RJ45 Cat. 6 STP (250 MHz)		21988	-
	Conector Hembra RJ45 Cat. 5e UTP (100 MHz)		21975	-
	Conector Hembra RJ45 Cat. 5e STP (100 MHz)		21985	-
	Doble Conector Hembra RJ45 Cat. 5e UTP (1 entrada / 2 salidas)		21980	-
	Conector Hembra RJ11 Cat. 3		21972	-
	Conector Cable Coaxial Tipo F		21979	-
	Conector IEC Macho Tipo F		82606	-
	Conector IEC Hembra Tipo F		82607	-

ADAPTADORES PARA CONECTORES DE FIBRA ÓPTICA

	Adaptador para Conectores de Fibra Óptica SC APC Duplex		82211	-
	Adaptador para Conectores de Fibra Óptica SC APC Simplex		82210	-
	Adaptador para Conectores de Fibra Óptica LC Duplex		82213	-
	Tapa de Protección para Adaptador de Fibra Óptica SC APC Simplex		82970	-
	Tapa de Protección para Adaptador de Fibra Óptica SC APC Duplex		82971	-

DISPOSITIVOS DE CONEXIÓN, DISTRIBUCIÓN Y ACCESORIOS





	Conector Macho RJ45 UTP 8 Contactos (sin blindaje)		82028	-
	Conector Macho RJ45 FTP 8 Contactos (sin blindaje)		82029	-
	Conector Macho RJ - 4 Posiciones con 4 Contactos		82024	-
	Conector Macho RJ - 6 Posiciones con 4 Contactos		82025	-
	Conector Macho RJ - 6 Posiciones con 6 Contactos		82026	-
	Conector Macho Tipo F		82601	-
	Conector Macho Tipo F 90°		82602	-

 - Power over Ethernet



DISPOSITIVOS DE CONEXIÓN, DISTRIBUCIÓN Y ACCESORIOS

		Ref.	Color
	Conector Macho Tipo F 90° de Compresión	82605	-
	Conector Macho - Hembra Tipo F 90°	82603	-
	Conector TV Macho + Hembra	82611	-
	Regleta de Corte (DDS) - 10 Pares Cat. 3.	82511	-
	Regleta de Corte Prueba (DDE) - 10 Pares Cat. 3.	82512	-
	Terminación 75 Ohm Macho - Hembra Tipo F	82681	-
	Repartidor de TV Coaxial Terminal 8 Salidas Tipo F, 5 MHz - 2,4 GHz, 8 dB, Paso DC.	82691	-
	Repartidor de TV Coaxial Terminal 4 Salidas Tipo F, 5 MHz - 2,4 GHz, 8 dB, Paso DC.	82692	-
	Repartidor de TV Coaxial 2x6 Salidas Tipo F, 5 - 2400 MHz, Paso DC 30 V 700 mA.	60911	-
	Repartidor de TV Coaxial 2x8 Salidas Tipo F, 5 - 2400 MHz, Paso DC 30 V 700 mA.	60913	-
	Repartidor de TV Coaxial 2x12 Salidas Tipo F, 5 - 2400 MHz, Paso DC 30 V 700 mA.	60912	-
	Conector Rápido hasta 3 Conductores	82536	-

LATIGUILLOS

	Latiguillo 2xRJ45 4P UTP Cat. 5e (0,5 m)	82621 A	
	Latiguillo 2xRJ45 4P UTP Cat. 5e (3 m)	82622 A	CZ
	Latiguillo 2xRJ45 4P UTP Cat. 5e (5 m)	82625 A	
	Latiguillo 2xRJ45 4P FTP Cat. 5e (0,5 m)	82631 A	
	Latiguillo 2xRJ45 4P FTP Cat. 5e (3 m)	82632 A	CZ
	Latiguillo 2xRJ45 4P FTP Cat. 5e (5 m)	82635 A	
	Latiguillo 2xRJ45 4P UTP Cat. 6 (0,5 m)	82641 A	
	Latiguillo 2xRJ45 4P UTP Cat. 6 (3 m)	82642 A	CZ
	Latiguillo 2xRJ45 4P UTP Cat. 6 (5 m)	82645 A	
	Latiguillo 2xRJ45 4P FTP Cat. 6 (0,5 m)	82651 A	
	Latiguillo 2xRJ45 4P FTP Cat. 6 (3 m)	82652 A	CZ
	Latiguillo 2xRJ45 4P FTP Cat. 6 (5 m)	82655 A	

HERRAMIENTAS

	Alicate para Crimpar RJ 6x4, 6x6 o 8x8	82581	-
	Herramienta de Inserción (con o sin Corte)	82561	-

A - Accesorio. CZ - Gris.

CUADROS ELÉCTRICOS Y DE TELECOMUNICACIONES

OMEGA	138
BETA	145
GAMA	151

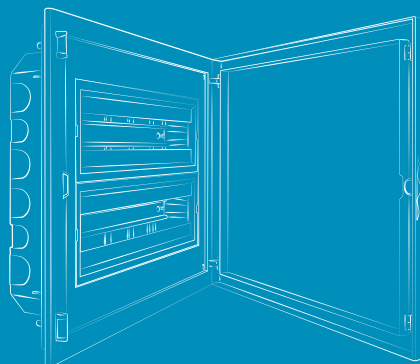
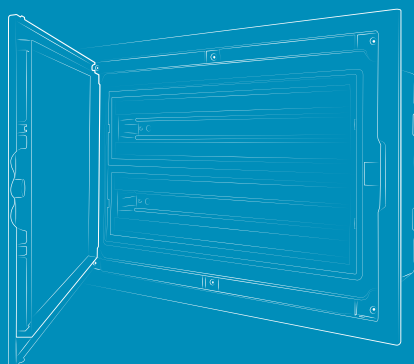

09



CUADROS ELÉCTRICOS Y DE TELECOMUNICACIONES

OMEGA - BAJO PERFIL

- CUADROS ELÉCTRICOS DE DISTRIBUCIÓN 138
- CUADROS DE TELECOMUNICACIONES (RTR Y CRTR) 142
- ACCESORIOS 144

BETA - BAJA PROFUNDIDAD

- CUADROS ELÉCTRICOS DE DISTRIBUCIÓN 145
- CUADROS DE TELECOMUNICACIONES (ICT) 149
- ACCESORIOS 150

GAMMA - STANDARD

- CUADROS ELÉCTRICOS DE DISTRIBUCIÓN 151
- CUADROS ELÉCTRICOS DE ABONADO PARA DCP 155
- CUADROS DE TELECOMUNICACIONES (RTR Y CRTR) 157
- ACCESORIOS 159

CUADROS ELÉCTRICOS DE DISTRIBUCIÓN - COMPLETOS

Ref. Mód. Filas

4 MÓDULOS (1x4)



Cuadro de Distribución de Empotrar de Bajo Perfil Completo

Dimensiones exteriores (mm): 217 x 275 x 124.

Caja resistente a 850 °C adecuada a instalación en mampostería o paredes huecas.

62004 1AB 4 1

8 MÓDULOS (1x8)



Cuadro de Distribución de Empotrar de Bajo Perfil Completo

Dimensiones exteriores (mm): 289 x 275 x 124.

Caja resistente a 850 °C adecuada a instalación en mampostería o paredes huecas.

62008 1AB 8 1

12 MÓDULOS (1x12)



Cuadro de Distribución de Empotrar de Bajo Perfil Completo

Dimensiones exteriores (mm): 361 x 275 x 124.

Caja resistente a 850 °C adecuada a instalación en mampostería o paredes huecas.

62012 1AB 12 1

16 MÓDULOS (2x8)



Cuadro de Distribución de Empotrar de Bajo Perfil Completo

Dimensiones exteriores (mm): 289 x 400 x 124.

Caja resistente a 850 °C adecuada a instalación en mampostería o paredes huecas.

62016 2AB 16 2

24 MÓDULOS (2x12)



Cuadro de Distribución de Empotrar de Bajo Perfil Completo

Dimensiones exteriores (mm): 361 x 400 x 124.

Caja resistente a 850 °C adecuada a instalación en mampostería o paredes huecas.

62024 2AB 24 2

Dimensiones exteriores (mm): **AN** - Ancho x **AL** - Altura x **P** - Profundidad.

CUADROS ELÉCTRICOS DE DISTRIBUCIÓN - COMPLETOS

Ref. Mód. Filas

32 MÓDULOS (2x16)



Cuadro de Distribución de Empotrar de Bajo Perfil Completo

Dimensiones exteriores (mm): 433 x 400 x 124.

Caja resistente a 850 °C adecuada a instalación en mampostería o paredes huecas.

62032 2AB 32 2

40 MÓDULOS (2x20)



Cuadro de Distribución de Empotrar de Bajo Perfil Completo

Dimensiones exteriores (mm): 505 x 400 x 124.

Caja resistente a 850 °C adecuada a instalación en mampostería o paredes huecas.

62040 2AB 40 2

48 MÓDULOS (2x24)



Cuadro de Distribución de Empotrar de Bajo Perfil Completo

Dimensiones exteriores (mm): 577 x 400 x 124.

Caja resistente a 850 °C adecuada a instalación en mampostería o paredes huecas.

62048 2AB 48 2

60 MÓDULOS (3x20)



Cuadro de Distribución de Empotrar de Bajo Perfil Completo

Dimensiones exteriores (mm): 505 x 525 x 124.

Caja resistente a 850 °C adecuada a instalación en mampostería o paredes huecas.

62060 3AB 60 3

80 MÓDULOS (4x20)



Cuadro de Distribución de Empotrar de Bajo Perfil Completo

Dimensiones exteriores (mm): 505 x 650 x 124.

Caja resistente a 850 °C adecuada a instalación en mampostería o paredes huecas.

62080 4AB 80 4

Dimensiones exteriores (mm): **AN** - Ancho x **AL** - Altura x **P** - Profundidad.

CUADROS ELÉCTRICOS DE DISTRIBUCIÓN - SEMI-MONTADOS

Ref.

Ref.

4 MÓDULOS (1x4)



Interior y Puerta para Cuadro Distribución de Bajo Perfil
Dimensiones exteriores (mm): 217 x 275 x 11.

62004 1JB



Caja de Empotrar para Cuadro

Dimensiones exteriores (mm): 192 x 255 x 113.
Caja resistente a 850 °C adecuada a instalación en mampostería o paredes huecas.

60004 1GB

8 MÓDULOS (1x8)



Interior y Puerta para Cuadro Distribución de Bajo Perfil
Dimensiones exteriores (mm): 289 x 275 x 11.

62008 1JB



Caja de Empotrar para Cuadro

Dimensiones exteriores (mm): 264 x 255 x 113.
Caja resistente a 850 °C adecuada a instalación en mampostería o paredes huecas.

60008 1GB

12 MÓDULOS (1x12)



Interior y Puerta para Cuadro Distribución de Bajo Perfil
Dimensiones exteriores (mm): 361 x 275 x 11.

62012 1JB



Caja de Empotrar para Cuadro

Dimensiones exteriores (mm): 336 x 255 x 113.
Caja resistente a 850 °C adecuada a instalación en mampostería o paredes huecas.

60012 1GB

16 MÓDULOS (2x8)



Interior y Puerta para Cuadro Distribución de Bajo Perfil
Dimensiones exteriores (mm): 289 x 400 x 11.

62016 2JB



Caja de Empotrar para Cuadro

Dimensiones exteriores (mm): 264 x 380 x 113.
Caja resistente a 850 °C adecuada a instalación en mampostería o paredes huecas.

60016 2GB

24 MÓDULOS (2x12)



Interior y Puerta para Cuadro Distribución de Bajo Perfil
Dimensiones exteriores (mm): 361 x 400 x 11.

62024 2JB



Caja de Empotrar para Cuadro

Dimensiones exteriores (mm): 336 x 380 x 113.
Caja resistente a 850 °C adecuada a instalación en mampostería o paredes huecas.

60024 2GB

Dimensiones exteriores (mm): **AN** - Ancho x **AL** - Altura x **P** - Profundidad.

CUADROS ELÉCTRICOS DE DISTRIBUCIÓN - SEMI-MONTADOS

Ref.

Ref.

32 MÓDULOS (2x16)



Interior y Puerta para Cuadro Distribución de Bajo Perfil
Dimensiones exteriores (mm): 433 x 400 x 11.

62032 2JB



Caja de Empotrar para Cuadro

Dimensiones exteriores (mm): 408 x 380 x 113.
Caja resistente a 850 °C adecuada a instalación en mampostería o paredes huecas.

60032 2GB

40 MÓDULOS (2x20)



Interior y Puerta para Cuadro Distribución de Bajo Perfil
Dimensiones exteriores (mm): 505 x 400 x 11.

62040 2JB



Caja de Empotrar para Cuadro

Dimensiones exteriores (mm): 480 x 380 x 113.
Caja resistente a 850 °C adecuada a instalación en mampostería o paredes huecas.

60040 2GB

48 MÓDULOS (2x24)



Interior y Puerta para Cuadro Distribución de Bajo Perfil
Dimensiones exteriores (mm): 577 x 400 x 11.

62048 2JB



Caja de Empotrar para Cuadro

Dimensiones exteriores (mm): 552 x 380 x 113.
Caja resistente a 850 °C adecuada a instalación en mampostería o paredes huecas.

60048 2GB

60 MÓDULOS (3x20)



Interior y Puerta para Cuadro Distribución de Bajo Perfil
Dimensiones exteriores (mm): 505 x 525 x 11.

62060 3JB



Caja de Empotrar para Cuadro

Dimensiones exteriores (mm): 480 x 505 x 113.
Caja resistente a 850 °C adecuada a instalación en mampostería o paredes huecas.

60060 3GB

80 MÓDULOS (4x20)



Interior y Puerta para Cuadro Distribución de Bajo Perfil
Dimensiones exteriores (mm): 505 x 650 x 11.

62080 4JB



Caja de Empotrar para Cuadro

Dimensiones exteriores (mm): 480 x 630 x 113.
Caja resistente a 850 °C adecuada a instalación en mampostería o paredes huecas.

60080 4GB

Dimensiones exteriores (mm): **AN** - Ancho x **AL** - Altura x **P** - Profundidad.

CUADROS DE TELECOMUNICACIONES - RTR - COMPLETOS

Ref.

6 SALIDAS DE CABLE COAXIAL (CC) Y HASTA 12 SALIDAS DE PARES DE COBRE (PC)



Cuadro de Comunicaciones de Bajo Perfil Completo

Dimensiones exteriores (mm): 577 x 400 x 124;

Caja resistente a 850 °C adecuada a instalación en mampostería o paredes huecas;

Accesorios: - Repartidor PC con Conectores Cat. 6 UTP (1 Entrada y 6 Salidas, expansible hasta 12 Salidas);

- Repartidor Doble Coaxial (2 entradas y 2 x 6 Salidas);
- Repartidor FO con Adaptador de Fibra Óptica SC/APC Simplex;
- Toma Schuko (Ref. 45132 SBR).

62048 2PB

8 SALIDAS DE CABLE COAXIAL (CC) Y HASTA 24 SALIDAS DE PARES DE COBRE (PC)



Cuadro de Comunicaciones de Bajo Perfil Completo

Dimensiones exteriores (mm): 505 x 525 x 124;

Caja resistente a 850 °C adecuada a instalación en mampostería o paredes huecas;

Accesorios: - Repartidor PC con Conectores Cat. 6 UTP (1 entrada y 8 Salidas, expansible hasta 24 Salidas);

- Repartidor Doble Coaxial (2 entradas y 2 x 8 Salidas);
- Repartidor FO con Adaptador de Fibra Óptica SC/APC Simplex;
- Toma Schuko (Ref. 45132 SBR).

62060 3SB

12 SALIDAS DE CABLE COAXIAL (CC) Y HASTA 24 SALIDAS DE PARES DE COBRE (PC)



Cuadro de Comunicaciones de Bajo Perfil Completo

Dimensiones exteriores (mm): 505 x 525 x 124;

Caja resistente a 850 °C adecuada a instalación en mampostería o paredes huecas;

Accesorios: - Repartidor PC con Conectores Cat. 6 UTP (1 entrada y 12 Salidas, expansible hasta 24 Salidas);

- Repartidor Doble Coaxial (2 entradas y 2 x 12 Salidas);
- Repartidor FO con Adaptador de Fibra Óptica SC/APC Simplex;
- Toma Schuko (Ref. 45132 SBR).

62060 3PB

CUADROS DE TELECOMUNICACIONES - CRTR - COMPLETOS

CRTR PARA 6 SALIDAS DE CABLE COAXIAL (CC) Y HASTA 12 SALIDAS DE PARES DE COBRE (PC)



Caja de Comunicaciones Auxiliar de Bajo Perfil Completa (CRTR)

Dimensiones exteriores (mm): 577 x 400 x 124.

Caja resistente a 850 °C adecuada a instalación en mampostería o paredes huecas.

62048 2UB

CRTR PARA 12 SALIDAS DE CABLE COAXIAL (CC) Y HASTA 24 SALIDAS DE PARES DE COBRE (PC)



Caja de Comunicaciones Auxiliar de Bajo Perfil Completa (CRTR)

Dimensiones exteriores (mm): 505 x 525 x 124.

Caja resistente a 850 °C adecuada a instalación en mampostería o paredes huecas.

62060 3UB

CC - Salidas de Cable Coaxial; PC - Salidas de Pares de Cobre; RTR - Registro de Terminación Red; CRTR - Caja Auxiliar para RTR.
Dimensiones exteriores (mm): AN - Ancho x AL - Altura x P - Profundidad.

CUADROS DE TELECOMUNICACIONES - RTR - SEMI-MONTADOS

Ref.

Ref.

6 SALIDAS DE CABLE COAXIAL (CC) Y HASTA 12 SALIDAS DE PARES DE COBRE (PC)



Interior y Puerta para RTR de Bajo Perfil

Dimensiones exteriores (mm): 577 x 400 x 11.

Accesorios:

- Repartidor PC con Conectores Cat. 6 UTP
- (1 entrada y 6 Salidas, expansible hasta 12 Salidas);
- Repartidor Doble Coaxial (2 entradas y 2 x 6 Salidas);
- Repartidor FO con Adaptador de Fibra Óptica SC/APC Simplex;
- Toma Schuko (Ref. 45132 SBR).

62048 2LB



Caja de Empotrar para Cuadro

Dimensiones exteriores (mm): 552 x 380 x 113.

Caja resistente a 850 °C adecuada a instalación en mampostería o paredes huecas.

60048 2GB

8 SALIDAS DE CABLE COAXIAL (CC) Y HASTA 24 SALIDAS DE PARES DE COBRE (PC)



Interior y Puerta para RTR de Bajo Perfil

Dimensiones exteriores (mm): 505 x 525 x 11.

Accesorios:

- Repartidor PC con Conectores Cat. 6 UTP
- (1 entrada y 8 Salidas, expansible hasta 24 Salidas);
- Repartidor Doble Coaxial (2 entradas y 2 x 8 Salidas);
- Repartidor FO con Adaptador de Fibra Óptica SC/APC Simplex;
- Toma Schuko (Ref. 45132 SBR).

62060 3NB



Caja de Empotrar para Cuadro

Dimensiones exteriores (mm): 480 x 505 x 113.

Caja resistente a 850 °C adecuada a instalación en mampostería o paredes huecas.

60060 3GB

12 SALIDAS DE CABLE COAXIAL (CC) Y HASTA 24 SALIDAS DE PARES DE COBRE (PC)



Interior y Puerta para RTR de Bajo Perfil

Dimensiones exteriores (mm): 505 x 525 x 11.

Accesorios:

- Repartidor PC con Conectores Cat. 6 UTP
- (1 entrada y 12 Salidas, expansible hasta 24 Salidas);
- Repartidor Doble Coaxial (2 entradas y 2 x 12 Salidas);
- Repartidor FO con Adaptador de Fibra Óptica SC/APC Simplex;
- Toma Schuko (Ref. 45132 SBR).

62060 3MB



Caja de Empotrar para Cuadro

Dimensiones exteriores (mm): 552 x 380 x 113.

Caja resistente a 850 °C adecuada a instalación en mampostería o paredes huecas.

60060 3GB

CUADROS DE TELECOMUNICACIONES - CRTR - SEMI-MONTADOS

CRTR PARA ATI DE 6 SALIDAS DE CABLE COAXIAL (CC) Y HASTA 12 SALIDAS DE PARES DE COBRE (PC)



Puerta para Caja de Comunicaciones de Bajo Perfil (CRTR)

Dimensiones exteriores (mm): 577 x 400 x 11.

62048 2QB



Caja de Empotrar para Cuadro

Dimensiones exteriores (mm): 552 x 380 x 113.

Caja resistente a 850 °C adecuada a instalación en mampostería o paredes huecas.

60048 2GB

CRTR PARA ATI DE 12 SALIDAS DE CABLE COAXIAL (CC) Y HASTA 24 SALIDAS DE PARES DE COBRE (PC)



Puerta para Caja de Comunicaciones de Bajo Perfil (CRTR)

Dimensiones exteriores (mm): 505 x 525 x 11.

62060 3RB



Caja de Empotrar para Cuadro



























Dimensiones exteriores (mm): 480 x 505 x 113.

Caja resistente a 850 °C adecuada a instalación en mampostería o paredes huecas.

60060 3GB

CC - Salidas de Cable Coaxial; PC - Salidas de Pares de Cobre; RTR - Registro de Terminación Red; CRTR - Caja Auxiliar para RTR.
Dimensiones exteriores (mm): AN - Ancho x AL - Altura x P - Profundidad.

ACCESORIOS

			Ref.
	Cerradura con Llave para Cuadro Eléctrico de Bajo Perfil		62900
	Cierre para Cuadro Eléctrico de Bajo Perfil		62910
	KIT de Fijación para Cajas de Empotrar para Paredes Huecas		60914
	Regleta de Conexión 9 Conexiones Fase		60901
	Regleta de Conexión 9 Conexiones Neutro		60902
	Regleta de Conexión 9 Conexiones Tierra		60903
	Regleta de Conexión 20 Conexiones Neutro		60904
	Regleta de Conexión 20 Conexiones Tierra		60905
	Repartidor de TV Coaxial 2x6 Salidas <small>Tipo F, 5 - 2400 MHz, Paso DC Máx. 30 V 700 mA.</small>		60911
	Repartidor de TV Coaxial 2x8 Salidas <small>Tipo F, 5 - 2400 MHz, Paso DC Máx. 30 V 700 mA.</small>		60913
	Repartidor de TV Coaxial 2x12 Salidas <small>Tipo F, 5 - 2400 MHz, Paso DC Máx. 30 V 700 mA.</small>		60912
	Máscara Tapa-módulos <small>10 módulos.</small>		60906
	Caja Terminal Fibra Óptica		60907

 CUADROS ELÉCTRICOS DE **DISTRIBUCIÓN**  CUADROS DE **TELECOMUNICACIONES**

CUADROS ELÉCTRICOS DE DISTRIBUCIÓN - COMPLETOS

Ref. Mód. Filas

4 MÓDULOS (1x4)



Cuadro de Distribución de Empotrar de Baja Profundidad Completo

Dimensiones exteriores (mm): 217 x 275 x 110.

Caja resistente a 850 °C adecuada a instalación en mampostería o paredes huecas.

61004 1AB 4 1

8 MÓDULOS (1x8)



Cuadro de Distribución de Empotrar de Baja Profundidad Completo

Dimensiones exteriores (mm): 289 x 275 x 110.

Caja resistente a 850 °C adecuada a instalación en mampostería o paredes huecas.

61008 1AB 8 1

12 MÓDULOS (1x12)



Cuadro de Distribución de Empotrar de Baja Profundidad Completo

Dimensiones exteriores (mm): 361 x 275 x 110.

Caja resistente a 850 °C adecuada a instalación en mampostería o paredes huecas.

61012 1AB 12 1

16 MÓDULOS (2x8)



Cuadro de Distribución de Empotrar de Baja Profundidad Completo

Dimensiones exteriores (mm): 289 x 400 x 110.

Caja resistente a 850 °C adecuada a instalación en mampostería o paredes huecas.

61016 2AB 16 2

24 MÓDULOS (2x12)



Cuadro de Distribución de Empotrar de Baja Profundidad Completo

Dimensiones exteriores (mm): 361 x 400 x 110.

Caja resistente a 850 °C adecuada a instalación en mampostería o paredes huecas.

61024 2AB 24 2

Dimensiones exteriores (mm): AN - Ancho x AL - Altura x P - Profundidad.

CUADROS ELÉCTRICOS DE DISTRIBUCIÓN - COMPLETOS

Ref. Mód. Filas

32 MÓDULOS (2x16)



Cuadro de Distribución de Empotrar de Baja Profundidad Completo

Dimensiones exteriores (mm): 433 x 400 x 110.

Caja resistente a 850 °C adecuada a instalación en mampostería o paredes huecas.

61032 2AB 32 2

40 MÓDULOS (2x20)



Cuadro de Distribución de Empotrar de Baja Profundidad Completo

Dimensiones exteriores (mm): 505 x 400 x 110.

Caja resistente a 850 °C adecuada a instalación en mampostería o paredes huecas.

61040 2AB 40 2

48 MÓDULOS (2x24)



Cuadro de Distribución de Empotrar de Baja Profundidad Completo

Dimensiones exteriores (mm): 577 x 400 x 110.

Caja resistente a 850 °C adecuada a instalación en mampostería o paredes huecas.

61048 2AB 48 2

60 MÓDULOS (3x20)



Cuadro de Distribución de Empotrar de Baja Profundidad Completo

Dimensiones exteriores (mm): 505 x 525 x 110.

Caja resistente a 850 °C adecuada a instalación en mampostería o paredes huecas.

61060 3AB 60 3

80 MÓDULOS (4x20)



Cuadro de Distribución de Empotrar de Baja Profundidad Completo

Dimensiones exteriores (mm): 505 x 650 x 110.

Caja resistente a 850 °C adecuada a instalación en mampostería o paredes huecas.

61080 4AB 80 4

Dimensiones exteriores (mm): AN - Ancho x AL - Altura x P - Profundidad.

CUADROS ELÉCTRICOS DE DISTRIBUCIÓN - SEMI-MONTADOS

Ref.

Ref.

4 MÓDULOS (1x4)



Interior y Puerta para Cuadro de Distribución de Baja Profundidad

Dimensiones exteriores (mm): 217 x 275 x 35.

61004 1JB



Caja de Empotrar de Baja Profundidad para Cuadro

Dimensiones exteriores (mm): 192 x 255 x 75.
Caja resistente a 850 °C adecuada a instalación en mampostería o paredes huecas.

61004 1GB

8 MÓDULOS (1x8)



Interior y Puerta para Cuadro de Distribución de Baja Profundidad

Dimensiones exteriores (mm): 289 x 275 x 35.

61008 1JB



Caja de Empotrar de Baja Profundidad para Cuadro

Dimensiones exteriores (mm): 264 x 255 x 75.
Caja resistente a 850 °C adecuada a instalación en mampostería o paredes huecas.

61008 1GB

12 MÓDULOS (1x12)



Interior y Puerta para Cuadro de Distribución de Baja Profundidad

Dimensiones exteriores (mm): 361 x 275 x 35.

61012 1JB



Caja de Empotrar de Baja Profundidad para Cuadro

Dimensiones exteriores (mm): 336 x 255 x 75.
Caja resistente a 850 °C adecuada a instalación en mampostería o paredes huecas.

61012 1GB

16 MÓDULOS (2x8)



Interior y Puerta para Cuadro de Distribución de Baja Profundidad

Dimensiones exteriores (mm): 289 x 400 x 35.

61016 2JB



Caja de Empotrar de Baja Profundidad para Cuadro

Dimensiones exteriores (mm): 264 x 380 x 75.
Caja resistente a 850 °C adecuada a instalación en mampostería o paredes huecas.

61016 2GB

24 MÓDULOS (2x12)



Interior y Puerta para Cuadro de Distribución de Baja Profundidad

Dimensiones exteriores (mm): 361 x 400 x 35.

61024 2JB



Caja de Empotrar de Baja Profundidad para Cuadro

Dimensiones exteriores (mm): 336 x 380 x 75.
Caja resistente a 850 °C adecuada a instalación en mampostería o paredes huecas.

61024 2GB

Dimensiones exteriores (mm): AN - Ancho x AL - Altura x P - Profundidad.

CUADROS ELÉCTRICOS DE DISTRIBUCIÓN - SEMI-MONTADOS

Ref.

Ref.

32 MÓDULOS (2x16)



Interior y Puerta para Cuadro de Distribución de Baja Profundidad

Dimensiones exteriores (mm): 433 x 400 x 35.

61032 2JB



Caja de Empotrar de Baja Profundidad para Cuadro

Dimensiones exteriores (mm): 408 x 380 x 75.
Caja resistente a 850 °C adecuada a instalación en mampostería o paredes huecas.

61032 2GB

40 MÓDULOS (2x20)



Interior y Puerta para Cuadro de Distribución de Baja Profundidad

Dimensiones exteriores (mm): 505 x 400 x 35.

61040 2JB



Caja de Empotrar de Baja Profundidad para Cuadro

Dimensiones exteriores (mm): 480 x 380 x 75.
Caja resistente a 850 °C adecuada a instalación en mampostería o paredes huecas.

61040 2GB

48 MÓDULOS (2x24)



Interior y Puerta para Cuadro de Distribución de Baja Profundidad

Dimensiones exteriores (mm): 577 x 400 x 35.

61048 2JB



Caja de Empotrar de Baja Profundidad para Cuadro

Dimensiones exteriores (mm): 552 x 380 x 75.
Caja resistente a 850 °C adecuada a instalación en mampostería o paredes huecas.

61048 2GB

60 MÓDULOS (3x20)



Interior y Puerta para Cuadro de Distribución de Baja Profundidad

Dimensiones exteriores (mm): 505 x 525 x 35.

61060 3JB



Caja de Empotrar de Baja Profundidad para Cuadro

Dimensiones exteriores (mm): 480 x 505 x 75.
Caja resistente a 850 °C adecuada a instalación en mampostería o paredes huecas.

61060 3GB

80 MÓDULOS (4x20)



Interior y Puerta para Cuadro de Distribución de Baja Profundidad

Dimensiones exteriores (mm): 505 x 650 x 35.

61080 4JB



Caja de Empotrar de Baja Profundidad para Cuadro

Dimensiones exteriores (mm): 480 x 630 x 75.
Caja resistente a 850 °C adecuada a instalación en mampostería o paredes huecas.

61080 4GB

Dimensiones exteriores (mm): AN - Ancho x AL - Altura x P - Profundidad.

CUADROS DE TELECOMUNICACIONES

DE EMPOTRAR BAJA PROFUNDIDAD COMPLETO



Cuadro de Telecomunicaciones de Empotrar Baja Profundidad Completo
Dimensiones exteriores (mm): 572 x 801 x 110;
Caja resistente a 850 °C adecuada a instalación en mampostería o paredes huecas.

61048 2UB



Unión de Cajas dos Cuadros para Paso de Cables

60915

* El producto cumple los requisitos de la norma **ICT** de España.

ACCESORIOS

Ref.



Cerradura con llave para Cuadro Eléctrico



60900



Cierre para Cuadro Eléctrico



60910



KIT de Fijación para Cajas de Empotrar para Paredes Huecas



60914



Unión de Cajas dos Cuadros para Paso de Cables



60915



Regleta de Conexión 9 Conexiones Fase



60901



Regleta de Conexión 9 Conexiones Neutro



60902



Regleta de Conexión 9 Conexiones Tierra



60903



Regleta de Conexión 20 Conexiones Neutro



60904



Regleta de Conexión 20 Conexiones Tierra



60905



Máscara Tapa-módulos

■ 10 módulos.



60906

 CUADROS ELÉCTRICOS DE **DISTRIBUCIÓN**
 CUADROS DE **TELECOMUNICACIONES**

CUADROS ELÉCTRICOS DE DISTRIBUCIÓN - COMPLETOS

Ref. Mód. Filas

4 MÓDULOS (1x4)



Cuadro de Distribución de Empotrar Completo

Dimensiones exteriores (mm): 217 x 275 x 148.

Caja resistente a 850 °C adecuada a instalación en mampostería o paredes huecas.

60004 1AB 4 1

8 MÓDULOS (1x8)



Cuadro de Distribución de Empotrar Completo

Dimensiones exteriores (mm): 289 x 275 x 148.

Caja resistente a 850 °C adecuada a instalación en mampostería o paredes huecas.

60008 1AB 8 1

12 MÓDULOS (1x12)



Cuadro de Distribución de Empotrar Completo

Dimensiones exteriores (mm): 361 x 275 x 148.

Caja resistente a 850 °C adecuada a instalación en mampostería o paredes huecas.

60012 1AB 12 1

16 MÓDULOS (2x8)



Cuadro de Distribución de Empotrar Completo

Dimensiones exteriores (mm): 289 x 400 x 148.

Caja resistente a 850 °C adecuada a instalación en mampostería o paredes huecas.

60016 2AB 16 2

24 MÓDULOS (2x12)



Cuadro de Distribución de Empotrar Completo

Dimensiones exteriores (mm): 361 x 400 x 148.

Caja resistente a 850 °C adecuada a instalación en mampostería o paredes huecas.

60024 2AB 24 2

Dimensiones exteriores (mm): AN - Ancho x AL - Altura x P - Profundidad.

CUADROS ELÉCTRICOS DE DISTRIBUCIÓN - COMPLETOS

Ref. Mód. Filas

32 MÓDULOS (2x16)



Cuadro de Distribución de Empotrar Completo

Dimensiones exteriores (mm): 433 x 400 x 148.

Caja resistente a 850 °C adecuada a instalación en mampostería o paredes huecas.

60032 2AB 32 2

40 MÓDULOS (2x20)



Cuadro de Distribución de Empotrar Completo

Dimensiones exteriores (mm): 505 x 400 x 148.

Caja resistente a 850 °C adecuada a instalación en mampostería o paredes huecas.

60040 2AB 40 2

48 MÓDULOS (2x24)



Cuadro de Distribución de Empotrar Completo

Dimensiones exteriores (mm): 577 x 400 x 148.

Caja resistente a 850 °C adecuada a instalación en mampostería o paredes huecas.

60048 2AB 48 2

60 MÓDULOS (3x20)



Cuadro de Distribución de Empotrar Completo

Dimensiones exteriores (mm): 505 x 525 x 148.

Caja resistente a 850 °C adecuada a instalación en mampostería o paredes huecas.

60060 3AB 60 3

80 MÓDULOS (4x20)



Cuadro de Distribución de Empotrar Completo

Dimensiones exteriores (mm): 505 x 650 x 148.

Caja resistente a 850 °C adecuada a instalación en mampostería o paredes huecas.

60080 4AB 80 4

Dimensiones exteriores (mm): **AN** - Ancho x **AL** - Altura x **P** - Profundidad.

CUADROS ELÉCTRICOS DE DISTRIBUCIÓN - SEMI-MONTADOS

Ref.

Ref.

4 MÓDULOS (1x4)



Interior y Puerta para Cuadro de Distribución

Dimensiones exteriores (mm): 217 x 275 x 35.

60004 1JB



Caja de Empotrar para Cuadro

Dimensiones exteriores (mm): 192 x 255 x 113.

Caja resistente a 850 °C adecuada a instalación en mampostería o paredes huecas.

60004 1GB

8 MÓDULOS (1x8)



Interior y Puerta para Cuadro de Distribución

Dimensiones exteriores (mm): 289 x 275 x 35.

60008 1JB



Caja de Empotrar para Cuadro

Dimensiones exteriores (mm): 264 x 255 x 113.

Caja resistente a 850 °C adecuada a instalación en mampostería o paredes huecas.

60008 1GB

12 MÓDULOS (1x12)



Interior y Puerta para Cuadro de Distribución

Dimensiones exteriores (mm): 361 x 275 x 35.

60012 1JB



Caja de Empotrar para Cuadro

Dimensiones exteriores (mm): 336 x 255 x 113.

Caja resistente a 850 °C adecuada a instalación en mampostería o paredes huecas.

60012 1GB

16 MÓDULOS (2x8)



Interior y Puerta para Cuadro de Distribución

Dimensiones exteriores (mm): 289 x 400 x 35.

60016 2JB



Caja de Empotrar para Cuadro

Dimensiones exteriores (mm): 264 x 380 x 113.

Caja resistente a 850 °C adecuada a instalación en mampostería o paredes huecas.

60016 2GB

24 MÓDULOS (2x12)



Interior y Puerta para Cuadro de Distribución

Dimensiones exteriores (mm): 361 x 400 x 35.

60024 2JB



Caja de Empotrar para Cuadro

Dimensiones exteriores (mm): 336 x 380 x 113.

Caja resistente a 850 °C adecuada a instalación en mampostería o paredes huecas.

60024 2GB

Dimensiones exteriores (mm): **AN** - Ancho x **AL** - Altura x **P** - Profundidad.

CUADROS ELÉCTRICOS DE DISTRIBUCIÓN - SEMI-MONTADOS

Ref.

Ref.

32 MÓDULOS (2x16)



Interior y Puerta para Cuadro de Distribución

Dimensiones exteriores (mm): 433 x 400 x 35.

60032 2JB



Caja de Empotrar para Cuadro

Dimensiones exteriores (mm): 408 x 380 x 113.

Caja resistente a 850 °C adecuada a instalación en mampostería o paredes huecas.

60032 2GB

40 MÓDULOS (2x20)



Interior y Puerta para Cuadro de Distribución

Dimensiones exteriores (mm): 505 x 400 x 35.

60040 2JB



Caja de Empotrar para Cuadro

Dimensiones exteriores (mm): 480 x 380 x 113.

Caja resistente a 850 °C adecuada a instalación en mampostería o paredes huecas.

60040 2GB

48 MÓDULOS (2x24)



Interior y Puerta para Cuadro de Distribución

Dimensiones exteriores (mm): 577 x 400 x 35.

60048 2JB



Caja de Empotrar para Cuadro

Dimensiones exteriores (mm): 552 x 380 x 113.

Caja resistente a 850 °C adecuada a instalación en mampostería o paredes huecas.

60048 2GB

60 MÓDULOS (3x20)



Interior y Puerta para Cuadro de Distribución

Dimensiones exteriores (mm): 505 x 525 x 35.

60060 3JB



Caja de Empotrar para Cuadro

Dimensiones exteriores (mm): 480 x 505 x 113.

Caja resistente a 850 °C adecuada a instalación en mampostería o paredes huecas.

60060 3GB

80 MÓDULOS (4x20)



Interior y Puerta para Cuadro de Distribución

Dimensiones exteriores (mm): 505 x 650 x 35.

60080 4JB



Caja de Empotrar para Cuadro

Dimensiones exteriores (mm): 480 x 630 x 113.

Caja resistente a 850 °C adecuada a instalación en mampostería o paredes huecas.

60080 4GB

Dimensiones exteriores (mm): **AN** - Ancho x **AL** - Altura x **P** - Profundidad.

CUADROS ELÉCTRICOS DE ABONADO PARA DCP (*) - COMPLETOS

(NO APLICABLE CON ICP DE CARRIL DIN)

Ref. Mód. Filas

16 MÓDULOS (2x8) + DCP



Cuadro de Abonado Completo

Dimensiones exteriores (mm): 433 x 400 x 148.

Caja resistente a 850 °C adecuada a instalación en mampostería o paredes huecas.

60016 2BB 16 2

24 MÓDULOS (2x12) + DCP



Cuadro de Abonado Completo

Dimensiones exteriores (mm): 505 x 400 x 148.

Caja resistente a 850 °C adecuada a instalación en mampostería o paredes huecas.

60024 2BB 24 2

32 MÓDULOS (2x16) + DCP



Cuadro de Abonado Completo

Dimensiones exteriores (mm): 577 x 400 x 148.

Caja resistente a 850 °C adecuada a instalación en mampostería o paredes huecas.

60032 2BB 32 2

44 MÓDULOS (2x12+1x20) + DCP



Cuadro de Abonado Completo

Dimensiones exteriores (mm): 505 x 525 x 148.

Caja resistente a 850 °C adecuada a instalación en mampostería o paredes huecas.

60044 3BB 44 3

64 MÓDULOS (2x12+2x20) + DCP



Cuadro de Abonado Completo

Dimensiones exteriores (mm): 505 x 650 x 148.

Caja resistente a 850 °C adecuada a instalación en mampostería o paredes huecas.

60064 4BB 64 4

DCP - Dispositivo Controlador de Potencia; (*) no aplicable con ICP de carril DIN.
Dimensiones exteriores (mm): **AN** - Ancho x **AL** - Altura x **P** - Profundidad.

CUADROS ELÉCTRICOS DE ABONADO PARA DCP - SEMI-MONTADOS

Ref.

Ref.

16 MÓDULOS (2x8) + DCP



Interior y Puerta para Cuadro de Abonado

Dimensiones exteriores (mm): 433 x 400 x 35.

60016 2KB



Caja de Empotrar para Cuadro

Dimensiones exteriores (mm): 408 x 380 x 113.

Caja resistente a 850 °C adecuada a instalación en mampostería o paredes huecas.

60032 2GB

24 MÓDULOS (2x12) + DCP



Interior y Puerta para Cuadro de Abonado

Dimensiones exteriores (mm): 505 x 400 x 35.

60024 2KB



Caja de Empotrar para Cuadro

Dimensiones exteriores (mm): 480 x 380 x 113.

Caja resistente a 850 °C adecuada a instalación en mampostería o paredes huecas.

60040 2GB

32 MÓDULOS (2x16) + DCP



Interior y Puerta para Cuadro de Abonado

Dimensiones exteriores (mm): 577 x 400 x 35.

60032 2KB



Caja de Empotrar para Cuadro

Dimensiones exteriores (mm): 552 x 380 x 113.

Caja resistente a 850 °C adecuada a instalación en mampostería o paredes huecas.

60048 2GB

44 MÓDULOS (2x12+1x20) + DCP



Interior y Puerta para Cuadro de Abonado

Dimensiones exteriores (mm): 505 x 525 x 35.

60044 3KB



Caja de Empotrar para Cuadro

Dimensiones exteriores (mm): 480 x 505 x 113.

Caja resistente a 850 °C adecuada a instalación en mampostería o paredes huecas.

60060 3GB

64 MÓDULOS (2x12+2x20) + DCP



Interior y Puerta para Cuadro de Abonado

Dimensiones exteriores (mm): 505 x 650 x 35.

60064 4KB



Caja de Empotrar para Cuadro

Dimensiones exteriores (mm): 480 x 630 x 113.

Caja resistente a 850 °C adecuada a instalación en mampostería o paredes huecas.

60080 4GB

DCP - Dispositivo Controlador de Potencia; (*) no aplicable con ICP de carril DIN.
Dimensiones exteriores (mm): **AN** - Ancho x **AL** - Altura x **P** - Profundidad.

CUADROS DE TELECOMUNICACIONES - RTR - COMPLETOS

Ref.

6 SALIDAS DE CABLE COAXIAL (CC) Y HASTA 12 SALIDAS DE PARES DE COBRE (PC)



Cuadro de Comunicaciones Completo

Dimensiones exteriores (mm): 577 x 400 x 124;

Caja resistente a 850 °C adecuada a instalación en mampostería o paredes huecas;

Accesorios: - Repartidor PC con Conectores Cat. 6 UTP (1 entrada y 6 Salidas, expansible hasta 12 Salidas);

- Repartidor Doble Coaxial (2 entradas y 2 x 6 Salidas);
- Repartidor FO con Adaptador de Fibra Óptica SC/APC Simplex;
- Toma Schuko (Ref. 45132 SBR).

60048 2PB

8 SALIDAS DE CABLE COAXIAL (CC) Y HASTA 24 SALIDAS DE PARES DE COBRE (PC)



Cuadro de Comunicaciones Completo

Dimensiones exteriores (mm): 505 x 525 x 124;

Caja resistente a 850 °C adecuada a instalación en mampostería o paredes huecas;

Accesorios: - Repartidor PC con Conectores Cat. 6 UTP (1 entrada y 8 Salidas, expansible hasta 24 Salidas);

- Repartidor Doble Coaxial (2 entradas y 2 x 8 Salidas);
- Repartidor FO con Adaptador de Fibra Óptica SC/APC Simplex;
- Toma Schuko (Ref. 45132 SBR)

60060 3SB

12 SALIDAS DE CABLE COAXIAL (CC) Y HASTA 24 SALIDAS DE PARES DE COBRE (PC)



Cuadro de Comunicaciones Completo

Dimensiones exteriores (mm): 505 x 525 x 124;

Caja resistente a 850 °C adecuada a instalación en mampostería o paredes huecas;

Accesorios: - Repartidor PC con Conectores Cat. 6 UTP (1 entrada y 12 Salidas, expansible hasta 24 Salidas);

- Repartidor Doble Coaxial (2 entradas y 2 x 12 Salidas);
- Repartidor FO con Adaptador de Fibra Óptica SC/APC Simplex;
- Toma Schuko (Ref. 45132 SBR).

60060 3PB

CUADROS DE TELECOMUNICACIONES - CRTR - COMPLETOS

CRTR PARA 6 SALIDAS DE CABLE COAXIAL (CC) Y HASTA 12 SALIDAS DE PARES DE COBRE (PC)



Caja de Comunicaciones Auxiliar Completa (CRTR)

Dimensiones exteriores (mm): 577 x 400 x 124.

Caja resistente a 850 °C adecuada a instalación en mampostería o paredes huecas.

60048 2UB

CRTR PARA 12 SALIDAS DE CABLE COAXIAL (CC) Y HASTA 24 SALIDAS DE PARES DE COBRE (PC)



Caja de Comunicaciones Auxiliar Completa (CRTR)

Dimensiones exteriores (mm): 505 x 525 x 124.

Caja resistente a 850 °C adecuada a instalación en mampostería o paredes huecas.

60060 3UB

CC - Salidas de Cable Coaxial; PC - Salidas de Pares de Cobre; RTR - Registro de Terminación Red; CRTR - Caja Auxiliar para RTR.
Dimensiones exteriores (mm): AN - Ancho x AL - Altura x P - Profundidad.

CUADROS DE TELECOMUNICACIONES - RTR - SEMI-MONTADOS

Ref.

Ref.

6 SALIDAS DE CABLE COAXIAL (CC) Y HASTA 12 SALIDAS DE PARES DE COBRE (PC)



Interior y Puerta para RTR

Dimensiones exteriores (mm): 577 x 400 x 11.

Accesorios:

- Repartidor PC con Conectores Cat. 6 UTP (1 entrada y 6 Salidas, expansible hasta 12 Salidas);
- Repartidor Doble Coaxial (2 entradas y 2 x 6 Salidas);
- Repartidor FO con Adaptador de Fibra Óptica SC/APC Simplex;
- Toma Schuko (Ref. 45132 SBR).

60048 2LB



Caja de Empotrar para Cuadro

Dimensiones exteriores (mm): 552 x 380 x 113.

Caja resistente a 850 °C adecuada a instalación en mampostería o paredes huecas.

60048 2GB

8 SALIDAS DE CABLE COAXIAL (CC) Y HASTA 24 SALIDAS DE PARES DE COBRE (PC)



Interior y Puerta para RTR

Dimensiones exteriores (mm): 505 x 525 x 11.

Accesorios:

- Repartidor PC con Conectores Cat. 6 UTP (1 entrada y 8 Salidas, expansible hasta 24 Salidas);
- Repartidor Doble Coaxial (2 entradas y 2 x 8 Salidas);
- Repartidor FO con Adaptador de Fibra Óptica SC/APC Simplex;
- Toma Schuko (Ref. 45132 SBR).

60060 3NB



Caja de Empotrar para Cuadro

Dimensiones exteriores (mm): 480 x 505 x 113.

Caja resistente a 850 °C adecuada a instalación en mampostería o paredes huecas.

60060 3GB

12 SALIDAS DE CABLE COAXIAL (CC) Y HASTA 24 SALIDAS DE PARES DE COBRE (PC)



Interior y Puerta para RTR

Dimensiones exteriores (mm): 505 x 525 x 11.

Accesorios:

- Repartidor PC con Conectores Cat. 6 UTP (1 entrada y 12 Salidas, expansible hasta 24 Salidas);
- Repartidor Doble Coaxial (2 entradas y 2 x 12 Salidas);
- Repartidor FO con Adaptador de Fibra Óptica SC/APC Simplex;
- Toma Schuko (Ref. 45132 SBR).

60060 3MB



Caja de Empotrar para Cuadro

Dimensiones exteriores (mm): 480 x 505 x 113.

Caja resistente a 850 °C adecuada a instalación en mampostería o paredes huecas.

60060 3GB

CUADROS DE TELECOMUNICACIONES - CRTR - SEMI-MONTADOS

CRTR PARA RTR DE 6 SALIDAS DE CABLE COAXIAL (CC) Y HASTA 12 SALIDAS DE PARES DE COBRE (PC)



Puerta para Caja de Comunicaciones (CRTR)

Dimensiones exteriores (mm): 577 x 400 x 35.

60048 2QB



Caja de Empotrar para Cuadro

Dimensiones exteriores (mm): 552 x 380 x 113.

Caja resistente a 850 °C adecuada a instalación en mampostería o paredes huecas.

60048 2GB

CRTR PARA RTR DE 12 SALIDAS DE CABLE COAXIAL (CC) Y HASTA 24 SALIDAS DE PARES DE COBRE (PC)



Puerta para Caja de Comunicaciones (CRTR)

Dimensiones exteriores (mm): 505 x 525 x 35.

60060 3RB



Caja de Empotrar para Cuadro



































Dimensiones exteriores (mm): 480 x 505 x 113.

Caja resistente a 850 °C adecuada a instalación en mampostería o paredes huecas.

60060 3GB

CC - Salidas de Cable Coaxial; PC - Salidas de Pares de Cobre; RTR - Registro de Terminación Red; CRTR - Caja Auxiliar para RTR.
Dimensiones exteriores (mm): AN - Ancho x AL - Altura x P - Profundidad.

ACCESORIOS

			Ref.
	Cerradura con llave para Cuadro Eléctrico	 	60900
	Cierre para Cuadro Eléctrico	 	60910
	KIT de Fijación para Cajas de Empotrar para Paredes Huecas	 	60914
	Regleta de Conexión 9 Conexiones Fase	 	60901
	Regleta de Conexión 9 Conexiones Neutro	 	60902
	Regleta de Conexión 9 Conexiones Tierra	 	60903
	Regleta de Conexión 20 Conexiones Neutro	 	60904
	Regleta de Conexión 20 Conexiones Tierra	 	60905
	Repartidor de TV Coaxial 2x6 Salidas Tipo F, 5 - 2400 MHz, Paso DC Máx. 30 V 700 mA.		60911
	Repartidor de TV Coaxial 2x8 Salidas Tipo F, 5 - 2400 MHz, Paso DC Máx. 30 V 700 mA.		60913
	Repartidor de TV Coaxial 2x12 Salidas Tipo F, 5 - 2400 MHz, Paso DC Máx. 30 V 700 mA.		60912
	Máscara Tapa-módulos 10 módulos.		60906
	Caja Terminal Fibra Óptica		60907

 CUADROS ELÉCTRICOS DE **DISTRIBUCIÓN**  CUADROS DE **TELECOMUNICACIONES**

APARELLAJE MODULAR PARA CUADROS ELÉCTRICOS

MODUS 55

162

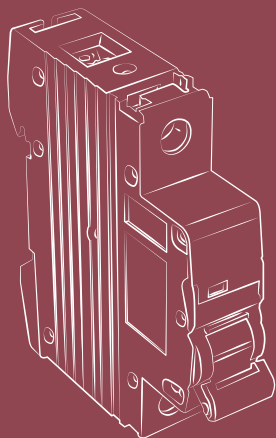

10

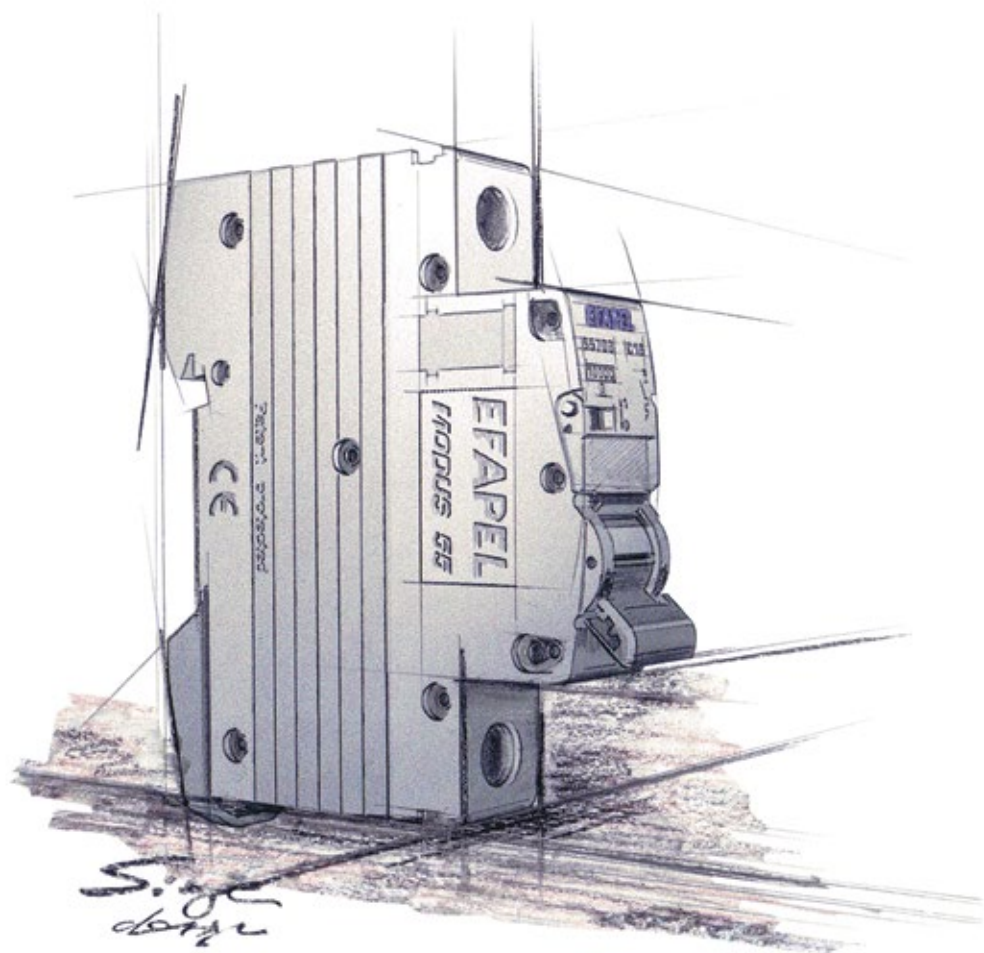

MODUS 55

DISYUNTORES MAGNETO-TÉRMICOS

- PLUS (4,5 KA) 164
- SUPER (6 KA) 165
- ULTRA (10 KA) 166

INTERRUPTORES DIFERENCIALES DIF 167

DISYUNTORES DIFERENCIALES COMBI 167

DESCARGADORES DE SOBRE TENSIÓN POWER 168

MANDO, AUTOMATISMO Y SEÑALIZACIÓN













- INTERRUPTORES 168
- SECCIONADOR PORTA FUSIBLES 169
- SEÑALIZADORES 169
- TRANSFORMADOR DE TIMBRE 169
- TIMBRE 169
- AUTOMÁTICOS DE ESCALERA 170
- CONTACTORES 170
- TELERRUPTOR 171
- INTERRUPTORES HORARIOS 171
- REGULADOR DE LUZ 171
- RELÉS 172

PUENTES DE CONEXIÓN 172





TOMAS DE CORRIENTE 173

ACCESORIOS 173





DISYUNTORES MAGNETO-TÉRMICOS PLUS (4,5 kA) - EN / IEC 60898-1

Símbolo	Descripción	Calibre In (A)	Mód. DIN	Ref. / Curva de Disparo: B	Ref. / Curva de Disparo: C	Ref. / Curva de Disparo: D
	Disyuntor MT - 1P - 4,5 kA 230/400 V ~ - 50/60 Hz	6	1	-	55106 1CP	-
		10		-	55110 1CP	-
		16		-	55116 1CP	-
		20		-	55120 1CP	-
		25		-	55125 1CP	-
		32		-	55132 1CP	-
		40		-	55140 1CP	-
		50		-	55150 1CP	-
63	-	55163 1CP	-			
						
	Disyuntor MT - 1P+N - 4,5 kA 230 V ~ - 50/60 Hz	2	1	-	55102 5CP	-
		6		-	55106 5CP	-
		10		-	55110 5CP	-
		16		-	55116 5CP	-
		20		-	55120 5CP	-
		25		-	55125 5CP	-
32	-	55132 5CP	-			
						
	Disyuntor MT - 1P+N - 4,5 kA 230 V ~ - 50/60 Hz	40	2	-	55140 6CP	-
		50		-	55150 6CP	-
		63		-	55163 6CP	-
						
	Disyuntor MT - 2P - 4,5 kA 400 V ~ - 50/60 Hz	6	2	-	55106 2CP	-
		10		-	55110 2CP	-
		16		-	55116 2CP	-
		20		-	55120 2CP	-
		25		-	55125 2CP	-
		32		-	55132 2CP	-
		40		-	55140 2CP	-
		50		-	55150 2CP	-
63	-	55163 2CP	-			
						
	Disyuntor MT - 3P - 4,5 kA 400 V ~ - 50/60 Hz	6	3	-	55106 3CP	-
		10		-	55110 3CP	-
		16		-	55116 3CP	-
		20		-	55120 3CP	-
		25		-	55125 3CP	-
		32		-	55132 3CP	-
		40		-	55140 3CP	-
		50		-	55150 3CP	-
63	-	55163 3CP	-			
						
	Disyuntor MT - 4P - 4,5 kA 400 V ~ - 50/60 Hz	6	4	-	55106 4CP	-
		10		-	55110 4CP	-
		16		-	55116 4CP	-
		20		-	55120 4CP	-
		25		-	55125 4CP	-
		32		-	55132 4CP	-
		40		-	55140 4CP	-
		50		-	55150 4CP	-
63	-	55163 4CP	-			
						



DISYUNTORES MAGNETO-TÉRMICOS SUPER (6 kA) - EN / IEC 60898-1

Símbolo	Descripción	Calibre In (A)	Mód. DIN	Ref. / Curva de Disparo: B	Ref. / Curva de Disparo: C	Ref. / Curva de Disparo: D
	Disyuntor MT - 1P - 6 kA 230/400 V ~ - 50/60 Hz	1	1	55101 1BS	55101 1CS	55101 1DS
		2		55102 1BS	55102 1CS	55102 1DS
		3		55103 1BS	55103 1CS	55103 1DS
		4		55104 1BS	55104 1CS	55104 1DS
		6		55106 1BS	55106 1CS	55106 1DS
		10		55110 1BS	55110 1CS	55110 1DS
		16		55116 1BS	55116 1CS	55116 1DS
		20		55120 1BS	55120 1CS	55120 1DS
		25		55125 1BS	55125 1CS	55125 1DS
		32		55132 1BS	55132 1CS	55132 1DS
		40		55140 1BS	55140 1CS	55140 1DS
50	55150 1BS	55150 1CS	55150 1DS			
63	55163 1BS	55163 1CS	55163 1DS			
	Disyuntor MT - 1P+N - 6 kA 230 V ~ - 50/60 Hz	1	2	55101 6BS	55101 6CS	-
		2		55102 6BS	55102 6CS	-
		3		55103 6BS	55103 6CS	-
		4		55104 6BS	55104 6CS	-
		6		55106 6BS	55106 6CS	-
		10		55110 6BS	55110 6CS	-
		16		55116 6BS	55116 6CS	-
		20		55120 6BS	55120 6CS	-
		25		55125 6BS	55125 6CS	-
		32		55132 6BS	55132 6CS	-
		40		55140 6BS	55140 6CS	-
50	55150 6BS	55150 6CS	-			
63	55163 6BS	55163 6CS	-			
	Disyuntor MT - 2P - 6 kA 400 V ~ - 50/60 Hz	1	2	55101 2BS	55101 2CS	55101 2DS
		2		55102 2BS	55102 2CS	55102 2DS
		3		55103 2BS	55103 2CS	55103 2DS
		4		55104 2BS	55104 2CS	55104 2DS
		6		55106 2BS	55106 2CS	55106 2DS
		10		55110 2BS	55110 2CS	55110 2DS
		16		55116 2BS	55116 2CS	55116 2DS
		20		55120 2BS	55120 2CS	55120 2DS
		25		55125 2BS	55125 2CS	55125 2DS
		32		55132 2BS	55132 2CS	55132 2DS
		40		55140 2BS	55140 2CS	55140 2DS
50	55150 2BS	55150 2CS	55150 2DS			
63	55163 2BS	55163 2CS	55163 2DS			
	Disyuntor MT - 3P - 6 kA 400 V ~ - 50/60 Hz	1	3	55101 3BS	55101 3CS	55101 3DS
		2		55102 3BS	55102 3CS	55102 3DS
		3		55103 3BS	55103 3CS	55103 3DS
		4		55104 3BS	55104 3CS	55104 3DS
		6		55106 3BS	55106 3CS	55106 3DS
		10		55110 3BS	55110 3CS	55110 3DS
		16		55116 3BS	55116 3CS	55116 3DS
		20		55120 3BS	55120 3CS	55120 3DS
		25		55125 3BS	55125 3CS	55125 3DS
		32		55132 3BS	55132 3CS	55132 3DS
		40		55140 3BS	55140 3CS	55140 3DS
50	55150 3BS	55150 3CS	55150 3DS			
63	55163 3BS	55163 3CS	55163 3DS			
	Disyuntor MT - 4P - 6 kA 400 V ~ - 50/60 Hz	1	4	55101 4BS	55101 4CS	55101 4DS
		2		55102 4BS	55102 4CS	55102 4DS
		3		55103 4BS	55103 4CS	55103 4DS
		4		55104 4BS	55104 4CS	55104 4DS
		6		55106 4BS	55106 4CS	55106 4DS
		10		55110 4BS	55110 4CS	55110 4DS
		16		55116 4BS	55116 4CS	55116 4DS
		20		55120 4BS	55120 4CS	55120 4DS
		25		55125 4BS	55125 4CS	55125 4DS
		32		55132 4BS	55132 4CS	55132 4DS
		40		55140 4BS	55140 4CS	55140 4DS
50	55150 4BS	55150 4CS	55150 4DS			
63	55163 4BS	55163 4CS	55163 4DS			

DISYUNTORES MAGNETO-TÉRMICOS ULTRA (10 kA) - EN / IEC 60898-1

Simbolo	Descripción	Calibre In (A)	Mód. DIN	Ref. / Curva de Disparo: B	Ref. / Curva de Disparo: C	Ref. / Curva de Disparo: D
	Disyuntor MT - 1P - 10 kA 230/400 V ~ - 50/60 Hz	1	1	55101 1BU	55101 1CU	55101 1DU
		2		55102 1BU	55102 1CU	55102 1DU
		3		55103 1BU	55103 1CU	55103 1DU
		4		55104 1BU	55104 1CU	55104 1DU
		6		55106 1BU	55106 1CU	55106 1DU
		10		55110 1BU	55110 1CU	55110 1DU
		16		55116 1BU	55116 1CU	55116 1DU
		20		55120 1BU	55120 1CU	55120 1DU
		25		55125 1BU	55125 1CU	55125 1DU
		32		55132 1BU	55132 1CU	55132 1DU
		40		55140 1BU	55140 1CU	55140 1DU
50	55150 1BU	55150 1CU	55150 1DU			
63	55163 1BU	55163 1CU	55163 1DU			
	Disyuntor MT - 2P - 10 kA 400 V ~ - 50/60 Hz	1	2	55101 2BU	55101 2CU	55101 2DU
		2		55102 2BU	55102 2CU	55102 2DU
		3		55103 2BU	55103 2CU	55103 2DU
		4		55104 2BU	55104 2CU	55104 2DU
		6		55106 2BU	55106 2CU	55106 2DU
		10		55110 2BU	55110 2CU	55110 2DU
		16		55116 2BU	55116 2CU	55116 2DU
		20		55120 2BU	55120 2CU	55120 2DU
		25		55125 2BU	55125 2CU	55125 2DU
		32		55132 2BU	55132 2CU	55132 2DU
		40		55140 2BU	55140 2CU	55140 2DU
50	55150 2BU	55150 2CU	55150 2DU			
63	55163 2BU	55163 2CU	55163 2DU			
	Disyuntor MT - 3P - 10 kA 400 V ~ - 50/60 Hz	1	3	55101 3BU	55101 3CU	55101 3DU
		2		55102 3BU	55102 3CU	55102 3DU
		3		55103 3BU	55103 3CU	55103 3DU
		4		55104 3BU	55104 3CU	55104 3DU
		6		55106 3BU	55106 3CU	55106 3DU
		10		55110 3BU	55110 3CU	55110 3DU
		16		55116 3BU	55116 3CU	55116 3DU
		20		55120 3BU	55120 3CU	55120 3DU
		25		55125 3BU	55125 3CU	55125 3DU
		32		55132 3BU	55132 3CU	55132 3DU
		40		55140 3BU	55140 3CU	55140 3DU
50	55150 3BU	55150 3CU	55150 3DU			
63	55163 3BU	55163 3CU	55163 3DU			
	Disyuntor MT - 4P - 10 kA 400 V ~ - 50/60 Hz	1	4	55101 4BU	55101 4CU	55101 4DU
		2		55102 4BU	55102 4CU	55102 4DU
		3		55103 4BU	55103 4CU	55103 4DU
		4		55104 4BU	55104 4CU	55104 4DU
		6		55106 4BU	55106 4CU	55106 4DU
		10		55110 4BU	55110 4CU	55110 4DU
		16		55116 4BU	55116 4CU	55116 4DU
		20		55120 4BU	55120 4CU	55120 4DU
		25		55125 4BU	55125 4CU	55125 4DU
		32		55132 4BU	55132 4CU	55132 4DU
		40		55140 4BU	55140 4CU	55140 4DU
50	55150 4BU	55150 4CU	55150 4DU			
63	55163 4BU	55163 4CU	55163 4DU			

INTERRUPTORES DIFERENCIALES DIF - EN / IEC 61008-1

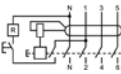

Símbolo	Descripción	Calibre In (A)	Mód. DIN	Ref. / Clase: AC (☑)	Ref. / Clase: A (☑)
	Interruptor Diferencial 2P - 10 mA	16	2	55616 2AC	—
		25		55625 2AC	—
	Interruptor Diferencial 2P - 30 mA	16	2	55616 2BC	55616 2BA
		25		55625 2BC	55625 2BA
		40		55640 2BC	55640 2BA
	Interruptor Diferencial 2P - 300 mA	40	2	55640 2DC	55640 2DA
63		55663 2DC		55663 2DA	
63		55663 2DC		55663 2DA	
	Interruptor Diferencial 2P - 500 mA	25	2	55625 2EC	—
		40		55640 2EC	—
		63		55663 2EC	—
	Interruptor Diferencial 4P - 30 mA	25	4	55625 4BC	55625 4BA
		40		55640 4BC	55640 4BA
		63		55663 4BC	55663 4BA
	Interruptor Diferencial 4P - 300 mA	25	4	55625 4DC	55625 4DA
		40		55640 4DC	55640 4DA
		63		55663 4DC	55663 4DA
	Interruptor Diferencial 4P - 500 mA	25	4	55625 4EC	—
		40		55640 4EC	—
		63		55663 4EC	—

 **Antitransitorios** - Los Interruptores Diferenciales DIF están protegidos contra disparos intempestivos provocados por corrientes de fuga transitoria (descargas atmosféricas, cargas capacitivas).

 **Clase AC** - De uso genérico, aseguran la protección en presencia de corrientes de fuga, con forma de onda puramente sinusoidal.

 **Clase A** - Para instalaciones con equipos, tales como rectificadores con diodos, triacs, etc., que provoquen una fuga de corriente continua, no detectable por los diferenciales de la Clase AC.

DISYUNTORES DIFERENCIALES COMBI - EN / IEC 61009-1

Símbolo	Descripción	Calibre In (A)	Mód. DIN	Ref. / Clase / Curva: AC (☑) / C
	Disyuntor Diferencial 1P+N - 6 kA - 30 mA	6	2	55306 6BY
		10		55310 6BY
		16		55316 6BY
		20		55320 6BY
		25		55325 6BY
		32		55332 6BY
		40		55340 6BY

 **Antitransitorios** - Los Interruptores Diferenciales DIF están protegidos contra disparos intempestivos provocados por corrientes de fuga transitoria (descargas atmosféricas, cargas capacitivas).









 **Clase AC** - De uso genérico, aseguran la protección en presencia de corrientes de fuga, con forma de onda puramente sinusoidal.

DESCARGADORES DE SOBRE TENSÓN POWER - IEC 61643-1

Símbolo	Descripción	Tensión Nominal (Un/Uc)	I _{max} (kA)	Mód. DIN	Ref.
	 Descargador de Sobre Tensión - 1P	230/320 V ~ 50/60 Hz	10		55410 1DC
	 Descargador de Sobre Tensión - 1P	230/320 V ~ 50/60 Hz	20		55420 1DC
	 Descargador de Sobre Tensión - 1P	230/320 V ~ 50/60 Hz	40	1	55440 1DC
	 Descargador de Sobre Tensión - 1P	380/420 V ~ 50/60 Hz	60		55460 1DC

MANDO, AUTOMATISMO Y SEÑALIZACIÓN - IEC 60947-3

INTERRUPTORES

Símbolo	Descripción	Tensión Nominal (Un)	Intensidad Asignada I _n (A)	Mód. DIN	Ref.	
		Interruptor - 1P	250/415 V ~ 50/60 Hz	25	1	55525 1IT
				32		55532 1IT
				40		55540 1IT
				63		55563 1IT
				80		55580 1IT
				100		55500 1IT
		Interruptor - 2P	250/415 V ~ 50/60 Hz	25	2	55525 2IT
				32		55532 2IT
				40		55540 2IT
				63		55563 2IT
				80		55580 2IT
				100		55500 2IT
		Interruptor - 3P	250/415 V ~ 50/60 Hz	25	3	55525 3IT
				32		55532 3IT
				40		55540 3IT
				63		55563 3IT
				80		55580 3IT
				100		55500 3IT
		Interruptor - 4P	250/415 V ~ 50/60 Hz	25	4	55525 4IT
				32		55532 4IT
				40		55540 4IT
				63		55563 4IT
				80		55580 4IT
				100		55500 4IT

MANDO, AUTOMATISMO Y SEÑALIZACIÓN



SECCIONADOR PORTA FUSIBLES

	Descripción	Mód. DIN	Ref.
	Seccionador Porta Fusibles Unipolar 10x38	1	55545



SEÑALIZADORES

Símbolo	Descripción	Color	Potencia (W)	Mód. DIN	Ref.
	Señalizador Luminoso con Difusor 230 V ~ - 50/60 Hz	Verde	<1	1	55560 VRD
		Rojo			55560 VRM
		Naranja			55560 LAR
	Señalizador de Tensión Trifásico 230 V ~ - 50/60 Hz		1,5	1	55009
	Señalizador del Valor de Tensión Monofásico 230 V ~ - 50/60 Hz Nivel de Tensión: 195 - 245 V ~.		5,5	1	55010
	Señalizador del Valor de Tensión Trifásico 230 V ~ - 50/60 Hz Nivel de Tensión: 195 - 245 V ~.		15,5	2	55011

TRANSFORMADOR DE TIMBRE



Símbolo	Descripción	Potencia	Tensión de Secundario (V)	Mód. DIN	Ref.
	Transformador de Timbre	8 VA	8 - 12 - 24	2	55508 TRF
					

TIMBRE





Símbolo	Descripción	Potencia	Tensión (V)	Mód. DIN	Ref.
	Timbre	5 VA	12	1	55505 CMP
		6,5 VA	230		55565 CMP

MANDO, AUTOMATISMO Y SEÑALIZACIÓN

AUTOMÁTICOS DE ESCALERA

	Descripción	Intensidad Asignada (A)	Mód. DIN	Ref.
	Automático de Escalera Electrónico de 16 A 230 V ~ - 50/60 Hz Temporización: 10 seg. - 10 min. Silencioso.	16	1	55030
	Automático de Escalera Electrónico de 16 A con Bloqueo 230 V ~ - 50/60 Hz Temporización: 3 min. - 30 min. Silencioso.	16	1	55031
	Automático de Escalera de 10 A 230 V ~ - 50/60 Hz	10	1	55510 SPA

CONTACTORES

	Descripción	Tipo	Intensidad Asignada (A)	Mód. DIN	
	Contactor Bipolar 230 V ~ - 50/60 Hz	2NA	20	1	55020 2NA
		2NF	20	1	55020 2NF
		1NA+1NC	20	1	55020 2AF
	Contactor Bipolar Mando Manual 230 V ~ - 50/60 Hz	2NA	20	1	55020 2MA
		2NC	20	1	55020 2MF
	Contactor Tetrapolar 230 V ~ - 50/60 Hz	4NA	25	2	55025 4NA
		4NC	25	2	55025 4NF
	Contactor Tetrapolar 230 V ~ - 50/60 Hz	4NA	63	3	55063 4NA
		4NC	63	3	55063 4NF

NA - Normalmente Abierto; **NC** - Normalmente Cerrado.

MANDO, AUTOMATISMO Y SEÑALIZACIÓN

TELERRUPTOR

	Descripción	Tipo	Intensidad Asignada (A)	Mód. DIN	Ref.
	<p>Interrupor Electrónico de 16 A 230 V ~ - 50/60 Hz Silencioso.</p>	1NA	16	1	55017

INTERRUPTORES HORARIOS

	Descripción	Tipo	Intensidad Asignada (A)	Mód. DIN	Ref.
	<p>Interrupor Horario de 1 Canal 230 V ~ - 50/60 Hz</p>	Diário Analógico	16	1	5501 ANL

	<p>Interrupor Horario de 1 Canal 230 V ~ - 50/60 Hz Tipo de funcionamiento: manual, automático, aleatoria. Tipo de maniobras: ON, OFF y PULSO. Espacios de memoria: 400 memorias. Posibilidad de accionamiento mediante Pulsadores.</p>	Digital / Semanal	16	2	55037
--	---	-------------------	----	---	--------------

	<p>Interrupor Horario de 1 Canal 230 V ~ - 50/60 Hz</p>	Digital / Semanal Digital	16	2	5501 DIG
---	---	---------------------------	----	---	-----------------

	<p>Interrupor Horario de 2 Canales 230 V ~ - 50/60 Hz Tipo de funcionamiento: manual, automático, aleatoria. Tipo de maniobras: ON, OFF y PULSO. Espacios de memoria: 400 memorias. Posibilidad de accionamiento mediante Pulsadores.</p>	Digital / Semanal	16	2	55039
--	---	-------------------	----	---	--------------

REGULADOR DE LUZ



	Descripción	Potencia Salida (W)	Mód. DIN	Ref.
	<p>Regulador de Luz Electrónico Modular 230 V ~ - 50/60 Hz Conectar por Pulsadores o Tecla. Cargas máximas recomendadas: - Lámparas incandescentes: 500 W. - Lámparas fluorescentes compactas REGULABLES: 300 W. - Lámparas de halógeno de MBT con transformador ferromagnético: 500 W. - Lámparas de halógeno de MBT con transformador electrónico: 500 W. Silencioso.</p>	30-500	2	55020

MANDO, AUTOMATISMO Y SEÑALIZACIÓN

RELÉS

	Descripción		Intensidad Asignada (A)	Mód. DIN	Ref.
	Relé Control de Tensión Monofásico 230 V ~ - 50/60 Hz Tensión mínima: 170 - 225 V ~. Tensión máxima: 235 - 290 V ~.	1NA+NC	–	1	55024
	Relé Control de Intensidad Monofásico de 16 A 230 V ~ - 50/60 Hz Ajuste del valor de Intensidad: 1,6 - 16 A.	1NA+NC	16A	1	55025

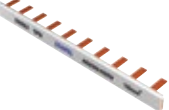
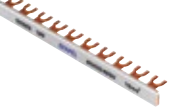
PUENTES DE CONEXIÓN

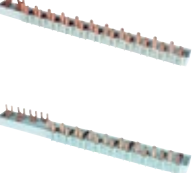
	Descripción	Imax (A)	Longitud (m)	Ref.
PUENTES DE CONEXIÓN RECTOS				
	Puente de Conexión Recto - 1P			55563 1PD
	Puente de Conexión Recto - 2P			55563 2PD
	Puente de Conexión Recto - 3P	63	1	55563 3PD
	Puente de Conexión Recto - 4P			55563 4PD
PUENTES DE CONEXIÓN EN "U"				
	Puente de Conexión en "U" - 1P			55563 1PF
	Puente de Conexión en "U" - 2P			55563 2PF
	Puente de Conexión en "U" - 3P	63	1	55563 3PF
	Puente de Conexión en "U" - 4P			55563 4PF
PUENTES DE CONEXIÓN PLANOS				
	Puente de Conexión Plano - 1P - 13 Dientes		–	55563 1WP
	Puente de Conexión Plano - 1P	63	1	55563 1PP
PUENTES DE CONEXIÓN EN "U" / RECTOS				
	Puente de Conexión en "U"/Recto 13 Módulos 1P+N		–	55563 5PR
	Puente de Conexión en "U"/Recto 13 Módulos 3P+N	63	–	55563 6PR



PUENTES DE CONEXIÓN

	Descripción	Ref.
TAPAS PARA PUENTES DE CONEXIÓN RECTO		
	Tapa para Puente de Conexión Recto - 1P	55563 1TP
	Tapa para Puente de Conexión Recto - 2P	55563 2TP
	Tapa para Puente de Conexión Recto - 3P	55563 3TP
	Tapa para Puente de Conexión Recto - 4P	55563 4TP



TOMAS DE CORRIENTE - IEC 60884-1

	Descripción	Color	Intensidad Asignada (A)	Mód. DIN	Ref.
	Toma Schuko con Protección 16 A - 250 V ~	Blanco	16	2,5	55532 CBR
		Rojo			55532 CVM
		Naranja			55532 CLR
	Toma Schuko 16 A - 250 V ~	Blanco	16	2,5	55531 CBR
		Rojo			55531 CVM
		Naranja			55531 CLR
	Toma Schuko con Enclavamiento 16 A - 250 V ~ <small>Incluye Perno de Enclavamiento para Tomas MEC Q45 (Ref.º 45991).</small>	Rojo			55536 CVM
	Toma Schuko con Enclavamiento y Señalización 16 A - 250 V ~ <small>Incluye Perno de Enclavamiento para Tomas MEC Q45 (Ref.º 45991).</small>				55537 CVM
	Toma Francesa con Protección 16 A - 250 V ~	Blanco	16	2,5	55512 CBR
Rojo		55512 CVM			
Naranja		55512 CLR			
Toma Francesa 16 A - 250 V ~	Blanco	16	2,5	55511 CBR	
	Rojo			55511 CVM	
	Naranja			55511 CLR	
Toma Francesa con Enclavamiento 16 A - 250 V ~ <small>Incluye Perno de Enclavamiento para Tomas MEC Q45 (Ref.º 45991).</small>	Rojo			55516 CVM	
Toma Francesa con Enclavamiento y Señalización 16 A - 250 V ~ <small>Incluye Perno de Enclavamiento para Tomas MEC Q45 (Ref.º 45991).</small>				55517 CVM	

ACCESORIOS

	Descripción	Color	Intensidad Asignada (A)	Mód. DIN	Ref.
	Adaptador Simple Q45 para Cuadros Eléctricos	BR	—	—	45990 A
	Perno de Enclavamiento para Tomas Q45	—	—	—	45991
	Conector Bilateral IP2X <small>Capacidad de conexión de conductores hasta 25 mm².</small>	—	63	1	55563 1LG

C - Producto Completo; A - Accesorio. | BR - Blanco; VM - Rojo; LR - Naranja.

 /  - Conexión tuerca tornillo.



TOMAS PARA RECARGA VE

		Ref.	Color
	Toma de Empotrar Schuko para Recarga VE 16 A - 250 V ~	 81132	
	Toma de Empotrar Francesa para Recarga VE 16 A - 250 V ~	 81112	
	Toma de Superficie Schuko para Recarga VE 16 A - 250 V ~	 81751	
	Toma de Superficie Francesa para Recarga VE 16 A - 250 V ~	 81752	

TACOS

	Ref.	Color
	Taco de 5 mm (Envase de 100 Un)	81052
	Taco de 5 mm (Envase de 500 Un)	81053
	Taco de 5 mm (Envase de 1000 Un)	81054
	Taco de 5 mm (Envase de 5000 Un)	81055
	Taco de 6 mm (Envase de 100 Un)	81062
	Taco de 6 mm (Envase de 500 Un)	81063
	Taco de 6 mm (Envase de 1000 Un)	81064
	Taco de 6 mm (Envase de 5000 Un)	81065
	Taco de 8 mm (Envase de 100 Un)	81082
	Taco de 8 mm (Envase de 500 Un)	81083
	Taco de 8 mm (Envase de 1000 Un)	81084
	Taco de 10 mm (Envase de 100 Un)	81102
	Taco de 10 mm (Envase de 500 Un)	81103
	Taco de 10 mm (Envase de 1000 Un)	81104

PORTALÁMPARAS

	Ref.	Color
	Portalámpara E27 (Luminarias) 4 A - 250 V ~	81211
	Portalámpara E27 (Pantalla) 4 A - 250 V ~	81221
	Portalámpara E27 de Toma Fija 200 W Máx. - 250 V ~	81251

EFAPEL[®]

SOLUCIONES ELÉCTRICAS

NUEVO



PUESTOS DE TRABAJO
SUPERFICIE Y EMPOTRAR

efapel.com





EFAPEL se reserva el derecho de modificar este documento o de los productos contenidos en él sin previo aviso. En caso de dudas, por favor póngase en contacto con EFAPEL.

efapel.com



Serpins,
3200-355 Serpins
PORTUGAL

ESPAÑA
☎ +900 535 746
✉ espana@efapel.com

EXPORT
☎ +351 239 970 135
✉ export@efapel.com

SAT - Servicio de Asistencia Técnica
☎ +351 239 970 132
✉ sat@efapel.com

