

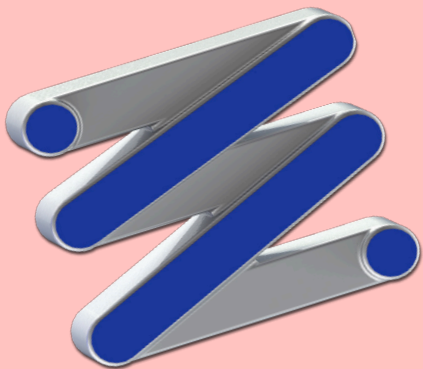

\*SEÑOR Aisladores Acústicos

# Tarifa INDUSTRIA 2022



# SEÑOR

1<sup>a</sup>  
Edición



# Tarifa **INDUSTRIA** 2022

**1ª EDICIÓN: VIGENTE A PARTIR DEL 1 DE ENERO DE 2022**

**Esta tarifa podrá ser modificada en caso de producirse un incremento en el precio de la materia prima. Si ese fuera el caso, se notificaría con 15 días de antelación.**



# Tarifa **INDUSTRIA** **2022**

\*SEÑOR Aisladores Acústicos

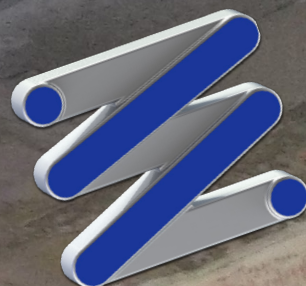

**SEÑOR**

## CONDUCTOS / **FIBRA & METAL**



AS-PLUS/L METAL

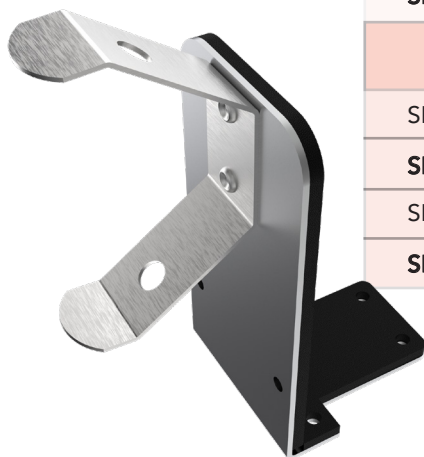

AS + AC/LA METAL

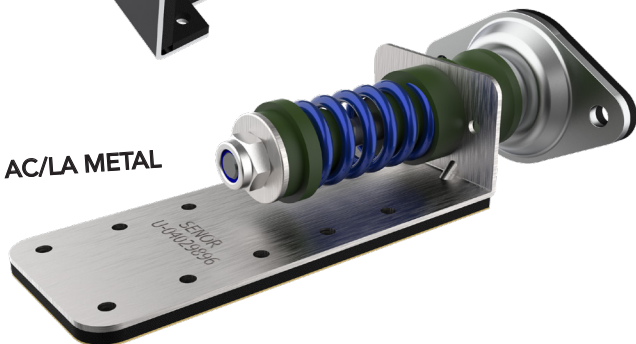

AS + AC/LV METAL



Referencia	Carga mínima/máx	P.V €/Ud
Reference	minimum/maximum load	RRP € / Unit
<b>Conducto FIBRA</b>		
SE-AS-PLUS/L4 A.FIBRA	-	2,46 €
SE-AS-PLUS/L6 A.FIBRA	-	2,46 €
<b>Conducto METÁLICO</b>		
SE-AS-PLUS/L6 A.METAL	-	4,65 €
SE-AS-PLUS/L8 A.METAL	-	5,57 €
<b>Conducto METÁLICO HÍBRIDO</b>		
SE-AS + AC/LG 15 METAL	3Kg hasta 15Kg	8,65 €
SE-AS + AC/LV 30 METAL	15Kg hasta 30Kg	8,72 €
SE-AS + AC/LA 50 METAL	30Kg hasta 50Kg	8,77 €
SE-AS + AC/LR 75 METAL	50Kg hasta 75Kg	8,85 €

## MÁQUINAS COLGADAS / **TECHO**

<b>Referencia</b>	<b>Carga mínima/máx</b>	<b>P.V € / Ud</b>
Reference	minimum/maximum load	RRP € / Unit
<b>FAN-COILS / GOMA</b>		
SE-TA-30/M6	8Kg hasta 30Kg	2,10 €
<b>SE-TA-30/M8</b>	<b>8Kg hasta 30Kg</b>	<b>2,19 €</b>
SE-TA-50/M6	27Kg hasta 50Kg	2,17 €
<b>SE-TA-50/M8</b>	<b>27Kg hasta 50Kg</b>	<b>2,24 €</b>
SE-TAC-30/M6	8Kg hasta 30Kg	2,33 €
<b>SE-TAC-30/M8</b>	<b>8Kg hasta 30Kg</b>	<b>2,41 €</b>
SE-TAC-50/M6	27Kg hasta 50Kg	2,40 €
<b>SE-TAC-50/M8</b>	<b>27Kg hasta 50Kg</b>	<b>2,49 €</b>
SE-TAF-10 G/M8	<b>Nuevo</b> 3Kg hasta 10Kg	3,33 €
<b>SE-TAF-20 V/M8</b>	<b>8Kg hasta 20Kg</b>	<b>3,46 €</b>
<b>FAN-COILS / MUELLE</b>		
SE-TCM-15 G/INOX/M8	3Kg hasta 15Kg	5,78 €
<b>SE-TCM-30 V/INOX/M8</b>	<b>15Kg hasta 30Kg</b>	<b>5,91 €</b>
SE-TCM-50 A/INOX/M8	30Kg hasta 50Kg	5,99 €
<b>SE-TCM-75 R/INOX/M8</b>	<b>50Kg hasta 75Kg</b>	<b>6,05 €</b>
SE-SCM-20 G/INOX/M8	3Kg hasta 20Kg	8,98 €
<b>SE-SCM-45 V/INOX/M8</b>	<b>15Kg hasta 45Kg</b>	<b>9,12 €</b>
SE-SCM-75 A/INOX/M8	30Kg hasta 75Kg	9,27 €
<b>SE-SCM-120 R/INOX/M8</b>	<b>60Kg hasta 120Kg</b>	<b>9,40 €</b>

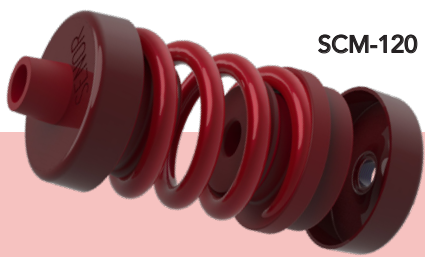

SCM-120 R/INOX



TCM-50 A/INOX

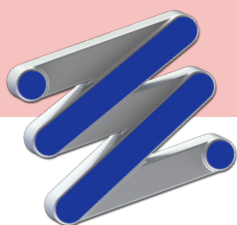

**SEÑOR**

A6/IH 30 V



# Tarifa **INDUSTRIA** 2022

## MÁQUINAS COLGADAS / **TECHO**

Referencia	Carga mínima/máx	P.V €/Ud
Reference	minimum/maximum load	RRP € / Unit

### CAJAS DE VENTILACIÓN / **GOMA**

SE-A6/IH-30 V/M8	<b>Nuevo</b>	8Kg hasta 30Kg	9,54 €
SE-A6/IH-50A/M8	<b>Nuevo</b>	27Kg hasta 50Kg	10,19 €
SE-A6/IE-30 V/M8	<b>Nuevo</b>	8Kg hasta 30Kg	10,67 €
SE-A6/IE-50A/M8	<b>Nuevo</b>	27Kg hasta 50Kg	11,32 €

A6/IE 50 A **Nuevo**



### EXTRACTORES / **GOMA**

SE-TAV/4000 G		3Kg hasta 20Kg	49,24 €
SE-TAV/4000 V		15Kg hasta 35Kg	52,20 €
SE-TAV/4000 A		30Kg hasta 45Kg	55,17 €
SE-TAV/4000 R		40Kg hasta 60Kg	57,88 €

\* **Productos disponibles en diferentes métricas: 8, 10, 12, 14 & 16.**

SE-TAV/4000 EG	<b>Nuevo</b>	3Kg hasta 20Kg	52,64 €
SE-TAV/4000 EV	<b>Nuevo</b>	15Kg hasta 35Kg	55,60 €
SE-TAV/4000 EA	<b>Nuevo</b>	30Kg hasta 45Kg	58,57 €
SE-TAV/4000 ER	<b>Nuevo</b>	40Kg hasta 60Kg	61,28 €

TAV/4000 G

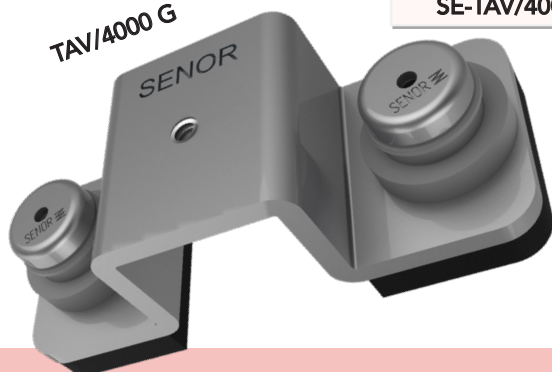

TAV/4000 ER

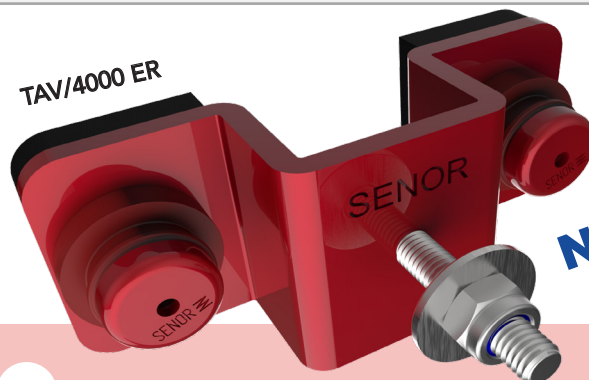

**Nuevo**

**SEÑOR**

## MÁQUINAS COLGADAS / **TECHO**

<b>Referencia</b>	<b>Carga mínima/máx</b>	<b>P.V €/Ud</b>
Reference	minimum/maximum load	RRP € / Unit

## EXTRACTORES / **MUELLE + GOMA**

SE-A4M8-MIXTO/20 G	3Kg hasta 20Kg	19,39 €
<b>SE-A4M8-MIXTO/45 V</b>	<b>15Kg hasta 45Kg</b>	<b>19,61 €</b>
SE-A4M8-MIXTO/75 A	30Kg hasta 75Kg	19,78 €
<b>SE-A4M8-MIXTO/120 R</b>	<b>60Kg hasta 120Kg</b>	<b>19,92 €</b>
SE-A4M10-MIXTO/20 G	3Kg hasta 20Kg	19,49 €
<b>SE-A4M10-MIXTO/45 V</b>	<b>15Kg hasta 45Kg</b>	<b>19,67 €</b>
SE-A4M10-MIXTO/75 A	30Kg hasta 75Kg	19,87 €
<b>SE-A4M10-MIXTO/120 R</b>	<b>60Kg hasta 120Kg</b>	<b>20,15 €</b>

## CAJAS DE VENTILACIÓN / **MUELLE + GOMA**

SE-A4MIXTO E 20 G/I-M8	<b>Nuevo</b>	3Kg hasta 20Kg	20,18 €
<b>SE-A4MIXTO E 45 V/I-M8</b>	<b>Nuevo</b>	<b>15Kg hasta 45Kg</b>	<b>20,33 €</b>
SE-A4MIXTO E 75 A/I-M8	<b>Nuevo</b>	30Kg hasta 75Kg	20,52 €
<b>SE-A4MIXTO E 120 R/I-M8</b>	<b>Nuevo</b>	<b>60Kg hasta 120Kg</b>	<b>20,67 €</b>

A4M-MIXTO/20G

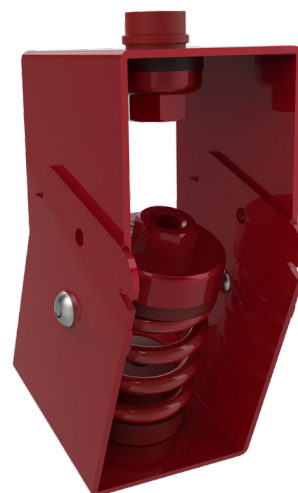
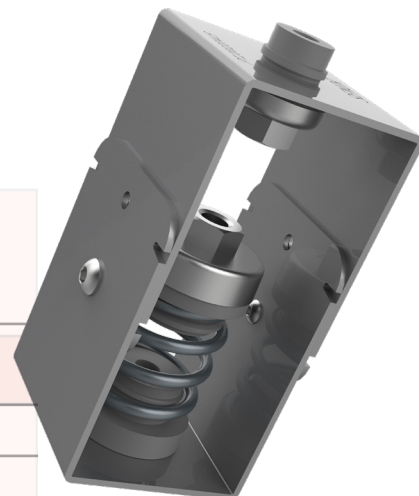

A4M-MIXTO/120 R

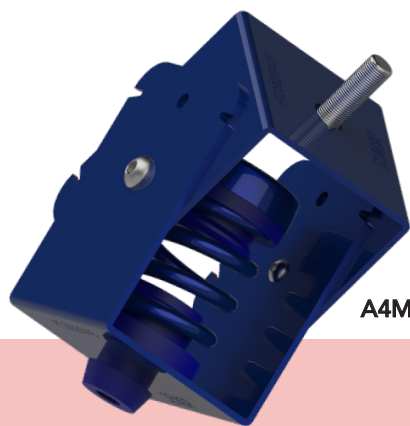

A4MIXTO E 45 V/I-M8

**Nuevo**

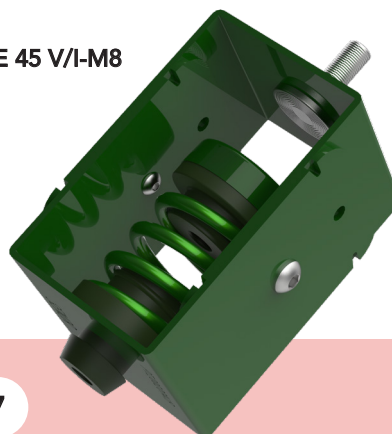

A4MIXTO E 75 A/I-M8



**SENOR**

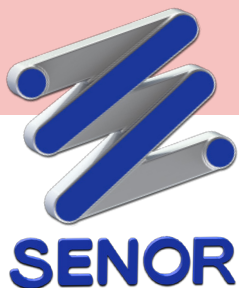

# Tarifa **INDUSTRIA** 2022

## MÁQUINAS SUSPENDIDAS / **TECHO**

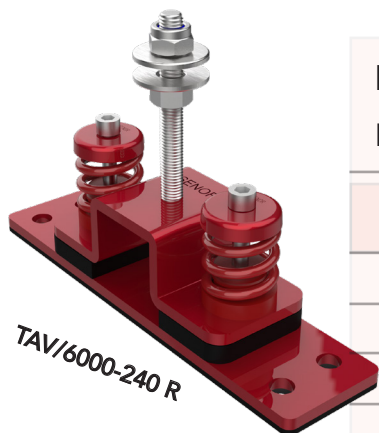

**Nuevo**

Referencia	Carga mínima/máx	P.V €/Ud
Reference	minimum/maximum load	RRP € / Unit
<b>ENFRIADORAS / MUELLE + GOMA</b>		
SE-TAV-6000/40 G	<b>Nuevo</b> 6Kg hasta 40Kg	73,07 €
SE-TAV-6000/90 V	<b>Nuevo</b> 30Kg hasta 90Kg	76,05 €
SE-TAV-6000/150 A	<b>Nuevo</b> 60Kg hasta 150Kg	79,02 €
SE-TAV-6000/240 R	<b>Nuevo</b> 120Kg hasta 240Kg	82,00 €
<b>MÁQUINAS PESADAS / MUELLE + GOMA</b>		
SE-TAV-7000/80 G	<b>Nuevo</b> 12Kg hasta 80Kg	112,55 €
SE-TAV-7000/180 V	<b>Nuevo</b> 60Kg hasta 180Kg	113,12 €
SE-TAV-7000/300 A	<b>Nuevo</b> 120Kg hasta 300Kg	113,69 €
SE-TAV-7000/480 R	<b>Nuevo</b> 240Kg hasta 480Kg	114,26 €

\* **Productos disponibles en diferentes métricas:** 8, 10, 12, 14 & 16.



TAV/6000-90 V

**Nuevo**

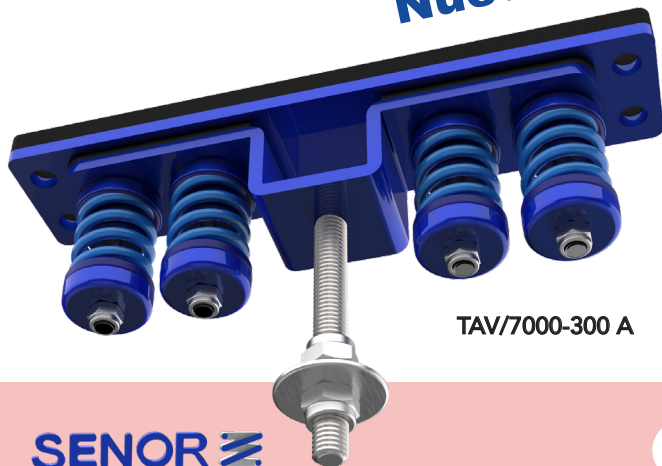

TAV/7000-300 A

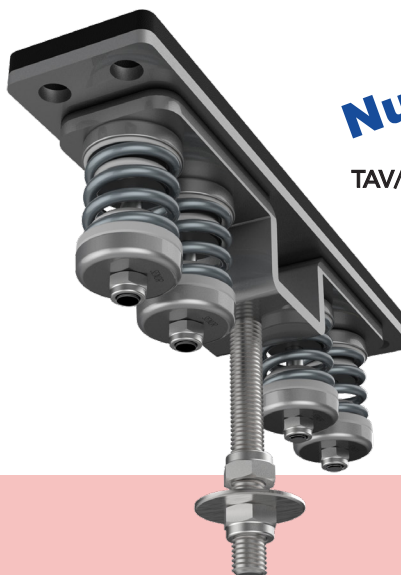

TAV/7000-80 G

**Nuevo**



## SPLIT / DOMÉSTICO

Referencia	Carga mínima/máx	P.V €/Ud
Reference	minimum/maximum load	RRP € / Unit
<b>MÁQUINAS SOBRE ESCUADRA / GOMA</b>		
SE-BF-25	5Kg hasta 25Kg	2,83 €
<b>SE-BF-35</b>	<b>25Kg hasta 35Kg</b>	<b>2,86 €</b>
SE-BF-45	35Kg hasta 45Kg	2,89 €
<b>SE-BF-60</b>	<b>45Kg hasta 60Kg</b>	<b>2,91 €</b>
* <b>Productos disponibles en métrica: 8.</b>		
SE-SPLIT/65-FUSIÓN	PACK DE 2 UDS BF-25 + 2 UDS BF-60	11,25 €
<b>SE-SPLIT/70-FUSIÓN</b>	<b>PACK DE 2 UDS BF-45 + 2 UDS BF-60</b>	<b>11,42 €</b>
* <b>Productos disponibles en métrica: 8.</b>		
<b>MÁQUINAS SOBRE SUELO / GOMA</b>		
SE-CF-10 G	4Kg hasta 12Kg	4,66 €
<b>SE-CF-20 V</b>	<b>9Kg hasta 24Kg</b>	<b>4,90 €</b>
SE-CF-30 A	15Kg hasta 35Kg	5,01 €
<b>SE-CF-50 R</b>	<b>30Kg hasta 50Kg</b>	<b>5,15 €</b>

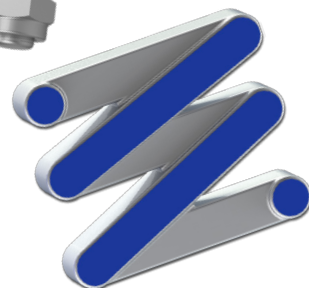
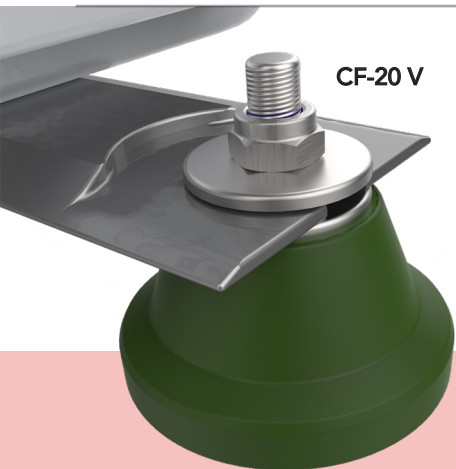

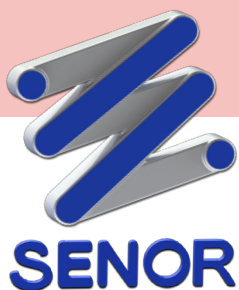

# Tarifa **INDUSTRIA** 2022

## SPLIT / **DOMÉSTICO**

SPLIT/75-FUSIÓN



CR-30 A



TB/INOX E-45 V

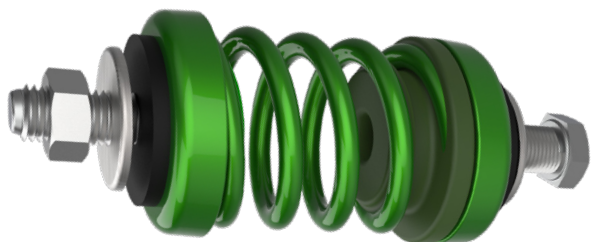

TB/INOX E-75 A



Referencia	Carga mínima/máx	P.V €/Ud
Reference	minimum/maximum load	RRP € / Unit

### MÁQUINAS SOBRE SUELO / **GOMA**

SE-SPLIT/75-FUSIÓN	PACK DE 2 UDS CF-10 G + 2 UDS CF-50 R	18,36 €
--------------------	---------------------------------------	---------

\* **Productos disponibles en métrica: 8.**

### MÁQUINAS SOBRE SUELO / **REGULABLE GOMA**

SE-CR-10 G	3Kg hasta 10Kg	6,92 €
SE-CR-20 V	8Kg hasta 20Kg	6,95 €
SE-CR-30 A	15Kg hasta 30Kg	6,98 €
SE-CR-50 R	25Kg hasta 50Kg	7,01 €

\* **Productos disponibles en métrica: 8.**

### MÁQUINAS SOBRE ESCUADRA / **MUELLE + GOMA**

SE-TB/INOX E-20 G	3Kg hasta 20Kg	20,94 €
SE-TB/INOX E-45 V	15Kg hasta 45Kg	21,34 €
SE-TB/INOX E-75 A	30Kg hasta 75Kg	21,73 €
SE-TB/INOX E-120 R	60Kg hasta 120Kg	22,91 €

Fabricante de sistemas **ANTIVIBRATORIOS**

## SPLIT / DOMÉSTICO **ANTIVUELCO**

Referencia	Carga mínima/máx	P.V €/Ud
Reference	minimum/maximum load	RRP € / Unit
<b>MÁQUINAS SOBRE ESCUADRA / HÍBRIDO</b>		
SE-TBF-20 G	<b>Nuevo</b> 3Kg hasta 20Kg	28,84 €
SE-TBF-45 V	<b>Nuevo</b> 15Kg hasta 45Kg	29,02 €
SE-TBF-75 A	<b>Nuevo</b> 30Kg hasta 75Kg	29,38 €
SE-TBF-120 R	<b>Nuevo</b> 60Kg hasta 120Kg	30,53 €

\* **Productos disponibles en métrica: 8.**

<b>MÁQUINAS SOBRE SUELO / HÍBRIDO</b>		
SE-TBMF-20 G	<b>Nuevo</b> 3Kg hasta 20Kg	35,67 €
SE-TBMF-45 V	<b>Nuevo</b> 15Kg hasta 45Kg	36,73 €
SE-TBMF-75 A	<b>Nuevo</b> 30Kg hasta 75Kg	37,19 €
SE-TBMF-120 R	<b>Nuevo</b> 60Kg hasta 120Kg	37,56 €

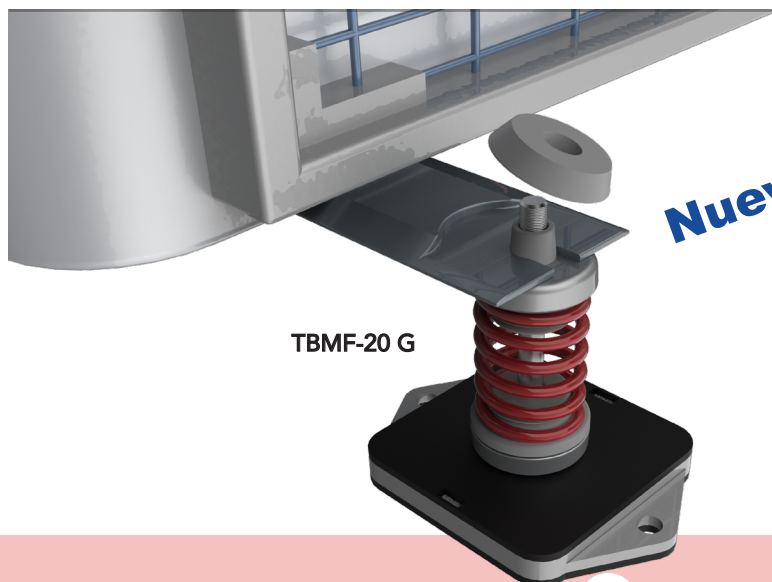
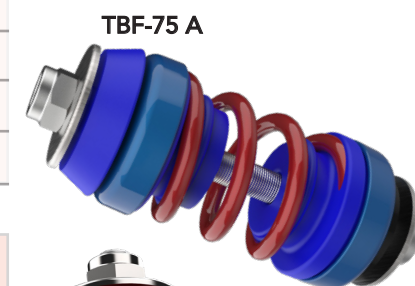
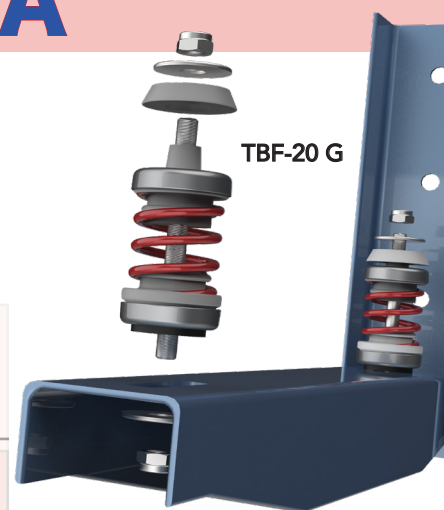

**Nuevo**

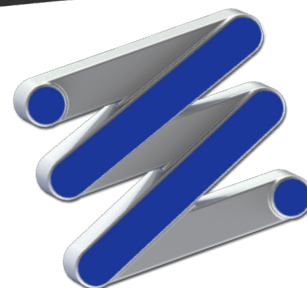

**SEÑOR**

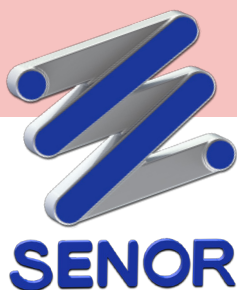

# Tarifa **INDUSTRIA** 2022

## **SPLIT / SEMI-INDUSTRIAL ANTIVUELCO**

<b>Referencia</b>	<b>Carga mínima/máx</b>	<b>P.V €/Ud</b>
Reference	minimum/maximum load	RRP € / Unit
<b>MÁQUINAS SOBRE SUELO / HÍBRIDO</b>		
SE-TBMF-ADAPTA 20 G	<b>Nuevo</b> 3Kg hasta 20Kg	70,16 €
SE-TBMF-ADAPTA 45 V	<b>Nuevo</b> 15Kg hasta 45Kg	70,67 €
SE-TBMF-ADAPTA 75 A	<b>Nuevo</b> 30Kg hasta 75Kg	71,12 €
SE-TBMF-ADAPTA 120 R	<b>Nuevo</b> 60Kg hasta 120Kg	71,51 €

\* Producto para fijar por el exterior de la máquina.



TBMF-ADAPTA 45 V

## **SPLIT / DOMÉSTICO**

<b>MÁQUINAS SOBRE SUELO / HÍBRIDO</b>		
SE-TBM/IX 20 G/M8	3Kg hasta 20Kg	25,19 €
SE-TBM/IX 45 V/M8	15Kg hasta 45Kg	25,90 €
SE-TBM/IX 75 A/M8	30Kg hasta 75Kg	26,64 €
SE-TBM/IX 120 R/M8	60Kg hasta 120Kg	27,00 €



TBM/IX 20 G



TBM/IX 75 A

Fabricante de sistemas **ANTIVIBRATORIOS**

## SPLIT / **DOMÉSTICO**

<b>Referencia</b>	<b>Carga mínima/máx</b>	<b>P.V €/Ud</b>
Reference	minimum/maximum load	RRP € / Unit

### MÁQUINAS SOBRE SUELO / **HÍBRIDO**

SE-TBM/IX 20 G + PT 1	<b>Nuevo</b>	3Kg hasta 20Kg	38,63 €
<b>SE-TBM/IX 45 V + PT 1</b>	<b>Nuevo</b>	15Kg hasta 45Kg	<b>39,35 €</b>
SE-TBM/IX 75 A + PT 1	<b>Nuevo</b>	30Kg hasta 75Kg	40,08 €
<b>SE-TBM/IX 120 R + PT 1</b>	<b>Nuevo</b>	60Kg hasta 120Kg	<b>40,44 €</b>

\* Producto para apoyar unidades de climatización sin escuadras de fijación.

### "ZONA CENTRAL"

SE-TBM/IX 20 G + PT 2	<b>Nuevo</b>	3Kg hasta 20Kg	39,77 €
<b>SE-TBM/IX 45 V + PT 2</b>	<b>Nuevo</b>	15Kg hasta 45Kg	<b>40,48 €</b>
SE-TBM/IX 75 A + PT 2	<b>Nuevo</b>	30Kg hasta 75Kg	41,22 €
<b>SE-TBM/IX 120 R + PT 2</b>	<b>Nuevo</b>	60Kg hasta 120Kg	<b>41,57 €</b>

\* Producto para apoyar unidades de climatización sin escuadras de fijación.



TBM/IX 45 V + PT 1



TBM/IX 120 R + PT 2

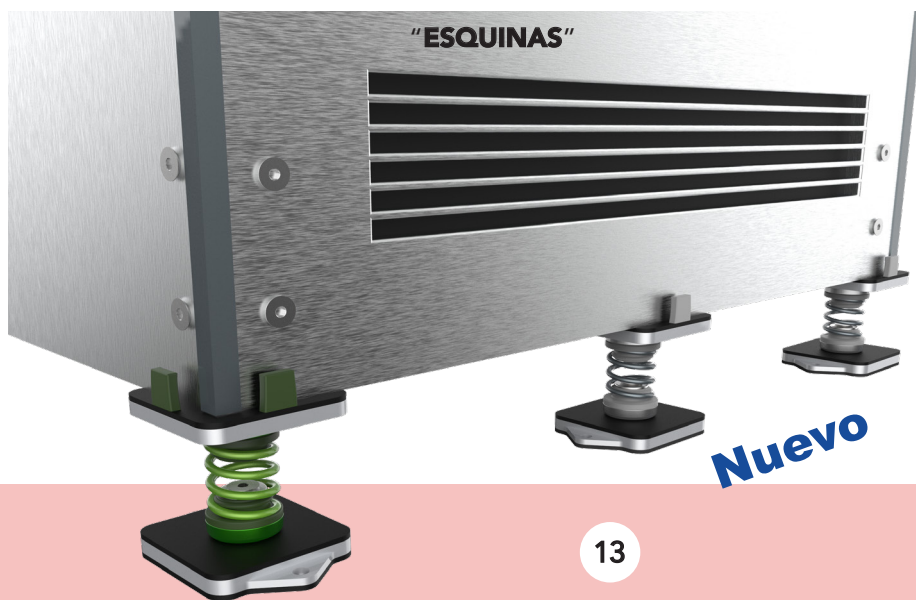

"ESQUINAS"

**Nuevo**

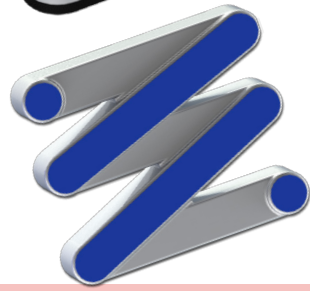

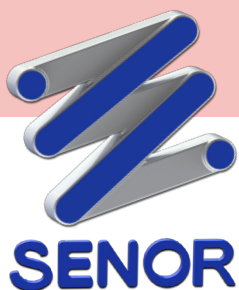

# Tarifa **INDUSTRIA** 2022

## MÁQUINAS / SEMI-INDUSTRIALES **ANTIVUELCO**

Referencia	Carga mínima/máx	P.V €/Ud
Reference	minimum/maximum load	RRP € / Unit

### MÁQUINAS SOBRE SUELO / **HÍBRIDO**

SE-TAV-4000/INOX 40 G	40 G	<b>Nuevo</b>	6Kg hasta 40Kg	192,50 €
SE-TAV-4000/INOX 90 V	90 V	<b>Nuevo</b>	30Kg hasta 90Kg	194,77 €
SE-TAV-4000/INOX 150 A	150 A	<b>Nuevo</b>	60Kg hasta 150Kg	197,04 €
SE-TAV-4000/INOX 240R	240R	<b>Nuevo</b>	120Kg hasta 240Kg	199,31 €

**Productos disponibles en diferentes métricas: 8, 10, 12, 14 & 16.**

SE-TAV-4000-E/INOX 40 G	40 G	<b>Nuevo</b>	6Kg hasta 40Kg	197,04 €
SE-TAV-4000-E/INOX 90 V	90 V	<b>Nuevo</b>	30Kg hasta 90Kg	199,31 €
SE-TAV-4000-E/INOX 150 A	150 A	<b>Nuevo</b>	60Kg hasta 150Kg	201,57 €
SE-TAV-4000-E/INOX 240R	240R	<b>Nuevo</b>	120Kg hasta 240Kg	203,84 €

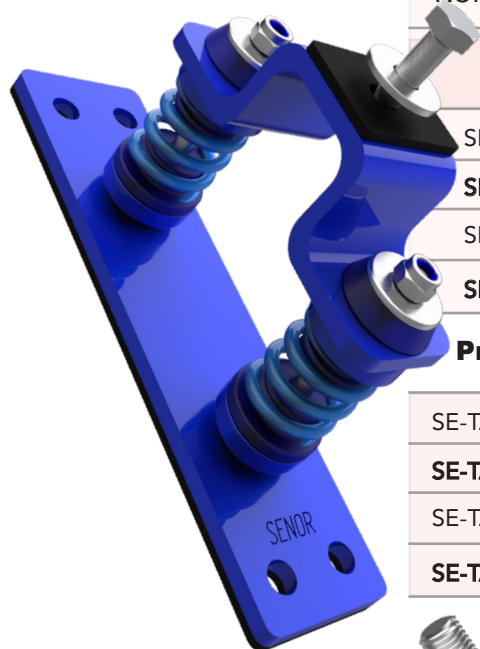

TAV-4000/INOX 150 A  
**Nuevo**

**Nuevo**

TAV-4000-E/INOX 240 R



Fabricante de sistemas **ANTIVIBRATORIOS**

## MÁQUINAS / INDUSTRIALES ANTIVUELCO

Referencia	Carga mínima/máx	P.V €/Ud
Reference	minimum/maximum load	RRP € / Unit

### MÁQUINAS SOBRE SUELO / HÍBRIDO

SE-TAV-8000/INOX 80 G	<b>Nuevo</b>	12Kg hasta 80Kg	227,37 €
SE-TAV-8000/INOX 180 V	<b>Nuevo</b>	60Kg hasta 180Kg	229,98 €
SE-TAV-8000/INOX 300 A	<b>Nuevo</b>	120Kg hasta 300Kg	232,33 €
SE-TAV-8000/INOX 480 R	<b>Nuevo</b>	240Kg hasta 480Kg	234,69 €

### MÁQUINAS SOBRE SUELO / HÍBRIDO

SE-TAV-8000-E/INOX 80 G	<b>Nuevo</b>	12Kg hasta 80Kg	233,04 €
SE-TAV-8000-E/INOX 180 V	<b>Nuevo</b>	60Kg hasta 180Kg	235,65 €
SE-TAV-8000-E/INOX 300 A	<b>Nuevo</b>	120Kg hasta 300Kg	238,00 €
SE-TAV-8000-E/INOX 480 R	<b>Nuevo</b>	240Kg hasta 480Kg	240,36 €

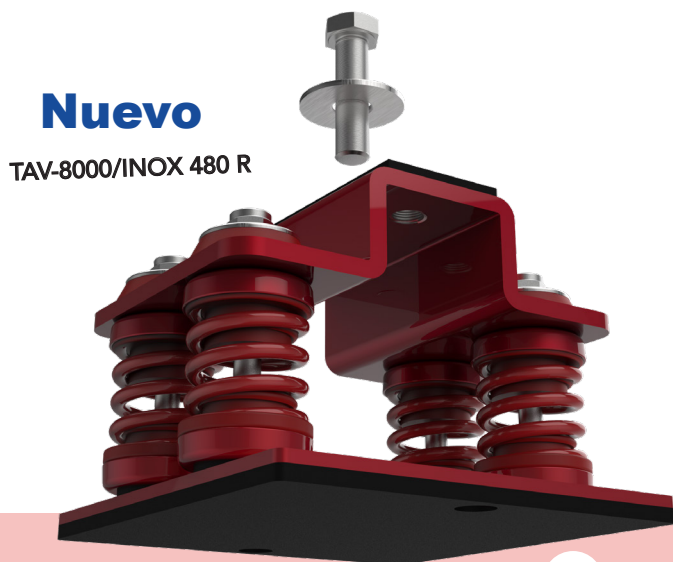
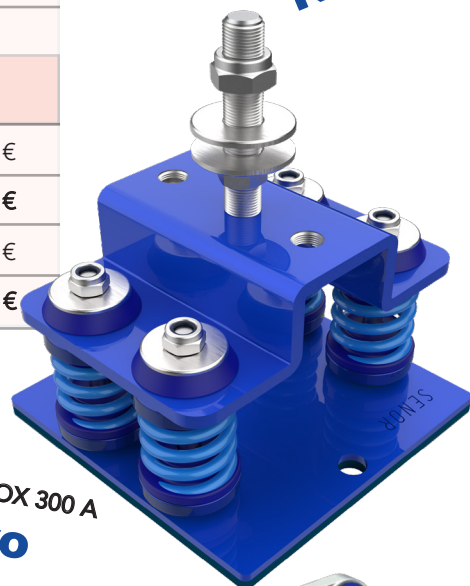
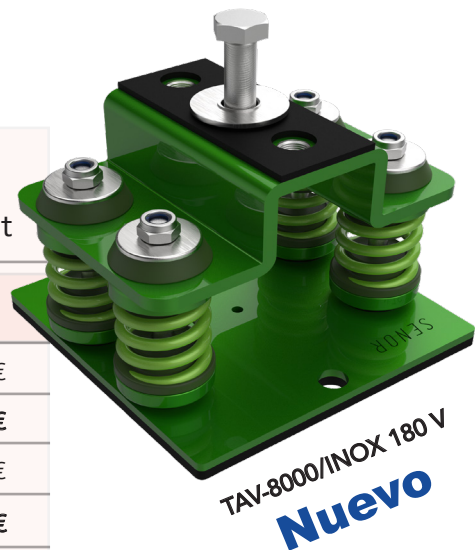

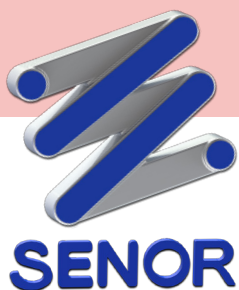

# Tarifa **INDUSTRIA** 2022

## BANCADAS DE INERCIA / **TACOS A RUIDO DE IMPACTO**

TS-80 A 280

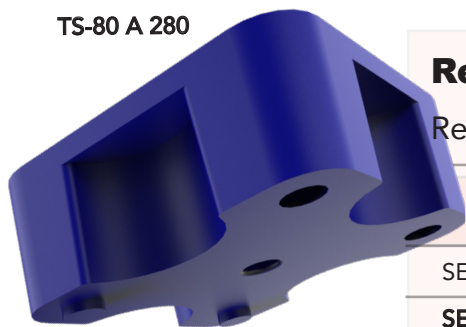

TS-60 R 400

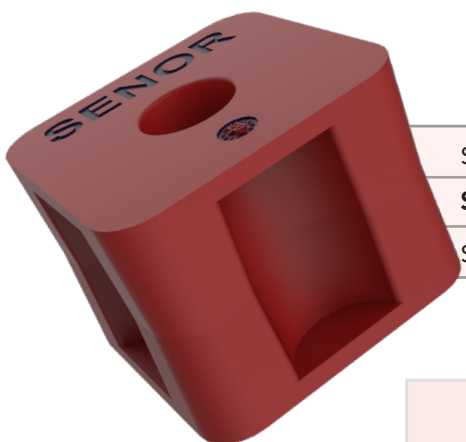

ACV-50/150 V  
**Nuevo**

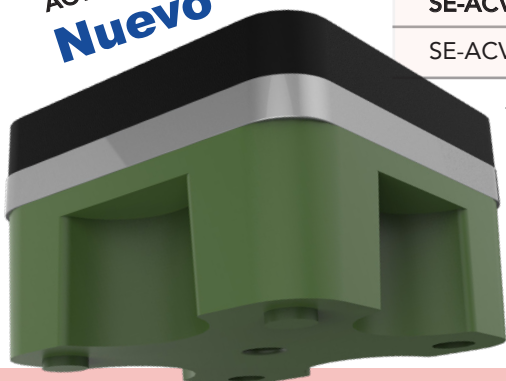

Referencia	Carga mínima/máx	P.V €/Ud
Reference	minimum/maximum load	RRP € / Unit
<b>MODELO TS-80 / GOMA</b>		
SE-TS-80 V 150/16-I	30Kg hasta 150Kg	6,36 €
<b>SE-TS-80 A 280/16-I</b>	<b>140Kg hasta 280Kg</b>	<b>6,74 €</b>
SE-TS-80 R 400/16-I	250Kg hasta 400Kg	7,14 €

\* Dimensiones: 30 mm (altura) x 80 mm (ancho) x 80 mm (fondo).

<b>MODELO TS-60 / GOMA</b>		
SE-TS-60 V 150/25-I	30Kg hasta 150Kg	13,65 €
<b>SE-TS-60 A 280/25-I</b>	<b>140Kg hasta 280Kg</b>	<b>14,39 €</b>
SE-TS-60 R 400/25-I	250Kg hasta 400Kg	15,15 €

\* Dimensiones: 60 mm (altura) x 80 mm (ancho) x 80 mm (fondo).

<b>MODELO ACV-50 / GOMA</b>			
SE-ACV-50/150 V/30-I	<b>Nuevo</b>	30Kg hasta 150Kg	25,87 €
<b>SE-ACV-50/280 A/30-I</b>	<b>Nuevo</b>	<b>140Kg hasta 280Kg</b>	<b>26,20 €</b>
SE-ACV-50/400 R/30-I	<b>Nuevo</b>	250Kg hasta 400Kg	26,55 €

\* Dimensiones: 50 mm (altura) x 80 mm (ancho) x 80 mm (fondo).

\* Formato caja: **16 uds Mod.TS-80**

**25 uds Mod.TS-60** (Pedido mínimo "caja")

**30 uds Mod.ACV-50.**

Fabricante de sistemas **ANTIVIBRATORIOS**



## MÁQUINAS / SEMI-INDUSTRIALES

Referencia	Carga mínima/máx	P.V €/Ud
Reference	minimum/maximum load	RRP € / Unit
<b>SERIE MBS / GOMA</b>		
SE-ACH-150 V	30Kg hasta 150Kg	28,40 €
<b>SE-ACH-280 A</b>	<b>140Kg hasta 280Kg</b>	<b>30,29 €</b>
SE-ACH-400 R	250Kg hasta 400Kg	32,15 €

\* Dimensiones: 42 mm (altura) x 80 mm (ancho) x 80 mm (fondo).

SE-ACV-150 V	30Kg hasta 150Kg	29,29 €
<b>SE-ACV-280 A</b>	<b>140Kg hasta 280Kg</b>	<b>31,22 €</b>
SE-ACV-400 R	250Kg hasta 400Kg	33,16 €

\* Dimensiones: 115 mm (altura) x 80 mm (ancho) x 80 mm (fondo).

SE-BI-150 V	30Kg hasta 150Kg	34,48 €
<b>SE-BI-280 A</b>	<b>140Kg hasta 280Kg</b>	<b>36,41 €</b>
SE-BI-400 R	250Kg hasta 400Kg	38,37 €

\* Dimensiones: 53 mm (altura) x 80 mm (ancho) x 112 mm (fondo).

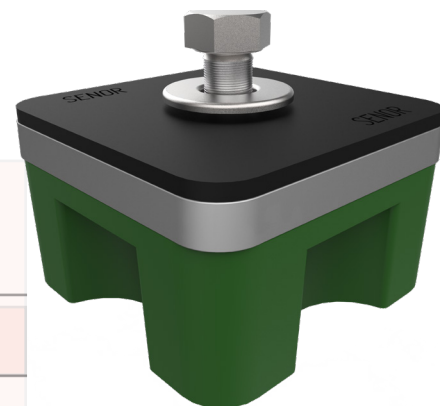

ACH-150/V

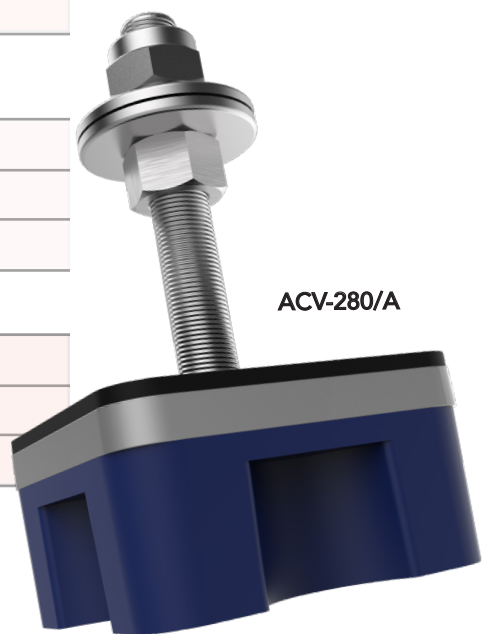

ACV-280/A

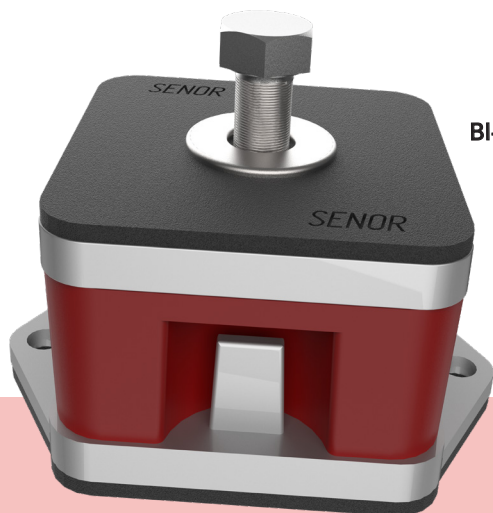

BI-400/R

\* Productos disponibles en diferentes métricas : 8, 10, 12, 14 & 16.

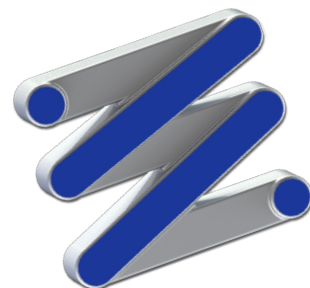

## MÁQUINAS / **SEMI-INDUSTRIALES**



BI-400/R + PT 1

<b>Referencia</b>	<b>Carga mínima/máx</b>	<b>P.V €/Ud</b>
Reference	minimum/maximum load	RRP € / Unit
<b>SERIE MBS / GOMA</b>		
SE-BI-150 V + PT 1	30Kg hasta 150Kg	44,27 €
<b>SE-BI-280 A + PT 1</b>	<b>140Kg hasta 280Kg</b>	<b>46,19 €</b>
SE-BI-400 R + PT 1	250Kg hasta 400Kg	48,16 €
* Dimensiones: 53 mm (altura) x 80 mm (ancho) x 112 mm (fondo).		
SE-BI-150 V + PT 2	30Kg hasta 150Kg	44,73 €
<b>SE-BI-280 A + PT 2</b>	<b>140Kg hasta 280Kg</b>	<b>46,68 €</b>
SE-BI-400 R + PT 2	250Kg hasta 400Kg	48,62 €
* Dimensiones: 53 mm (altura) x 80 mm (ancho) x 112 mm (fondo).		
SE-BIE-150 V	30Kg hasta 150Kg	37,91 €
<b>SE-BIE-280 A</b>	<b>140Kg hasta 280Kg</b>	<b>39,86 €</b>
SE-BIE-400 R	250Kg hasta 400Kg	41,84 €

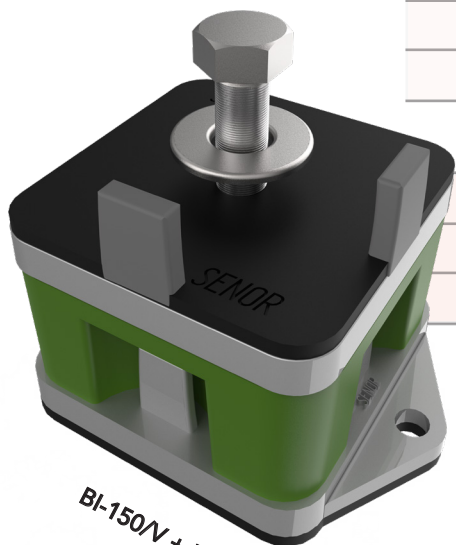

BI-150/V + PT 2

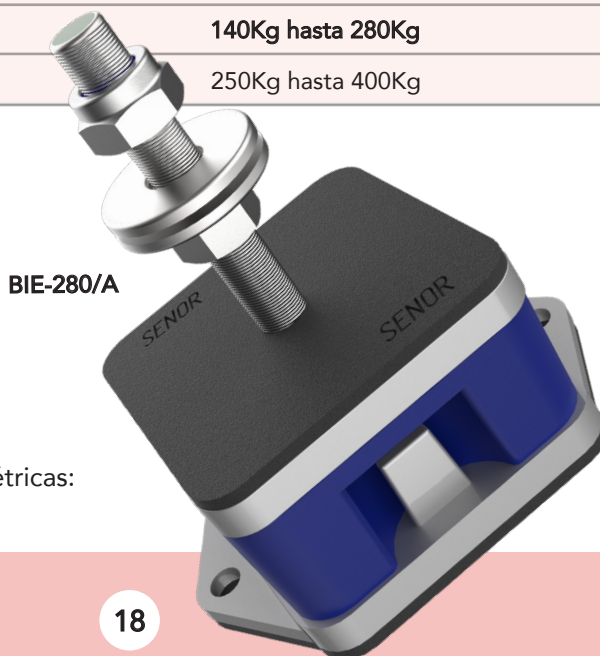

BIE-280/A

\* Productos disponibles en diferentes métricas:  
8, 10, 12, 14 & 16.

## MÁQUINAS / SEMI-INDUSTRIALES

<b>Referencia</b>	<b>Carga mínima/máx</b>	<b>P.V €/Ud</b>
Reference	minimum/maximum load	RRP € / Unit
<b>SERIE MBS / GOMA</b>		
SE-BIR-150 V	30Kg hasta 150Kg	45,21 €
<b>SE-BIR-280 A</b>	<b>140Kg hasta 280Kg</b>	<b>48,95 €</b>
SE-BIR-400 R	250Kg hasta 400Kg	52,65 €

\* **Dimensiones:** 95 mm (altura) x 80 mm (ancho) x 112 mm (fondo).

SE-BIR-150 V + PT 1	30Kg hasta 150Kg	55,53 €
<b>SE-BIR-280 A + PT 1</b>	<b>140Kg hasta 280Kg</b>	<b>59,26 €</b>
SE-BIR-400 R + PT 1	250Kg hasta 400Kg	62,97 €

\* **Dimensiones:** 95 mm (altura) x 80 mm (ancho) x 112mm (fondo).

SE-BIR-150 V + PT 2	30Kg hasta 150Kg	56,66 €
<b>SE-BIR-280 A + PT 2</b>	<b>140Kg hasta 280Kg</b>	<b>60,39 €</b>
SE-BIR-400 R + PT 2	250Kg hasta 400Kg	64,11 €

\* Productos con sistema de nivelación. Permite regular hasta 3cm.

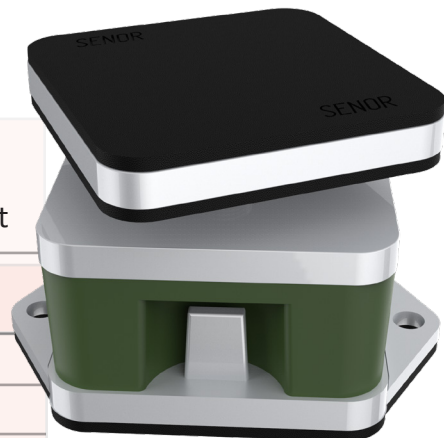

**BIR-150/V**

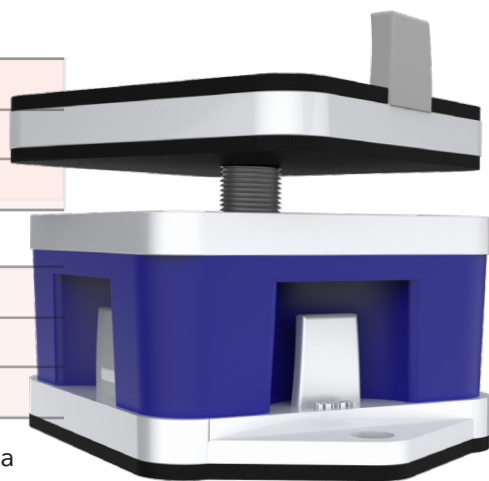

**BIR-280/A + PT 1**

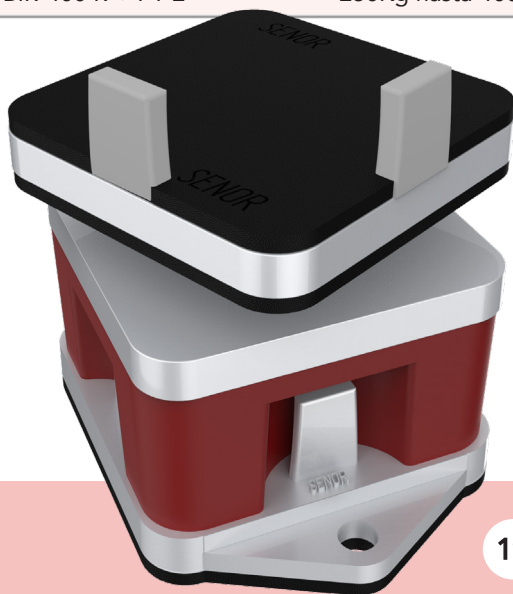

**BIR-400/R + PT 2**

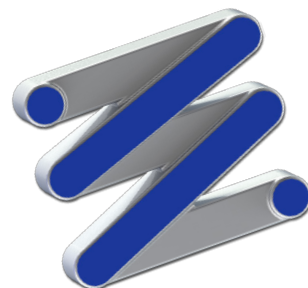

# SENOR

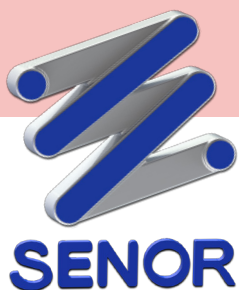

# Tarifa **INDUSTRIA** 2022

## MÁQUINAS SUELO / **SEMI-INDUSTRIALES**

Referencia	Carga mínima/máx	P.V €/Ud
Reference	minimum/maximum load	RRP € / Unit

### SERIE MBS / **GOMA**

SE-BIRE-150 V	30Kg hasta 150Kg	48,64 €
SE-BIRE-280 A	140Kg hasta 280Kg	52,39 €
SE-BIRE-400 R	250Kg hasta 400Kg	56,10 €

\* Dimensiones: 115 mm (altura) x 80 mm (ancho) x 112 mm (fondo).

\* **Productos disponibles en diferentes métricas:** 8, 10, 12, 14 & 16.

## MÁQUINAS / **INDUSTRIALES**

### MÁQUINAS SOBRE SUELO / **GOMA**

#### Serie BI/THREE

SE-BI/THREE-450 V	<b>Nuevo</b>	90Kg hasta 450Kg	382,89 €
SE-BI/THREE-840 A	<b>Nuevo</b>	420Kg hasta 840Kg	385,72 €
SE-BI/THREE-1200 R	<b>Nuevo</b>	750Kg hasta 1200Kg	388,44 €

BI/THREE-450 V

**Nuevo**

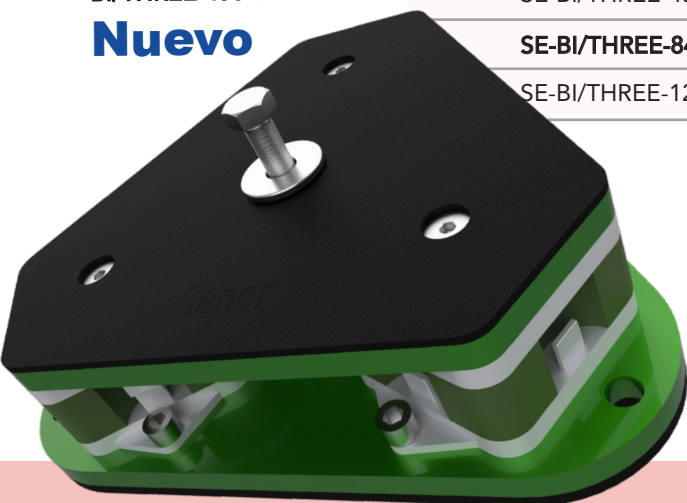

SEÑOR

**Nuevo**

BI/THREE-1200 R

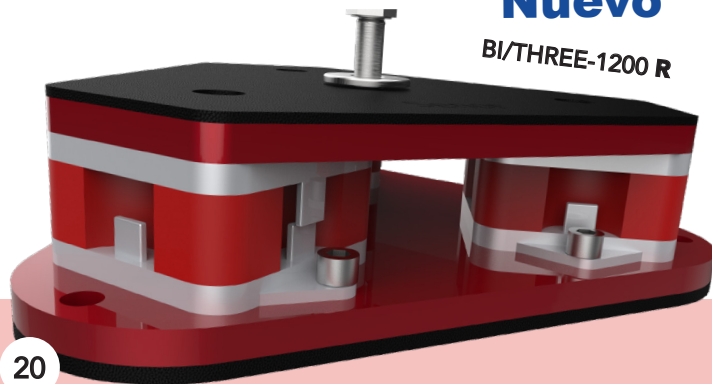

Fabricante de sistemas **ANTIVIBRATORIOS**

## MÁQUINAS / INDUSTRIALES

Referencia	Carga mínima/máx	P.V €/Ud
Reference	minimum/maximum load	RRP € / Unit

### MÁQUINAS SOBRE SUELO / GOMA

#### Serie BI/THREE

SE-BI/THREE-450 EV	<b>Nuevo</b>	90Kg hasta 450Kg	394,23 €
SE-BI/THREE-840 EA	<b>Nuevo</b>	420Kg hasta 840Kg	397,06 €
SE-BI/THREE-1200 ER	<b>Nuevo</b>	750Kg hasta 1200Kg	399,78 €

\* **Productos disponibles en diferentes métricas:** 8, 10, 12, 14 & 16.

## MÁQUINAS / INDUSTRIALES

### MÁQUINAS SOBRE SUELO / HÍBRIDO

#### Serie BM80/INOX

SE-BM-80/IX 80 G	20Kg hasta 80Kg	89,13 €
SE-BM-80/IX 120 V	50Kg hasta 120Kg	90,26 €
SE-BM-80/IX 160 A	75Kg hasta 160Kg	91,35 €
SE-BM-80/IX 200 R	90Kg hasta 200Kg	92,46 €

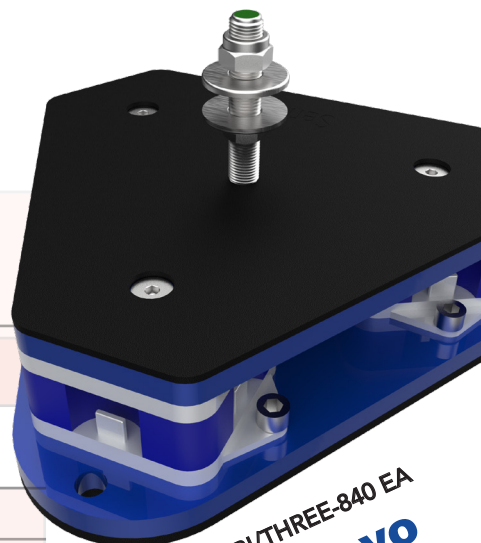

BI/THREE-840 EA  
**Nuevo**

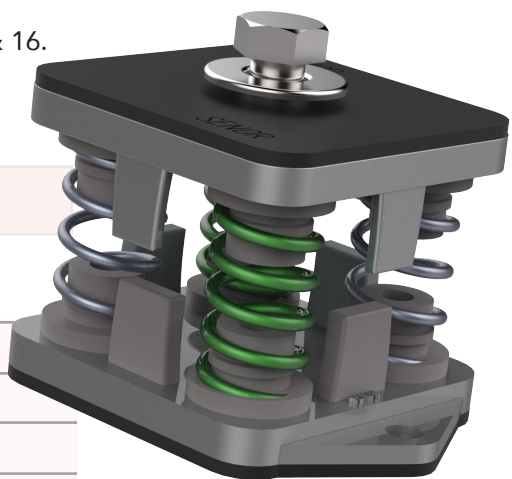

BM-80/IX 80 G

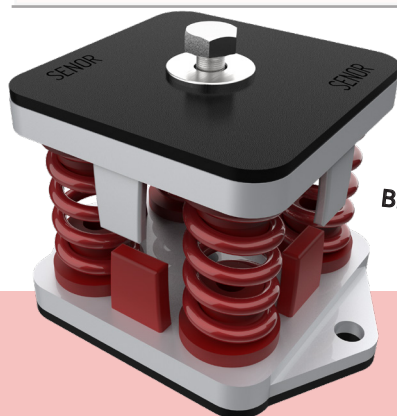

BM-80/IX 200 R

\* Dimensiones:

- 70 mm (altura).
- 80 mm (ancho).
- 112 mm. (fondo).

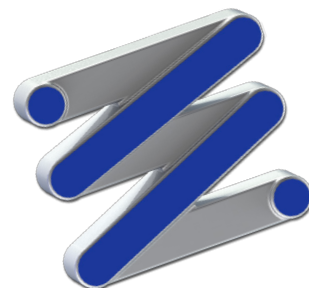

## MÁQUINAS / INDUSTRIALES

Referencia	Carga mínima/máx	P.V €/Ud
Reference	minimum/maximum load	RRP € / Unit

### MÁQUINAS SOBRE SUELO / HÍBRIDO

#### Serie BM-80/INOX

SE-BM-80/IX EG 80	20Kg hasta 80Kg	92,58 €
<b>SE-BM-80/IX EV 120</b>	<b>50Kg hasta 120Kg</b>	<b>93,69 €</b>
SE-BM-80/IX EA 160	75Kg hasta 160Kg	94,80 €
<b>SE-BM-80/IX ER 200</b>	<b>90Kg hasta 200Kg</b>	<b>95,91 €</b>
SE-BM-80/IX REG 80	20Kg hasta 80Kg	105,09 €
<b>SE-BM-80/IX REV 120</b>	<b>50Kg hasta 120Kg</b>	<b>106,24 €</b>
SE-BM-80/IX REA 160	75Kg hasta 160Kg	107,30 €
<b>SE-BM-80/IX RER 200</b>	<b>90Kg hasta 200Kg</b>	<b>108,42 €</b>
<b>* Productos disponibles en diferentes métricas: 8, 10, 12, 14 &amp; 16.</b>		
SE-BM-80/IX RG 80	20Kg hasta 80Kg	101,68 €
<b>SE-BM-80/IX RV 120</b>	<b>50Kg hasta 120Kg</b>	<b>102,77 €</b>
SE-BM-80/IX RA 160	75Kg hasta 160Kg	103,88 €
<b>SE-BM-80/IX RR 200</b>	<b>90Kg hasta 200Kg</b>	<b>104,98 €</b>

\* Productos con sistema de nivelación.

**BM-80/INOX RR 200**



**BM-80/INOX EV 120**

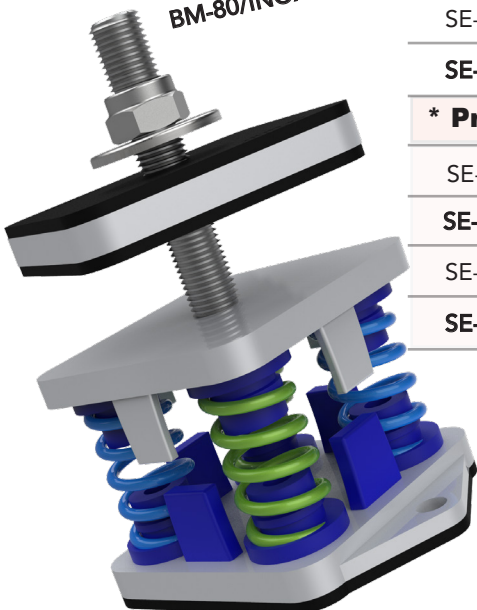

**BM-80/INOX REA 160**



## MÁQUINAS / INDUSTRIALES

Referencia	Carga mínima/máx	P.V €/Ud
Reference	minimum/maximum load	RRP € / Unit

## MÁQUINAS SOBRE SUELO / HÍBRIDO

### Serie BM80/INOX

SE-BM-80/IX RG 80 + PT 1	<b>Nuevo</b>	20Kg hasta 80Kg	111,99 €
SE-BM-80/IX RV 120 + PT 1	<b>Nuevo</b>	50Kg hasta 120Kg	113,09 €
SE-BM-80/IX RA 160 + PT 1	<b>Nuevo</b>	75Kg hasta 160Kg	114,21 €
SE-BM-80/IX RR 200 + PT 1	<b>Nuevo</b>	90Kg hasta 200Kg	115,31 €

\* **Productos disponibles en diferentes métricas:** 12, 14 & 16.

SE-BM-80/IX RG 80 + PT 2	<b>Nuevo</b>	20Kg hasta 80Kg	113,12 €
SE-BM-80/IX RV 120 + PT 2	<b>Nuevo</b>	50Kg hasta 120Kg	114,22 €
SE-BM-80/IX RA 160 + PT 2	<b>Nuevo</b>	75Kg hasta 160Kg	115,35 €
SE-BM-80/IX RR 200 + PT 2	<b>Nuevo</b>	90Kg hasta 200Kg	116,44 €

\* Productos con sistema de nivelación.

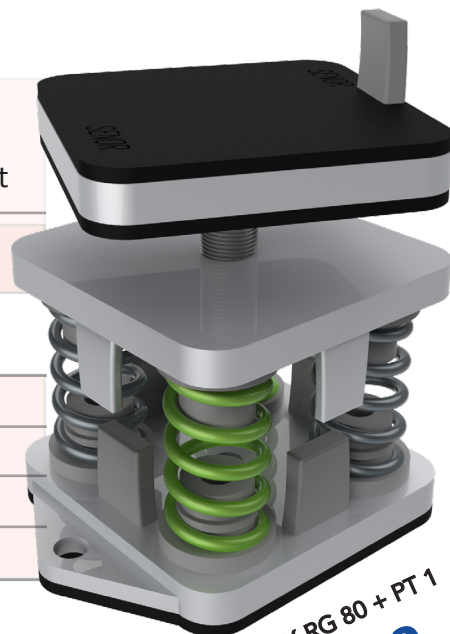

BM-80/IX RG 80 + PT 1  
**Nuevo**



**Nuevo**  
BM-80/IX RV 80 + PT 2



**SENOR**

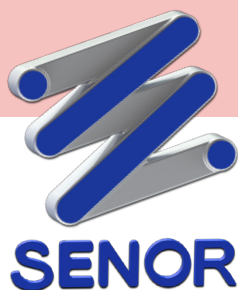

# Tarifa **INDUSTRIA** 2022

## MÁQUINAS / **INDUSTRIALES**

BM-100/INOX 150 G

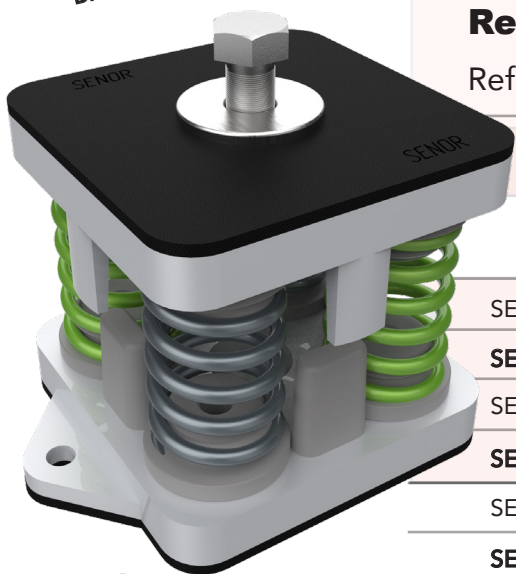

Referencia	Carga mínima/máx	P.V €/Ud
Reference	minimum/maximum load	RRP € / Unit

## MÁQUINAS SOBRE SUELO / **HÍBRIDO**

### Serie BM100/INOX

SE-BM-100/IX 150 G	40Kg hasta 150Kg	115,56 €
<b>SE-BM-100/IX 250 V</b>	<b>120Kg hasta 250Kg</b>	<b>116,70 €</b>
SE-BM-100/IX 330 A	200Kg hasta 330Kg	120,01 €
<b>SE-BM-100/IX 500 R</b>	<b>280Kg hasta 500Kg</b>	<b>121,16 €</b>
SE-BM-100/IX EG 150	40Kg hasta 150Kg	119,02 €
<b>SE-BM-100/IX EV 250</b>	<b>120Kg hasta 250Kg</b>	<b>120,28 €</b>
SE-BM-100/IX EA 330	200Kg hasta 330Kg	123,50 €
<b>SE-BM-100/IX ER 500</b>	<b>280Kg hasta 500Kg</b>	<b>124,60 €</b>

\* **Productos disponibles en diferentes métricas:** 8, 10, 12, 14 & 16.

SE-BM-100/IX REG 150	40Kg hasta 150Kg	131,53 €
<b>SE-BM-100/IX REV 250</b>	<b>120Kg hasta 250Kg</b>	<b>132,63 €</b>
SE-BM-100/IX REA 330	200Kg hasta 330Kg	135,98 €
<b>SE-BM-100/IX RER 500</b>	<b>280Kg hasta 500Kg</b>	<b>137,11 €</b>

\* Productos con sistema de nivelación.

BM-100/INOX EV 250

BM-100/INOX REA 330

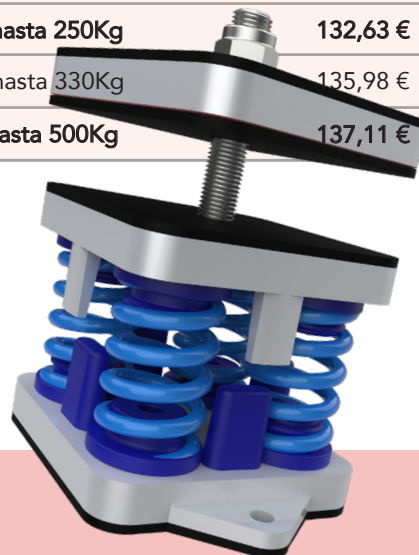
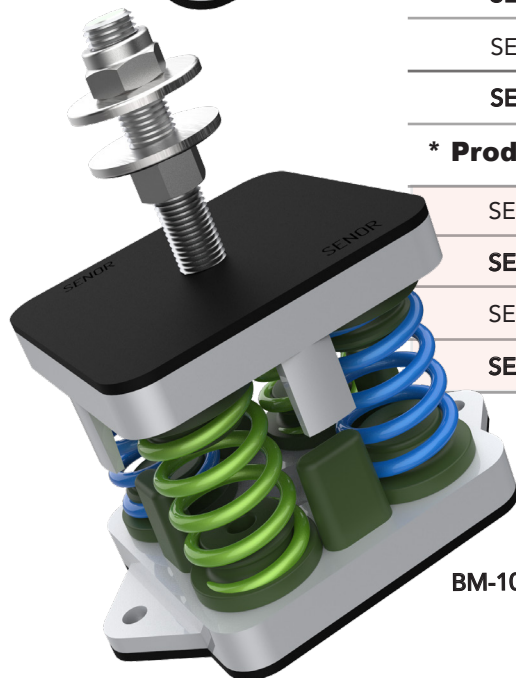

Fabricante de sistemas **ANTIVIBRATORIOS**



## MÁQUINAS / INDUSTRIALES

Referencia	Carga mínima/máx	P.V €/Ud
Reference	minimum/maximum load	RRP € / Unit

### MÁQUINAS SOBRE SUELO / **HÍBRIDO**

#### Serie BM100/INOX

SE-BM-100/IX RG 150	40Kg hasta 150Kg	128,08 €
<b>SE-BM-100/IX RV 250</b>	<b>120Kg hasta 250Kg</b>	<b>129,21 €</b>
SE-BM-100/IX RA 330	200Kg hasta 330Kg	132,54 €
<b>SE-BM-100/IX RR 500</b>	<b>280Kg hasta 500Kg</b>	<b>133,65 €</b>
SE-BM-100/IX RG 150 + PT 1	<b>Nuevo</b> 40Kg hasta 150Kg	138,41 €
<b>SE-BM-100/IX RV 250 + PT 1</b>	<b>Nuevo</b> 120Kg hasta 250Kg	<b>139,53 €</b>
SE-BM-100/IX RA 330 + PT 1	<b>Nuevo</b> 200Kg hasta 330Kg	142,86 €
<b>SE-BM-100/IX RR 500 + PT 1</b>	<b>Nuevo</b> 280Kg hasta 500Kg	<b>143,97 €</b>

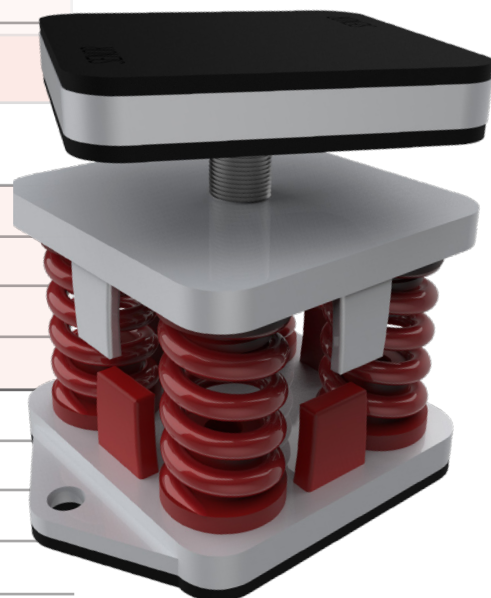

BM-100/INOX RR 500

\* Productos con sistema de nivelación.

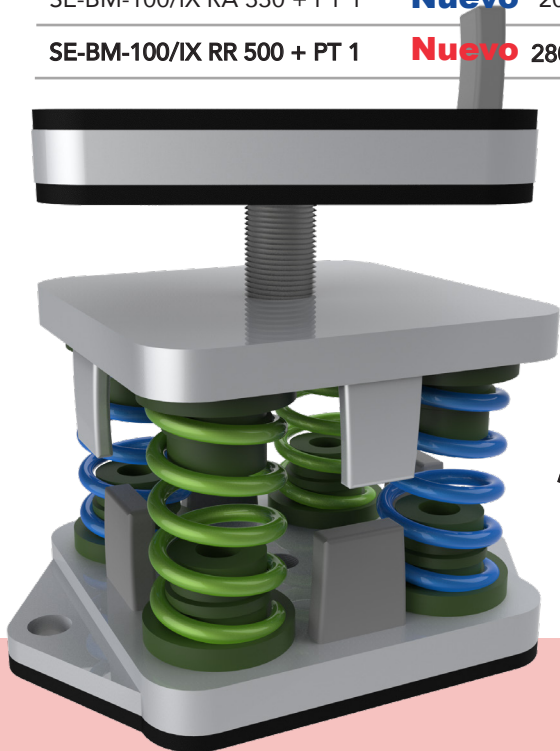

**Nuevo**  
BM-100/INOX RV 250 + PT 1



**SEÑOR**

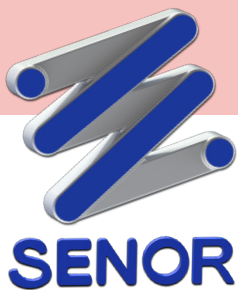

# Tarifa **INDUSTRIA** 2022

## MÁQUINAS / INDUSTRIALES



**Nuevo**

BM-100/INOX RA 330 + PT 2

Referencia	Carga mínima/máx	P.V €/Uds
Reference	minimum/maximum load	RRP € / Unit

### MÁQUINAS SOBRE SUELO / HÍBRIDO

#### Serie BM-100/INOX

SE-BM-100/IX RG 150 + PT 2	<b>Nuevo</b>	40Kg hasta 150Kg	139,54 €
SE-BM-100/IX RV 250 + PT 2	<b>Nuevo</b>	120Kg hasta 250Kg	140,66 €
SE-BM-100/IX RA 330 + PT 2	<b>Nuevo</b>	200Kg hasta 330Kg	143,99 €
SE-BM-100/IX RR 500 + PT 2	<b>Nuevo</b>	280Kg hasta 500Kg	145,10 €

\* Productos con sistemas de nivelación.

\* **Productos disponibles en diferentes métricas:** 12, 14 & 16.

### MÁQUINAS SUELO / HÍBRIDO ANTI VUELCO

#### Serie BMF-100/ANTV

SE-BMF-100 G 150 ANTV	<b>Nuevo</b>	40Kg hasta 150Kg	234,65 €
SE-BMF-100 V 250 ANTV	<b>Nuevo</b>	120Kg hasta 250Kg	235,76 €
SE-BMF-100 A 330 ANTV	<b>Nuevo</b>	200Kg hasta 330Kg	236,88 €
SE-BMF-100 R 500 ANTV	<b>Nuevo</b>	280Kg hasta 500Kg	238,00 €

**Nuevo**

BMF-100 R 500 ANTV

**Nuevo**

BMF-100 A 330 ANTV

Fabricante de sistemas **ANTIVIBRATORIOS**

## MÁQUINAS / INDUSTRIALES DE GRAN TONELAJE

Referencia	Carga mínima/máx	P.V €/Ud
Reference	minimum/maximum load	RRP € / Unit

## MÁQUINAS SOBRE SUELO / HÍBRIDO **ANTI VUELCO**

### Serie BMF/SHOCK ABSORBER

SE-BMF-SAI/300 G	<b>Nuevo</b>	150Kg hasta 300Kg	1131,65 €
SE-BMF-SAI/675 V	<b>Nuevo</b>	280Kg hasta 675Kg	1138,85 €
SE-BMF-SAI/1125 A	<b>Nuevo</b>	600Kg hasta 1.125Kg	1304,62 €
SE-BMF-SAI/1800 R	<b>Nuevo</b>	975Kg hasta 1.800Kg	1326,26 €

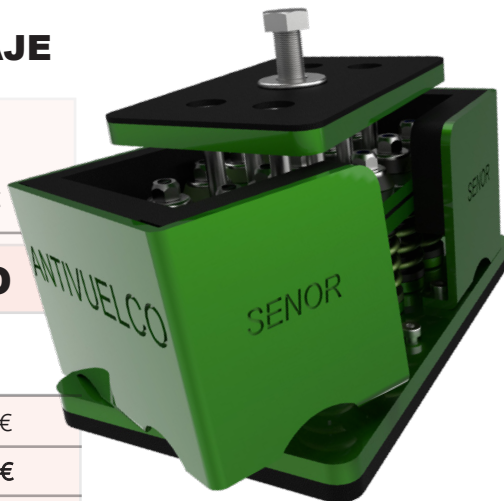

**Nuevo**  
BMF-SAI/720 V

\* **Productos disponibles en diferentes métricas:** 12, 14,16,18 & 20.

## MÁQUINAS SOBRE SUELO / **HÍBRIDO**

### Serie SAB/SHOCK ABSORBER

SE-SAB-3 G	120Kg hasta 450Kg	616,17 €
SE-SAB-3 V	360Kg hasta 750Kg	629,72 €
SE-SAB-3 A	600Kg hasta 990Kg	641,78 €
SE-SAB-3 R	840Kg hasta 1.500Kg	655,35 €

\* Productos con sistema de nivelación.

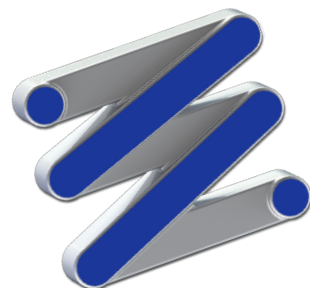
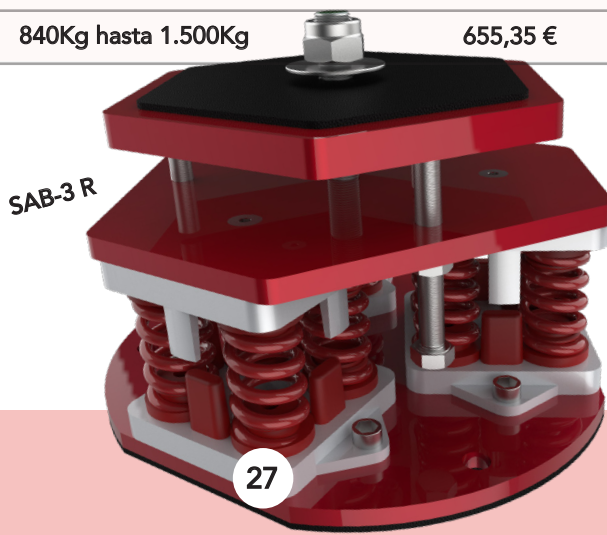

**SEÑOR**

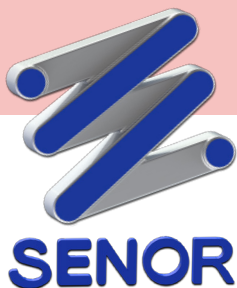

# Tarifa **INDUSTRIA** 2022

MÁQUINAS / INDUSTRIALES DE GRAN TONELAJE

SAB-4 V

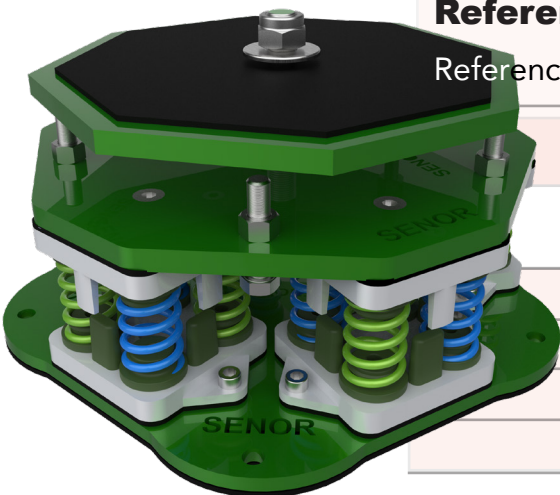

Referencia	Carga mínima/máx	P.V €/Ud
Reference	minimum/maximum load	RRP € / Unit

## MÁQUINAS SOBRE SUELO / **HÍBRIDO**

### Serie SAB/SHOCK ABSORBER

SE-SAB-4 G	160Kg hasta 600Kg	733,68 €
SE-SAB-4 V	480Kg hasta 1.000Kg	747,23 €
SE-SAB-4 A	800Kg hasta 1.320Kg	760,77 €
SE-SAB-4 R	1.120Kg hasta 2.000Kg	772,85 €

\* **Productos disponibles en diferentes métricas:** 12, 14,16,18 & 20.

SAB-5 A

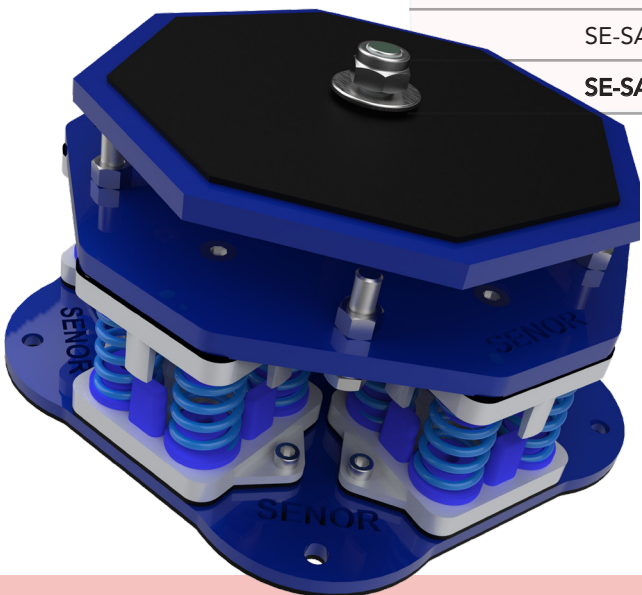

SE-SAB-5 G	200Kg hasta 750Kg	998,81 €
SE-SAB-5 V	600Kg hasta 1.250Kg	1010,86 €
SE-SAB-5 A	1.000Kg hasta 1.650Kg	1022,91 €
SE-SAB-5 R	1.400Kg hasta 2.500Kg	1036,44 €

SAB-5 G

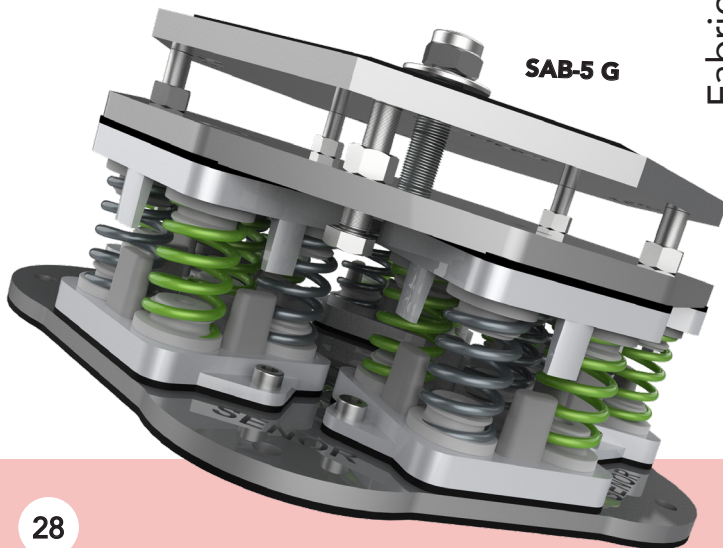

Fabricante de sistemas **ANTIVIBRATORIOS**



## MÁQUINAS / INDUSTRIALES DE GRAN TONELAJE

\* Tratamiento de vibraciones en **TORRE DE REFRIGERACIÓN**.  
Todos los productos se pueden fabricar según la tipología del perfil estructural que se requiera.

(Perfil tubular, viga IP, IPN, HEA, HEB, etc...).



**SEÑOR**

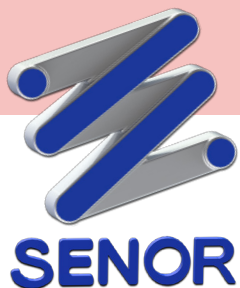

# Tarifa **INDUSTRIA** 2022

## MÁQUINAS / INDUSTRIALES DE **GRAN TONELAJE**

Referencia	Carga mínima/máx	P.V €/Ud
Reference	minimum/maximum load	RRP € / Unit

## MÁQUINAS SUELO / HÍBRIDO **ANTI VUELCO**

### Serie EIGHT-TBF/ANTV

SE-EIGHT-TBF 160 G	60Kg hasta 160Kg	231,44 €
SE-EIGHT-TBF 360 V	125Kg hasta 360Kg	234,39 €
SE-EIGHT-TBF 600 A	285Kg hasta 600Kg	237,63 €
SE-EIGHT-TBF 1000 R	525Kg hasta 1.000Kg	258,80 €

\* **Productos disponibles en diferentes métricas:** 12, 14,16,18 & 20.

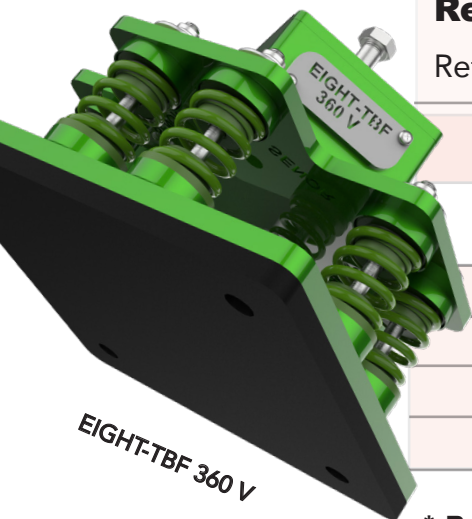

EIGHT-TBF 1000 R



EIGHT-TBF 600 A

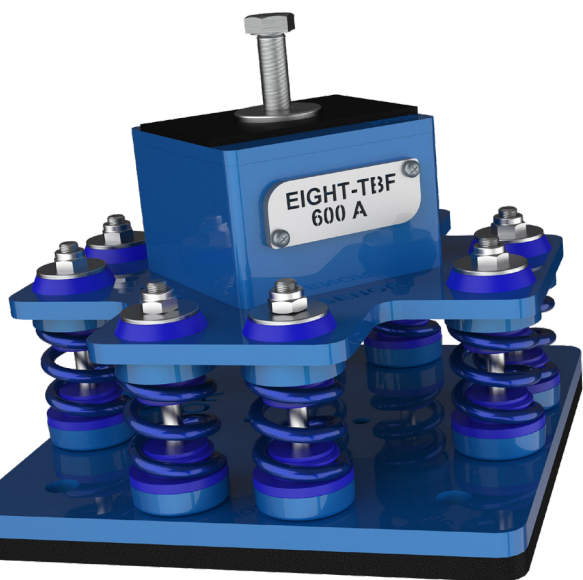

Fabricante de sistemas **ANTIVIBRATORIOS**

# Tarifa **INDUSTRIA** **2022**

\*SENOR Aisladores Acústicos

Serie **TEN & EIGHT-TBF/ANTV**



MÁQUINAS / **INDUSTRIALES DE**  
**GRAN TONELAJE**

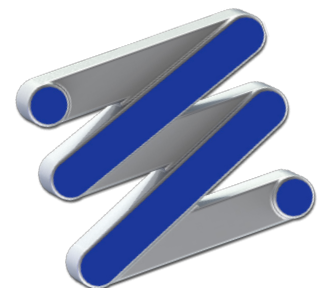

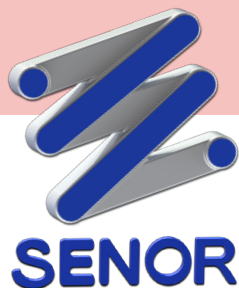

# Tarifa **INDUSTRIA** 2022

## MÁQUINAS / INDUSTRIALES DE **GRAN TONELAJE**

Referencia	Carga mínima/máx	P.V €/Ud
Reference	minimum/maximum load	RRP € / Unit

### MÁQUINAS SUELO / HÍBRIDO **ANTI VUELCO**

#### Serie TEN-TBF/ANTV

SE-TEN-TBF 1200 R	<b>Nuevo</b>	680Kg hasta 1.200Kg	277,25 €
SE-TEN-TBF 1400 R	<b>Nuevo</b>	800Kg hasta 1.400Kg	348,98 €
SE-TEN-TBF 1600 R	<b>Nuevo</b>	950Kg hasta 1.600Kg	418,68 €

\* **Productos disponibles en diferentes métricas:** 12,14,16,18 & 20.



TEN-TBF 1400 R

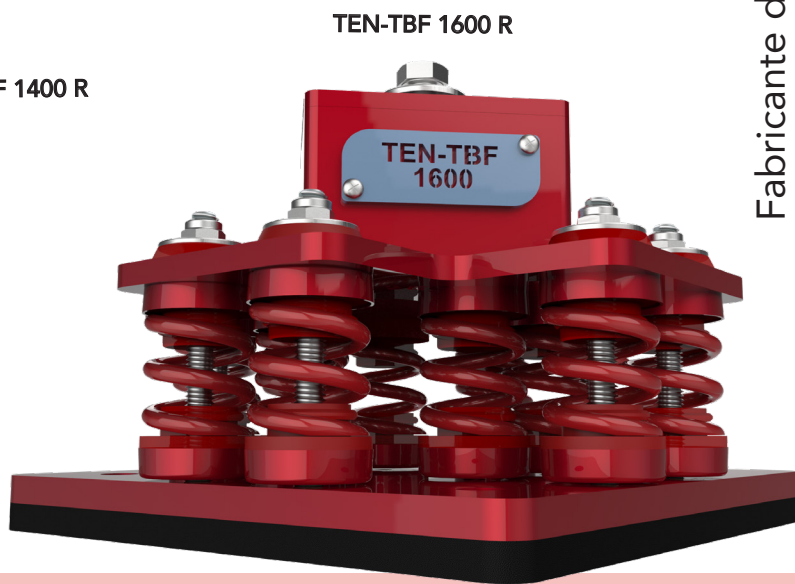

TEN-TBF 1600 R

Fabricante de sistemas **ANTIVIBRATORIOS**



## MÁQUINAS / INDUSTRIALES DE **GRAN TONELAJE**

<b>Referencia</b>	<b>Carga mínima/máx</b>	<b>P.V €/Ud</b>
Reference	minimum/maximum load	RRP € / Unit

## MÁQUINAS SUELO / HÍBRIDO **ANTI VUELCO**

### Serie 2x TEN-TBF/ANTV

SE-2x TEN-TBF 1200 R	<b>Nuevo</b>	1.360Kg hasta 2.400Kg	622,53 €
SE-2x TEN-TBF 1400 R	<b>Nuevo</b>	1.600Kg hasta 2.800Kg	766,00 €
SE-2x TEN-TBF 1600 R	<b>Nuevo</b>	1.900Kg hasta 3.200Kg	905,40 €



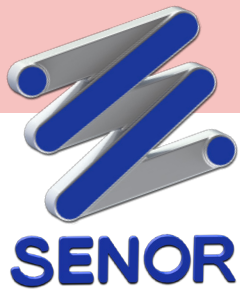

# Tarifa **INDUSTRIA** **2022**

Serie 2x **TEN-TBF/ANTV**



Fabricante de sistemas **ANTIVIBRATORIOS**

MÁQUINAS / **INDUSTRIALES DE GRAN TONELAJE**

## PLACAS DE ANCLAJE SOBRE MURO / **ACÚSTICAS**

<b>Referencia</b>	<b>Carga mínima/máx</b>	<b>P.V €/Ud</b>
Reference	minimum/maximum load	RRP € / Unit

### ESTRUCTURAS METÁLICAS / **ANTIVUELCO**

#### Serie PLM VERTICAL

SE-PLM VERTICAL-200 V-TB	<b>Nuevo</b>	50Kg hasta 200Kg	289,58 €
SE-PLM VERTICAL-500 A-TB	<b>Nuevo</b>	200Kg hasta 500Kg	313,18 €
SE-PLM VERTICAL-800 R-HEA	<b>Nuevo</b>	400Kg hasta 800Kg	431,97 €
SE-PLM VERTICAL-1600 R-HEB	<b>Nuevo</b>	750Kg hasta 1.600Kg	589,58 €

\* Todos los productos se pueden fabricar según la tipología del perfil estructural que se requiera. (Perfil **tubular**, viga **IP, IPN, HEA, HEB**, etc.)

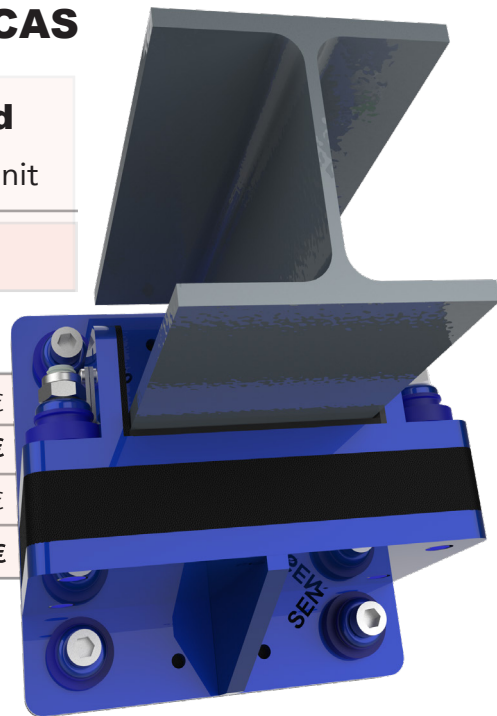

PLM VERTICAL-500 A-HEA  
**Nuevo**

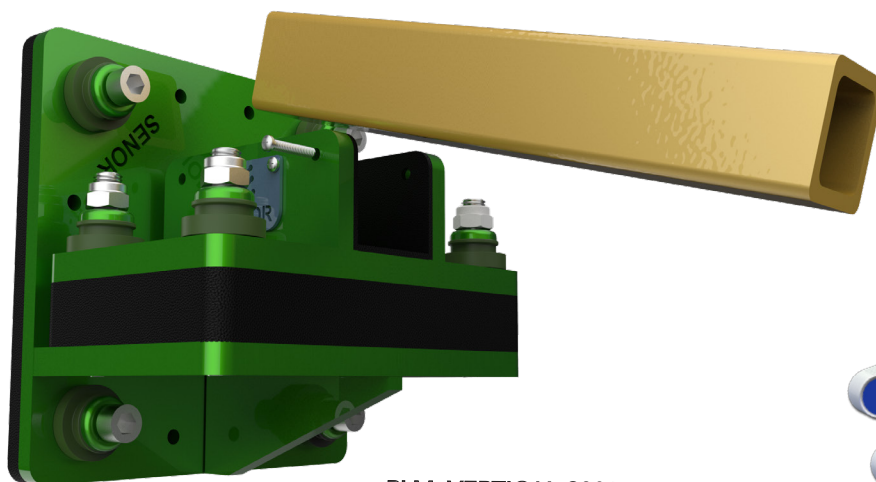

PLM VERTICAL-200 V-TB  
**Nuevo**



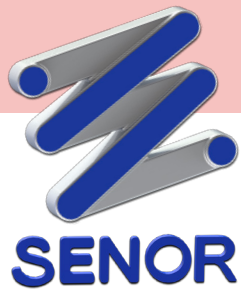

# Tarifa **INDUSTRIA** **2022**

PLACAS DE ANCLAJE SOBRE MURO / **ACÚSTICAS**



Serie **PLM VERTICAL**

Fabricante de sistemas **ANTIVIBRATORIOS**

# Tarifa **INDUSTRIA** **2022**

\*SENOR Aisladores Acústicos

## Serie **PLM VERTICAL**



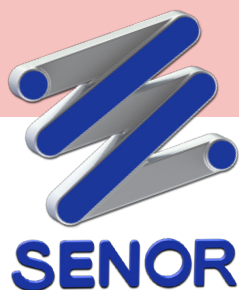

# Tarifa **INDUSTRIA** 2022

## PLACAS DE ANCLAJE SOBRE SUELO / **ACÚSTICAS**

Referencia	Carga mínima/máx	P.V €/Ud
Reference	minimum/maximum load	RRP € / Unit

## ESTRUCTURAS METÁLICAS / **ANTIVUELCO**

### Serie PLM SUELO.

SE-PLM/PSC-120 V-TUBULAR	<b>Nuevo</b>	50Kg hasta 120Kg	187,52 €
SE-PLM/PSC-150 A-TUBULAR	<b>Nuevo</b>	80Kg hasta 150Kg	193,19 €
SE-PLM/PSC-180 R-TUBULAR	<b>Nuevo</b>	100Kg hasta 180Kg	199,02 €
SE-PLM/PST-400 V-TUBULAR	<b>Nuevo</b>	150Kg hasta 400Kg	204,69 €
SE-PLM/PST-600 A-TUBULAR	<b>Nuevo</b>	300Kg hasta 600Kg	250,05 €
SE-PLM/PST-800 R-TUBULAR	<b>Nuevo</b>	500Kg hasta 800Kg	318,55 €

**Nuevo**  
PLM/PSC-120 V-TUBULAR

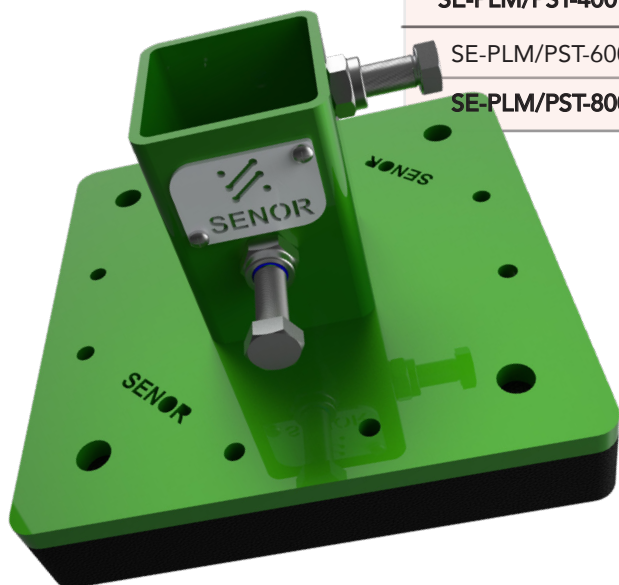

**Nuevo**  
PLM/PST-800 R-TUBULAR

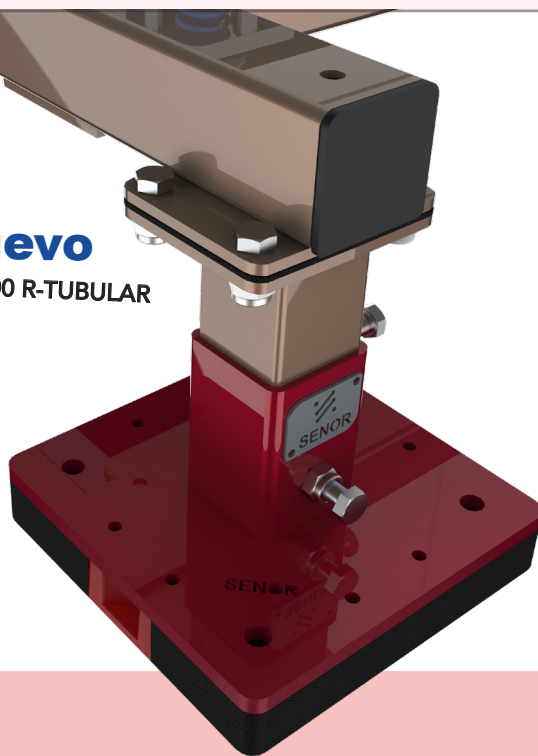

\* Todos los productos se pueden fabricar según la tipología del perfil estructural que se requiera. (Perfil **tubular**, viga IP, IPN, HEA, HEB, etc.)

Fabricante de sistemas **ANTIVIBRATORIOS**



## PLACAS DE ANCLAJE SOBRE SUELO / **ACÚSTICAS**

**Nuevo**  
PLM/PST-800 R-TUBULAR

\* Todos los productos se pueden fabricar según la tipología del perfil estructural que se requiera. (Perfil **tubular**, viga IP, IPN, HEA, HEB, etc.)

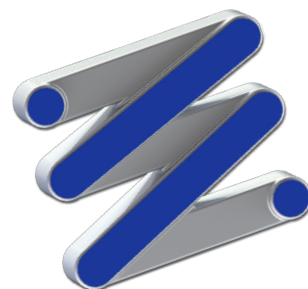

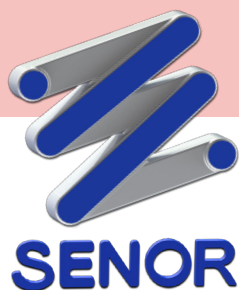

# Tarifa **INDUSTRIA** 2022

## PLACAS DE ANCLAJE SOBRE MURO / **ACÚSTICAS**

FTV-40 G + B.A/L800

**Nuevo**

Referencia	Carga mínima/máx	P.V €/Ud
Reference	minimum/maximum load	RRP € / Unit

## GUÍAS ASCENSOR, TUBERÍAS, ETC / **ANTIVUELCO**

### Serie FTV MURAL

SE-FTV-40 G + B.A/L-800	<b>Nuevo</b>	8Kg hasta 40Kg	218,30 €
SE-FTV-90 V + B.A/L800	<b>Nuevo</b>	30Kg hasta 90Kg	221,13 €
SE-FTV-150 A + B.A/L-800	<b>Nuevo</b>	50Kg hasta 150Kg	223,97 €
SE-FTV-240 R + B.A/L800	<b>Nuevo</b>	130Kg hasta 240Kg	226,80 €
SE-FTV-80 G + B.A/L-800	<b>Nuevo</b>	16Kg hasta 80Kg	454,80 €
SE-FTV-180 V + B.A/L800	<b>Nuevo</b>	60Kg hasta 180Kg	457,64 €
SE-FTV-300 A + B.A/L-800	<b>Nuevo</b>	100Kg hasta 300Kg	460,47 €
SE-FTV-480 R + B.A/L800	<b>Nuevo</b>	260Kg hasta 480Kg	463,31 €

FTV-480 R + B.A/L800

**Nuevo**



Fabricante de sistemas **ANTIVIBRATORIOS**



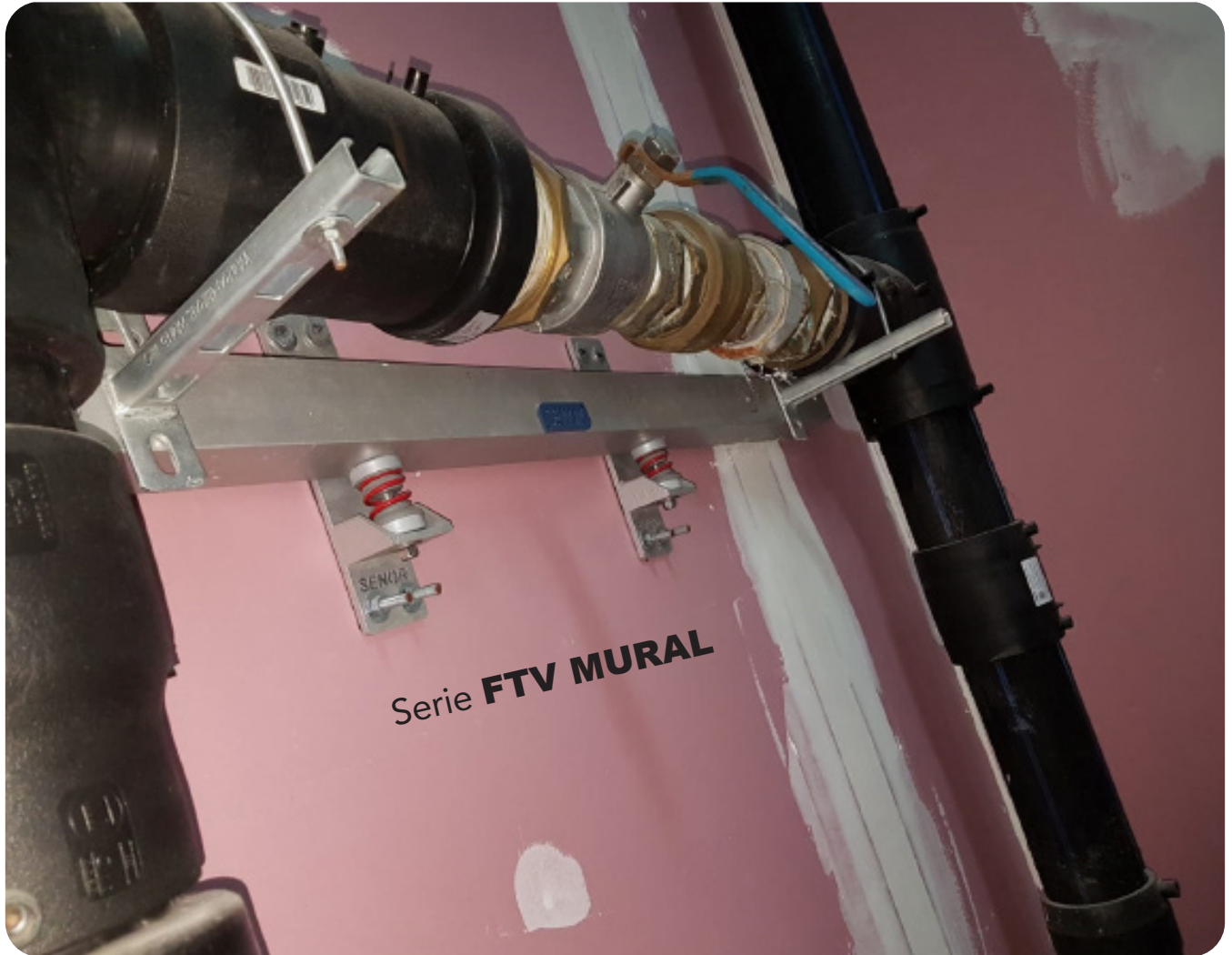

## PLACAS DE ANCLAJE SOBRE MURO / **ACÚSTICAS**

\* Todos los productos se pueden fabricar y adaptar a la tipología de solución constructiva que se requiera. (Perfil **TUBULAR**, viga **IP**, **IPN**, **HEA**, **HEB**, **TUBERÍAS**, **GUÍAS DE ASCENSOR**, etc.)

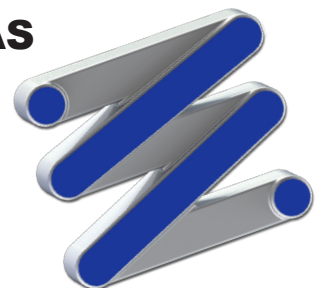

## PLACAS DE ANCLAJE SOBRE MURO / **ACÚSTICAS**



Fabricante de sistemas **ANTIVIBRATORIOS**

\*Tratamiento de sala de **TRANSFORMADOR**. Separación acústica de cableado de alta tensión del equipo respecto al muro divisor entre viviendas.

# Tarifa **INDUSTRIA** **2022**

\*SEÑOR Aisladores Acústicos



## Serie **FTV MURAL**

\*Tratamiento de **MONTACARGAS**. Separación acústica de tramo de estructura (guías) respecto al muro divisor entre viviendas.

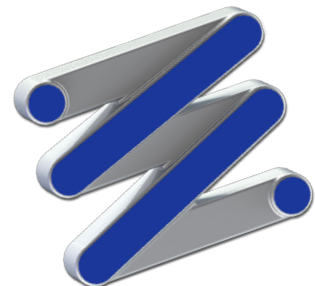

**SEÑOR**

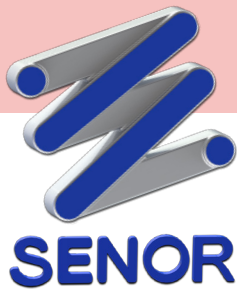

# Tarifa **INDUSTRIA** 2022

## BANCADA AIR / **ACÚSTICA**

<b>Referencia</b>	<b>Carga mínima/máx</b>	<b>P.V €/Ud</b>
Reference	minimum/maximum load	RRP € / Unit

### EXTRACTORES, ENFRIADORAS & **CLIMATIZADORAS**

**BANCADA** diseñada para erradicar toda contaminación por energía vibro-mecánica y reducir el nivel sonoro que produce el equipo.

SE-BANCADA AIR/1000 x1000	<b>Nuevo</b>	Amortiguadores incluidos	2262,33 €
---------------------------	--------------	--------------------------	-----------

BANCADA AIR

**Nuevo**



Fabricante de sistemas **ANTIVIBRATORIOS**

\*BANCADA AIR se pueden fabricar y adaptar a la tipología de solución constructiva que se requiera.  
(CONSULTAR POSIBILIDADES DE DISEÑO).

# Tarifa **INDUSTRIA** **2022**

\*SEÑOR Aisladores Acústicos



BANCADA AIR / **ACÚSTICA**

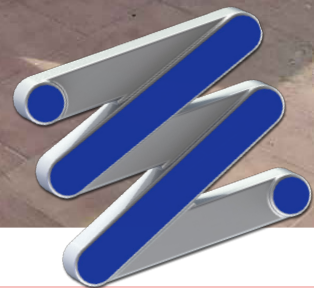

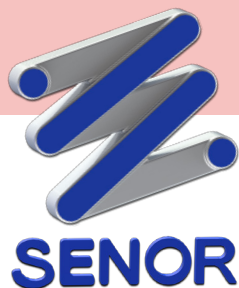

# Tarifa **INDUSTRIA** **2022**

## BANCADA BCP / **ACÚSTICA**

<b>Referencia</b>	<b>Carga mínima/máx</b>	<b>P.V €/Ud</b>
Reference	minimum/maximum load	RRP € / Unit

### ASCENSORES, EXTRACTORES, ENFRIADORAS & **CLIMATIZADORAS**

**BANCADAS** auto-nivelables diseñadas para erradicar toda contaminación por energía vibro-mecánica y reducir el nivel sonoro que producen los equipos.

SE-BANCADA BCP/1000 x1000	<b>Nuevo</b>	Amortiguadores incluidos	3118,50 €
---------------------------	--------------	--------------------------	-----------



**Nuevo**

\*BANCADA BCP

se pueden fabricar y adaptar a la tipología de solución constructiva que se requiera.  
(CONSULTAR POSIBILIDADES DE DISEÑO).

Fabricante de sistemas **ANTIVIBRATORIOS**

## BANCADA BCP / **ACÚSTICA**

<b>Referencia</b>	<b>Carga mínima/máx</b>	<b>P.V €/Ud</b>
Reference	minimum/maximum load	RRP € / Unit

### ASCENSORES, EXTRACTORES, ENFRIADORAS & **CLIMATIZADORAS**

**ACCESORIO** para fabricar bancadas de hormigón auto-nivelables.  
Permite introducir cualquier amortiguador de la GAMA BM-100/INOX.

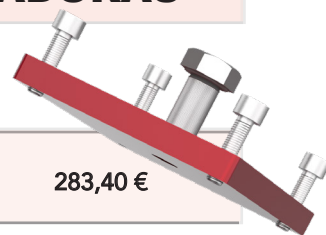

SE-CÁPSULA BCP/100	<b>Nuevo</b>	Amortiguadores NO incluidos	283,40 €
--------------------	--------------	-----------------------------	----------



**Nuevo**  
\*CÁPSULA BCP

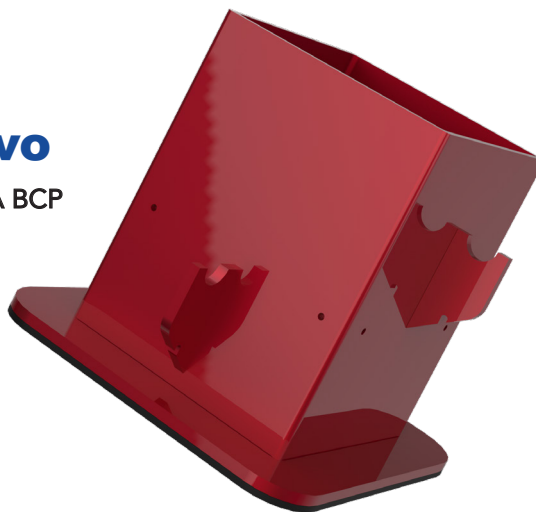

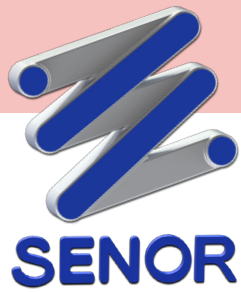

# Tarifa **INDUSTRIA** **2022**

BANCADA BCP / **ACÚSTICA**



Fabricante de sistemas **ANTIVIBRATORIOS**

**Nuevo**  
BANCADA  
**BCP ACÚSTICA**

\*Tratamiento de maquinaria de climatización en **CARREFOUR CÁDIZ**.





**Nuevo**  
BANCADA  
**BCP ACÚSTICA**

\*Tratamiento de **ASCENSOR**. Separación acústica entre los muretes de obra que sustentan el equipo motriz.

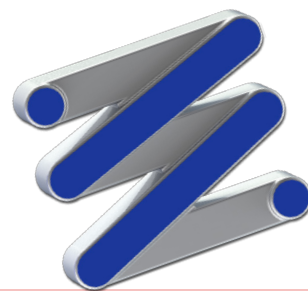

**SEÑOR**

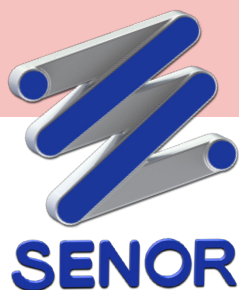

# Tarifa **INDUSTRIA** 2022

## PLACAS SUELO / **ACÚSTICAS**

<b>Referencia</b>	<b>Carga mínima/máx</b>	<b>P.V €/Ud</b>
Reference	minimum/maximum load	RRP € / Unit

### EXTRACTORES, ENFRIADORAS & **CLIMATIZADORAS**

**PFT-1000/ADAPTA** diseñadas para aportar seguridad y rendimiento. Su principal finalidad es erradicar toda contaminación por energía vibro-mecánica.

SE-PFT-1000/ADAPTA 450 V	<b>Nuevo</b>	100Kg hasta 450Kg	437,56 €
SE-PFT-1000/ADAPTA 800 A	<b>Nuevo</b>	350Kg hasta 800Kg	439,15 €
SE-PFT-1000/ADAPTA 1400 R	<b>Nuevo</b>	800Kg hasta 1400Kg	440,74 €

Fabricante de sistemas **ANTIVIBRATORIOS**

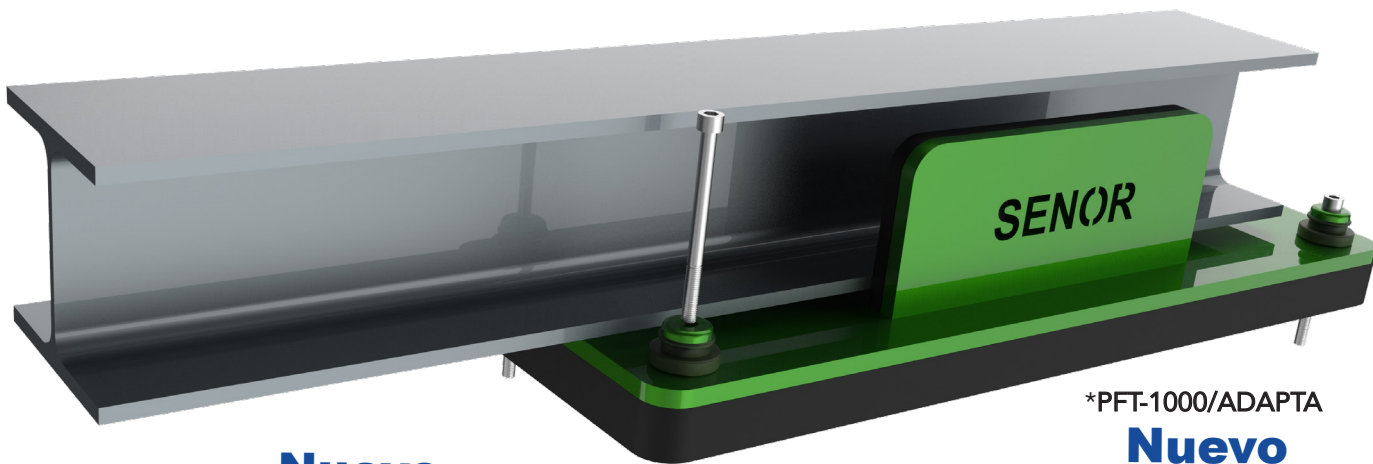

**Nuevo**

\*PFT-1000/ADAPTA

se pueden fabricar y adaptar a la tipología de solución constructiva que se requiera.

(CONSULTAR POSIBILIDADES DE DISEÑO).

\*PFT-1000/ADAPTA

**Nuevo**

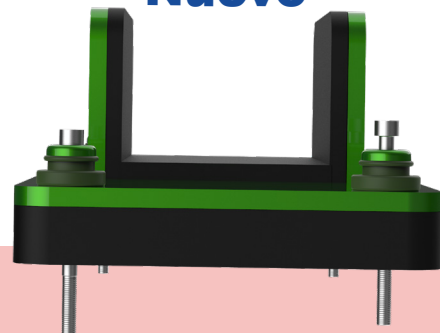

# Tarifa **INDUSTRIA** **2022**

\*SEÑOR Aisladores Acústicos



BANCADA AIR / **ACÚSTICA**

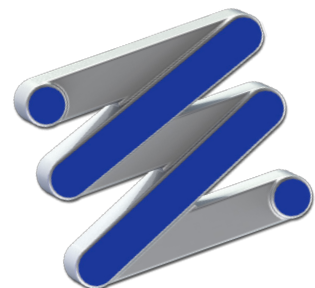

**SEÑOR**

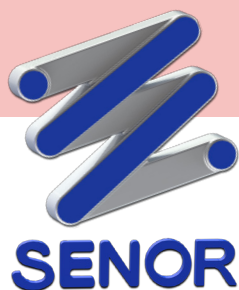

# Tarifa **INDUSTRIA** **2022**

## PLACAS SUELO / **ACÚSTICAS**

<b>Referencia</b>	<b>Carga mínima/máx</b>	<b>P.V €/Ud</b>
Reference	minimum/maximum load	RRP € / Unit

### LAVADORAS & **EQUIPOS ROTATIVOS**

**BANCADA** diseñada para erradicar toda contaminación por energía vibro-mecánica y reducir el nivel sonoro que produce el equipo.

SE-PLM-ADAPTA/LAVADORA 1.100 x 1.200	<b>Nuevo</b>	Amortiguadores incluidos	5443,20 €
SE-PLM-ADAPTA/LAVADORA 1.300 x 1.500	<b>Nuevo</b>	Amortiguadores incluidos	5896,80 €
SE-PLM-ADAPTA/LAVADORA 1.600 x 1.700	<b>Nuevo</b>	Amortiguadores incluidos	6407,10 €



\*PLM-ADAPTA/LAVADORA  
**Nuevo**

Fabricante de sistemas **ANTIVIBRATORIOS**

# Tarifa **INDUSTRIA** **2022**

\*SEÑOR Aisladores Acústicos



\*LAVANDERÍA HOTEL, se pueden fabricar y adaptar a la tipología de solución constructiva que se requiera.  
(CONSULTAR POSIBILIDADES DE DISEÑO).

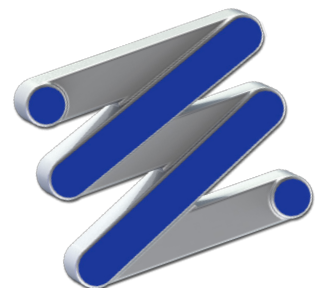

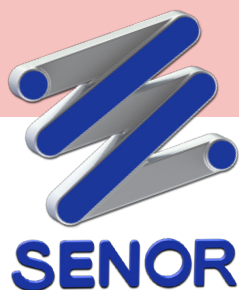

# Tarifa **INDUSTRIA** **2022**

## PLACAS SUELO / **ACÚSTICAS**

<b>Referencia</b>	<b>Carga mínima/máx</b>	<b>P.V €/Ud</b>
Reference	minimum/maximum load	RRP € / Unit

### ASCENSORES & **EQUIPOS ROTATIVOS**

**BANCADA** diseñada para erradicar toda contaminación por energía vibro-mecánica y reducir el nivel sonoro que produce el equipo.

SE-PLM-ADAPTA/ASCENSOR 820 x 300	<b>Nuevo</b>	Amortiguadores incluidos	1950,48 €
----------------------------------	--------------	--------------------------	-----------



\*PLM-ADAPTA/ASCENSOR  
**Nuevo**

Fabricante de sistemas **ANTIVIBRATORIOS**

# Tarifa **INDUSTRIA** **2022**

\*SENOR Aisladores Acústicos

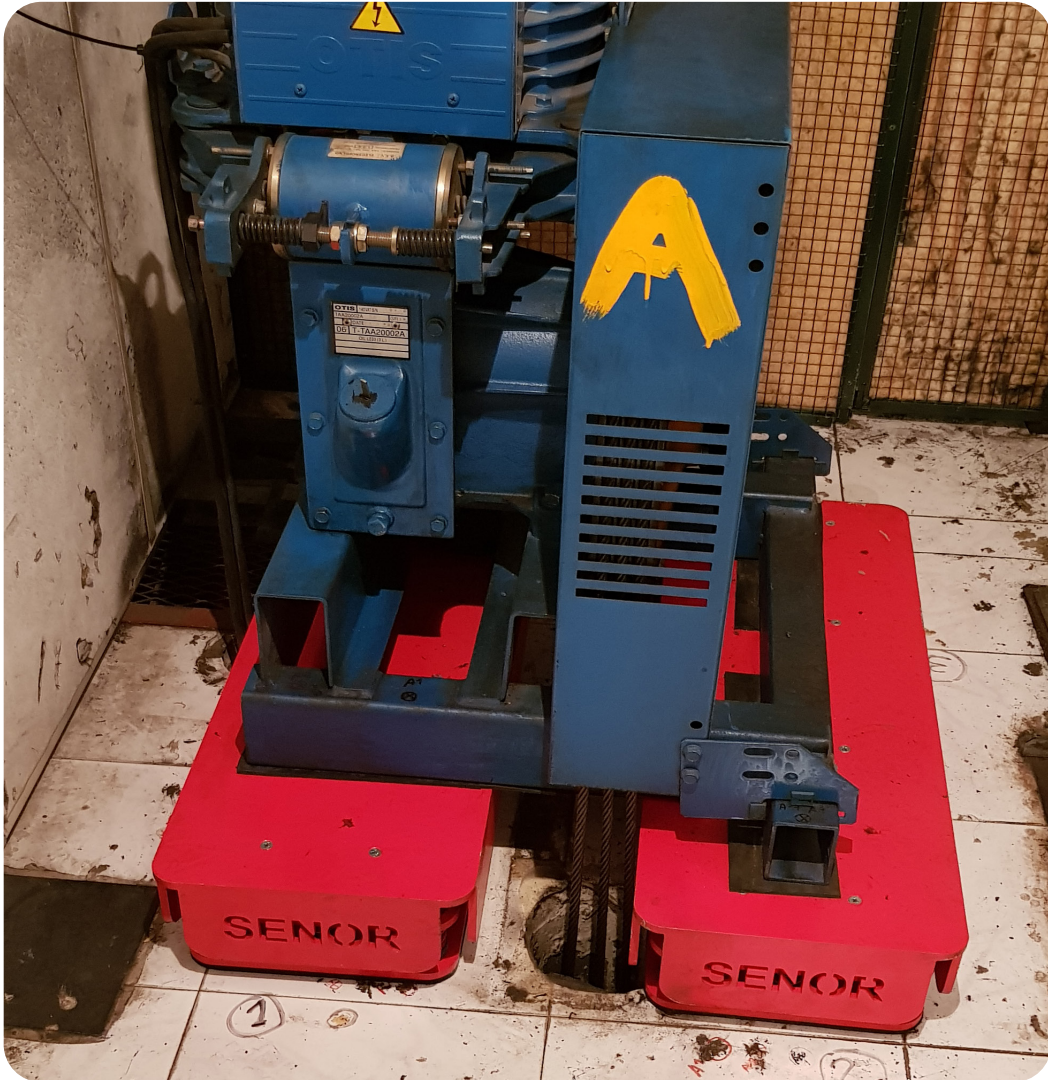

\*PLM-ADAPTA/ASCENSOR

**Nuevo**

\*ASCENSORES, se pueden fabricar y adaptar a la tipología de solución constructiva que se requiera.  
(CONSULTAR POSIBILIDADES DE DISEÑO).

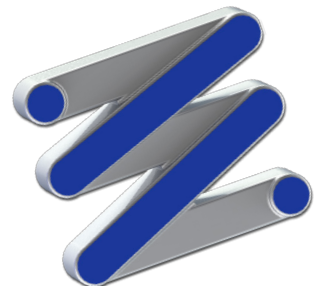

**Un Mundo de Soluciones Acústicas**

**A World of Acoustic Solutions**

