

BATERÍAS



ACCESORIOS PARA BATERÍAS

VÁLVULAS



ACCESORIOS PARA ACOMETIDAS

ALOJAMIENTOS



CATÁLOGO TARIFA GENERAL

- 01. Baterías
- 02. Accesorios para baterías
- 03. Válvulas para contadores
- 04. Elementos para alojamiento
- 05. Accesorios para acometidas
- 06. Valvulería
- 07. Accesorios para tuberías PE



Somos parte del ciclo del agua

Condiciones generales de venta

El suministro de material se realizará de acuerdo con las condiciones generales que a continuación se detallan, las cuales se consideran aceptadas por el cliente en el momento de realizar el pedido.

Suministro y transporte

Los portes serán calculados hasta destino en territorio nacional, consultar. En caso de no cubrir portes, si no tenemos notificación previa por parte de Uds. el porte se cargará automáticamente en factura.

Antes de hacerse cargo de la expedición, el comprador deberá asegurarse de que los bultos estén en perfectas condiciones. En caso de detectar alguna rotura o desperfecto deberá exigir su apertura en presencia del agente de la compañía de transporte.

Precios

Gatell se reserva el derecho de modificar precios sin previo aviso. Datos técnicos actualizados en la web. La facturación de los materiales se realizará según la tarifa vigente en el momento de suministro. Serán a cargo del comprador todos los impuestos, arbitrios y gravámenes que pudieran afectar a la venta de nuestros productos.

Condiciones de pago

Serán concretadas por escrito en cada caso por ambas partes. En caso de demora en el cumplimiento de pago. Gatell se reserva el derecho de cargar al cliente los gastos producidos por el impago, así mismo el interés legal devengado desde la fecha prevista de pago.

Reclamaciones y devoluciones

No se aceptará ninguna devolución que no haya sido previamente acordada entre Gatell y el cliente. En caso de acuerdo se deberán cumplir las siguientes condiciones:

- No se aceptarán devoluciones transcurridos los 15 días de la fecha del albarán.
- No se aceptará material deteriorado, mal conservado, con señales de haber estado en obra, etc.
- Todos los gastos de devolución serán por cuenta del cliente.
- No se aceptarán devoluciones de productos especiales, que se hayan fabricado específicamente para el cliente.

Garantía

Gatell garantiza la calidad de los materiales que comercializa, obligándose a la reposición de aquellos que presenten defectos de fabricación, una vez hayan sido reconocidos como propios por nuestro Responsable Técnico.

Propiedad de la mercancía

La mercancía enviada será propiedad de Gatell hasta que el cliente haya abonado la totalidad del importe del envío.

Jurisdicción

Toda cuestión que pudiera suscitarse por incumplimiento del presente documento, en 1a instancia, y con previo acuerdo de las partes afectadas, se acudirá al tribunal de arbitraje. En 2a instancia, se acudirá a la jurisdicción y competencia de los juzgados y tribunales de la ciudad de Barcelona, con expresa renuncia al fuero de su domicilio.

Catálogo tarifa de distribución gratuita.

Enero 2023



Índice

Condiciones generales de venta.....	1
Introducción.....	3
Baterías para contadores de agua.....	4
Baterías metálicas para contadores de agua.....	5
Baterías plásticas para contadores de agua.....	6
Baterías doble alimentación.....	7
Baterías plásticas Premium.....	8
Mini baterías para contadores de agua.....	9
Dimensiones de los armarios para baterías.....	10
Accesorios para baterías.....	12
Accesorios para baterías.....	13
Contadores de agua.....	16
Accesorios para contadores.....	16
Válvulas para contadores.....	18
Válvulas de entrada con pletina.....	19
Válvulas de entrada roscadas.....	20
Válvulas de entrada con conexión para tubería PE.....	21
Válvulas de salida roscadas.....	23
Válvulas de salida con conexión para tubería PE.....	25
Válvulas de esfera Gatell.....	27
Accesorios para válvulas.....	30
Recambios para válvulas.....	31
Sistemas antifraude.....	32
Precintos para contadores.....	33
Elementos para alojamiento.....	34
Arquetas de registro.....	35
Armarios de registro.....	36
Llaves.....	37
Puertas de registro.....	37
Registros panelables.....	39
Anexo montajes.....	40
Opciones para más de un contador.....	46
Accesorios para acometidas de agua.....	47
Abrazaderas de reparación.....	48
Cabezales y collarines.....	57
Bridas.....	61
Accesorios de fundición.....	63
Válvulas.....	71
Valvulería.....	74
Accesorios para tuberías PE.....	76
Accesorios de latón para tubería PE.....	77
Accesorios electrosoldables para tubería PE.....	80
Accesorios inyectados para tubería PE.....	85
Accesorios de transición.....	89



4
Baterías



12
Accesorios para baterías



18
Válvulas para contadores



34
Elementos para alojamiento



47
Accesorios para acometidas

Desde 1942



En 1942 GATELL inicia su andadura, con la firme voluntad de ofrecer **soluciones a problemas concretos en el sector de la distribución de agua potable y sanitaria en el mercado nacional.**

La constante **investigación** y el posterior **diseño** de nuevos productos, ha especializado a GATELL como una empresa **líder en el sector hidráulico**, incorporando en nuestro día a día nuevos elementos, en constante colaboración con entidades públicas, empresas y profesionales.

GATELL... La voluntad de ser mejores.

Líderes en sistemas antifraude



Desarrollamos junto con las principales compañías del país, **sistemas para evitar el fraude y la manipulación de diferentes partes de las redes de agua potable**, junto con vosotros nos gustaría continuar con este proyecto y seguir innovando productos en este área.

NOVEDADES

BATERÍA PPR PREMIUM

Pág. 8



Sin soldadura en los cuellos y con pletina plástica incorporada, lo que le otorga resistencia mecánica total y durabilidad ilimitada. Además respeta el diámetro de caudal reglamentado.

VÁLVULA DE RETENCIÓN

Pág. 15

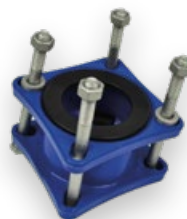

Su orificio de apertura 40% más grande que las de doble disco admite mayor caudal. Además, al tener una sola compuerta presenta menor rozamiento y pérdida de presión.

VÁLVULAS DE ASIENTO

Pág. 21



Conexión con el contador mediante manguito dch-izq o racor loco. Su eje en latón, vulcanizado en EPDM, cuenta con un asiento de teflón que la hace de gran durabilidad y rendimiento.

PRECINTOS GATELL

Pág. 33



Nuevos precintos con mayor superficie para grabado personalizado. Se sirven con cable cortado a la medida de su preferencia.

ARMARIOS Y PUERTAS DE POLIESTIRENO

Pág. 36



Además de su excelente acabado superficial, son resistentes a la corrosión, agentes químicos y rayos UV y resistencia al impacto IK05. Disponible con y sin ventana.

ARMARIOS PANELABLES

Pág. 39

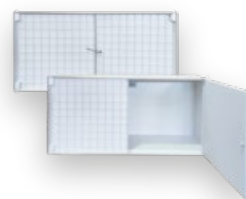

De chapa de acero, lo que les proporciona gran acabado y resistencia. No rompen con la armonía de las fachadas.

ENLACE MULTIDIÁMETRO ANTI-TRACCIÓN

Pág. 63



Enlace y adaptador para brida multidímetro con anti-tracción que permite una óptima sujeción de los tubos, incluso con alta presión hidráulica.

MÁQUINAS DE ELECTROFUSIÓN

Pág. 84



Manejo sencillo del programa de control de la soldadura. Posibilidad de colocar un escaner de código de barras. Sistema de medición de la temperatura del transformador, que protege la soldadura del sobrecalentamiento.



01

BATERÍAS PARA CONTADORES DE AGUA

Baterías metálicas para contadores de agua

Batería Gatell de acero galvanizado std.

Código	Medida	Precio €
01BH042200ST	4-2-2"	163,14
01BH062200ST	6-2-2"	186,36
01BH063200ST	6-3-2"	224,80
01BH082212ST	8-2-2 1/2"	272,98
01BH093212ST	9-3-2 1/2"	334,96
01BH102212ST	10-2-2 1/2"	312,95
01BH122212ST	12-2-2 1/2"	340,80
01BH123212ST	12-3-2 1/2"	386,85
01BH142212ST	14-2-2 1/2"	372,68
01BH153212ST	15-3-2 1/2"	438,73
01BH162212ST	16-2-2 1/2"	404,56
01BH182212ST	18-2-2 1/2"	442,55
01BH183212ST	18-3-2 1/2"	488,28
01BH202212ST	20-2-2 1/2"	468,83
01BH213212ST	21-3-2 1/2"	536,50
01BH222212ST	22-2-2 1/2"	510,26
01BH242212ST	24-2-2 1/2"	533,44
01BH243212ST	24-3-2 1/2"	580,29
01BH262212ST	26-2-2 1/2"	567,93
01BH273212ST	27-3-2 1/2"	638,49
01BH282212ST	28-2-2 1/2"	601,50
01BH302212ST	30-2-2 1/2"	637,04
01BH303212ST	30-3-2 1/2"	682,04
01BH333300ST	33-3-3"	858,50
01BH363300ST	36-3-3"	900,15
01BH393300ST	39-3-3"	961,89
01BH423300ST	42-3-3"	1.011,69
01BH453300ST	45-3-3"	1.065,06

*Incluye contrabridas; las abonamos en caso de que no las utilicen.

Batería Gatell de acero inoxidable std.

Código	Medida	Precio €
02BI042200ST	4-2-2"	372,59
02BI062200ST	6-2-2"	415,43
02BI063200ST	6-3-2"	496,43
02BI082212ST	8-2-2 1/2"	479,55
02BI093212ST	9-3-2 1/2"	582,42
02BI102212ST	10-2-2 1/2"	524,42
02BI122212ST	12-2-2 1/2"	569,10
02BI123212ST	12-3-2 1/2"	639,33
02BI142212ST	14-2-2 1/2"	613,83
02BI153212ST	15-3-2 1/2"	707,70
02BI162212ST	16-2-2 1/2"	660,96
02BI182212ST	18-2-2 1/2"	708,03
02BI183212ST	18-3-2 1/2"	776,00
02BI202212ST	20-2-2 1/2"	752,76
02BI213212ST	21-3-2 1/2"	844,32
02BI222212ST	22-2-2 1/2"	797,49
02BI242212ST	24-2-2 1/2"	844,62
02BI243212ST	24-3-2 1/2"	912,54
02BI262212ST	26-2-2 1/2"	889,31
02BI273212ST	27-3-2 1/2"	980,82
02BI282212ST	28-2-2 1/2"	934,04
02BI302212ST	30-2-2 1/2"	981,17
02BI3032212ST	30-3-2 1/2"	1.049,07
02BI333300ST	33-3-3"	1.463,69
02BI363300ST	36-3-3"	1.537,62
02BI393300ST	39-3-3"	1.611,47
02BI423300ST	42-3-3"	1.685,00
02BI453300ST	45-3-3"	1.764,74

*Incluye contrabridas; las abonamos en caso de que no las utilicen.

Baterías plásticas para contadores de agua

Batería Gatell de Polipropileno std.

Código	Medida	Precio €
03BP042200ST	4-2-2"	131,38
03BP062200ST	6-2-2"	141,76
03BP063200ST	6-3-2"	186,71
03BP082212ST	8-2-2 1/2"	181,52
03BP093212ST	9-3-2 1/2"	227,79
03BP102212ST	10-2-2 1/2"	195,05
03BP122212ST	12-2-2 1/2"	210,71
03BP123212ST	12-3-2 1/2"	249,51
03BP142212ST	14-2-2 1/2"	225,30
03BP153212ST	15-3-2 1/2"	273,36
03BP162212ST	16-2-2 1/2"	242,03
03BP182212ST	18-2-2 1/2"	256,62
03BP183212ST	18-3-2 1/2"	295,43
03BP202212ST	20-2-2 1/2"	272,64
03BP213212ST	21-3-2 1/2"	320,34
03BP222212ST	22-2-2 1/2"	291,86
03BP242212ST	24-2-2 1/2"	306,82
03BP243212ST	24-3-2 1/2"	342,05
03BP262212ST	26-2-2 1/2"	319,62
03BP273212ST	27-3-2 1/2"	363,06
03BP282212ST	28-2-2 1/2"	336,36
03BP302212ST	30-2-2 1/2"	355,91
03BP303212ST	30-3-2 1/2"	384,41
03BP333300ST	33-3-3"	491,19
03BP363300ST	36-3-3"	522,87
03BP393300ST	39-3-3"	548,86
03BP423300ST	42-3-3"	568,79
03BP453300ST	45-3-3"	601,10

*Incluye contrabridas; las abonamos en caso de que no las utilicen.

Batería Gatell de Polietileno std.

Código	Medida	Precio €
03BPE042200ST	4-2-2"	159,85
03BPE062200ST	6-2-2"	180,55
03BPE063200ST	6-3-2"	219,65
03BPE082212ST	8-2-2 1/2"	261,05
03BPE093212ST	9-3-2 1/2"	300,15
03BPE102212ST	10-2-2 1/2"	279,45
03BPE122212ST	12-2-2 1/2"	295,55
03BPE123212ST	12-3-2 1/2"	323,15
03BPE142212ST	14-2-2 1/2"	316,25
03BPE153212ST	15-3-2 1/2"	348,45
03BPE162212ST	16-2-2 1/2"	334,65
03BPE182212ST	18-2-2 1/2"	345,00
03BPE183212ST	18-3-2 1/2"	377,20
03BPE202212ST	20-2-2 1/2"	361,10
03BPE213212ST	21-3-2 1/2"	401,35
03BPE222212ST	22-2-2 1/2"	376,05
03BPE242212ST	24-2-2 1/2"	389,85
03BPE243212ST	24-3-2 1/2"	425,50
03BPE262212ST	26-2-2 1/2"	410,55
03BPE273212ST	27-3-2 1/2"	455,40
03BPE282212ST	28-2-2 1/2"	425,50
03BPE302212ST	30-2-2 1/2"	449,65
03BPE303212ST	30-3-2 1/2"	522,10
03BPE333300ST	33-3-3"	631,35
03BPE363300ST	36-3-3"	677,35
03BPE393300ST	39-3-3"	704,95
03BPE423300ST	42-3-3"	733,70
03BPE453300ST	45-3-3"	779,70

*Incluye contrabridas; las abonamos en caso de que no las utilicen.

Baterías para contadores de agua | Doble alimentación



Batería Gatell de acero galvanizado Doble alimentación

Código	Medida	Precio €
01BH182212DA	18-2-2 1/2"	473,52
01BH183212DA	18-3-2 1/2"	522,46
01BH202212DA	20-2-2 1/2"	501,64
01BH213212DA	21-3-2 1/2"	574,05
01BH222212DA	22-2-2 1/2"	545,97
01BH242212DA	24-2-2 1/2"	570,78
01BH243212DA	24-3-2 1/2"	620,91
01BH262212DA	26-2-2 1/2"	607,68
01BH273212DA	27-3-2 1/2"	683,18
01BH282212DA	28-2-2 1/2"	643,60
01BH302212DA	30-2-2 1/2"	681,63
01BH303212DA	30-3-2 1/2"	729,78
01BH333300DA	33-3-3"	918,59
01BH363300DA	36-3-3"	963,16
01BH393300DA	39-3-3"	1.029,23
01BH423300DA	42-3-3"	1.082,51
01BH453300DA	45-3-3"	1.139,60

*Incluye contrabridas; las abonamos en caso de que no las utilicen.

Batería Gatell de polipropileno Doble alimentación

Código	Medida	Precio €
03BP182212DA	18-2-2 1/2"	295,70
03BP183212DA	18-3-2 1/2"	315,67
03BP202212DA	20-2-2 1/2"	313,17
03BP213212DA	21-3-2 1/2"	335,19
03BP222212DA	22-2-2 1/2"	320,21
03BP242212DA	24-2-2 1/2"	325,44
03BP243212DA	24-3-2 1/2"	357,68
03BP262212DA	26-2-2 1/2"	335,49
03BP273212DA	27-3-2 1/2"	379,46
03BP282212DA	28-2-2 1/2"	354,49
03BP302212DA	30-2-2 1/2"	373,35
03BP303212DA	30-3-2 1/2"	400,53
03BP333300DA	33-3-3"	525,96
03BP363300DA	36-3-3"	563,01
03BP393300DA	39-3-3"	583,03
03BP423300DA	42-3-3"	595,84
03BP453300DA	45-3-3"	631,44

*Incluye contrabridas; las abonamos en caso de que no las utilicen.

Baterías plásticas Premium

Batería Gatell de Polipropileno Premium

Código	Serie	Medida	Precio €
03BPRM042212ST	S6/S10	4-2-2 1/2"	153,68
03BPRM062212ST	S6/S10	6-2-2 1/2"	180,21
03BPRM063212ST	S6/S10	6-3-2 1/2"	221,53
03BPRM082212ST	S6/S10	8-2-2 1/2"	269,31
03BPRM093212ST	S6/S10	9-3-2 1/2"	349,15
03BPRM102212ST	S6/S10	10-2-2 1/2"	298,59
03BPRM122212ST	S6/S10	12-2-2 1/2"	325,67
03BPRM123212ST	S6/S10	12-3-2 1/2"	387,59
03BPRM142212ST	S6/S10	14-2-2 1/2"	353,92
03BPRM153212ST	S6/S10	15-3-2 1/2"	430,10
03BPRM162212ST	S6/S10	16-2-2 1/2"	382,07
03BPRM182212ST	S6/S10	18-2-2 1/2"	411,45
03BPRM183212ST	S6/S10	18-3-2 1/2"	475,01
03BPRM202212ST	S6/S10	20-2-2 1/2"	437,86
03BPRM213212ST	S6/S10	21-3-2 1/2"	516,59
03BPRM243212ST	S6/S10	24-3-2 1/2"	558,11
03BPRM273212ST	S6/S10	27-3-2 1/2"	601,93
03BPRM303212ST	S6/S10	30-3-2 1/2"	641,51

*Para mayor número de pletinas consultar

Serie 10

Brida plástica para portabridas

Código	DN	PN	Precio €
03BP065	65	10	39,90

Serie 6

Brida metálica para portabridas

Código	DN	PN	Precio €
04CDIN2573212SR	65	6	25,24

Batería Gatell de Polipropileno Premium Doble alimentación

Código	Serie	Medida	Precio €
03BPRM182212DA	S6/S10	18-2-2 1/2"	434,87
03BPRM183212DA	S6/S10	18-3-2 1/2"	496,47
03BPRM202212DA	S6/S10	20-2-2 1/2"	460,60
03BPRM213212DA	S6/S10	21-3-2 1/2"	536,99
03BPRM243212DA	S6/S10	24-3-2 1/2"	577,45
03BPRM273212DA	S6/S10	27-3-2 1/2"	620,15
03BPRM303212DA	S6/S10	30-3-2 1/2"	658,72



Tubos monopieza fabricados por inyección, lo que permite precisión en las uniones y evita la corrosión.



Diámetros de caudal cumpliendo la reglamentación de los cuellos con un paso de 20mm.



Incorporación de brida en composite, generando un producto plástico en su totalidad.

Opción de conexión a tubo de Polietileno

Válvula de retención Gatell 04VRETB

Válvula de mariposa 06VM

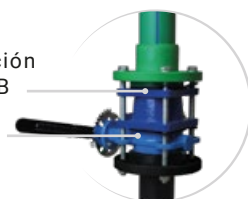
Brida metálica roscada

Código	DN	PN	Precio €
03BM065	2 1/2"	10	30,12

Brida metálica roscada

Código	DN	PN	Precio €
04DIN2573212	2 1/2"	6	29,68

Mini baterías para contadores de agua

Mini baterías de acero galvanizado

	Código	Tipo	Medida	Precio €
  	01BH021200MI	Candelabro	2-1-2"	117,59
	01BH042200MI	Candelabro	4-2-2"	142,00
	01BH022200MI	Árbol	2-2-2"	134,16
	01BH033200MI	Árbol	3-3-2"	162,90
	01BH044200MI	Árbol	4-4-2"	174,29
	01BH042200CC	Circuito Cerrado	4-2-2"	412,85
	01BH063200CC	Circuito Cerrado	6-3-2"	457,70
	01BH084212CC	Circuito Cerrado	8-4-2 1/2"	499,10

Candelabro

Árbol

Circuito Cerrado

*Incluye contrabridas; las abonamos en caso de que no las utilicen.

Mini baterías de acero inoxidable

	Código	Tipo	Medida	Precio €
  	02BI021200MI	Candelabro	2-1-2"	474,75
	02BI042200MI	Candelabro	4-2-2"	579,78
	02BI022200MI	Árbol	2-2-2"	341,07
	02BI033200MI	Árbol	3-3-2"	372,57
	02BI044200MI	Árbol	4-4-2"	408,27
	02BI042200CC	Circuito Cerrado	4-2-2"	717,00
	02BI063200CC	Circuito Cerrado	6-3-2"	924,00
	02BI084212CC	Circuito Cerrado	8-4-2 1/2"	1.011,50

Candelabro

Árbol

Circuito Cerrado

*Incluye contrabridas; las abonamos en caso de que no las utilicen.

Mini baterías de polipropileno

	Código	Tipo	Medida	Precio €
  	03BP021200MI	Candelabro	2-1-2"	111,30
	03BP042200MI	Candelabro	4-2-2"	138,60
	03BP022200MI	Árbol	2-2-2"	106,81
	03BP033200MI	Árbol	3-3-2"	139,83
	03BP044200MI	Árbol	4-4-2"	174,43
	03BP042200CC	Circuito Cerrado	4-2-2"	201,17
	03BP063200CC	Circuito Cerrado	6-3-2"	241,56
	03BP084212CC	Circuito Cerrado	8-4-2 1/2"	330,69



Candelabro

Árbol

Circuito Cerrado

*Incluye contrabridas; las abonamos en caso de que no las utilicen.

Mini baterías de polietileno

	Código	Tipo	Medida	Precio €
 	03BPE021200MI	Candelabro	2-1-2"	171,60
	03BPE042200MI	Candelabro	4-2-2"	196,80
	03BPE022200MI	Árbol	2-2-2"	146,40
	03BPE033200MI	Árbol	3-3-2"	165,60
	03BPE044200MI	Árbol	4-4-2"	205,20

Candelabro

Árbol

*Incluye contrabridas; las abonamos en caso de que no las utilicen.

Dimensiones de los armarios para baterías

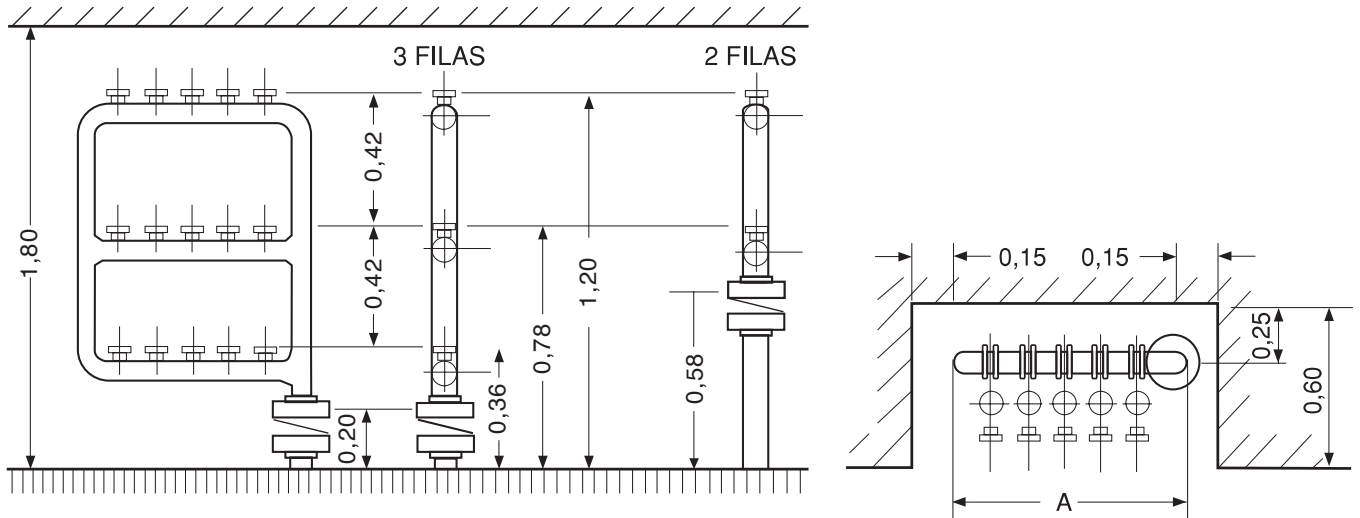

Dimensiones A (m) del armario para baterías standard

Diámetro (mm)	Características		A (m) según tipo de batería					
	Nº Pletinas	Nº Filas	INOX		GALVA		PPR/PE	
			Medidas	Peso Kg	Medidas	Peso Kg	Medidas	Peso Kg
53 INOX 2" GALVA 63 PPR/PE	4	2	0,38	6,40	0,37	11,80	0,39	7,00
	6	2	0,50	6,90	0,49	13,50	0,51	7,60
		3	0,38	6,50	0,37	17,30	0,39	9,20
	8	2	0,68	9,20	0,67	19,40	0,67	10,50
63,5 INOX 2 1/2" GALVA 75 PRP/PE	9	3	0,54	11,70	0,55	25,70	0,55	13,20
	10	2	0,80	10,20	0,79	21,70	0,79	11,20
	12	2	0,92	10,70	0,91	23,10	0,91	11,90
		3	0,66	13,20	0,67	28,90	0,67	14,30
	14	2	1,04	11,80	1,03	25,50	1,03	12,60
	15	3	0,78	14,20	0,79	31,70	0,79	15,30
	16	2	1,16	12,70	1,15	27,50	1,15	13,30
	18	2	1,28	13,20	1,27	29,70	1,27	14,40
		3	0,90	15,70	0,91	34,70	0,91	16,40
	20	2	1,40	13,70	1,39	31,10	1,39	14,70
	21	3	1,02	16,70	1,03	38,00	1,03	17,50
	22	2	1,52	14,20	1,51	33,20	1,51	15,40
	24	2	1,64	14,70	1,63	35,40	1,63	16,10
		3	1,14	17,70	1,15	41,20	1,15	18,50
	26	2	1,76	16,70	1,75	37,30	1,75	16,80
	27	3	1,26	18,70	1,27	43,30	1,27	19,60
28	2	1,88	18,00	1,87	39,50	1,87	17,50	
30	2	2,00	19,30	1,99	40,90	1,99	18,30	
	3	1,38	20,20	1,39	46,40	1,39	19,40	
73 INOX 3" GALVA 90 PRP/PE	33	3	1,55	22,00	1,57	63,60	1,57	30,10
	36	3	1,67	26,30	1,69	66,60	1,69	31,50
	39	3	1,79	28,30	1,81	69,80	1,81	32,80
	42	3	1,91	30,80	1,93	73,00	1,93	34,20
	45	3	2,03	33,80	2,05	76,20	2,05	35,50



ACCESORIOS PARA BATERÍAS

Accesorios para baterías

Cuadros de clasificación



Código	Medida	Descripción	Precio €
04CC093	Pequeño	9 cont. en 3 filas	16,80
04CC213	Mediano	21 cont. en 3 filas	19,95
04CC453	Grande	45 cont. en 3 filas	19,95

Soportes para baterías

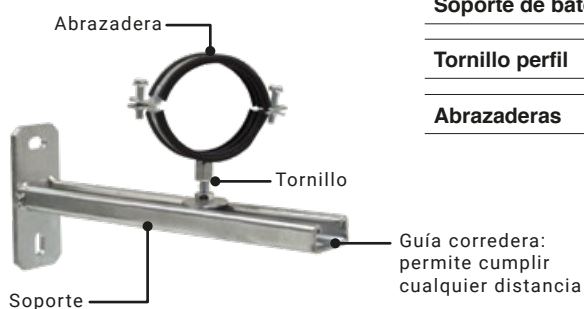

Descripción	Código	Medida	Precio €
Soporte de batería	15SF4121	41/21 x 300	15,30
Tornillo perfil	15TF840	M-8 x 40	2,00
Abrazaderas	15ABFE060	2" sin goma	2,37
	15ABFE060G	2" con goma	3,23
	15ABFE075	2 1/2" sin goma	2,58
	15ABFE075G	2 1/2" con goma	3,56
	15ABFE090	3" sin goma	2,82
	15ABFE090G	3" con goma	4,08

Gancho de cuchara para batería empotrable



Código	Descripción	Precio €
04GB	Galva	4,29
04GBI	Inox	6,82

Multitool



08MT



08MTAF

Código	Precio €
08MT	26,09
08MTAF	Consultar

Utilidades:

- Gestión de manguitos de todas las medidas
- Gestión de los tornillos de válvulas con pletina
- Gestión de monturas de asiento

Utilidades:

- Gestión de tornillo antifraude (Ref. 08F031AA)
- Gestión de los tornillos de válvulas con pletina
- Gestión de monturas de asiento

Accesorios para baterías

Pipa STD galvanizada | 2E / 3S I

	Código	Precio €
	04PIPAG	89,36

Pipa STD galvanizada | 1E / 2S I

	Código	Precio €
	04PIPAG2	53,80

Pipa STD polipropileno | 2E / 3S I

	Código	Precio €
	04PIPAPPR	58,09

Pipa STD polipropileno | 1E / 2S I

	Código	Precio €
	04PIPAPPR2	41,20

Pipa STD inoxidable | 2E / 3S I

	Código	Precio €
	04PIPAI	188,30

Brida DIN 2573 PN6

	Código	DN	Precio €
	04DIN2573200	2"	25,83
	04DIN2573212	2 1/2"	29,68
	04DIN2573300	3"	36,53

Pletina ciega

	Código	Medida	Precio €
	04CIEGA	Galva	5,28
	04CIEGAI	Inox	13,94

*Posibilidad de marcaje láser personalizado

Brida Agbar PN10/16

	Código	DN	Precio €
	04BAG030	30-1 1/4"	34,30
	04BAG040	40-1 1/2"	37,24
	04BAG050	50-2"	54,06
	04BAG060	60-2 1/2"	64,82
	04BAG080	80-3"	82,74
	04BAG100	100-4"	110,08

Brida barco

	Código	DN	Precio €
	04BARCO112	1 1/2"	76,37
	04BARCO200	2"	76,37

Collarín reparación batería PPR

	Código	Medida	Precio €
	04CR063	63mm	74,89
	04CR075	75mm	79,94
	04CR090	90mm	89,19

Tornillo llave entrada

	Código	DN	Precio €
	08TORLLAR	15/20	0,52

*Tratamiento GEOMET® 321: Incrementa la resistencia a la corrosión

Accesorios para baterías

Válvula de retención para embridar PN6-10



Código	Medida	Precio €
04VRETB200	2"	Consultar
04VRETB212	2 1/2"	115,57
04VRETB300	3"	115,57

Válvula de retención roscada clapeta



Código	Medida	Precio €
06VRR012	1/2"	11,46
06VRR034	3/4"	15,62
06VRR100	1"	22,35
06VRR114	1 1/4"	31,28
06VRR112	1 1/2"	42,18
06VRR200	2"	73,63
06VRR212	2 1/2"	114,35
06VRR300	3"	158,56

Válvula de retención roscada york



Código	Medida	Precio €
06VYR012	1/2"	7,79
06VYR034	3/4"	12,11
06VYR100	1"	14,40
06VYR114	1 1/4"	22,78
06VYR112	1 1/2"	34,43
06VYR200	2"	50,39
06VYR212	2 1/2"	106,13
06VYR300	3"	251,60

Válvula de retención doble disco para embridar PN6-10



Código	Medida	Precio €
06VRDD200	DN50	61,77
06VRDD212	DN65	71,34
06VRDD300	DN80	95,81

Flexos especial batería



Código	Longitud	Medida	Precio €
05FLC0400034	400mm	3/4" M-H / H-H	11,64
05FLC0400100	400mm	1" M-H / H-H	20,79
05FLC0500034	500mm	3/4" M-H / H-H	14,26
05FLC0500100034	500mm	1-3/4" M-H	22,67
05FLC0500100	500mm	1" M-H / H-H	22,46
05FLC0600034	600mm	3/4" M-H / H-H	16,65
05FLC0600100	600mm	1" M-H / H-H	24,16
05FLC0600100034	600mm	1-3/4" M-H	25,11

Contadores de agua

Contador chorro único



Código	Temperatura agua	Medida	Precio €
16AFDN015034034	Agua fría	3/4" - 3/4"	44,99
16ACDN015034034	Agua caliente	3/4" - 3/4"	51,18
16AFDN013078034	Agua fría	7/8" - 3/4"	54,84
16ACDN013078034	Agua caliente	7/8" - 3/4"	61,78
16AFDN020100100	Agua fría	1" - 1"	64,32
16ACDN020100100	Agua caliente	1" - 1"	71,65

Contador chorro múltiple



Código	Temperatura agua	Medida	Precio €
16AFDN025114114	Agua fría	DN25	228,17
16ACDN025114114	Agua caliente	DN25	296,69
16AFDN030112112	Agua fría	DN30	239,45
16ACDN030112112	Agua caliente	DN30	312,70
16AFDN040200200	Agua fría	DN40	507,46
16ACDN040200200	Agua caliente	DN40	683,13

Contador industrial



Código	Temperatura agua	Medida	Precio €
16AFDN050200200	Agua fría	DN50	676,19
16AFDN065212212	Agua fría	DN65	773,26
16AFDN080300300	Agua fría	DN80	893,85
16AFDN100400400	Agua fría	DN100	1.021,13

Accesorios para contadores

Punto de lectura exterior de superficie



Código	Precio €
16PL	59,35

Punto de lectura exterior para empotrar



Código	Precio €
16PL2	299,29

Punto de lectura liso exterior



Código	Precio €
CTLL18081	108,68

Punto de lectura exterior EMASESA



Código	Precio €
CTLS1808113	108,68

Punto de lectura interior



Código	Precio €
CTLL18080	63,14



03

VÁLVULAS PARA CONTADORES DE AGUA

Válvulas de entrada con pletina

Válvula de entrada orientable de asiento manual antirretorno

	Código	Entrada	DN	Contador *	Precio €
	0810215	Pletina	15	M LL13	17,36
	0810215RL034	Pletina	15	R/L 3/4"	21,55
	0810220	Pletina	20	M 1"INV - H 3/4"	28,12
	0810220RL034	Pletina	20	R/L 3/4"	36,12
	0810220RL078	Pletina	20	R/L 7/8"	36,29
	0810220RL100	Pletina	20	R/L 1"	40,22

* M conexión mediante manguito
* R/L conexión mediante racor loco

Válvula de entrada orientable de asiento antifraude antirretorno

	Código	Entrada	DN	Contador *	Precio €
	0810215AF	Pletina	15	M LL13	20,71
	0810215RL034AF	Pletina	15	R/L 3/4"	29,34
	0810220AF	Pletina	20	M 1"INV - H 3/4"	32,42
	0810220RL034AF	Pletina	20	R/L 3/4"	44,33
	0810220RL078AF	Pletina	20	R/L 7/8"	44,73
	0810220RL100AF	Pletina	20	R/L 1"	47,49

* M conexión mediante manguito
* R/L conexión mediante racor loco

Válvula de entrada orientable esfera teflonada

	Código	Entrada	DN	Contador *	Precio €
	08102B15RL034	Pletina	15	R/L 3/4"	22,12
	08102B20	Pletina	20	M 3/4"INV	28,68
	08102B20034H	Pletina	20	H 3/4"	32,13
	08102B20100M	Pletina	20	M 1"INV	32,10
	08102B20RL034	Pletina	20	R/L 3/4"	34,15
	08102B20RL078	Pletina	20	R/L 7/8"	35,85
	08102B20RL100	Pletina	20	R/L 1"	37,21

* M conexión mediante manguito
* R/L conexión mediante racor loco

Válvula de entrada orientable esfera teflonada antifraude

	Código	Entrada	DN	Contador *	Precio €
	08102B20AF	Pletina	20	M 3/4"INV	28,69
	08102B20034HAF	Pletina	20	H 3/4"	33,28
	08102B20100MAF	Pletina	20	M 1"INV	36,11
	08102B20RL034AF	Pletina	20	R/L 3/4"	40,72
	08102B20RL078AF	Pletina	20	R/L 7/8"	41,37
	08102B20RL100AF	Pletina	20	R/L 1"	42,29

* M conexión mediante manguito
* R/L conexión mediante racor loco

Válvulas de entrada roscadas

Válvula de entrada de asiento manual antirretorno

	Código	Entrada	DN	Contador *	Precio €
	0810515	3/4"	15	M LL13	11,52
	0810520	1"	20	M 1"INV - H 3/4"	23,87
	0810520RL034	1"	20	R/L 3/4"	29,50
	0810520RL078	1"	20	R/L 7/8"	29,75
	0810520RL100	1"	20	R/L 1"	31,14

* M conexión mediante manguito

* R/L conexión mediante racor loco

Válvula de entrada de asiento antifraude antirretorno

	Código	Entrada	DN	Contador *	Precio €
	0810515AF	3/4"	15	M LL13	14,71
	0810520AF	1"	20	M 1"INV - H 3/4"	24,55
	0810520RL034AF	1"	20	R/L 3/4"	32,22
	0810520RL078AF	1"	20	R/L 7/8"	32,58
	0810520RL100AF	1"	20	R/L 1"	34,58

* M conexión mediante manguito

* R/L conexión mediante racor loco

Válvula de entrada esfera teflonada manual

	Código	Entrada	DN	Contador *	Precio €
	08105B15RL034	3/4"	15	R/L 3/4"	12,57
	08105B20	1"	20	H 3/4"	21,83
	08105B20M034I	1"	20	M 3/4"INV	25,11
	08105B20M100I	1"	20	M 1"INV	28,26
	08105B20RL034	1"	20	R/L 3/4"	25,22
	08105B20RL078	1"	20	R/L 7/8"	25,90
	08105B20RL100	1"	20	R/L 1"	26,39

También disponible:



Antivandálico



Antifraude
Cuadrillo 30x30

* M conexión mediante manguito

* R/L conexión mediante racor loco

Válvula de entrada esfera teflonada antifraude

	Código	Entrada	DN	Contador *	Precio €
	08105B20AF	1"	20	H 3/4"	26,44
	08105B20M034IAF	1"	20	M 3/4"INV	29,85
	08105B20M100IAF	1"	20	M 1"INV	33,77
	08105B20RL034AF	1"	20	R/L 3/4"	30,66
	08105B20RL078AF	1"	20	R/L 7/8"	31,00
	08105B20RL100AF	1"	20	R/L 1"	33,10

* M conexión mediante manguito

* R/L conexión mediante racor loco

Válvulas de entrada con conexión para tubería PE

Válvula de entrada de asiento manual antirretorno



Código	Entrada	DN	Contador *	Precio €
081061520	PE20	15	M LL13	24,37
081061525	PE25	15	M LL13	19,55
081062025	PE25	20	M 1"INV - H 3/4"	37,13
081062025RL034	PE25	20	R/L 3/4"	48,15
081062025RL078	PE25	20	R/L 7/8"	48,62
081062025RL100	PE25	20	R/L 1"	51,35
081062032	PE32	20	M 1"INV - H 3/4"	28,78
081062032RL034	PE32	20	R/L 3/4"	36,66
081062032RL078	PE32	20	R/L 7/8"	37,01
081062032RL100	PE32	20	R/L 1"	38,96

* M conexión mediante manguito

* R/L conexión mediante racor loco

Válvula de entrada de asiento antifraude antirretorno



Código	Entrada	DN	Contador *	Precio €
081061520AF	PE20	15	M LL13	29,42
081061525AF	PE25	15	M LL13	23,14
081062025AF	PE25	20	M 1"INV - H 3/4"	32,96
081062025RL034AF	PE25	20	R/L 3/4"	31,86
081062025RL078AF	PE25	20	R/L 7/8"	32,20
081062025RL100AF	PE25	20	R/L 1"	34,25
081062032AF	PE32	20	M 1"INV - H 3/4"	32,83
081062032RL034AF	PE32	20	R/L 3/4"	40,29
081062032RL078AF	PE32	20	R/L 7/8"	40,66
081062032RL100AF	PE32	20	R/L 1"	40,99

* M conexión mediante manguito

* R/L conexión mediante racor loco



Opción **ajuste hexagonal**

Válvulas de entrada con conexión para tubería PE

Válvula de entrada esfera teflonada manual

	Código	Entrada	DN	Contador *	Precio €
	08106B2025	PE25	20	H 3/4"	24,32
	08106B2025M034I	PE25	20	M 3/4" INV	28,46
	08106B2025M100I	PE25	20	M 1" INV	32,60
	08106B2025RL034	PE25	20	R/L 3/4"	26,40
	08106B2025RL078	PE25	20	R/L 7/8"	27,68
	08106B2025RL100	PE25	20	R/L 1"	28,98
	08106B2032	PE32	20	H 3/4"	26,36
	08106B2032M034I	PE32	20	M 3/4" INV	30,18
	08106B2032M100I	PE32	20	M 1" INV	34,32
	08106B2032RL034	PE32	20	R/L 3/4"	35,12
	08106B2032RL078	PE32	20	R/L 7/8"	37,10
	08106B2032RL100	PE32	20	R/L 1"	38,25

También disponible:



Antivandálico



Antifraude
Cuadradillo 30x30

* M conexión mediante manguito
* R/L conexión mediante racor loco

Válvula de entrada esfera teflonada antifraude

	Código	Entrada	DN	Contador *	Precio €
	08106B2025AF	PE25	20	H 3/4"	27,97
	08106B2025M034IA	PE25	20	M 3/4" INV	32,43
	08106B2025M100IA	PE25	20	M 1" INV	37,16
	08106B2025RL034A	PE25	20	R/L 3/4"	29,98
	08106B2025RL078A	PE25	20	R/L 7/8"	30,72
	08106B2025RL100AF	PE25	20	R/L 1"	36,17
	08106B2032AF	PE32	20	H 3/4"	30,04
	08106B2032M034IAF	PE32	20	M 3/4" INV	35,79
	08106B2032M100IAF	PE32	20	M 1" INV	39,13
	08106B2032RL034AF	PE32	20	R/L 3/4"	35,95
	08106B2032RL078AF	PE32	20	R/L 7/8"	36,85
	08106B2032RL100AF	PE32	20	R/L 1"	37,66

* M conexión mediante manguito
* R/L conexión mediante racor loco



Opción ajuste hexagonal

Válvulas de salida roscada

Válvula de salida de asiento manual antirretorno

	Código	Contador *	DN	Salida	Precio €
	0820115	M LL13	15	M 3/4"	11,38
	0820120	M 1" INV	20	M 1"	21,71
	0820120RL034	R/L 3/4"	20	M 1"	27,80
	0820120RL100	R/L 1"	20	M 1"	28,40

- * M conexión mediante manguito
- * R/L conexión mediante racor loco

Válvula de salida de asiento manual antirretorno con purga incorporada

	Código	Contador *	DN	Salida	Precio €
	0820415	M LL13	15	M 3/4"	14,56
	0820415RL034	R/L 3/4"	15	M 3/4"	19,98
	0820420	M 1" INV	20	M 1"	33,71
	0820420RL034	R/L 3/4"	20	M 1"	35,61
	0820420RL100	R/L 1"	20	M 1"	37,23

- * M conexión mediante manguito
- * R/L conexión mediante racor loco

Válvula de salida de asiento manual antirretorno con purga ensamblada

	Código	Contador *	DN	Salida	Precio €
	0820515	M LL13	15	M 3/4"	26,49
	0820520	M 1" INV	20	M 1"	44,53

- * M conexión mediante manguito
- * R/L conexión mediante racor loco

Válvula de salida de asiento vertical manual antirretorno

	Código	Contador *	DN	Salida	Precio €
	0820715	M LL13	15	M 3/4"	17,97
	0820720	H 3/4"	20	M 1"	28,93
	0820720R	M 1" INV	20	M 1"	33,17
	0820720RL034R	R/L 3/4"	20	M 1"	33,15
	0820720RL100R	R/L 1"	20	M 1"	36,81

- * M conexión mediante manguito
- * R/L conexión mediante racor loco

Válvulas de salida roscada

Válvula de salida de asiento vertical manual antirretorno con purga ensamblada

Código	Contador *	DN	Salida	Precio €
0820715P	M LL13	15	M 3/4"	29,32
0820720P	H 3/4"	20	M 1"	47,10

- * M conexión mediante manguito
- * R/L conexión mediante racor loco

Válvula de salida de asiento vertical manual antirretorno con purga incorporada

Código	Contador *	DN	Salida	Precio €
0820920P	H 3/4"	20	M 1"	35,51
0820920PR	M 1" INV	20	M 1"	39,50
0820920RL034PR	R/L 3/4"	20	M 1"	39,73
0820920RL100PR	R/L 1"	20	M 1"	43,39

- * M conexión mediante manguito
- * R/L conexión mediante racor loco

Válvula de salida esfera teflonada manual antirretorno

Código	Contador *	DN	Salida	Precio €
08207B20	H 3/4"	20	M 1"	24,92
08207B20M034I	M 3/4" INV	20	M 1"	28,22
08207B20M100I	M 1" INV	20	M 1"	31,37
08207B20RL034	R/L 3/4"	20	M 1"	27,31
08207B20RL100	R/L 1"	20	M 1"	30,13

- * M conexión mediante manguito
- * R/L conexión mediante racor loco

Válvula de salida esfera teflonada manual antirretorno con purga

Código	Contador *	DN	Salida	Precio €
08201B20	M 3/4" INV	20	M 1"	26,62
08207B20P	H 3/4"	20	M 1"	29,25
08207B20034IP	M 3/4" INV	20	M 1"	31,12
08207B20100IP	M 1" INV	20	M 1"	35,70
08207B15RL034P	R/L 3/4"	15	M 3/4"	14,40
08207B20RL034P	R/L 3/4"	20	M 1"	27,83
08207B20RL100P	R/L 1"	20	M 1"	31,17

- * M conexión mediante manguito
- * R/L conexión mediante racor loco

Válvulas de salida con conexión para tubería PE

Válvula de salida vertical manual antirretorno



Código	Contador *	DN	Salida	Precio €
082081520	M LL13	15	PE20	24,17
082081525	M LL13	15	PE25	25,60
082082025	M 1" INV - H 3/4"	20	PE25	32,05
082082025R	M 1" INV	20	PE25	38,06
082082025RL034R	R/L 3/4"	20	PE25	48,16
082082025RL100R	R/L 1"	20	PE25	54,13
082082032	M 1" INV - H 3/4"	20	PE32	39,30
082082032R	M 1" INV	20	PE32	46,35
082082032RL034R	R/L 3/4"	20	PE32	49,32
082082032RL100R	R/L 1"	20	PE32	55,22

* M conexión mediante manguito

* R/L conexión mediante racor loco

Válvula de salida vertical de asiento manual con purga ensamblada



Código	Contador *	DN	Salida	Precio €
082081520P	M LL13	15	PE20	36,23
082081525P	M LL13	15	PE25	38,02
082082025P	1" INV	20	PE25	50,35
082082032P	1" INV	20	PE32	61,73

* M conexión mediante manguito

* R/L conexión mediante racor loco

Válvula de salida vertical de asiento manual con purga incorporada



Código	Contador *	DN	Salida	Precio €
082102025P	H 3/4"	20	PE25	42,51
082102025PR	M 1" INV	20	PE25	48,68
082102025RL034PR	R/L 3/4"	20	PE25	53,40
082102025RL100PR	R/L 1"	20	PE25	59,01
082102032P	H 3/4"	20	PE32	52,12
082102032PR	M 1" INV	20	PE32	61,46
082102032RL034PR	R/L 3/4"	20	PE32	65,40
082102032RL100PR	R/L 1"	20	PE32	73,23

* M conexión mediante manguito

* R/L conexión mediante racor loco



Opción ajuste hexagonal

Válvulas de salida con conexión para tubería PE

Válvula de salida esfera teflonada manual antirretorno



Código	Contador *	DN	Salida	Precio €
08208B2025	H 3/4"	20	PE25	25,65
08208B2025M034I	M 3/4" INV	20	PE25	30,02
08208B2025M100I	M 1" INV	20	PE25	34,39
08208B2025RL034	R/L 3/4"	20	PE25	27,85
08208B2025RL100	R/L 1"	20	PE25	30,57
08208B2032	H 3/4"	20	PE32	31,10
08208B2032M034I	M 3/4" INV	20	PE32	33,78
08208B2032M100I	M 1" INV	20	PE32	36,20
08208B2032RL034	R/L 3/4"	20	PE32	37,05
08208B2032RL100	R/L 1"	20	PE32	40,35

* M conexión mediante manguito
 * R/L conexión mediante racor loco

Válvula de salida esfera teflonada manual antirretorno con purga



Código	Contador *	DN	Salida	Precio €
08208B2025P	H 3/4"	20	PE25	37,19
08208B2025M034IP	M 3/4" INV	20	PE25	43,52
08208B2025M100IP	M 1" INV	20	PE25	49,86
08208B2025RL034P	R/L 3/4"	20	PE25	40,38
08208B2025RL100P	R/L 1"	20	PE25	44,32
08208B2032P	H 3/4"	20	PE32	40,31
08208B2032M034IP	M 3/4" INV	20	PE32	46,08
08208B2032M100IP	M 1" INV	20	PE32	49,60
08208B2032RL034P	R/L 3/4"	20	PE32	49,60
08208B2032RL100P	R/L 1"	20	PE32	51,87

* M conexión mediante manguito
 * R/L conexión mediante racor loco



Opción **ajuste hexagonal**

Válvulas de esfera Gatell

Válvula esfera teflonada Gatell roscada

	Código	Medida	Precio €
	06VECHH034	H-H 3/4" Cuadradillo 30x30	22,06
	06VECHH012	H-H 1/2" Cuadradillo 30x30	25,11
	06VECHH100	H-H 1" Cuadradillo 30x30	26,62

*Consultar modelos rosca macho-hembra

También disponible:

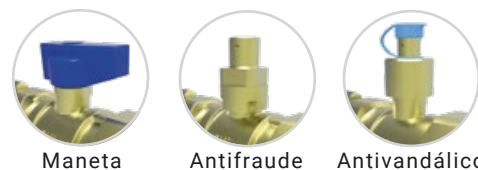

Maneta

Antifraude

Antivandálico

Válvula esfera teflonada Gatell con conexión para tubería PE

	Código	Medida	Precio €
	06VECPE20PE20	PE20 x PE20 Cuadradillo 30x30	29,12
	06VECPE25PE25	PE25 x PE25 Cuadradillo 30x30	37,08
	06VECPE32PE32	PE32 x PE32 Cuadradillo 30x30	48,05

También disponible:

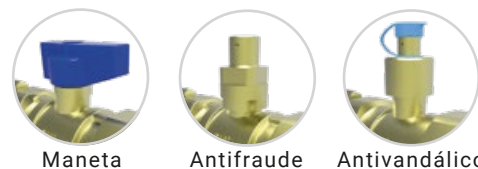

Maneta

Antifraude

Antivandálico

Opción ajuste hexagonal



Válvula esfera entrada roscada racor loco H-H

	Código	Medida	Precio €
	BH362034	H 3/4"- H 3/4"	Consultar
	BH362100	H 1"- H 1"	Consultar

Válvula esfera entrada roscada racor loco M-H

	Código	Medida	Precio €
	BH363034	H 3/4"- H 3/4"	Consultar
	BH363100	H 1"- H 1"	Consultar

Válvulas de esfera Gatell

Válvula esfera entrada roscada racor loco telescópico H-H



Código	Medida	Precio €
BH364012034	H 1/2"- H 3/4"	Consultar
BH364034100	H 3/4"- H 1"	Consultar
BH364100	H 1"- H 1"	Consultar

Válvula esfera entrada roscada racor loco H-H con antirretorno



Código	Medida	Precio €
BH365012034	H 1/2"- H 3/4"	Consultar
BH365034	H 3/4"- H 3/4"	Consultar
BH365034100	H 3/4"- H 1"	Consultar

Válvula esfera entrada acodada roscada racor loco M-H



Código	Medida	Precio €
BH353034	M 3/4"- H 3/4"	Consultar
BH353100	M 1"- H 1"	Consultar

Válvula esfera entrada PE roscada racor loco H



Código	Medida	Precio €
BH500025034	H 3/4"- PE25	Consultar
BH500032034	H 3/4"-PE32	Consultar
BH500025100	H 1"-PE25	Consultar
BH500032100	H 1"-PE32	Consultar
BH500032114	H 1 1/4"-PE32	Consultar
BH500040114	H 1 1/4"-PE40	Consultar
BH500050112	H 1 1/2"-PE50	Consultar

Válvulas de esfera Gatell

Válvula esfera salida roscada racor loco H-H



Código	Medida	Precio €
BH362034	H 3/4" - H 3/4"	Consultar
BH362100	H 1" - H 1"	Consultar

Válvula esfera salida roscada racor loco H-H con antirretorno



Código	Medida	Precio €
BH317034	H 3/4" - H 3/4"	Consultar
BH317100	H " - H 1"	Consultar

Válvula esfera salida acodada roscada racor loco H-M



Código	Medida	Precio €
BH565034	H 3/4" - M 3/4"	Consultar
BH565100	H " - M 1"	Consultar

Válvula esfera salida PE roscada racor loco H con antirretorno



Código	Medida	Precio €
BHX165	H 3/4" - PE25	Consultar

Válvula esfera salida PE roscada racor loco H



Código	Medida	Precio €
BH500025034	H 3/4" - PE25	Consultar
BH500032034	H 3/4" - PE32	Consultar
BH500025100	H 1" - PE25	Consultar
BH500032100	H 1" - PE32	Consultar
BH500032114	H 1 1/4" - PE32	Consultar
BH500040114	H 1 1/4" - PE40	Consultar
BH500050112	H 1 1/2" - PE50	Consultar

Accesorios para válvulas

Manguito



Código	DN	Medida	Precio €
08MANLL13012	15	LL13 - 1/2"	4,74
08MANLL13LL13	15	LL13 - LL13	4,52
08MANLL13034	15	LL13 - 3/4"	2,68
08MANLL13078	15	LL13 - 7/8"	3,31
08MANLL13100	15	LL13 - 1"	5,11
08MAN100LL13	20	1" - LL13	6,21
08MAN100034	20	1" - 3/4"	4,56
08MAN100078	20	1" - 7/8"	5,48
08MAN100100	20	1" - 1"	4,56
08MAN100114	20	1" - 1 1/4"	12,50
08MAN034LL13	20	3/4" - LL13	4,24
08MAN034034	20	3/4" - 3/4"	2,68
08MAN034078	20	3/4" - 7/8"	5,48
08MAN034100	20	3/4" - 1"	4,56

Racor contador

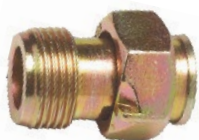

Código	Medida	Precio €
8T011	3/4" x 1/2"	4,64
8T011FJ	3/4" x 3/4"	6,90
8T011FJR	3/4" x 3/4" c/ Ret.	8,40
8T012	7/8" x 1/2"	6,80
8T012FJ	7/8" x 3/4"	7,30
8T009C	1" x 3/4"	7,50
8T009A	1" x 3/4" c/ Ret.	11,20

Purga válvula salida



08PUR15



08PUR20

Código	DN	Precio €
08PUR15	15	9,85
08PUR20	20	18,30

Filtro válvula entrada (Tapón precintable)



Código	DN	Precio €
08FIL15	15	24,50
08FIL20	20	44,10

Caño libre



Código	Longitud	Medida	Precio €
04CL034034	115mm	3/4" - 3/4"	7,47
04CL078034	115mm	7/8" - 3/4"	10,61
04CL100100	115mm	1" - 1"	11,48

Caño ciego



Código	Longitud	Medida	Precio €
04CC034034	115mm	3/4" - 3/4"	6,72
04CC078034	115mm	7/8" - 3/4"	9,56
04CC100100	115mm	1" - 1"	10,34

Recambios para válvulas

Montura manual antirretorno (pisoncillo metálico)

	Código	DN	Precio €
	08MON15M	15	9,93
	08MON20	20	13,80
	08MON20B *	20	Consultar

* Montura modelo antiguo Gatell DN20

Pisoncillo EPDM/metálico

	Código	DN	Precio €
	08F008	15/E	0,36
	08F017V	15/M	2,87
	8VPV070	20/M	3,45

Montura manual antirretorno (pisoncillo EPDM)

	Código	DN	Precio €
	08MON15	15	7,77

Válvula de retención para válvula contador

	Código	Medida	Precio €
	VR32104	M 3/4"-H 3/4"	10,91

Montura antifraude y antirretorno (pisoncillo EPDM)

	Código	DN	Precio €
	08MON15AF	15	10,53

Montura válvula manual antirretorno para válvula VD (pisoncillo metálico)

	Código	DN	Precio €
	8V003	20	19,43

Montura antifraude y antiretorno (pisoncillo metálico)

	Código	DN	Precio €
	08MON15AFM	15	13,65

Montura válvula manual antirretorno y antifraude para válvula VD (pis. metálico)

	Código	DN	Precio €
	8V006	20	16,15

Montura válvula salida vertical

	Código	DN	Precio €
	08MON15V	15	12,17
	08MON20V	20	13,90

Montura válvula salida vertical para válvula VD

	Código	DN	Precio €
	8V004	20	17,36

Sistemas antifraude

Llave de maniobra antifraude

Código	DN	Precio €
08LO41	15/20	Consultar



Tornillo antifraude válvula de entrada

Código	Precio €
08F031AA	Consultar



*Gestión con Multitool 08MTAF o con Llave maniobra magnética 08F032AM

Cuadrillo antifraude

Código	DN	Precio €
08SAC	15/20	Consultar



Llave maniobra magnética para tornillo antifraude de llave de entrada

Código	Precio €
08F032AM	Consultar



Kit antivandálico para válvulas de bola

Código	DN	Precio €
08SACAV	20	Consultar



Pletina ciega antifraude

Código	Medida	Precio €
04CIEGAAF	Galva 6mm	Consultar
04CIEGA20AF	Galva 20mm	Consultar
04CIEGAAFI	Inox 6mm	Consultar



Tapón obturador antifraude

Código	Descripción	Precio €
08F093	Tapón Obturador	Consultar
08F121	Alargadera* 45mm	Consultar
08F122	Alargadera* 55mm	Consultar



*Evita que el tapón se pueda colar en el interior de la batería por vandalismo

Cabezal soporte de tapón obturador antifraude

Código	Precio €
08F094	Consultar



Tapón corte de suministro universal

Código	Medida	Precio €
08F113	3/4"	Consultar
08F114	1"	Consultar
08F119	LL13	Consultar



Llave de accionamiento del tapón de corte

Código	Precio €
08F112	Consultar



Opción para todos los antifraudes:



Llavín

Magnético

Mecánica

Precintos para contador

Precinto Rojo

	Código	Unidad/Caja	Precio €
	XP001	Caja x 500 ud.	0,67 x ud

* Disponibilidad de marcaje personalizado

Precinto Azul

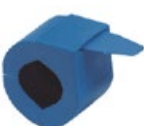
	Código	Unidad/Caja	Precio €
	XP004	Caja x 500 ud.	0,67 x ud

* Disponibilidad de marcaje personalizado

Precinto giratorio tipo mariposa

	Código	Unidad/Caja	Precio €
	XP101G	Caja x 100 ud.	0,65 x ud
	XP101GC	Caja x 100 ud.	0,70 x ud
	XP102G	Caja x 100 ud.	0,72 x ud
	XP102GC	Caja x 100 ud.	0,77 x ud

* Disponibilidad de marcaje personalizado

Nuevo modelo con **cable cortado** que agiliza el montaje

Precinto cable metálico plastificado, remache y máquina

	Código	Descripción	Unidad/Caja	Precio €
	XP201	Precinto cable	Rollo x 400mts	0,43 x mt
	XP202	Precinto remache	Caja x 400 ud.	0,37 x ud
	XP203	Máquina remachar	1	480,00

Precinto contador agua azul Gatell

	Código	DN	Unidad/Caja	Precio €
	XP601	23 a 45mm	Caja x 500 ud.	2,05 x ud

* Disponibilidad de marcaje personalizado

Precinto tipo bandera ajustable

	Código	Unidad/Caja	Precio €
	XP401	Caja x 1000 ud.	0,90 x ud



* Disponibilidad de marcaje personalizado

ELEMENTOS PARA ALOJAMIENTO



Arquetas de registro

Arqueta para llave de acometida

	Código	Descripción	Medida	Precio €
 PE  Fundición	AP2020NA	Arqueta Polipropileno grifo c/ base	20 x 20	105,49
	21FAS	Arqueta Fundición	Pequeña	40,54
	21FAB	Arqueta Fundición	Grande	124,02
	21FAH	Arqueta Fundición	Hidrante	188,41

Arqueta para montajes

	Código	Descripción	Medida	Precio €
	21ARQ482625C	Polipropileno con tapa composite - B125	48 x 26 x 25	Consultar

Montajes con válvula de cuadrado 30x30

Entrada	Salida	Conjunto
PE25	PE25	
PE32	PE32	
H3/4"	H3/4"	
PE25	H3/4"	

Entrada	Salida	Conjunto
H3/4"	PE25	
M3/4"	M3/4"	
H3/4"	M3/4"	
M3/4"	PE25	

También disponible:

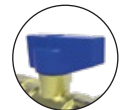

Maneta



Antifraude



Antivandálico

*Consultar por otras opciones

Arqueta

	Código	Descripción	Medida	Precio €
	20ARQUEG40	Arqueta	40 x 40	222,32
	20ARQUEG50	Arqueta	50 x 50	227,32
	20ARQUEG60	Arqueta	60 x 60	278,77

Marco

	Código	Descripción	Medida	Precio €
	20MARCOG40	Marco	40 x 40	100,27
	20MARCOG50	Marco	50 x 50	106,05
	20MARCOG60	Marco	60 x 60	112,07

Tapa Plancha

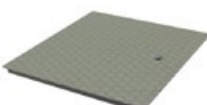
	Código	Descripción	Medida	Precio €
	20TPLG40	Tapa plancha	40 x 40	147,77
	20TPLG50	Tapa plancha	50 x 50	195,02
	20TPLG60	Tapa plancha	60 x 60	238,73

Tapa Terrazo

	Código	Descripción	Medida	Precio €
	20TTEG40	Tapa terrazo	40 x 40	131,25
	20TTEG50	Tapa terrazo	50 x 50	149,87
	20TTEG60	Tapa terrazo	60 x 60	224,17

Armarios de registro

Armario de análisis de agua

	Código	Descripción	Medida	PE	Precio €
	CPSS3353631	Armario de poliéster con montaje	300x450mm	PE25	322,88
	CPSS3353631VB	Armario de poliéster y válvula bola	300x450mm	PE25	315,25
	ACPSS3353631CP	Armario de hormigón con puerta poliéster	300x450mm	PE25	521,33
	ACPSS3353631CPVB	Armario de horm., puerta poliéster y valv. bola	300x450mm	PE25	505,50

*Posibilidad de marcaje laser personalizado

Armario poliéster

	Código	Descripción	Medida	Precio €
	CPG2350	Armario de poliéster	250x350x160mm	53,66
	CPG2350A	Armario de poliéster con aislamiento total	250x350x160mm	68,90
	CPG2350P	Armario de poliéster con aislamiento en puerta	250x350x160mm	60,71
	CPG3450	Armario de poliéster	300x450x160mm	55,08
	CPV3450	Armario de poliéster con ventana	300x450x160mm	63,75
	CPG3450A	Armario de poliéster con aislamiento total	300x450x160mm	72,97
	CPG3450P	Armario de poliéster con aislamiento en puerta	300x450x160mm	67,35
	CPEG3450	Armario de poliéster estrecho	300x450x102mm	55,44
	CPG5050AL	Armario de poliéster	530x530x190mm	151,24
	CPG5070AL	Armario de poliéster	530x700x195mm	194,94

Hay tres frontales standard: liso, pictograma con grifo o con ventanilla rectangular. **Son posibles rotulaciones especiales, bajo demanda.**

Armario poliestireno

	Código	Descripción	Medida	Precio €
	CPG3450E	Armario de poliestireno	350x500x200mm	42,22
	CPV3450E	Armario de poliestireno con ventana	350x500x200mm	45,94
	PPG3450E+8Q004	Armario de poliestireno	350x500x140mm	38,23
	CPG5050E	Armario de poliestireno	540x540x200mm	119,22
	CPV5050E	Armario de poliestireno con ventana	540x540x200mm	137,37

*Posibilidad de marcaje laser personalizado

Armario chapa acero

	Código	Descripción	Medida	Precio €
	CFP5060	Armario chapa de acero	500x600mm	230,28
	CFP5061	Armario chapa de acero	500x600mm SGAB	276,57
	CFP5064	Armario chapa de acero	500x600mm TRI 7mm	222,25
	CFP5091	Armario chapa de acero	500x900mm SGAB	763,20

*Posibilidad de marcaje laser personalizado

Armario hormigón

	Código	Descripción	Medida	Precio €
	ACPG2350	Armario hormigón con puerta poliéster	250x350mm	153,81
	ACPG3450	Armario hormigón con puerta poliéster	300x450mm	168,38
	ACFP4040	Armario hormigón con puerta chapa de acero	400x400mm	296,18
	ACFP5060	Armario hormigón con puerta chapa de acero	500x600mm	363,07
	ACPGA3450CP	Armario horm. con armario poliéster, aislamiento total	300x450mm	286,78
	ACPG3450CP	Armario hormigón con armario poliéster	300x450mm	257,35
	ACPEG3450CP	Armario hormigón con armario poliéster estrecho	300x450mm	216,19

*Posibilidad de marcaje laser personalizado

Puertas de registro

Puertas de registro de poliéster

	Código	Descripción	Medida	Precio €
	PPG2350	Puerta registro poliéster	250x350mm	30,75
	PPG2350A	Puerta registro poliéster con aislamiento	250x350mm	38,52
	PPG3450	Puerta registro poliéster	300x450mm	35,67
	PPG3450A	Puerta registro poliéster con aislamiento	300x450mm	41,77
	PPV3450	Puerta registro poliéster con ventana	300x450mm	39,20

Hay tres frontales standard: liso, pictograma con grifo o con ventanilla rectangular. **Son posibles rotulaciones especiales, bajo demanda.**

Puertas de registro de poliestireno

	Código	Descripción	Medida	Precio €
	PPG3450E	Puerta registro poliestireno	300x450mm	28,13
	PPV3450E	Puerta registro poliestireno con ventana	300x450mm	31,85

*Posibilidad de marcaje laser personalizado

Puertas de registro de aluminio

	Código	Descripción	Medida	Precio €
	PAG2536	Puerta registro aluminio	250x350mm	65,70
	PAG3031	Puerta registro aluminio	300x300mm	70,92
	PAG3046	Puerta registro aluminio	300x450mm	80,10

*Posibilidad de marcaje laser personalizado

Fabricación de puertas y armarios **a medida**

Posibilidad de fabricar puertas y armarios de chapa en **acero inoxidable**

Llaves

Llave cierre triang. 7mm bicrom.

	Código	Precio €
	8L021	6,36

LLlave cierre cuadr. tornillo hembra zinc.

	Código	Precio €
	8L022	7,13

Llave plástico triangular

	Código	Medida	Precio €
	8L038	7mm	0,44
	8L039	9mm	0,44

Llave Zinc Allen nº 6

	Código	Precio €
	8L019	0,62

Puertas de registro

Puertas de registro de chapa acero

Código	Descripción	Medida	Precio €
PFP2350	Puerta registro chapa de acero	250x350mm STD	79,90
PFP3030	Puerta registro chapa de acero	300x300mm STD	95,20
PFP3032	Puerta registro chapa de acero	300x300mm CFE	115,28
PFP3033	Puerta registro chapa de acero	300x300mm CGE	116,40
PFP3450	Puerta registro chapa de acero	300x450mm STD	97,90
PFP4030	Puerta registro chapa de acero	400x300mm STD	97,50
PFP4032	Puerta registro chapa de acero	400x300mm CFE	121,30
PFP4033	Puerta registro chapa de acero	400x300mm CGE	121,30
PFP4040	Puerta registro chapa de acero	400x400mm STD	98,20
PFP4050	Puerta registro chapa de acero	400x500mm STD	105,63
PFP5040	Puerta registro chapa de acero	500x400mm STD	101,20
PFP5042	Puerta registro chapa de acero	500x400mm CFE	130,33
PFP5043	Puerta registro chapa de acero	500x400mm CGE	130,33
PFP5044	Puerta registro chapa de acero	500x400mm TRI 7mm	101,20
PFP5060	Puerta registro chapa de acero	500x600mm STD	108,10
PFP5061	Puerta registro chapa de acero	500x600mm SGAB	122,46
PFP5062	Puerta registro chapa de acero	500x600mm CFE	140,22
PFP5063	Puerta registro chapa de acero	500x600mm CGE	140,22
PFP5064	Puerta registro chapa de acero	500x600mm TRI 7mm	104,20
PFP5090	Puerta registro chapa de acero	500x900mm STD	307,25
PFP5091	Puerta registro chapa de acero	500x900mm AGBAR	290,50
PFP6050	Puerta registro chapa de acero	600x500mm STD	108,10
PFP6052	Puerta registro chapa de acero	600x500mm CFE	140,22
PFP6053	Puerta registro chapa de acero	600x500mm CGE	140,22
PFP6054	Puerta registro chapa de acero	600x500mm TRI 7mm	108,10
PFP60131	Puerta registro chapa de acero	600x1300mm AGBAR	686,84
PFP9050	Puerta registro chapa de acero	900x500mm STD	149,80
PFP9052	Puerta registro chapa de acero	900x500mm CFE	184,20
PFP9053	Puerta registro chapa de acero	900x500mm CGE	184,20
PFP9054	Puerta registro chapa de acero	900x500mm TRI 7mm	149,80
PFP10061	Puerta registro chapa de acero	1000x600mm AGBAR	456,50
PFP12050	Puerta registro chapa de acero	1200x500mm STD	258,60
PFP12052	Puerta registro chapa de acero	1200x500mm CFE	280,14
PFP12053	Puerta registro chapa de acero	1200x500mm CGE	280,14
PFP15061	Puerta registro chapa de acero	1500x600mm AGBAR	515,20

Fabricación de puertas y armarios **a medida**

Posibilidad de fabricar puertas y armarios de chapa en **acero inoxidable**

Registros panelables

Armarios de chapa de acero panelables



Código	Medida	Precio €
CFPPAN2350	250x300mm STD / TRI 7mm	331,83
CFPPAN3450	300x450mm STD / TRI 7mm	368,70
CFPPAN5060	500x600mm STD / TRI 7mm	458,20
CFPPAN50100	500x1000mm STD / TRI 7mm	957,15

Fabricación de armarios **a medida**

Puertas de chapa de acero panelables



Código	Medida	Precio €
PFPPAN2350	250x300mm STD / TRI 7mm	153,40
PFPPAN3450	300x450mm STD / TRI 7mm	170,45
PFPPAN5060	500x600mm STD / TRI 7mm	202,35
PFPPAN50100	500x1000mm STD / TRI 7mm	598,21

Fabricación de puertas **a medida**

Tapas de registro

Tapas de poliéster



Código	Descripción	Medida	Precio €
TPA2516CH	Poliéster con cierre	250x160mm	Consultar
TPA2516H	Poliéster	250x160mm	Consultar
TPA2828H	Poliéster	280x280mm	Consultar
TPA2815H	Poliéster	280x150mm	Consultar
TPA2815CH	Poliéster con cierre	280x150mm	Consultar

Tapas de aluminio



Código	Descripción	Medida	Precio €
TAE2015	Aluminio	150x200mm	Consultar
TAE3030	Aluminio	280x280mm	Consultar

Tapas de fundición



Código	Descripción	Medida	Precio €
THTC0250	Fundición B125	250x250mm	Consultar
THTC0400	Fundición B125	400x400mm	Consultar
THTR0600	Fundición B125 redonda	600x450mm	Consultar
THTC0800	Fundición B125 redonda	800x640mm	Consultar
TPA2815CH	Fundición D400 redonda	850x645mm	Consultar

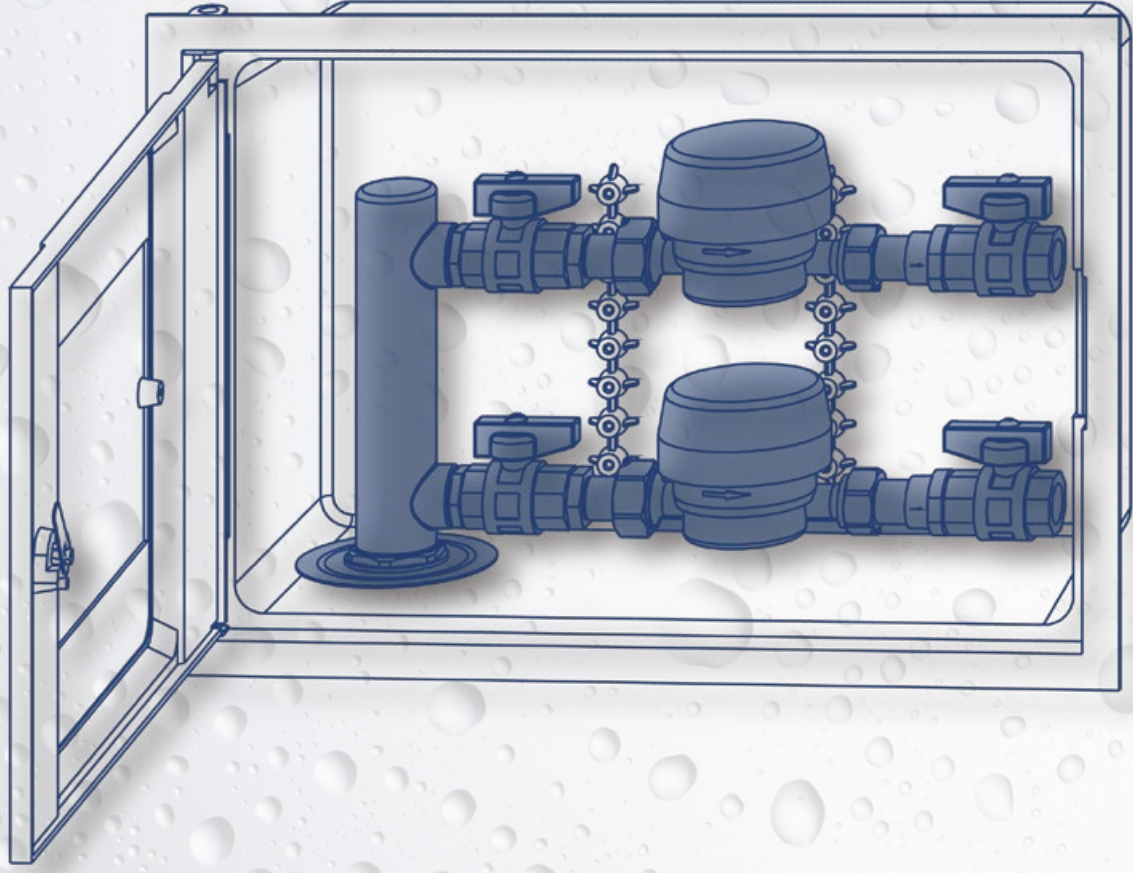

ANEXO: Montajes

Montajes para cofres y armarios de hormigón

VÁLVULAS MODELO DN15
Características técnicas:

- Montaje para contador equipado con soporte de acero inoxidable, válvula de paso angular de entrada, rácores para la sujeción del contador y válvula de paso angular con función antirretorno en la salida.

VÁLVULA DE ASIENTO DN15 PASO ANGULAR

CONTADOR 13.115 (7/8"-3/4")

CÓDIGO	CONEXIONES	
	ACOMETIDA	ABONADO
5MC8099	M 3/4"	M 3/4" tumbada con antirretorno

CONTADOR 15.115 (3/4"-3/4")

CÓDIGO	CONEXIONES	
	ACOMETIDA	ABONADO
5MC8101	M 3/4"	M 3/4" tumbada con antirretorno

CONTADOR 13.115 (7/8"-3/4")

CÓDIGO	CONEXIONES	
	ACOMETIDA	ABONADO
5MC8100	M 3/4"	M 3/4" tumbada c/ purga y antirretorno

CONTADOR 15.115 (3/4"-3/4")

CÓDIGO	CONEXIONES	
	ACOMETIDA	ABONADO
5MC8004	M 3/4"	M 3/4" tumbada c/ purga y antirretorno

VÁLVULA DE ASIENTO DN15 ANTIFRAUDE

CONTADOR 13.115 (7/8"-3/4")

CÓDIGO	CONEXIONES	
	ACOMETIDA	ABONADO
5MC8095	M 3/4"	M 3/4" tumbada con antirretorno

CONTADOR 15.115 (3/4"-3/4")

CÓDIGO	CONEXIONES	
	ACOMETIDA	ABONADO
5MC8092	M 3/4"	M 3/4" tumbada con antirretorno

CONTADOR 13.115 (7/8"-3/4")

CÓDIGO	CONEXIONES	
	ACOMETIDA	ABONADO
5MC8096	M 3/4"	M 3/4" tumbada c/ purga y antirretorno

CONTADOR 15.115 (3/4"-3/4")

CÓDIGO	CONEXIONES	
	ACOMETIDA	ABONADO
5MC8093	M 3/4"	M 3/4" tumbada c/ purga y antirretorno

Consultar por otras opciones de montaje

Montajes para cofres y armarios de hormigón

SEGÚN EL CÓDIGO TÉCNICO DE EDIFICACIÓN (CTE)
Características técnicas:

- Montaje para contador equipado con soporte de acero inoxidable, válvula de paso angular de entrada, rácores para la sujeción del contador y válvula de paso angular con antirretorno en la salida.

VÁLVULA DE ASIENTO DN15 PASO ANGULAR

CONTADOR 13.115 (7/8"-3/4")

CÓDIGO	CONEXIONES	
	ACOMETIDA	ABONADO
5MC8098	M 3/4"	M 3/4" CTE tumbada con antirretorno y purga

CONTADOR 15.115 (3/4"-3/4")

CÓDIGO	CONEXIONES	
	ACOMETIDA	ABONADO
5MC8005	M 3/4"	M 3/4" CTE tumbada con antirretorno y purga

VÁLVULA DE ASIENTO DN15 ANTIFRAUDE

CONTADOR 13.115 (7/8"-3/4")

CÓDIGO	CONEXIONES	
	ACOMETIDA	ABONADO
5MC8097	M 3/4"	M 3/4" CTE tumbada con antirretorno y purga

CONTADOR 15.115 (3/4"-3/4")

CÓDIGO	CONEXIONES	
	ACOMETIDA	ABONADO
5MC8094	M 3/4"	M 3/4" CTE tumbada con antirretorno y purga

Consultar por otras opciones de montaje

Montajes para cofres y armarios de hormigón

SEGÚN EL CÓDIGO TÉCNICO DE EDIFICACIÓN (CTE)
Características técnicas:

- Montaje para contador equipado con soporte de acero inoxidable, válvula de paso angular de entrada, rácores para la sujeción del contador y válvula de paso angular con antirretorno en la salida.

VÁLVULA DE BOLA STANDARD DN20

VÁLVULA DE BOLA DN20 ANTIFRAUDE

CONTADOR 13.115 (7/8"-3/4")

CÓDIGO	CONEXIONES	
	ACOMETIDA	ABONADO
5MC4001	M1" H3/4"	M1" H3/4" antirretorno y doble purga

CONTADOR 13.115 (7/8"-3/4")

CÓDIGO	CONEXIONES	
	ACOMETIDA	ABONADO
5MC4004	M1" H3/4"	M1" H3/4" antirretorno y doble purga

CONTADOR 15.115 (3/4"-3/4")

CÓDIGO	CONEXIONES	
	ACOMETIDA	ABONADO
5MC4002	M1" H3/4"	M1" H3/4" antirretorno y doble purga

CONTADOR 15.115 (3/4"-3/4")

CÓDIGO	CONEXIONES	
	ACOMETIDA	ABONADO
5MC4005	M1" H3/4"	M1" H3/4" antirretorno y doble purga

CONTADOR 20.115 (1"-1")

CÓDIGO	CONEXIONES	
	ACOMETIDA	ABONADO
5MC4003	M1" H3/4"	M1" H3/4" antirretorno y doble purga

CONTADOR 20.115 (1"-1")

CÓDIGO	CONEXIONES	
	ACOMETIDA	ABONADO
5MC4006	M1" H3/4"	M1" H3/4" antirretorno y doble purga

Montajes para cofres y armarios de hormigón

VÁLVULAS MODELO STANDARD DN20
Características técnicas:

- Montaje para contador equipado con soporte de acero inoxidable, válvula de paso angular de entrada, rácores para la sujeción del contador y válvula de paso angular con antirretorno en la salida.

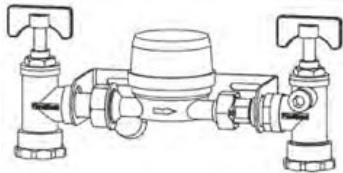
VÁLVULA DE ASIENTO DN20 PASO ANGULAR

CONTADOR 13.115 (7/8"-3/4")

CÓDIGO	CONEXIONES	
	ACOMETIDA	ABONADO
5MC0141	PE25	PE25
5MC0114	PE25	H3/4"
5MC0137	PE32	PE32

CONTADOR 15.115 (3/4"-3/4")

CÓDIGO	CONEXIONES	
	ACOMETIDA	ABONADO
5MC0164	PE25	PE25
5MC0224	PE32	PE32

CONTADOR 20.115 (1"-1")

CÓDIGO	CONEXIONES	
	ACOMETIDA	ABONADO
5MC0176	PE25	PE25
5MC0152	PE32	PE32

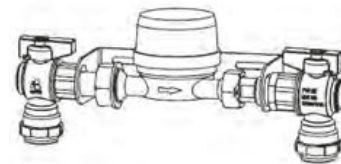
VÁLVULA DE BOLA DN20 PASO ANGULAR

CONTADOR 13.115 (7/8"-3/4")

CÓDIGO	CONEXIONES	
	ACOMETIDA	ABONADO
5MC4141	PE25	PE25
5MC4114	PE25	H3/4"
5MC4137	PE32	PE32

CONTADOR 15.115 (3/4"-3/4")

CÓDIGO	CONEXIONES	
	ACOMETIDA	ABONADO
5MC4164	PE25	PE25
5MC4224	PE32	PE32
5MC4101	H3/4"	H3/4"

CONTADOR 20.115 (1"-1")

CÓDIGO	CONEXIONES	
	ACOMETIDA	ABONADO
5MC4176	PE25	PE25
5MC4152	PE25	H3/4"

Consultar por otras opciones de montaje

Montajes para cofres y armarios de hormigón

VÁLVULAS MODELO ANTIFRAUDE DN20
Características técnicas:

Montaje para contador equipado con soporte de acero inoxidable, válvula de paso angular antifraude en la entrada, rácores para la sujeción del contador y válvula de paso angular con antirretorno en la salida.

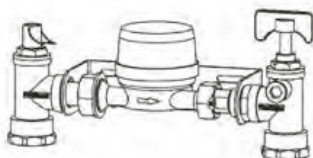
VÁLVULA DE ASIENTO DN20 PASO ANGULAR

CONTADOR 13.115 (7/8"-3/4")

CÓDIGO	CONEXIONES	
	ACOMETIDA	ABONADO
5MC0181	PE25	PE25
5MC0165	PE25	H3/4"
5MC0215	PE32	PE32

CONTADOR 15.115 (3/4"-3/4")

CÓDIGO	CONEXIONES	
	ACOMETIDA	ABONADO
5MC0121	PE32	PE32
5MC0261	PE32	H3/4"- M1"

CONTADOR 20.115 (1"-1")

CÓDIGO	CONEXIONES	
	ACOMETIDA	ABONADO
5MC0623	PE32	H3/4"- M1"
5MC0429	PE25	M3/4"

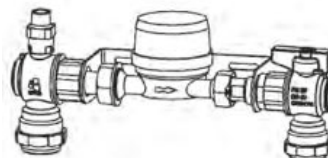
VÁLVULA DE BOLA DN20 PASO ANGULAR

CONTADOR 13.115 (7/8"-3/4")

CÓDIGO	CONEXIONES	
	ACOMETIDA	ABONADO
5MC4181	PE25	PE25
5MC4165	PE25	H3/4"
5MC4215	PE32	PE32

CONTADOR 15.115 (3/4"-3/4")

CÓDIGO	CONEXIONES	
	ACOMETIDA	ABONADO
5MC4121	PE32	PE32
5MC4261	PE32	H3/4"- M1"

CONTADOR 20.115 (1"-1")

CÓDIGO	CONEXIONES	
	ACOMETIDA	ABONADO
5MC4623	PE32	H3/4"- M1"
5MC4429	PE25	M3/4"

Consultar por otras opciones de montaje

Opciones posibles para más de un contador:

5MC0093

Contador 13.115
Armario de poliéster 30x45

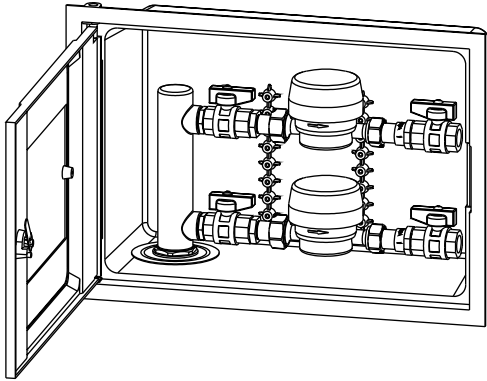

5MC0095

Contador 13.115
Armario de poliéster 30x45

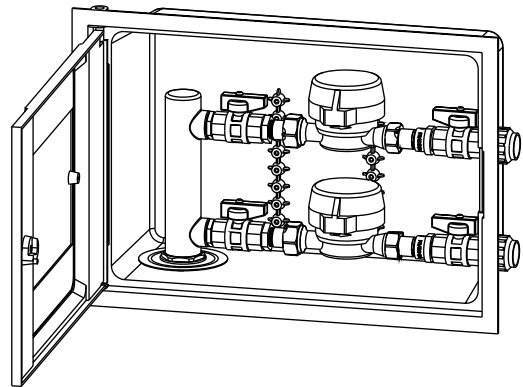

5MC0205

Contador 13.115
Armario de chapa 50x40

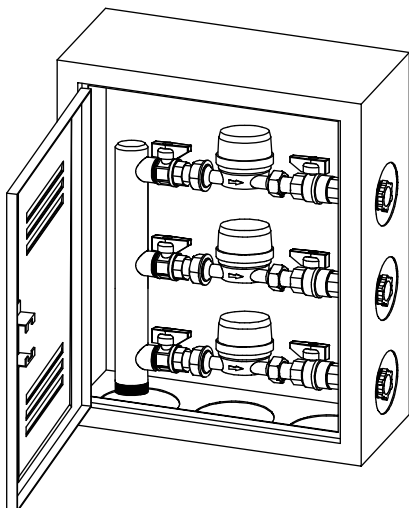

5MC0707

Contador 13.115
Armario de chapa 50x60

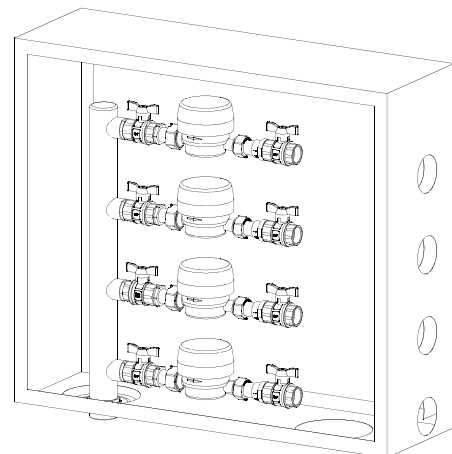

5MC0368

Contador 13.115
Armario de hormigón

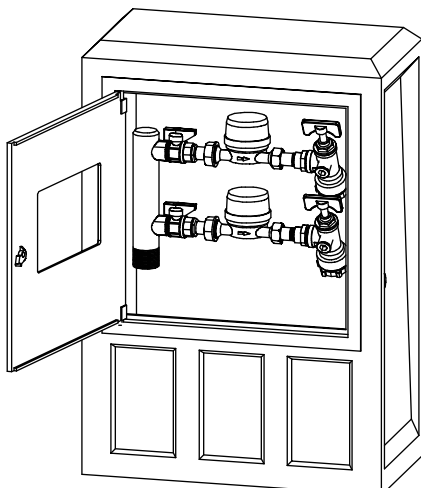

5MC0616

Contador 15.115
Armario de chapa 50x40
Tipo: Minibatería

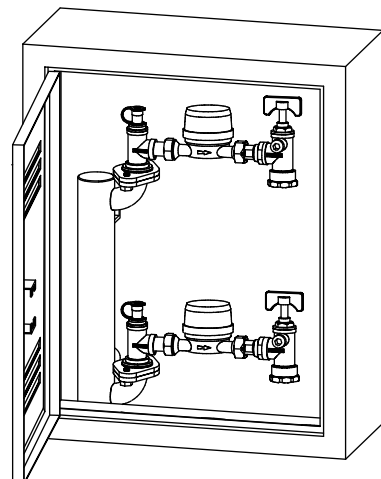

Consultar por otras opciones de montaje



ACCESORIOS PARA ACOMETIDAS DE AGUA



Abrazaderas de reparación

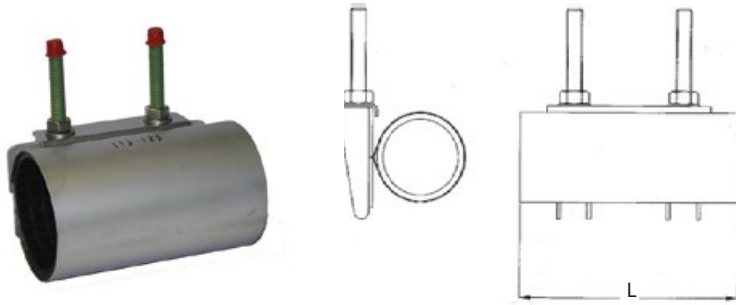

Abrazadera de reparación inox plus 2T

Código	Tolerancia	Longitud	Precio €
21ARIPL048052200	48-52	200 mm	81,90
21ARIPL054058200	54-58	200 mm	84,00
21ARIPL060067100	60-67	100 mm	42,00
21ARIPL060067200	60-67	200 mm	84,00
21ARIPL060067300	60-67	300 mm	123,90
21ARIPL060067400	60-67	400 mm	165,90
21ARIPL067074100	67-74	100 mm	44,10
21ARIPL067074150	67-74	150 mm	71,40
21ARIPL067074200	67-74	200 mm	86,10
21ARIPL067074300	67-74	300 mm	126,00
21ARIPL067074400	67-74	400 mm	168,00
21ARIPL070077100	70-77	100 mm	44,10
21ARIPL070077150	70-77	150 mm	71,40
21ARIPL070077200	70-77	200 mm	88,20
21ARIPL070077300	70-77	300 mm	128,10
21ARIPL070077400	70-77	400 mm	170,10
21ARIPL073080100	73-80	100 mm	46,20
21ARIPL073080150	73-80	150 mm	73,50
21ARIPL073080200	73-80	200 mm	90,30
21ARIPL073080300	73-80	300 mm	130,20
21ARIPL073080400	73-80	400 mm	172,20
21ARIPL076083100	76-83	100 mm	46,20
21ARIPL076083150	76-83	150 mm	73,50
21ARIPL076083200	76-83	200 mm	90,30
21ARIPL076083300	76-83	300 mm	132,30
21ARIPL076083400	76-83	400 mm	174,30
21ARIPL080087100	80-87	100 mm	46,20
21ARIPL080087150	80-87	150 mm	75,60
21ARIPL080087200	80-87	200 mm	92,40
21ARIPL080087300	80-87	300 mm	134,40
21ARIPL080087400	80-87	400 mm	176,40
21ARIPL082089100	82-89	100 mm	46,20
21ARIPL082089150	82-89	150 mm	75,60
21ARIPL082089200	82-89	200 mm	92,40
21ARIPL082089300	82-89	300 mm	134,40
21ARIPL082089400	82-89	400 mm	176,40
21ARIPL087094100	87-94	100 mm	48,30
21ARIPL087094150	87-94	150 mm	77,70
21ARIPL087094200	87-94	200 mm	94,50

Código	Tolerancia	Longitud	Precio €
21ARIPL087094300	87-94	300 mm	136,50
21ARIPL087094400	87-94	400 mm	178,50
21ARIPL088095100	88-95	100 mm	48,30
21ARIPL088095150	88-95	150 mm	77,70
21ARIPL088095200	88-95	200 mm	94,50
21ARIPL088095300	88-95	300 mm	136,50
21ARIPL088095400	88-95	400 mm	178,50
21ARIPL090097100	90-97	100 mm	48,30
21ARIPL090097150	90-97	150 mm	77,70
21ARIPL090097200	90-97	200 mm	94,50
21ARIPL090097300	90-97	300 mm	138,60
21ARIPL090097400	90-97	400 mm	180,60
21ARIPL093100100	93-100	100 mm	48,30
21ARIPL093100150	93-100	150 mm	77,70
21ARIPL093100200	93-100	200 mm	94,50
21ARIPL093100300	93-100	300 mm	138,60
21ARIPL093100400	93-100	400 mm	180,60
21ARIPL095102100	95-102	100 mm	48,30
21ARIPL095102150	95-102	150 mm	79,80
21ARIPL095102200	95-102	200 mm	96,60
21ARIPL095102300	95-102	300 mm	140,70
21ARIPL095102400	95-102	400 mm	182,70
21ARIPL098105100	98-105	100 mm	48,30
21ARIPL098105150	98-105	150 mm	79,80
21ARIPL098105200	98-105	200 mm	96,60
21ARIPL098105300	98-105	300 mm	140,70
21ARIPL098105400	98-105	400 mm	182,70
21ARIPL102112150	102-112	150 mm	81,90
21ARIPL102112200	102-112	200 mm	98,70
21ARIPL102112250	102-112	250 mm	132,30
21ARIPL102112300	102-112	300 mm	144,90
21ARIPL102112400	102-112	400 mm	189,00
21ARIPL106116150	106-116	150 mm	84,00
21ARIPL106116200	106-116	200 mm	100,80
21ARIPL106116250	106-116	250 mm	134,40
21ARIPL106116300	106-116	300 mm	149,10
21ARIPL106116400	106-116	400 mm	193,20
21ARIPL108118150	108-118	150 mm	86,10
21ARIPL108118200	108-118	200 mm	102,90

Abrazaderas de reparación



Abrazadera de reparación inox plus 2T

Código	Tolerancia	Longitud	Precio €
21ARIPL108118250	108-118	250 mm	136,50
21ARIPL108118300	108-118	300 mm	151,20
21ARIPL108118400	108-118	400 mm	197,40
21ARIPL113123150	113-123	150 mm	88,20
21ARIPL113123200	113-123	200 mm	105,00
21ARIPL113123250	113-123	250 mm	140,70
21ARIPL113123300	113-123	300 mm	155,40
21ARIPL113123400	113-123	400 mm	201,60
21ARIPL118128150	118-128	150 mm	90,30
21ARIPL118128200	118-128	200 mm	107,10
21ARIPL118128250	118-128	250 mm	142,80
21ARIPL118128300	118-128	300 mm	157,50
21ARIPL118128400	118-128	400 mm	205,80
21ARIPL120131150	120-131	150 mm	90,30
21ARIPL120131200	120-131	200 mm	109,20
21ARIPL120131250	120-131	250 mm	144,90
21ARIPL120131300	120-131	300 mm	161,70
21ARIPL120131400	120-131	400 mm	210,00
21ARIPL125135150	125-135	150 mm	92,40
21ARIPL125135200	125-135	200 mm	111,30
21ARIPL125135250	125-135	250 mm	149,10
21ARIPL125135300	125-135	300 mm	163,80
21ARIPL125135400	125-135	400 mm	215,80
21ARIPL132142150	132-142	150 mm	96,60
21ARIPL132142200	132-142	200 mm	115,50
21ARIPL132142250	132-142	250 mm	153,30
21ARIPL132142300	132-142	300 mm	170,10
21ARIPL132142400	132-142	400 mm	222,60
21ARIPL135150150	135-150	150 mm	100,80
21ARIPL135150200	135-150	200 mm	119,70
21ARIPL135150250	135-150	250 mm	159,60
21ARIPL135150300	135-150	300 mm	176,40
21ARIPL135150400	135-150	400 mm	231,00
21ARIPL145155150	145-155	150 mm	102,90
21ARIPL145155200	145-155	200 mm	123,90
21ARIPL145155250	145-155	250 mm	163,80
21ARIPL145155300	145-155	300 mm	180,60
21ARIPL145155400	145-155	400 mm	237,30
21ARIPL145155500	145-155	500 mm	296,10
21ARIPL151161150	151-161	150 mm	105,00
21ARIPL151161200	151-161	200 mm	126,00
21ARIPL151161250	151-161	250 mm	165,90
21ARIPL151161300	151-161	300 mm	184,80
21ARIPL151161400	151-161	400 mm	239,40

Código	Tolerancia	Longitud	Precio €
21ARIPL151161500	151-161	500 mm	300,30
21ARIPL151161600	151-161	600 mm	361,20
21ARIPL159170200	159-170	200 mm	128,10
21ARIPL159170250	159-170	250 mm	170,10
21ARIPL159170300	159-170	300 mm	186,90
21ARIPL159170400	159-170	400 mm	243,66
21ARIPL159170500	159-170	500 mm	304,50
21ARIPL159170600	159-170	600 mm	365,40
21ARIPL165175200	165-175	200 mm	130,20
21ARIPL165175250	165-175	250 mm	172,20
21ARIPL165175300	165-175	300 mm	191,10
21ARIPL165175400	165-175	400 mm	247,80
21ARIPL165175500	165-175	500 mm	310,80
21ARIPL165175600	165-175	600 mm	371,70
21ARIPL167177200	167-177	200 mm	130,20
21ARIPL167177250	167-177	250 mm	174,30
21ARIPL167177300	167-177	300 mm	191,10
21ARIPL167177400	167-177	400 mm	249,90
21ARIPL167177500	167-177	500 mm	312,90
21ARIPL167177600	167-177	600 mm	375,90
21ARIPL170180200	170-180	200 mm	132,30
21ARIPL170180250	170-180	250 mm	174,30
21ARIPL170180300	170-180	300 mm	193,20
21ARIPL170180400	170-180	400 mm	252,00
21ARIPL170180500	170-180	500 mm	315,00
21ARIPL170180600	170-180	600 mm	378,00
21ARIPL174184200	174-184	200 mm	134,40
21ARIPL174184250	174-184	250 mm	178,50
21ARIPL174184300	174-184	300 mm	197,40
21ARIPL174184400	174-184	400 mm	256,20
21ARIPL174184500	174-184	500 mm	321,30
21ARIPL174184600	174-184	600 mm	384,30
21ARIPL176186200	176-186	200 mm	136,50
21ARIPL176186250	176-186	250 mm	180,60
21ARIPL176186300	176-186	300 mm	199,50
21ARIPL176186400	176-186	400 mm	260,40
21ARIPL176186500	176-186	500 mm	325,50
21ARIPL176186600	176-186	600 mm	390,60
21ARIPL180191200	180-191	200 mm	138,60
21ARIPL180191250	180-191	250 mm	182,70
21ARIPL180191300	180-191	300 mm	203,70
21ARIPL180191400	180-191	400 mm	264,60
21ARIPL180191500	180-191	500 mm	329,70
21ARIPL180191600	180-191	600 mm	396,90

Abrazaderas de reparación



Abrazadera de reparación inox plus 2T

Código	Tolerancia	Longitud	Precio €
21ARIPL186196200	186-196	200 mm	140,70
21ARIPL186196250	186-196	250 mm	186,90
21ARIPL186196300	186-196	300 mm	205,80
21ARIPL186196400	186-196	400 mm	268,80
21ARIPL186196500	186-196	500 mm	336,00
21ARIPL186196600	186-196	600 mm	403,20
21ARIPL193203200	193-203	200 mm	142,80
21ARIPL193203250	193-203	250 mm	189,00
21ARIPL193203300	193-203	300 mm	207,90
21ARIPL193203400	193-203	400 mm	273,00
21ARIPL193203500	193-203	500 mm	340,20
21ARIPL193203600	193-203	600 mm	409,50
21ARIPL200210200	200-210	200 mm	144,90
21ARIPL200210250	200-210	250 mm	191,10
21ARIPL200210300	200-210	300 mm	212,10
21ARIPL200210400	200-210	400 mm	277,20
21ARIPL200210500	200-210	500 mm	346,50
21ARIPL200210600	200-210	600 mm	415,80
21ARIPL209220200	209-220	200 mm	149,10
21ARIPL209220250	209-220	250 mm	197,40
21ARIPL209220300	209-220	300 mm	218,40
21ARIPL209220400	209-220	400 mm	285,60
21ARIPL209220500	209-220	500 mm	354,90
21ARIPL209220600	209-220	600 mm	426,30
21ARIPL215225200	215-225	200 mm	151,20
21ARIPL215225250	215-225	250 mm	201,60
21ARIPL215225300	215-225	300 mm	222,60
21ARIPL215225400	215-225	400 mm	289,80
21ARIPL215225500	215-225	500 mm	363,28
21ARIPL215225600	215-225	600 mm	436,80
21ARIPL219229200	219-229	200 mm	155,40
21ARIPL219229250	219-229	250 mm	205,80
21ARIPL219229300	219-229	300 mm	226,80
21ARIPL219229400	219-229	400 mm	297,80
21ARIPL219229500	219-229	500 mm	371,70
21ARIPL219229600	219-229	600 mm	445,20
21ARIPL222233200	222-233	200 mm	157,50
21ARIPL222233250	222-233	250 mm	210,00
21ARIPL222233300	222-233	300 mm	231,00
21ARIPL222233400	222-233	400 mm	302,40
21ARIPL222233500	222-233	500 mm	378,00
21ARIPL222233600	222-233	600 mm	453,60
21ARIPL228239200	228-239	200 mm	161,70
21ARIPL228239250	228-239	250 mm	214,20

Código	Tolerancia	Longitud	Precio €
21ARIPL228239300	228-239	300 mm	237,30
21ARIPL228239400	228-239	400 mm	308,70
21ARIPL228239500	228-239	500 mm	386,40
21ARIPL228239600	228-239	600 mm	462,00
21ARIPL230240200	230-240	200 mm	163,80
21ARIPL230240250	230-240	250 mm	218,40
21ARIPL230240300	230-240	300 mm	241,50
21ARIPL230240400	230-240	400 mm	315,00
21ARIPL230240500	230-240	500 mm	392,70
21ARIPL230240600	230-240	600 mm	472,50
21ARIPL237247200	237-247	200 mm	168,00
21ARIPL237247250	237-247	250 mm	224,70
21ARIPL237247300	237-247	300 mm	247,80
21ARIPL237247400	237-247	400 mm	323,40
21ARIPL237247500	237-247	500 mm	403,20
21ARIPL237247600	237-247	600 mm	485,10
21ARIPL239249200	239-249	200 mm	172,20
21ARIPL239249250	239-249	250 mm	228,90
21ARIPL239249300	239-249	300 mm	252,00
21ARIPL239249400	239-249	400 mm	329,70
21ARIPL239249500	239-249	500 mm	411,60
21ARIPL239249600	239-249	600 mm	493,50
21ARIPL243254200	243-254	200 mm	174,30
21ARIPL243254250	243-254	250 mm	233,10
21ARIPL243254300	243-254	300 mm	256,20
21ARIPL243254400	243-254	400 mm	336,00
21ARIPL243254500	243-254	500 mm	420,00
21ARIPL243254600	243-254	600 mm	501,90
21ARIPL250260200	250-260	200 mm	176,40
21ARIPL250260250	250-260	250 mm	235,20
21ARIPL250260300	250-260	300 mm	260,40
21ARIPL250260400	250-260	400 mm	340,20
21ARIPL250260500	250-260	500 mm	424,20
21ARIPL250260600	250-260	600 mm	508,20
21ARIPL252263200	252-263	200 mm	178,50
21ARIPL252263250	252-263	250 mm	237,30
21ARIPL252263300	252-263	300 mm	260,40
21ARIPL252263400	252-263	400 mm	340,20
21ARIPL252263500	252-263	500 mm	426,30
21ARIPL252263600	252-263	600 mm	512,40
21ARIPL261271200	261-271	200 mm	180,60
21ARIPL261271250	261-271	250 mm	239,40
21ARIPL261271300	261-271	300 mm	264,60
21ARIPL261271400	261-271	400 mm	344,40

Abrazaderas de reparación



Abrazadera de reparación inox plus 2T

Código	Tolerancia	Longitud	Precio €
21ARIPL261271500	261-271	500 mm	430,50
21ARIPL261271600	261-271	600 mm	576,60
21ARIPL266276200	266-276	200 mm	180,60
21ARIPL266276250	266-276	250 mm	241,50
21ARIPL266276300	266-276	300 mm	266,70
21ARIPL266276400	266-276	400 mm	346,50
21ARIPL266276500	266-276	500 mm	434,70
21ARIPL266276600	266-276	600 mm	520,80
21ARIPL270280200	270-280	200 mm	193,20
21ARIPL270280250	270-280	250 mm	256,20
21ARIPL270280300	270-280	300 mm	283,50
21ARIPL270280400	270-280	400 mm	369,60
21ARIPL270280500	270-280	500 mm	462,00
21ARIPL270280600	270-280	600 mm	554,40
21ARIPL273283200	273-283	200 mm	193,20
21ARIPL273283250	273-283	250 mm	258,30
21ARIPL273283300	273-283	300 mm	283,50
21ARIPL273283400	273-283	400 mm	371,00
21ARIPL273283500	273-283	500 mm	464,10
21ARIPL273283600	273-283	600 mm	556,50
21ARIPL280291200	280-291	200 mm	195,30
21ARIPL280291250	280-291	250 mm	260,40
21ARIPL280291300	280-291	300 mm	285,60
21ARIPL280291400	280-291	400 mm	375,90
21ARIPL280291500	280-291	500 mm	468,30
21ARIPL280291600	280-291	600 mm	562,80
21ARIPL290300300	290-300	300 mm	304,50
21ARIPL290300400	290-300	400 mm	407,40
21ARIPL290300500	290-300	500 mm	508,20
21ARIPL290300600	290-300	600 mm	609,00
21ARIPL300310300	300-310	300 mm	315,00
21ARIPL300310400	300-310	400 mm	426,30
21ARIPL300310500	300-310	500 mm	525,00
21ARIPL300310600	300-310	600 mm	630,00
21ARIPL310320300	310-320	300 mm	325,50
21ARIPL310320400	310-320	400 mm	432,60
21ARIPL310320500	310-320	500 mm	541,80
21ARIPL310320600	310-320	600 mm	650,00
21ARIPL315325300	315-325	300 mm	336,00
21ARIPL315325400	315-325	400 mm	449,40
21ARIPL315325500	315-325	500 mm	560,70
21ARIPL315325600	315-325	600 mm	672,00
21ARIPL320330300	320-330	300 mm	346,50
21ARIPL320330400	320-330	400 mm	462,00

Código	Tolerancia	Longitud	Precio €
21ARIPL320330500	320-330	500 mm	577,50
21ARIPL320330600	320-330	600 mm	693,00
21ARIPL325335300	325-335	300 mm	352,80
21ARIPL325335400	325-335	400 mm	470,40
21ARIPL325335500	325-335	500 mm	585,90
21ARIPL325335600	325-335	600 mm	703,50
21ARIPL340350300	340-350	300 mm	363,30
21ARIPL340350400	340-350	400 mm	483,00
21ARIPL340350500	340-350	500 mm	604,80
21ARIPL340350600	340-350	600 mm	724,50
21ARIPL350360300	350-360	300 mm	373,80
21ARIPL350360400	350-360	40 mm	497,70
21ARIPL350360500	350-360	500 mm	621,60
21ARIPL350360600	350-360	600 mm	745,50

Abrazaderas de reparación



Abrazadera de reparación inox plus 4T

Código	Tolerancia	Longitud	Precio €
21ARIPL088110200	88-110	200 mm	157,50
21ARIPL088110250	88-110	250 mm	210,00
21ARIPL088110300	88-110	300 mm	231,00
21ARIPL088110400	88-110	400 mm	302,40
21ARIPL088110500	88-110	500 mm	378,00
21ARIPL088110600	88-110	600 mm	453,60
21ARIPL100120200	100-120	200 mm	163,80
21ARIPL100120250	100-120	250 mm	216,30
21ARIPL100120300	100-120	300 mm	239,40
21ARIPL100120400	100-120	400 mm	312,90
21ARIPL100120500	100-120	500 mm	390,60
21ARIPL100120600	100-120	600 mm	468,30
21ARIPL108128200	108-128	200 mm	165,90
21ARIPL108128250	108-128	250 mm	218,40
21ARIPL108128300	108-128	300 mm	243,60
21ARIPL108128400	108-128	400 mm	319,20
21ARIPL108128500	108-128	500 mm	399,00
21ARIPL108128600	108-128	600 mm	478,80
21ARIPL114134200	114-134	200 mm	170,10
21ARIPL114134250	114-134	250 mm	224,70
21ARIPL114134300	114-134	300 mm	249,90
21ARIPL114134400	114-134	400 mm	339,50
21ARIPL114134500	114-134	500 mm	405,30
21ARIPL114134600	114-134	600 mm	487,20
21ARIPL120140200	120-140	200 mm	172,20
21ARIPL120140250	120-140	250 mm	228,90
21ARIPL120140300	120-140	300 mm	254,10
21ARIPL120140400	120-140	400 mm	331,80
21ARIPL120140500	120-140	500 mm	413,70
21ARIPL120140600	120-140	600 mm	495,60
21ARIPL130150200	130-150	200 mm	176,40
21ARIPL130150250	130-150	250 mm	233,10
21ARIPL130150300	130-150	300 mm	258,30
21ARIPL130150400	130-150	400 mm	338,10
21ARIPL130150500	130-150	500 mm	420,00
21ARIPL130150600	130-150	600 mm	506,10
21ARIPL135155200	135-155	200 mm	178,50
21ARIPL135155250	135-155	250 mm	237,30
21ARIPL135155300	135-155	300 mm	260,40

Código	Tolerancia	Longitud	Precio €
21ARIPL135155400	135-155	400 mm	340,20
21ARIPL135155500	135-155	500 mm	426,30
21ARIPL135155600	135-155	600 mm	512,40
21ARIPL140160200	140-160	200 mm	180,60
21ARIPL140160250	140-160	250 mm	241,50
21ARIPL140160300	140-160	300 mm	266,70
21ARIPL140160400	140-160	400 mm	345,50
21ARIPL140160500	140-160	500 mm	434,70
21ARIPL140160600	140-160	600 mm	520,80
21ARIPL159180200	159-180	200 mm	184,80
21ARIPL159180250	159-180	250 mm	245,70
21ARIPL159180300	159-180	300 mm	270,90
21ARIPL159180400	159-180	400 mm	352,80
21ARIPL159180500	159-180	500 mm	441,00
21ARIPL159180600	159-180	600 mm	529,20
21ARIPL165185200	165-185	200 mm	186,90
21ARIPL165185250	165-185	250 mm	249,30
21ARIPL165185300	165-185	300 mm	275,10
21ARIPL165185400	165-185	400 mm	359,10
21ARIPL165185500	165-185	500 mm	449,40
21ARIPL165185600	165-185	600 mm	539,70
21ARIPL168189200	168-189	200 mm	189,00
21ARIPL168189250	168-189	250 mm	252,00
21ARIPL168189300	168-189	300 mm	279,30
21ARIPL168189400	168-189	400 mm	363,33
21ARIPL168189500	168-189	500 mm	453,60
21ARIPL168189600	168-189	600 mm	543,90
21ARIPL170190200	170-190	200 mm	191,10
21ARIPL170190250	170-190	250 mm	254,10
21ARIPL170190300	170-190	300 mm	281,40
21ARIPL170190400	170-190	400 mm	367,50
21ARIPL170190500	170-190	500 mm	459,90
21ARIPL170190600	170-190	600 mm	550,20
21ARIPL176196200	176-196	200 mm	195,30
21ARIPL176196250	176-196	250 mm	258,30
21ARIPL176196300	176-196	300 mm	285,60
21ARIPL176196400	176-196	400 mm	373,80
21ARIPL176196500	176-196	500 mm	466,20
21ARIPL176196600	176-196	600 mm	560,70

Abrazaderas de reparación



Abrazadera de reparación inox plus 4T

Código	Tolerancia	Longitud	Precio €
21ARIPL190210200	190-210	200 mm	199,50
21ARIPL190210250	190-210	250 mm	266,70
21ARIPL190210300	190-210	300 mm	294,00
21ARIPL190210400	190-210	400 mm	384,30
21ARIPL190210500	190-210	500 mm	478,80
21ARIPL190210600	190-210	600 mm	575,40
21ARIPL195217200	195-217	200 mm	205,80
21ARIPL195217250	195-217	250 mm	273,00
21ARIPL195217300	195-217	300 mm	302,40
21ARIPL195217400	195-217	400 mm	393,80
21ARIPL195217500	195-217	500 mm	491,40
21ARIPL195217600	195-217	600 mm	594,10
21ARIPL210230200	210-230	200 mm	210,00
21ARIPL210230250	210-230	250 mm	279,30
21ARIPL210230300	210-230	300 mm	308,70
21ARIPL210230400	210-230	400 mm	401,10
21ARIPL210230500	210-230	500 mm	501,90
21ARIPL210230600	210-230	600 mm	602,70
21ARIPL216238200	216-238	200 mm	216,30
21ARIPL216238250	216-238	250 mm	287,70
21ARIPL216238300	216-238	300 mm	317,10
21ARIPL216238400	216-238	400 mm	413,70
21ARIPL216238500	216-238	500 mm	516,60
21ARIPL216238600	216-238	600 mm	619,50
21ARIPL225246200	225-246	200 mm	220,50
21ARIPL225246250	225-246	250 mm	294,00
21ARIPL225246300	225-246	300 mm	325,50
21ARIPL225246400	225-246	400 mm	424,20
21ARIPL225246500	225-246	500 mm	529,20
21ARIPL225246600	225-246	600 mm	636,30
21ARIPL240260200	240-260	200 mm	231,00
21ARIPL240260250	240-260	250 mm	308,70
21ARIPL240260300	240-260	300 mm	340,20
21ARIPL240260400	240-260	400 mm	443,10
21ARIPL240260500	240-260	500 mm	554,40
21ARIPL240260600	240-260	600 mm	665,70
21ARIPL250270200	250-270	200 mm	252,00
21ARIPL250270250	250-270	250 mm	340,20
21ARIPL250270300	250-270	300 mm	378,00
21ARIPL250270400	250-270	400 mm	493,50
21ARIPL250270500	250-270	500 mm	619,50
21ARIPL250270600	250-270	600 mm	741,30
21ARIPL269289200	269-289	200 mm	268,80
21ARIPL269289250	269-289	250 mm	357,00

Código	Tolerancia	Longitud	Precio €
21ARIPL269289300	269-289	300 mm	396,90
21ARIPL269289400	269-289	400 mm	514,50
21ARIPL269289500	269-289	500 mm	644,70
21ARIPL269289600	269-289	600 mm	774,90
21ARIPL273293200	273-293	200 mm	273,00
21ARIPL273293250	273-293	250 mm	363,30
21ARIPL273293300	273-293	300 mm	403,20
21ARIPL273293400	273-293	400 mm	522,90
21ARIPL273293500	273-293	500 mm	659,40
21ARIPL273293600	273-293	600 mm	816,90
21ARIPL282302200	282-302	200 mm	279,30
21ARIPL282302250	282-302	250 mm	369,60
21ARIPL282302300	282-302	300 mm	409,50
21ARIPL282302400	282-302	400 mm	533,40
21ARIPL282302500	282-302	500 mm	672,00
21ARIPL282302600	282-302	600 mm	831,60
21ARIPL295315200	295-315	200 mm	283,50
21ARIPL295315250	295-315	250 mm	375,90
21ARIPL295315300	295-315	300 mm	420,00
21ARIPL295315400	295-315	400 mm	546,00
21ARIPL295315500	295-315	500 mm	686,70
21ARIPL295315600	295-315	600 mm	850,50
21ARIPL315335200	315-335	200 mm	294,00
21ARIPL315335250	315-335	250 mm	386,40
21ARIPL315335300	315-335	300 mm	422,10
21ARIPL315335400	315-335	400 mm	550,20
21ARIPL315335500	315-335	500 mm	693,00
21ARIPL315335600	315-335	600 mm	856,80
21ARIPL322344200	322-344	200 mm	300,30
21ARIPL322344250	322-344	250 mm	390,60
21ARIPL322344300	322-344	300 mm	436,80
21ARIPL322344400	322-344	400 mm	560,70
21ARIPL322344500	322-344	500 mm	705,60
21ARIPL322344600	322-344	600 mm	873,60
21ARIPL337358200	337-358	200 mm	304,50
21ARIPL337358250	337-358	250 mm	399,00
21ARIPL337358300	337-358	300 mm	443,10
21ARIPL337358400	337-358	400 mm	575,40
21ARIPL337358500	337-358	500 mm	724,50
21ARIPL337358600	337-358	600 mm	898,80
21ARIPL347367200	347-367	200 mm	315,00
21ARIPL347367250	347-367	250 mm	409,50
21ARIPL347367300	347-367	300 mm	451,50
21ARIPL347367400	347-367	400 mm	588,00

Abrazaderas de reparación



Abrazadera de reparación inox plus 4T

Código	Tolerancia	Longitud	Precio €
21ARIPL347367500	347-367	500 mm	741,30
21ARIPL347367600	347-367	600 mm	917,70
21ARIPL365385300	365-385	300 mm	472,50
21ARIPL365385400	365-385	400 mm	615,30
21ARIPL365385500	365-385	500 mm	774,90
21ARIPL365385600	365-385	600 mm	959,70
21ARIPL382402300	382-402	300 mm	483,00
21ARIPL382402400	382-402	400 mm	627,90
21ARIPL382402500	382-402	400 mm	791,70
21ARIPL382402600	382-402	600 mm	980,70
21ARIPL390410250	390-410	250 mm	493,50
21ARIPL390410300	390-410	300 mm	493,50
21ARIPL390410400	390-410	400 mm	642,60
21ARIPL390410500	390-410	500 mm	810,60
21ARIPL390410600	390-410	600 mm	1.001,70
21ARIPL410430300	410-430	300 mm	520,80

Código	Tolerancia	Longitud	Precio €
21ARIPL410430400	410-430	400 mm	653,10
21ARIPL410430500	410-430	500 mm	854,70
21ARIPL410430600	410-430	600 mm	1.012,20
21ARIPL420440400	420-440	400 mm	660,30
21ARIPL420440500	420-440	500 mm	867,30
21ARIPL420440600	420-440	600 mm	946,90
21ARIPL435455400	435-455	400 mm	672,00
21ARIPL435455500	435-455	500 mm	879,90
21ARIPL435455600	435-455	600 mm	1.041,60
21ARIPL450470400	450-470	400 mm	684,60
21ARIPL450470500	450-470	500 mm	896,70
21ARIPL450470600	450-470	600 mm	862,60
21ARIPL468488400	468-488	400 mm	699,30
21ARIPL468488500	468-488	500 mm	915,60
21ARIPL468488600	468-488	600 mm	1.081,50



Abrazadera de reparación inox plus 6T

Código	Tolerancia	Longitud	Precio €
21ARIPL270300300	270-300	300 mm	485,10
21ARIPL270300400	270-300	400 mm	630,00
21ARIPL270300500	270-300	500 mm	913,50
21ARIPL270300600	270-300	600 mm	970,20
21ARIPL310340300	310-340	300 mm	520,80
21ARIPL310340400	310-340	400 mm	680,40
21ARIPL310340500	310-340	500 mm	942,90
21ARIPL310340600	310-340	600 mm	1.043,70
21ARIPL340370300	340-370	300 mm	543,90
21ARIPL340370400	340-370	400 mm	709,80
21ARIPL340370500	340-370	500 mm	984,90
21ARIPL340370600	340-370	600 mm	1.087,80
21ARIPL350380300	350-380	300 mm	558,60
21ARIPL350380400	350-380	400 mm	724,50
21ARIPL350380500	350-380	500 mm	999,60
21ARIPL350380600	350-380	600 mm	1.115,10
21ARIPL395425300	395-425	300 mm	609,00
21ARIPL395425400	395-425	400 mm	798,00
21ARIPL395425500	395-425	500 mm	1.100,40

Código	Tolerancia	Longitud	Precio €
21ARIPL395425600	395-425	600 mm	1218,00
21ARIPL400430300	400-430	300 mm	609,00
21ARIPL400430400	400-430	400 mm	798,00
21ARIPL400430500	400-430	500 mm	1.100,40
21ARIPL400430600	400-430	600 mm	1.218,00
21ARIPL440470400	440-470	400 mm	825,30
21ARIPL440470500	440-470	500 mm	1.144,50
21ARIPL440470600	440-470	600 mm	1.274,70
21ARIPL475505400	475-505	400 mm	840,00
21ARIPL475505500	475-505	500 mm	1.173,90
21ARIPL475505600	475-505	600 mm	1.289,40
21ARIPL530560500	530-560	500 mm	1.260,00
21ARIPL530560600	530-560	600 mm	1.404,90
21ARIPL570600500	570-600	500 mm	1.304,10
21ARIPL570600600	570-600	600 mm	1.434,30
21ARIPL608638500	608-638	500 mm	1.318,80
21ARIPL608638600	608-638	600 mm	1.463,70
21ARIPL685715500	685-715	500 mm	1.507,80
21ARIPL685715600	685-715	600 mm	1.667,40

Abrazaderas de reparación



Abrazadera de reparación inox ECO 1T

Código	Longitud	Tolerancia	Precio €
21ARIE1T021025	76 mm	(21-25)	12,98
21ARIE1T026030	76 mm	(26-30)	13,23
21ARIE1T026030	76 mm	(29-31)	14,15
21ARIE1T032037	76 mm	(32-37)	14,15
21ARIE1T038042	76 mm	(38-42)	14,89
21ARIE1T042045	76 mm	(42-45)	14,89
21ARIE1T044048	76 mm	(44-48)	15,31
21ARIE1T048051	76 mm	(48-51)	15,53
21ARIE1T050054	76 mm	(50-54)	15,87
21ARIE1T055060	76 mm	(55-60)	16,90
21ARIE1T060064	76 mm	(60-64)	19,37
21ARIE1T065069	76 mm	(65-69)	19,37
21ARIE1T069073	76 mm	(69-73)	19,37
21ARIE1T071075	76 mm	(71-75)	19,37
21ARIE1T076082	76 mm	(76-82)	20,02
21ARIE1T082087	76 mm	(82-87)	20,02
21ARIE1T087093	76 mm	(87-93)	21,39
21ARIE1T094100	76 mm	(94-100)	22,13
21ARIE1T099104	76 mm	(99-104)	22,13
21ARIE1T112118	76 mm	(112-118)	23,15
21ARIE1T118124	76 mm	(118-124)	35,39
21ARIE1T120126	76 mm	(120-126)	39,83
21ARIE1T126131	76 mm	(126-131)	40,22
21ARIE1T131136	76 mm	(131-136)	40,22
21ARIE1T139145	76 mm	(139-145)	41,40
21ARIE1T143149	76 mm	(139-145)	41,40
21ARIE1T149155	76 mm	(149-155)	41,68
21ARIE1T156162	76 mm	(156-162)	43,98
21ARIE1T167173	76 mm	(167-173)	44,59
21ARIE1T173179	76 mm	(173-179)	46,26
21ARIE1T198204	76 mm	(198-204)	47,82
21ARIE1T205211	76 mm	(205-211)	48,63
21ARIE1T217223	76 mm	(217-223)	49,92
21ARIE1T223229	76 mm	(223-229)	51,02



Abrazadera de reparación inox ECO 2T

Código	Longitud	Tolerancia	Precio €
21ARIE2T021025	152 mm	(21-25)	19,00
21ARIE2T026030	152 mm	(26-30)	19,00
21ARIE2T029031	152 mm	(29-31)	19,50
21ARIE2T032037	152 mm	(32-37)	19,50
21ARIE2T038042	152 mm	(38-42)	19,97
21ARIE2T042045	152 mm	(42-45)	19,97
21ARIE2T044048	152 mm	(44-48)	20,62
21ARIE2T048051	152 mm	(48-51)	20,94
21ARIE2T050054	152 mm	(50-54)	21,42
21ARIE2T055060	152 mm	(55-60)	22,88
21ARIE2T060064	152 mm	(60-64)	28,25
21ARIE2T076082	152 mm	(76-82)	30,18
21ARIE2T082087	152 mm	(82-87)	30,18
21ARIE2T087093	152 mm	(87-93)	31,48
21ARIE2T094100	152 mm	(94-100)	32,16
21ARIE2T112118	152 mm	(112-118)	34,58
21ARIE2T118124	152 mm	(118-124)	53,10
21ARIE2T139145	152 mm	(139-145)	60,89
21ARIE2T143149	152 mm	(143-149)	60,89
21ARIE2T167173	152 mm	(167-173)	64,28
21ARIE2T217223	152 mm	(217-223)	73,04



Abrazadera de reparación iron

Código	Medida	Precio €
21ARFI012	1/2"	9,16
21ARFI034	3/4"	9,68
21ARFI100	1"	12,68
21ARFI114	1 1/4"	21,40
21ARFI112	1 1/2"	30,80
21ARFI200	2"	44,18
21ARFI212	2 1/2"	56,08
21ARFI300	3"	64,80
21ARFI400	4"	70,52

Abrazaderas de reparación

Kit de reparación de emergencia

	Código	Descripción	L	Alcance	Precio €
	21AREMK213780	Kit de reparación con 5 secciones de abrazadera	400 mm	213-780 mm	Consultar

**Incluye caja de madera para almacenaje*

Secciones de abrazadera de reparación

	Código	Sección	L	Precio €
	21AREM317	317 mm	400 mm	Consultar
	21AREM383	383 mm	400 mm	Consultar
	21AREM446	446 mm	400 mm	Consultar
	21AREM543	543 mm	400 mm	Consultar
	21AREM637	637 mm	400 mm	Consultar

Cabezales y collarines

Cabezal de toma sin carga para fundición, fibrocemento y acero



Código	DN	Medida	Precio €
21BH350050034	50-200	3/4"	29,25
21BH350050100	50-200	1"	29,25
21BH350050114	50-200	1 1/4"	29,25
21BH350050112	50-200	1 1/2"	29,25
21BH350080100	100-300	1"	36,00
21BH350080114	100-300	1 1/4"	36,00
21BH350080112	100-300	1 1/2"	36,00
21BH350080200	100-300	2"	36,00

Banda de acero inoxidable para cabezal



Código	DN	Medida	Precio €
21BH310060077	50-200	60-77	24,77
21BH310077095	50-200	77-95	24,77
21BH310098119	50-200	98-119	27,03
21BH310102122	50-200	102-122	27,03
21BH310120150	50-200	120-150	27,03
21BH310125135	50-200 / 100-300	125-135	27,03
21BH310139160	50-200 / 100-300	139-160	29,28
21BH310150180	50-200 / 100-300	150-180	31,53
21BH310200230	50-200 / 100-300	200-230	38,29
21BH310230250	100-300 / 150-400	230-250	38,29
21BH310250280	100-300 / 150-400	250-280	38,29
21BH310285315	100-300 / 150-400	285-315	42,75
21BH310315340	100-300 / 150-400	315-340	45,00
21BH310410435	100-300 / 150-400	410-435	51,75
21BH310506535	100-300 / 150-400	506-535	69,75

Taladradora manual



Código	Medida	Precio €
XTC002	3/4" a 2"	1067,64

Cabezales y collarines

Collarín de toma sin carga para PE y PVC

Código	DN	Medida	Precio €
21BH525050034	50 mm	3/4"	35,77
21BH525050100	50 mm	1"	35,77
21BH525050114	50 mm	1 1/4"	35,77
21BH525063034	63 mm	3/4"	42,93
21BH525063100	63 mm	1"	42,93
21BH525063114	63 mm	1 1/4"	42,93
21BH525063112	63 mm	1 1/2"	42,93
21BH525063200	63 mm	2"	42,93
21BH525075034	75 mm	3/4"	47,20
21BH525075100	75 mm	1"	47,20
21BH525075114	75 mm	1 1/4"	47,20
21BH525075112	75 mm	1 1/2"	47,20
21BH525075200	75 mm	2"	47,20
21BH525090034	90 mm	3/4"	50,08
21BH525090100	90 mm	1"	50,08
21BH525090114	90 mm	1 1/4"	50,08
21BH525090112	90 mm	1 1/2"	50,08
21BH525090200	90 mm	2"	50,08
21BH525110034	110 mm	3/4"	66,78
21BH525110100	110 mm	1"	66,78
21BH525110114	110 mm	1 1/4"	66,78
21BH525110112	110 mm	1 1/2"	66,78
21BH525110200	110 mm	2"	66,78
21BH525110212	110 mm	2 1/2"	66,78
21BH525125034	125 mm	3/4"	71,68
21BH525125100	125 mm	1"	71,68
21BH525125114	125 mm	1 1/4"	71,68
21BH525125112	125 mm	1 1/2"	71,68
21BH525125200	125 mm	2"	71,68
21BH525125212	125 mm	2 1/2"	71,68
21BH525140100	140 mm	1"	83,20
21BH525140112	140 mm	1 1/2"	83,20
21BH525140200	140 mm	2"	83,20
21BH525160114	160 mm	1 1/4"	102,55
21BH525160112	160 mm	1 1/2"	102,55
21BH525160200	160 mm	2"	102,55
21BH525200100	200 mm	1"	126,40
21BH525200114	200 mm	1 1/4"	126,40
21BH525200112	200 mm	1 1/2"	126,40
21BH525200200	200 mm	2"	126,40
21BH525250200	250 mm	2"	226,57
21BH525315200	315 mm	2"	298,12

Cabezales y collarines



Collarín plástico de toma sin carga para PE y PVC

Código	DN	Medida	Precio €
21BH526025012	25 mm	1/2"	1,16
21BH526025034	25 mm	3/4"	1,16
21BH526032012	32 mm	1/2"	1,00
21BH526032034	32 mm	3/4"	1,48
21BH526040012	40 mm	1/2"	1,15
21BH526040034	40 mm	3/4"	1,70
21BH526040100	40 mm	1"	1,70
21BH526050012	50 mm	1/2"	1,99
21BH526050034	50 mm	3/4"	1,99
21BH526050100	50 mm	1"	2,10
21BH526063012	63 mm	1/2"	3,00
21BH526063034	63 mm	3/4"	2,37
21BH526063100	63 mm	1"	2,60
21BH526063114	63 mm	1 1/4"	3,60
21BH526063112	63 mm	1 1/2"	3,64
21BH526075012	75 mm	1/2"	3,48
21BH526075034	75 mm	3/4"	3,48
21BH526075100	75 mm	1"	3,48
21BH526075114	75 mm	1 1/4"	4,18
21BH526075112	75 mm	1 1/2"	4,31
21BH526075200	75 mm	2"	4,71
21BH526090012	90 mm	1/2"	4,06
21BH526090034	90 mm	3/4"	4,15
21BH526090100	90 mm	1"	4,15
21BH526090114	90 mm	1 1/4"	4,79
21BH526090112	90 mm	1 1/2"	4,83
21BH526090200	90 mm	2"	5,21
21BH526110012	110 mm	1/2"	4,64
21BH526110034	110 mm	3/4"	4,68
21BH526110100	110 mm	1"	4,68
21BH526110114	110 mm	1 1/4"	5,58
21BH526110112	110 mm	1 1/2"	5,70
21BH526110200	110 mm	2"	6,06

Código	DN	Medida	Precio €
21BH526125012	125 mm	1/2"	7,32
21BH526125034	125 mm	3/4"	7,52
21BH526125100	125 mm	1"	7,76
21BH526125114	125 mm	1 1/4"	8,07
21BH526125112	125 mm	1 1/2"	8,25
21BH526125200	125 mm	2"	8,74
21BH526140012	140 mm	1/2"	10,75
21BH526140034	140 mm	3/4"	10,97
21BH526140100	140 mm	1"	11,07
21BH526140114	140 mm	1 1/4"	11,43
21BH526140112	140 mm	1 1/2"	11,52
21BH526140200	140 mm	2"	11,52
21BH526160012	160 mm	1/2"	12,04
21BH526160034	160 mm	3/4"	12,20
21BH526160100	160 mm	1"	12,38
21BH526160114	160 mm	1 1/4"	12,73
21BH526160112	160 mm	1 1/2"	12,90
21BH526160200	160 mm	2"	13,15
21BH526200034	200 mm	3/4"	25,08
21BH526200100	200 mm	1"	25,24
21BH526200114	200 mm	1 1/4"	25,40
21BH526200112	200 mm	1 1/2"	25,65
21BH526200200	200 mm	2"	26,02

Cabezales y collarines

Cabezal de toma con brida



Código	DN	Medida (DN)	Precio €
21BH351080050	80	50	174,10
21BH351100050	100	50	219,42
21BH351100065	100	65	233,73
21BH351100080	100	80	238,50
21BH351150050	150	50	267,12
21BH351150080	150	80	276,66
21BH351150100	150	100	305,28
21BH351200080	200	80	317,20
21BH351200100	200	100	324,36
21BH351200150	200	150	360,13
21BH351250100	250	100	362,52
21BH351250150	250	150	403,06
21BH351300100	300	100	510,39
21BH351300150	300	150	548,55
21BH351400100	400	100	739,35
21BH351400150	400	150	834,75
21BH351500100	500	100	875,21
21BH351500150	500	150	918,22
21BH351600100	600	100	844,29
21BH351600150	600	150	946,84

Bridas

Brida antitracción para PE-PVC

Código	DN	Medida	Precio €
21BAT050063	50	63 mm	71,55
21BAT060075	60	75 mm	85,86
21BAT065063	65	63 mm	85,86
21BAT065075	65	75 mm	85,86
21BAT080090	80	90 mm	107,32
21BAT100110	100	110 mm	126,40
21BAT100125	100	125 mm	159,79
21BAT125125	125	125 mm	169,33
21BAT125140	125	140 mm	221,80
21BAT150160	150	160 mm	231,34
21BAT150180	150	180 mm	310,05
21BAT200200	200	200 mm	331,51
21BAT200225	200	225 mm	352,98
21BAT250250	250	250 mm	477,00
21BAT250280	250	280 mm	574,78
21BAT300315	300	315 mm	639,18
21BAT400400	400	400 mm	1.772,05

Manguito antitracción para PE-PVC

Código	DN	Medida	Precio €
21MAT065075	65	75 mm	124,02
21MAT080090	80	90 mm	143,10
21MAT100110	100	110 mm	178,87
21MAT125125	125	125 mm	255,19
21MAT140140	140	140 mm	Consultar
21MAT150160	150	160 mm	298,12
21MAT200200	200	200 mm	417,37
21MAT225225	225	225 mm	429,30
21MAT250250	250	250 mm	782,28
21MAT280280	280	280 mm	Consultar
21MAT315315	315	315 mm	973,08

Brida con bloqueo para PE-PVC

Código	DN	Medida	Precio €
21BB050	50	63 mm	42,93
21BB065	65	75 mm	47,70
21BB080	80	90 mm	59,62
21BB100	100	110 mm	76,32
21BB125	125	125 mm	95,40
21BB150	150	160 mm	135,94
21BB200	200	200 mm	183,64
21BB250	250	250 mm	329,13
21BB300	300	315 mm	398,29

Bridas



Brida reductora con clavetas

Código	DN	Precio €
21BRC065050	65-50	83,45
21BRC080050	80-50	100,17
21BRC080065	80-65	102,55
21BRC100050	100-50	107,32
21BRC100065	100-65	107,32
21BRC100080	100-80	147,87
21BRC125080	125-80	169,33
21BRC125100	125-100	188,41
21BRC150050	150-50	155,02
21BRC150065	150-65	152,64
21BRC150080	150-80	143,10
21BRC150100	150-100	174,10
21BRC150125	150-125	231,34
21BRC200050	200-50	193,18
21BRC200065	200-65	195,57
21BRC200080	200-80	207,49
21BRC200100	200-100	202,72
21BRC200150	200-150	240,88

Código	DN	Precio €
21BRC250100	250-100	331,51
21BRC250150	250-150	245,65
21BRC250200	250-200	288,58
21BRC300080	300-80	386,37
21BRC300100	300-100	376,83
21BRC300150	300-150	375,83
21BRC300200	300-200	288,58
21BRC300250	300-250	367,29
21BRC400100	400-100	913,45
21BRC400150	400-150	906,30
21BRC400200	400-200	875,29
21BRC400250	400-250	853,83
21BRC400300	400-300	796,59
21BRC500100	500-100	1.798,29
21BRC500200	500-200	1.550,25
21BRC500300	500-300	1.657,57
21BRC500400	500-400	1.812,60



Brida doble cámara PE-PVC

Código	DN	Precio €
21BDC050063	50-63	33,47
21BDC065063	60/65-63	35,70
21BDC065075	60/65-75	37,94
21BDC080090	80-90	53,56
21BDC100110	100-110	64,71
21BDC125125	125-125	75,87
21BDC125140	125-140	95,95

Código	DN	Precio €
21BDC150160	150-160	102,64
21BDC200200	200-200	142,81
21BDC200225	200-225	149,50
21BDC250250	250-250	207,52
21BDC300315	300-315	252,14
21BDC400400	400-400	439,57

Accesorios de fundición

Acoplamiento multidímetro (tubería plástica)

Código	DN	Tolerancia	Precio €
21RF050	50	(57-74)	50,08
21RF065	65	(63-85)	62,01
21RF080	80	(85-107)	73,93
21RF100	100	(107-132)	95,40
21RF100/80	100/80	-	93,01
21RF125	125	(132-158)	124,02
21RF150	150	(158-184)	138,33
21RF150/100	150/100	-	133,56
21RF175	175	(189-212)	171,72
21RF200	200	(218-244)	188,41
21RF200/150	200/150	-	186,03
21RF225	225	(243-269)	224,19
21RF250	250	(266-295)	240,88
21RF300	300	(315-349)	295,74
21RF400	400	(417-437)	572,40
21RF500	500	(526-546)	980,23
21RF600	600	(630-650)	1.080,40

Enlace brida multidímetro (tubería plástica)

Código	DN	Tolerancia	Precio €
21RA050	50	(57-74)	52,47
21RA065	65	(63-85)	62,01
21RA080	80	(85-107)	69,16
21RA100	100	(107-132)	83,47
21RA125	125	(132-158)	119,25
21RA125138	125	(138-153)	119,25
21RA150	150	(158-184)	121,63
21RA200	200	(218-244)	157,41
21RA200225	200	(200-225)	202,72
21RA250	250	(266-295)	209,88
21RA300	300	(315-349)	269,50
21RA350	350	(351-378)	493,69
21RA400	400	(400-420)	574,78
21RA400417	400	(417-437)	565,24
21RA500532	500	(500-532)	920,61
21RA500	500	(526-546)	839,52
21RA600	600	(630-650)	1.085,17

Accesorios de fundición

Enlace brida multidímetro anti-tracción (plástico, acero, fundición dúctil)

Código	DN	Tolerancia	Precio €
21MGB050	50	(46-70)	210,37
21MGB065	65	(70-95)	262,35
21MGB080	80	(88-123)	316,80
21MGB100	100	(108-143)	400,95
21MGB125	125	(133-168)	447,97
21MGB150	150	(159-194)	465,30
21MGB200	200	(200-235)	779,62
21MGB250	250	(250-285)	1.051,87
21MGB300	300	(315-350)	1.529,55

Acoplamiento multidímetro anti-tracción (plástico, acero, fundición dúctil)

Código	DN	Tolerancia	Precio €
21MGM050	50	(46-70)	329,17
21MGM065	65	(70-95)	363,82
21MGM080	80	(88-123)	420,85
21MGM100	100	(108-143)	495,00
21MGM125	125	(133-168)	591,52
21MGM150	150	(159-194)	613,80
21MGM200	200	(200-235)	1.098,90
21MGM250	250	(250-285)	1.480,05
21MGM300	300	(315-350)	1.871,10

Accesorios de fundición

Cruz de fundición con bridas fijas

Código	DN	Precio €
21F130050050	50-50	171,72
21F130065065	65-65	217,03
21F130080080	80-80	243,27
21F130100050	100-50	243,27
21F130100080	100-80	279,04
21F130100100	100-100	286,20
21F130150080	150-80	441,22
21F130150100	150-100	443,61
21F130150150	150-150	505,62
21F130200100	200-100	581,94
21F130200150	200-150	672,57
21F130200200	200-200	725,04
21F130200PN16	200PN16	725,04
21F130250100	250-100	789,43
21F130250250	250-250	1.206,81
21F130300100	300-100	961,15
21F130300150	300-150	1.144,80
21F130300200	300-200	Consultar
21F130300300	300-300	1.564,56
21F130400100	400-100	1.593,18
21F130400150	400-150	1.757,74
21F130400400	400-400	2.723,67
21F130500500	500-500	3.992,49
21F130600600	600-600	Consultar

Accesorios de fundición



Codo 45° de fundición con bridas fijas

Código	DN	Precio €
21F123080	80	100,17
21F123100	100	124,02
21F123150	150	226,57



Codo 90° de fundición con pata

Código	DN	Precio €
21F120080Z	80	147,87
21F120100Z	100	195,57
21F120150Z	150	405,45



Codo 90° de fundición con bridas fijas

Código	DN	Precio €
21F120050	50	81,09
21F120065	65	100,17
21F120080	80	104,94
21F120100	100	128,79
21F120150	150	228,96
21F120200010	200 PN10	376,83
21F120200016	200 PN16	376,83
21F120250010	250 PN10	620,10
21F120250016	250 PN16	620,10
21F120300010	300 PN10	954,00
21F120300016	300 PN16	954,00
21F120400010	400 PN10	1.450,08
21F120400016	400 PN16	1.450,08
21F120500	500	2.499,48
21F120600	600	3.966,25

Accesorios de fundición



T fundición con bridas fijas

Código	DN	Precio €
21F125050	50-50	121,63
21F125065050	65-50	138,33
21F125065	65-65	140,71
21F125080050	80-50	152,64
21F125080065	80-65	164,56
21F125080	80-80	169,33
21F125100050	100-50	181,26
21F125100065	100-65	188,41
21F125100080	100-80	200,34
21F125100	100-100	212,26
21F125150050	150-50	307,66
21F125150065	150-65	326,74
21F125150080	150-80	310,05
21F125150100	150-100	324,36
12F125150	150-150	364,90
21F125200065	200-65	412,60
21F125200080	200-80	414,99
21F125200100	200-100	434,07
21F125200100016	200PN16-100	434,07
21F125200150	200-150	486,54
21F125200150016	200PN16-150	486,54
21F125200	200-200	539,01
21F125200016	200PN16-200PN16	539,01
21F125250065	250-65	620,10
21F125250080	250-80	632,02
21F125250100	250-100	660,64
21F125250100016	250PN16-100	660,64
21F125250150	250-150	767,97
21F125250150016	250PN16-150	767,97
21F125250200	250-200	813,28
21F125250200016	250PN16-200PN16	813,28
21F125250250	250-250	908,68
21F125250250016	250PN16-250PN16	908,68
21F125300080	300-80	880,06
21F125300080016	300PN16-80	880,06
21F125300100	300-100	803,74
21F125300100016	300PN16-100	803,74
21F125300150	300-150	925,38
21F125300150016	300PN16-150	925,38

Código	DN	Precio €
21F125300200	300-200	1.018,39
21F125300200016	300PN16-200PN16	1.018,39
21F125300250	300-250	1.175,80
21F125300	300-300	1.275,97
21F125300016	300PN16	1.275,97
21F125400100	400-100	1.371,37
21F125400150	400-150	1.576,48
21F125400200	400-200	1.836,45
21F125400250	400-250	1.853,14
21F125400300	400-300	1.948,54
21F125400	400-400	2.034,40
21F125500100	500-100	1.179,00
21F125550150	500-150	1.351,50
21F125500200	500-200	1.408,57
21F125500300	500-300	1.684,87
21F125500400	500-400	1.968,69
21F125500	500-500	2.129,37
21F125600100	600-100	1.714,91
21F125600150	600-150	1.821,52
21F125600200	600-200	1.977,70
21F125600250	600-250	Consultar
21F125600300	600-300	2.332,09
21F125600400	600-400	2.677,48
21F125600500	600-500	Consultar
21F125600	600-600	3.021,36

Accesorios de fundición

Brida fundición ciega

Código	PN	DN	Precio €
21BC050	10/16	50	26,23
21BC065	10/16	65	33,39
21BC080	10/16	80	42,93
21BC100	10/16	100	50,08
21BC150	10/16	150	81,09
21BC200010	10	200	124,02
21BC200016	16	200	124,02
21BC250010	10	250	186,03
21BC250016	16	250	186,03
21BC300010	10	300	279,04
21BC300016	16	300	279,04
21BC400010	10	400	519,93
21BC400016	16	400	519,93
21BC500010	10	500	708,34
21BC500016	16	500	708,34
21BC600010	10	600	1.178,19

Brida fundición roscada

Código	DN	Rosca	Precio €
21BR050100	50	1"	38,16
21BR050114	50	1 1/4"	38,16
21BR050112	50	1 1/2"	38,16
21BR050200	50	2"	38,16
21BR065100	65	1"	47,70
21BR065114	65	1 1/4"	47,70
21BR065200	65	2"	47,70
21BR080100	80	1"	54,85
21BR080114	80	1 1/4"	54,85
21BR080200	80	2"	54,85
21BR100100	100	1"	62,01
21BR100114	100	1 1/4"	62,01
21BR100112	100	1 1/2"	62,01
21BR100200	100	2"	62,01
21BR150200	150	2"	102,55
21BR200200	200	2"	166,95
21BR200200016	200 PN16	2"	166,95
21BR250200	250	2"	217,03
21BR250200016	250 PN16	2"	217,03
21BR300200	300	2"	310,05
21BR300200016	300 PN16	2"	310,05

Accesorios de fundición



Carrete con bridas

Código	DN	L (mm)	Precio €
21CB0500100	50	100	66,78
21CB0500200	50	200	73,93
21CB0500300	50	300	83,47
21CB0500400	50	400	95,40
21CB0500500	50	500	102,55
21CB0500600	50	600	112,09
21CB0500800	50	800	133,56
21CB0501000	50	1000	169,33
21CB0650200	65	200	97,78
21CB0650300	65	300	109,71
21CB0650500	65	500	138,33
21CB0800100	80	100	85,86
21CB0800200	80	200	102,55
21CB0800300	80	300	124,02
21CB0800400	80	400	131,17
21CB0800500	80	500	152,64
21CB0800600	80	600	183,64
21CB0800800	80	800	212,26
21CB0801000	80	1000	262,35
21CB1000100	100	100	97,78
21CB1000200	100	200	126,40
21CB1000300	100	300	138,33
21CB1000400	100	400	164,56
21CB1000500	100	500	178,87
21CB1001000	100	1000	307,66
21CB1500100	150	100	156,64
21CB1500200	150	200	186,03
21CB1500300	150	300	217,03
21CB1500400	150	400	243,27
21CB1500500	150	500	295,74
21CB1501000	150	1000	493,69
21CB2000100	200	100	243,27
21CB2000200	200	200	269,50
21CB2000300	200	300	317,20
21CB2000400	200	400	386,37
21CB2000500	200	500	434,07
21CB2001000	200	1000	717,88
21CB2500200	250	200	469,84
21CB2500300	250	300	565,24
21CB2500500	250	500	725,04
21CB2501000	250	1000	944,46
21CB3000100	300	100	465,07

Código	DN	L (mm)	Precio €
21CB3000200	300	200	522,31
21CB3000300	300	300	620,10
21CB3000500	300	500	763,20
21CB3001000	300	1000	1.216,35
21CB4000100	400	100	Consultar
21CB4000200	400	200	Consultar
21CB4000300	400	300	Consultar
21CB4000400	400	400	Consultar
21CB4000500	400	500	Consultar
21CB4001000	400	1000	Consultar

Accesorios de fundición



Reducción fundición con bridas

Código	DN	Precio €
21F149065050	65-50	83,47
21F149080050	80-50	85,86
21F149080065	80-65	97,78
21F149100050	100-50	97,78
21F149100065	100-65	107,32
21F149100080	100-80	109,71
21F149125100	125-100	145,48
21F149150050	150-50	131,17
21F149150065	150-65	140,71
21F149150080	150-80	145,48
21F149150100	150-100	152,64
21F149200080	200-80	243,27
21F149200080016	200PN16-80	243,27
21F149200100	200-100	245,65
21F149200100016	200PN16-100	245,65
21F149200150	200-150	267,12
21F149200150016	200PN16-150	267,12
21F149250100	250-100	310,05
21F149250100016	250PN16-100	310,05
21F149250150	250-150	369,67
21F149250150016	250PN16-150	369,67
21F149250200	250-200	386,37
21F149250200016	250PN16-200PN16	386,37
21F149300100	300-100	369,67
21F149300100016	300PN16-100	369,67
21F149300150	300-150	436,45
21F149300200	300-200	479,38
21F149300200016	300PN16-200PN16	479,38
21F149300250	300-250	491,31
21F149300250016	300PN16-250PN16	491,31
21F149400150	400-150	665,41
21F149400200	400-200	677,34
21F149400250	400-250	810,90
21F149400300	400-300	832,36
21F149500300	500-300	1.328,44



Carrete de desmontaje

Código	DN	PN	Precio €
21CTD050	50	10/16	186,03
21CTD065	65	10/16	212,26
21CTD080	80	10/16	262,35
21CTD100	100	10/16	281,43
21CTD125	125	10/16	395,91
21CTD150	150	10/16	436,45
21CTD200010	200	10	565,24
21CTD200016	200	16	655,87
21CTD250010	250	10	796,59
21CTD250016	250	16	911,07
21CTD300010	300	10	949,23
21CTD300016	300	16	1.066,09
21CTD350010	350	10	1.342,75
21CTD350016	350	16	1.419,07
21CTD400010	400	10	1.488,24
21CTD400016	400	16	1.984,32
21CTD500010	500	10	1.917,54
21CTD500016	500	16	3.203,05
21CTD600010	600	10	2.883,46
21CTD600016	600	16	4.018,72
21CTD700010	700	10	3.863,70
21CTD700016	700	16	4.335,93
21CTD800010	800	10	4.474,26
21CTD800016	800	16	6.136,60
21CTD900010	900	10	6.162,84
21CTD900016	900	16	8.306,95
21CTD1000010	1000	10	6.565,90
21CTD1000016	1000	16	9.008,14
21CTD1200010	1200	10	8.894,70
21CTD1200016	1200	16	13.084,11

Válvulas

Válvula de mariposa



Código	DN	PN	Precio €
06VM200	50	10/16	60,75
06VM212	65	10/16	112,00
06VM300	80	10/16	118,28
06VM400	100	10/16	123,80
06VM500	125	10/16	132,40
06VM600	150	10/16	147,20
06VM700	200	10/16	236,25
06VM800	250	10/16	362,25
06VM900	300	10/16	605,25
06VM1000	400	10/16	1.579,50

Válvula de compuerta F4



Código	DN	PN	Precio €
21ACVC040	40	10/16	174,72
21ACVC050	50	10/16	183,14
21ACVC065	60/65	10/16	197,87
21ACVC080	80	10/16	233,66
21ACVC100	100	10/16	290,49
21ACVC125	125	10/16	486,26
21ACVC150	150	10/16	484,15
21ACVC200010	200	10	812,53
21ACVC200016	200	16	812,53
21ACVC250010	250	10	1.117,76
21ACVC250016	250	16	1.153,54
21ACVC300010	300	10	1.723,99
21ACVC300016	300	16	1.761,89
21ACVC350010	350	10	2.934,37
21ACVC350016	350	16	3.018,57
21ACVC400010	400	10	3.974,24
21ACVC400016	400	16	4.058,44
21ACVC500010	500	10	6.388,68
21ACVC500016	500	16	6.504,45
21ACVC600010	600	10	9.813,51
21ACVC600016	600	16	9.929,29

Válvula de compuerta F5



Código	DN	PN	Precio €
21ACVC050F5	50	10/16	191,25
21ACVC060F5	60/65	10/16	207,00
21ACVC080F5	80	10/16	252,00
21ACVC100F5	100	10/16	315,00
21ACVC125F5	125	10/16	531,00
21ACVC150F5	150	10/16	537,75
21ACVC200F5	200	10/16	900,00
21ACVC250F5	250	10/16	1.203,75
21ACVC300F5	300	10/16	1.883,25

Válvulas

Válvula de compuerta con rosca interna (H-H)



Código	DN	Cuadradillo (mm)	Precio €
21VCR020HH	3/4"	14	73,93
21VCR025HH	1"	14	76,32
21VCR032HH	1 1/4"	14	93,01
21VCR040HH	1 1/2"	14	109,35
21VCR050HH	2"	14	121,63

Válvula de compuerta con rosca interna y externa (M-H)



Código	DN	Cuadradillo (mm)	Precio €
21VCR025MH	1"	14	97,78
21VCR032MH	1 1/4"	14	104,94
21VCR040MH	1 1/2"	14	143,10
21VCR050MH	2"	14	171,72

Válvula bola de retención roscada



Código	DN	PN	Precio €
21VRR100	1"	10/16	51,75
21VRR114	1 1/4"	10/16	60,75
21VRR112	1 1/2"	10/16	76,50
21VRR200	2"	10/16	108,00

Válvula bola de retención



Código	DN	PN	Precio €
21VRB050	50	10/16	157,41
21VRB065	65	10/16	190,80
21VRB080	80	10/16	238,50
21VRB100	100	10/16	307,66
21VRB125	125	10/16	426,91
21VRB150	150	10/16	443,61
21VRB200010	200	10	787,05
21VRB200016	200	16	787,05
21VRB250010	250	10	1.042,24
21VRB250016	250	16	1.042,24
21VRB300010	300	10	1.714,81
21VRB300016	300	16	1.714,81
21VRB400010	400	10	6.666,07

Válvulas

Válvula de guillotina



Código	DN	PN	Precio €
21VG050	50	10/16	300,51
21VG065	65	10/16	374,44
21VG080	80	10/16	434,07
21VG100	100	10/16	505,62
21VG125	125	10/16	701,19
21VG150	150	10/16	767,97
21VG200	200	10	1.173,42
21VG250	250	10	1.679,04
21VG300	300	10	2.070,18
21VG400	400	10	3.536,95
21VG500	500	10	8.492,98
21VG600	600	10	Consultar

Llave de maniobra



Código	DN	Precio €
21LLM025050	25-50	104,94

Alargo telescópico



Código	Cuadrado (mm)	L (m)	Precio €
21AT1013	10	1,3 - 1,8	69,16
21AT1213	12	1,3 - 1,8	71,55
21AT1413	14	1,3 - 1,8	78,70
21AT1713	17	1,3 - 1,8	85,86
21AT1913	19	1,3 - 1,8	88,24
21AT2413	24	1,3 - 1,8	114,48
21AT2713	27	1,3 - 1,8	124,02
21AT3213	32	1,3 - 1,8	226,57
21AT1420	14	2,0 - 2,5	100,17
21AT1720	17	2,0 - 2,5	116,86
21AT1920	19	2,0 - 2,5	119,25
21AT2420	24	2,0 - 2,5	150,25



06

VALVULERÍA

Válvulas

Válvula de esfera



Código	DN	Precio €
06VEHH012	1/2"	5,76
06VEHH034	3/4"	10,12
06VEHH100	1"	16,96
06VEHH114	1 1/4"	28,08
06VEHH112	1 1/2"	37,08
06VEHH200	2"	57,48
06VEHH212	2 1/2"	120,36
06VEHH300	3"	149,32
06VEHH400	4"	314,26

Válvula reductora de presión



Código	Medida	Precio €
06VRP012	1/2"	25,00
06VRP034	3/4"	37,60
06VRP100	1"	57,69
06VRP114	1 1/4"	83,24
06VRP112	1 1/2"	118,41
06VRP200	2"	148,35

Filtro colador roscado



Código	Medida	Precio €
06FCY012	1/2"	7,52
06FCY034	3/4"	8,88
06FCY100	1"	14,40
06FCY114	1 1/4"	25,40
06FCY112	1 1/2"	37,40
06FCY200	2"	69,92



ACCESORIOS PARA TUBERÍA

Accesorios de latón para tubería PE

Manguito latón

	Código	Medida	Precio €
 <p>Hasta 63 mm Desde 75 mm</p>	11BH100020	20mm	7,73
	11BH100025	25mm	11,17
	11BH110032	32mm	17,21
	11BH100040	40mm	29,70
	11BH100050	50mm	42,07
	11BH100063	63mm	72,08
	11BH100075	75mm	138,93
	11BH100090	90mm	216,92
	11BH100110	110mm	280,20

Enlace recto rosca macho latón

	Código	Medida	Precio €
 <p>Hasta 63 mm Desde 75 mm</p>	11BH110020012	20mm - 1/2"	4,93
	11BH110025034	25mm - 3/4"	6,80
	11BH110032100	32mm - 1"	11,43
	11BH110040114	40mm - 1 1/4"	17,89
	11BH110050112	50mm - 1 1/2"	27,20
	11BH110063200	63mm - 2"	43,30
	11BH110075212	75mm - 2 1/2"	98,64
	11BH110090300	90mm - 3"	145,77
	11BH110110400	110mm - 4"	168,25

Enlace recto rosca hembra latón

	Código	Medida	Precio €
 <p>Hasta 63 mm Desde 75 mm</p>	11BH116020012	20mm - 1/2"	4,93
	11BH116025034	25mm - 3/4"	7,26
	11BH116032100	32mm - 1"	10,96
	11BH116040114	40mm - 1 1/4"	18,99
	11BH116050112	50mm - 1 1/2"	26,77
	11BH116063200	63mm - 2"	50,10
	11BH116075212	75mm - 2 1/2"	98,13
	11BH116090300	90mm - 3"	146,49
	11BH116110400	110mm - 4"	171,36

T latón

	Código	Medida	Precio €
 <p>Hasta 63 mm Desde 75 mm</p>	11BH125020	20mm	12,36
	11BH125025	25mm	19,33
	11BH125032	32mm	28,77
	11BH125040	40mm	43,73
	11BH125050	50mm	76,24
	11BH125063	63mm	122,40
	11BH125075	75mm	240,89
	11BH125090	90mm	385,17
	11BH125110	110mm	551,90

Accesorios de latón para tubería PE

T rosca macho latón



Hasta 63 mm

Código	Medida	Precio €
11BH131020012	20mm - 1/2"	10,10
11BH131025034	25mm - 3/4"	15,40
11BH131032100	32mm - 1"	25,35
11BH131040114	40mm - 1 1/4"	37,20
11BH131050112	50mm - 1 1/2"	58,70
11BH131063200	63mm - 2"	99,10

T rosca hembra latón



Hasta 63 mm



Desde 75 mm

Código	Medida	Precio €
11BH132020012	20mm - 1/2"	11,30
11BH132025034	25mm - 3/4"	15,00
11BH132032100	32mm - 1"	25,33
11BH132040114	40mm - 1 1/4"	38,03
11BH110050112	50mm - 1 1/2"	65,66
11BH132063200	63mm - 2"	109,86
11BH132075212	75mm - 2 1/2"	180,62
11BH132090300	90mm - 3"	252,40
11BH132110400	110mm - 4"	430,73

Codo 90° latón



Hasta 63 mm



Desde 75 mm

Código	Medida	Precio €
11BH120020	20mm	9,01
11BH120025	25mm	13,68
11BH120032	32mm	21,33
11BH120040	40mm	33,61
11BH120050	50mm	51,76
11BH120063	63mm	85,42
11BH120075	75mm	210,24
11BH120090	90mm	257,80
11BH120110	110mm	383,64

Codo 90° rosca macho latón



Hasta 63 mm



Desde 75 mm

Código	Medida	Precio €
11BH12102012	20mm - 1/2"	6,71
11BH121025034	25mm - 3/4"	10,83
11BH121032100	32mm - 1"	16,83
11BH121040114	40mm - 1 1/4"	21,97
11BH121050112	50mm - 1 1/2"	41,43
11BH121063200	63mm - 2"	64,60
11BH121075212	75mm - 2 1/2"	136,25
11BH121090300	90mm - 3"	163,24
11BH121110400	110mm - 4"	253,17

Accesorios de latón para tubería PE

Codo 90° rosca hembra latón



Hasta 63 mm



Desde 75 mm

Código	Medida	Precio €
11BH122020012	20mm - 1/2"	6,71
11BH122025034	25mm - 3/4"	9,13
11BH122032100	32mm - 1"	15,42
11BH122040114	40mm - 1 1/4"	22,31
11BH122050112	50mm - 1 1/2"	41,60
11BH122063200	63mm - 2"	71,69
11BH122075212	75mm - 2 1/2"	108,03
11BH122090300	90mm - 3"	193,88
11BH122110400	110mm - 4"	246,28

Codo placa rosca hembra latón



Código	Medida	Precio €
11BH150020012	20mm - 1/2"	6,84
11BH150025034	25mm - 3/4"	15,98
11BH150032100	32mm - 1"	20,60

Accesorios electrosoldables para tubería PE

Manguito electrosoldable



Código	Medida	Precio €
33ELS100020	20mm	4,35
33ELS100025	25mm	4,40
33ELS100032	32mm	4,54
33ELS100040	40mm	5,05
33ELS100050	50mm	5,51
33ELS100063	63mm	5,97
33ELS100075	75mm	7,92
33ELS100090	90mm	10,51
33ELS100110	110mm	17,78
33ELS100125	125mm	20,28
33ELS100140	140mm	23,47
33ELS100160	160mm	33,34
33ELS100180	180mm	41,58
33ELS100200	200mm	77,04
33ELS100225	225mm	98,25
33ELS100250	250mm	117,93
33ELS100280	280mm	159,13
33ELS100315	315mm	211,87
33ELS100355	355mm	293,22
33ELS100400	400mm	469,07
33ELS100450	450mm	607,46
33ELS100500	500mm	649,40
33ELS100560	560mm	862,57
33ELS100630	630mm	1.189,45

Codo 90° Electrosoldable



Código	Medida	Precio €
33ELS120020	20mm	10,74
33ELS120025	25mm	10,74
33ELS120032	32mm	7,82
33ELS120040	40mm	10,28
33ELS120050	50mm	10,28
33ELS120063	63mm	11,48
33ELS120075	75mm	17,78
33ELS120090	90mm	25,42
33ELS120110	110mm	32,04
33ELS120125	125mm	45,05
33ELS120140*	140mm	57,78
33ELS120160	160mm	99,27
33ELS120180	180mm	156,45
33ELS120200	200mm	176,31
33ELS120225	225mm	232,75

Accesorios electrosoldables para tubería PE

Codo 45° Electrosoldable



Código	Medida	Precio €
33ELS123032*	32mm	6,85
33ELS123040	40mm	9,86
33ELS123050	50mm	9,86
33ELS123063	63mm	11,76
33ELS123075	75mm	15,56
33ELS123090	90mm	24,59
33ELS123110	110mm	28,06
33ELS123125	125mm	54,45
33ELS123140*	140mm	74,17
33ELS123160	160mm	86,86
33ELS123180*	180mm	125,89
33ELS123200	200mm	145,20
33ELS123225	225mm	187,98

Los productos marcados * corresponden a accesorios inyectados con electrosoldables

T igual electrosoldable



Código	Medida	Precio €
33ELS125032	32mm	11,02
33ELS125040	40mm	14,40
33ELS125050	50mm	14,82
33ELS125063	63mm	15,42
33ELS125075	75mm	31,11
33ELS125090	90mm	34,22
33ELS125110	110mm	36,67
33ELS125125	125mm	63,57
33ELS125140	140mm	77,04
33ELS125160	160mm	151,59
33ELS125180	180mm	231,13
33ELS125200	200mm	217,80
33ELS125225	225mm	282,99

T reducida electrosoldable



Código	Medida	Precio €
33ELS125090063	90-63mm	63,71
33ELS125110063	110-63mm	72,60
33ELS125110090	110-90mm	90,10
33ELS125160063	160-63mm	151,12
33ELS125160090	160-90mm	151,12
33ELS125160110	160-110mm	151,12

Accesorios electrosoldables para tubería PE

Reducción electrosoldable



Código	Medida	Precio €
33ELS149063032	63-32mm	14,82
33ELS149063040	63-40mm	14,82
33ELS149063050*	63-50mm	22,04
33ELS149075050*	75-50mm	18,66
33ELS149090063	90-63mm	27,41
33ELS149110063	110-63mm	31,39
33ELS149110090	110-90mm	37,04
33ELS149160110	160-110mm	74,08
33ELS149225160*	225-160mm	147,14

*Los productos marcados * corresponden a accesorios inyectados con electrosoldables*

Tapón electrosoldable



Código	Medida	Precio €
33ELS300020	20mm	5,46
33ELS300025	25mm	5,93
33ELS300032	32mm	6,53
33ELS300040	40mm	7,13
33ELS300050	50mm	8,89
33ELS300063	63mm	10,97
33ELS300075	75mm	14,82
33ELS300090	90mm	21,34
33ELS300110	110mm	31,85
33ELS300125	125mm	39,54
33ELS300140	140mm	56,58
33ELS300160	160mm	62,97
33ELS300180	180mm	88,90
33ELS300200	200mm	105,19
33ELS300225	225mm	133,34
33ELS300250	250mm	222,24
33ELS300280	280mm	296,32
33ELS300315	315mm	370,40

Collarín electrosoldable



Código	Medida	Precio €
33ELS525063063	63-63mm	22,04
33ELS525075063	75-63mm	22,04
33ELS525090063	90-63mm	24,63
33ELS525110063	110-63mm	24,63
33ELS525125063	125-63mm	24,63
33ELS525140063	140-63mm	27,22
33ELS525160063	160-63mm	27,22
33ELS525180063	180-63mm	27,22
33ELS525200063	200-63mm	30,98
33ELS525225063	225-63mm	30,98
33ELS525250063	250-63mm	30,98
33ELS525280063	280-63mm	51,21
33ELS525315063	315-63mm	51,21
33ELS525355063	355-63mm	51,21
33ELS525400063	400-63mm	51,21

Accesorios electrosoldables para tubería PE

Collarín de toma en carga



	Código	Medida	Precio €
	33ELS351063020	63-20mm	22,04
	33ELS351063032	63-32mm	22,04
	33ELS351063040	63-40mm	22,04
	33ELS351063063	63-63mm	36,30
	33ELS351090032	90-32mm	23,98
	33ELS351090063	90-63mm	36,30
	33ELS351110020	110-20mm	23,98
	33ELS351110032	110-32mm	23,98
	33ELS351110040	110-40mm	23,98
	33ELS351110063	110-63mm	36,30
	33ELS351125020	125-20mm	23,98
	33ELS351125032	125-32mm	23,98
	33ELS351125040	125-40mm	23,98
	33ELS351125063	125-63mm	36,30
	33ELS351160020	160-20mm	25,93
	33ELS351160032	160-32mm	25,93
	33ELS351160040	160-40mm	25,93
	33ELS351160063	160-63mm	36,30
	33ELS351180032	180-32mm	25,93
	33ELS351180063	180-63mm	36,30
	33ELS351200020	200-20mm	29,82
	33ELS351200032	200-32mm	29,82
	33ELS351200040	200-40mm	29,82
	33ELS351200063	200-63mm	44,08
	33ELS351225032	225-32mm	29,82
	33ELS351225063	225-63mm	45,37

Derivación con carga superior



	Código	Medida	Precio €
	33ELSD355090	355-90mm	226,87
	33ELSD400110	400-110mm	226,87
	33ELSD450125	450-125mm	246,32
	33ELSD500160	500-160mm	324,10
	33ELSD560180	560-180mm	404,48
	33ELSD630200	630-200mm	404,48
	33ELSD710225	710-225mm	445,96
	33ELSD800250	800-250mm	486,15
	33ELSD900280	900-280mm	547,08
	33ELSD1000315	1000-315mm	563,93

Accesorios electrosoldables para tubería PE

Collarín de toma simple



	Código	Medida	Precio €
	33ELS350075025	75-25mm	26,58
	33ELS350075032	75-32mm	26,58
	33ELS350075040	75-40mm	26,58
	33ELS350075050	75-50mm	27,87
	33ELS350125025	125-25mm	29,17
	33ELS350125032	125-32mm	27,87
	33ELS350125040	125-40mm	29,17
	33ELS350125050	125-50mm	29,17
	33ELS350140025	140-25mm	31,76
	33ELS350140032	140-32mm	31,76
	33ELS350140040	140-40mm	31,76
	33ELS350140050	140-50mm	32,41
	33ELS350160025	160-25mm	31,76
	33ELS350160032	160-32mm	31,76
	33ELS350160040	160-40mm	31,76
	33ELS350160050	160-50mm	32,41
	33ELS350180025	180-25mm	31,76
	33ELS350180032	180-32mm	31,76
	33ELS350180040	180-40mm	31,76
	33ELS350180050	180-50mm	32,41
	33ELS350200025	200-25mm	35,65
	33ELS350200032	200-32mm	35,65
	33ELS350200040	200-40mm	35,65
	33ELS350200050	200-50mm	36,30
	33ELS350225025	225-25mm	35,65
	33ELS350225032	225-32mm	35,65
	33ELS350225040	225-40mm	35,65
	33ELS350225050	225-50mm	36,30
	33ELS350250032	250-32mm	35,65
	33ELS350250040	250-40mm	35,65
	33ELS350250050	250-50mm	36,30
	33ELS350315032	315-32mm	55,75

Máquina de electrofusión

	Código	Descripción	Precio €
	33ELSMAQ	Hasta 160mm	1.850,00
	33ELSMAQ400	Hasta 400mm	2.664,00
	33ELSMAQLCB	Lector de código de barras	460,00



Hasta 160mm



Hasta 400mm

Accesorios inyectados para tubería PE

Codo 45° inyectado



	Código	Medida	Precio €
	33PEI123032	32mm	3,70
	33PEI123040	40mm	5,33
	33PEI123050	50mm	5,48
	33PEI123063	63mm	5,78
	33PEI123075	75mm	10,07
	33PEI123090	90mm	12,30
	33PEI123110	110mm	18,52
	33PEI123125	125mm	27,41
	33PEI123140	140mm	37,78
	33PEI123160	160mm	48,89
	33PEI123180	180mm	68,15
	33PEI123200	200mm	85,34
	33PEI123225	225mm	120,01

Codo 90° inyectado



	Código	Medida	Precio €
	33PEI120020	20mm	3,56
	33PEI120025	25mm	3,70
	33PEI120032	32mm	3,85
	33PEI120040	40mm	4,00
	33PEI120050	50mm	4,59
	33PEI120063	63mm	6,22
	33PEI120075	75mm	10,67
	33PEI120090	90mm	14,45
	33PEI120110	110mm	22,82
	33PEI120125	125mm	33,34
	33PEI120140	140mm	44,45
	33PEI120160	160mm	61,49
	33PEI120180	180mm	87,41
	33PEI120200	200mm	118,53
	33PEI120225	225mm	152,60

Portabridas inyectado



	Código	Medida	Precio €
	33PEIPB050	50mm	4,74
	33PEIPB063	63mm	5,19
	33PEIPB075	75mm	6,82
	33PEIPB090	90mm	8,74
	33PEIPB110	110mm	13,33
	33PEIPB125	125mm	18,45
	33PEIPB140	140mm	22,96
	33PEIPB160	160mm	32,00
	33PEIPB180	180mm	40,00
	33PEIPB200	200mm	57,78
	33PEIPB225	225mm	67,41

Accesorios inyectados para tubería PE

Reducción inyectada

Código	Medida	Precio €
33PEI149025020	25-20mm	3,56
33PEI149032020	32-20mm	2,96
33PEI149032025	32-25mm	2,96
33PEI149040025	40-25mm	4,30
33PEI149040032	40-32mm	4,37
33PEI149050032	50-32mm	5,19
33PEI149050040	50-40mm	5,19
33PEI149063032	63-32mm	5,19
33PEI149063040	63-40mm	5,19
33PEI149063050	63-50mm	6,07
33PEI149075050	75-50mm	5,93
33PEI149075063	75-63mm	6,07
33PEI149090063	90-63mm	8,59
33PEI149090075	90-75mm	9,33
33PEI149110063	110-63mm	10,30
33PEI149110090	110-90mm	12,30
33PEI149125025	125-25mm	11,70
33PEI149125063	125-63mm	13,04
33PEI149125075	125-75mm	13,33
33PEI149125090	125-90mm	14,82
33PEI149125110	125-110mm	17,19
33PEI149140075	140-75mm	21,48
33PEI149140090	140-90mm	21,48
33PEI149140110	140-110mm	21,48
33PEI149160090	140-125mm	22,22
33PEI149160090	160-90mm	25,19
33PEI149160110	160-110mm	26,22
33PEI149160125	160-125mm	26,67
33PEI149160140	160-140mm	30,08
33PEI149180090	180-90mm	31,11
33PEI149180110	180-110mm	32,60
33PEI149180125	180-125mm	35,56
33PEI149125075	180-140mm	34,82
33PEI149125090	180-160mm	37,78
33PEI149125110	200-90mm	55,56
33PEI149140075	200-110mm	47,71
33PEI149140090	200-125mm	48,89
33PEI149140110	200-140mm	49,63
33PEI149160090	200-160mm	51,12
33PEI149160090	200-180mm	53,34
33PEI149160110	225-110mm	55,56
33PEI149160125	225-125mm	75,56
33PEI149160140	225-160mm	62,23
33PEI149180090	225-180mm	69,64
33PEI149180110	225-200mm	71,12

Accesorios inyectados para tubería PE

T igual inyectada



	Código	Medida	Precio €
	33PEI125020	20mm	5,04
	33PEI125025	25mm	5,78
	33PEI125032	32mm	6,22
	33PEI125040	40mm	7,11
	33PEI125050	50mm	7,41
	33PEI125063	63mm	7,85
	33PEI125075	75mm	12,74
	33PEI125090	90mm	18,82
	33PEI125110	110mm	32,00
	33PEI125125	125mm	49,49
	33PEI125140	140mm	66,67
	33PEI125160	160mm	83,82
	33PEI125180	180mm	133,94
	33PEI125200	200mm	164,46
	33PEI125225	225mm	211,87

Brida loca zincada PN 10/16



	Código	Medida	Precio €
	33PEIBL063050	DN50/63mm	19,53
	33PEIBL075065	DN65/75mm	24,70
	33PEIBL090080	DN80/90mm	29,55
	33PEIBL110100	DN100/110mm	32,84
	33PEIBL125100	DN100/125mm	35,61
	33PEIBL125125	DN125/125mm	49,47
	33PEIBL140125	DN125/140mm	50,22
	33PEIBL160150	DN150/160mm	58,46
	33PEIBL180150	DN150/180mm	58,72
	33PEIBL200200	DN200/200mm	85,20
	33PEIBL225200	DN200/225mm	85,58

Enlace transición inyectado rosca macho



	Código	Medida	Precio €
	33PEI110032100	32mm x 1"	27,09
	33PEI110040114	40mm x 1 1/4"	40,63
	33PEI110050112	50mm x 1 1/2"	47,30
	33PEI110063200	63mm x 2"	54,17
	33PEI110075212	75mm x 2 1/2"	93,76
	33PEI110090300	90mm x 3"	162,51
	33PEI110110400	110mm x 4"	200,02

Soldadura a tope

Equipo de soldadura a tope



Código	Descripción	Aplicación	Precio €
33PEIMAQ0160	Equipo 160 manual	50-160mm	Consultar
33PEIMAQ0250	Equipo 250 manual	63-250mm	Consultar
33PEIMAQ0315	Equipo 315 manual	90-315mm	Consultar
33PEIMAQ0400	Equipo 400 manual	110-400mm	Consultar
33PEIMAQ0500	Equipo 500 manual	250-500mm	Consultar
33PEIMAQ0630	Equipo 630 manual	355-630mm	Consultar
33PEIMAQ0800	Equipo 800 manual	500-800mm	Consultar
33PEIMAQ1000	Equipo 1000 manual	450-1000mm	Consultar
33PEIMAQ1200	Equipo 1200 manual	630-1200mm	Consultar

Útiles y herramientas para tubería

Estranguladores



Código	Descripción	Aplicación	Precio €
33EM020090	Estrang. manual	20-90 mm	Consultar
33EH090160	Estrang. hidráulico	90-160 mm	Consultar
33EH110125	Estrang. hidráulico	110-125 mm	Consultar

Raspador manual



Código	Precio €
33RM	Consultar

Alineador



Código	Aplicación	Precio €
33AL025090	25-90 mm	Consultar
33AL025160	25-160 mm	Consultar

Accesorios de transición



Enlace macho transición

	Código	Medida	Precio €
 <p>1/2" - 2"</p>  <p>2 1/2" - 4"</p>	23EMHH012	1/2"	11,92
	23EMHH034	3/4"	15,72
	23EMHH100	1"	19,22
	23EMHH114	1 1/4"	27,64
	23EMHH112	1 1/2"	38,40
	23EMHH200	2"	43,26
	23EMHH212	2 1/2"	119,72
	23EMHH300	3"	161,40
	23EMHH400	4"	330,08

Enlace hembra transición

	Código	Medida	Precio €
 <p>1/2" - 2"</p>  <p>2 1/2" - 4"</p>	23EHHH012	1/2"	13,12
	23EHHH034	3/4"	14,80
	23EHHH100	1"	18,20
	23EHHH114	1 1/4"	26,64
	23EHHH112	1 1/2"	35,68
	23EHHH200	2"	42,48
	23EHHH212	2 1/2"	135,84
	23EHHH300	3"	164,28
	23EHHH400	4"	325,72

Manguito de transición

	Código	Medida	Precio €
 <p>1/2" - 2"</p>  <p>2 1/2" - 4"</p>	23MHH012	1/2"	25,04
	23MHH034	3/4"	31,52
	23MHH100	1"	36,24
	23MHH114	1 1/4"	45,48
	23MHH112	1 1/2"	59,60
	23MHH200	2"	91,36
	23MHH400	4"	465,00

Manguito mixto de transición PE-FE

	Código	Medida	Precio €
 <p>1/2" - 2"</p>  <p>2 1/2" - 4"</p>	23MPH020012	20mm - 1/2"	38,80
	23MPH025034	25mm - 3/4"	46,64
	23MPH032100	32mm - 1"	53,26
	23MPH040114	40mm - 1 1/4"	69,96
	23MPH050112	50mm - 1 1/2"	84,08
	23MPH063200	63mm - 2"	123,72
	23MPH075212	75mm - 2 1/2"	234,01
	23MPH090300	90mm - 3"	252,92
	23MPH110400	110mm - 4"	605,28



Somos parte del ciclo del agua

Calle Valencia 471, 08013 Barcelona

www.gatell.com

 +34 932 456 845

 www.gatell.com

 @gatell_sa

 /company/gatell

 /gatellsa

 @gatell1942