



IVAR

HYDRONIC COMPONENTS & SYSTEMS

CATALOGUE L28

INTERNATIONAL

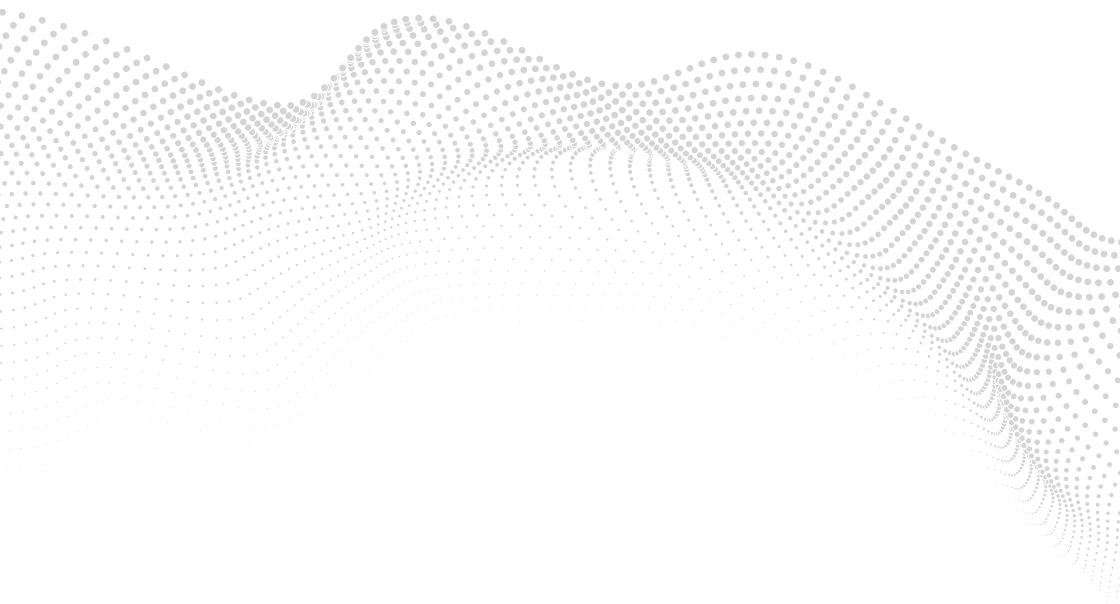

IVAR

Hydronic solutions for every need

Established in 1985 as company focused on the production of valves, over the years IVAR actively seeks and develops new products reaching high quality standards, to become today one of the leading companies in the sector of plumbing and heating components.

From sourcing raw materials to choosing our packaging, every process is carefully examined and optimised to save energy and materials in facilities with near-zero environmental impact.

The Italian headquarters also acts as a hub for the wider IVAR Group, set up with the goal of distributing products beyond Italy's borders. The group now has 11 branches, in Australia, Belgium, China, Germany, the United Kingdom, the Czech Republic, Romania, Slovakia, Spain, the United States and Tunisia.

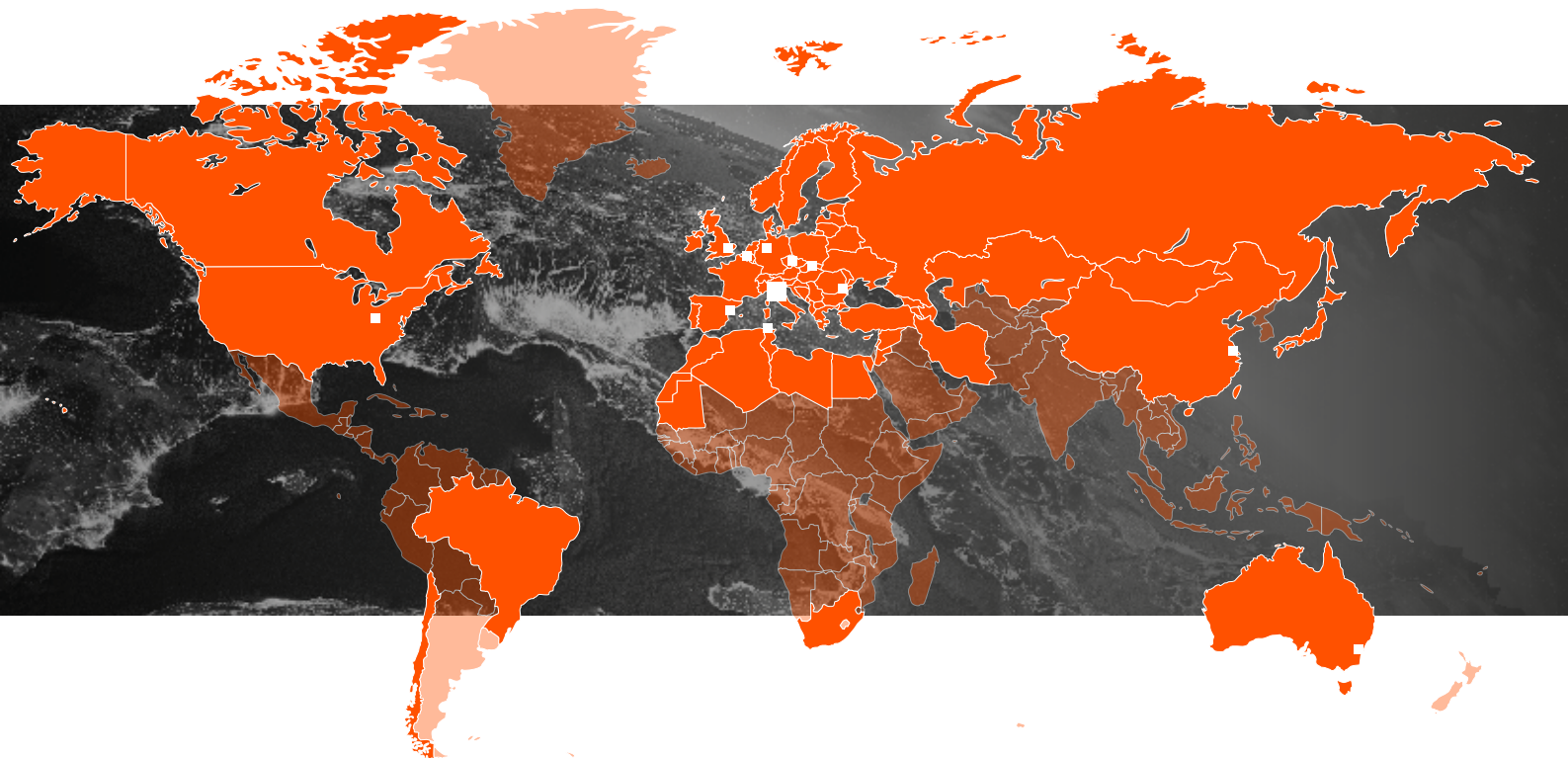



11.000 Made in Italy
products

50.900 sqm total surface
of production area

11 World business
branches

60 Countries where
IVAR trades

4 Corporate
certifications

Mass market products
and customized solutions



DOWNLOAD ALL THE TECHNICAL FOCUSES

IN YOUR FAVOURITE LANGUAGE



pim.ivar-group.com/short/FocusTecnici



DOWNLOAD
Focus tecnici



pim.ivar-group.com/short/DetailsTechniques



DOWNLOAD
Détails techniques



pim.ivar-group.com/short/TechnischeDetails

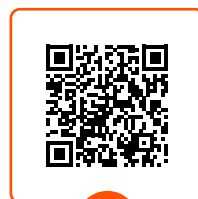

DOWNLOAD
Technische Details



pim.ivar-group.com/short/ProfTécnicas

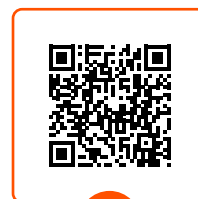

DOWNLOAD
Profundizaciones técnicas

Valvole per radiatori e fan-coil
Radiator and fan-coil valves
Robinets pour radiateurs et fan-coils
Heizkörper- und Ventilator-konvektoren-Ventile
Válvulas para radiadores y fan-coil

p. 7

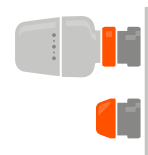

Tubazioni e raccorderia
Pipes and fittings
Tuyaux et raccords
Rohre und Fittings
Tuberías y accesorios

p. 77



Collettori
Manifolds
Collecteurs
Verteiler
Colectores

p. 135



Sistemi radianti
Radiant systems
Systèmes radiants
Flachheizung-Systeme
Sistemas radiantés

p. 231

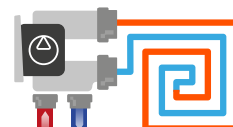

Centrale termica
Thermal power station
Centrale thermique
Heizungsanlagen
Central térmica

p. 287

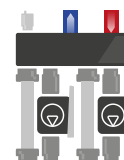

Regolazione e controllo
Regulation & control
Réglage et contrôle
Regelung und Bedingung
Regulación y control

p. 341



Bilanciamento idraulico
Hydraulic balancing
Équilibrage hydraulique
Hydraulischer Ausgleich
Equilibrio hidráulico

p. 365

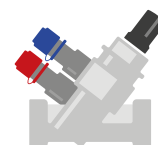

Satelliti di utenza
Satellite modules
Satellites d'application
Satellitenmodule
Módulos satélite

p. 381

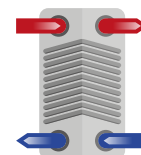

Impianti sanitari
Sanitary systems
Installations sanitaires
Sanitäre Anlagen
Instalaciones sanitarias

p. 405



Sistemi per il gas
Systems for gas
Systèmes pour le gaz
Systeme für Gas
Sistemas para el gas

p. 451



Contabilizzazione
Metering systems
Comptabilisation
Kostenabrechnung
Contabilización

p. 469



Sistemi solari
Solar systems
Systèmes solaires
Solarsysteme
Sistemas solares

p. 525







RADIATOR AND FAN-COIL VALVES

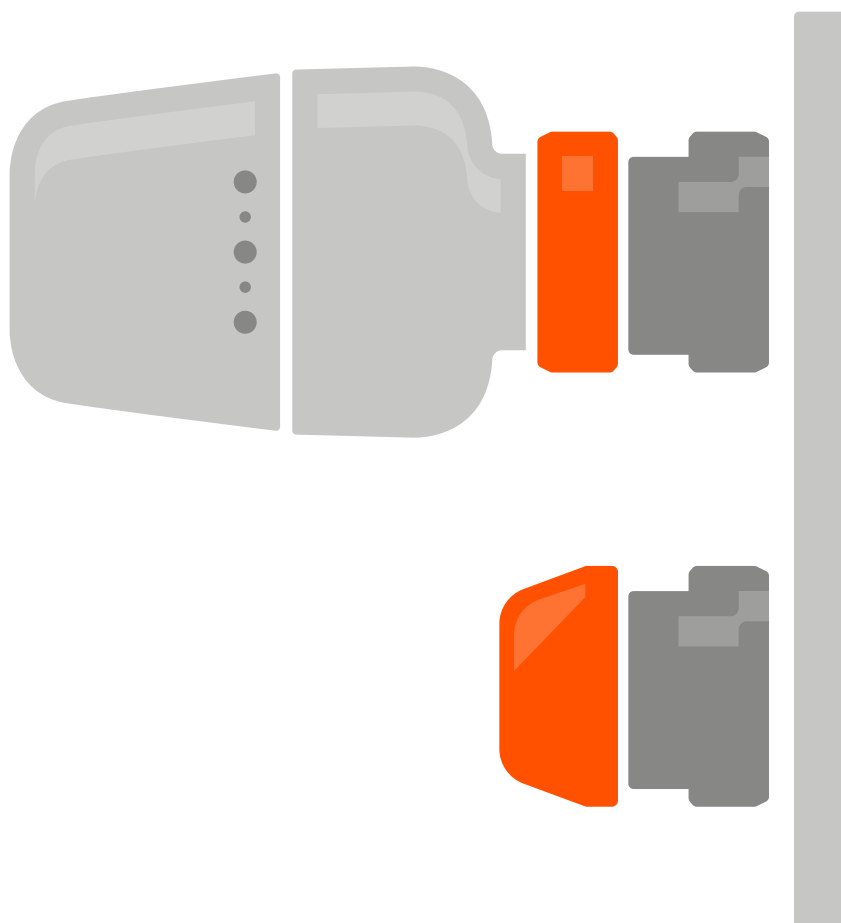

pim.ivar-group.com/short/IT-01

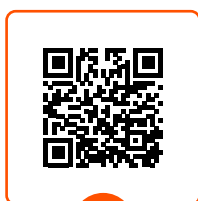

DOWNLOAD
Focus tecnici



pim.ivar-group.com/short/FR-01

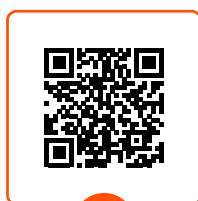

DOWNLOAD
Détails techniques



pim.ivar-group.com/short/DE-01

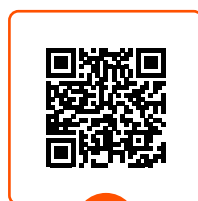







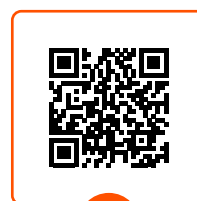



DOWNLOAD
Technische Details



pim.ivar-group.com/short/ES-01



DOWNLOAD
Profundizaciones técnicas

	<p>Teste termostatiche, valvole e detentori serie OPTIMA <i>Thermostatic heads, valves and lockshields OPTIMA series</i> Têtes thermostatiques, robinets et raccords de réglage de la série OPTIMA <i>Thermostat-Köpfe, Ventile und Rücklaufventile OPTIMA-Serie</i> Cabezas termostáticas, válvulas y detentores de la serie optima</p>	10
	<p>Teste termostatiche <i>Thermostatic heads</i> Têtes thermostatiques <i>Thermostat-Köpfe</i> Cabezas termostáticas</p>	22
	<p>Valvole termostatzabili serie HARMONIA <i>Thermostatic valves HARMONIA series</i> Robinets thermostatisables série HARMONIA <i>Thermostatventile HARMONIA-Serie</i> Válvulas termostatzables serie HARMONIA</p>	26
	<p>Valvole termostatzabili <i>Thermostatic valves</i> Robinets thermostatisables <i>Thermostatventile</i> Válvulas termostatzables</p>	31
	<p>Valvole manuali <i>Manual valves</i> Robinets manuels <i>Handbetätigung Ventile</i> Válvulas manuales</p>	45
	<p>Detentori <i>Lockshields</i> Raccords de réglage <i>Rücklaufventile</i> Detentores</p>	48
	<p>Valvole per radiatori serie BASIC <i>Radiator valves BASIC series</i> Robinets pour radiateurs de la série BASIC <i>Heizkörper-Ventile BASIC-Serie</i> Válvulas para radiadores de la serie BASIC</p>	53
	<p>Kit radiatore <i>Radiator kits</i> Kits pour radiateur <i>Heizkörper-Bausätze</i> Kits para radiador</p>	56
	<p>Valvole H <i>H valves</i> Pièces H <i>H-Ventile</i> Válvulas H</p>	58
	<p>Distributori a 4 vie <i>4-way distributors</i> Distributeurs à 4 voies <i>4-Wege-Anschlussgewinde</i> Distribuidores de 4 vías</p>	60



	<p>Valvole monotubo termostattizzabili <i>Single-pipe thermostatic valves</i> Robinets monotube thermostatizables <i>Einrohr-Thermostatventile</i> Válvulas monotubo termostatizables</p>	62
	<p>Valvole monotubo manuali <i>Single-pipe manual valves</i> Robinets monotube manuels <i>Einrohr-Handbetätigungventile</i> Válvulas monotubo manuales</p>	63
	<p>Accessori e parti di ricambio per valvole monotubo <i>Accessories and spare parts for single-pipe valves</i> Accessoires et pièces de rechange pour les robinets monotube <i>Zubehör und Ersatzteile für Einrohr-Ventile</i> Accesorios y repuestos para válvulas monotubo</p>	64
	<p>Raccordi <i>Fittings</i> Raccords <i>Verbinder</i> Racores</p>	65
	<p>Accessori e parti di ricambio <i>Accessories and spare parts</i> Accessoires et pièces de rechange <i>Zubehör und Ersatzteile</i> Accesorios y repuestos</p>	68
	<p>Valvole per Fan-coil <i>Fan-coil valves</i> Robinets pour Fan-coil <i>Ventile für Ventilator-konvektoren</i> Válvulas para Fan-coil</p>	70
	<p>Fan-coil unit kit <i>Fan-coil unit kit</i> Fan-coil unit kit <i>Fan-Coil Unit Kit</i> Fan-coil unit kit</p>	72

The OPTIMA thermostatic valve range features a superior quality finish which ensures perfect application in designer heating units. The technical specifications are also impressive: the DH 01 head features an ultra-rapid response and extremely low hysteresis, ranking it at the top of the range of IVAR thermostatic controls.

Valves and lockshields complete the range with the same finishes, complete with accessories and fittings. All valves and lockshields outlined in this section are supplied with AVK 01 adaptors.

Materials

Valve body: brass CW617N

Seals and O-rings: peroxide EPDM

Head knob: brass CW508L

Head thermostat: liquid expansion type

Technical specifications

Max. fluid temperature inside valve: 100 °C

Maximum operating pressure: 10 bar

Max. pressure differential on valves with fitted thermostatic head: 0.25 bar

Parameters according to EN 215 (for DH 01 WHITE only)

Hysteresis: 0.5 K

Influence of pressure differential D: 0.45 K

Effect of water temperature W: 0.8 K

Response time Z: 10 min (DH 01 WHITE); < 40 min (others)



⊕ PLUS

- Minimal and elegant design, suitable for modern heated towel rails
- Several finishes available
- Head with internal liquid expansion thermostat
- Equipped with selector for flow rate pre-regulation ⊕ FOCUS 1
- Ring nut can be replaced even when the system is working ⊕ FOCUS 2

FINISHES



CHROME



INOX



WHITE



BLACK
ON REQUEST



SILVER
ON REQUEST

Example codes

530040

530040INOX

530040WHITE



FOCUS 1: Pre-regulation

All Optima valves are fitted with a pre-adjustment selector which acts on the flow rate to simplify water balancing operations on the circuits.

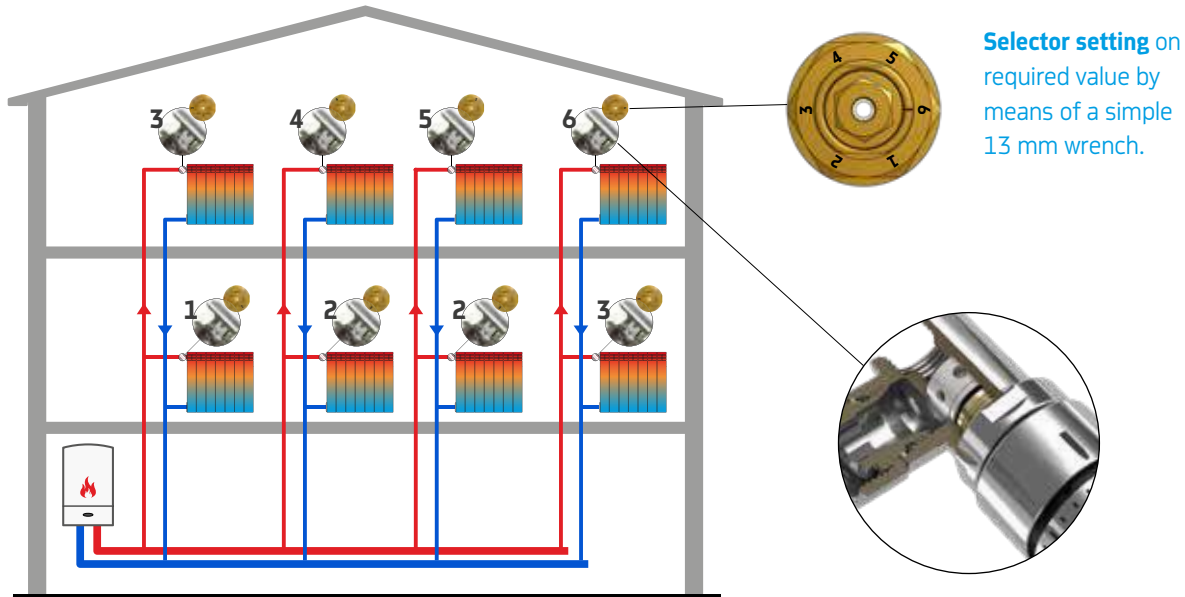

FOCUS 2: Ring nut substitution

The ring nut is screwed on a special insert and can be replaced even when the system is working.



VERSIONS EXAMPLE - OPTIMA

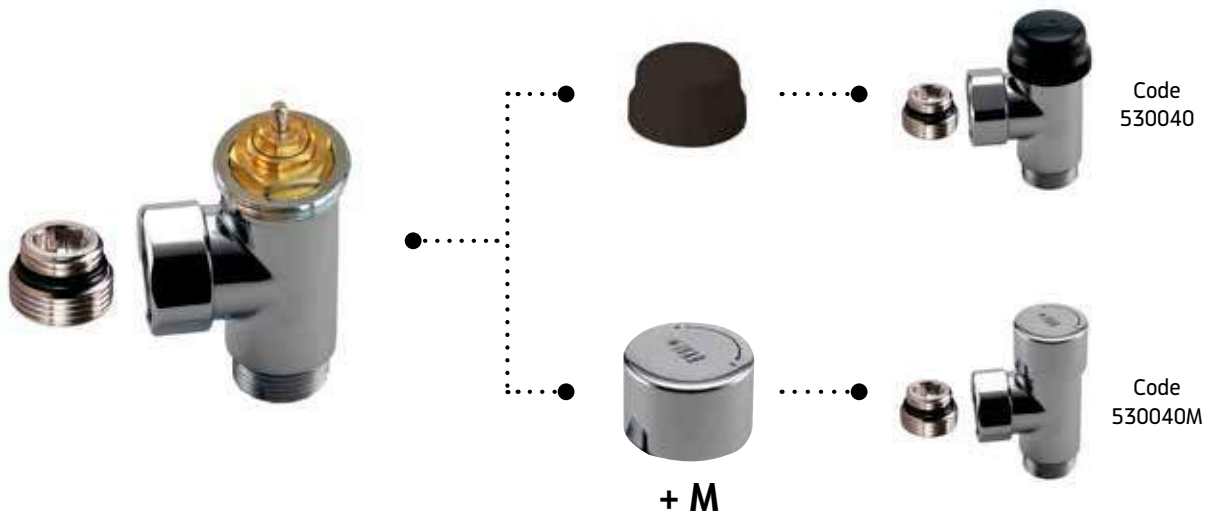

DH 01 CHROME



- Testa termostatica serie OPTIMA con comando e sensore a espansione di liquido incorporati.
- Thermostatic head OPTIMA series with incorporated command and liquid expansion sensor.
- Tête thermostatique série OPTIMA avec commande et senseur à expansion de liquide incorporés.
- Thermostat-Kopf OPTIMA-Serie mit eingebauten Steuerung und Flüssigkeitsausdehnung Fühler.
- Cabeza termostática de la serie OPTIMA con mando y sensor de expansión de líquido incorporados.

Code	Size	Z	Range	Color	Price	Class	Packaging
530021	M30 x 1,5	< 40 min	6,5-28 °C	■	37,45 €	RA	1 / 90

DH 01 INOX



- Testa termostatica serie OPTIMA con comando e sensore a espansione di liquido incorporati.
- Thermostatic head OPTIMA series with incorporated command and liquid expansion sensor.
- Tête thermostatique série OPTIMA avec commande et senseur à expansion de liquide incorporés.
- Thermostat-Kopf OPTIMA-Serie mit eingebauten Steuerung und Flüssigkeitsausdehnung Fühler.
- Cabeza termostática de la serie OPTIMA con mando y sensor de expansión de líquido incorporados.

Code	Size	Z	Range	Color	Price	Class	Packaging
530021INOX	M30 x 1,5	< 40 min	6,5-28 °C	■	52,03 €	RA	1 / 90

DH 01 WHITE



- Testa termostatica serie OPTIMA con comando e sensore a espansione di liquido incorporati. Isteresi 0,5 K.
- Thermostatic head OPTIMA series with incorporated command and liquid expansion sensor. Hysteresis 0.5 K.
- Tête thermostatique série OPTIMA avec commande et senseur à expansion de liquide incorporés. Hystérésis 0,5 K.
- Thermostat-Kopf OPTIMA-Serie mit eingebauten Steuerung und Flüssigkeitsausdehnung Fühler. Hysterese 0,5 K.
- Cabeza termostática de la serie OPTIMA con mando y sensor de expansión de líquido incorporados. Histéresis 0,5 K.



Code	Size	D	W	Z	Color	Price	Class	Packaging
530021WHITE	M30 x 1,5	0.45 K	0.80 K	10 min	□	37,45 €	RA	1 / 90

- D = Influenza della pressione differenziale. W = Effetto della temperatura dell'acqua. Z = Tempo di risposta.
- D = Differential pressure influence. W = Water temperature effect. Z = Response time.
- D = Influence de la pression différentielle. W = Influence de la température de l'eau. Z = Temps de réponse.
- D = Einfluß des Differenzialdrucks. W = Wassertemperatureinfluss. Z = Schließzeit.
- D = Influencia de la presión diferencial. W = Efecto de la temperatura del agua. Z = Tiempo de respuesta.

AD 03 M



- Testa manuale serie OPTIMA.
- Manual head OPTIMA series.
- Tête manuelle série OPTIMA.
- Manueller Hebel OPTIMA-Serie.
- Cabeza manual serie OPTIMA.

Code	Color	Price	Class	Packaging
530033M	■	10,81 €	RA	40 / 160
530033MINOX	■	13,46 €	RA	40 / 160
530033MWHITE	□	10,81 €	RA	40 / 160

AVK 01

- Adattatore per serie OPTIMA, detentori serie VK e valvole H.
- Adapter for OPTIMA series, VK series lockshields and H valves.
- Adaptateur pour série OPTIMA, coudes et tés de réglage série VK et pièces H.
- Adapter für Serie OPTIMA, Absperrungen der Serie VK und H-Ventile.
- Adaptador para serie OPTIMA, detentores serie VK y válvulas H

Code	Size	Color	Price	Class	Packaging
500770	EUROK x 1/2" M O-ring	■	1,996 €	EC	80 / 640

AD 03

- Cappuccio per detentori e valvole H serie OPTIMA.
- Cap for lockshields and H valves OPTIMA series.
- Capuchon pour tés/coudes de réglage et vannes en H série OPTIMA.
- Schutzkappe für Rücklaufventile und H-Thermostatventile OPTIMA-Serie.
- Capuchón para detentores y válvulas H serie OPTIMA.

Code	Color	Price	Class	Packaging
530033	■	10,81 €	RA	40 / 160
530033INOX	■	13,46 €	RA	40 / 160
530033WHITE	□	8,78 €	RA	40 / 160



■ DV 020



- Valvola termostattizzabile a squadra con prerregolazione serie OPTIMA con attacco maschio.
- Angle thermostatic valve with pre-regulation OPTIMA series with male connection.
- Robinet thermostatisable équerre avec pré-réglage série OPTIMA avec embout mâle.
- Eck-Thermostatventil mit Voreinstellung OPTIMA Serie mit AG Anschluss.
- Válvula termostatizable de escuadra con prerregulación serie OPTIMA con conexión macho.

Code	Size	Color	Price	Class	Packaging
530040	M24x1,5 x 1/2" M O-ring	■	43,38 €	RA	1 / 24
530040INOX	M24x1,5 x 1/2" M O-ring	■	54,06 €	RA	1 / 24
530040WHITE	M24x1,5 x 1/2" M O-ring	□	40,67 €	RA	1 / 24

■ DV 013



- Valvola termostattizzabile diritta con prerregolazione serie OPTIMA con attacco maschio.
- Straight thermostatic valve with pre-regulation OPTIMA series with male connection.
- Robinet thermostatisable droit avec pré-réglage série OPTIMA avec embout mâle.
- Durchgangs-Thermostatventil mit Voreinstellung OPTIMA Serie mit AG Anschluss.
- Válvula termostatizable recta con prerregulación serie OPTIMA con conexión macho.

Code	Size	Color	Price	Class	Packaging
530008	M24x1,5 x 1/2" M O-ring	■	44,07 €	RA	1 / 24
530008INOX	M24x1,5 x 1/2" M O-ring	■	54,47 €	RA	1 / 24
530008WHITE	M24x1,5 x 1/2" M O-ring	□	41,09 €	RA	1 / 24

■ DV 032



- Valvola termostattizzabile a corpo reverso OPTIMA con attacco maschio.
- Reverse thermostatic valve with pre-regulation OPTIMA series with male connection.
- Robinet thermostatisable à corps renversé avec pré-réglage série OPTIMA avec embout mâle.
- Reversthermostatventil mit Voreinstellung OPTIMA Serie mit AG Anschluss.
- Válvula termostatizable invertida con prerregulación serie OPTIMA con conexión macho.

Code	Size	Color	Price	Class	Packaging
530044	M24x1,5 x 1/2" M O-ring	■	50,54 €	RA	1 / 24
530044INOX	M24x1,5 x 1/2" M O-ring	■	60,68 €	RA	1 / 24
530044WHITE	M24x1,5 x 1/2" M O-ring	□	43,38 €	RA	1 / 24



- È possibile ordinare questi articoli con testa manuale utilizzando il medesimo codice, ma aggiungendo la "M" dopo l'ultima cifra.
- It is possible to order these items with manual head, please use the same reference code and add "M" after the last figure.
- Il est possible de commander ces articles avec la tête manuelle en utilisant le même code, mais en ajoutant le "M" après le dernier chiffre.
- Ausführung mit manueller Hebel verfügbar. Dieselbe o.g. Bestellnummer aber bitte „M“ nach der letzten Ziffer hinzufügen.
- Puede pedir estos artículos con cabeza manual, con el mismo código y añadiendo la "M" después del último dígito.

■ DV 030



- Detentore a squadra serie OPTIMA con attacco maschio.
- Angle lockshield OPTIMA series with male connection.
- Coude de réglage équerre série OPTIMA avec embout mâle.
- Eck-Rücklaufventil OPTIMA Serie mit AG Anschluss.
- Detentor de escuadra serie OPTIMA con conexión macho.

Code	Size	Color	Price	Class	Packaging
530041	M24x1,5 x 1/2" M O-ring	■	51,75 €	RA	1 / 24
530041INOX	M24x1,5 x 1/2" M O-ring	■	65,21 €	RA	1 / 24
530041WHITE	M24x1,5 x 1/2" M O-ring	□	47,11 €	RA	1 / 24

■ DV 023



- Detentore diritto serie OPTIMA con attacco maschio.
- Straight lockshield OPTIMA series with male connection.
- Tè de réglage droit série OPTIMA avec embout mâle.
- Durchgangs-Rücklaufventil OPTIMA Serie mit AG Anschluss.
- Detentor recto serie OPTIMA con conexión macho.

Code	Size	Color	Price	Class	Packaging
530009	M24x1,5 x 1/2" M O-ring	■	52,44 €	RA	1 / 24
530009INOX	M24x1,5 x 1/2" M O-ring	■	65,62 €	RA	1 / 24
530009WHITE	M24x1,5 x 1/2" M O-ring	□	47,51 €	RA	1 / 24

■ DV 042



- Detentore a corpo reverso serie OPTIMA con attacco maschio.
- Reverse lockshield OPTIMA series with male connection.
- Coude de réglage à corps renversé série OPTIMA avec embout mâle.
- Reversrücklaufventil OPTIMA Serie mit AG Anschluss.
- Detentor invertido serie OPTIMA con conexión macho.

Code	Size	Color	Price	Class	Packaging
530045	M24x1,5 x 1/2" M O-ring	■	58,92 €	RA	1 / 24
530045INOX	M24x1,5 x 1/2" M O-ring	■	71,83 €	RA	1 / 24
530045WHITE	M24x1,5 x 1/2" M O-ring	□	49,81 €	RA	1 / 24



- Raccordo per tubo in rame serie OPTIMA >> p. 21
- Fitting for copper pipe OPTIMA series >> p. 21
- Raccord pour tube en cuivre série OPTIMA >> p. 21
- Verschraubung für Kupferrohr OPTIMA-Serie >> p. 21
- Conexión para tubo de cobre serie OPTIMA >> p. 21



- Raccordo per tubo multistrato serie OPTIMA >> p. 21
- Fitting for multilayer pipe OPTIMA series >> p. 21
- Raccord pour tube multicouche série OPTIMA >> p. 21
- Verschraubung für Verbundrohr OPTIMA-Serie >> p. 21
- Conexión para tubo multicapa serie OPTIMA >> p. 21



- Raccordo per tubo in polietilene serie OPTIMA >> p. 21
- Fitting for polyethylene pipe OPTIMA series >> p. 21
- Raccord pour tube en polyéthylène série OPTIMA >> p. 21
- Verschraubung für PEX-Rohr OPTIMA-Serie >> p. 21
- Conexión para tubo de polietileno serie OPTIMA >> p. 21

DV 019

- Valvola termostattizzabile a squadra con prerregolazione serie OPTIMA con attacco femmina.
- Angle thermostatic valve with pre-regulation OPTIMA series with female connection.
- Robinet thermostatisable équerre avec préréglage série OPTIMA avec embout femelle.
- Eck-Thermostatventil mit Voreinstellung OPTIMA Serie mit IG Anschluss.
- Válvula termostatizable de escuadra con prerregulación serie OPTIMA con conexión hembra.

Code	Size	Color	Price	Class	Packaging
530038	1/2" F x 1/2" M O-ring	■	40,00 €	RA	1 / 24
530038INOX	1/2" F x 1/2" M O-ring	■	50,69 €	RA	1 / 24
530038WHITE	1/2" F x 1/2" M O-ring	□	37,30 €	RA	1 / 24

DV 011

- Valvola termostattizzabile diritta con prerregolazione serie OPTIMA con attacco femmina.
- Straight thermostatic valve with pre-regulation OPTIMA series with female connection.
- Robinet thermostatisable droit avec préréglage série OPTIMA avec embout femelle.
- Durchgangs-Thermostatventil mit Voreinstellung OPTIMA Serie mit IG Anschluss.
- Válvula termostatizable recta con prerregulación serie OPTIMA con conexión hembra.

Code	Size	Color	Price	Class	Packaging
530024	1/2" F x 1/2" M O-ring	■	40,67 €	RA	1 / 24
530024INOX	1/2" F x 1/2" M O-ring	■	51,09 €	RA	1 / 24
530024WHITE	1/2" F x 1/2" M O-ring	□	37,71 €	RA	1 / 24

DV 031

- Valvola termostattizzabile a corpo reverso con prerregolazione serie OPTIMA con attacco femmina.
- Reverse thermostatic valve with pre-regulation OPTIMA series with female connection.
- Robinet thermostatisable à corps renversé avec préréglage série OPTIMA avec embout femelle.
- Reversthermostatventil mit Voreinstellung OPTIMA Serie mit IG Anschluss.
- Válvula termostatizable invertida con prerregulación serie OPTIMA con conexión hembra.

Code	Size	Color	Price	Class	Packaging
530042	1/2" F x 1/2" M O-ring	■	47,17 €	RA	1 / 24
530042INOX	1/2" F x 1/2" M O-ring	■	57,31 €	RA	1 / 24
530042WHITE	1/2" F x 1/2" M O-ring	□	40,00 €	RA	1 / 24



- È possibile ordinare questi articoli con testa manuale utilizzando il medesimo codice, ma aggiungendo la "M" dopo l'ultima cifra.
- It is possible to order these items with manual head, please use the same reference code and add "M" after the last figure.
- Il est possible de commander ces articles avec la tête manuelle en utilisant le même code, mais en ajoutant le "M" après le dernier chiffre.
- Ausführung mit manueller Hebel verfügbar. Dieselbe o.g. Bestellnummer aber bitte „M“ nach der letzten Ziffer hinzufügen.
- Puede pedir estos artículos con cabeza manual, con el mismo código y añadiendo la "M" después del último dígito.

DV 029

- Detentore a squadra serie OPTIMA con attacco femmina.
- Angle lockshield OPTIMA series with female connection.
- Coude de réglage équerre série OPTIMA avec embout femelle.
- Eck-Rücklaufventil OPTIMA Serie mit IG Anschluss.
- Detentor de escuadra serie OPTIMA con conexión hembra.

Code	Size	Color	Price	Class	Packaging
530039	1/2" F x 1/2" M O-ring	■	48,39 €	RA	1 / 24
530039INOX	1/2" F x 1/2" M O-ring	■	61,83 €	RA	1 / 24
530039WHITE	1/2" F x 1/2" M O-ring	□	43,72 €	RA	1 / 24

DV 021



- Detentore diritto serie OPTIMA con attacco femmina.
- Straight lockshield OPTIMA series with female connection.
- Tè de réglage droit série OPTIMA avec embout femelle.
- Durchgangs-Rücklaufventil OPTIMA Serie mit IG Anschluss.
- Detentor recto serie OPTIMA con conexión hembra.

Code	Size	Color	Price	Class	Packaging
530025	1/2" F x 1/2" M O-ring	■	49,05 €	RA	1 / 24
530025INOX	1/2" F x 1/2" M O-ring	■	62,23 €	RA	1 / 24
530025WHITE	1/2" F x 1/2" M O-ring	□	44,13 €	RA	1 / 24

DV 041

- Detentore a corpo reverso serie OPTIMA con attacco femmina.
- Reverse lockshield OPTIMA series with female connection.
- Coude de réglage à corps renversé série OPTIMA avec embout femelle.
- Reversrücklaufventil OPTIMA Serie mit IG Anschluss.
- Detentor invertido serie OPTIMA con conexión hembra.

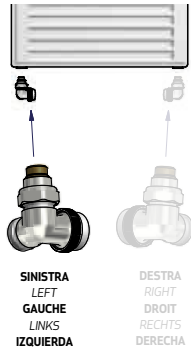
Code	Size	Color	Price	Class	Packaging
530043	1/2" F x 1/2" M O-ring	■	55,55 €	RA	1 / 24
530043INOX	1/2" F x 1/2" M O-ring	■	68,44 €	RA	1 / 24
530043WHITE	1/2" F x 1/2" M O-ring	□	46,43 €	RA	1 / 24



DV 018



- Valvola termostattabile coassiale sinistra con prerregolazione serie OPTIMA con attacco maschio.
- Co-axial left thermostatic valve with pre-regulation OPTIMA series with male connection.
- Robinet thermostatisable coaxial gauche avec préréglage série OPTIMA avec embout mâle.
- Koaxiales Thermostatventil links mit Voreinstellung OPTIMA Serie mit AG Anschluß.
- Válvula termostattabile coaxial izquierda con prerregulación serie OPTIMA con conexión macho.

Code	Size	Color	Price	Class	Packaging
530012	M24x1,5 x 1/2" M O-ring	■	48,53 €	RA	1 / 24
530012INOX	M24x1,5 x 1/2" M O-ring	■	59,87 €	RA	1 / 24
530012WHITE	M24x1,5 x 1/2" M O-ring	□	44,86 €	RA	1 / 24

DV 017



- Valvola termostattabile coassiale sinistra con prerregolazione serie OPTIMA con attacco femmina.
- Co-axial left thermostatic valve with pre-regulation OPTIMA series with female connection.
- Robinet thermostatisable coaxial gauche avec préréglage série OPTIMA avec embout femelle.
- Koaxiales Thermostatventil links mit Voreinstellung OPTIMA Serie mit IG Anschluß.
- Válvula termostattabile coaxial izquierda con prerregulación serie OPTIMA con conexión hembra.

Code	Size	Color	Price	Class	Packaging
530028	1/2" F x 1/2" M O-ring	■	45,13 €	RA	1 / 24
530028INOX	1/2" F x 1/2" M O-ring	■	56,49 €	RA	1 / 24
530028WHITE	1/2" F x 1/2" M O-ring	□	41,49 €	RA	1 / 24



- È possibile ordinare questi articoli con testa manuale utilizzando il medesimo codice, ma aggiungendo la "M" dopo l'ultima cifra.
- It is possible to order these items with manual head; please use the same reference code and add "M" after the last figure.
- Il est possible de commander ces articles avec la tête manuelle en utilisant le même code, mais en ajoutant le "M" après le dernier chiffre.
- Ausführung mit manueller Hebel verfügbar. Dieselbe o.g. Bestellnummer aber bitte „M“ nach der letzten Ziffer hinzufügen.
- Puede pedir estos artículos con cabeza manual, con el mismo código y añadiendo la "M" después del último dígito.



- Raccordo per tubo in rame serie OPTIMA >> p. 21
- Fitting for copper pipe OPTIMA series >> p. 21
- Raccord pour tube en cuivre série OPTIMA >> p. 21
- Verschraubung für Kupferrohr OPTIMA-Serie >> p. 21
- Conexión para tubo de cobre serie OPTIMA >> p. 21



- Raccordo per tubo multistrato serie OPTIMA >> p. 21
- Fitting for multilayer pipe OPTIMA series >> p. 21
- Raccord pour tube multicouche série OPTIMA >> p. 21
- Verschraubung für Verbundrohr OPTIMA-Serie >> p. 21
- Conexión para tubo multicapa serie OPTIMA >> p. 21



- Raccordo per tubo in polietilene serie OPTIMA >> p. 21
- Fitting for polyethylene pipe OPTIMA series >> p. 21
- Raccord pour tube en polyéthylène série OPTIMA >> p. 21
- Verschraubung für PEX-Rohr OPTIMA-Serie >> p. 21
- Conexión para tubo de polietileno serie OPTIMA >> p. 21

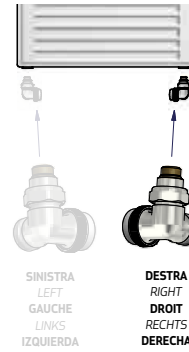

DV 026



- Detentore coassiale destro serie OPTIMA con attacco maschio.
- Co-axial right lockshield OPTIMA series with male connection.
- Raccord de réglage coaxial droit série OPTIMA avec embout mâle.
- Koaxiales Rücklaufventil rechts OPTIMA Serie mit AG Anschluß.
- Detentor coaxial derecho serie OPTIMA con conexión macho.

Code	Size	Color	Price	Class	Packaging
530011	M24x1,5 x 1/2" M O-ring	■	56,90 €	RA	1 / 24
530011INOX	M24x1,5 x 1/2" M O-ring	■	71,01 €	RA	1 / 24
530011WHITE	M24x1,5 x 1/2" M O-ring	□	51,29 €	RA	1 / 24

DV 025



- Detentore coassiale destro serie OPTIMA con attacco femmina.
- Co-axial right lockshield OPTIMA series with female connection.
- Raccord de réglage coaxial droit série OPTIMA avec embout femelle.
- Koaxiales Rücklaufventil rechts OPTIMA Serie mit IG Anschluß.
- Detentor coaxial derecho serie OPTIMA con conexión hembra.

Code	Size	Color	Price	Class	Packaging
530027	1/2" F x 1/2" M O-ring	■	53,52 €	RA	1 / 24
530027INOX	1/2" F x 1/2" M O-ring	■	67,64 €	RA	1 / 24
530027WHITE	1/2" F x 1/2" M O-ring	□	47,91 €	RA	1 / 24

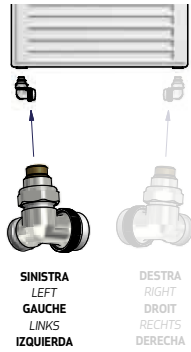

SINISTRA
LEFT
GAUCHE
LINKS
IZQUIERDA

DESTRA
RIGHT
DROIT
RECHTS
DERECHA

DV 028



- Detentore coassiale sinistro serie OPTIMA con attacco maschio.
- Co-axial left lockshield OPTIMA series with male connection.
- Raccord de réglage coaxial gauche série OPTIMA avec embout mâle.
- Koaxiales Rücklaufventil links OPTIMA Serie mit AG Anschluß.
- Detentor coaxial izquierdo serie OPTIMA con conexión macho.

Code	Size	Color	Price	Class	Packaging
530013	M24x1,5 x 1/2" M O-ring	■	56,90 €	RA	1 / 24
530013INOX	M24x1,5 x 1/2" M O-ring	■	71,01 €	RA	1 / 24
530013WHITE	M24x1,5 x 1/2" M O-ring	□	51,29 €	RA	1 / 24

DV 027

- Detentore coassiale sinistro serie OPTIMA con attacco femmina.
- Co-axial left lockshield OPTIMA series with female connection.
- Raccord de réglage coaxial gauche série OPTIMA avec embout femelle.
- Koaxiales Rücklaufventil links OPTIMA Serie mit IG Anschluß.
- Detentor coaxial izquierdo serie OPTIMA con conexión hembra.

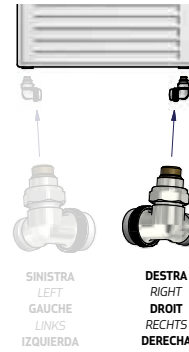
Code	Size	Color	Price	Class	Packaging
530029	1/2" F x 1/2" M O-ring	■	53,52 €	RA	1 / 24
530029INOX	1/2" F x 1/2" M O-ring	■	67,64 €	RA	1 / 24
530029WHITE	1/2" F x 1/2" M O-ring	□	47,91 €	RA	1 / 24



SINISTRA
LEFT
GAUCHE
LINKS
IZQUIERDA

DESTRA
RIGHT
DROIT
RECHTS
DERECHA

DV 016

- Valvola termostattabile coassiale destra con prerregolazione serie OPTIMA con attacco maschio.
- Co-axial right thermostatic valve with pre-regulation OPTIMA series with male connection.
- Robinet thermostatisable coaxial droit avec pré-réglage série OPTIMA avec embout mâle.
- Koaxiales Thermostatventil rechts mit Voreinstellung OPTIMA Serie mit AG Anschluß.
- Válvula termostatzable coaxial derecha con prerregulación serie OPTIMA con conexión macho.

Code	Size	Color	Price	Class	Packaging
530010	M24x1,5 x 1/2" M O-ring	■	48,53 €	RA	1 / 24
530010INOX	M24x1,5 x 1/2" M O-ring	■	59,87 €	RA	1 / 24
530010WHITE	M24x1,5 x 1/2" M O-ring	□	44,86 €	RA	1 / 24

DV 015

- Valvola termostattabile coassiale destra con prerregolazione serie OPTIMA con attacco femmina.
- Co-axial right thermostatic valve with pre-regulation OPTIMA series with female connection.
- Robinet thermostatisable coaxial droit avec pré-réglage série OPTIMA avec embout femelle.
- Koaxiales Thermostatventil rechts mit Voreinstellung OPTIMA Serie mit IG Anschluß.
- Válvula termostatzable coaxial derecha con prerregulación serie OPTIMA con conexión hembra.

Code	Size	Color	Price	Class	Packaging
530026	1/2" F x 1/2" M O-ring	■	45,13 €	RA	1 / 24
530026INOX	1/2" F x 1/2" M O-ring	■	56,49 €	RA	1 / 24
530026WHITE	1/2" F x 1/2" M O-ring	□	41,49 €	RA	1 / 24



- È possibile ordinare questi articoli con testa manuale utilizzando il medesimo codice, ma aggiungendo la "M" dopo l'ultima cifra.
- It is possible to order these items with manual head; please use the same reference code and add "M" after the last figure.
- Il est possible de commander ces articles avec la tête manuelle en utilisant le même code, mais en ajoutant le "M" après le dernier chiffre.
- Ausführung mit manueller Hebel verfügbar. Dieselbe o.g. Bestellnummer aber bitte „M“ nach der letzten Ziffer hinzufügen.
- Puede pedir estos artículos con cabeza manual, con el mismo código y añadiendo la "M" después del último dígito.



- Raccordo per tubo in rame serie OPTIMA >> p. 21
- Fitting for copper pipe OPTIMA series >> p. 21
- Raccord pour tube en cuivre série OPTIMA >> p. 21
- Verschraubung für Kupferrohr OPTIMA-Serie >> p. 21
- Conexión para tubo de cobre serie OPTIMA >> p. 21



- Raccordo per tubo multistrato serie OPTIMA >> p. 21
- Fitting for multilayer pipe OPTIMA series >> p. 21
- Raccord pour tube multicouche série OPTIMA >> p. 21
- Verschraubung für Verbundrohr OPTIMA-Serie >> p. 21
- Conexión para tubo multicapa serie OPTIMA >> p. 21



- Raccordo per tubo in polietilene serie OPTIMA >> p. 21
- Fitting for polyethylene pipe OPTIMA series >> p. 21
- Raccord pour tube en polyéthylène série OPTIMA >> p. 21
- Verschraubung für PEX-Rohr OPTIMA-Serie >> p. 21
- Conexión para tubo de polietileno serie OPTIMA >> p. 21

■ DV 104



- Valvola H termostattabile bitubo per alimentazione a parete con prerregolazione serie OPTIMA con attacco maschio.
- Double pipe H thermostatic valve for wall delivery with pre-regulation OPTIMA series with male connection.
- Pièce H thermostatisable bitube pour alimentation murale avec pré-réglage série OPTIMA avec embout mâle.
- Zweirohr-H-Thermostatventil Eckform mit Voreinstellung OPTIMA Serie mit AG Anschluß.
- Válvula H termostattabile bitubo para alimentación en pared con prerregulación serie OPTIMA con conexión macho.

Code	Size	Color	Price	Class	Packaging
530007	M24x1,5 x 1/2" M O-ring	■	97,85 €	RA	1 / 14
530007INOX	M24x1,5 x 1/2" M O-ring	■	119,87 €	RA	1 / 14
530007WHITE	M24x1,5 x 1/2" M O-ring	□	90,82 €	RA	1 / 14

■ DV 103



- Valvola H termostattabile bitubo per alimentazione a pavimento con prerregolazione serie OPTIMA con attacco maschio.
- Double pipe H thermostatic valve for floor delivery with pre-regulation OPTIMA series with male connection.
- Pièce H thermostatisable bitube pour alimentation au sol avec pré-réglage série OPTIMA avec embout mâle.
- Zweirohr-H-Thermostatventil Durchgangsform mit Voreinstellung OPTIMA Serie mit AG Anschluß.
- Válvula H termostattabile bitubo para alimentación en suelo con prerregulación serie OPTIMA con conexión macho.

Code	Size	Color	Price	Class	Packaging
530005	M24x1,5 x 1/2" M O-ring	■	96,37 €	RA	1 / 14
530005INOX	M24x1,5 x 1/2" M O-ring	■	116,36 €	RA	1 / 14
530005WHITE	M24x1,5 x 1/2" M O-ring	□	91,63 €	RA	1 / 14

■ DV 104 B



- Valvola H termostattabile mono/bitubo (con bypass regolabile 50-100%) per alimentazione a parete con prerregolazione serie OPTIMA con attacco maschio.
- Single/double pipe H thermostatic valve (with adjustable bypass 50-100%) for wall delivery with pre-regulation OPTIMA series with male connection.
- Pièce H thermostatisable mono/bitube (avec bypass réglable 50-100%) pour alimentation murale avec pré-réglage série OPTIMA avec embout mâle.
- Ein-/Zweirohr-H-Thermostatventil (mit regelbarer Bypass 50-100%) Eckform mit Voreinstellung OPTIMA Serie mit AG Anschluß.
- Válvula H termostattabile mono/bitubo (con bypass ajustable 50-100%) para alimentación en pared con prerregulación serie OPTIMA con conexión macho.

Code	Size	Color	Price	Class	Packaging
530007B	M24x1,5 x 1/2" M O-ring	■	103,93 €	RA	1 / 14
530007INOXB	M24x1,5 x 1/2" M O-ring	■	125,96 €	RA	1 / 14
530007WHITEB	M24x1,5 x 1/2" M O-ring	□	96,90 €	RA	1 / 14

■ DV 103 B



- Valvola H termostattabile mono/bitubo (con bypass regolabile 50-100%) per alimentazione a pavimento con prerregolazione serie OPTIMA con attacco maschio.
- Single/double pipe H thermostatic valve (with adjustable bypass 50-100%) for floor delivery with pre-regulation OPTIMA series with male connection.
- Pièce H thermostatisable mono/bitube (avec bypass réglable 50-100%) pour alimentation au sol avec pré-réglage série OPTIMA avec embout mâle.
- Ein-/Zweirohr-H-Thermostatventil (mit regelbarer Bypass 50-100%) Durchgangsform mit Voreinstellung OPTIMA Serie mit AG Anschluß.
- Válvula H termostattabile mono/bitubo (con bypass ajustable 50-100%) para alimentación en suelo con prerregulación serie OPTIMA con conexión macho.

Code	Size	Color	Price	Class	Packaging
530005B	M24x1,5 x 1/2" M O-ring	■	102,45 €	RA	1 / 14
530005INOXB	M24x1,5 x 1/2" M O-ring	■	122,45 €	RA	1 / 14
530005WHITEB	M24x1,5 x 1/2" M O-ring	□	97,71 €	RA	1 / 14



- È possibile ordinare questi articoli con testa manuale utilizzando il medesimo codice, ma aggiungendo la "M" dopo l'ultima cifra.
- It is possible to order these items with manual head; please use the same reference code and add "M" after the last figure.
- Il est possible de commander ces articles avec la tête manuelle en utilisant le même code, mais en ajoutant le "M" après le dernier chiffre.
- Ausführung mit manueller Hebel verfügbar. Dieselbe o.g. Bestellnummer aber bitte „M“ nach der letzten Ziffer hinzufügen.
- Puede pedir estos artículos con cabeza manual, con el mismo código y añadiendo la "M" después del último dígito.



- Raccordo per tubo in rame serie OPTIMA >> p. 21
- Fitting for copper pipe OPTIMA series >> p. 21
- Raccord pour tube en cuivre série OPTIMA >> p. 21
- Verschraubung für Kupferrohr OPTIMA-Serie >> p. 21
- Conexión para tubo de cobre serie OPTIMA >> p. 21



- Raccordo per tubo multistrato serie OPTIMA >> p. 21
- Fitting for multilayer pipe OPTIMA series >> p. 21
- Raccord pour tube multicouche série OPTIMA >> p. 21
- Verschraubung für Verbundrohr OPTIMA-Serie >> p. 21
- Conexión para tubo multicapa serie OPTIMA >> p. 21



- Raccordo per tubo in polietilene serie OPTIMA >> p. 21
- Fitting for polyethylene pipe OPTIMA series >> p. 21
- Raccord pour tube en polyéthylène série OPTIMA >> p. 21
- Verschraubung für PEX-Rohr OPTIMA-Serie >> p. 21
- Conexión para tubo de polietileno serie OPTIMA >> p. 21

DV 102

- Valvola H termostattabile bitubo per alimentazione a parete con prerregolazione serie OPTIMA con attacco femmina.
- Double pipe H thermostatic valve for wall delivery with pre-regulation OPTIMA series with female connection.
- Pièce H thermostatizable bitube pour alimentation murale avec pré-réglage série OPTIMA avec embout femelle.
- Zweirohr-H-Thermostatventil Eckform mit Voreinstellung OPTIMA Serie mit IG Anschluß.
- Válvula H termostatizable bitubo para alimentación en pared con prerregulación serie OPTIMA con conexión hembra.

Code	Size	Color	Price	Class	Packaging
530006	1/2" F x 1/2" M O-ring	■	91,09 €	RA	1 / 14
530006INOX	1/2" F x 1/2" M O-ring	■	113,12 €	RA	1 / 14
530006WHITE	1/2" F x 1/2" M O-ring	□	84,06 €	RA	1 / 14

DV 101

- Valvola H termostattabile bitubo per alimentazione a pavimento con prerregolazione serie OPTIMA con attacco femmina.
- Double pipe H thermostatic valve for floor delivery with pre-regulation OPTIMA series with female connection.
- Pièce H thermostatizable bitube pour alimentation au sol avec pré-réglage série OPTIMA avec embout femelle.
- Zweirohr-H-Thermostatventil Durchgangsform mit Voreinstellung OPTIMA Serie mit IG Anschluß.
- Válvula H termostatizable bitubo para alimentación en suelo con prerregulación serie OPTIMA con conexión hembra.

Code	Size	Color	Price	Class	Packaging
530004	1/2" F x 1/2" M O-ring	■	89,61 €	RA	1 / 14
530004INOX	1/2" F x 1/2" M O-ring	■	109,61 €	RA	1 / 14
530004WHITE	1/2" F x 1/2" M O-ring	□	84,89 €	RA	1 / 14

DV 102 B

- Valvola H termostattabile mono/bitubo (con bypass regolabile 50-100%) per alimentazione a parete con prerregolazione serie OPTIMA con attacco femmina.
- Single/double pipe H thermostatic valve (with adjustable bypass 50-100%) for wall delivery with pre-regulation OPTIMA series with female connection.
- Pièce H thermostatizable mono/bitube (avec bypass réglable 50-100%) pour alimentation murale avec pré-réglage série OPTIMA avec embout femelle.
- Ein-/Zweirohr-H-Thermostatventil (mit regelbarer Bypass 50-100%) Eckform mit Voreinstellung OPTIMA Serie mit IG Anschluß.
- Válvula H termostatizable mono/bitubo (con bypass ajustable 50-100%) para alimentación en pared con prerregulación serie OPTIMA con conexión hembra.

Code	Size	Color	Price	Class	Packaging
530006B	1/2" F x 1/2" M O-ring	■	97,18 €	RA	1 / 14
530006INOXB	1/2" F x 1/2" M O-ring	■	119,20 €	RA	1 / 14
530006WHITEB	1/2" F x 1/2" M O-ring	□	90,14 €	RA	1 / 14

DV 101 B

- Valvola H termostattabile mono/bitubo (con bypass regolabile 50-100%) per alimentazione a pavimento con prerregolazione serie OPTIMA con attacco femmina.
- Single/double pipe H thermostatic valve (with adjustable bypass 50-100%) for floor delivery with pre-regulation OPTIMA series with female connection.
- Pièce H thermostatizable mono/bitube (avec bypass réglable 50-100%) pour alimentation au sol avec pré-réglage série OPTIMA avec embout femelle.
- Ein-/Zweirohr-H-Thermostatventil (mit regelbarer Bypass 50-100%) Durchgangsform mit Voreinstellung OPTIMA Serie mit IG Anschluß.
- Válvula H termostatizable mono/bitubo (con bypass ajustable 50-100%) para alimentación en suelo con prerregulación serie OPTIMA con conexión hembra.

Code	Size	Color	Price	Class	Packaging
530004B	1/2" F x 1/2" M O-ring	■	95,69 €	RA	1 / 14
530004INOXB	1/2" F x 1/2" M O-ring	■	115,69 €	RA	1 / 14
530004WHITEB	1/2" F x 1/2" M O-ring	□	90,95 €	RA	1 / 14



- È possibile ordinare questi articoli con testa manuale utilizzando il medesimo codice, ma aggiungendo la "M" dopo l'ultima cifra.
- It is possible to order these items with manual head; please use the same reference code and add "M" after the last figure.
- Il est possible de commander ces articles avec la tête manuelle en utilisant le même code, mais en ajoutant le "M" après le dernier chiffre.
- Ausführung mit manueller Hebel verfügbar. Dieselbe o.g. Bestellnummer aber bitte „M“ nach der letzten Ziffer hinzufügen.
- Puede pedir estos artículos con cabeza manual, con el mismo código y añadiendo la "M" después del último dígito.

AD 02



- **Mostrina singola in ABS serie OPTIMA (in 2 pezzi).**
- *ABS single plate OPTIMA series (in 2 pieces).*
- **Rosace single en ABS série OPTIMA (en 2 pièces).**
- *Einzelne Abdeckmanschette aus ABS OPTIMA-Serie (in 2 Stücke).*
- **Embellecedor simple de ABS serie OPTIMA (en 2 piezas).**

Code	Size	Color	Price	Class	Packaging
530031	Ø15	■	3,821 €	RA	40 / 160
530031INOX	Ø15	■	11,90 €	RA	40 / 160
530031WHITE	Ø15	□	4,853 €	RA	40 / 160

AD 01



- **Mostrina doppia in ABS serie OPTIMA (in 2 pezzi).**
- *ABS double plate OPTIMA series (in 2 pieces).*
- **Rosace double en ABS série OPTIMA (en 2 pièces).**
- *Doppelte Abdeckmanschette aus ABS OPTIMA-Serie (in 2 Stücke).*
- **Plafón embellecedor doble de ABS serie OPTIMA (en 2 piezas).**

Code	Size	Color	Price	Class	Packaging
530030	Ø15	■	4,853 €	RA	20 / 80
530030INOX	Ø15	■	17,47 €	RA	20 / 80
530030WHITE	Ø15	□	6,86 €	RA	20 / 80

AD 06



- **Kit copritubo serie OPTIMA completo con mostrine singole in ottone.**
- *Complete pipe covering kit OPTIMA series with brass single plates.*
- **Kit couvre-tube série OPTIMA complet avec rosaces singles en laiton.**
- *Völlständiges Rohrdeckungsset OPTIMA-Serie mit einzel Abdeckmanschetten aus Messing.*
- **Conjunto cubre-tubo serie OPTIMA completo de embellecedores simples en latón.**

Code	Size	Color	Price	Class	Packaging
530061	Ø18 x 70 mm	■	40,00 €	RA	1
530061WHITE	Ø18 x 70 mm	□	43,92 €	RA	1
530062	Ø18 x 160 mm	■	43,25 €	RA	1
530062WHITE	Ø18 x 160 mm	□	57,31 €	RA	1

AD 05



- **Kit copritubo serie OPTIMA completo con mostrina doppia in ottone.**
- *Complete pipe covering kit OPTIMA series with brass double plate.*
- **Kit couvre-tube série OPTIMA complet avec rosace double en laiton.**
- *Völlständiges Rohrdeckungsset OPTIMA-Serie mit doppelter Abdeckmanschette aus Messing.*
- **Conjunto cubre-tubo serie OPTIMA completo de embellecedor doble (en latón).**

Code	Size	Color	Price	Class	Packaging
530059	Ø18 x 70 mm	■	64,09 €	RA	1
530059WHITE	Ø18 x 70 mm	□	70,58 €	RA	1
530060	Ø18 x 160 mm	■	72,08 €	RA	1
530060WHITE	Ø18 x 160 mm	□	79,42 €	RA	1

AD 04



- **Mostrina singola in ottone serie OPTIMA.**
- *Brass single plate OPTIMA series.*
- **Rosace single en laiton série OPTIMA.**
- *Einzelne Abdeckmanschette aus Messing OPTIMA-Serie.*
- **Embellecedor simple en latón serie OPTIMA.**

Code	Size	Color	Price	Class	Packaging
530055	Ø10	■	5,61 €	RA	1
530055WHITE	Ø10	□	7,03 €	RA	1
530056	Ø12	■	5,61 €	RA	1
530056WHITE	Ø12	□	7,03 €	RA	1
530057	Ø14	■	5,61 €	RA	1
530057WHITE	Ø14	□	7,03 €	RA	1
530058	Ø16	■	5,61 €	RA	1
530058WHITE	Ø16	□	7,03 €	RA	1

RR 702 OPTIMA



- **Tubo di raccordo in rame serie OPTIMA.**
- *Copper connection pipe OPTIMA series*
- **Tube de raccord en cuivre série OPTIMA.**
- *Verbindungsrohr aus Kupfer OPTIMA-Serie.*
- **Tubo de conexión de cobre serie OPTIMA.**

Code	Size	Color	Price	Class	Packaging
530032	Ø15 x 1/2" x 140 mm	■	10,34 €	RA	35 / 140
530032INOX	Ø15 x 1/2" x 140 mm	■	15,54 €	RA	35 / 140
530032WHITE	Ø15 x 1/2" x 140 mm	□	12,37 €	RA	35 / 140

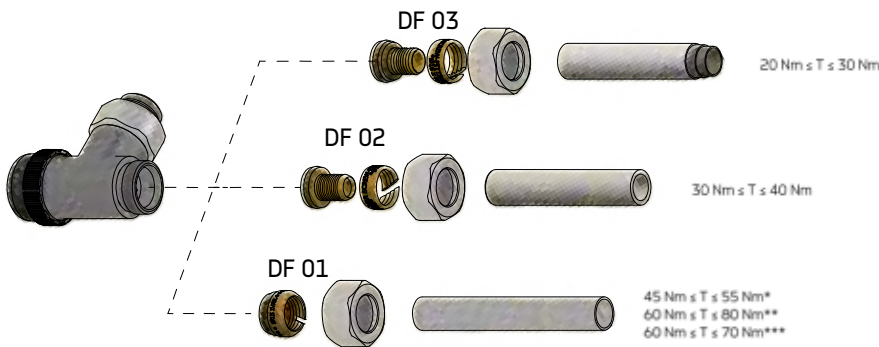
Suitable fittings for valves and lockshields OPTIMA series with M24x1,5 connection

- T = Coppia max. di serraggio. [*Rame ricotto.]**Rame semiduro. [***Acciaio dolce.
- T = Max. tightening torque. [*Soft copper.]**Semi-hard copper. [***Mild steel.
- T = Couple de serrage max. [*Cuivre recuit.]**Cuivre semi-rigide. [***Acier doux.
- T = Max. Anzugsdrehmoment. [*Geglühtes Kupfer.]**Mittelfestes Kupfer. [***Weichstahl.
- T = Par de apriete max. [*Cobre recocido.]**Cobre semiduro. [***Acero dulce.

DF 03

- Raccordo a stringere M24x1,5 per tubo multistrato serie OPTIMA.
- Screw fitting M24x1,5 for multilayer pipe OPTIMA series.
- Raccord à serrer M24x1,5 pour tube multicouche série OPTIMA.
- Verschraubung M24x1,5 für Verbundrohr OPTIMA-Serie.
- Conexión M24x1,5 para tubo multicapa serie OPTIMA.

Code	Size	Color	Price	Class	Packaging
530046	M24x1,5 x 14/2	■	4,474 €	RA	40 / 160
530046INOX	M24x1,5 x 14/2	■	6,78 €	RA	40 / 160
530016	M24x1,5 x 16/2	■	4,474 €	RA	40 / 160
530016INOX	M24x1,5 x 16/2	■	6,78 €	RA	40 / 160
530063	M24x1,5 x 16/2,25	■	4,474 €	RA	40 / 160
530063INOX	M24x1,5 x 16/2,25	■	6,78 €	RA	40 / 160

DF 02

- Raccordo a stringere M24x1,5 per tubo in polietilene serie OPTIMA.
- Screw fitting M24x1,5 for polyethylene pipe OPTIMA series.
- Raccord à serrer M24x1,5 pour tube en polyéthylène série OPTIMA.
- Verschraubung M24x1,5 für PEX-Rohr OPTIMA-Serie.
- Conexión M24x1,5 para tubo de polietileno serie OPTIMA.

Code	Size	Color	Price	Class	Packaging
530052	M24x1,5 x 14/2	■	4,20 €	RA	40 / 160
530052INOX	M24x1,5 x 14/2	■	6,14 €	RA	40 / 160
530066	M24x1,5 x 16/1,5	■	4,295 €	RA	40 / 160
530066INOX	M24x1,5 x 16/1,5	■	6,02 €	RA	40 / 160
530015	M24x1,5 x 16/2	■	4,45 €	RA	40 / 160
530015INOX	M24x1,5 x 16/2	■	6,19 €	RA	40 / 160

DF 01

- Raccordo a stringere M24x1,5 per tubo in rame ed acciaio dolce serie OPTIMA.
- Screw fitting M24x1,5 for copper and mild steel pipe OPTIMA series.
- Raccord à serrer M24x1,5 pour tube en cuivre et en acier doux série OPTIMA.
- Verschraubung M24x1,5 für Kupferrohr und Weichstahlrohr OPTIMA-Serie.
- Conexión M24x1,5 para tubo de cobre y acero dulce serie OPTIMA.

Code	Size	Color	Price	Class	Packaging
530053	M24x1,5 x 10/1	■	3,904 €	RA	40 / 160
530053INOX	M24x1,5 x 10/1	■	5,70 €	RA	40 / 160
530047	M24x1,5 x 12/1	■	4,77 €	RA	40 / 160
530047INOX	M24x1,5 x 12/1	■	6,62 €	RA	40 / 160
530048	M24x1,5 x 14/1	■	3,607 €	RA	40 / 160
530048INOX	M24x1,5 x 14/1	■	5,35 €	RA	40 / 160
530014	M24x1,5 x 15/1	■	3,963 €	RA	40 / 160
530014INOX	M24x1,5 x 15/1	■	5,76 €	RA	40 / 160
530049	M24x1,5 x 16/1	■	3,762 €	RA	40 / 160
530049INOX	M24x1,5 x 16/1	■	5,58 €	RA	40 / 160

THERMOSTATIC HEADS

The thermostat heads are mechanical devices for automatic control of the water flow to heating units, thanks to a heat-sensitive element that reacts to the variations in the room temperature.

A wide range of IVAR thermostatic valve models bear the mark Keymark EN 215, which guarantees conformity of the low thermal inertia system (response time < 40 min). The same systems are accompanied by the TELL energy label. Eurovent Certita certification is also available for numerous thermostatic valves with the T 5000 head.

The heads in the 5000 series are fitted with a liquid element and offer the possibility of limiting and blocking settings. They can also be selected with remote sensors to avoid the problem of obstacles in front of the radiator, and ensure optimal detection of the room temperature.

T 1500 head has a compact size and a simple line; it is particularly suitable to regulate water flow to the radiator when detection of ambient temperature does not need to be remote controlled.

Materials

Knob and body: ABS

Thermostat: liquid expansion

Technical specifications

Max. fluid temperature inside valve: 100 °C

Parameters according to EN 215 (T 5000 only)

Hysteresis: 0.5 K

Influence of pressure differential D: 0.25 K

Effect of water temperature W: 0.75 K

Response time Z: 30 min (T 5000); 28 min (T 5005); < 40 min (others)

Control accuracy CA (T 5005 only): 0.2 K

⊕ PLUS

- **No temperature imbalances in rooms**
 - **Better regulation accuracy**
 - **Lowered return temperature, with a significant increase of condensing boiler efficiency**
 - **Available with anti-tamper ring nut and temperature limitation/lock functions**
- ⊕ FOCUS 1
- **Liquid expansion sensor** ⊕ FOCUS 2





FOCUS 1: Temperature limitation and lock

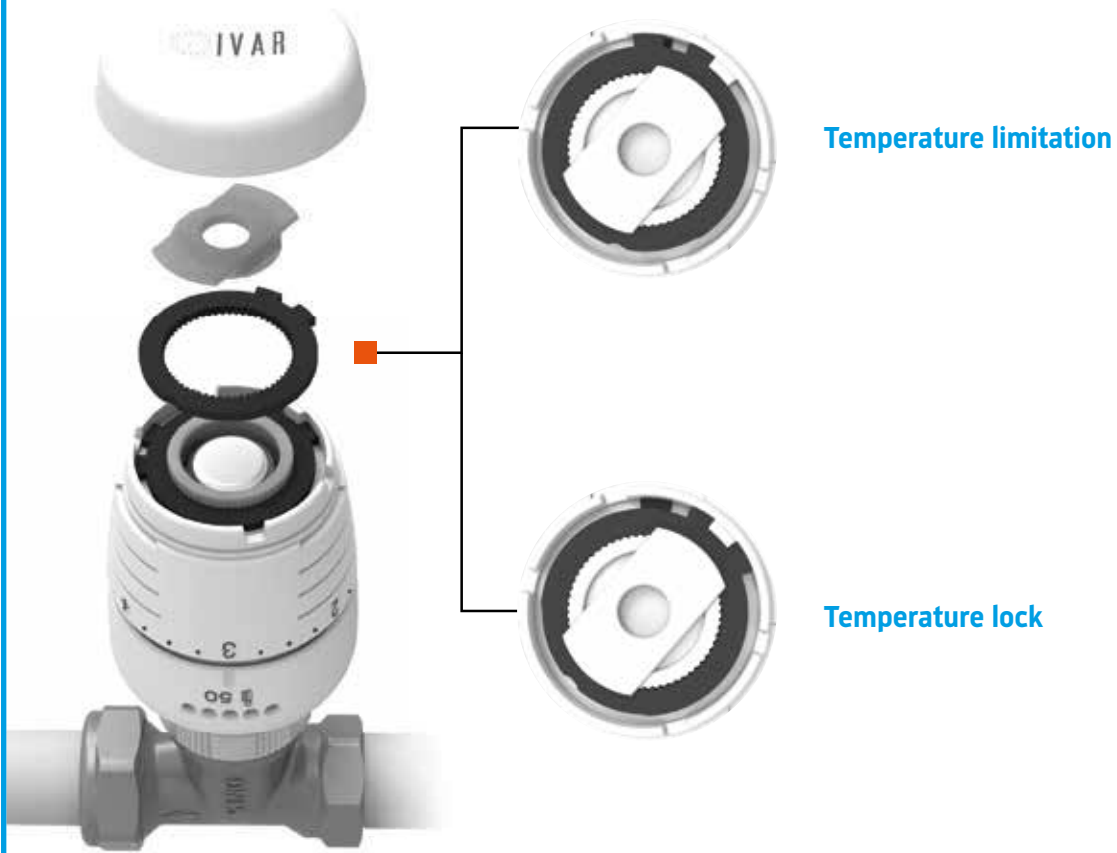

FOCUS 2: Liquid expansion sensor

T 5000



Range
6,5-28 °C

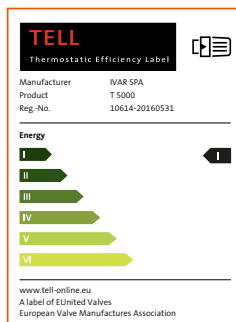
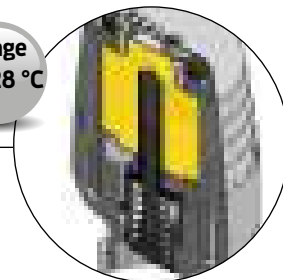

LIQUID SENSOR

Sensitive element that reacts to the variations in room temperature (expanding or retracting) to activate movement of the shutter rod. The thrust on closure is applied thanks to expansion of the sensor element, while the thrust on closure is applied by a counter-spring.

Available with remote capillary sensor

T 5000



- Testa termostatica con comando e sensore a espansione di liquido incorporati. Isteresi 0,5 K.
- Thermostatic head with incorporated command and liquid expansion sensor. Hysteresis 0.5 K.
- Tête thermostatique avec commande et senseur à expansion de liquide incorporés. Hystérésis 0,5 K.
- Thermostat-Kopf mit eingebauten Steuerung und Flüssigkeitsausdehnung Fühler. Hysterese 0,5 K.
- Cabeza termostática con mando y sensor de expansión de líquido incorporados. Histéresis 0,5 K.



Code	Size	D	W	Z	Color	Price	Class	Packaging
501172	M30 x 1,5	0.25 K	0.75 K	30 min	□	18,10 €	AA	10 / 80

T 5010



- Testa termostatica con comando incorporato e sensore remoto a parete.
- Thermostatic head with incorporated command and remote wall sensor.
- Tête thermostatique avec commande incorporée et senseur à distance mural.
- Thermostat-Kopf mit eingebauter Steuerung und Wand-Fernfühler.
- Cabeza termostática con mando incorporado y sensor remoto de pared.

Code	Size	Z	Range	Length	Price	Class	Packaging
501173	M30 x 1,5	< 40 min	6,5-28 °C	2 m	48,48 €	AA	5 / 40
501174	M30 x 1,5	< 40 min	6,5-28 °C	5 m	55,13 €	AA	5 / 40

T 5020



- Testa termostatica con comando e sensore remoti.
- Thermostatic head with remote command and sensor.
- Tête thermostatique avec commande et senseur à distance.
- Thermostat-Kopf mit Fernsteuerung und Fernfühler.
- Cabeza termostática con mando y sensor remotos.

Code	Size	Z	Range	Length	Price	Class	Packaging
501177	M30 x 1,5	< 40 min	6,5-28 °C	2 m	67,45 €	AA	3 / 24
501178	M30 x 1,5	< 40 min	6,5-28 °C	5 m	75,68 €	AA	3 / 24

T 5030



- Testa termostatica con sensore remoto e comando ad incasso.
- Thermostatic head with remote sensor and concealed command.
- Tête thermostatique avec senseur à distance commande d'encaissement.
- Thermostat-Kopf mit Fernfühler und UP-Steuerung.
- Cabeza termostática con sensor remoto y mando empotrable.

Code	Size	Z	Range	Length	Price	Class	Packaging
501179	M30 x 1,5	< 40 min	6,5-28 °C	2 m	65,25 €	AA	2 / 16
501180	M30 x 1,5	< 40 min	6,5-28 °C	5 m	73,78 €	AA	2 / 16

- D = Influenza della pressione differenziale. W = Effetto della temperatura dell'acqua. Z = Tempo di risposta.
- D = Differential pressure influence. W = Water temperature effect. Z = Response time.
- D = Influence de la pression différentielle. W = Influence de la température de l'eau. Z = Temps de réponse.
- D = Einfluß des Differenzialdrucks. W = Wassertemperatureinfluss. Z = Schließzeit.
- D = Influencia de la presión diferencial. W = Efecto de la temperatura del agua. Z = Tiempo de respuesta.

T 5000 CHROME

- Testa termostatica con comando e sensore a espansione di liquido incorporati.
- Thermostatic head with incorporated command and liquid expansion sensor.
- Tête thermostatique avec commande et senseur à expansion de liquide incorporés.
- Thermostat-Kopf mit eingebauten Steuerung und Flüssigkeitsausdehnung Fühler.
- Cabeza termostática con mando y sensor de expansión de líquido incorporados.

Code	Size	Z	Range	Color	Price	Class	Packaging
501172C	M30 x 1,5	< 40 min	6,5-28 °C	■	42,57 €	AA	10 / 80

T 5005

- Testa termostatica con comando e sensore a espansione di liquido incorporati. Isteresi 0,4 K; precisione del controllo (CA) 0,2 K.
- Thermostatic head with incorporated command and liquid expansion sensor. Hysteresis 0.4 K; control accuracy (CA) 0.2 K.
- Tête thermostatique avec commande et senseur à expansion de liquide incorporés. Hystérésis 0,4 K; précision de contrôle (CA) 0,2 K.
- Thermostat-Kopf mit eingebauten Steuerung und Flüssigkeitsausdehnung Fühler. Hysterese 0,4 K; Regelgenauigkeit (CA) 0,2 K.
- Cabeza termostática con mando y sensor de expansión de líquido incorporados. Histéresis 0,5 K; precisión de control (CA) 0,2 K.

Code	Size	D	W	Z	Color	Price	Class	Packaging
591142	M30 x 1,5	0.30 K	0.45 K	28 min	□	29,05 €	AA	10 / 80

T 1500

- Testa termostatica con comando e sensore a espansione di liquido incorporati.
- Thermostatic head with incorporated command and liquid expansion sensor.
- Tête thermostatique avec commande et senseur à expansion de liquide incorporés.
- Thermostat-Kopf mit eingebauten Steuerung und Flüssigkeitsausdehnung Fühler.
- Cabeza termostática con mando y sensor de expansión de líquido incorporados.

Code	Size	Z	Range	Color	Price	Class	Packaging
502841	M30 x 1,5	< 40 min	6,5-28 °C	□	14,50 €	AA	16 / 128

AT 0001

- Fascetta antifurto per teste termostatiche serie T 3000 e serie T 5000.
- Anti-theft clamp for thermostatic heads T 5000 series and T 3000 series.
- Collier antivol pour têtes thermostatiques série T 5000 et série T 3000.
- Diebstahlsicherungs-Manschette für Thermostat-Köpfe Serie T 5000 serie und Serie T 3000.
- Abrazadera antirrobo para cabezas termostáticas serie T 3000 y serie T 5000.

Code	Price	Class	Packaging
500250	0,653 €	AE	75 / 600

AT 0001E

- Fascetta antifurto per T 1000, T 1500 e AS 1010.
- Anti-theft clamp for T 1000, T 1500 and AS 1010.
- Collier antivol pour T 1000, T 1500 et AS 1010.
- Diebstahlsicherungs-Manschette für T 1000, T 1500 und AS 1010.
- Abrazadera antirrobo para T 1000, T 1500 y AS 1010.

Code	Price	Class	Packaging
500506	1,519 €	AE	30 / 240

A thermostatic valve regulates the ambient temperature and modulates the flow rate in the radiator: when the room temperature is close to the required value, the flow rate in the radiator is reduced, down to very low values. Systems with thermostatic valves are therefore variable flow rate versions.

In a centralised system, how is it possible to distribute the correct flow rate to radiators even with partial loads? In these cases, dynamic balancing valves are often installed at the base of the distribution columns, known as differential pressure balancers. To install this valve, the following is required:

- the location of the distribution columns;
- guaranteed clearance for installation at the base of the distribution column;
- after installation, precise calibration.

IVAR HARMONIA valves, as well as ideal for use in new systems, are designed to simplify these situations, and are the easiest solution for installation on existing systems. Combined with a thermostat head, they offer 3 functions:

1. Temperature control, thanks to the thermostat head which modulates flow rate.
2. Pre-setting of the maximum flow rates in 6 positions, to facilitate system activation intervals.
3. Dynamic balancing of system, for effective management of partial loads.

IVAR HARMONIA valves can therefore be installed on any system, without the need for complex calibration procedures. Simply install them, and they will do the rest!

Materials

Body: nickel-plated brass CW617N

Seals and O-rings: peroxide EPDM

Technical specifications

Versions available: straight, angle, reverse body and coaxial

Connection diameters: DN 10 and DN 15 for steel or Eurokonus pipes.

Max. fluid temperature inside valve: 120 °C

Maximum operating pressure: 10 bar

Differential pressure range: 0.1 - 0.6 bar

HARMONIA SERIES VALVES



2 Pre-adjustment of flow rates



1 Temperature control

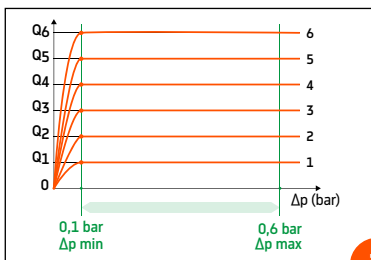

3 Dynamic balancing

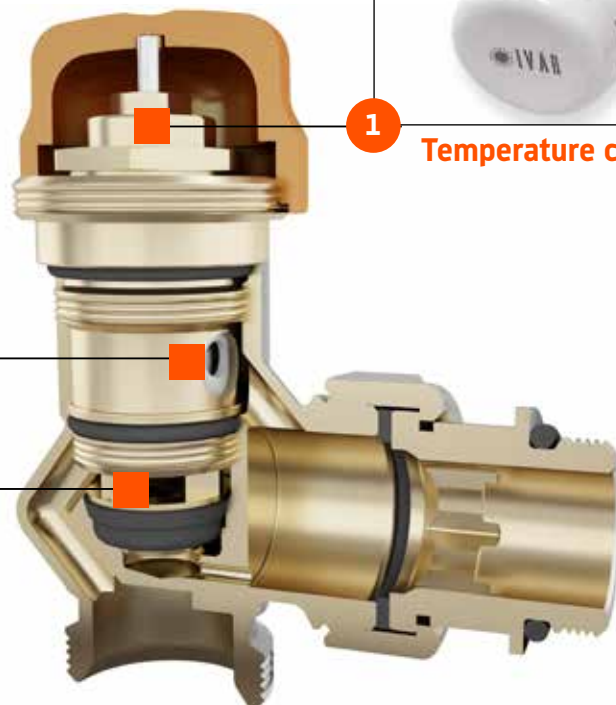

FOCUS: Static and dynamic balancing



FOCUS: Pre-regulation

HARMONIA series valves are fitted with a pre-adjustment selector which acts on the flow rate to simplify water balancing operations on the circuits.

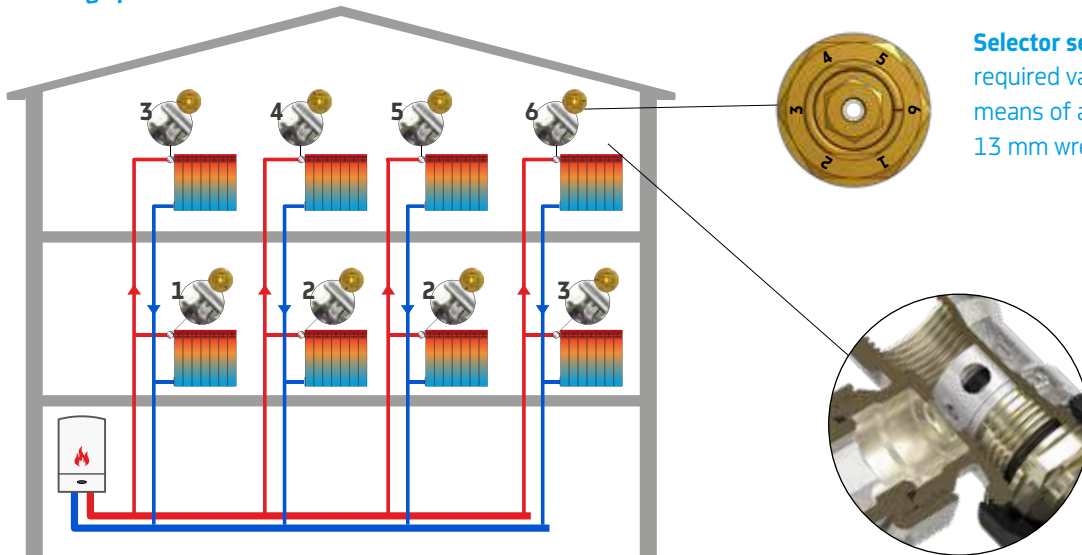

FOCUS: Ring nut substitution

The ring nut is screwed on a special insert and can be replaced even when the system is working.



■ VS 2106 NH



- Valvola termostattizzabile a squadra serie HARMONIA con selettore di portata, bilanciamento dinamico della pressione, attacco maschio e cappuccio di protezione.
- Angle thermostatic valve HARMONIA-series with flow rate selector, pressure dynamic balancing, male connection and protection cap.
- Robinet thermostatisable équerre série HARMONIA avec sélecteur de débit, équilibrage dynamique de la pression, embout mâle capuchon de protection.
- Eck-Thermostatventil Serie HARMONIA mit Durchfluss-Wählschalter, dynamische Abgleichventile des Drucks, AG Anschluß und Schutzkappe.
- Válvula termostatzabile de escuadra serie HARMONIA con selector de flujo, equilibrio dinámico de la presión, conexión macho y capuchón de protección.

Code	Size	Price	Class	Packaging
501185R	EUROK x 3/8" M	63,53 €	BF	10 / 40
501185	EUROK x 1/2" M	63,53 €	BF	10 / 40
501185RCR	EUROK x 3/8" M O-ring	64,21 €	BF	10 / 40
501185RC	EUROK x 1/2" M O-ring	64,21 €	BF	10 / 40

■ VD 2105 NH



- Valvola termostattizzabile diritta serie HARMONIA con selettore di portata, bilanciamento dinamico della pressione, attacco maschio e cappuccio di protezione.
- Straight thermostatic valve HARMONIA-series with flow rate selector, pressure dynamic balancing, male connection and protection cap.
- Robinet thermostatisable droit série HARMONIA avec sélecteur de débit, équilibrage dynamique de la pression, embout mâle capuchon de protection.
- Durchgangs-Thermostatventil Serie HARMONIA mit Durchfluss-Wählschalter, dynamische Abgleichventile des Drucks, AG Anschluß und Schutzkappe.
- Válvula termostatzabile recta serie HARMONIA con selector de flujo, equilibrio dinámico de la presión, conexión macho y capuchón de protección.

Code	Size	Price	Class	Packaging
501188R	EUROK x 3/8" M	63,53 €	BF	10 / 40
501188	EUROK x 1/2" M	63,53 €	BF	10 / 40
501188RCR	EUROK x 3/8" M O-ring	64,21 €	BF	10 / 40
501188RC	EUROK x 1/2" M O-ring	64,21 €	BF	10 / 40

■ VCR 2136 NH



- Valvola termostattizzabile a corpo reverso serie HARMONIA con selettore di portata, bilanciamento dinamico della pressione, attacco maschio e cappuccio di protezione.
- Reverse thermostatic valve HARMONIA-series with flow rate selector, pressure dynamic balancing, male connection and protection cap.
- Robinet thermostatisable à corps renversé série HARMONIA avec sélecteur de débit, équilibrage dynamique de la pression, embout mâle capuchon de protection.
- Revertthermostatventil Serie HARMONIA mit Durchfluss-Wählschalter, dynamische Abgleichventile des Drucks, AG Anschluß und Schutzkappe.
- Válvula termostatzabile invertida serie HARMONIA con selector de flujo, equilibrio dinámico de la presión, conexión macho y capuchón de protección.

Code	Size	Price	Class	Packaging
501192R	EUROK x 3/8" M	63,53 €	BF	10 / 40
501192	EUROK x 1/2" M	63,53 €	BF	10 / 40
501192RCR	EUROK x 3/8" M O-ring	64,21 €	BF	10 / 40
501192RC	EUROK x 1/2" M O-ring	64,21 €	BF	10 / 40



- Raccordo per tubo in rame >> p. 61,66,126,429
- Fitting for copper pipe >> p. 61,66,126,429
- Raccord pour tube en cuivre >> p. 61,66,126,429
- Verschraubung für Kupferrohr >> p. 61,66,126,429
- Conexión para tubo de cobre >> p. 61,66,126,429



- Raccordo per tubo multistrato >> p. 66,123,212,428
- Fitting for multilayer pipe >> p. 66,123,212,428
- Raccord pour tube multicouche >> p. 66,123,212,428
- Verschraubung für Verbundrohr >> p. 66,123,212,428
- Conexión para tubo multicapa >> p. 66,123,212,428



- Raccordo per tubo in polietilene >> p. 66,124,212,428
- Fitting for polyethylene pipe >> p. 66,124,212,428
- Raccord pour tube en polyéthylène >> p. 66,124,212,428
- Verschraubung für PEX-Rohr >> p. 66,124,212,428
- Conexión para tubo de polietileno >> p. 66,124,212,428

VS 2102 NH

- Valvola termostattizzabile a squadra serie HARMONIA con selettore di portata, bilanciamento dinamico della pressione, attacco femmina e cappuccio di protezione.
- Angle thermostatic valve HARMONIA-series with flow rate selector, pressure dynamic balancing, female connection and protection cap.
- Robinet thermostatisable équerre série HARMONIA avec sélecteur de débit, équilibrage dynamique de la pression, embout femelle capuchon de protection.
- Eck-Thermostatventil Serie HARMONIA mit Durchfluss-Wählschalter, dynamische Abgleichventile des Drucks, IG Anschluß und Schutzkappe.
- Válvula termostatzable de escuadra serie HARMONIA con selector de flujo, equilibrio dinámico de la presión, conexión hembra y capuchón de protección.

Code	Size	Price	Class	Packaging
501183	3/8" F x 3/8" M	62,17 €	BF	10 / 40
501184	1/2" F x 1/2" M	63,53 €	BF	10 / 40
501183RC	3/8" F x 3/8" M O-ring	62,84 €	BF	10 / 40
501184RC	1/2" F x 1/2" M O-ring	64,21 €	BF	10 / 40

VD 2101 NH



- Valvola termostattizzabile diritta serie HARMONIA con selettore di portata, bilanciamento dinamico della pressione, attacco femmina e cappuccio di protezione.
- Straight thermostatic valve HARMONIA-series with flow rate selector, pressure dynamic balancing, female connection and protection cap.
- Robinet thermostatisable droit série HARMONIA avec sélecteur de débit, équilibrage dynamique de la pression, embout femelle capuchon de protection.
- Durchgangs-Thermostatventil Serie HARMONIA mit Durchfluss-Wählschalter, dynamische Abgleichventile des Drucks, IG Anschluß und Schutzkappe.
- Válvula termostatzable recta serie HARMONIA con selector de flujo, equilibrio dinámico de la presión, conexión hembra y capuchón de protección.

Code	Size	Price	Class	Packaging
501186	3/8" F x 3/8" M	62,17 €	BF	10 / 40
501187	1/2" F x 1/2" M	63,53 €	BF	10 / 40
501186RC	3/8" F x 3/8" M O-ring	62,84 €	BF	10 / 40
501187RC	1/2" F x 1/2" M O-ring	64,21 €	BF	10 / 40

VCR 2132 NH

- Valvola termostattizzabile a corpo reverso serie HARMONIA con selettore di portata, bilanciamento dinamico della pressione, attacco femmina e cappuccio di protezione.
- Reverse thermostatic valve HARMONIA-series with flow rate selector, pressure dynamic balancing, female connection and protection cap.
- Robinet thermostatisable à corps renversé série HARMONIA avec sélecteur de débit, équilibrage dynamique de la pression, embout femelle capuchon de protection.
- Reversthermostatventil Serie HARMONIA mit Durchfluss-Wählschalter, dynamische Abgleichventile des Drucks, IG Anschluß und Schutzkappe.
- Válvula termostatzable invertida serie HARMONIA con selector de flujo, equilibrio dinámico de la presión, conexión hembra y capuchón de protección.

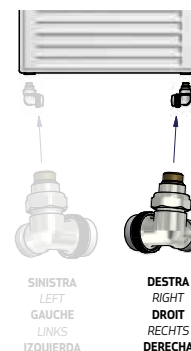
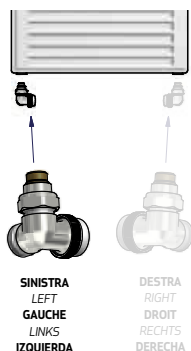
Code	Size	Price	Class	Packaging
501189	3/8" F x 3/8" M	62,17 €	BF	10 / 40
501190	1/2" F x 1/2" M	63,53 €	BF	10 / 40
501189RC	3/8" F x 3/8" M O-ring	62,84 €	BF	10 / 40
501190RC	1/2" F x 1/2" M O-ring	64,21 €	BF	10 / 40



■ VCS 2166 NH SX



- Valvola termostattabile coassiale sinistra serie HARMONIA con selettore di portata, bilanciamento dinamico della pressione, attacco maschio e cappuccio di protezione.
- Co-axial left thermostatic valve HARMONIA-series with flow rate selector, pressure dynamic balancing, male connection and protection cap.
- Robinet thermostatisable coaxial gauche série HARMONIA avec sélecteur de débit, équilibrage dynamique de la pression, embout mâle capuchon de protection.
- Koaxiales Thermostatventil links Serie HARMONIA mit Durchfluss-Wählschalter, dynamische Abgleichventile des Drucks, AG Anschluß und Schutzkappe.
- Válvula termostattabile coaxial izquierda serie HARMONIA con selector de flujo, equilibrio dinámico de la presión, conexión macho y capuchón de protección.

Code	Size	Price	Class	Packaging
500509R	EUROK x 3/8" M	63,53 €	BF	10 / 40
500509	EUROK x 1/2" M	63,53 €	BF	10 / 40
500509RCR	EUROK x 3/8" M O-ring	64,21 €	BF	10 / 40
500509RC	EUROK x 1/2" M O-ring	64,21 €	BF	10 / 40

■ VCS 2162 NH SX



- Valvola termostattabile coassiale sinistra serie HARMONIA con selettore di portata, bilanciamento dinamico della pressione, attacco femmina e cappuccio di protezione.
- Co-axial left thermostatic valve HARMONIA-series with flow rate selector, pressure dynamic balancing, female connection and protection cap.
- Robinet thermostatisable coaxial gauche série HARMONIA avec sélecteur de débit, équilibrage dynamique de la pression, embout femelle capuchon de protection.
- Koaxiales Thermostatventil links Serie HARMONIA mit Durchfluss-Wählschalter, dynamische Abgleichventile des Drucks, IG Anschluß und Schutzkappe.
- Válvula termostattabile coaxial izquierda serie HARMONIA con selector de flujo, equilibrio dinámico de la presión, conexión hembra y capuchón de protección.

Code	Size	Price	Class	Packaging
500507	3/8" F x 3/8" M	62,17 €	BF	10 / 40
500508	1/2" F x 1/2" M	63,53 €	BF	10 / 40
500507RC	3/8" F x 3/8" M O-ring	62,84 €	BF	10 / 40
500508RC	1/2" F x 1/2" M O-ring	64,21 €	BF	10 / 40



- Raccordo per tubo in rame >> p. 61,66,126,429
- Fitting for copper pipe >> p. 61,66,126,429
- Raccord pour tube en cuivre >> p. 61,66,126,429
- Verschraubung für Kupferrohr >> p. 61,66,126,429
- Conexión para tubo de cobre >> p. 61,66,126,429



- Raccordo per tubo multistrato >> p. 66,123,212,428
- Fitting for multilayer pipe >> p. 66,123,212,428
- Raccord pour tube multicouche >> p. 66,123,212,428
- Verschraubung für Verbundrohr >> p. 66,123,212,428
- Conexión para tubo multicapa >> p. 66,123,212,428



- Raccordo per tubo in polietilene >> p. 66,124,212,428
- Fitting for polyethylene pipe >> p. 66,124,212,428
- Raccord pour tube en polyéthylène >> p. 66,124,212,428
- Verschraubung für PEX-Rohr >> p. 66,124,212,428
- Conexión para tubo de polietileno >> p. 66,124,212,428

■ VCD 2166 NH DX



- Valvola termostattabile coassiale destra serie HARMONIA con selettore di portata, bilanciamento dinamico della pressione, attacco maschio e cappuccio di protezione.
- Co-axial right thermostatic valve HARMONIA-series with flow rate selector, pressure dynamic balancing, male connection and protection cap.
- Robinet thermostatisable coaxial droit série HARMONIA avec sélecteur de débit, équilibrage dynamique de la pression, embout mâle capuchon de protection.
- Koaxiales Thermostatventil rechts Serie HARMONIA mit Durchfluss-Wählschalter, dynamische Abgleichventile des Drucks, AG Anschluß und Schutzkappe.
- Válvula termostattabile coaxial derecha serie HARMONIA con selector de flujo, equilibrio dinámico de la presión, conexión macho y capuchón de protección.

Code	Size	Price	Class	Packaging
500512R	EUROK x 3/8" M	63,53 €	BF	10 / 40
500512	EUROK x 1/2" M	63,53 €	BF	10 / 40
500512RCR	EUROK x 3/8" M O-ring	64,21 €	BF	10 / 40
500512RC	EUROK x 1/2" M O-ring	64,21 €	BF	10 / 40

■ VCD 2162 NH DX



- Valvola termostattabile coassiale destra serie HARMONIA con selettore di portata, bilanciamento dinamico della pressione, attacco femmina e cappuccio di protezione.
- Co-axial right thermostatic valve HARMONIA-series with flow rate selector, pressure dynamic balancing, female connection and protection cap.
- Robinet thermostatisable coaxial droit série HARMONIA avec sélecteur de débit, équilibrage dynamique de la pression, embout femelle capuchon de protection.
- Koaxiales Thermostatventil rechts Serie HARMONIA mit Durchfluss-Wählschalter, dynamische Abgleichventile des Drucks, IG Anschluß und Schutzkappe.
- Válvula termostattabile coaxial derecha serie HARMONIA con selector de flujo, equilibrio dinámico de la presión, conexión hembra y capuchón de protección.

Code	Size	Price	Class	Packaging
500510	3/8" F x 3/8" M	62,17 €	BF	10 / 40
500511	1/2" F x 1/2" M	63,53 €	BF	10 / 40
500510RC	3/8" F x 3/8" M O-ring	62,84 €	BF	10 / 40
500511RC	1/2" F x 1/2" M O-ring	64,21 €	BF	10 / 40

THERMOSTATIC VALVES

The thermostatic valve is a device that regulates the flow of water to the radiator and is ready for thermostatic control. The ring nut with control rod can be inspected and replaced while the system is running.

The IVAR standard series valves are supplied in all the figures with a manual head or protection caps instead of controls. The pipe fitting can be female (DN10-15-20 for iron pipe) or male EUROK, while the radiator fitting can be a standard union with a tapered seal or a soft seal union including O-ring. The respective versions are available with reduced 3/8" thread (for EUROK valves).

Standard valves

The standard valves have a plug that moves through the action of the thermostatic head. Standard valves cannot have a pre-set flow rate, which is instead controlled by the lockshield installed at the radiator outlet. All IVAR thermostatic devices have low thermal inertia with a response time of less than 40 min; many of them are EN 215 certified.

Lockshields

In addition to the inlet valve to the radiator, it is advisable to install a lockshield (see appropriate section) at the outlet with shut-off and regulation functions. IVAR lockshields are available in a version that is paired to the corresponding inlet valve, also in the coaxial figures (200 series). The piping and radiator fittings are similar to those found on the valves.

Materials

Body: nickel-plated brass CW617N
Seals and O-rings: peroxide EPDM

Technical specifications

Max. fluid temperature inside valve: 120 °C
Maximum operating pressure: 10 bar
Max. pressure differential with fitted thermostatic head: 0.25 bar



FOCUS: Ring nut substitution

The ring nut is screwed on a special insert and can be replaced even when the system is working.



VERSIONS EXAMPLE - STANDARD SERIES

 500805	 -	 +T
 -	500805	500805T
 +R	500805R	500805TR
 +RC	500805RC	500805TRC
 +RCR	500805RCR	500805TRCR

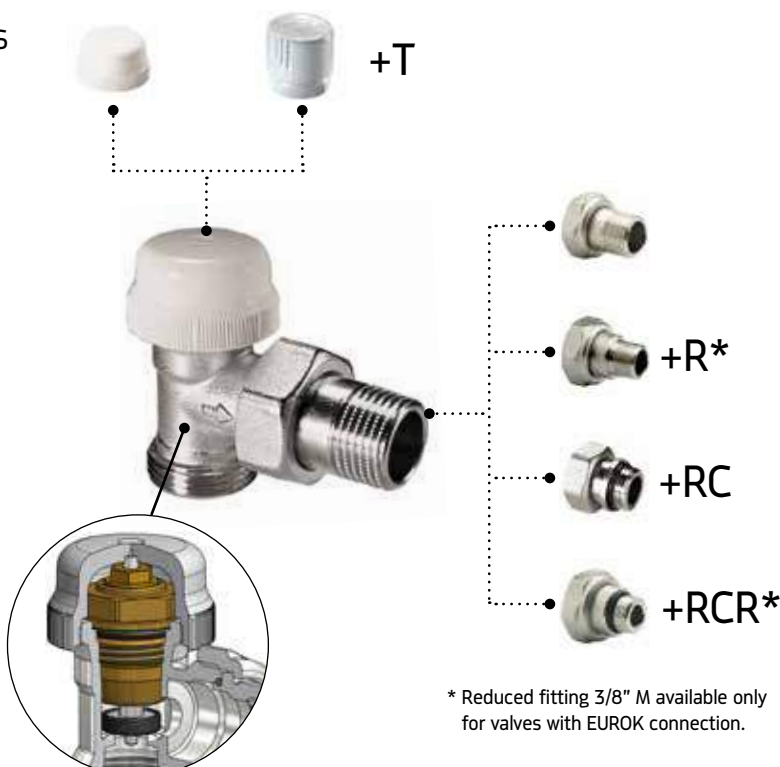

* Reduced fitting 3/8" M available only for valves with EUROK connection.

■ VS 2106



- Valvola termostattizzabile a squadra con attacco maschio e cappuccio di protezione.
- Angle thermostatic valve with male connection and protection cap.
- Robinet thermostatizable équerre avec embout mâle et capuchon de protection.
- Eck-Thermostatventil mit AG Anschluß und Schutzkappe.
- Válvula de escuadra termostattizable con conexión macho y capuchón de protección.

Code	Size	Price	Class	Packaging
500805R	EUROK x 3/8" M	13,50 €	BA	10 / 80
500805	EUROK x 1/2" M	13,12 €	BA	10 / 80
500805RCR	EUROK x 3/8" M O-ring	14,07 €	BA	10 / 80
500805RC	EUROK x 1/2" M O-ring	13,77 €	BA	10 / 80

■ VS 2106 T



- Valvola termostattizzabile a squadra con attacco maschio e testa manuale.
- Angle thermostatic valve with male connection and manual head.
- Robinet thermostatizable équerre avec embout mâle et tête manuelle.
- Eck-Thermostatventil mit AG Anschluß und manueller Hebel.
- Válvula de escuadra termostattizable con conexión macho y cabeza manual.

Code	Size	Price	Class	Packaging
500805TR	EUROK x 3/8" M	15,05 €	BA	10 / 80
500805T	EUROK x 1/2" M	14,68 €	BA	10 / 80
500805TRCR	EUROK x 3/8" M O-ring	15,63 €	BA	10 / 80
500805TRC	EUROK x 1/2" M O-ring	15,33 €	BA	10 / 80

■ VD 2105



- Valvola termostattizzabile diritta con attacco maschio e cappuccio di protezione.
- Straight thermostatic valve with male connection and protection cap.
- Robinet thermostatizable droit avec embout mâle et capuchon de protection.
- Durchgangs-Thermostatventil mit AG Anschluß und Schutzkappe.
- Válvula recta termostattizable con conexión macho y capuchón de protección.

Code	Size	Price	Class	Packaging
500473R	EUROK x 3/8" M	14,68 €	BA	10 / 80
500473	EUROK x 1/2" M	14,31 €	BA	10 / 80
500473RCR	EUROK x 3/8" M O-ring	15,24 €	BA	10 / 80
500473RC	EUROK x 1/2" M O-ring	14,95 €	BA	10 / 80

■ VD 2105 T



- Valvola termostattizzabile diritta con attacco maschio e testa manuale.
- Straight thermostatic valve with male connection and manual head.
- Robinet thermostatizable droit avec embout mâle et tête manuelle.
- Durchgangs-Thermostatventil mit AG Anschluß und manueller Hebel.
- Válvula recta termostattizable con conexión macho y cabeza manual.

Code	Size	Price	Class	Packaging
500473TR	EUROK x 3/8" M	16,23 €	BA	10 / 80
500473T	EUROK x 1/2" M	15,85 €	BA	10 / 80
500473TRCR	EUROK x 3/8" M O-ring	16,80 €	BA	10 / 80
500473TRC	EUROK x 1/2" M O-ring	16,51 €	BA	10 / 80

■ VCR 2136



- Valvola termostattizzabile a corpo reverso con attacco maschio e cappuccio di protezione.
- Reverse thermostatic valve with male connection and protection cap.
- Robinet thermostatizable à corps renversé avec embout mâle et capuchon de protection.
- Revertthermostatventil mit AG Anschluß und Schutzkappe.
- Válvula termostattizable invertida con conexión macho y capuchón de protección.

Code	Size	Price	Class	Packaging
500558R	EUROK x 3/8" M	15,51 €	BA	10 / 80
500558	EUROK x 1/2" M	15,13 €	BA	10 / 80
500558RCR	EUROK x 3/8" M O-ring	16,09 €	BA	10 / 80
500558RC	EUROK x 1/2" M O-ring	15,80 €	BA	10 / 80

■ VCR 2136 T



- Valvola termostattizzabile a corpo reverso con attacco maschio e testa manuale.
- Reverse thermostatic valve with male connection and manual head.
- Robinet thermostatizable à corps renversé avec embout mâle et tête manuelle.
- Revertthermostatventil mit AG Anschluß und manueller Hebel.
- Válvula termostattizable invertida con conexión macho y cabeza manual.

Code	Size	Price	Class	Packaging
500558TR	EUROK x 3/8" M	17,07 €	BA	10 / 80
500558T	EUROK x 1/2" M	16,69 €	BA	10 / 80
500558TRCR	EUROK x 3/8" M O-ring	17,64 €	BA	10 / 80
500558TRC	EUROK x 1/2" M O-ring	17,35 €	BA	10 / 80



- Raccordo per tubo in rame >> p. 61,66,126,429
- Fitting for copper pipe >> p. 61,66,126,429
- Raccord pour tube en cuivre >> p. 61,66,126,429
- Verschraubung für Kupferrohr >> p. 61,66,126,429
- Conexión para tubo de cobre >> p. 61,66,126,429



- Raccordo per tubo multistrato >> p. 66,123,212,428
- Fitting for multilayer pipe >> p. 66,123,212,428
- Raccord pour tube multicouche >> p. 66,123,212,428
- Verschraubung für Verbundrohr >> p. 66,123,212,428
- Conexión para tubo multicapa >> p. 66,123,212,428



- Raccordo per tubo in polietilene >> p. 66,124,212,428
- Fitting for polyethylene pipe >> p. 66,124,212,428
- Raccord pour tube en polyéthylène >> p. 66,124,212,428
- Verschraubung für PEX-Rohr >> p. 66,124,212,428
- Conexión para tubo de polietileno >> p. 66,124,212,428

VS 2102

028

- Valvola termostattizzabile a squadra con attacco femmina e cappuccio di protezione.
- Angle thermostatic valve with female connection and protection cap.
- Robinet thermostatisable équerre avec embout femelle et capuchon de protection.
- Eck-Thermostatventil mit IG Anschluß und Schutzkappe.
- Válvula de escuadra termostatizable con conexión hembra y capuchón de protección.

Code	Size	Price	Class	Packaging
500500	3/8" F x 3/8" M	11,97 €	BA	10 / 80
500501	1/2" F x 1/2" M	13,45 €	BA	10 / 80
500309	3/4" F x 3/4" M	20,35 €	BA	8 / 64
500500RC	3/8" F x 3/8" M O-ring	13,27 €	BA	10 / 80
500501RC	1/2" F x 1/2" M O-ring	14,08 €	BA	10 / 80
500309RC	3/4" F x 3/4" M O-ring	21,38 €	BA	8 / 64

VS 2102 T

- Valvola termostattizzabile a squadra con attacco femmina e testa manuale.
- Angle thermostatic valve with female connection and manual head.
- Robinet thermostatisable équerre avec embout femelle et tête manuelle.
- Eck-Thermostatventil mit IG Anschluß und manueller Hebel.
- Válvula de escuadra termostatizable con conexión hembra y cabeza manual.

Code	Size	Price	Class	Packaging
500500T	3/8" F x 3/8" M	13,53 €	BA	10 / 80
500501T	1/2" F x 1/2" M	14,98 €	BA	10 / 80
500309T	3/4" F x 3/4" M	21,89 €	BA	8 / 64
500500TRC	3/8" F x 3/8" M O-ring	14,81 €	BA	10 / 80
500501TRC	1/2" F x 1/2" M O-ring	15,64 €	BA	10 / 80
500309TRC	3/4" F x 3/4" M O-ring	22,94 €	BA	8 / 64

VD 2101

028

- Valvola termostattizzabile diritta con attacco femmina e cappuccio di protezione.
- Straight thermostatic valve with female connection and protection cap.
- Robinet thermostatisable droit avec embout femelle et capuchon de protection.
- Durchgangs-Thermostatventil mit IG Anschluß und Schutzkappe.
- Válvula recta termostatizable con conexión hembra y capuchón de protección.

Code	Size	Price	Class	Packaging
500439	3/8" F x 3/8" M	13,31 €	BA	10 / 80
500440	1/2" F x 1/2" M	14,61 €	BA	10 / 80
500308	3/4" F x 3/4" M	21,62 €	BA	8 / 32
500439RC	3/8" F x 3/8" M O-ring	14,62 €	BA	10 / 80
500440RC	1/2" F x 1/2" M O-ring	15,24 €	BA	10 / 80
500308RC	3/4" F x 3/4" M O-ring	22,67 €	BA	8 / 32

VD 2101 T

- Valvola termostattizzabile diritta con attacco femmina e testa manuale.
- Straight thermostatic valve with female connection and manual head.
- Robinet thermostatisable droit avec embout femelle et tête manuelle.
- Durchgangs-Thermostatventil mit IG Anschluß und manueller Hebel.
- Válvula recta termostatizable con conexión hembra y cabeza manual.

Code	Size	Price	Class	Packaging
500439T	3/8" F x 3/8" M	14,88 €	BA	10 / 80
500440T	1/2" F x 1/2" M	16,15 €	BA	10 / 80
500308T	3/4" F x 3/4" M	23,18 €	BA	8 / 32
500439TRC	3/8" F x 3/8" M O-ring	16,17 €	BA	10 / 80
500440TRC	1/2" F x 1/2" M O-ring	16,80 €	BA	10 / 80
500308TRC	3/4" F x 3/4" M O-ring	24,23 €	BA	8 / 32

VCR 2132



- Valvola termostattizzabile a corpo reverso con attacco femmina e cappuccio di protezione.
- Reverse thermostatic valve with female connection and protection cap.
- Robinet thermostatisable à corps renversé avec embout femelle et capuchon de protection.
- Revertthermostatventil mit IG Anschluß und Schutzkappe.
- Válvula termostatizable invertida con conexión hembra y capuchón de protección.

Code	Size	Price	Class	Packaging
500399	1/2" F x 1/2" M	15,13 €	BA	10 / 80
500399RC	1/2" F x 1/2" M O-ring	15,80 €	BA	10 / 80

VCR 2132 T

- Valvola termostattizzabile a corpo reverso con attacco femmina e testa manuale.
- Reverse thermostatic valve with female connection and manual head.
- Robinet thermostatisable à corps renversé avec embout femelle et tête manuelle.
- Revertthermostatventil mit IG Anschluß und manueller Hebel.
- Válvula termostatizable invertida con conexión hembra y cabeza manual.

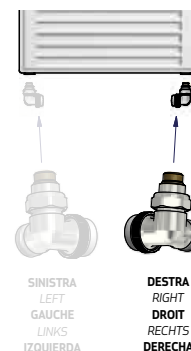
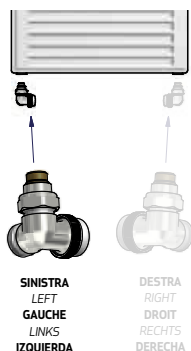
Code	Size	Price	Class	Packaging
500399T	1/2" F x 1/2" M	16,35 €	BA	10 / 80
500399TRC	1/2" F x 1/2" M O-ring	17,01 €	BA	10 / 80



■ VCS 2166 SX



- Valvola termostattizzabile coassiale sinistra con attacco maschio e cappuccio di protezione.
- Co-axial left thermostatic valve with male connection and protection cap.
- Robinet thermostatisable coaxial gauche avec embout mâle et capuchon de protection.
- Koaxiales Thermostatventil links mit AG Anschluß und Schutzkappe.
- Válvula termostatzabile coaxial izquierda con conexión macho y capuchón de protección.

Code	Size	Price	Class	Packaging
500518R	EUROK x 3/8" M	19,50 €	BA	10 / 80
500518	EUROK x 1/2" M	19,13 €	BA	10 / 80
500518RCR	EUROK x 3/8" M O-ring	20,08 €	BA	10 / 80
500518RC	EUROK x 1/2" M O-ring	19,78 €	BA	10 / 80

■ VCS 2166 SXT



- Valvola termostattizzabile coassiale sinistra con attacco maschio e testa manuale.
- Co-axial left thermostatic valve with male connection and manual head.
- Robinet thermostatisable coaxial gauche avec embout mâle et tête manuelle.
- Koaxiales Thermostatventil links mit AG Anschluß und manueller Hebel.
- Válvula termostatzabile coaxial izquierda con conexión macho y cabeza manual.

Code	Size	Price	Class	Packaging
500518TR	EUROK x 3/8" M	21,06 €	BA	10 / 80
500518T	EUROK x 1/2" M	20,68 €	BA	10 / 80
500518TRCR	EUROK x 3/8" M O-ring	21,62 €	BA	10 / 80
500518TRC	EUROK x 1/2" M O-ring	21,32 €	BA	10 / 80

■ VCD 2166 DX



- Valvola termostattizzabile coassiale destra con attacco maschio e cappuccio di protezione.
- Co-axial right thermostatic valve with male connection and protection cap.
- Robinet thermostatisable coaxial droit avec embout mâle et capuchon de protection.
- Koaxiales Thermostatventil rechts mit AG Anschluß und Schutzkappe.
- Válvula termostatzabile coaxial derecha con conexión macho y capuchón de protección.

Code	Size	Price	Class	Packaging
500430R	EUROK x 3/8" M	19,50 €	BA	10 / 80
500430	EUROK x 1/2" M	19,13 €	BA	10 / 80
500430RCR	EUROK x 3/8" M O-ring	20,08 €	BA	10 / 80
500430RC	EUROK x 1/2" M O-ring	19,78 €	BA	10 / 80

■ VCD 2166 DXT



- Valvola termostattizzabile coassiale destra con attacco maschio e testa manuale.
- Co-axial right thermostatic valve with male connection and manual head.
- Robinet thermostatisable coaxial droit avec embout mâle et tête manuelle.
- Koaxiales Thermostatventil rechts mit AG Anschluß und manueller Hebel.
- Válvula termostatzabile coaxial derecha con conexión macho y cabeza manual.

Code	Size	Price	Class	Packaging
500430TR	EUROK x 3/8" M	21,06 €	BA	10 / 80
500430T	EUROK x 1/2" M	20,68 €	BA	10 / 80
500430TRCR	EUROK x 3/8" M O-ring	21,62 €	BA	10 / 80
500430TRC	EUROK x 1/2" M O-ring	21,32 €	BA	10 / 80



- Raccordo per tubo in rame >>> p. 61,66,126,429
- Fitting for copper pipe >>> p. 61,66,126,429
- Raccord pour tube en cuivre >>> p. 61,66,126,429
- Verschraubung für Kupferrohr >>> p. 61,66,126,429
- Conexión para tubo de cobre >>> p. 61,66,126,429



- Raccordo per tubo multistrato >>> p. 66,123,212,428
- Fitting for multilayer pipe >>> p. 66,123,212,428
- Raccord pour tube multicouche >>> p. 66,123,212,428
- Verschraubung für Verbundrohr >>> p. 66,123,212,428
- Conexión para tubo multicapa >>> p. 66,123,212,428

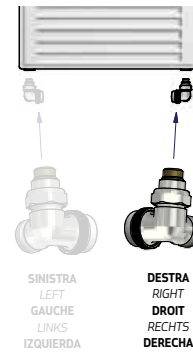
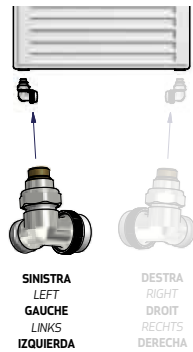

- Raccordo per tubo in polietilene >>> p. 66,124,212,428
- Fitting for polyethylene pipe >>> p. 66,124,212,428
- Raccord pour tube en polyéthylène >>> p. 66,124,212,428
- Verschraubung für PEX-Rohr >>> p. 66,124,212,428
- Conexión para tubo de polietileno >>> p. 66,124,212,428

VCS 2162 SX

- Valvola termostattizzabile coassiale sinistra con attacco femmina e cappuccio di protezione.
- Co-axial left thermostatic valve with female connection and protection cap.
- Robinet thermostatisable coaxial gauche avec embout femelle et capuchon de protection.
- Koaxiales Thermostatventil links mit IG Anschluß und Schutzkappe.
- Válvula termostatzable coaxial izquierda con conexión hembra y capuchón de protección.

Code	Size	Price	Class	Packaging
506077SX	3/8" F x 3/8" M	19,13 €	BA	10 / 80
500433	1/2" F x 1/2" M	19,13 €	BA	10 / 80
506077SXRC	3/8" F x 3/8" M O-ring	20,42 €	BA	10 / 80
500433RC	1/2" F x 1/2" M O-ring	19,78 €	BA	10 / 80

VCS 2162 SXT

- Valvola termostattizzabile coassiale sinistra con attacco femmina e testa manuale.
- Co-axial left thermostatic valve with female connection and manual head.
- Robinet thermostatisable coaxial gauche avec embout femelle et tête manuelle.
- Koaxiales Thermostatventil links mit IG Anschluß und manueller Hebel.
- Válvula termostatzable coaxial izquierda con conexión hembra y cabeza manual.

Code	Size	Price	Class	Packaging
506077SXT	3/8" F x 3/8" M	20,68 €	BA	10 / 80
500433T	1/2" F x 1/2" M	20,68 €	BA	10 / 80
506077SXTRC	3/8" F x 3/8" M O-ring	21,98 €	BA	10 / 80
500433TRC	1/2" F x 1/2" M O-ring	21,32 €	BA	10 / 80

VCD 2162 DX

- Valvola termostattizzabile coassiale destra con attacco femmina e cappuccio di protezione.
- Co-axial right thermostatic valve with female connection and protection cap.
- Robinet thermostatisable coaxial droit avec embout femelle et capuchon de protection.
- Koaxiales Thermostatventil rechts mit IG Anschluß und Schutzkappe.
- Válvula termostatzable coaxial derecha con conexión hembra y capuchón de protección.

Code	Size	Price	Class	Packaging
506077DX	3/8" F x 3/8" M	19,13 €	BA	10 / 80
500829	1/2" F x 1/2" M	19,13 €	BA	10 / 80
506077DXRC	3/8" F x 3/8" M O-ring	20,42 €	BA	10 / 80
500829RC	1/2" F x 1/2" M O-ring	19,78 €	BA	10 / 80

VCD 2162 DXT

- Valvola termostattizzabile coassiale destra con attacco femmina e testa manuale.
- Co-axial right thermostatic valve with female connection and manual head.
- Robinet thermostatisable coaxial droit avec embout femelle et tête manuelle.
- Koaxiales Thermostatventil rechts mit IG Anschluß und manueller Hebel.
- Válvula termostatzable coaxial derecha con conexión hembra y cabeza manual.

Code	Size	Price	Class	Packaging
506077DXT	3/8" F x 3/8" M	20,68 €	BA	10 / 80
500829T	1/2" F x 1/2" M	20,68 €	BA	10 / 80
506077DXTRC	3/8" F x 3/8" M O-ring	21,98 €	BA	10 / 80
500829TRC	1/2" F x 1/2" M O-ring	21,32 €	BA	10 / 80

■ VD 2127



- Valvola termostattizzabile diritta con cappuccio di protezione e attacchi maschio senza bocchettone.
- Straight thermostatic valve with protection cap and male connections without fitting.
- Robinet thermostatisable droit avec capuchon de protection et embouts mâle sans goulotte.
- Durchgangs-Thermostatventil mit Schutzkappe und AG Anschlüsse ohne Stutzen.
- Válvula recta termostatizable con capuchón de protección y conexiones macho sin racor.

Code	Size	Price	Class	Packaging
500890	EUROK x EUROK	11,38 €	BA	10 / 80

■ VD 2127 T



- Valvola termostattizzabile diritta con testa manuale e attacchi maschio senza bocchettone.
- Straight thermostatic valve with manual head and male connections without fitting.
- Robinet thermostatisable droit avec tête manuelle et embouts mâle sans goulotte.
- Durchgangs-Thermostatventil mit manueller Hebel und AG Anschlüsse ohne Stutzen.
- Válvula recta termostatizable con cabeza manual y conexiones macho sin racor.

Code	Size	Price	Class	Packaging
500890T	EUROK x EUROK	12,94 €	BA	10 / 80

■ VD 2115



- Valvola termostattizzabile diritta con attacco maschio, bocchettone ad angolo e cappuccio di protezione.
- Straight thermostatic valve with male connection, angle fitting and protection cap.
- Robinet thermostatisable droit avec embout mâle, goulotte à angle et capuchon de protection.
- Durchgangs-Thermostatventil mit AG Anschluß, Winkel-Stutzen und Schutzkappe.
- Válvula recta termostatizable con conexión macho, boquilla en ángulo y capuchón de protección.

Code	Size	Price	Class	Packaging
500496	EUROK x 1/2" M	18,10 €	BA	10 / 80

■ VD 2111



- Valvola termostattizzabile diritta con attacco femmina, bocchettone ad angolo e cappuccio di protezione.
- Straight thermostatic valve with female connection, angle fitting and protection cap.
- Robinet thermostatisable droit avec embout femelle, goulotte à angle et capuchon de protection.
- Durchgangs-Thermostatventil mit IG Anschluß, Winkel-Stutzen und Schutzkappe.
- Válvula recta termostatizable con conexión hembra, boquilla en ángulo y capuchón de protección.

Code	Size	Price	Class	Packaging
500479	1/2" F x 1/2" M	18,37 €	BA	10 / 40



- Raccordo per tubo in rame >> p. 61,66,126,429
- Fitting for copper pipe >> p. 61,66,126,429
- Raccord pour tube en cuivre >> p. 61,66,126,429
- Verschraubung für Kupferrohr >> p. 61,66,126,429
- Conexión para tubo de cobre >> p. 61,66,126,429



- Raccordo per tubo multistrato >> p. 66,123,212,428
- Fitting for multilayer pipe >> p. 66,123,212,428
- Raccord pour tube multicouche >> p. 66,123,212,428
- Verschraubung für Verbundrohr >> p. 66,123,212,428
- Conexión para tubo multicapa >> p. 66,123,212,428



- Raccordo per tubo in polietilene >>p. 66,124,212,428
- Fitting for polyethylene pipe >>p. 66,124,212,428
- Raccord pour tube en polyéthylène >>p. 66,124,212,428
- Verschraubung für PEX-Rohr >>p. 66,124,212,428
- Conexión para tubo de polietileno >>p. 66,124,212,428



IVAR offers a new range of thermostatic valves for high flow rates.

These valves are available in the straight and angle versions, for steel DN 25 and DN 32 pipes, with tapered or soft seal outlets.

These valves are designed to ensure high flow rate coefficients, making them ideal in renovations of existing single-pipe systems with bypass Tee-fittings upline of the valve.

These valves are compatible with all thermostat heads in the IVAR range.

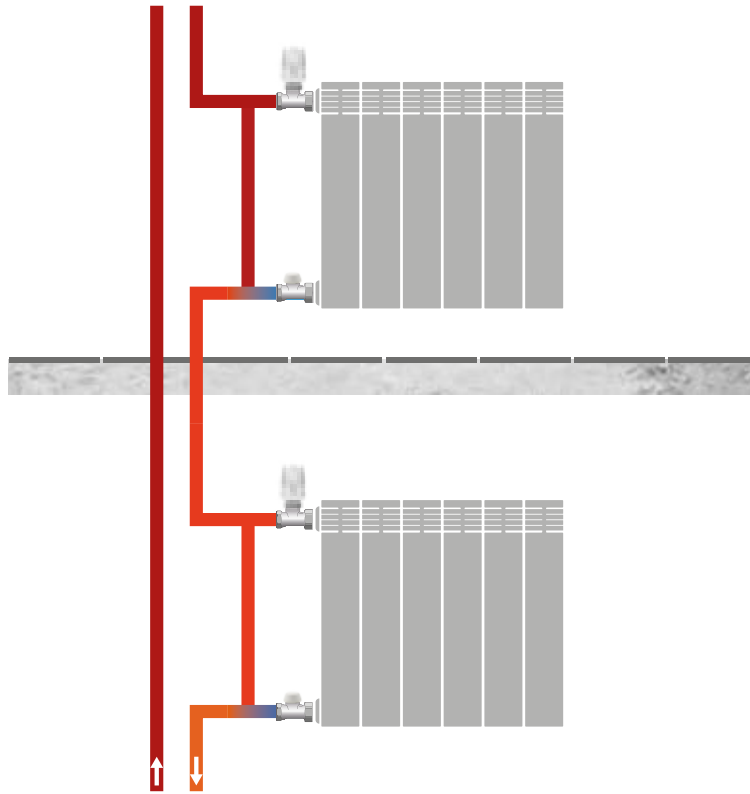

■ VS 2102 XL



- Valvola termostattizzabile a squadra per elevate portate con attacco femmina e cappuccio di protezione.
- Angle thermostatic valve for high flow capacity with female connection and protection cap.
- Robinet thermostatisable équerre pour débit élevé avec embout femelle et capuchon de protection.
- Eck-Thermostatventil für erhöhte Durchfluss mit IG Anschluß und Schutzkappe.
- Válvula de escuadra termostatizable para caudales elevados con conexión hembra y capuchón de protección.

Code	Size	Price	Class	Packaging
500503	1" F x 1" M	61,38 €	BA	5 / 40
500505	1"1/4 F x 1"1/4 M	79,89 €	BA	4 / 32
500503RC	1" F x 1" M O-ring	63,57 €	BA	5 / 40
500505RC	1"1/4 F x 1"1/4 M O-ring	82,64 €	BA	4 / 32

■ VD 2101 XL



- Valvola termostattizzabile diritta per elevate portate con attacco femmina e cappuccio di protezione.
- Straight thermostatic valve for high flow capacity with female connection and protection cap.
- Robinet thermostatisable droit pour débit élevé avec embout femelle et capuchon de protection.
- Durchgangs-Thermostatventil für erhöhte Durchfluss mit IG Anschluß und Schutzkappe.
- Válvula recta termostatizable para caudales elevados con conexión hembra y capuchón de protección.

Code	Size	Price	Class	Packaging
500502	1" F x 1" M	63,54 €	BA	5 / 40
500504	1"1/4 F x 1"1/4 M	89,80 €	BA	4 / 32
500502RC	1" F x 1" M O-ring	65,62 €	BA	5 / 40
500504RC	1"1/4 F x 1"1/4 M O-ring	92,56 €	BA	4 / 32

The thermostatic valve is a device that regulates the flow of water to the radiator and has provision for thermostatic control. The ring nut with control rod can be inspected and replaced while the system is running.

The IVAR N series valves are supplied in all the figures with a manual head or protection caps (**black for N series**) instead of controls. The pipe fitting can be female (DN10-15-20 for iron pipe) or male EUROK, while the radiator fitting can be a standard union with a tapered seal or a soft seal union including O-ring. The respective versions are available with reduced 3/8" thread (for EUROK valves).

"N" series valves with pre-set flow rate

In addition to the plug, valves with pre-set flow rate have a selector with six different calibrated holes (Kv 0.1-0.6), which offer different levels of resistance to the water flow depending on the design characteristics and the position of the radiator in the circuit.

All IVAR thermostatic devices have low thermal inertia with a response time of less than 40 min; many of them are EN 215 certified.

Lockshields

In addition to the inlet valve to the radiator, it is advisable to install a lockshield (see appropriate section) at the outlet with shut-off and regulation functions. IVAR lockshields are available in a version that is paired to the corresponding inlet valve, also in the coaxial figures (200 series). The piping and radiator fittings are similar to those found on the valves.

Materials

Body: nickel-plated brass CW617N
Seals and O-rings: peroxide EPDM

Technical specifications

Max. fluid temperature inside valve: 120 °C
Maximum operating pressure: 10 bar
Max. pressure differential with fitted thermostatic head: 0.25 bar



FOCUS: Ring nut substitution

The ring nut is screwed on a special insert and can be replaced even when the system is working.



VERSIONS EXAMPLE - N SERIES

 500806	 -	 +T
 -	500806	500806T
 +R	500806R	500806TR
 +RC	500806RC	500806TRC
 +RCR	500806RCR	500806TRCR



* Reduced fitting 3/8" M available only for valves with EUROK connection.



FOCUS: Pre-regulation

N series valves are fitted with a pre-adjustment selector which acts on the flow rate to simplify water balancing operations on the circuits.

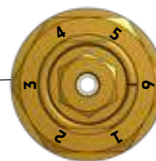
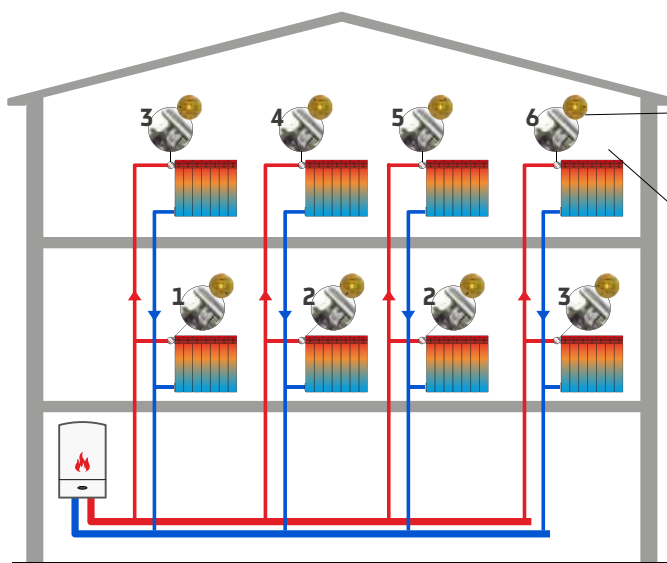

Selector setting on required value by means of a simple 13 mm wrench.

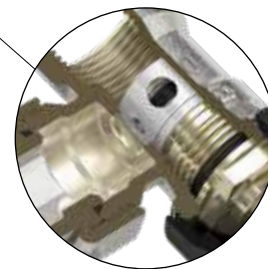

■ VS 2106 N



- Valvola termostattabile a squadra serie N con selettore di portata, attacco maschio e cappuccio di protezione.
- Angle thermostatic valve N-series with flow rate selector, male connection and protection cap.
- Robinet thermostatisable équerre série N avec sélecteur de débit, embout mâle et capuchon de protection.
- Eck-Thermostatventil Serie N mit Durchfluss-Wählschalter, AG Anschluß und Schutzkappe.
- Válvula termostattabile de escuadra serie N con selector de flujo, conexión macho y capuchón de protección.

Code	Size	Price	Class	Packaging
500806R	EUROK x 3/8" M	14,85 €	BC	10 / 80
500806	EUROK x 1/2" M	14,48 €	BC	10 / 80
500806RCR	EUROK x 3/8" M O-ring	15,41 €	BC	10 / 80
500806RC	EUROK x 1/2" M O-ring	15,12 €	BC	10 / 80

■ VS 2106 NT



- Valvola termostattabile a squadra serie N con selettore di portata, attacco maschio e testa manuale.
- Angle thermostatic valve N-series with flow rate selector, male connection and manual head.
- Robinet thermostatisable équerre série N avec sélecteur de débit, embout mâle et tête manuelle.
- Eck-Thermostatventil Serie N mit Durchfluss-Wählschalter, AG Anschluß und manueller Hebel.
- Válvula termostattabile de escuadra serie N con selector de flujo, conexión macho y capuchón de protección.

Code	Size	Price	Class	Packaging
500806TR	EUROK x 3/8" M	16,41 €	BC	10 / 80
500806T	EUROK x 1/2" M	16,03 €	BC	10 / 80
500806TRCR	EUROK x 3/8" M O-ring	16,98 €	BC	10 / 80
500806TRC	EUROK x 1/2" M O-ring	16,68 €	BC	10 / 80

■ VD 2105 N



- Valvola termostattabile diritta serie N con selettore di portata, attacco maschio e cappuccio di protezione.
- Straight thermostatic valve N-series with flow rate selector, male connection and protection cap.
- Robinet thermostatisable droit série N avec sélecteur de débit, embout mâle et capuchon de protection.
- Durchgangs-Thermostatventil Serie N mit Durchfluss-Wählschalter, AG Anschluß und Schutzkappe.
- Válvula termostattabile recta serie N con selector de flujo, conexión macho y capuchón de protección.

Code	Size	Price	Class	Packaging
500474R	EUROK x 3/8" M	16,03 €	BC	10 / 80
500474	EUROK x 1/2" M	15,65 €	BC	10 / 80
500474RCR	EUROK x 3/8" M O-ring	16,59 €	BC	10 / 80
500474RC	EUROK x 1/2" M O-ring	16,29 €	BC	10 / 80

■ VD 2105 NT



- Valvola termostattabile diritta serie N con selettore di portata, attacco maschio e testa manuale.
- Straight thermostatic valve N-series with flow rate selector, male connection and manual head.
- Robinet thermostatisable droit série N avec sélecteur de débit, embout mâle et tête manuelle.
- Durchgangs-Thermostatventil Serie N mit Durchfluss-Wählschalter, AG Anschluß und manueller Hebel.
- Válvula termostattabile recta serie N con selector de flujo, conexión macho y cabeza manual.

Code	Size	Price	Class	Packaging
500474TR	EUROK x 3/8" M	17,58 €	BC	10 / 80
500474T	EUROK x 1/2" M	17,21 €	BC	10 / 80
500474TRCR	EUROK x 3/8" M O-ring	18,14 €	BC	10 / 80
500474TRC	EUROK x 1/2" M O-ring	17,84 €	BC	10 / 80

■ VCR 2136 N



- Valvola termostattabile a corpo reverso serie N con selettore di portata, attacco maschio e cappuccio di protezione.
- Reverse thermostatic valve N-series with flow rate selector, male connection and protection cap.
- Robinet thermostatisable à corps renversé série N avec sélecteur de débit, embout mâle et capuchon de protection.
- Revertthermostatventil Serie N mit Durchfluss-Wählschalter, AG Anschluß und Schutzkappe.
- Válvula termostattabile invertida serie N con selector de flujo, conexión macho y capuchón de protección.

Code	Size	Price	Class	Packaging
500827R	EUROK x 3/8" M	16,86 €	BC	10 / 80
500827	EUROK x 1/2" M	16,50 €	BC	10 / 80
500827RCR	EUROK x 3/8" M O-ring	17,42 €	BC	10 / 80
500827RC	EUROK x 1/2" M O-ring	17,13 €	BC	10 / 80

■ VCR 2136 NT



- Valvola termostattabile a corpo reverso serie N con selettore di portata, attacco maschio e testa manuale.
- Reverse thermostatic valve N-series with flow rate selector, male connection and manual head.
- Robinet thermostatisable à corps renversé série N avec sélecteur de débit, embout mâle et tête manuelle.
- Revertthermostatventil Serie N mit Durchfluss-Wählschalter, AG Anschluß und manueller Hebel.
- Válvula termostattabile invertida serie N con selector de flujo, conexión macho y cabeza manual.

Code	Size	Price	Class	Packaging
500827TR	EUROK x 3/8" M	18,42 €	BC	10 / 80
500827T	EUROK x 1/2" M	18,05 €	BC	10 / 80
500827TRCR	EUROK x 3/8" M O-ring	18,98 €	BC	10 / 80
500827TRC	EUROK x 1/2" M O-ring	18,69 €	BC	10 / 80



- Raccordo per tubo in rame >> p. 61,66,126,429
- Fitting for copper pipe >> p. 61,66,126,429
- Raccord pour tube en cuivre >> p. 61,66,126,429
- Verschraubung für Kupferrohr >> p. 61,66,126,429
- Conexión para tubo de cobre >> p. 61,66,126,429



- Raccordo per tubo multistrato >> p. 66,123,212,428
- Fitting for multilayer pipe >> p. 66,123,212,428
- Raccord pour tube multicouche >> p. 66,123,212,428
- Verschraubung für Verbundrohr >> p. 66,123,212,428
- Conexión para tubo multicapa >> p. 66,123,212,428



- Raccordo per tubo in polietilene >> p. 66,124,212,428
- Fitting for polyethylene pipe >> p. 66,124,212,428
- Raccord pour tube en polyéthylène >> p. 66,124,212,428
- Verschraubung für PEX-Rohr >> p. 66,124,212,428
- Conexión para tubo de polietileno >> p. 66,124,212,428

VS 2102 N

- Valvola termostattizzabile a squadra serie N con selettore di portata, attacco femmina e cappuccio di protezione.
- Angle thermostatic valve N-series with flow rate selector, female connection and protection cap.
- Robinet thermostatisable équerre série N avec sélecteur de débit, embout femelle et capuchon de protection.
- Durchgangs-Thermostatventil Serie N mit Durchfluss-Wählschalter, IG Anschluß und Schutzkappe.
- Válvula termostatzable de escuadra serie N con selector de flujo, conexión hembra y capuchón de protección.

Code	Size	Price	Class	Packaging
500870	3/8" F x 3/8" M	13,32 €	BC	10 / 80
500513	1/2" F x 1/2" M	14,78 €	BC	10 / 80
500384	3/4" F x 3/4" M	21,68 €	BC	8 / 64
500870RC	3/8" F x 3/8" M O-ring	14,63 €	BC	10 / 80
500513RC	1/2" F x 1/2" M O-ring	15,42 €	BC	10 / 80
500384RC	3/4" F x 3/4" M O-ring	22,74 €	BC	8 / 64

VS 2102 NT

- Valvola termostattizzabile a squadra serie N con selettore di portata, attacco femmina e testa manuale.
- Angle thermostatic valve N-series with flow rate selector, female connection and manual head.
- Robinet thermostatisable équerre série N avec sélecteur de débit, embout femelle et tête manuelle.
- Durchgangs-Thermostatventil Serie N mit Durchfluss-Wählschalter, IG Anschluß und manueller Hebel.
- Válvula termostatzable de escuadra serie N con selector de flujo, conexión hembra y cabeza manual.

Code	Size	Price	Class	Packaging
500870T	3/8" F x 3/8" M	14,89 €	BC	10 / 80
500513T	1/2" F x 1/2" M	16,34 €	BC	10 / 80
500384T	3/4" F x 3/4" M	23,24 €	BC	8 / 64
500870TRC	3/8" F x 3/8" M O-ring	16,18 €	BC	10 / 80
500513TRC	1/2" F x 1/2" M O-ring	17,00 €	BC	10 / 80
500384TRC	3/4" F x 3/4" M O-ring	24,28 €	BC	8 / 64

VD 2101 N

- Valvola termostattizzabile diritta serie N con selettore di portata, attacco femmina e cappuccio di protezione.
- Straight thermostatic valve N-series with flow rate selector, female connection and protection cap.
- Robinet thermostatisable droit série N avec sélecteur de débit, embout femelle et capuchon de protection.
- Durchgangs-Thermostatventil Serie N mit Durchfluss-Wählschalter, IG Anschluß und Schutzkappe.
- Válvula termostatzable recta serie N con selector de flujo, conexión hembra y capuchón de protección.

Code	Size	Price	Class	Packaging
500888	3/8" F x 3/8" M	14,67 €	BC	10 / 80
500459	1/2" F x 1/2" M	15,94 €	BC	10 / 80
500382	3/4" F x 3/4" M	22,98 €	BC	8 / 64
500888RC	3/8" F x 3/8" M O-ring	15,96 €	BC	10 / 80
500459RC	1/2" F x 1/2" M O-ring	16,59 €	BC	10 / 80
500382RC	3/4" F x 3/4" M O-ring	24,01 €	BC	8 / 64

VD 2101 NT

- Valvola termostattizzabile diritta serie N con selettore di portata, attacco femmina e testa manuale.
- Straight thermostatic valve N-series with flow rate selector, female connection and manual head.
- Robinet thermostatisable droit série N avec sélecteur de débit, embout femelle et tête manuelle.
- Durchgangs-Thermostatventil Serie N mit Durchfluss-Wählschalter, IG Anschluß und manueller Hebel.
- Válvula termostatzable recta serie N con selector de flujo, conexión hembra y cabeza manual.

Code	Size	Price	Class	Packaging
500888T	3/8" F x 3/8" M	16,22 €	BC	10 / 80
500459T	1/2" F x 1/2" M	17,50 €	BC	10 / 80
500382T	3/4" F x 3/4" M	24,53 €	BC	8 / 64
500888TRC	3/8" F x 3/8" M O-ring	17,52 €	BC	10 / 80
500459TRC	1/2" F x 1/2" M O-ring	18,14 €	BC	10 / 80
500382TRC	3/4" F x 3/4" M O-ring	25,57 €	BC	8 / 64

VCR 2132 N



- Valvola termostattizzabile a corpo reverso serie N con selettore di portata, attacco femmina e cappuccio di protezione.
- Reverse thermostatic valve N-series with flow rate selector, female connection and protection cap.
- Robinet thermostatisable à corps renversé série N avec sélecteur de débit, embout femelle et capuchon de protection.
- Revertthermostatventil Serie N mit Durchfluss-Wählschalter, IG Anschluß und Schutzkappe.
- Válvula termostatzable invertida serie N con selector de flujo, conexión hembra y capuchón de protección.

Code	Size	Price	Class	Packaging
500810	1/2" F x 1/2" M	16,50 €	BC	10 / 80
500810RC	1/2" F x 1/2" M O-ring	17,13 €	BC	10 / 80

VCR 2132 NT

- Valvola termostattizzabile a corpo reverso serie N con selettore di portata, attacco femmina e testa manuale.
- Reverse thermostatic valve N-series with flow rate selector, female connection and manual head.
- Robinet thermostatisable à corps renversé série N avec sélecteur de débit, embout femelle et tête manuelle.
- Revertthermostatventil Serie N mit Durchfluss-Wählschalter, IG Anschluß und manueller Hebel.
- Válvula termostatzable invertida serie N con selector de flujo, conexión hembra y cabeza manual.

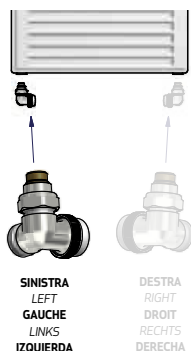
Code	Size	Price	Class	Packaging
500810T	1/2" F x 1/2" M	17,71 €	BC	10 / 80
500810TRC	1/2" F x 1/2" M O-ring	18,35 €	BC	10 / 80



VCS 2166 N SX



- Valvola termostattizzabile coassiale sinistra serie N con selettore di portata, attacco maschio e cappuccio di protezione.
- Co-axial left thermostatic valve N-series with flow rate selector, male connection and protection cap.
- Robinet thermostatisable coaxial gauche série N avec sélecteur de débit, embout mâle et capuchon de protection.
- Koaxiales Thermostatventil links Serie N mit Durchfluss-Wählschalter, AG Anschluß und Schutzkappe.
- Válvula termostatzabile coaxial izquierda serie N con selector de flujo, conexión macho y capuchón de protección.

Code	Size	Price	Class	Packaging
500519R	EUROK x 3/8" M	20,85 €	BC	10 / 80
500519	EUROK x 1/2" M	20,46 €	BC	10 / 80
500519RCR	EUROK x 3/8" M O-ring	21,41 €	BC	10 / 80
500519RC	EUROK x 1/2" M O-ring	21,12 €	BC	10 / 80

VCS 2166 N SXT



- Valvola termostattizzabile coassiale sinistra serie N con selettore di portata, attacco maschio e testa manuale.
- Co-axial left thermostatic valve N-series with flow rate selector, male connection and manual head.
- Robinet thermostatisable coaxial gauche série N avec sélecteur de débit, embout mâle et tête manuelle.
- Koaxiales Thermostatventil links Serie N mit Durchfluss-Wählschalter, AG Anschluß und manueller Hebel.
- Válvula termostatzabile coaxial izquierda serie N con selector de flujo, conexión macho y cabeza manual.

Code	Size	Price	Class	Packaging
500519TR	EUROK x 3/8" M	22,41 €	BC	10 / 80
500519T	EUROK x 1/2" M	22,02 €	BC	10 / 80
500519TRCR	EUROK x 3/8" M O-ring	22,98 €	BC	10 / 80
500519TRC	EUROK x 1/2" M O-ring	22,69 €	BC	10 / 80

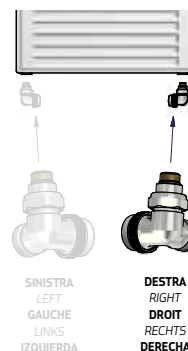

VCD 2166 N DX



- Valvola termostattizzabile coassiale destra serie N con selettore di portata, attacco maschio e cappuccio di protezione.
- Co-axial right thermostatic valve N-series with flow rate selector, male connection and protection cap.
- Robinet thermostatisable coaxial droit série N avec sélecteur de débit, embout mâle et capuchon de protection.
- Koaxiales Thermostatventil rechts Serie N mit Durchfluss-Wählschalter, AG Anschluß und Schutzkappe.
- Válvula termostatzabile coaxial derecha serie N con selector de flujo, conexión macho y capuchón de protección.

Code	Size	Price	Class	Packaging
500431R	EUROK x 3/8" M	20,85 €	BC	10 / 80
500431	EUROK x 1/2" M	20,46 €	BC	10 / 80
500431RCR	EUROK x 3/8" M O-ring	21,41 €	BC	10 / 80
500431RC	EUROK x 1/2" M O-ring	21,12 €	BC	10 / 80

VCD 2166 N DXT



- Valvola termostattizzabile coassiale destra serie N con selettore di portata, attacco maschio e testa manuale.
- Co-axial right thermostatic valve N-series with flow rate selector, male connection and manual head.
- Robinet thermostatisable coaxial droit série N avec sélecteur de débit, embout mâle et tête manuelle.
- Koaxiales Thermostatventil rechts Serie N mit Durchfluss-Wählschalter, AG Anschluß und manueller Hebel.
- Válvula termostatzabile coaxial derecha serie N con selector de flujo, conexión macho y cabeza manual.

Code	Size	Price	Class	Packaging
500431TR	EUROK x 3/8" M	22,41 €	BC	10 / 80
500431T	EUROK x 1/2" M	22,02 €	BC	10 / 80
500431TRCR	EUROK x 3/8" M O-ring	22,98 €	BC	10 / 80
500431TRC	EUROK x 1/2" M O-ring	22,69 €	BC	10 / 80



- Raccordo per tubo in rame >> p. 61,66,126,429
- Fitting for copper pipe >> p. 61,66,126,429
- Raccord pour tube en cuivre >> p. 61,66,126,429
- Verschraubung für Kupferrohr >> p. 61,66,126,429
- Conexión para tubo de cobre >> p. 61,66,126,429



- Raccordo per tubo multistrato >> p. 66,123,212,428
- Fitting for multilayer pipe >> p. 66,123,212,428
- Raccord pour tube multicouche >> p. 66,123,212,428
- Verschraubung für Verbundrohr >> p. 66,123,212,428
- Conexión para tubo multicapa >> p. 66,123,212,428

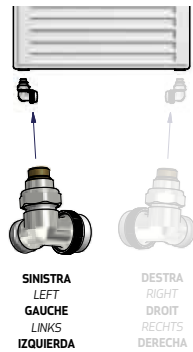

- Raccordo per tubo in polietilene >> p. 66,124,212,428
- Fitting for polyethylene pipe >> p. 66,124,212,428
- Raccord pour tube en polyéthylène >> p. 66,124,212,428
- Verschraubung für PEX-Rohr >> p. 66,124,212,428
- Conexión para tubo de polietileno >> p. 66,124,212,428

VCS 2162 N SX



- Valvola termostattizzabile coassiale sinistra serie N con selettore di portata, attacco femmina e cappuccio di protezione.
- Co-axial left thermostatic valve N-series with flow rate selector, female connection and protection cap.
- Robinet thermostatisable coaxial gauche série N avec sélecteur de débit, embout femelle et capuchon de protection.
- Koaxiales Thermostatventil links Serie N mit Durchfluss-Wählschalter, IG Anschluß und Schutzkappe.
- Válvula termostatzabile coaxial izquierda serie N con selector de flujo, conexión hembra y capuchón de protección.

Code	Size	Price	Class	Packaging
506208SX	3/8" F x 3/8" M	20,46 €	BC	10 / 80
500547	1/2" F x 1/2" M	20,46 €	BC	10 / 80
506208SXRC	3/8" F x 3/8" M O-ring	21,76 €	BC	10 / 80
500547RC	1/2" F x 1/2" M O-ring	21,12 €	BC	10 / 80

VCS 2162 N SXT

- Valvola termostattizzabile coassiale sinistra serie N con selettore di portata, attacco femmina e testa manuale.
- Co-axial left thermostatic valve N-series with flow rate selector, female connection and manual head.
- Robinet thermostatisable coaxial gauche série N avec sélecteur de débit, embout femelle et tête manuelle.
- Koaxiales Thermostatventil links Serie N mit Durchfluss-Wählschalter, IG Anschluß und manueller Hebel.
- Válvula termostatzabile coaxial izquierda serie N con selector de flujo, conexión hembra y cabeza manual.

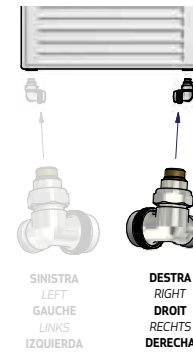
Code	Size	Price	Class	Packaging
506208SXT	3/8" F x 3/8" M	22,02 €	BC	10 / 80
500547T	1/2" F x 1/2" M	22,02 €	BC	10 / 80
506208SXTRC	3/8" F x 3/8" M O-ring	23,32 €	BC	10 / 80
500547TRC	1/2" F x 1/2" M O-ring	22,69 €	BC	10 / 80

VCD 2162 N DX

- Valvola termostattizzabile coassiale destra serie N con selettore di portata, attacco femmina e cappuccio di protezione.
- Co-axial right thermostatic valve N-series with flow rate selector, female connection and protection cap.
- Robinet thermostatisable coaxial droit série N avec sélecteur de débit, embout femelle et capuchon de protection.
- Koaxiales Thermostatventil rechts Serie N mit Durchfluss-Wählschalter, IG Anschluß und Schutzkappe.
- Válvula termostatzabile coaxial derecha serie N con selector de flujo, conexión hembra y capuchón de protección.

Code	Size	Price	Class	Packaging
506208DX	3/8" F x 3/8" M	20,46 €	BC	10 / 80
500546	1/2" F x 1/2" M	20,46 €	BC	10 / 80
506208DXRC	3/8" F x 3/8" M O-ring	21,76 €	BC	10 / 80
500546RC	1/2" F x 1/2" M O-ring	21,12 €	BC	10 / 80

VCD 2162 N DXT

- Valvola termostattizzabile coassiale destra serie N con selettore di portata, attacco femmina e testa manuale.
- Co-axial right thermostatic valve N-series with flow rate selector, female connection and manual head.
- Robinet thermostatisable coaxial droit série N avec sélecteur de débit, embout femelle et tête manuelle.
- Koaxiales Thermostatventil rechts Serie N mit Durchfluss-Wählschalter, IG Anschluß und manueller Hebel.
- Válvula termostatzabile coaxial derecha serie N con selector de flujo, conexión hembra y cabeza manual.

Code	Size	Price	Class	Packaging
506208DXT	3/8" F x 3/8" M	22,02 €	BC	10 / 80
500546T	1/2" F x 1/2" M	22,02 €	BC	10 / 80
506208DXTRC	3/8" F x 3/8" M O-ring	23,32 €	BC	10 / 80
500546TRC	1/2" F x 1/2" M O-ring	22,69 €	BC	10 / 80

■ VD 2127 N



- Valvola termostattizzabile diritta serie N con selettore di portata, cappuccio di protezione e attacchi maschio senza bocchettone.
- Straight thermostatic valve N-series with flow rate selector, protection cap and male connections without fitting.
- Robinet thermostatisable droit série N avec sélecteur de débit, capuchon de protection et embouts mâle sans goulotte.
- Durchgangs-Thermostatventil Serie N mit Durchfluss-Wählschalter, Schutzkappe und AG Anschlüsse ohne Stutzen.
- Válvula termostattizable recta serie N con selector de flujo, capuchón de protección y conexiones macho sin racor.

Code	Size	Price	Class	Packaging
500891	EUROK x EUROK	12,74 €	BC	10 / 80

■ VD 2127 NT



- Valvola termostattizzabile diritta serie N con selettore di portata, testa manuale e attacchi maschio senza bocchettone.
- Straight thermostatic valve N-series with flow rate selector, manual head and male connections without fitting.
- Robinet thermostatisable droit série N avec sélecteur de débit, tête manuelle et embouts mâle sans goulotte.
- Durchgangs-Thermostatventil Serie N mit Durchfluss-Wählschalter, manueller Hebel und AG Anschlüsse ohne Stutzen.
- Válvula termostattizable recta serie N con selector de flujo, cabeza manual y conexiones macho sin racor.

Code	Size	Price	Class	Packaging
500891T	EUROK x EUROK	14,28 €	BC	10 / 80

■ VD 2115 N



- Valvola termostattizzabile diritta serie N con selettore di portata, attacco maschio, bocchettone ad angolo e cappuccio di protezione.
- Straight thermostatic valve N-series with flow rate selector, male connection, angle fitting and protection cap.
- Robinet thermostatisable droit série N avec sélecteur de débit, embout mâle, goulotte à angle et capuchon de protection.
- Durchgangs-Thermostatventil Serie N mit Durchfluss-Wählschalter, AG Anschluß, Winkel-Stutzen und Schutzkappe.
- Válvula termostattizable recta serie N con selector de flujo, conexión macho, racor en ángulo y capuchón de protección.

Code	Size	Price	Class	Packaging
500497	EUROK x 1/2" M	19,46 €	BC	10 / 80

■ VD 2111 N



- Valvola termostattizzabile diritta serie N con selettore di portata, attacco femmina, bocchettone ad angolo e cappuccio di protezione.
- Straight thermostatic valve N-series with flow rate selector, female connection, angle fitting and protection cap.
- Robinet thermostatisable droit série N avec sélecteur de débit, embout femelle, goulotte à angle et capuchon de protection.
- Durchgangs-Thermostatventil Serie N mit Durchfluss-Wählschalter, IG Anschluß, Winkel-Stutzen und Schutzkappe.
- Válvula termostattizable recta serie N con selector de flujo, conexión hembra, racor en ángulo y capuchón de protección.

Code	Size	Price	Class	Packaging
500480	1/2" F x 1/2" M	19,73 €	BC	10 / 80



- Raccordo per tubo in rame >> p. 61,66,126,429
- Fitting for copper pipe >> p. 61,66,126,429
- Raccord pour tube en cuivre >> p. 61,66,126,429
- Verschraubung für Kupferrohr >> p. 61,66,126,429
- Conexión para tubo de cobre >> p. 61,66,126,429



- Raccordo per tubo multistrato >> p. 66,123,212,428
- Fitting for multilayer pipe >> p. 66,123,212,428
- Raccord pour tube multicouche >> p. 66,123,212,428
- Verschraubung für Verbundrohr >> p. 66,123,212,428
- Conexión para tubo multicapa >> p. 66,123,212,428



- Raccordo per tubo in polietilene >> p. 66,124,212,428
- Fitting for polyethylene pipe >> p. 66,124,212,428
- Raccord pour tube en polyéthylène >> p. 66,124,212,428
- Verschraubung für PEX-Rohr >> p. 66,124,212,428
- Conexión para tubo de polietileno >> p. 66,124,212,428

MANUAL VALVES

Manual valves are radiator isolation devices with manual operation only. The DRM series also performs double micrometric adjustment of the opening setting, remembering it in case of subsequent shut-offs. Both families of manual valves are available in all figures, with female pipe fittings (DN10-15-20 for iron pipe) or male EUROK fittings, while the radiator fitting can be a standard union with a tapered seal or a soft seal union including O-ring. The respective versions are available with reduced 3/8" thread (for EUROK valves).

In addition to the inlet valve to the radiator, it is advisable to install a lockshield (see appropriate section) at the outlet with shut-off and regulation functions. IVAR lockshields are available in a standard version (300 series) with the same centre-to-centre distance as the corresponding inlet valve. The piping and radiator fittings are similar to those found on the valves.

Materials

Body: nickel-plated brass CW617N
Seals and O-rings: peroxide EPDM

Technical specifications

Max. fluid temperature inside valve: 120 °C
Maximum operating pressure: 10 bar

VERSIONS EXAMPLE

	501567
	501567
 +R	501567R
 +RC	501567RC
 +RCR	501567RCR

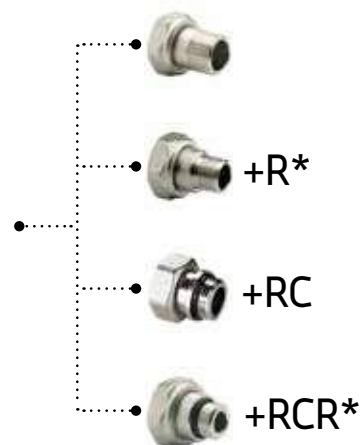

* Reduced fitting 3/8" M available only for valves with EUROK connection.

DRM series: double micrometric adjustment and position memory.

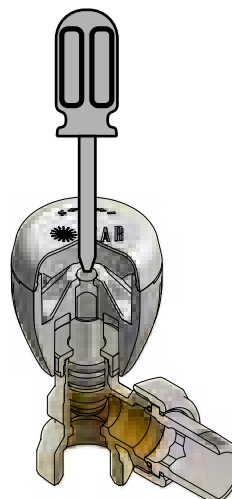

■ VS 206



- Valvola manuale a squadra con attacco maschio.
- Angle manual valve with male connection.
- Robinet manuel équerre avec embout mâle.
- Eck-Handbetätigungsventil mit AG Anschluß.
- Válvula manual de escuadra con conexión macho.

Code	Size	Price	Class	Packaging
501567R	EUROK x 3/8" M	11,46 €	CA	8 / 64
501567	EUROK x 1/2" M	11,09 €	CA	8 / 64
501567RCR	EUROK x 3/8" M O-ring	12,02 €	CA	8 / 64
501567RC	EUROK x 1/2" M O-ring	11,73 €	CA	8 / 64

■ VS 202



- Valvola manuale a squadra con attacco femmina.
- Angle manual valve with female connection.
- Robinet manuel équerre avec embout femelle.
- Eck-Handbetätigungsventil mit IG Anschluß.
- Válvula manual de escuadra con conexión hembra.

Code	Size	Price	Class	Packaging
501456	3/8" F x 3/8" M	10,64 €	CA	8 / 64
501457	1/2" F x 1/2" M	11,16 €	CA	8 / 64
501458	3/4" F x 3/4" M	15,80 €	CA	8 / 64
501456RC	3/8" F x 3/8" M O-ring	11,94 €	CA	8 / 64
501457RC	1/2" F x 1/2" M O-ring	11,80 €	CA	8 / 64
501458RC	3/4" F x 3/4" M O-ring	16,84 €	CA	8 / 64

■ VD 205



- Valvola manuale diritta con attacco maschio.
- Straight manual valve with male connection.
- Robinet manuel droit avec embout mâle.
- Durchgangs-Handbetätigungsventil mit AG Anschluß.
- Válvula manual recta con conexión macho.

Code	Size	Price	Class	Packaging
501459R	EUROK x 3/8" M	11,98 €	CA	8 / 64
501459	EUROK x 1/2" M	11,59 €	CA	8 / 64
501459RCR	EUROK x 3/8" M O-ring	12,53 €	CA	8 / 64
501459RC	EUROK x 1/2" M O-ring	12,23 €	CA	8 / 64

■ VD 201



- Valvola manuale diritta con attacco femmina.
- Straight manual valve with female connection.
- Robinet manuel droit avec embout femelle.
- Durchgangs-Handbetätigungsventil mit IG Anschluß.
- Válvula manual recta con conexión hembra.

Code	Size	Price	Class	Packaging
501451	3/8" F x 3/8" M	10,72 €	CA	8 / 64
501452	1/2" F x 1/2" M	11,73 €	CA	8 / 64
501453	3/4" F x 3/4" M	16,45 €	CA	8 / 64
501451RC	3/8" F x 3/8" M O-ring	12,01 €	CA	8 / 64
501452RC	1/2" F x 1/2" M O-ring	12,37 €	CA	8 / 64
501453RC	3/4" F x 3/4" M O-ring	17,50 €	CA	8 / 64

■ VCR 236



- Valvola manuale a corpo reverso con attacco maschio.
- Reverse manual valve with male connection.
- Robinet manuel à corps renversé avec embout mâle.
- Revershandbetätigungsventil mit AG Anschluß.
- Válvula manual invertida con conexión macho.

Code	Size	Price	Class	Packaging
501636	EUROK x 1/2" M	13,61 €	CA	8 / 64
501636RC	EUROK x 1/2" M O-ring	14,25 €	CA	8 / 64

■ VCR 232



- Valvola manuale a corpo reverso con attacco femmina.
- Reverse manual valve with female connection.
- Robinet manuel à corps renversé avec embout femelle.
- Revershandbetätigungsventil mit IG Anschluß.
- Válvula manual invertida con conexión hembra.

Code	Size	Price	Class	Packaging
501638	1/2" F x 1/2" M	13,97 €	CA	8 / 64
501638RC	1/2" F x 1/2" M O-ring	14,62 €	CA	8 / 64



- Raccordo per tubo in rame >> p. 61,66,126,429
- Fitting for copper pipe >> p. 61,66,126,429
- Raccord pour tube en cuivre >> p. 61,66,126,429
- Verschraubung für Kupferrohr >> p. 61,66,126,429
- Conexión para tubo de cobre >> p. 61,66,126,429



- Raccordo per tubo multistrato >> p. 66,123,212,428
- Fitting for multilayer pipe >> p. 66,123,212,428
- Raccord pour tube multicouche >> p. 66,123,212,428
- Verschraubung für Verbundrohr >> p. 66,123,212,428
- Conexión para tubo multicapa >> p. 66,123,212,428



- Raccordo per tubo in polietilene >> p. 66,124,212,428
- Fitting for polyethylene pipe >> p. 66,124,212,428
- Raccord pour tube en polyéthylène >> p. 66,124,212,428
- Verschraubung für PEX-Rohr >> p. 66,124,212,428
- Conexión para tubo de polietileno >> p. 66,124,212,428

VS 006 DRM

- Valvola manuale a squadra serie DRM con attacco maschio.
- Angle manual valve DRM-series with male connection.
- Robinet manuel équerre série DRM avec embout mâle.
- Eck-Handbetätigungsverventil Serie DRM mit AG Anschluß.
- Válvula manual de escuadra serie DRM con conexión macho.

Code	Size	Price	Class	Packaging
500048R	EUROK x 3/8" M	12,15 €	CC	8 / 64
500048	EUROK x 1/2" M	11,76 €	CC	8 / 64
500048RCR	EUROK x 3/8" M O-ring	12,71 €	CC	8 / 64
500048RC	EUROK x 1/2" M O-ring	12,42 €	CC	8 / 64

VS 002 DRM

- Valvola manuale a squadra serie DRM con attacco femmina.
- Angle manual valve DRM-series with female connection.
- Robinet manuel équerre série DRM avec embout femelle.
- Eck-Handbetätigungsverventil Serie DRM mit IG Anschluß.
- Válvula manual de escuadra serie DRM con conexión hembra.

Code	Size	Price	Class	Packaging
500565	3/8" F x 3/8" M	11,06 €	CC	8 / 64
500566	1/2" F x 1/2" M	11,76 €	CC	8 / 64
500567	3/4" F x 3/4" M	16,44 €	CC	8 / 64
500565RC	3/8" F x 3/8" M O-ring	12,36 €	CC	8 / 64
500566RC	1/2" F x 1/2" M O-ring	12,42 €	CC	8 / 64
500567RC	3/4" F x 3/4" M O-ring	17,49 €	CC	8 / 64

VD 005 DRM

- Valvola manuale diritta serie DRM con attacco maschio.
- Straight manual valve DRM-series with male connection.
- Robinet manuel droit série DRM avec embout mâle.
- Durchgangs-Handbetätigungsverventil Serie DRM mit AG Anschluß.
- Válvula manual recta serie DRM con conexión macho.

Code	Size	Price	Class	Packaging
500571R	EUROK x 3/8" M	12,54 €	CC	8 / 64
500571	EUROK x 1/2" M	12,17 €	CC	8 / 64
500571RCR	EUROK x 3/8" M O-ring	13,11 €	CC	8 / 64
500571RC	EUROK x 1/2" M O-ring	12,81 €	CC	8 / 64

VD 001 DRM

- Valvola manuale diritta serie DRM con attacco femmina.
- Straight manual valve DRM-series with female connection.
- Robinet manuel droit série DRM avec embout femelle.
- Durchgangs-Handbetätigungsverventil Serie DRM mit IG Anschluß.
- Válvula manual recta serie DRM con conexión hembra.

Code	Size	Price	Class	Packaging
500561	3/8" F x 3/8" M	11,38 €	CC	8 / 64
500562	1/2" F x 1/2" M	12,44 €	CC	8 / 64
500563	3/4" F x 3/4" M	16,60 €	CC	8 / 64
500561RC	3/8" F x 3/8" M O-ring	12,67 €	CC	8 / 64
500562RC	1/2" F x 1/2" M O-ring	13,09 €	CC	8 / 64
500563RC	3/4" F x 3/4" M O-ring	17,64 €	CC	8 / 64



- Raccordo per tubo in rame >> p. 61,66,126,429
- Fitting for copper pipe >> p. 61,66,126,429
- Raccord pour tube en cuivre >> p. 61,66,126,429
- Verschraubung für Kupferrohr >> p. 61,66,126,429
- Conexión para tubo de cobre >> p. 61,66,126,429



- Raccordo per tubo multistrato >> p. 66,123,212,428
- Fitting for multilayer pipe >> p. 66,123,212,428
- Raccord pour tube multicouche >> p. 66,123,212,428
- Verschraubung für Verbundrohr >> p. 66,123,212,428
- Conexión para tubo multicapa >> p. 66,123,212,428



- Raccordo per tubo in polietilene >> p. 66,124,212,428
- Fitting for polyethylene pipe >> p. 66,124,212,428
- Raccord pour tube en polyéthylène >> p. 66,124,212,428
- Verschraubung für PEX-Rohr >> p. 66,124,212,428
- Conexión para tubo de polietileno >> p. 66,124,212,428

LOCKSHIELDS

Aside from the inlet valve to the radiator, a lockshield should be installed at the outlet with shut-off and regulation functions. IVAR lockshields are offered in the standard version (series 300) or as a twin of the corresponding inlet valve, also in coaxial figures (series 200). In both cases, the pipe connection can be female or male, while the radiator connection is the standard tapered seal, pipe union with O-ring or reduced 3/8" version (for EUROK valves). VK series lockshields are characterised by the female connection to the radiator with the rotating nut which screws onto the specific male adaptor fitting installed beforehand on the radiator.

Materials

Body: nickel-plated brass CW617N
Gaskets and O-rings: Peroxide EPDM

Technical characteristics

Max fluid temperature inside valve: 120°C
Maximum operating pressure: 10 bar

VERSIONS EXAMPLE - 300 SERIES



*Reduced fitting 3/8" M available only for valves with EUROK connection.

	500053
	500053
-	
	500053R +R
	500053RC +RC
	500053RCR +RCR

VERSIONS EXAMPLE - 200 SERIES

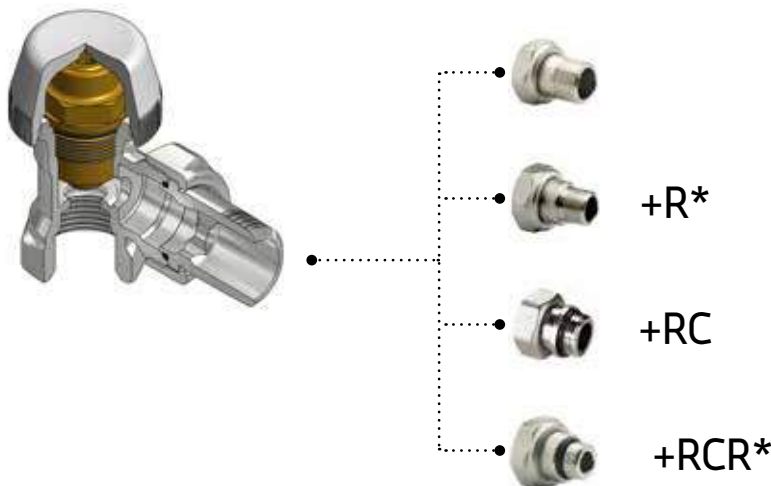

*Reduced fitting 3/8" M available only for valves with EUROK connection.

	520079
	520079
-	
	520079R +R
	520079RC +RC
	520079RCR +RCR

DS 306

- Detentore a squadra con attacco maschio.
- Angle lockshield with male connection.
- Coude de réglage avec embout mâle.
- Eck-Rücklaufventil mit AG Anschluß.
- Detentor de escuadra con conexión macho.

Code	Size	Price	Class	Packaging
500053R	EUROK x 3/8" M	9,32 €	DA	10 / 80
500053	EUROK x 1/2" M	8,95 €	DA	10 / 80
500053RCR	EUROK x 3/8" M O-ring	9,89 €	DA	10 / 80
500053RC	EUROK x 1/2" M O-ring	9,58 €	DA	10 / 80

DS 302

- Detentore a squadra con attacco femmina.
- Angle lockshield with female connection.
- Coude de réglage avec embout femelle.
- Eck-Rücklaufventil mit IG Anschluß.
- Detentor de escuadra con conexión hembra.

Code	Size	Price	Class	Packaging
500656	3/8" F x 3/8" M	8,35 €	DA	10 / 80
500652	1/2" F x 1/2" M	9,07 €	DA	10 / 80
500655	3/4" F x 3/4" M	13,73 €	DA	10 / 80
500656RC	3/8" F x 3/8" M O-ring	9,62 €	DA	10 / 80
500652RC	1/2" F x 1/2" M O-ring	9,73 €	DA	10 / 80
500655RC	3/4" F x 3/4" M O-ring	14,76 €	DA	10 / 80

DS 312

- Detentore a squadra con attacco a saldare.
- Angle lockshield with welding connection.
- Coude de réglage avec embout à souder.
- Eck-Rücklaufventil mit Lotanschluß.
- Detentor de escuadra con conexión para soldar.

Code	Size	Price	Class	Packaging
500784	Ø15 x 1/2" M	8,54 €	DA	10 / 80

DS 330

- Detentore a squadra con tubo in rame cromato saldato.
- Angle lockshield with welder chrome-plated copper pipe.
- Coude de réglage léger avec tube en cuivre chromé soudé.
- Eck-Rücklaufventil mit verchromtem geschweißtem Kupferrohr.
- Detentor de escuadra con tubo de cobre cromado soldado.

Code	Size	Price	Class	Packaging
500557	Ø 15 x Ø 15	18,14 €	DA	70

DD 305

- Detentore diritto con attacco maschio.
- Straight lockshield with male connection.
- Té de réglage avec embout mâle.
- Durchgangs-Rücklaufventil mit AG Anschluß.
- Detentor recto con conexión macho.

Code	Size	Price	Class	Packaging
500751R	EUROK x 3/8" M	9,77 €	DA	10 / 80
500751	EUROK x 1/2" M	9,40 €	DA	10 / 80
500751RCR	EUROK x 3/8" M O-ring	10,34 €	DA	10 / 80
500751RC	EUROK x 1/2" M O-ring	10,03 €	DA	10 / 80

DD 301

- Detentore diritto con attacco femmina.
- Straight lockshield with female connection.
- Té de réglage droit avec embout femelle.
- Durchgangs-Rücklaufventil mit IG Anschluß.
- Detentor recto con conexión hembra.

Code	Size	Price	Class	Packaging
500647	3/8" F x 3/8" M	8,41 €	DA	10 / 80
500642	1/2" F x 1/2" M	9,61 €	DA	10 / 80
500644	3/4" F x 3/4" M	13,89 €	DA	10 / 80
500647RC	3/8" F x 3/8" M O-ring	9,71 €	DA	10 / 80
500642RC	1/2" F x 1/2" M O-ring	10,26 €	DA	10 / 80
500644RC	3/4" F x 3/4" M O-ring	14,92 €	DA	10 / 80

DD 311

- Detentore diritto con attacco a saldare.
- Straight lockshield with welding connection.
- Té de réglage avec embout à souder.
- Rücklaufventil Durchgangsform mit Lotanschluß.
- Detentor recto con conexión para soldar.

Code	Size	Price	Class	Packaging
500623	Ø15 x 1/2" M	9,07 €	DA	10 / 80

DD 327

- Detentore diritto con attacchi maschio senza bocchettone.
- Straight lockshield with male connections without fitting.
- Té de réglage avec embouts mâle sans goulotte.
- Durchgangs-Rücklaufventil mit AG Anschlüsse ohne Stutzen.
- Detentor recto con conexiones macho sin racor.

Code	Size	Price	Class	Packaging
500750	EUROK x EUROK	6,55 €	DA	10 / 80



- Raccordo per tubo in rame >> p. 61,66,126,429
- Fitting for copper pipe >> p. 61,66,126,429
- Raccord pour tube en cuivre >> p. 61,66,126,429
- Verschraubung für Kupferrohr >> p. 61,66,126,429
- Conexión para tubo de cobre >> p. 61,66,126,429



- Raccordo per tubo multistrato >> p. 66,123,212,428
- Fitting for multilayer pipe >> p. 66,123,212,428
- Raccord pour tube multicouche >> p. 66,123,212,428
- Verschraubung für Verbundrohr >> p. 66,123,212,428
- Conexión para tubo multicapa >> p. 66,123,212,428



- Raccordo per tubo in polietilene >> p. 66,124,212,428
- Fitting for polyethylene pipe >> p. 66,124,212,428
- Raccord pour tube en polyéthylène >> p. 66,124,212,428
- Verschraubung für PEX-Rohr >> p. 66,124,212,428
- Conexión para tubo de polietileno >> p. 66,124,212,428

DS 206



- Detentore a squadra serie pesante con attacco maschio.
- Angle lockshield heavy series with male connection.
- Coude de réglage série lourde avec embout mâle.
- Eck-Rücklaufventil schwere Serie mit AG Anschluß.
- Detentor de escuadra serie pesada con conexión macho.

Code	Size	Price	Class	Packaging
520079R	EUROK x 3/8" M	11,72 €	DA	10 / 80
520079	EUROK x 1/2" M	11,32 €	DA	10 / 80
520079RCR	EUROK x 3/8" M O-ring	12,31 €	DA	10 / 80
520079RC	EUROK x 1/2" M O-ring	11,91 €	DA	10 / 80

DD 205



- Detentore diritto serie pesante con attacco maschio.
- Straight lockshield heavy series with male connection.
- Té de réglage série lourde avec embout mâle.
- Durchgangs-Rücklaufventil schwere Serie mit AG Anschluß.
- Detentor recto serie pesada con conexión macho.

Code	Size	Price	Class	Packaging
520077R	EUROK x 3/8" M	12,93 €	DA	10 / 80
520077	EUROK x 1/2" M	12,53 €	DA	10 / 80
520077RCR	EUROK x 3/8" M O-ring	13,51 €	DA	10 / 80
520077RC	EUROK x 1/2" M O-ring	13,12 €	DA	10 / 80

DS 202



- Detentore a squadra serie pesante con attacco femmina.
- Angle lockshield heavy series with female connection.
- Coude de réglage série lourde avec embout femelle.
- Eck-Rücklaufventil schwere Serie mit IG Anschluß.
- Detentor de escuadra serie pesada con conexión hembra.

Code	Size	Price	Class	Packaging
520073	3/8" F x 3/8" M	10,34 €	DA	10 / 80
520074	1/2" F x 1/2" M	11,64 €	DA	10 / 80
520075	3/4" F x 3/4" M	18,19 €	DA	8 / 64
520073RC	3/8" F x 3/8" M O-ring	10,93 €	DA	10 / 80
520074RC	1/2" F x 1/2" M O-ring	12,23 €	DA	10 / 80
520075RC	3/4" F x 3/4" M O-ring	18,84 €	DA	8 / 64

DD 201



- Detentore diritto serie pesante con attacco femmina.
- Straight lockshield heavy series with female connection.
- Té de réglage série lourde avec embout femelle.
- Durchgangs-Rücklaufventil schwere Serie mit IG Anschluß.
- Detentor recto serie pesada con conexión hembra.

Code	Size	Price	Class	Packaging
520070	3/8" F x 3/8" M	11,41 €	DA	10 / 80
520071	1/2" F x 1/2" M	12,81 €	DA	10 / 80
520072	3/4" F x 3/4" M	19,32 €	DA	8 / 64
520070RC	3/8" F x 3/8" M O-ring	12,00 €	DA	10 / 80
520071RC	1/2" F x 1/2" M O-ring	13,40 €	DA	10 / 80
520072RC	3/4" F x 3/4" M O-ring	19,97 €	DA	8 / 64

DD 227



- Detentore diritto serie pesante con attacchi maschio senza bocchettone.
- Straight lockshield heavy series with male connections without fitting.
- Té de réglage série lourde avec embouts mâle sans goulotte.
- Durchgangs-Rücklaufventil schwere Serie mit AG Anschlüsse ohne Stutzen.
- Detentor recto serie pesada con conexiones macho sin racor.

Code	Size	Price	Class	Packaging
520086	EUROK x EUROK	9,77 €	DA	10 / 80



- Raccordo per tubo in rame >> p. 61,66,126,429
- Fitting for copper pipe >> p. 61,66,126,429
- Raccord pour tube en cuivre >> p. 61,66,126,429
- Verschraubung für Kupferrohr >> p. 61,66,126,429
- Conexión para tubo de cobre >> p. 61,66,126,429



- Raccordo per tubo multistrato >> p. 66,123,212,428
- Fitting for multilayer pipe >> p. 66,123,212,428
- Raccord pour tube multicouche >> p. 66,123,212,428
- Verschraubung für Verbundrohr >> p. 66,123,212,428
- Conexión para tubo multicapa >> p. 66,123,212,428



- Raccordo per tubo in polietilene >> p. 66,124,212,428
- Fitting for polyethylene pipe >> p. 66,124,212,428
- Raccord pour tube en polyéthylène >> p. 66,124,212,428
- Verschraubung für PEX-Rohr >> p. 66,124,212,428
- Conexión para tubo de polietileno >> p. 66,124,212,428

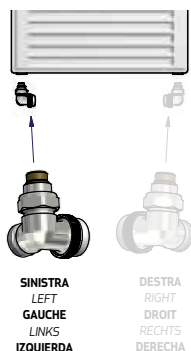

DCS 216 SX



- Detentore coassiale sinistro serie pesante con attacco maschio.
- Co-axial left lockshield heavy series with male connection.
- Raccord de réglage coaxial gauche série lourde avec embout mâle.
- Koaxiales Rücklaufventil links schwere Serie mit AG Anschluß.
- Detentor coaxial izquierdo serie pesada con conexión macho.

Code	Size	Price	Class	Packaging
520085R	EUROK x 3/8" M	17,22 €	DA	10 / 80
520085	EUROK x 1/2" M	16,84 €	DA	10 / 80
520085RCR	EUROK x 3/8" M O-ring	17,81 €	DA	10 / 80
520085RC	EUROK x 1/2" M O-ring	17,41 €	DA	10 / 80

DCS 212 SX



- Detentore coassiale sinistro serie pesante con attacco femmina.
- Co-axial left lockshield heavy series with female connection.
- Raccord de réglage coaxial gauche série lourde avec embout femelle.
- Koaxiales Rücklaufventil links schwere Serie mit IG Anschluß.
- Detentor coaxial izquierdo serie pesada con conexión hembra.

Code	Size	Price	Class	Packaging
520111	3/8" F x 3/8" M	16,89 €	DA	10 / 80
520081	1/2" F x 1/2" M	16,89 €	DA	10 / 80
520111RC	3/8" F x 3/8" M O-ring	17,49 €	DA	10 / 80
520081RC	1/2" F x 1/2" M O-ring	17,49 €	DA	10 / 80

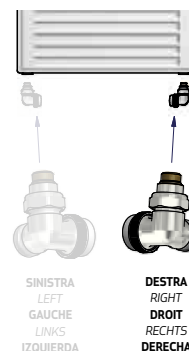

DCD 216 DX



- Detentore coassiale destro serie pesante con attacco maschio.
- Co-axial right lockshield heavy series with male connection.
- Raccord de réglage coaxial droit série lourde avec embout mâle.
- Koaxiales Rücklaufventil rechts schwere Serie mit AG Anschluß.
- Detentor coaxial derecho serie pesada con conexión macho.

Code	Size	Price	Class	Packaging
520084R	EUROK x 3/8" M	17,22 €	DA	10 / 80
520084	EUROK x 1/2" M	16,84 €	DA	10 / 80
520084RCR	EUROK x 3/8" M O-ring	17,81 €	DA	10 / 80
520084RC	EUROK x 1/2" M O-ring	17,41 €	DA	10 / 80

DCD 212 DX



- Detentore coassiale destro serie pesante con attacco femmina.
- Co-axial right lockshield heavy series with female connection.
- Raccord de réglage coaxial droit série lourde avec embout femelle.
- Koaxiales Rücklaufventil rechts schwere Serie mit IG Anschluß.
- Detentor coaxial derecho serie pesada con conexión hembra.

Code	Size	Price	Class	Packaging
520110	3/8" F x 3/8" M	16,89 €	DA	10 / 80
520080	1/2" F x 1/2" M	16,89 €	DA	10 / 80
520110RC	3/8" F x 3/8" M O-ring	17,49 €	DA	10 / 80
520080RC	1/2" F x 1/2" M O-ring	17,49 €	DA	10 / 80



- Raccordo per tubo in rame >> p. 61,66,126,429
- Fitting for copper pipe >> p. 61,66,126,429
- Raccord pour tube en cuivre >> p. 61,66,126,429
- Verschraubung für Kupferrohr >> p. 61,66,126,429
- Conexión para tubo de cobre >> p. 61,66,126,429



- Raccordo per tubo multistrato >> p. 66,123,212,428
- Fitting for multilayer pipe >> p. 66,123,212,428
- Raccord pour tube multicouche >> p. 66,123,212,428
- Verschraubung für Verbundrohr >> p. 66,123,212,428
- Conexión para tubo multicapa >> p. 66,123,212,428



- Raccordo per tubo in polietilene >> p. 66,124,212,428
- Fitting for polyethylene pipe >> p. 66,124,212,428
- Raccord pour tube en polyéthylène >> p. 66,124,212,428
- Verschraubung für PEX-Rohr >> p. 66,124,212,428
- Conexión para tubo de polietileno >> p. 66,124,212,428

■ DS 336



- Detentore a squadra serie VK con attacco maschio.
- Angle lockshield VK series with male connection.
- Coude de réglage série VK avec embout mâle.
- Eck-Rücklaufventil VK Serie mit AG Anschluß.
- Detentor de escuadra serie VK con conexión macho.

Code	Size	Price	Class	Packaging
500598	EUROK x 3/4" EUROK swivel	8,09 €	DA	10 / 80

■ AVK 01



- Adattatore per serie OPTIMA, detentori serie VK e valvole H.
- Adapter for OPTIMA series, VK series lockshields and H valves.
- Adaptateur pour série OPTIMA, coudes et tés de réglage série VK et pièces H.
- Adapter für Serie OPTIMA, Absperrungen der Serie VK und H-Ventile.
- Adaptador para serie OPTIMA, detentores serie VK y válvulas H

Code	Size	Color	Price	Class	Packaging
500770	EUROK x 1/2" M O-ring		1,996 €	EC	80 / 640



- Raccordo per tubo in rame >> p. 61,66,126,429
- Fitting for copper pipe >> p. 61,66,126,429
- Raccord pour tube en cuivre >> p. 61,66,126,429
- Verschraubung für Kupferrohr >> p. 61,66,126,429
- Conexión para tubo de cobre >> p. 61,66,126,429



- Raccordo per tubo multistrato >> p. 66,123,212,428
- Fitting for multilayer pipe >> p. 66,123,212,428
- Raccord pour tube multicouche >> p. 66,123,212,428
- Verschraubung für Verbundrohr >> p. 66,123,212,428
- Conexión para tubo multicapa >> p. 66,123,212,428



- Raccordo per tubo in polietilene >> p. 66,124,212,428
- Fitting for polyethylene pipe >> p. 66,124,212,428
- Raccord pour tube en polyéthylène >> p. 66,124,212,428
- Verschraubung für PEX-Rohr >> p. 66,124,212,428
- Conexión para tubo de polietileno >> p. 66,124,212,428

BASIC SERIES VALVES

Thermostatic and manual valves series "Basic" provides IVAR quality in a range of functional basic components. Liquid-expansion head T 1500 can be perfectly fitted to the valves of "Basic" series, or with any other IVAR valve suitable to thermostatic command. "Basic" product line is completed by valves suitable to thermostatic or manual control, and lockshield valves. All valves are available in angled pattern, with 1/2" or M24x1,5-male and 3/8"- or 1/2"-female pipe connection. Radiator connection can be either standard tapered seal or union with o-ring.

Materials

Valve body: brass CW617N
 Gaskets and O-rings: Peroxide EPDM
 Thermostatic valves insert: PPA +60% heat stabilized FV
 Thermostatic head knob: ABS (RAL 9003)
 Head thermostat: liquid expansion

Technical characteristics

Max fluid temperature inside valve: 100°C
 Maximum operating pressure: 10 bar
 Max valve differential pressure with thermostatic head installed: 0.25 bar
 Response time Z: < 40 min

T 1500



- Testa termostatica con comando e sensore a espansione di liquido incorporati.
- Thermostatic head with incorporated command and liquid expansion sensor.
- Tête thermostatique avec commande et senseur à expansion de liquide incorporés.
- Thermostat-Kopf mit eingebauten Steuerung und Flüssigkeitsausdehnung Fühler.
- Cabeza termostática con mando y sensor de expansión de líquido incorporados.

Code	Size	Z	Range	Color	Price	Class	Packaging
502841	M30 x 1,5	< 40 min	6,5-28 °C	□	14,50 €	AA	16 / 128

THERMOSTATIC VALVES - VERSIONS EXAMPLE



		
510220	510220	510220RC

VS 1104



- Valvola termostattizzabile a squadra serie BASIC con attacco maschio e cappuccio di protezione.
- Angle thermostatic valve BASIC series with male connection and protection cap.
- Robinet thermostatisable équerre série BASIC avec embout mâle et capuchon de protection.
- Eck-Thermostatventil Serie BASIC mit AG Anschluß und Schutzkappe.
- Válvula de escuadra termostatizable serie BASIC con conexión macho y capuchón de protección.

Code	Size	Price	Class	Packaging
510226	1/2" M x 3/8" M	11,06 €	BA	10 / 80
510223	M24x1,5 x 3/8" M	10,92 €	BA	10 / 80
510220	1/2" M x 1/2" M	11,12 €	BA	10 / 80
510213	M24x1,5 x 1/2" M	10,99 €	BA	10 / 80
510226RC	1/2" M x 3/8" M O-ring	11,19 €	BA	10 / 80
510223RC	M24x1,5 x 3/8" M O-ring	11,07 €	BA	10 / 80
510220RC	1/2" M x 1/2" M O-ring	11,70 €	BA	10 / 80
510213RC	M24x1,5 x 1/2" M O-ring	11,59 €	BA	10 / 80

VS 1102



- Valvola termostattizzabile a squadra serie BASIC con attacco femmina e cappuccio di protezione.
- Angle thermostatic valve BASIC series with female connection and protection cap.
- Robinet thermostatisable équerre série BASIC avec embout femelle et capuchon de protection.
- Eck-Thermostatventil Serie BASIC mit IG Anschluß und Schutzkappe.
- Válvula de escuadra termostatizable serie BASIC con conexión hembra y capuchón de protección.

Code	Size	Price	Class	Packaging
510211	3/8" F x 3/8" M	11,11 €	BA	10 / 80
510212	1/2" F x 1/2" M	11,35 €	BA	10 / 80
510211RC	3/8" F x 3/8" M O-ring	11,24 €	BA	10 / 80
510212RC	1/2" F x 1/2" M O-ring	11,92 €	BA	10 / 80



- Raccordo per tubo in rame >> p. 55,429
- Fitting for copper pipe >> p. 55,429
- Raccord pour tube en cuivre >> p. 55,429
- Verschraubung für Kupferrohr >> p. 55,429
- Conexión para tubo de cobre >> p. 55,429



- Raccordo per tubo multistrato >> p. 55,428
- Fitting for multilayer pipe >> p. 55,428
- Raccord pour tube multicouche >> p. 55,428
- Verschraubung für Verbundrohr >> p. 55,428
- Conexión para tubo multicapa >> p. 55,428



- Raccordo per tubo in polietilene >> p. 55,428
- Fitting for polyethylene pipe >> p. 55,428
- Raccord pour tube en polyéthylène >> p. 55,428
- Verschraubung für PEX-Rohr >> p. 55,428
- Conexión para tubo de polietileno >> p. 55,428

MANUAL VALVES - VERSIONS EXAMPLE

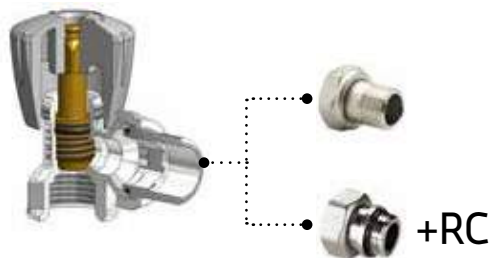

510221	510221	510221RC

LOCKSHIELD VALVES - VERSIONS EXAMPLE

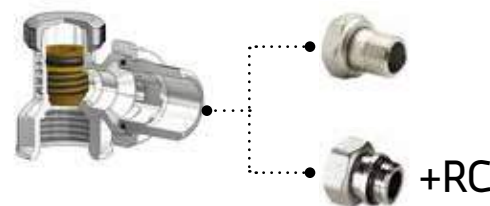

510222	510222	510222RC

VS 104



- Valvola manuale a squadra serie BASIC con attacco maschio.
- Angle manual valve BASIC series with male connection.
- Robinet manuel équerre série BASIC avec embout mâle.
- Eck-Handbetätigungsventil Serie BASIC mit AG Anschluß.
- Válvula manual de escuadra serie BASIC con conexión macho.

Code	Size	Price	Class	Packaging
510227	1/2" M x 3/8" M	9,77 €	CA	10 / 80
510224	M24x1,5 x 3/8" M	9,92 €	CA	10 / 80
510221	1/2" M x 1/2" M	9,83 €	CA	10 / 80
510216	M24x1,5 x 1/2" M	9,98 €	CA	10 / 80
510227RC	1/2" M x 3/8" M O-ring	9,92 €	CA	10 / 80
510224RC	M24x1,5 x 3/8" M O-ring	10,06 €	CA	10 / 80
510221RC	1/2" M x 1/2" M O-ring	10,42 €	CA	10 / 80
510216RC	M24x1,5 x 1/2" M O-ring	10,58 €	CA	10 / 80

DS 404



- Detentore a squadra serie BASIC con attacco maschio.
- Angle lockshield BASIC series with male connection.
- Coude de réglage série BASIC avec embout mâle.
- Eck-Rücklaufventil Serie BASIC mit AG Anschluß.
- Detentor de escuadra serie BASIC con conexión macho.

Code	Size	Price	Class	Packaging
510228	1/2" M x 3/8" M	7,80 €	DA	10 / 80
510225	M24x1,5 x 3/8" M	7,80 €	DA	10 / 80
510222	1/2" M x 1/2" M	7,80 €	DA	10 / 80
510219	M24x1,5 x 1/2" M	7,80 €	DA	10 / 80
510228RC	1/2" M x 3/8" M O-ring	7,96 €	DA	10 / 80
510225RC	M24x1,5 x 3/8" M O-ring	7,96 €	DA	10 / 80
510222RC	1/2" M x 1/2" M O-ring	8,40 €	DA	10 / 80
510219RC	M24x1,5 x 1/2" M O-ring	8,40 €	DA	10 / 80

VS 102



- Valvola manuale a squadra serie BASIC con attacco femmina.
- Angle manual valve BASIC series with female connection.
- Robinet manuel équerre série BASIC avec embout femelle.
- Eck-Handbetätigungsventil Serie BASIC mit IG Anschluß.
- Válvula manual de escuadra serie BASIC con conexión hembra.

Code	Size	Price	Class	Packaging
510214	3/8" F x 3/8" M	9,61 €	CA	10 / 80
510215	1/2" F x 1/2" M	9,98 €	CA	10 / 80
510214RC	3/8" F x 3/8" M O-ring	9,76 €	CA	10 / 80
510215RC	1/2" F x 1/2" M O-ring	10,58 €	CA	10 / 80

DS 402



- Detentore a squadra serie BASIC con attacco femmina.
- Angle lockshield BASIC series with female connection.
- Coude de réglage série BASIC avec embout femelle.
- Eck-Rücklaufventil Serie BASIC mit IG Anschluß.
- Detentor de escuadra serie BASIC con conexión hembra.

Code	Size	Price	Class	Packaging
510217	3/8" F x 3/8" M	7,40 €	DA	10 / 80
510218	1/2" F x 1/2" M	7,94 €	DA	10 / 80
510217RC	3/8" F x 3/8" M O-ring	7,55 €	DA	10 / 80
510218RC	1/2" F x 1/2" M O-ring	8,53 €	DA	10 / 80



- Raccordo per tubo in rame >> p. 55,429
- Fitting for copper pipe >> p. 55,429
- Raccord pour tube en cuivre >> p. 55,429
- Verschraubung für Kupferrohr >> p. 55,429
- Conexión para tubo de cobre >> p. 55,429



- Raccordo per tubo multistrato >> p. 55,428
- Fitting for multilayer pipe >> p. 55,428
- Raccord pour tube multicouche >> p. 55,428
- Verschraubung für Verbundrohr >> p. 55,428
- Conexión para tubo multicapa >> p. 55,428

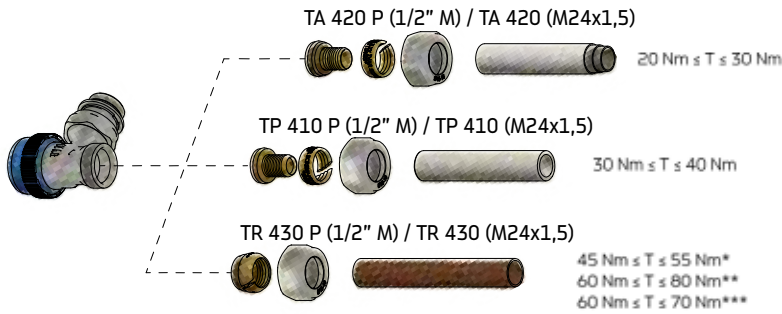

- Raccordo per tubo in polietilene >> p. 55,428
- Fitting for polyethylene pipe >> p. 55,428
- Raccord pour tube en polyéthylène >> p. 55,428
- Verschraubung für PEX-Rohr >> p. 55,428
- Conexión para tubo de polietileno >> p. 55,428

Suitable fittings for valves and lockshields BASIC series with 1/2" M and M24x1,5 connections

- T = Coppia max. di serraggio. [*Rame ricotto.]**Rame semiduro. [***Acciaio dolce.
- T = Max. tightening torque. [*Soft copper.]**Semi-hard copper. [***Mild steel.
- T = Couple de serrage max. [*Cuivre recuit.]**Cuivre semi-rigide. [***Acier doux.
- T = Max. Anzugsdrehmoment. [*Geglühtes Kupfer.]**Mittelfestes Kupfer. [***Weichstahl.
- T = Par de apriete max. [*Cobre recocido.]**Cobre semiduro. [***Acero dulce.

TR 430 P

- Raccordo 1/2" F a stringere per tubo rame ed acciaio dolce con bussola in NBR.
- 1/2" F fitting for copper and mild steel pipe with NBR bushing.
- Raccord 1/2" F pour tube en cuivre et en acier doux avec douille en NBR.
- Verschraubung 1/2" IG für Kupferrohre und Weichstahlrohre mit Hülse aus NBR.
- Conexión 1/2" F para tubo de cobre y acero dulce con buje en NBR.

Code	Size	Color	Price	Class	Packaging
506260	1/2" F x 10/1	■	2,659 €	JA	50 / 400
506261	1/2" F x 12/1	■	2,659 €	JA	50 / 400
506262	1/2" F x 14/1	■	2,659 €	JA	50 / 400
506263	1/2" F x 15/1	■	2,935 €	JA	50 / 400
506264	1/2" F x 16/1	■	2,935 €	JA	50 / 400

TR 430

- Raccordo M24 per tubo rame ed acciaio dolce.
- M24 fitting for copper and mild steel pipe.
- Raccord M24 pour tube en cuivre et en acier doux.
- M24-Verschraubung für Kupferrohre und Weichstahlrohre.
- Conexión M24 para tubo de cobre y acero dulce.

Code	Size	Color	Price	Class	Packaging
500938	M24x1,5 x 10/1	■	3,007 €	JA	50 / 400
500141	M24x1,5 x 12/1	■	2,599 €	JA	50 / 400
500014	M24x1,5 x 14/1	■	2,479 €	JA	50 / 400
500007	M24x1,5 x 15/1	■	2,479 €	JA	50 / 400
500016	M24x1,5 x 16/1	■	2,479 €	JA	50 / 400

TA 420 P

- Raccordo 1/2" F per tubo multistrato e in polietilene.
- 1/2" F fitting for multilayer and polyethylene pipe.
- Raccord 1/2" F pour tube multicouches et en polyéthylène.
- Verschraubung 1/2" IG für Verbund- und für Polyäthyl-Rohr.
- Conexión 1/2" F para tubo multicapa y de polietileno.

Code	Size	Color	Price	Class	Packaging
506265	1/2" F x 14/2	■	3,138 €	JA	50 / 400
500759	1/2" F x 16/2	■	3,138 €	JA	40 / 320
506267	1/2" F x 16/2,25	■	3,138 €	JA	50 / 400

TA 420

- Raccordo M24 per tubo multistrato e in polietilene.
- M24 fitting for multilayer and polyethylene pipe.
- Raccord M24 pour tube multicouches et en polyéthylène.
- M24-Verschraubung für Verbund- und für Polyäthyl-Rohr.
- Conexión M24 para tubo multicapa y de polietileno.

Code	Size	Color	Price	Class	Packaging
501040	M24x1,5 x 14/2	■	3,221 €	JA	50 / 400
501028	M24x1,5 x 16/2	■	3,138 €	JA	50 / 400
501025	M24x1,5 x 16/2,2	■	3,221 €	JA	50 / 400
500049	M24x1,5 x 17/2,3	■	3,318 €	JA	50 / 400
501027	M24x1,5 x 18/2	■	3,318 €	JA	50 / 400
506215	M24x1,5 x 20/2	■	4,935 €	JA	40 / 320

TP 410 P

- Raccordo 1/2" F per tubo in polietilene.
- 1/2" F fitting for polyethylene pipe.
- Raccord 1/2" F pour tube en polyéthylène.
- Verschraubung 1/2" IG für Polyäthyl-Rohr.
- Conexión 1/2" F para tubo de polietileno.

Code	Size	Color	Price	Class	Packaging
506268	1/2" F x 12/1,1	■	3,138 €	JA	50 / 400
506269	1/2" F x 12/2	■	3,138 €	JA	50 / 400
506272	1/2" F x 15/2,5	■	3,138 €	JA	50 / 400
506273	1/2" F x 16/1,5	■	3,138 €	JA	50 / 400
506275	1/2" F x 16/2,2	■	3,138 €	JA	50 / 400

TP 410

- Raccordo M24 per tubo in polietilene.
- M24 fitting for polyethylene pipe.
- Raccord M24 pour tube en polyéthylène.
- M24-Verschraubung für Polyäthyl-Rohr.
- Conexión M24 para tubo de polietileno.

Code	Size	Color	Price	Class	Packaging
501056	M24x1,5 x 12/1	■	3,21 €	JA	50 / 400
501032	M24x1,5 x 14/2	■	3,078 €	JA	50 / 400
501022	M24x1,5 x 16/1,5	■	3,051 €	JA	50 / 400
501034	M24x1,5 x 16/2	■	2,911 €	JA	50 / 400
501035	M24x1,5 x 16/2,2	■	2,911 €	JA	50 / 400
501048	M24x1,5 x 17/2	■	3,051 €	JA	50 / 400
501037	M24x1,5 x 18/2	■	3,318 €	JA	50 / 400

RADIATOR KITS

STANDARD SERIES



KS 306 B



- Kit a squadra standard con attacco maschio.
- Angle kit standard with male connection.
- Kit équerre standard avec embout mâle.
- Eck-Bausatz standard mit AG Anschluß.
- Conjunto de escuadra estándar con conexión macho.

Code	Actuator	Size	Price	Class	Packaging
520188SB	T 1500	EUROK x 3/8" M	37,21 €	BN	1 / 32
520181SB	T 1500	EUROK x 1/2" M	36,47 €	BN	1 / 32
520188SBRC	T 1500	EUROK x 3/8" M O-ring	38,34 €	BN	1 / 32
520181SBRC	T 1500	EUROK x 1/2" M O-ring	37,74 €	BN	1 / 32

KS 306 L



- Kit a squadra standard con attacco maschio.
- Angle kit standard with male connection.
- Kit équerre standard avec embout mâle.
- Eck-Bausatz standard mit AG Anschluß.
- Conjunto de escuadra estándar con conexión macho.

Code	Actuator	Size	Price	Class	Packaging
520188SL	T 5000	EUROK x 3/8" M	40,83 €	BN	1 / 32
520181SL	T 5000	EUROK x 1/2" M	40,08 €	BN	1 / 32
520188SLRC	T 5000	EUROK x 3/8" M O-ring	41,96 €	BN	1 / 32
520181SLRC	T 5000	EUROK x 1/2" M O-ring	41,36 €	BN	1 / 32

KD 305 B



- Kit diritto standard con attacco maschio.
- Straight kit standard with male connection.
- Kit droit standard avec embout mâle.
- Durchgangs-Bausatz standard mit AG Anschluß.
- Conjunto recto estándar con conexión macho.

Code	Actuator	Size	Price	Class	Packaging
520189SB	T 1500	EUROK x 3/8" M	38,84 €	BN	1 / 32
520180SB	T 1500	EUROK x 1/2" M	38,09 €	BN	1 / 32
520189SBRC	T 1500	EUROK x 3/8" M O-ring	39,96 €	BN	1 / 32
520180SBRC	T 1500	EUROK x 1/2" M O-ring	39,37 €	BN	1 / 32

KD 305 L



- Kit diritto standard con attacco maschio.
- Straight kit standard with male connection.
- Kit droit standard avec embout mâle.
- Durchgangs-Bausatz standard mit AG Anschluß.
- Conjunto recto estándar con conexión macho.

Code	Actuator	Size	Price	Class	Packaging
520189SL	T 5000	EUROK x 3/8" M	42,45 €	BN	1 / 32
520180SL	T 5000	EUROK x 1/2" M	41,71 €	BN	1 / 32
520189SLRC	T 5000	EUROK x 3/8" M O-ring	43,58 €	BN	1 / 32
520180SLRC	T 5000	EUROK x 1/2" M O-ring	42,99 €	BN	1 / 32

KS 302 B



- Kit a squadra standard con attacco femmina.
- Angle kit standard with female connection
- Kit équerre standard avec embout femelle
- Eck-Bausatz standard mit IG Anschluß.
- Conjunto de escuadra estándar con conexión hembra.

Code	Actuator	Size	Price	Class	Packaging
520177SB	T 1500	3/8" F x 3/8" M	34,71 €	BN	1 / 32
520178SB	T 1500	1/2" F x 1/2" M	36,91 €	BN	1 / 32
520179SB	T 1500	3/4" F x 3/4" M	48,41 €	BN	1 / 15
520177SBRC	T 1500	3/8" F x 3/8" M O-ring	37,27 €	BN	1 / 32
520178SBRC	T 1500	1/2" F x 1/2" M O-ring	38,19 €	BN	1 / 32
520179SBRC	T 1500	3/4" F x 3/4" M O-ring	50,47 €	BN	1 / 15

KS 302 L



- Kit a squadra standard con attacco femmina.
- Angle kit standard with female connection
- Kit équerre standard avec embout femelle
- Eck-Bausatz standard mit IG Anschluß.
- Conjunto de escuadra estándar con conexión hembra.

Code	Actuator	Size	Price	Class	Packaging
520177SL	T 5000	3/8" F x 3/8" M	38,34 €	BN	1 / 32
520178SL	T 5000	1/2" F x 1/2" M	40,52 €	BN	1 / 32
520179SL	T 5000	3/4" F x 3/4" M	52,03 €	BN	1 / 15
520177SLRC	T 5000	3/8" F x 3/8" M O-ring	40,89 €	BN	1 / 32
520178SLRC	T 5000	1/2" F x 1/2" M O-ring	41,81 €	BN	1 / 32
520179SLRC	T 5000	3/4" F x 3/4" M O-ring	54,08 €	BN	1 / 32

KD 301 B



- Kit diritto standard con attacco femmina.
- Straight kit standard with female connection.
- Kit droit standard avec embout femelle.
- Durchgangs-Bausatz standard mit IG Anschluß.
- Conjunto recto estándar con conexión hembra.

Code	Actuator	Size	Price	Class	Packaging
520174SB	T 1500	3/8" F x 3/8" M	36,10 €	BN	1 / 32
520175SB	T 1500	1/2" F x 1/2" M	38,60 €	BN	1 / 32
520176SB	T 1500	3/4" F x 3/4" M	49,84 €	BN	1 / 15
520174SBRC	T 1500	3/8" F x 3/8" M O-ring	38,69 €	BN	1 / 32
520175SBRC	T 1500	1/2" F x 1/2" M O-ring	39,89 €	BN	1 / 32
520176SBRC	T 1500	3/4" F x 3/4" M O-ring	51,90 €	BN	1 / 15

KD 301 L



- Kit diritto standard con attacco femmina.
- Straight kit standard with female connection.
- Kit droit standard avec embout femelle.
- Durchgangs-Bausatz standard mit IG Anschluß.
- Conjunto recto estándar con conexión hembra.

Code	Actuator	Size	Price	Class	Packaging
520174SL	T 5000	3/8" F x 3/8" M	39,72 €	BN	1 / 32
520175SL	T 5000	1/2" F x 1/2" M	42,22 €	BN	1 / 32
520176SL	T 5000	3/4" F x 3/4" M	53,46 €	BN	1 / 15
520174SLRC	T 5000	3/8" F x 3/8" M O-ring	42,31 €	BN	1 / 32
520175SLRC	T 5000	1/2" F x 1/2" M O-ring	43,51 €	BN	1 / 32
520176SLRC	T 5000	3/4" F x 3/4" M O-ring	55,52 €	BN	1 / 32

N SERIES (with flow rate selector)



KS 306 BN



- Kit a squadra serie N con attacco maschio.
- Angle kit N-series with male connection.
- Kit équerre série N avec embout mâle.
- Eck-Bausatz Serie N mit AG Anschluß.
- Conjunto de escuadra serie N con conexión macho.

Code	Actuator	Size	Price	Class	Packaging
520188VB	T 1500	EUROK x 3/8" M	38,54 €	BN	1 / 32
520181VB	T 1500	EUROK x 1/2" M	37,80 €	BN	1 / 32
520188VBRC	T 1500	EUROK x 3/8" M O-ring	39,67 €	BN	1 / 32
520181VBRC	T 1500	EUROK x 1/2" M O-ring	39,09 €	BN	1 / 32

KS 306 LN



- Kit a squadra serie N con attacco maschio.
- Angle kit N-series with male connection.
- Kit équerre série N avec embout mâle.
- Eck-Bausatz Serie N mit AG Anschluß.
- Conjunto de escuadra serie N con conexión macho.

Code	Actuator	Size	Price	Class	Packaging
520188VL	T 5000	EUROK x 3/8" M	42,17 €	BN	1 / 32
520181VL	T 5000	EUROK x 1/2" M	41,43 €	BN	1 / 32
520188VLRC	T 5000	EUROK x 3/8" M O-ring	43,29 €	BN	1 / 32
520181VLRC	T 5000	EUROK x 1/2" M O-ring	42,70 €	BN	1 / 32

KD 305 BN



- Kit diritto serie N con attacco maschio.
- Straight kit N-series with male connection.
- Kit droit série N avec embout mâle.
- Durchgangs-Bausatz Serie N mit AG Anschluß.
- Conjunto recto serie N con conexión macho.

Code	Actuator	Size	Price	Class	Packaging
520189VB	T 1500	EUROK x 3/8" M	40,18 €	BN	1 / 32
520180VB	T 1500	EUROK x 1/2" M	39,43 €	BN	1 / 32
520189VBRC	T 1500	EUROK x 3/8" M O-ring	41,30 €	BN	1 / 32
520180VBRC	T 1500	EUROK x 1/2" M O-ring	40,71 €	BN	1 / 32

KD 305 LN



- Kit diritto serie N con attacco maschio.
- Straight kit N-series with male connection.
- Kit droit série N avec embout mâle.
- Durchgangs-Bausatz Serie N mit AG Anschluß.
- Conjunto recto serie N con conexión macho.

Code	Actuator	Size	Price	Class	Packaging
520189VL	T 5000	EUROK x 3/8" M	43,81 €	BN	1 / 32
520180VL	T 5000	EUROK x 1/2" M	43,05 €	BN	1 / 32
520189VLRC	T 5000	EUROK x 3/8" M O-ring	44,93 €	BN	1 / 32
520180VLRC	T 5000	EUROK x 1/2" M O-ring	44,34 €	BN	1 / 32

KS 302 BN



- Kit a squadra serie N con attacco femmina.
- Angle kit N-series with female connection.
- Kit équerre série N avec embout femelle.
- Eck-Bausatz Serie N mit IG Anschluß.
- Conjunto de escuadra serie N con conexión hembra.

Code	Actuator	Size	Price	Class	Packaging
520177VB	T 1500	3/8" F x 3/8" M	36,06 €	BN	1 / 32
520178VB	T 1500	1/2" F x 1/2" M	38,24 €	BN	1 / 32
520179VB	T 1500	3/4" F x 3/4" M	49,75 €	BN	1 / 32
520177VBRC	T 1500	3/8" F x 3/8" M O-ring	38,63 €	BN	1 / 32
520178VBRC	T 1500	1/2" F x 1/2" M O-ring	39,54 €	BN	1 / 32
520179VBRC	T 1500	3/4" F x 3/4" M O-ring	51,82 €	BN	1 / 32

KS 302 LN



- Kit a squadra serie N con attacco femmina.
- Angle kit N-series with female connection.
- Kit équerre série N avec embout femelle.
- Eck-Bausatz Serie N mit IG Anschluß.
- Conjunto de escuadra serie N con conexión hembra.

Code	Actuator	Size	Price	Class	Packaging
520177VL	T 5000	3/8" F x 3/8" M	39,67 €	BN	1 / 32
520178VL	T 5000	1/2" F x 1/2" M	41,86 €	BN	1 / 32
520179VL	T 5000	3/4" F x 3/4" M	53,37 €	BN	1 / 15
520177VLRC	T 5000	3/8" F x 3/8" M O-ring	42,25 €	BN	1 / 32
520178VLRC	T 5000	1/2" F x 1/2" M O-ring	43,15 €	BN	1 / 32
520179VLRC	T 5000	3/4" F x 3/4" M O-ring	55,45 €	BN	1 / 15

KD 301 BN



- Kit diritto serie N con attacco femmina.
- Straight kit N-series with female connection.
- Kit droit série N avec embout femelle.
- Durchgangs-Bausatz Serie N mit IG Anschluß.
- Conjunto recto serie N con conexión hembra.

Code	Actuator	Size	Price	Class	Packaging
520174VB	T 1500	3/8" F x 3/8" M	37,47 €	BN	1 / 32
520175VB	T 1500	1/2" F x 1/2" M	39,93 €	BN	1 / 32
520176VB	T 1500	3/4" F x 3/4" M	51,20 €	BN	1 / 32
520174VBRC	T 1500	3/8" F x 3/8" M O-ring	40,05 €	BN	1 / 32
520175VBRC	T 1500	1/2" F x 1/2" M O-ring	41,23 €	BN	1 / 32
520176VBRC	T 1500	3/4" F x 3/4" M O-ring	53,26 €	BN	1 / 32

KD 301 LN



- Kit diritto serie N con attacco femmina.
- Straight kit N-series with female connection.
- Kit droit série N avec embout femelle.
- Durchgangs-Bausatz Serie N mit IG Anschluß.
- Conjunto recto serie N con conexión hembra.

Code	Actuator	Size	Price	Class	Packaging
520174VL	T 5000	3/8" F x 3/8" M	41,09 €	BN	1 / 32
520175VL	T 5000	1/2" F x 1/2" M	43,56 €	BN	1 / 32
520176VL	T 5000	3/4" F x 3/4" M	54,83 €	BN	1 / 15
520174VLRC	T 5000	3/8" F x 3/8" M O-ring	43,66 €	BN	1 / 32
520175VLRC	T 5000	1/2" F x 1/2" M O-ring	44,85 €	BN	1 / 32
520176VLRC	T 5000	3/4" F x 3/4" M O-ring	56,88 €	BN	1 / 32

H VALVES

Four-port valves are necessary when the inlet and outlet connections of the radiator are located at the same spot. Radiators with built-in taps and fittings use DS/DD series H valves for two pipe plants, or with adjustable bypass for single pipe plants. A thermostatic headwork can be installed on the delivery line (type H and type D, depending on the seat model used by the radiator manufacturer) by screwing it directly onto the radiator inlet.

VS/VD H valves can be adapted to radiant plates, incorporating both the thermostatic valve with flow rate pre-regulation and the lockshield.

All IVAR H valves are available for systems with floor and wall connections.

Materials

Body: nickel-plated brass CW617N

Gaskets and O-rings: Peroxide EPDM

Technical characteristics

Max fluid temperature inside valve: 120°C

Maximum operating pressure: 10 bar

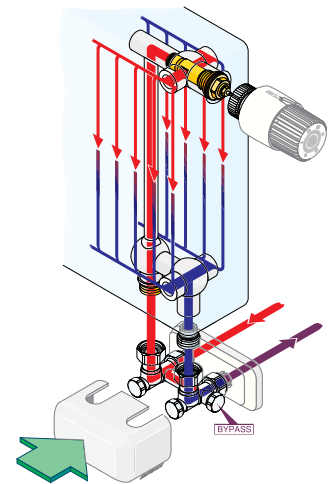

DS 346



- Valvola H con attacco maschio per impianti bitubo con derivazioni a parete.
- H valve with male connection for double pipe systems with wall pipes.
- Pièce H avec embout mâle pour systèmes bitube avec dérivation murales.
- Zweirohr-Hahnblock Eckform mit AG Anschluß.
- Válvula H con conexión macho para sistemas bitubo con derivaciones de pared.

Code	Size	Price	Class	Packaging
500848	EUROK x 3/4" EUROK swivel	18,88 €	EA	6 / 48
500848B	EUROK x 1/2" M O-ring	22,88 €	EA	6 / 48

DD 345



- Valvola H con attacco maschio per impianti bitubo con derivazioni a pavimento.
- H valve with male connection for double pipe systems with floor pipes.
- Pièce H avec embout mâle pour systèmes bitube avec dérivation au sol.
- Zweirohr-Hahnblock Durchgangsform mit AG Anschluß.
- Válvula H con conexión macho para sistemas bitubo con derivaciones de suelo.

Code	Size	Price	Class	Packaging
500845	EUROK x 3/4" EUROK swivel	19,07 €	EA	6 / 48
500845B	EUROK x 1/2" M O-ring	23,11 €	EA	6 / 48

DS 356



- Valvola H con attacco maschio per impianti monotubo/bitubo (con bypass regolabile 50-100%) con derivazioni a parete.
- H valve with male connection for single/double pipe systems (with adjustable bypass 50-100%) with wall pipes.
- Pièce H avec embout mâle pour systèmes monotube/bitube (avec bypass réglable 50-100%) avec dérivation murales.
- Ein-/Zweirohr-Hahnblock (mit regelbarer Bypass 50-100%) Eckform mit AG Anschluß.
- Válvula H con conexión macho para sistemas monotubo/bitubo (con bypass ajustable 50-100%) con derivaciones de pared.

Code	Size	Price	Class	Packaging
500323	EUROK x 3/4" EUROK swivel	25,19 €	EA	6 / 48
500323B	EUROK x 1/2" M O-ring	29,21 €	EA	6 / 48

DD 355



- Valvola H con attacco maschio per impianti monotubo/bitubo (con bypass regolabile 50-100%) con derivazioni a pavimento.
- H valve with male connection for single/double pipe systems (with adjustable bypass 50-100%) with floor pipes.
- Pièce H avec embout mâle pour systèmes monotube/bitube (avec bypass réglable 50-100%) avec dérivation au sol.
- Ein-/Zweirohr-Hahnblock (mit regelbarer Bypass 50-100%) Durchgangsform mit AG Anschluß.
- Válvula H con conexión macho para sistemas monotubo/bitubo (con bypass ajustable 50-100%) con derivaciones de suelo.

Code	Size	Price	Class	Packaging
500317	EUROK x 3/4" EUROK swivel	24,96 €	EA	6 / 48
500317B	EUROK x 1/2" M O-ring	29,00 €	EA	6 / 48

AVK 02



- Carter universale per valvole H.
- Universal cover for H valves.
- Carter universel pour pièces H.
- Universalgehäuse für Hahnblöcke.
- Tapa universal para válvulas H

Code	Color	Price	Class	Packaging
501217	□	1,933 €	EC	120

AVK 01



- Adattatore per serie OPTIMA, detentori serie VK e valvole H.
- Adapter for OPTIMA series, VK series lockshields and H valves.
- Adaptateur pour série OPTIMA, coudes et tés de réglage série VK et pièces H.
- Adapter für Serie OPTIMA, Absperrungen der Serie VK und H-Ventile.
- Adaptador para serie OPTIMA, detentores serie VK y válvulas H

Code	Size	Color	Price	Class	Packaging
500770	EUROK x 1/2" M O-ring	■	1,996 €	EC	80 / 640

VIT 51

- Vitone termostatico con selettore di portata per valvola incorporata nel corpo scaldante tipo H.
- Thermostatic headwork with flow rate selector for valve incorporated in the heating element H-type.
- Insert thermostatique avec sélecteur de débit pour vanne incorporée dans le corps chauffant type H.
- Thermostat- Einsatz mit Durchfluss-Wählschalter für in dem Heizkörper eingebaut Ventil Typ H.
- Tornillo termostático con selector de flujo para válvula integrada en el radiador tipo H.

Code	Range	Price	Class	Packaging
500423	KV 0,1 - 0,6 (N SERIES)	10,31 €	EC	200

VIT 52

- Vitone termostatico con selettore di portata per valvola incorporata nel corpo scaldante tipo D.
- Thermostatic headwork with flow rate selector for valve incorporated in the heating element D-type.
- Insert thermostatique avec sélecteur de débit pour vanne incorporée dans le corps chauffant type D.
- Thermostat- Einsatz mit Durchfluss-Wählschalter für in dem Heizkörper eingebaut Ventil Typ D.
- Tornillo termostático con selector de flujo para válvula integrada en el radiador tipo D.

Code	Range	Price	Class	Packaging
500424	KV 0,1 - 0,6 (N SERIES)	10,45 €	EC	200

VS 2146

- Valvola H termostattabile serie N con attacco maschio per impianti bitubo con derivazioni a parete.
- H thermostatic valve N-series with male connection for double pipe systems with wall pipes.
- Pièce H thermostatizable série N avec embout mâle pour systèmes bitube avec dérivations murales.
- Zweirohr-H-Thermostatventil Serie N Eckform mit AG Anschluß.
- Válvula H termostattabile serie N con conexión macho para sistemas bitubo con derivaciones de pared.

Code	Size	Price	Class	Packaging
500831	EUROK x 1/2" M O-ring	33,14 €	BC	5 / 40

VD 2145

- Valvola H termostattabile serie N con attacco maschio per impianti bitubo con derivazioni a pavimento.
- H thermostatic valve N-series with male connection for double pipe systems with floor pipes.
- Pièce H thermostatizable série N avec embout mâle pour systèmes bitube avec dérivations au sol.
- Zweirohr-H-Thermostatventil Serie N Durchgangsform mit AG Anschluß.
- Válvula H termostattabile serie N con conexión macho para sistemas bitubo con derivaciones de suelo.

Code	Size	Price	Class	Packaging
500823	EUROK x 1/2" M O-ring	31,18 €	BC	6 / 48

VS 2156

- Valvola H termostattabile serie N con attacco maschio per impianti bitubo con derivazioni a parete.
- H thermostatic valve N-series with male connection for double pipe systems with wall pipes.
- Pièce H thermostatizable série N avec embout mâle pour systèmes bitube avec dérivations murales.
- Zweirohr-H-Thermostatventil Serie N Eckform mit AG Anschluß.
- Válvula H termostattabile serie N con conexión macho para sistemas bitubo con derivaciones de pared.

Code	Size	Price	Class	Packaging
501826	EUROK x 1/2" M O-ring (AVK 01)	36,60 €	BC	5 / 40

VD 2155

- Valvola H termostattabile serie N con attacco maschio per impianti bitubo con derivazioni a pavimento.
- H thermostatic valve N-series with male connection for double pipe systems with floor pipes.
- Pièce H thermostatizable série N avec embout mâle pour systèmes bitube avec dérivations au sol.
- Zweirohr-H-Thermostatventil Serie N Durchgangsform mit AG Anschluß.
- Válvula H termostattabile serie N con conexión macho para sistemas bitubo con derivaciones de suelo.

Code	Size	Price	Class	Packaging
501823	EUROK x 1/2" M O-ring (AVK 01)	34,91 €	BC	6 / 48



- Raccordo per tubo in rame >> p. 61,66,126,429
- Fitting for copper pipe >> p. 61,66,126,429
- Raccord pour tube en cuivre >> p. 61,66,126,429
- Verschraubung für Kupferrohr >> p. 61,66,126,429
- Conexión para tubo de cobre >> p. 61,66,126,429



- Raccordo per tubo multistrato >> p. 66,123,212,428
- Fitting for multilayer pipe >> p. 66,123,212,428
- Raccord pour tube multicouche >> p. 66,123,212,428
- Verschraubung für Verbundrohr >> p. 66,123,212,428
- Conexión para tubo multicapa >> p. 66,123,212,428



- Raccordo per tubo in polietilene >> p. 66,124,212,428
- Fitting for polyethylene pipe >> p. 66,124,212,428
- Raccord pour tube en polyéthylène >> p. 66,124,212,428
- Verschraubung für PEX-Rohr >> p. 66,124,212,428
- Conexión para tubo de polietileno >> p. 66,124,212,428

4-WAY DISTRIBUTORS

Distributors are four-way valves for the distribution of heat transfer fluid in single pipe (DM) or double pipe (DB) systems. DMB valves are equipped with adjustable bypass so that they can be installed on both types of systems. In all the models, after the top valve closes, the valve plug isolates the radiator and balances the circuit, if necessary. Available for systems with floor or wall junctions.

Materials

Body: nickel-plated brass CW617N
Gaskets and O-rings: Peroxide EPDM

Technical characteristics

Max fluid temperature inside valve: 120°C
Maximum operating pressure: 10 bar

INSTALLATION LAYOUT

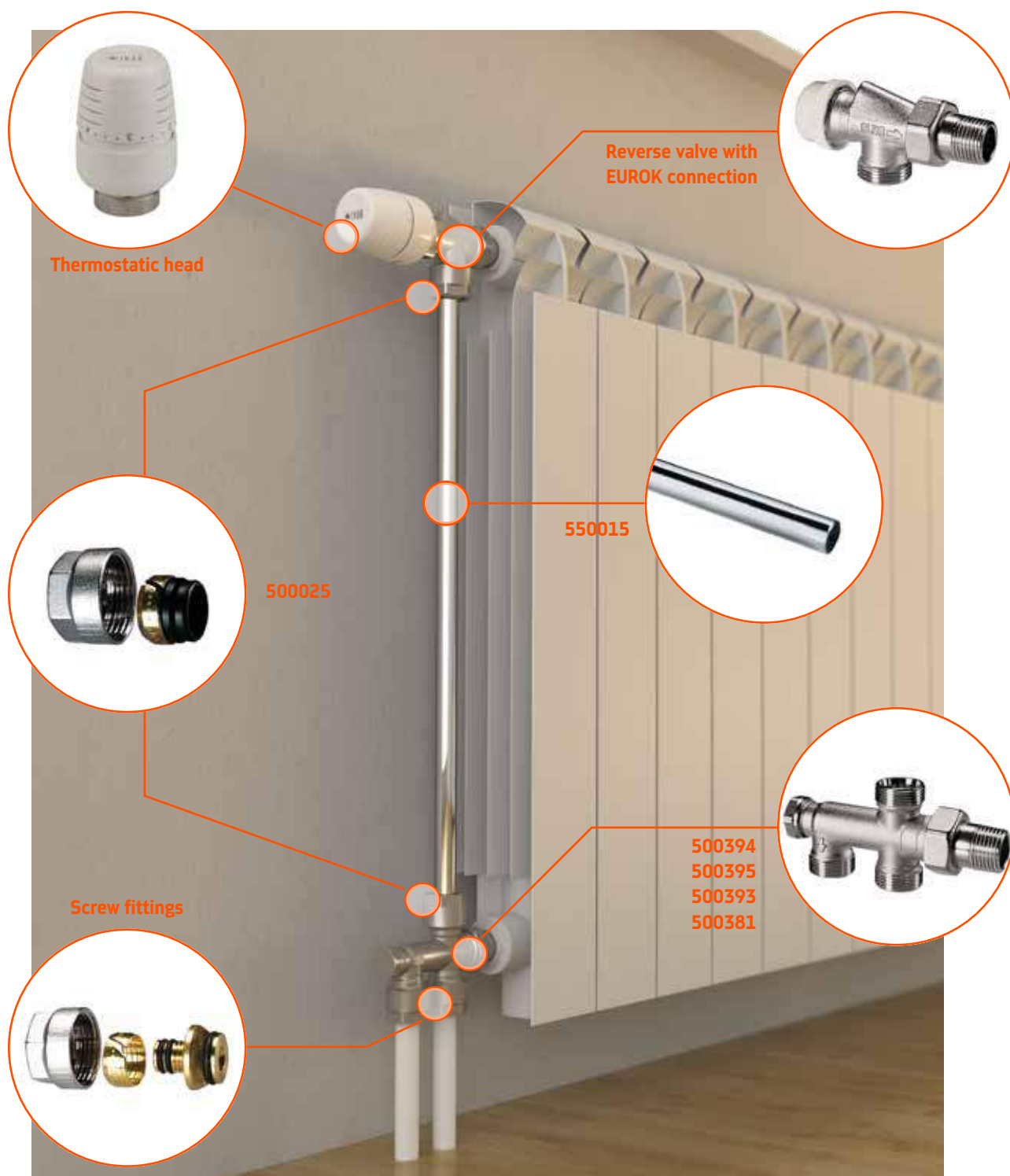

DM 1416

- Distributore a 4 vie con attacco maschio per impianti monotubo (portata 60%) con derivazioni a parete.
- 4-way distributor with male connection for single pipe systems (flow rate 60%) with wall pipes.
- Distributeur à 4 voies avec embout mâle pour systèmes monotube (débit 60%) avec dérivations murales.
- Einrohr 4-Wege-Anschlußgewinde Eckform (Durchfluss 60%) mit AG Anschlüssen.
- Distribuidor de 4 vías con conexión macho para sistemas monotubo (flujo 60%) con derivaciones de pared.

Code	Size	Price	Class	Packaging
500394	EUROK x 1/2" M	23,93 €	FA	8 / 64

DB 1406

- Distributore a 4 vie con attacco maschio per impianti bitubo (portata 100%) con derivazioni a parete.
- 4-way distributor with male connection for double pipe systems (flow rate 100%) with wall pipes.
- Distributeur à 4 voies avec embout mâle pour systèmes bitube (débit 100%) avec dérivations murales.
- Zweirohr 4-Wege-Anschlußgewinde Eckform (Durchfluss 100%) mit AG Anschlüssen.
- Distribuidor de 4 vías con conexión macho para sistemas bitubo (flujo 100%) con derivaciones de pared.

Code	Size	Price	Class	Packaging
500395	EUROK x 1/2" M	23,55 €	FA	8 / 64

DM 1415

- Distributore a 4 vie con attacco maschio per impianti monotubo (portata 60%) con derivazioni a pavimento.
- 4-way distributor with male connection for single pipe systems (flow rate 60%) with floor pipes.
- Distributeur à 4 voies avec embout mâle pour systèmes monotube (débit 60%) avec dérivations au sol.
- Einrohr 4-Wege-Anschlußgewinde Durchgangsform (Durchfluss 60%) mit AG Anschlüssen.
- Distribuidor de 4 vías con conexión macho para sistemas monotubo (flujo 60%) con derivaciones de suelo.

Code	Size	Price	Class	Packaging
500393	EUROK x 1/2" M	20,67 €	FA	10 / 80

DB 1405

- Distributore a 4 vie con attacco maschio per impianti bitubo (portata 100%) con derivazioni a pavimento.
- 4-way distributor with male connection for double pipe systems (flow rate 100%) with floor pipes.
- Distributeur à 4 voies avec embout mâle pour systèmes bitube (débit 100%) avec dérivations au sol.
- Zweirohr 4-Wege-Anschlußgewinde Durchgangsform (Durchfluss 100%) mit AG Anschlüssen.
- Distribuidor de 4 vías con conexión macho para sistemas bitubo (flujo 100%) con derivaciones de suelo.

Code	Size	Price	Class	Packaging
500381	EUROK x 1/2" M	20,43 €	FA	10 / 80

ADI 01

- Tubo cromato in acciaio dolce.
- Chrome-plated mild steel pipe.
- Tube chromé en acier doux.
- Verchromtes Weichstahl-Rohr.
- Tubo cromado de acero dulce.

Code	Size	Color	Price	Class	Packaging
550015	Ø 15	■	12,61 €	HA	80

TR 4430

- Raccordo EUROK per tubo rame ed acciaio dolce.
- EUROK fitting for copper and mild steel pipe.
- Raccord EUROK pour tube en cuivre et en acier doux.
- EUROK-Verschraubung für Kupferrohre und Weichstahlrohre.
- Conexión EUROK para tubo de cobre y acero dulce.

Code	Size	Color	Price	Class	Packaging
500998	EUROK x 10/1	■	3,282 €	JA	40 / 320
500157	EUROK x 12/1	■	2,712 €	JA	40 / 320
500024	EUROK x 14/1	■	2,671 €	JA	40 / 320
500025	EUROK x 15/1	■	2,671 €	JA	40 / 320
500026	EUROK x 16/1	■	2,671 €	JA	40 / 320

SINGLE-PIPE THERMOSTATIC VALVES

One-pipe systems were mainly used in the past. They consist of a single pipe that connects all radiators in a series, as shown in Fig. 1.

In practice, the radiators are not exactly in series, but each radiator takes a fraction of the flow rate of the loop while the rest passes directly from the flow to the return of the radiator through a bypass incorporated in the valve as shown in Fig. 2.

One-pipe thermostatic valves can be equipped with a manual knob, which can be used to completely isolate the radiator or adjust its supply level from 0% to 100%, with a very limited pressure drop. Equipped with thermostatic head, it can supply the radiator with a flow rate equal to 30% of the total flow rate of the circuit with a $\Delta = 2K$. The valve does not permit reverse flow (follow the arrow on the valve body). For correct use of the valve and better circulation of the fluid in the heating unit, it is advisable to extend the probe by fitting it to a pipe with an appropriate diameter, for a total length equal to that of the radiator minus 5-10 cm.

Materials

Body: nickel-plated brass CW617N

Seals and O-rings: peroxide EPDM

Technical specifications

Max. fluid temperature inside valve: 100 °C

Maximum operating pressure: 10 bar

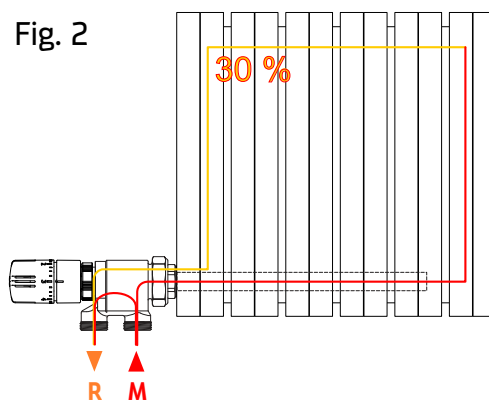
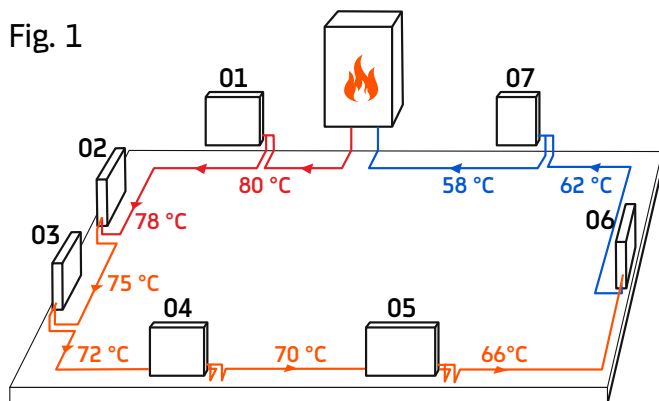

VM 1303 R



- Valvola monotubo termostattabile con attacco maschio.
- Single-pipe thermostatic valve with male connection.
- Robinet monotube thermostatisable avec embout mâle.
- Einrohr-Thermostatventil mit AG Anschluss.
- Válvula monotubo termostattabile con conexión macho.

Code	Size	Price	Class	Packaging
520172	1/2" x EUROK	37,89 €	GA	5 / 40
520173	3/4" x EUROK	37,89 €	GA	5 / 40



- Raccordo per tubo in rame >> p. 61,66,126,429
- Fitting for copper pipe >> p. 61,66,126,429
- Raccord pour tube en cuivre >> p. 61,66,126,429
- Verschraubung für Kupferrohr >> p. 61,66,126,429
- Conexión para tubo de cobre >> p. 61,66,126,429



- Raccordo per tubo multistrato >> p. 66,123,212,428
- Fitting for multilayer pipe >> p. 66,123,212,428
- Raccord pour tube multicouche >> p. 66,123,212,428
- Verschraubung für Verbundrohr >> p. 66,123,212,428
- Conexión para tubo multicapa >> p. 66,123,212,428



- Raccordo per tubo in polietilene >> p. 66,124,212,428
- Fitting for polyethylene pipe >> p. 66,124,212,428
- Raccord pour tube en polyéthylène >> p. 66,124,212,428
- Verschraubung für PEX-Rohr >> p. 66,124,212,428
- Conexión para tubo de polietileno >> p. 66,124,212,428

SINGLE-PIPE MANUAL VALVES

Manual single-pipe valves, as opposed to the thermostatic type, do not allow choking of the flow to the heating element:

- in the open position, all the ring flow passes through the radiator;
- in the closed position, the heating body is completely isolated and all the fluid is bypassed on return.

Flow input and output can be inverted with items VM 1405 and VM 1415.

Items VM 1505 and VM 1515 with external vertical feed allow the flow input to be changed using the appropriate probes contained in the kit.

Materials

Body: nickel-plated brass CW617N

Gaskets and O-rings: Peroxide EPDM

Technical characteristics

Max fluid temperature inside valve: 120°C

Maximum operating pressure: 10 bar

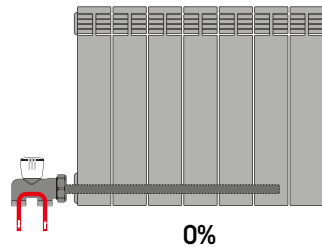

0%

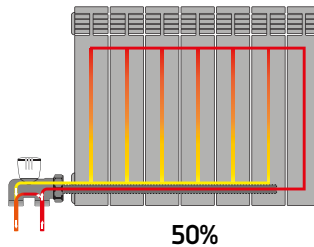

50%

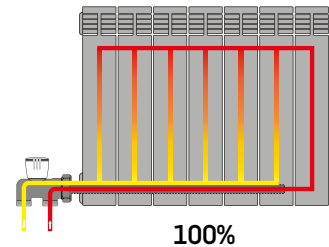

100%

VM 1405



- Valvola monotubo manuale a squadra con attacchi maschio.
- Single-pipe angle manual valve with male connections.
- Robinet monotube manuel équerre avec embouts mâle.
- Einrohr-Handbetätigungsventil Eckform mit AG AnschluÙe.
- Válvula monotubo manual de escuadra con conexiones macho.

Code	Size	Price	Class	Packaging
501613	1/2" x EUROK - Flow rate 100%	27,40 €	GC	5 / 40
501614	3/4" x EUROK - Flow rate 100%	27,40 €	GC	5 / 40
5016135	1/2" x EUROK - Flow rate 50%	31,08 €	GC	5 / 40
5016145	3/4" x EUROK - Flow rate 50%	31,08 €	GC	5 / 40

VM 1415



- Valvola monotubo manuale diritta con attacchi maschio.
- Single-pipe straight manual valve with male connections.
- Robinet monotube manuel droit avec embouts mâle.
- Einrohr-Handbetätigungsventil Durchgangform mit AG AnschluÙe.
- Válvula monotubo manual recta con conexiones macho.

Code	Size	Price	Class	Packaging
502442	1/2" x EUROK - Flow rate 100%	40,12 €	GC	4 / 32
502443	3/4" x EUROK - Flow rate 100%	40,12 €	GC	5 / 40

VM 1505



- Valvola monotubo manuale a squadra con convogliatore di flusso per tubo esterno e attacchi maschio.
- Single-pipe angle manual valve with flow conveyor for external pipe and male connections.
- Robinet monotube manuel équerre avec convoyeur de débit pour le tuyau externe et embouts mâle.
- Einrohr-Handbetätigungsventil Eckform mit Flussumstellung für Außenrohr und AG AnschluÙe.
- Válvula monotubo manual de escuadra con deflector de flujo para tubo exterior y conexión macho.

Code	Size	Price	Class	Packaging
501616	1/2" x EUROK - Flow rate 100%	39,08 €	GC	4 / 32
5016165	1/2" x EUROK - Flow rate 50%	42,14 €	GC	4 / 32

VM 1515



- Valvola monotubo manuale diritta con convogliatore di flusso per tubo esterno e attacchi maschio.
- Single-pipe straight manual valve with flow conveyor for external pipe and male connections.
- Robinet monotube manuel droit avec convoyeur de débit pour le tuyau externe et embouts mâle.
- Einrohr-Handbetätigungsventil Durchgangform mit Flussumstellung für Außenrohr und AG AnschluÙe.
- Válvula monotubo manual recta con deflector de flujo para tubo exterior y conexiones macho.

Code	Size	Price	Class	Packaging
502445	1/2" x EUROK - Flow rate 100%	52,55 €	GC	4 / 32



- Raccordo per tubo in rame >> p. 61,66,126,429
- Fitting for copper pipe >> p. 61,66,126,429
- Raccord pour tube en cuivre >> p. 61,66,126,429
- Verschraubung für Kupferrohr >> p. 61,66,126,429
- Conexión para tubo de cobre >> p. 61,66,126,429



- Raccordo per tubo multistrato >> p. 66,123,212,428
- Fitting for multilayer pipe >> p. 66,123,212,428
- Raccord pour tube multicouche >> p. 66,123,212,428
- Verschraubung für Verbundrohr >> p. 66,123,212,428
- Conexión para tubo multicapa >> p. 66,123,212,428



- Raccordo per tubo in polietilene >> p. 66,124,212,428
- Fitting for polyethylene pipe >> p. 66,124,212,428
- Raccord pour tube en polyéthylène >> p. 66,124,212,428
- Verschraubung für PEX-Rohr >> p. 66,124,212,428
- Conexión para tubo de polietileno >> p. 66,124,212,428

ACCESSORIES FOR SINGLE-PIPE VALVES

■ AVM 1326



- Bocchettone per valvole monotubo termostattizzabili e manuali.
- Fitting for thermostatic and manual single-pipe valves.
- Goulotte pour robinets monotube thermostatisables et manuels.
- Stutzen für Thermostat- und Handbetätigung-Einrohr-Ventile.
- Racor para válvulas monotubo termostatzables y manuales.

Code	Size	Price	Class	Packaging
506058	1/2"	5,37 €	GE	25 / 200
506059	3/4"	5,37 €	GE	20 / 80

■ AVM 1324



- Controsonda per valvole monotubo termostattizzabili.
- Counterprobe for single-pipe thermostatic valves.
- Contre-sonde pour robinets monotube thermostatisables.
- Gegensonde für Einrohr-Thermostatventile.
- Contra-sonda para válvulas monotubo termostatzables.

Code	Price	Class	Packaging
500161	0,606 €	GE	200

■ AVM 1325



- Prolunga per sonda per valvole monotubo termostattizzabili e manuali (montaggio esterno per valvole da 1/2"; montaggio interno per valvole da 3/4").
- Extension for probe for thermostatic and manual single-pipe valves (external installation for 1/2" valves; internal installation for 3/4" valves).
- Rallonge pour sonde pour robinets monotube thermostatisables et manuels (montage externe pour robinets 1/2» ; montage interne pour robinets 3/4»).
- Verlängerung für Sonde für Thermostat- und Handbetätigung-Einrohr-Ventile (Außenmontage für 1/2" Ventile; Innenmontage für 3/4" Ventile).
- Extención para la sonda para válvulas monotubo termostatzables y manuales (montaje externo para válvulas de 1/2"; montaje interno para válvulas de 3/4").

Code	Size	Price	Class	Packaging
500585	350 mm - Ø14,7 mm	2,492 €	GE	1

■ AVM 1328



- Sonda diritta per convogliatore di flusso.
- Straight probe for flow conveyor.
- Sonde droite pour convoyeur de débit.
- Sonde Durchgangsform für Flussumstellung.
- Sonda recta para deflector de flujo.

Code	Price	Class	Packaging
501623	0,664 €	GE	50 / 400

■ AVM 1321



- Sonda interna per valvole monotubo termostattizzabili e manuali.
- Internal probe for thermostatic and manual single-pipe valves.
- Sonde interne pour robinets monotube thermostatisables et manuels.
- Interne Sonde für Thermostat- und Handbetätigung-Einrohr-Ventile.
- Sonda interna para válvulas monotubo termostatzables y manuales.

Code	Size	Price	Class	Packaging
501301	1/2"	0,606 €	GE	50 / 400
501302	3/4"	0,854 €	GE	50 / 400

■ AVM 1327



- Controsonda per valvole monotubo manuali.
- Counterprobe for single-pipe manual valves.
- Contre-sonde pour robinets monotube manuels.
- Gegensonde für Einrohr-Handbetätigungventile.
- Contra-sonda para válvulas monotubo manuales.

Code	Price	Class	Packaging
501622	0,44 €	GE	50 / 400

■ AVM 1319



- Convogliatore di flusso con sonda diritta e a squadra per valvole monotubo manuali con tubo esterno.
- Flow conveyor with straight and angle probe for manual single-pipe valves with external pipe.
- Convoyeur de débit avec sonde droite et équerre pour robinets monotube manuels avec tuyau externe.
- Flussumstellung mit Sonde Durchgangsform und Eckform für manuelle Einrohr-Ventile mit Außenrohr.
- Deflector de flujo con sonda recta y de escuadra para válvulas monotubo manuales con tubo exterior.

Code	Size	Price	Class	Packaging
501677	1/2"	10,88 €	GE	25 / 200

■ AVM 1329



- Sonda a squadra per convogliatore di flusso.
- Angle probe for flow conveyor.
- Sonde équerre pour convoyeur de débit.
- Sonde Eckform für Flussumstellung.
- Sonda de escuadra para deflector de flujo.

Code	Price	Class	Packaging
501624	0,593 €	GE	50 / 400



FOCUS: AGE 15 telescopic fitting

After upgrades with replacement of valves and/or radiators, misalignments may arise, making a proper connection of the radiator to the system difficult, if not impossible. Using the AGE 15 telescopic ball fitting makes this issue easy to overcome. With extension of about 15 mm, critical situations can be recovered while ensuring an excellent aesthetic result. Available both in the soft-seal version, to be favoured in the case of new radiators, and in the version with tapered thread, recommended only for the replacement of valves.

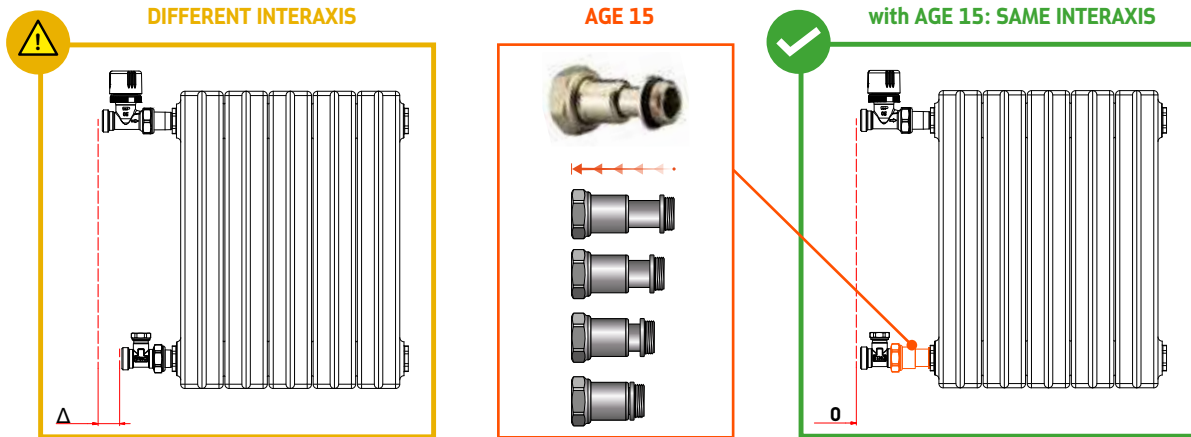

AGE 15



- Raccordo sferico allungabile.
- Extendible sphere fitting.
- Raccord sphérique extensible.
- Verlängerungsfähige kugelförmige Verbindung.
- Racor esférico extensible.

Code	Size	Color	Price	Class	Packaging
510197	3/8" (Length 38,8 - 53,8 mm)	■	14,28 €	HA	50 / 400
510198	1/2" (Length 39,8 - 54,8 mm)	■	13,99 €	HA	50 / 400
501425	1/2" O-ring (Length 36,8 - 51,8 mm)	■	13,76 €	HA	50 / 400

AGE 04



- Raccordo sferico ad angolo con tenuta o-ring.
- Spherical fitting elbow with o-ring seal.
- Raccord sphérique à angle avec étanchéité joint torique.
- Kugelverbinder mit O-Ring.
- Racor esférico en ángulo con junta o-ring.

Code	Size	Color	Price	Class	Packaging
501201	1/2"	■	7,14 €	HA	30 / 120

RR 701



- Raccordo diritto con dado girevole femmina - femmina.
- Straight female-female fitting with rotating nut.
- Raccord droit avec écrou pivotant femelle - femelle.
- Durchgang IG x IG Schraubverbinder mit drehbarer Mutter.
- Racor recto con tuerca giratoria hembra - hembra.

Code	Size	Color	Price	Class	Packaging
500632	1/2" F x EUROK	■	4,757 €	KA	30 / 240
500624	3/4" F x EUROK	■	6,51 €	KA	30 / 240
500632N	1/2" F x EUROK	■	4,995 €	KA	20 / 160
500624N	3/4" F x EUROK	■	6,72 €	KA	25 / 200

RR 4613



- Raccordo diritto maschio - femmina.
- Straight male-female fitting.
- Raccord droit mâle-femelle.
- Durchgang AG x IG Schraubverbinder.
- Racor recto macho - hembra.

Code	Size	Color	Price	Class	Packaging
500080	1/2" F x EUROK	■	2,893 €	KA	50 / 200
500174	3/4" F x EUROK	■	3,752 €	KA	40 / 160
500081	1/2" F x EUROK	■	2,972 €	KA	50 / 200
500175	3/4" F x EUROK	■	3,887 €	KA	40 / 160

Suitable fittings for valves and lockshields with EUROKONUS connection

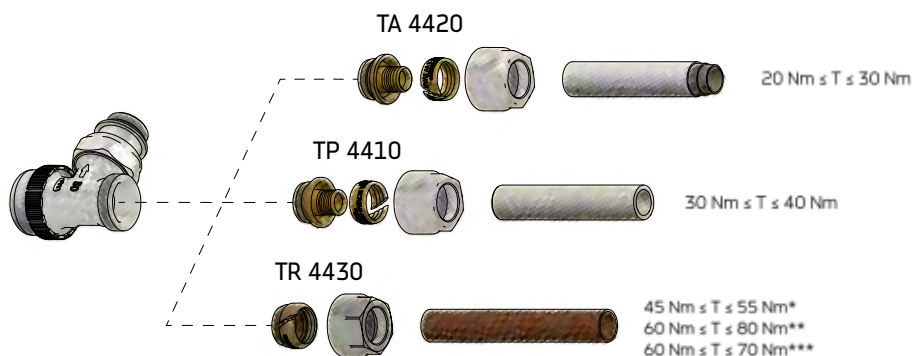

FOCUS: Fittings for multilayer and PEX pipe
See page 122.

- T = Coppia max. di serraggio. |*Rame ricotto. |**Rame semiduro. |***Acciaio dolce.
- T = Max. tightening torque. |*Soft copper. |**Semi-hard copper. |***Mild steel.
- T = Couple de serrage max. |*Cuivre recuit. |**Cuivre semi-rigide. |***Acier doux.
- T = Max. Anzugsdrehmoment. |*Geglühtes Kupfer. |**Mittelfestes Kupfer. |***Weichstahl.
- T = Par de apriete max. |*Cobre recocido. |**Cobre semiduro. |***Acero dulce.

■ TR 4430



- Raccordo EUROK per tubo rame ed acciaio dolce.
- EUROK fitting for copper and mild steel pipe.
- Raccord EUROK pour tube en cuivre et en acier doux.
- EUROK-Verschraubung für Kupferrohre und Weichstahlrohre.
- Conexión EUROK para tubo de cobre y acero dulce.

Code	Size	Color	Price	Class	Packaging
500998	EUROK x 10/1	■	3,282 €	JA	40 / 320
500157	EUROK x 12/1	■	2,712 €	JA	40 / 320
500024	EUROK x 14/1	■	2,671 €	JA	40 / 320
500025	EUROK x 15/1	■	2,671 €	JA	40 / 320
500026	EUROK x 16/1	■	2,671 €	JA	40 / 320

■ TR 4430-18



- Raccordo EUROK per tubo rame ed acciaio dolce.
- EUROK fitting for copper and mild steel pipe.
- Raccord EUROK pour tube en cuivre et en acier doux.
- EUROK-Verschraubung für Kupferrohre und Weichstahlrohre.
- Conexión EUROK para tubo de cobre y acero dulce.

Code	Size	Color	Price	Class	Packaging
500417	EUROK x 18/1	■	4,30 €	JA	40 / 320

■ TA 4420



- Raccordo EUROK per tubo multistrato e in polietilene.
- EUROK fitting for multilayer and polyethylene pipe.
- Raccord EUROK pour tube multicouches et en polyéthylène.
- EUROK-Verschraubung für Verbund- und für Polyäthylen-Rohr.
- Conexión EUROK para tubo multicapa y de polietileno.

Code	Size	Color	Price	Class	Packaging
506061	EUROK x 12/1,8	■	3,893 €	JA	40 / 320
500683	EUROK x 14/2	■	3,893 €	JA	40 / 320
500400	EUROK x 15/1,5	■	4,012 €	JA	40 / 320
500684	EUROK x 16/2	■	3,893 €	JA	40 / 320
500579	EUROK x 16/2,25	■	3,893 €	JA	40 / 320
506040	EUROK x 16,2/2,6	■	3,893 €	JA	40 / 320
500012	EUROK x 17/2	■	4,169 €	JA	40 / 320
500685	EUROK x 18/2	■	4,169 €	JA	40 / 320
500754	EUROK x 18/2,5	■	4,169 €	JA	40 / 320
500914	EUROK x 20/2	■	4,348 €	JA	40 / 320
500009	EUROK x 20/2,25	■	4,575 €	JA	40 / 320
501010	EUROK x 20/2,5	■	4,348 €	JA	40 / 320
506295	EUROK x 20/2,9	■	5,94 €	JA	40 / 320

■ TP 4410



- Raccordo EUROK per tubo in polietilene.
- EUROK fitting for polyethylene pipe.
- Raccord EUROK pour tube en polyéthylène.
- EUROK-Verschraubung für Polyäthylen-Rohr.
- Conexión EUROK para tubo de polietileno.

Code	Size	Color	Price	Class	Packaging
500590	EUROK x 12/1	■	3,673 €	JA	40 / 320
520041	EUROK x 12/2	■	3,673 €	JA	40 / 320
500679	EUROK x 14/2	■	3,593 €	JA	40 / 320
500148	EUROK x 15/1,7	■	3,893 €	JA	40 / 320
500769	EUROK x 15/2,5	■	3,737 €	JA	40 / 320
500591	EUROK x 16/1,5	■	3,51 €	JA	40 / 320
500680	EUROK x 16/2	■	3,51 €	JA	40 / 320
500681	EUROK x 16/2,2	■	3,51 €	JA	40 / 320
500682	EUROK x 17/2	■	3,737 €	JA	40 / 320
500145	EUROK x 18/1,8	■	3,737 €	JA	40 / 320
500650	EUROK x 18/2	■	4,169 €	JA	40 / 320
506020	EUROK x 18/2,5	■	3,737 €	JA	40 / 320
500651	EUROK x 20/2	■	4,169 €	JA	40 / 320
500649	EUROK x 20/2,8	■	4,025 €	JA	40 / 320
506200	EUROK x 20/3,4	■	4,025 €	JA	40 / 320
500753	EUROK x 21/2,5	■	4,528 €	JA	40 / 320

TR 401

- Raccordo per tubo rame ed acciaio dolce con ogiva ricotta.
- Fitting for copper and mild steel pipe with annealed ogive.
- Raccord pour tube en cuivre et en acier doux avec ogive recuite.
- Verschraubung für Kupferrohre und Weichstahlrohre mit geglühtem Klemmring.
- Conexión para tubo de cobre y acero dulce con ojiva recocida.

Code	Size	Color	Price	Class	Packaging
501047	G 1/2" x 15/1	■	2,06 €	JA	100 / 800

ADI 01

- Tubo cromato in acciaio dolce.
- Chrome-plated mild steel pipe.
- Tube chromé en acier doux.
- Verchromtes Weichstahl-Rohr.
- Tubo cromado de acero dulce.

Code	Size	Length	Color	Price	Class	Packaging
550015	Ø 15	1 m	■	12,61 €	HA	80

AVK 01

- Adattatore per serie OPTIMA, detentori serie VK e valvole H.
- Adapter for OPTIMA series, VK series lockshields and H valves.
- Adaptateur pour série OPTIMA, coudes et tés de réglage série VK et pièces H.
- Adapter für Serie OPTIMA, Absperungen der Serie VK und H-Ventile.
- Adaptador para serie OPTIMA, detentores serie VK y válvulas H

Code	Size	Color	Price	Class	Packaging
500770	EUROK x 1/2" M O-ring	■	1,996 €	EC	80 / 640

AGE 01 N

- Bocchettone a tenuta morbida.
- Soft seal fitting.
- Goulotte à étanchéité souple.
- Stutzen mit O-Ring.
- Manguito de unión con junta blanda.

Code	Size	Color	Price	Class	Packaging
506074	5/8" F x 3/8" M O-ring	■	4,058 €	HA	75 / 600
500106	3/4" F x 3/8" M O-ring	■	3,501 €	HA	50 / 400
501279	3/4" F x 1/2" M O-ring (short version)	■	3,501 €	HA	50 / 400
500605N	3/4" F x 1/2" M O-ring	■	3,678 €	HA	50 / 200
501215N	1" F x 3/4" M O-ring	■	6,77 €	HA	35 / 140
506032N	1" F x 1" M O-ring	■	7,35 €	HA	20 / 160
506060N	1" F TP x 1" M O-ring	■	7,77 €	HA	20 / 160
501214N	1" 1/4 F x 1" M O-ring	■	8,36 €	HA	20 / 80
501219	1" 1/2 F x 1" 1/4 M O-ring	■	18,69 €	HA	10 / 80

TR 402

- Raccordo per tubo rame ed acciaio dolce con ogiva e o-ring.
- Fitting for copper and mild steel with ogive and o-ring.
- Raccord pour tube en cuivre et en acier doux avec ogive et joint torique.
- Verschraubung für Kupferrohre und Weichstahlrohre mit Klemmring und O-Ring.
- Conexión para tubo de cobre y acero dulce con ojiva y o-ring.

Code	Size	Color	Price	Class	Packaging
501009	G 1/2" x 15/1	■	2,192 €	JA	100 / 800

AGE 10

- Raccordo ad angolo con tenuta morbida per collegamento radiatore.
- Angle fitting with soft seal for radiator connection.
- Raccord à angle avec étanchéité souple pour raccordement radiateur.
- Winkelverbinder mit O-Ring für Verbindung zum Heizkörper.
- Racor en ángulo con junta blanda para conexión al radiador.

Code	Size	Color	Price	Class	Packaging
500069	1/2" M x 1/2" M	■	6,69 €	HA	30 / 240

AGE 11

- Adattatore sede tenuta conica / tenuta piana.
- Tapered seal / flat seal seat adaptor.
- Adaptateur siège joint conique / joint plat.
- Sitzzwischenstück konisch Dichtung / Flachdichtung.
- Adaptador junta cónica / junta plana.

Code	Size	Color	Price	Class	Packaging
500201	EUROK	■	1,376 €	HA	150 / 600

AGE 16

- Kit dado e bocchettone.
- Kit nut and fitting.
- Kit écrou et raccord.
- Kit Mutter und Anschluss-Stutzen.
- Conjunto tuerca y manguito de unión.

Code	Size	Color	Price	Class	Packaging
506201	5/8" F x 3/8" M	■	3,277 €	HA	75 / 600
506076	3/4" F x 3/8" M	■	3,417 €	HA	75 / 600
506202	3/4" F x 1/2" M	■	3,334 €	HA	75 / 600
506203	1" F x 3/4" M	■	6,64 €	HA	35 / 280

ACCESSORIES AND SPARE PARTS

AGE 09



- Cappuccio di protezione per vitone termostatico.
- Protection cap for thermostatic insert.
- Capuchon de protection pour insert thermostatique.
- Schutzkappe für Thermostat-Regulievorrichtung.
- Tapa de protección para tornillo termostático.

Code	Color	Price	Class	Packaging
501278	<input type="checkbox"/>	0,463 €	HA	50 / 400

AGE 09 N



- Cappuccio di protezione per vitone termostatico.
- Protection cap for thermostatic insert.
- Capuchon de protection pour insert thermostatique.
- Schutzkappe für Thermostat-Regulievorrichtung.
- Tapa de protección para tornillo termostático.

Code	Color	Price	Class	Packaging
501278DRN	<input checked="" type="checkbox"/>	0,463 €	HA	50 / 400

AGE 09 NH



- Cappuccio di protezione per vitone termostatico.
- Protection cap for thermostatic insert.
- Capuchon de protection pour insert thermostatique.
- Schutzkappe für Thermostat-Regulievorrichtung.
- Tapa de protección para tornillo termostático.

Code	Color	Price	Class	Packaging
501278NH	<input checked="" type="checkbox"/>	0,463 €	HA	50 / 400

TM 3052



- Testa manuale in plastica con ghiera in ottone.
- Plastic manual head with brass ring.
- Tête manuelle en plastique avec bague en laiton.
- Kunststoff manueller Hebel mit Messing Rändelmutter.
- Cabeza manual de plástico con rosca de latón.

Code	Size	Color	Price	Class	Packaging
500047	M30 x 1,5	<input type="checkbox"/>	2,718 €	AD	400

AGE 05



- Tappo con guarnizione per collettori con detentori a doppia regolazione micrometrica.
- Plug with gasket for manifolds with double-micrometric-adjustment lockshields.
- Bouchon avec joint pour collecteurs avec inserts à double réglage micrométrique.
- Verschluss mit Dichtung für Verteiler mit doppelfeinvorein Stellbaren Rücklaufverschraubungen.
- Tapón con junta para colectores con detentores de doble regulación micrométrica.

Code	Color	Price	Class	Packaging
500056	<input checked="" type="checkbox"/>	0,878 €	HA	200 / 1600

VTT 02



- Vitone termostatico.
- Thermostatic insert.
- Insert thermostatique.
- Thermostat-Regulievorrichtung.
- Tornillo termostático.

Code	Price	Class	Packaging
500543	5,54 €	BG	100 / 800

VTT 03



- Vitone termostatico con selettore di portata.
- Thermostatic insert with flow rate selector.
- Insert thermostatique avec sélecteur de débit.
- Thermostat- Einsatz mit Durchfluss-Wählschalter.
- Tornillo termostático con selector de flujo.

Code	Range	Price	Class	Packaging
500544	KV 0,1 - 0,6 (N SERIES)	6,49 €	BG	50 / 400

AVT 02



- Ghiera per vitone termostatico.
- Ring nut for thermostatic insert.
- Bague filetée pour insert thermostatique.
- Ring für Thermostat-Regulievorrichtung.
- Anillo para el tornillo termostático.

Code	Price	Class	Packaging
553003	1,484 €	BG	200 / 1600

TM 3053



- Testa manuale in plastica.
- Plastic manual head.
- Tête manuelle en plastique.
- Kunststoff manueller Hebel.
- Cabezal manual.

Code	Size	Color	Price	Class	Packaging
500046	M30 x 1,5	<input type="checkbox"/>	1,555 €	AD	25 / 200

AGE 09 D



- Cappuccio per detentori serie pesante.
- Cap for lockshields heavy series.
- Capuchon pour tés/coudes de réglage série lourde.
- Schutzkappe für Rücklaufventile schwere Serie.
- Capuchón de protección para detentores serie pesada.

Code	Color	Price	Class	Packaging
501278D	<input type="checkbox"/>	0,463 €	HA	50

AGE 06

- **Mostrina doppia in ABS (in 2 pezzi).**
- *ABS double plate (in 2 pieces).*
- **Rosace double en ABS (en 2 pièces).**
- *Doppelte Abdeckmanschette aus ABS (in 2 Stücke).*
- **Plafón embellecedor doble de ABS (en 2 piezas).**

Code	Size	OC distance	Color	Price	Class	Packaging
501308	Ø15	38 mm	<input type="checkbox"/>	0,867 €	HA	400
500109	Ø15	50 mm	<input type="checkbox"/>	1,139 €	HA	500

AGE 07

- **Mostrina singola in ABS (in 2 pezzi).**
- *ABS single plastic plate (in 2 pieces).*
- **Rosace single en ABS (en 2 pièces).**
- *Einzelne Abdeckmanschette aus ABS (in 2 Stücke).*
- **Embellecedor simple de ABS (en dos piezas).**

Code	Size	Color	Price	Class	Packaging
500110	Ø15	<input type="checkbox"/>	1,092 €	HA	1100

AC 651

- **Valvola di sfiato aria automatica per radiatori.**
- *Automatic air valve for radiators.*
- **Purgeur d'air automatique pour les radiateurs.**
- *Automatisches Entlüftungsventil für Heizkörper.*
- **Válvula purgadora automática para radiadores.**

Code	Size	Price	Class	Packaging
506251DX	1" - RIGHT	9,38 €	HA	20 / 160
506251SX	1" - LEFT	9,38 €	HA	20 / 160
506252DX	1"1/4 - RIGHT	12,11 €	HA	120
506252SX	1"1/4 - LEFT	12,11 €	HA	120

AC 625 M

- **Valvola manuale di sfiato.**
- *Manual air vent valve.*
- **Purgeur d'air manuel.**
- *Manuelles Entlüftungsventil.*
- **Válvula purgadora manual.**

Code	Size	Price	Class	Packaging
500954M	1/4"	2,112 €	HA	100 / 400
500675M	3/8"	2,204 €	HA	100 / 400
500674M	1/2"	2,938 €	HA	100 / 400

AGE 14

- **Prolunga per attacco valvole.**
- *Extension for valves connection.*
- **Rallonge pour l'embout des robinets.**
- *Verlängerung für Ventilanschluß.*
- **Extensión para la conexión de las válvulas.**

Code	Size	Price	Class	Packaging
501424	3/4" F TP x EUROK - 13,5 mm	5,09 €	HA	40 / 320
501964	3/4" F TP x EUROK - 18,5 mm	5,51 €	HA	40 / 320
501965	3/4" F TP x EUROK - 23,5 mm	6,06 €	HA	40 / 320

AGE 17

- **Adattatore teste termostatiche / valvole DANFOSS.**
- *Thermostatic heads / DANFOSS valves adapter.*
- **Adaptateur têtes thermostatiques / robinets DANFOSS.**
- *Adapter für Thermostatköpfe / Ventile DANFOSS.*
- **Adaptador cabezas termostáticas / válvulas DANFOSS.**

Code	Price	Class	Packaging
560001	16,95 €	VE	40 / 320

FAN-COIL VALVES

VFC valves, available in two-way and three-way versions (4 ports), are used to control the flow of hot and cold water in heating and air conditioning systems with fan-coil terminals.

The valve is a normally open type, i.e., without the actuator mounted, the straight way supply to the user component is open.

Flow control is performed by mounting an electrothermic actuator that can be either normally closed or normally open. The operation for this type of valve is normally ON/OFF.

These valves can be mounted on either the flow or the return side, even though the return-side is preferable for less critical temperature conditions for both heating and cooling. However, to avoid leaks and noises from the system, it is important not to exceed the maximum differential pressure at the ends of the valve.

The two-way version completely cuts off the heating fluid flow and should therefore to be used with high efficiency circulation systems.

The three-way version with 4 ports can be mounted either as a bypass as in Fig. 1 (one inlet and two outlets) or for mixing as in Fig. 2 (2 inlets and one outlet). Closing the straight supply way takes the flow through the bypass, resulting in a continuous recirculation of the fluid.

Materials

Body: brass CW617N

Seals and O-rings: peroxide EPDM

Technical specifications

Max. fluid temperature inside valve: 120 °C

Maximum operating pressure: 10 bar

Max. permissible pressure differential with fitted electro-thermal head: 1.5 bar

Operating mode: on/off

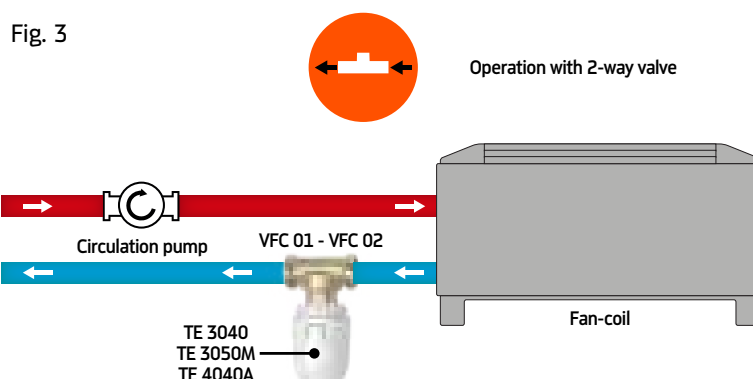
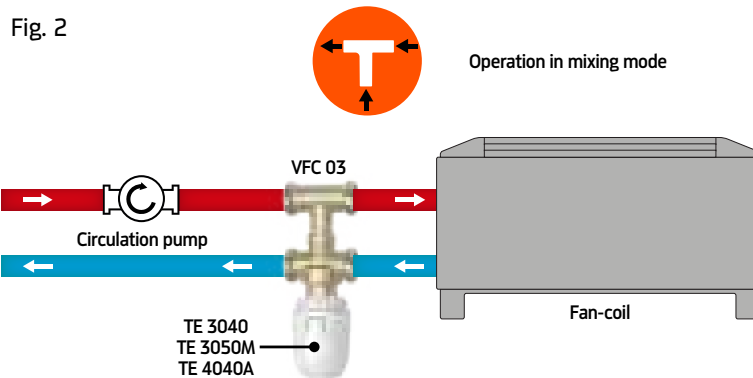
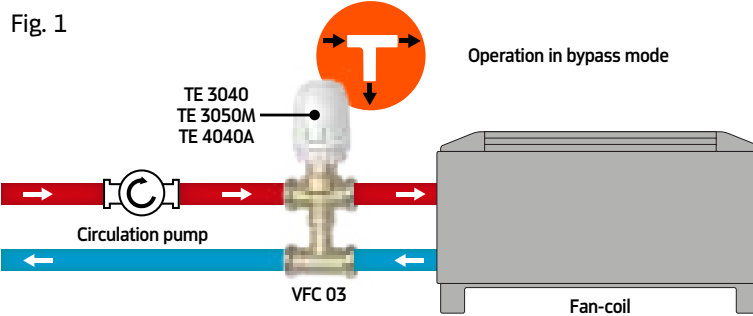

VFC 01

- **Valvola per fan-coil a 2 vie.**
- *2-way fan-coil valve.*
- **Vanne à 2 voies pour fan-coil.**
- *2-Wege Ventil für Ventilator-konvektoren.*
- **Válvula de 2 vías para fan-coil.**

Code	Kv	Size	Color	Price	Class	Packaging
570200	0.25	1/2" M		19,87 €	BL	10 / 80
570201	0.40	1/2" M		19,87 €	BL	10 / 80
570202	0.63	1/2" M		19,87 €	BL	10 / 80
570203	1.00	1/2" M		19,87 €	BL	10 / 80
570204	1.60	1/2" M		19,87 €	BL	10 / 80
506356	2.10	1/2" M		19,87 €	BL	10 / 80
570210	0.25	3/4" M		22,16 €	BL	10 / 80
570211	0.40	3/4" M		22,16 €	BL	10 / 80
570212	0.63	3/4" M		22,16 €	BL	10 / 80
570213	1.00	3/4" M		22,16 €	BL	10 / 80
570214	1.60	3/4" M		22,16 €	BL	10 / 80

VFC 02

- **Valvola per fan-coil a 2 vie per elevate portate.**
- *2-way fan-coil valve for high flow capacity.*
- **Vanne à 2 voies pour fan-coil pour débit élevé.**
- *2-Wege Ventil für Ventilator-konvektoren für erhöhte Durchfluss.*
- **Válvula de 2 vías para fan-coil para caudales elevados.**

Code	Kv	Size	Color	Price	Class	Packaging
570220	2.50	3/4" M		25,00 €	BL	10 / 80
570221	4.00	3/4" M		25,94 €	BL	10 / 80
570216	4.50	3/4" M		26,20 €	BL	10 / 80

VFC 03

- **Valvola per fan-coil a 3 vie.**
- *3-way fan-coil valve.*
- **Vanne à 3 voies pour fan-coil.**
- *3-Wege Ventil für Ventilator-konvektoren.*
- **Válvula de 3 vías para fan-coil.**

Code	Kv	Size	OC distance	Color	Price	Class	Packaging
570205	0.25	1/2" M	40 mm		26,97 €	BL	10 / 80
570206	0.40	1/2" M	40 mm		26,97 €	BL	10 / 80
570207	0.63	1/2" M	40 mm		26,97 €	BL	10 / 80
570208	1.00	1/2" M	40 mm		26,97 €	BL	10 / 80
570209	1.60	1/2" M	40 mm		26,97 €	BL	10 / 80
506098	2.50	3/4" M	50 mm		26,49 €	BL	5 / 40



- **Teste elettrotermiche >>p. 220,360,397,477,488**
- **Electrothermal heads >>p. 220,360,397,477,488**
- **Têtes électrothermiques >>p. 220,360,397,477,488**
- **Elektrothermische Stellantriebe >>p. 220,360,397,477,488**
- **Cabezas electotérmicas >>p. 220,360,397,477,488**

FAN-COIL UNIT KIT

Fan-Coil Unit Kit is a pre-assembled multifunction bypass unit designed for plant situations that require a constant flow of heat transfer fluid, such as fan-coils, cold beams, radiant strip heaters and other ceiling conditioning systems. The flow control is entrusted to a PICV (Pressure Independent Control Valve) dynamic balancing valve.

Fan-Coil Unit Kit connects the delivery and return pipes to the terminal units and integrates the following accessories, necessary for correct operation and maintenance of the system:

- three-way valves
- two loading/unloading taps
- mesh filter
- PICV
- piezometric connections
- Venturi orifice for flow measurement.

The position of the ball valves allows up to five operating modes and allows isolating the primary circuit (system side) from the secondary circuit (serving the individual terminal units). In this way it is easy to clean the mesh strainer, replace a terminal unit or perform the flushing, washing and cleaning of the primary circuit (without these operations affecting the terminal unit).

Materials

Body: brass CW617N

Strainer mesh: AISI 304 stainless steel

Insulation: ARPRO 4135 FR

Technical specifications

Compatible fluids: water or glycol solution (max. 50%)

Permissible pressure differential range (PICV): 16-200 kPa; 30-400 kPa

Flow rate regulation range (PICV): 37-575 l/h; 64-1110 l/h

Maximum operating pressure: 10 bar

Maximum operating temperature: 120 °C

Mesh strainer: 500 µm

Available Venturi orifice Kv: 0.307; 0.477; 1.15; 2.15; 3.66; 4.27

Connections to primary circuit: 1/2" F (DN 15) - 3/4" F (DN 20) with rotary inlet ports

Connections to secondary circuit: 3/4" M

Dimensions with insulation casing W x H x D: 250 x 330 x 110 mm

Insulation density: 40 g/l

Insulation conductivity: 0.037 W/mK

Insulation fire reaction class (standard UL-94): HF-1 Class

PLUS

- **Compact and pre-assembled for an easy and quick installation**
- **Multifunction: 5 operating and maintenance modes**
- **Simplified system maintenance**
- **Flow control via PICV**
- **Flow measurement and precise balancing thanks to the Venturi orifice and piezometric connections**

Applications

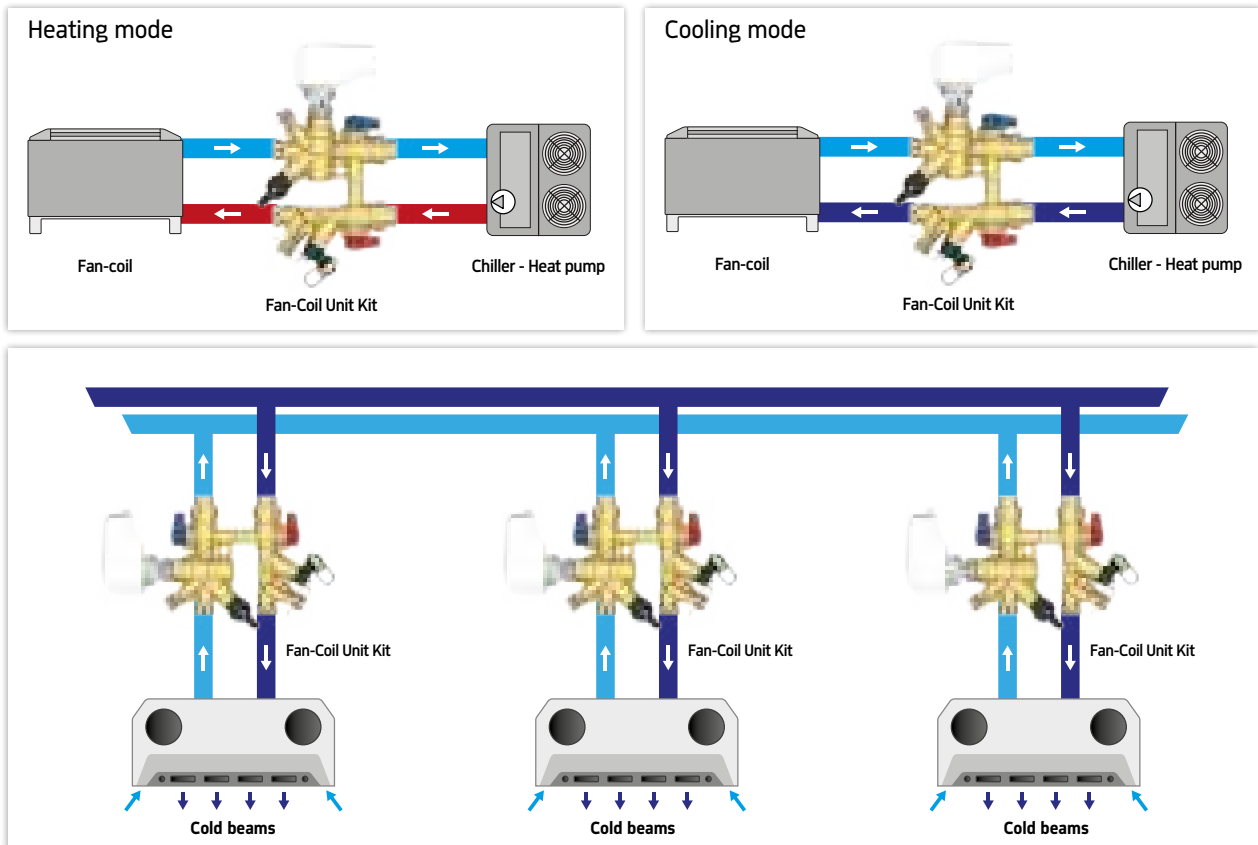

5 operating modes

- 1**

Supply to the terminal unit
The valves are both open, the bypass branch of the system is closed. Water flows into the terminal unit.
- 2**

Insulation of the terminal unit and flushing of the primary circuit.
Both valves are closed, the bypass branch of the system is open. The water from the primary circuit recirculates into the bypass branch.
This configuration is used to clean the primary circuit, avoiding possible contamination of the water on the terminal unit side.
- 3**

Washing the terminal unit with water from the primary circuit - PICV cartridge not mounted.
System supply valve is open, return valve is closed. The bypass branch is closed.
Disconnect the PICV cartridge from the system to prevent clogging.
This configuration allows water from the main circuit (containing the cleaning fluid) to circulate through the terminal unit. The water is discharged from the drain valve of the return branch of the system.
- 4**

Direct washing of the mesh filter.
The supply valve of the system is open, the return valve is closed. The bypass branch is closed.
This configuration allows water from the main circuit to circulate through the mesh filter. The filter is deprived of residual impurities and the water is discharged from the discharge tap of the system's delivery branch.
- 5**

Insulation of the terminal unit for maintenance and cleaning - PICV cartridge not mounted.
The valves are both closed, the bypass branch of the system is open. Primary circuit water recirculates into the bypass branch.
Disconnect the PICV cartridge from the system to prevent it from clogging up.
This configuration isolates the terminal unit. This allows maintenance of the terminal unit side system. The circuit section can be cleaned with the loading and unloading taps open, by circulating an external cleaning fluid.
The circulator of the primary circuit stops, to avoid the movement of water not required by the system at this stage.

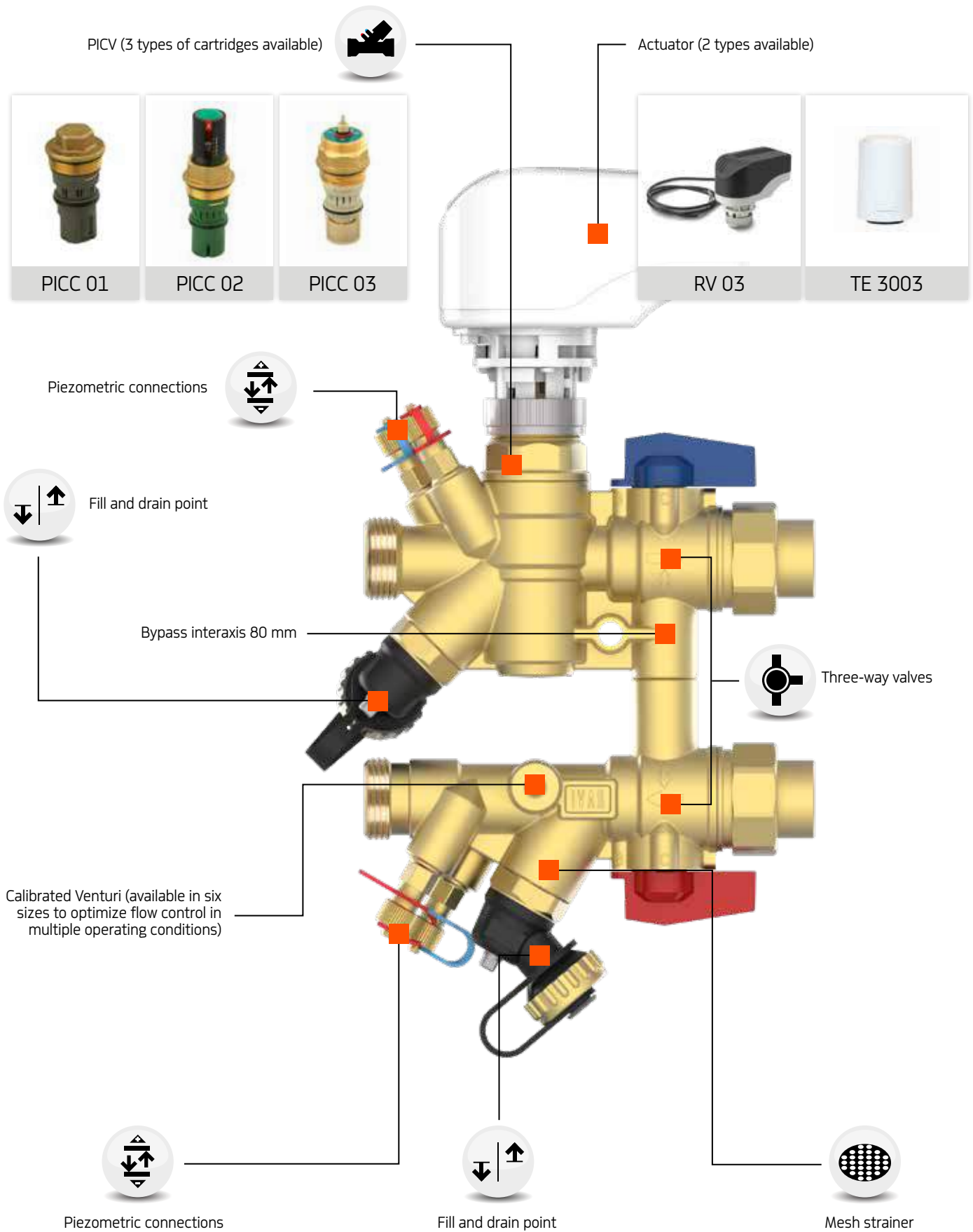

FCU-KIT 00

- **Gruppo di bypass multifunzione preassemblato completo di coppia di valvole a 3 vie, filtro a maglie, rubinetti di carico/scarico, orificio Venturi con coppia di prese piezometriche e regolatore di portata PICV.**
- *Pre-assembled multifunction bypass unit complete with pair of 3-way valves, mesh strainer, fill/drain taps, Venturi orifice with pair of piezometric ports and PICV flow regulator.*
- **Unité de bypass multifonctions pré-assemblée avec paire de vannes à 3 voies, filtre en maille, vannes de remplissage / vidange, orifice Venturi avec paire de manchons piézométriques et régulateur de débit PICV.**
- *Vormontierte multifunktionsfähige Bypass-Gruppe, komplett mit paarweisem 3-Wege-Ventil, Maschenfilter, Befüll-/Ablasshähne, Venturi-Düse mit paarweisem Druckmessanschluss und PICV-Volumenstromregler.*
- **Grupo de bypass multifunción premontado dotado de un par de válvulas de 3 vías, filtro de mallas, grifos de carga/descarga, orificio Venturi con un par de tomas piezométricas y regulador de caudal PICV.**

Code	Size	Insulation	Price	Class	Packaging
52014503	1/2" F - Venturi Ø3	-	236,52 €	BL	1
52014504	1/2" F - Venturi Ø4	-	236,52 €	BL	1
52014506	1/2" F - Venturi Ø6	-	236,52 €	BL	1
52014508	1/2" F - Venturi Ø8	-	236,52 €	BL	1
52014510	1/2" F - Venturi Ø10	-	236,52 €	BL	1
52014511	1/2" F - Venturi Ø11	-	236,52 €	BL	1
52014503I	1/2" F - Venturi Ø3	✓	290,58 €	BL	1
52014504I	1/2" F - Venturi Ø4	✓	290,58 €	BL	1
52014506I	1/2" F - Venturi Ø6	✓	290,58 €	BL	1
52014508I	1/2" F - Venturi Ø8	✓	290,58 €	BL	1
52014510I	1/2" F - Venturi Ø10	✓	290,58 €	BL	1
52014511I	1/2" F - Venturi Ø11	✓	290,58 €	BL	1
52014603	3/4" F - Venturi Ø3	-	239,22 €	BL	1
52014604	3/4" F - Venturi Ø4	-	239,22 €	BL	1
52014606	3/4" F - Venturi Ø6	-	239,22 €	BL	1
52014608	3/4" F - Venturi Ø8	-	239,22 €	BL	1
52014610	3/4" F - Venturi Ø10	-	239,22 €	BL	1
52014611	3/4" F - Venturi Ø11	-	239,22 €	BL	1
52014603I	3/4" F - Venturi Ø3	✓	293,28 €	BL	1
52014604I	3/4" F - Venturi Ø4	✓	293,28 €	BL	1
52014606I	3/4" F - Venturi Ø6	✓	293,28 €	BL	1
52014608I	3/4" F - Venturi Ø8	✓	293,28 €	BL	1
52014610I	3/4" F - Venturi Ø10	✓	293,28 €	BL	1
52014611I	3/4" F - Venturi Ø11	✓	293,28 €	BL	1

FCU-KIT 01



- Gruppo di bypass multifunzione preassemblato completo di coppia di valvole a 3 vie, filtro a maglie, rubinetti di carico/scarico e orifizio Venturi con coppia di prese piezometriche.
- Pre-assembled multifunction bypass unit complete with pair of 3-way valves, mesh strainer, fill/drain taps and Venturi orifice with pair of piezometric ports.
- Unité de bypass multifonctions pré-assemblée avec paire de vannes à 3 voies, filtre en maille, vannes de remplissage / vidange et orifice Venturi avec paire de manchons piézométriques.
- Vormontierte multifunktionsfähige Bypass-Gruppe, komplett mit paarweisem 3-Wege-Ventil, Maschenfilter, Befüll-/Ablasshähne und Venturi-Düse mit paarweisem Druckmessanschluss.
- Grupo de bypass multifunción premontado dotado de un par de válvulas de 3 vías, filtro de mallas, grifos de carga/descarga y orificio Venturi con un par de tomas piezométricas.

Code	Size	Price	Class	Packaging
52014703	1/2" F - Venturi Ø3	167,58 €	BL	1
52014704	1/2" F - Venturi Ø4	167,58 €	BL	1
52014706	1/2" F - Venturi Ø6	167,58 €	BL	1
52014708	1/2" F - Venturi Ø8	167,58 €	BL	1
52014710	1/2" F - Venturi Ø10	167,58 €	BL	1
52014711	1/2" F - Venturi Ø11	167,58 €	BL	1
52014803	3/4" F - Venturi Ø3	170,29 €	BL	1
52014804	3/4" F - Venturi Ø4	170,29 €	BL	1
52014806	3/4" F - Venturi Ø6	170,29 €	BL	1
52014808	3/4" F - Venturi Ø8	170,29 €	BL	1
52014810	3/4" F - Venturi Ø10	170,29 €	BL	1
52014811	3/4" F - Venturi Ø11	170,29 €	BL	1

PICV 00 FCU



- Corpo valvola di bilanciamento dinamico, completo di prese piezometriche e scarico. Connessioni maschio - femmina.
- Dynamic balancing valve body, complete with piezometric ports and drain. Male - female connections.
- Corps de vanne à équilibrage dynamique, complet avec douilles piézométriques et échappement. Connexions mâle - femelle.
- Körper dynamisches Abgleichventil, komplett mit Piezometeranschlüsse und Entladeventil. AG - IG Anschlüsse
- Cuerpo de la válvula de equilibrio dinámico, dotado de tomas piezométricas y descarga. Conexiones macho - hembra.

Code	Size	Color	Price	Class	Packaging
520149	3/4" M x 3/4" F		71,64 €	BL	5 / 40



- Cartuccia PICC 01 >> p. 373
- Cartridge PICC 01 >> p. 373
- Cartouche PICC 01 >> p. 373
- Einsatz PICC 01 >> p. 373
- Cartucho PICC 01 >> p. 373



- Cartuccia PICC 02 >> p. 373
- Cartridge PICC 02 >> p. 373
- Cartouche PICC 02 >> p. 373
- Einsatz PICC 02 >> p. 373
- Cartucho PICC 02 >> p. 373



- Cartuccia PICC 03 >> p. 373
- Cartridge PICC 03 >> p. 373
- Cartouche PICC 03 >> p. 373
- Einsatz PICC 03 >> p. 373
- Cartucho PICC 03 >> p. 373

PIPES AND FITTINGS

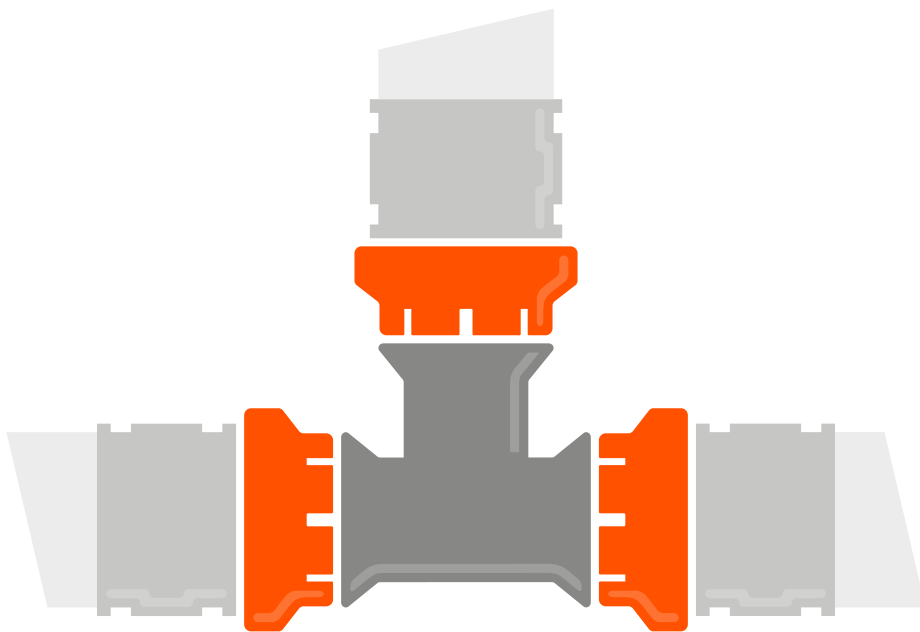

pim.ivar-group.com/short/IT-02

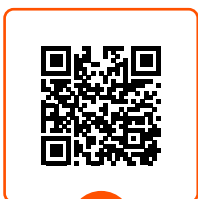

DOWNLOAD
Focus tecnici



pim.ivar-group.com/short/FR-02



DOWNLOAD
Détails techniques



pim.ivar-group.com/short/DE-02

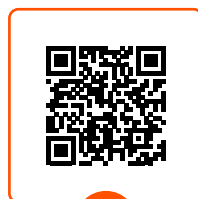

DOWNLOAD
Technische Details



pim.ivar-group.com/short/ES-02

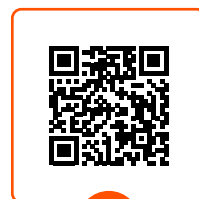

DOWNLOAD
Profundizaciones técnicas

	Tubazioni <i>Pipes</i> Tuyaux <i>Rohre</i> Tuberías	80
	Raccordi a pressione M•P <i>Press fittings M•P</i> Raccords à presser M•P <i>Press Fittings M•P</i> Accesorios a presar M•P	88
	Raccordi a pressione P•M•P <i>Press fittings P•M•P</i> Raccords à presser P•M•P <i>Press Fittings P•M•P</i> Accesorios a presar P•M•P	101
	Raccordi a pressione con perdita M•P•L <i>Press fittings with leakage function M•P•L</i> Raccords à presser avec perte M•P•L <i>Press Fittings mit unverpresst undicht Funktion M•P•L</i> Accesorios a presar con pérdida M•P•L	104
	Raccordi a pressione con perdita P•M•P•L <i>Press fittings with leakage function P•M•P•L</i> Raccords à presser avec perte P•M•P•L <i>Press Fittings mit unverpresst undicht Funktion P•M•P•L</i> Accesorios a presar con pérdida P•M•P•L	113
	Accessori e parti di ricambio per raccordi a pressione M•P / M•P•L <i>Accessories and spare parts for press fittings M•P / M•P•L</i> Accessoires et pièces de rechange pour raccords à presser M•P / M•P•L <i>Zubehör und Ersatzteile für Press Fittings M•P / M•P•L</i> Accesorios y repuestos para accesorios a presar M•P / M•P•L	116
	Raccorderia di base <i>Basic fittings</i> Raccords de base <i>Schraubverbinder</i> Accesorios básicos	117
	Raccorderia a stringere <i>Screw fittings</i> Raccords à serrer <i>Klemmverschraubungen</i> Accesorios de compresión	122
	Raccorderia per la distribuzione sottotraccia <i>Fittings for under-floor distribution systems</i> Raccords pour la distribution à encastrer <i>Verbinder für die Unterputzverteilung</i> Cajas de distribución empotrable	127
	Utensili e accessori generali <i>Tools and general accessories</i> Outils et accessoires généraux <i>Werkzeuge und Allgemeines Zubehör</i> Herramientas y accesorios en general	130



PIPES

MULTILAYER

Multilayer pipes have five different layers:

1. polymer (inner layer)
2. adhesive
3. aluminium alloy (middle layer)
4. adhesive
5. polymer (outer layer)

Given the composite nature of the material, they **perfectly combine the advantages of plastic pipe with those of a metal pipe.**

Advantages of plastic piping:

- light weight
- flexibility
- low surface roughness
- high resistance to corrosion and chlorinated water

Advantages of metal piping:

- high mechanical resistance
- holds bends
- completely impermeable to oxygen and light.

Multilayer pipes are very versatile and are primarily used in domestic water distribution, low and high temperature heating and compressed air distribution systems. The reference standard for these pipes, EN ISO 21003, provides for different usage classes, which define the operating conditions, in terms of design temperatures and pressures to which they will be subjected in their service life.

The polymer that makes up the inner and outer layers can be different. Typically they are combinations of PE-X and HDPE, with the latter never left in contact with the fluid, so it never makes up the inner layer of the pipe.

To define its range of multilayer pipes, IVAR has selected top quality suppliers, with pipes made in Italy (IVAR brand) and in Germany (Fraenkische brand).

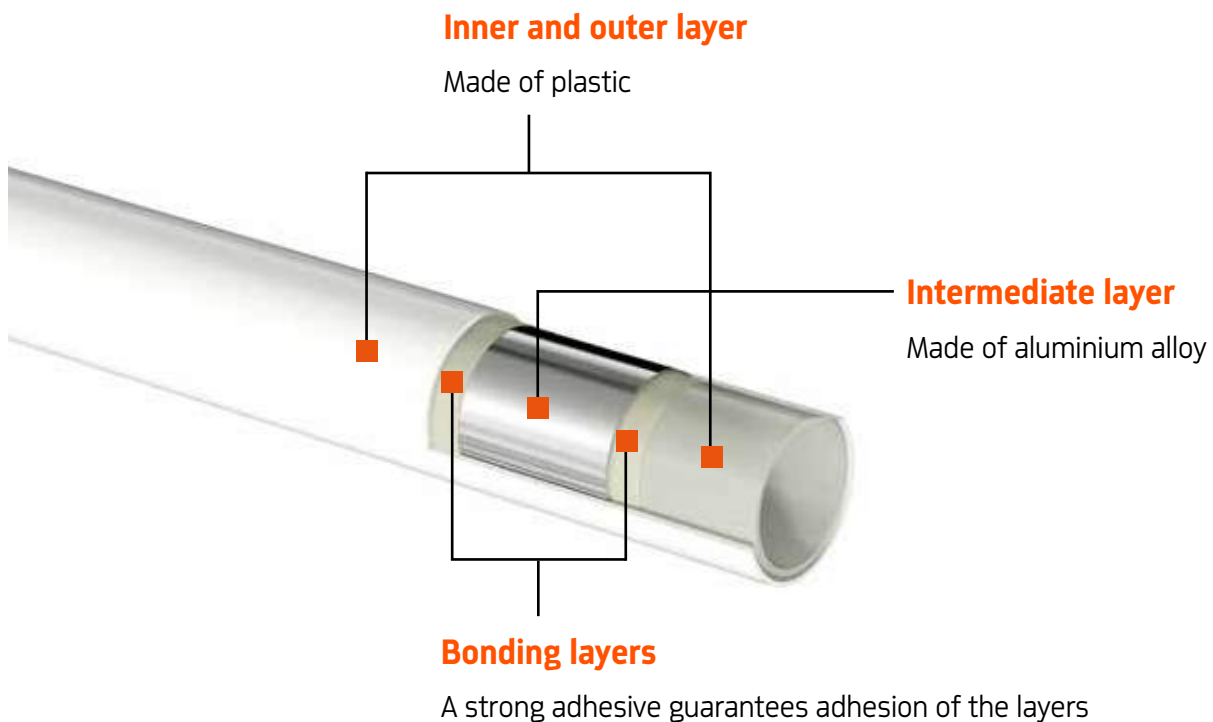



Fig. 1

Fig. 2
INSTRUCTIONS FOR CORRECT PREPARATION OF THE PIPE
Cutting (Fig. 1)

Cut the pipe using a shear that does not squash the pipe and make sure that the cut is perpendicular to the pipe axis. For the specific shears, see the section "Tools and general accessories".

Calibration and countersink (Fig. 2)

Calibration determines the right internal diameter of the pipe, while countersink allows to create a chamfer at the end of the pipe which prevents any movement of the o-rings from their housing during the pipe insertion phase. If there is great resistance when inserting the fitting, this means that calibration and countersinking were not carried out correctly; in this case, you have to avoid to insert the fitting in the pipe, repeat calibration/countersinking operations and lubricate o-rings with water. For calibration and countersink tools, see the section "Tools and general accessories".

NOTE: it is absolutely forbidden to lubricate o-rings with mineral-based oils or greases.

ALPEX DUO

- Tubo multistrato PE-Xb/Al/PE-Xb in barre.
- PE-Xb/Al/PE-Xb multilayer pipe in bars.
- Tuyau multicouche PE-Xb/Al/PE-Xb en barres.
- Verbundrohr PE-Xb/Al/PE-Xb in Stangen.
- Tubo multicapa PE-Xb/Al/PE-Xb en barras.

FRÄNKISCHE

Code	Size	Length	Price	Class	Packaging
ALPEX-16B	Ø16/2 (Aluminium 0,30 mm)	5 m	4,253 €/m	HG	75 m
ALPEX-20B	Ø20/2 (Aluminium 0,40 mm)	5 m	5,034 €/m	HG	50 m
ALPEX-26B	Ø26/3 (Aluminium 0,65 mm)	5 m	8,687 €/m	HG	25 m
ALPEX-32B	Ø32/3 (Aluminium 0,85 mm)	5 m	12,605 €/m	HG	20 m
ALPEX-40B	Ø40/3,5 (Aluminium 1,00 mm)	5 m	18,628 €/m	HG	25 m
ALPEX-50B	Ø50/4 (Aluminium 1,20 mm)	5 m	28,026 €/m	HG	25 m
ALPEX-63B	Ø63/4,5 (Aluminium 1,50 mm)	5 m	54,015 €/m	HG	15 m

IVAR-APEX B

- Tubo multistrato PE-Xb/Al/PE-Xb in barre.
- PE-Xb/Al/PE-Xb multilayer pipe in bars.
- Tuyau multicouche PE-Xb/Al/PE-Xb en barres.
- Verbundrohr PE-Xb/Al/PE-Xb in Stangen.
- Tubo multicapa PE-Xb/Al/PE-Xb en barras.

Code	Size	Length	Price	Class	Packaging
I-APEX16B4	Ø16/2 (Aluminium 0,20 mm)	4 m	2,583 €/m	HX	100 m
I-APEX20B4	Ø20/2 (Aluminium 0,25 mm)	4 m	3,686 €/m	HX	64 m
I-APEX25B4	Ø25/2,5 (Aluminium 0,30 mm)	4 m	7,72 €/m	HX	40 m
I-APEX26B4	Ø26/3 (Aluminium 0,30 mm)	4 m	7,988 €/m	HX	40 m
I-APEX32B4	Ø32/3 (Aluminium 0,40 mm)	4 m	11,376 €/m	HX	28 m

ALPEX DUO XS



- Tubo multistrato PE-Xb/Al/PE-HD in rotoli.
- PE-Xb/Al/PE-HD multilayer pipe in coils.
- Tuyau multicouche PE-Xb/Al/PE-HD en rouleaux.
- Verbundrohr PE-Xb/Al/PE-HD in Rollen.
- Tubo multicapa PE-Xb/Al/PE-HD en rollos.

FRANKISCHE

Code	Size	Price	Class	Packaging
ALPEX-16R1	Ø16/2 (Aluminium 0,20 mm)	2,176 €/m	HB	100 m
ALPEX-16R3	Ø16/2 (Aluminium 0,20 mm)	2,176 €/m	HB	301,50 m
ALPEX-18R1	Ø18/2 (Aluminium 0,30 mm)	3,178 €/m	HB	100 m
ALPEX-18R3	Ø18/2 (Aluminium 0,30 mm)	3,178 €/m	HB	301,50 m
ALPEX-20R1	Ø20/2 (Aluminium 0,30 mm)	3,291 €/m	HB	100 m
ALPEX-20R3	Ø20/2 (Aluminium 0,30 mm)	3,291 €/m	HB	301,50 m
ALPEX-26R	Ø26/3 (Aluminium 0,50 mm)	6,582 €/m	HB	50 m
ALPEX-32R	Ø32/3 (Aluminium 0,60 mm)	9,816 €/m	HB	50 m

ALPEX DUO XS RCB



- Tubo multistrato PE-Xb/Al/PE-HD in rotoli completo di coibentazione termica.
- PE-Xb/Al/PE-HD multilayer pipe in coils complete with thermal insulation.
- Tuyau multicouche PE-Xb/Al/PE-HD en rouleaux avec isolation thermique.
- Verbundrohr PE-Xb/Al/PE-HD in Rollen komplett mit Wärmedämmung.
- Tubo multicapa PE-Xb/Al/PE-HD en rollos con aislamiento térmico.

FRANKISCHE

Code	Size	Insulation thickness	Color	Price	Class	Packaging
ALPEX-16RCB	Ø16/2 (Aluminium 0,20 mm)	6 mm	■	2,942 €/m	HE	50 m
ALPEX-18RCB	Ø18/2 (Aluminium 0,30 mm)	6 mm	■	4,099 €/m	HE	50 m
ALPEX-20RCB	Ø20/2 (Aluminium 0,30 mm)	6 mm	■	4,197 €/m	HE	50 m
ALPEX-26RCB	Ø26/3 (Aluminium 0,50 mm)	10 mm	■	8,477 €/m	HE	50 m

ALPEX DUO XS RCR



- Tubo multistrato PE-Xb/Al/PE-HD in rotoli completo di coibentazione termica.
- PE-Xb/Al/PE-HD multilayer pipe in coils complete with thermal insulation.
- Tuyau multicouche PE-Xb/Al/PE-HD en rouleaux avec isolation thermique.
- Verbundrohr PE-Xb/Al/PE-HD in Rollen komplett mit Wärmedämmung.
- Tubo multicapa PE-Xb/Al/PE-HD en rollos con aislamiento térmico.

FRANKISCHE

Code	Size	Insulation thickness	Color	Price	Class	Packaging
ALPEX-16RCR	Ø16/2 (Aluminium 0,20 mm)	6 mm	■	2,942 €/m	HE	50 m
ALPEX-18RCR	Ø18/2 (Aluminium 0,30 mm)	6 mm	■	4,099 €/m	HE	50 m
ALPEX-20RCR	Ø20/2 (Aluminium 0,30 mm)	6 mm	■	4,197 €/m	HE	50 m
ALPEX-26RCR	Ø26/3 (Aluminium 0,50 mm)	10 mm	■	8,477 €/m	HE	50 m

IVAR-APEX R

- **Tubo multistrato PE-Xb/Al/PE-Xb in rotoli.**
- *PE-Xb/Al/PE-Xb multilayer pipe in coils.*
- **Tuyau multicouche PE-Xb/Al/PE-Xb en rouleaux.**
- *Verbundrohr PE-Xb/Al/PE-Xb in Rollen.*
- **Tubo multicapa PE-Xb/Al/PE-Xb en rollos.**

Code	Size	Price	Class	Packaging
I-APEX16R100	Ø16/2 (Aluminium 0,20 mm)	2,065 €/m	HM	100 m
I-APEX16R200	Ø16/2 (Aluminium 0,20 mm)	2,065 €/m	HM	200 m
I-APEX16R400	Ø16/2 (Aluminium 0,20 mm)	2,065 €/m	HM	400 m
I-APEX18R50	Ø18/2 (Aluminium 0,20 mm)	2,982 €/m	HM	50 m
I-APEX18R100	Ø18/2 (Aluminium 0,20 mm)	2,982 €/m	HM	100 m
I-APEX18R200	Ø18/2 (Aluminium 0,20 mm)	2,982 €/m	HM	200 m
I-APEX20R100	Ø20/2 (Aluminium 0,25 mm)	3,081 €/m	HM	100 m
I-APEX25R50	Ø25/2,5 (Aluminium 0,30 mm)	6,096 €/m	HM	50 m
I-APEX26R50	Ø26/3 (Aluminium 0,30 mm)	6,096 €/m	HM	50 m
I-APEX32R50	Ø32/3 (Aluminium 0,40 mm)	8,98 €/m	HM	50 m

IVAR-APEX RCB

- **Tubo multistrato PE-Xb/Al/PE-Xb in rotoli completo di coibentazione termica.**
- *PE-Xb/Al/PE-Xb multilayer pipe in coils complete with thermal insulation.*
- **Tuyau multicouche PE-Xb/Al/PE-Xb en rouleaux avec isolation thermique.**
- *Verbundrohr PE-Xb/Al/PE-Xb in Rollen komplett mit Wärmedämmung.*
- **Tubo multicapa PE-Xb/Al/PE-Xb en rollos con aislamiento térmico.**

Code	Size	Insulation thickness	Color	Price	Class	Packaging
I-APEX16RCB50	Ø16/2 (Aluminium 0,20 mm)	6 mm	■	2,868 €/m	HO	50 m
I-APEX20RCB50	Ø20/2 (Aluminium 0,25 mm)	6 mm	■	4,413 €/m	HO	50 m
I-APEX25RCB25	Ø25/2,5 (Aluminium 0,30 mm)	10 mm	■	8,699 €/m	HO	25 m
I-APEX26RCB50	Ø26/3 (Aluminium 0,30 mm)	10 mm	■	8,699 €/m	HO	50 m
I-APEX32RCB25	Ø32/3 (Aluminium 0,40 mm)	10 mm	■	12,462 €/m	HO	25 m

IVAR-APEX RCR

- **Tubo multistrato PE-Xb/Al/PE-Xb in rotoli completo di coibentazione termica.**
- *PE-Xb/Al/PE-Xb multilayer pipe in coils complete with thermal insulation.*
- **Tuyau multicouche PE-Xb/Al/PE-Xb en rouleaux avec isolation thermique.**
- *Verbundrohr PE-Xb/Al/PE-Xb in Rollen komplett mit Wärmedämmung.*
- **Tubo multicapa PE-Xb/Al/PE-Xb en rollos con aislamiento térmico.**

Code	Size	Insulation thickness	Color	Price	Class	Packaging
I-APEX16RCR50	Ø16/2 (Aluminium 0,20 mm)	6 mm	■	2,868 €/m	HO	50 m
I-APEX20RCR50	Ø20/2 (Aluminium 0,25 mm)	6 mm	■	4,413 €/m	HO	50 m
I-APEX25RCR25	Ø25/2,5 (Aluminium 0,30 mm)	10 mm	■	8,699 €/m	HO	25 m
I-APEX26RCR50	Ø26/3 (Aluminium 0,30 mm)	10 mm	■	8,699 €/m	HO	50 m
I-APEX32RCR25	Ø32/3 (Aluminium 0,40 mm)	10 mm	■	12,462 €/m	HO	25 m

ALPEX RCFG



- **Tubo multistrato PE-Xb/Al/PE-HD in rotoli completo di coibentazione termica per raffreddamento.**
- *PE-Xb/Al/PE-HD multilayer pipe in coils complete with thermal insulation for cooling.*
- **Tuyau multicouche PE-Xb/Al/PE-HD en rouleaux avec isolation thermique pour refroidissement.**
- *Verbundrohr PE-Xb/Al/PE-HD in Rollen komplett mit Wärmedämmung für Kühlung.*
- **Tubo multicapa PE-Xb/Al/PE-HD en rollos con aislamiento térmico para enfriamiento.**

FRÄNKISCHE

Code	Size	Insulation thickness	Color	Price	Class	Packaging
ALPEX-16RCFG	Ø16/2 (Aluminium 0,20 mm)	13 mm	■	5,899 €/m	HE	50 m
ALPEX-20RCFG	Ø20/2 (Aluminium 0,30 mm)	13 mm	■	7,001 €/m	HE	50 m
ALPEX-26RCFG	Ø26/3 (Aluminium 0,50 mm)	13 mm	■	12,465 €/m	HE	25 m
ALPEX-32RCFG	Ø32/3 (Aluminium 0,60 mm)	13 mm	■	14,905 €/m	HE	25 m

IVAR-APEX RCF



- **Tubo multistrato PE-Xb/Al/PE-Xb in rotoli completo di coibentazione termica per raffreddamento.**
- *PE-Xb/Al/PE-Xb multilayer pipe in coils complete with thermal insulation for cooling.*
- **Tuyau multicouche PE-Xb/Al/PE-Xb en rouleaux avec isolation thermique pour refroidissement.**
- *Verbundrohr PE-Xb/Al/PE-Xb in Rollen komplett mit Wärmedämmung für Kühlung.*
- **Tubo multicapa PE-Xb/Al/PE-Xb en rollos con aislamiento térmico para enfriamiento.**

Code	Size	Insulation thickness	Color	Price	Class	Packaging
I-APEX16RCF50	Ø16/2 (Aluminium 0,20 mm)	13 mm	□	4,806 €/m	HO	50 m
I-APEX20RCF50	Ø20/2 (Aluminium 0,25 mm)	13 mm	□	6,382 €/m	HO	50 m
I-APEX26RCF50	Ø26/3 (Aluminium 0,30 mm)	13 mm	□	10,337 €/m	HO	50 m
I-APEX32RCF25	Ø32/3 (Aluminium 0,40 mm)	13 mm	□	15,899 €/m	HO	25 m

PE-RT

PE-RT (Polyethylene of Raised Temperature Resistance) is a polyethylene with improved mechanical resistance to high temperatures. Normal polyethylene has its polymer chains organised in a lamellar crystalline structure. By mixing a suitably different comonomer (Octene- 1) with polyethylene, it is possible to stimulate the formation of amorphous polymeric segments connecting the crystals of the material. These segments, called tie chains, show extensibility and mobility properties and improve the hardness of polyethylene and its resistance to high temperatures. Therefore PE-RT manufacture requires no cross-linking and for this reason the material remains thermoplastic, flexible and easy to join by fusion. Like PE-X, PE-RT also needs an EVOH barrier to prevent the diffusion of oxygen inside heating and cooling systems. PE-RT is often preferred for the implementation of radiant heating systems, where for a medium sized residential unit several hundred metres can be used. This is both because of its high flexibility, which facilitates its bending, and for the simpler industrial process necessary for its manufacture, which makes PE-RT economically competitive.

 **PLUS**

- **Particularly flexible**
- **Good strength characteristics at high temperatures**
- **Economically competitive**

IVAR PE-RT 5

- **Tubo PE-RT in rotoli con barriera EVOH a 5 strati.**
- *PE-RT pipe in coils with 5-layer EVOH barrier.*
- **Tuyau PE-RT en rouleaux avec barrière EVOH à 5 couches.**
- *PE-RT-Rohr mit EVOH-Barriere in Rollen, fünfschichtig.*
- **Tubo PE-RT en rollos con barrera EVOH de 5 capas.**

Code	Size	Price	Class	Packaging
I-PERT5L16R12	Ø16/2	1,651 €/m	HN	120 m
I-PERT5L16R25	Ø16/2	1,651 €/m	HN	250 m
I-PERT5L16R60	Ø16/2	1,651 €/m	HN	600 m
I-PERT5L17R12	Ø17/2	1,714 €/m	HN	120 m
I-PERT5L17R25	Ø17/2	1,714 €/m	HN	250 m
I-PERT5L17R60	Ø17/2	1,714 €/m	HN	600 m
I-PERT5L20R25	Ø20/2	2,369 €/m	HN	250 m
I-PERT5L20R50	Ø20/2	2,369 €/m	HN	500 m

HK PE-RT

- **Tubo in polietilene a resistenza termica maggiorata in rotoli.**
- *High thermal resistance polyethylene pipe in coils.*
- **Tuyau en polyéthylène avec résistance thermique augmenté en rouleaux.**
- *Polyethylenrohr mit thermischem Widerstand erhöht in Rollen.*
- **Tubo de polietileno con resistencia térmica aumentada en rollos.**

Code	Size	Price	Class	Packaging
HK-PERT10R2	Ø10/1,3	1,865 €/m	HH	200 m
HK-PERT10R10	Ø10/1,3	1,865 €/m	HH	1000 m

OXYGEN BARRIER PEX

Cross-linked polyethylene is typically made of high density polyethylene (HDPE) using an industrial process called cross-linking. Through this process, which creates strong bonds among the polymer chains, polyethylene is transformed from a thermoplastic to a thermoset, its resistance to chemical agents and mechanical stress is greatly improved and, above all, its resistance to ageing (i.e. its ability to maintain its properties stable over time) is improved.

From an industrial point of view, cross-linking is achieved by different methods, known by the names:

- Type A cross-linking (chemical method using peroxides)
- Type B cross-linking (chemical method using silanes)
- Type C cross-linking (physical method using electron beam)
- Type D cross-linking (chemical method using nitrogen compounds)

Type D cross-linking is not used for plumbing and heating applications, while Types A, B, and C polyethylene cross-linking, which are called PE-Xa, PE-Xb and PE-Xc, are very common.

Current standards define different minimum levels of cross-linking for different cross-linked types, especially for reasons linked to manufacturing processes. However, this does not substantially change the final result, which is still cross-linked polyethylene. It makes no sense to compare cross-linking methods defining one as "better" or "worse" than another.

All plastics have a certain gas permeability, including oxygen. Therefore, a certain amount of oxygen can pass through the walls of PE-X pipes over time. For this reason, in closed loop systems such as heating and cooling, they must include an EVOH (Ethylene Vinyl Alcohol) barrier, capable of significantly reducing the passage of oxygen molecules and thereby preventing their spread in the system. This results in cleaner circulating water (reducing the formation of algae) and a lower risk of corrosion of any ferrous parts of the system.

Therefore, all PE-X pipes proposed by IVAR have an EVOH oxygen barrier.

PEHD

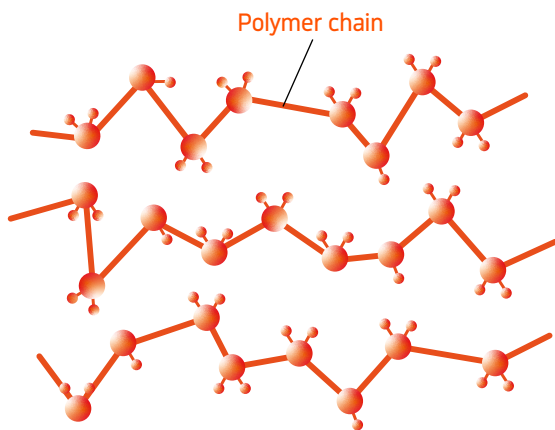

PE-X

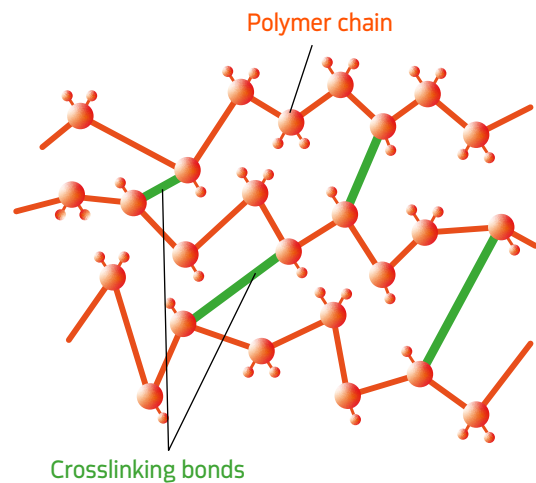

⊕ PLUS

- **Material with low surface roughness, reduces the risk of scale**
- **Highly resistant to chemical agents and especially to chlorinated water**
- **High mechanical strength at both high and low temperatures**

FF-Therm PE-Xa

- Tubo FF-Therm in polietilene reticolato PE-Xa in rotoli e barriera anti ossigeno (EVOH / DIN4726).
- FF-Therm pipe made of cross-linked polyethylene PE-Xa in coils and anti-oxygen barrier (EVOH / DIN4726).
- Tuyau FF-Therm en polyéthylène réticulé PE-Xa en rouleaux et barrière anti-oxygène (EVOH / DIN4726).
- FF-Therm-Rohr aus vernetztem Polyethylen PE-Xa in Rollen und Anti-Sauerstoff-Barriere (EVOH / DIN4726).
- Tubo FF-Therm de polietileno reticulado PE-Xa con barrera de oxígeno (EVOH / DIN4726) en rollos.

FRÄNKISCHE

Code	Size	Price	Class	Packaging
FF-PEXA16R1	Ø16/2	2,105 €/m	HH	120 m
FF-PEXA16R2	Ø16/2	2,105 €/m	HH	200 m
FF-PEXA16R6	Ø16/2	2,105 €/m	HH	600 m
FF-PEXA17R1	Ø17/2	2,105 €/m	HH	120 m
FF-PEXA17R25	Ø17/2	2,105 €/m	HH	250 m
FF-PEXA17R6	Ø17/2	2,105 €/m	HH	600 m
FF-PEXA18R2	Ø18/2	2,989 €/m	HH	200 m
FF-PEXA18R6	Ø18/2	2,989 €/m	HH	600 m
FF-PEXA20R2	Ø20/2	2,802 €/m	HH	200 m
FF-PEXA20R25	Ø20/2	2,802 €/m	HH	250 m
FF-PEXA20R5	Ø20/2	2,802 €/m	HH	500 m
FF-PEXA25R2	Ø25/2,3	4,457 €/m	HH	200 m
FF-PEXA25R45	Ø25/2,3	4,457 €/m	HH	450 m

IVAR PE-Xa 3

- Tubo in polietilene reticolato PE-Xa in rotoli con barriera EVOH a 3 strati.
- Pipe made of cross-linked polyethylene PE-Xa in coils with 3-layer EVOH barrier.
- Tuyau en polyéthylène réticulé PE-Xa en rouleaux avec barrière EVOH à 3 couches.
- Rohr aus vernetztem Polyethylen PE-Xa in Rollen mit EVOH-Barriere, dreischichtig.
- Tubo de polietileno reticulado PE-Xa en rollos con barrera EVOH de 3 capas.

Code	Size	Price	Class	Packaging
I-PEXA3L16R12	Ø16/2	1,814 €/m	HN	120 m
I-PEXA3L16R25	Ø16/2	1,814 €/m	HN	250 m
I-PEXA3L16R60	Ø16/2	1,814 €/m	HN	600 m
I-PEXA3L17R25	Ø17/2	1,89 €/m	HN	250 m
I-PEXA3L17R60	Ø17/2	1,89 €/m	HN	600 m
I-PEXA3L20R25	Ø20/2	2,419 €/m	HN	250 m
I-PEXA3L20R50	Ø20/2	2,419 €/m	HN	500 m

PRESS FITTINGS M•P

MULTI-PRESS is the IVAR press fitting designed and tested for use with 7 different crimping profiles (BE, B, TH, R, H, F and U). Its body is made of CW617N. Also available upon request is the version with a lead-free copper-silicon alloy or Cuphin® CW724R body, (add the suffix "C" to the code), which conforms to the positive lists of metal materials suitable for applications in contact with drinking water (4 MS Common Composition List and the UBA List defined by the German Federal Environment Agency).

The geometry of the fitting, which was designed to provide optimal coupling between pipe and fitting after pressing and the windows on the bushing flange used to verify that the pipe and two peroxide EPDM O-rings on each end have been inserted properly are all details that help to ensure the applicability and reliability of the product.

Available in a broad range of configurations and sizes from 16/2 to 63/4.5.

Technical specifications:

Maximum operating temperature: 120 °C

Maximum operating static pressure: 10 bar

⊕ PLUS

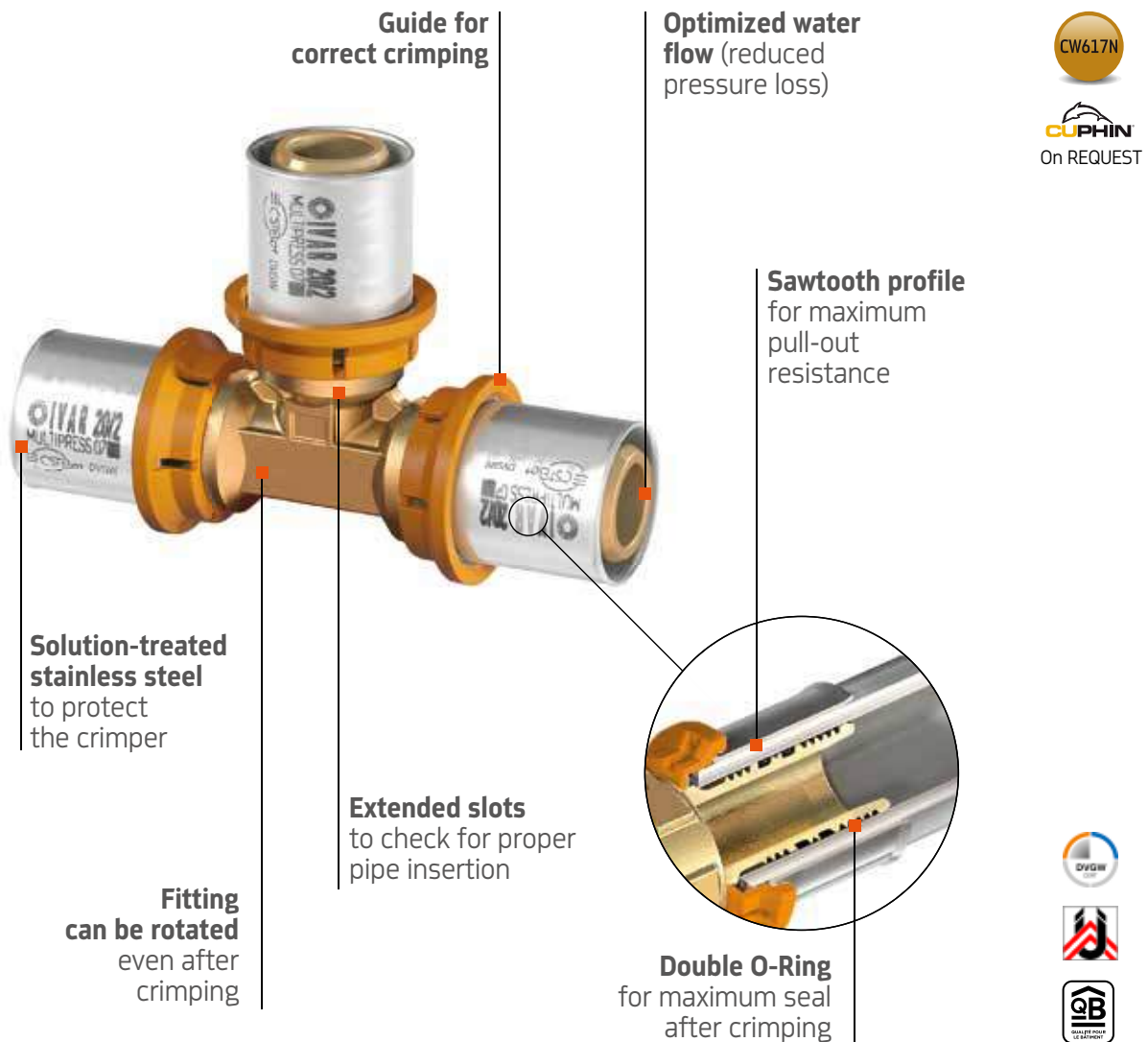

Up to 32/3

- **Compatible with all TH - H/R - U - B/BE - F crimping profiles**
- **Complete range of figures**
- **Ø from 16 to 63 mm**



Ø (mm)	16	18	20	25	26	32	40	50	63
Spessore Thickness Épaisseur Dicke Espesor (mm)	2 2,25	2	2 2,25 2,5	2,5	3	3	3,5	4	4,5
 BE**	■	-	■	-	■	■	-	-	-
B***	■	■	■	-	■	■	-	-	-
F***	■	■	■	-	■	■	■	■	■
R**	■	■	■	■	■	■	-	-	-
H***	■	■	■	■	■	■	■	-	-
TH*	■	■	■	■	■	■	■	■	■
U*	■	■	■	■	-	■	■	■	■

* Rothenberger/Rems

** Rothenberger

*** Rems

MP 5700 R



- **Raccordo diritto ridotto.**
- *Straight reduced fitting.*
- **Raccord droit réduit.**
- *Reduzierter Durchgangs-Verbinder.*
- **Racor recto reducido.**

Code	Size	Price	Class	Packaging
510040MP	16/2 x 18/2	6,73 €	IM	40 / 160
510008MP	16/2 x 20/2	6,54 €	IM	40 / 160
512103MP	16/2 x 20/2,5	6,73 €	IM	40 / 160
510135MP	16/2 x 25/2,5	8,83 €	IM	20 / 80
510009MP	16/2 x 26/3	8,83 €	IM	20 / 80
510024MP	16/2 x 32/3	11,70 €	IM	15 / 60
511031MP	16/2,25 x 20/2,25	6,73 €	IM	40 / 160
511032MP	16/2,25 x 20/2,5	6,73 €	IM	40 / 160
510039MP	18/2 x 20/2	7,10 €	IM	40 / 160
510041MP	18/2 x 26/3	9,18 €	IM	20 / 80
510200MP	20/2 x 20/2,5	7,10 €	IM	40 / 160
510137MP	20/2 x 25/2,5	9,18 €	IM	20 / 80
510010MP	20/2 x 26/3	9,18 €	IM	20 / 80
510023MP	20/2 x 32/3	12,44 €	IM	15 / 60
511035MP	20/2,25 x 25/2,5	9,18 €	IM	20 / 80
511036MP	20/2,25 x 26/3	9,18 €	IM	20 / 80
511038MP	20/2,5 x 25/2,5	9,18 €	IM	20 / 80
511039MP	20/2,5 x 26/3	9,18 €	IM	20 / 80
510181MP	25/2,5 x 26/3	10,57 €	IM	20 / 80
510138MP	25/2,5 x 32/3	13,39 €	IM	15 / 60
510019MP	26/3 x 32/3	13,39 €	IM	15 / 60
510129	20/2 x 40/3,5	28,62 €	IB	40
510139	25/2,5 x 40/3,5	30,82 €	IB	40
510108	26/3 x 40/3,5	30,82 €	IB	40
510173	25/2,5 x 50/4	41,90 €	IB	30
510128	26/3 x 50/4	41,90 €	IB	30
510031	32/3 x 40/3,5	30,82 €	IB	40
510103	32/3 x 50/4	41,90 €	IB	30
510029	40/3,5 x 50/4	54,18 €	IB	25
510054	40/3,5 x 63/4,5	86,81 €	IB	15
510055	50/4 x 63/4,5	86,81 €	IB	15

MP 5700



- **Raccordo diritto.**
- *Straight fitting.*
- **Raccord droit.**
- *Kupplung.*
- **Racor recto.**

Code	Size	Price	Class	Packaging
510005MP	16/2 x 16/2	5,41 €	IM	40 / 160
511030MP	16/2,25 x 16/2,25	5,57 €	IM	40 / 160
510038MP	18/2 x 18/2	7,10 €	IM	40 / 160
510006MP	20/2 x 20/2	7,10 €	IM	30 / 120
511034MP	20/2,25 x 20/2,25	7,10 €	IM	40 / 160
511037MP	20/2,5 x 20/2,5	7,10 €	IM	40 / 160
510134MP	25/2,5 x 25/2,5	10,57 €	IM	20 / 80
510007MP	26/3 x 26/3	10,57 €	IM	20 / 80
510020MP	32/3 x 32/3	15,64 €	IM	15 / 60
510030	40/3,5 x 40/3,5	34,94 €	IB	40
510028	50/4 x 50/4	54,18 €	IB	25
510053	63/4,5 x 63/4,5	88,46 €	IB	15

MP 5704



- **Raccordo a 45°.**
- *45° fitting.*
- **Raccord à 45°.**
- *Verbindungsstück 45°.*
- **Racor a 45°.**

Code	Size	Price	Class	Packaging
510169MP	25/2,5 x 25/2,5	15,70 €	IM	15 / 60
510099MP	26/3 x 26/3	15,70 €	IM	15 / 60
510100MP	32/3 x 32/3	18,09 €	IM	10 / 40
510101	40/3,5 x 40/3,5	63,49 €	IB	25
510102	50/4 x 50/4	81,44 €	IB	12
511093	63/4,5 x 63/4,5	130,90 €	IB	7

MP 5609



- **Raccordo diritto maschio a tenuta morbida.**
- *Straight male soft seal fitting.*
- **Raccord droit mâle à étanchéité souple.**
- *Durchgang AG Verbinder mit O-Ring.*
- **Racor recto macho con junta blanda.**

Code	Size	Price	Class	Packaging
510048MP	1/2" M O-ring x 16/2	5,22 €	IM	40 / 160
511050MP	1/2" M O-ring x 16/2,25	5,22 €	IM	40 / 160
510050MP	1/2" M O-ring x 20/2	5,71 €	IM	40 / 160
511051MP	1/2" M O-ring x 20/2,25	5,71 €	IM	40 / 160

- È possibile ordinare questi articoli in versione Cuphin® CW724R (aggiungere il suffisso "C" al codice).
- It is possible to order these items in Cuphin® CW724R version (adding suffix "C" at the end of the code).
- Il est possible de commander ces articles en version Cuphin® CW724R (en ajoutant le suffixe «C» au code).
- Sie können diese Artikel in Cuphin® CW724R Ausführungen (Fügen Sie das „C“ Nachsilbe, um den Code) bestellen.
- Puede pedir estos artículos en la versión Cuphin® CW724R (sufijo "C" al final del código).

MP 5710

- Raccordo ad angolo.
- Angle fitting.
- Raccord à angle.
- Winkel-Kupplung.
- Racor codo.

Code	Size	Price	Class	Packaging
511009MP	16/2 x 16/2	6,31 €	IM	30 / 120
511053MP	16/2,25 x 16/2,25	6,31 €	IM	30 / 120
511018MP	18/2 x 18/2	7,83 €	IM	30 / 120
511010MP	20/2 x 20/2	7,83 €	IM	30 / 120
511054MP	20/2,25 x 20/2,25	7,83 €	IM	30 / 120
511055MP	20/2,5 x 20/2,5	7,83 €	IM	30 / 120
510140MP	25/2,5 x 25/2,5	11,73 €	IM	15 / 60
511011MP	26/3 x 26/3	11,73 €	IM	15 / 60
511012MP	32/3 x 32/3	17,46 €	IM	10 / 40
510035	40/3,5 x 40/3,5	40,89 €	IB	20
510036	50/4 x 50/4	63,23 €	IB	10
510056	63/4,5 x 63/4,5	94,64 €	IB	7

MP 5720

- Raccordo a T.
- Tee fitting.
- Raccord à T.
- T-Stück.
- Racor en Te.

Code	Size	Price	Class	Packaging
512001MP	16/2 x 16/2 x 16/2	8,07 €	IM	20 / 80
511067MP	16/2,25 x 16/2,25 x 16/2,25	8,07 €	IM	20 / 80
512054MP	18/2 x 18/2 x 18/2	11,31 €	IM	16 / 64
512002MP	20/2 x 20/2 x 20/2	11,31 €	IM	16 / 64
511070MP	20/2,25 x 20/2,25 x 20/2,25	11,31 €	IM	16 / 64
510143MP	25/2,5 x 25/2,5 x 25/2,5	17,36 €	IM	10 / 40
512003MP	26/3 x 26/3 x 26/3	17,36 €	IM	10 / 40
512020MP	32/3 x 32/3 x 32/3	27,73 €	IM	8 / 32
512035	40/3,5 x 40/3,5 x 40/3,5	62,40 €	IB	12
512036	50/4 x 50/4 x 50/4	100,26 €	IB	7
510058	63/4,5 x 63/4,5 x 63/4,5	157,16 €	IB	4

MP 5720 RLL

- Raccordo a T con attacchi laterali ridotti.
- Tee fitting with reduced side connections.
- Raccord à T avec connexions latérales réduites.
- T-Stück mit reduzierten seitlichen Anschlüssen.
- Racor en Te con conexiones laterales reducidas.

Code	Size	Price	Class	Packaging
512056MP	16/2 x 18/2 x 16/2	10,57 €	IM	16 / 64
512013MP	16/2 x 20/2 x 16/2	10,57 €	IM	16 / 64
510147MP	20/2 x 25/2,5 x 20/2	15,96 €	IM	12 / 48
512014MP	20/2 x 26/3 x 20/2	15,96 €	IM	12 / 48
512051MP	20/2 x 32/3 x 20/2	24,27 €	IM	8 / 32
510179MP	25/2,5 x 32/3 x 25/2,5	25,21 €	IM	8 / 32
512019MP	26/3 x 32/3 x 26/3	25,21 €	IM	8 / 32
510120	32/3 x 40/3,5 x 32/3	58,04 €	IB	16
510127	40/3,5 x 50/4 x 40/3,5	96,29 €	IB	7
510122	50/4 x 63/4,5 x 50/4	144,93 €	IB	6

MP 5720 RCL

- Raccordo a T con attacco centrale e laterale ridotti.
- Tee fitting with reduced central and side connection.
- Raccord à T avec connexion centrale et latérale réduites.
- T-Stück mit reduziertem Mittel- und Seitenanschluss.
- Racor en Te con conexión central y lateral reducida.

Code	Size	Price	Class	Packaging
512058MP	16/2 x 16/2 x 18/2	10,57 €	IM	16 / 64
512009MP	16/2 x 16/2 x 20/2	10,57 €	IM	16 / 64
511068MP	16/2 x 16/2 x 20/2,25	10,57 €	IM	16 / 64
512101MP	16/2 x 16/2 x 20/2,5	10,57 €	IM	16 / 64
512064MP	18/2 x 18/2 x 20/2	11,31 €	IM	16 / 64
512062MP	18/2 x 18/2 x 26/3	15,96 €	IM	10 / 40
510154MP	20/2 x 20/2 x 25/2,5	15,96 €	IM	12 / 48
512012MP	20/2 x 20/2 x 26/3	15,96 €	IM	12 / 48
512021MP	20/2 x 20/2 x 32/3	24,27 €	IM	8 / 32
510155MP	25/2,5 x 25/2,5 x 32/3	25,21 €	IM	8 / 32
512017MP	26/3 x 26/3 x 32/3	25,21 €	IM	8 / 32
510156	25/2,5 x 25/2,5 x 40/3,5	58,04 €	IB	16
510116	26/3 x 26/3 x 40/3,5	58,04 €	IB	16
510118	32/3 x 32/3 x 40/3,5	58,04 €	IB	16
510125	40/3,5 x 40/3,5 x 50/4	96,29 €	IB	7
510121	50/4 x 50/4 x 63/4,5	144,93 €	IB	6



- È possibile ordinare questi articoli in versione Cuphin® CW724R (aggiungere il suffisso "C" al codice).
- It is possible to order these items in Cuphin® CW724R version (adding suffix "C" at the end of the code).
- Il est possible de commander ces articles en version Cuphin® CW724R (en ajoutant le suffixe «C» au code).
- Sie können diese Artikel in Cuphin® CW724R Ausführungen (Fügen Sie das „C“ Nachsilbe, um den Code) bestellen.
- Puede pedir estos artículos en la versión Cuphin® CW724R (sufijo "C" al final del código).

■ MP 5720 RC



- Raccordo a T con attacco centrale ridotto.
- Tee fitting with reduced central connection.
- Raccord à T avec connexion centrale réduite.
- T-Stück mit reduziertem Zentralanschluss.
- Racor en Te con conexión central reducida.

Code	Size	Price	Class	Packaging
512055MP	18/2 x 16/2 x 18/2	10,96 €	IM	16 / 64
512004MP	20/2 x 16/2 x 20/2	10,96 €	IM	16 / 64
510182MP	20/2,25 x 16/2 x 20/2,25	10,96 €	IM	16 / 64
511071MP	20/2,5 x 16/2 x 202,5	10,96 €	IM	16 / 64
511072MP	20/2,5 x 16/2,25 x 20/2,5	10,96 €	IM	16 / 64
510144MP	25/2,5 x 16/2 x 25/2,5	15,96 €	IM	12 / 48
511074MP	25/2,5 x 16/2,25 x 25/2,5	15,96 €	IM	12 / 48
510146MP	25/2,5 x 20/2 x 25/2,5	16,34 €	IM	12 / 48
511075MP	25/2,5 x 20/2,25 x 25/2,5	16,34 €	IM	12 / 48
511076MP	25/2,5 x 20/2,5 x 25/2,5	16,34 €	IM	12 / 48
512005MP	26/3 x 16/2 x 26/3	15,96 €	IM	12 / 48
511077MP	26/3 x 16/2,25 x 26/3	15,96 €	IM	12 / 48
512059MP	26/3 x 18/2 x 26/3	16,34 €	IM	12 / 48
512006MP	26/3 x 20/2 x 26/3	16,34 €	IM	12 / 48
511078MP	26/3 x 20/2,25 x 26/3	16,34 €	IM	12 / 48
512015MP	32/3 x 16/2 x 32/3	22,79 €	IM	8 / 32
512060MP	32/3 x 18/2 x 32/3	25,33 €	IM	8 / 32
512016MP	32/3 x 20/2 x 32/3	25,33 €	IM	8 / 32
511081MP	32/3 x 20/2,25 x 32/3	25,33 €	IM	8 / 32
511082MP	32/3 x 20/2,5 x 32/3	25,33 €	IM	8 / 32
510174MP	32/3 x 25/2,5 x 32/3	26,59 €	IM	8 / 32
512018MP	32/3 x 26/3 x 32/3	26,59 €	IM	8 / 32
512089	40/3,5 x 20/2 x 40/3,5	62,40 €	IB	15
510175	40/3,5 x 25/2,5 x 40/3,5	62,40 €	IB	15
512090	40/3,5 x 26/3 x 40/3,5	62,40 €	IB	15
512037	40/3,5 x 32/3 x 40/3,5	62,40 €	IB	14
512091	50/4 x 20/2 x 50/4	96,29 €	IB	10
510176	50/4 x 25/2,5 x 50/4	96,29 €	IB	10
512092	50/4 x 26/3 x 50/4	96,29 €	IB	10
512039	50/4 x 32/3 x 50/4	96,43 €	IB	10
512038	50/4 x 40/3,5 x 50/4	99,89 €	IB	7
510177	63/4,5 x 25/2,5 x 63/4,5	106,34 €	IB	6
512093	63/4,5 x 26/3 x 63/4,5	106,34 €	IB	6
512094	63/4,5 x 32/3 x 63/4,5	106,34 €	IB	6
512095	63/4,5 x 40/3,5 x 63/4,5	106,34 €	IB	6
510059	63/4,5 x 50/4 x 63/4,5	154,69 €	IB	5

■ MP 5720 RL



- Raccordo a T con attacco laterale ridotto.
- Tee fitting with reduced side connection.
- Raccord à T avec connexion latérale réduite.
- T-Stück mit reduziertem seitlichen Anschluss.
- Racor en Te con conexión lateral reducida.

Code	Size	Price	Class	Packaging
512007MP	20/2 x 20/2 x 16/2	10,96 €	IM	16 / 64
510148MP	25/2,5 x 25/2,5 x 16/2	15,96 €	IM	12 / 48
510150MP	25/2,5 x 25/2,5 x 20/2	16,33 €	IM	12 / 48
512048MP	26/3 x 26/3 x 16/2	15,96 €	IM	12 / 48
512063MP	26/3 x 26/3 x 18/2	16,33 €	IM	10 / 40
512008MP	26/3 x 26/3 x 20/2	16,33 €	IM	12 / 48
512068MP	32/3 x 32/3 x 16/2	22,79 €	IM	8 / 32
512052MP	32/3 x 32/3 x 20/2	25,33 €	IM	8 / 32
510151MP	32/3 x 32/3 x 25/2,5	26,59 €	IM	8 / 32
512053MP	32/3 x 32/3 x 26/3	26,59 €	IM	8 / 32
510152	40/3,5 x 40/3,5 x 25/2,5	62,40 €	IB	16
510117	40/3,5 x 40/3,5 x 26/3	62,40 €	IB	16
510119	40/3,5 x 40/3,5 x 32/3	62,40 €	IB	16
510124	50/4 x 50/4 x 32/3	96,29 €	IB	10
510126	50/4 x 50/4 x 40/3,5	98,50 €	IB	7
510123	63/4,5 x 63/4,5 x 50/4	154,69 €	IB	6

■ MP 5720 RR



- Raccordo a T con attacchi a doppia riduzione.
- Tee fitting with double reduction connections.
- Raccord à T avec des connexions à double réduction.
- T-Stück mit Doppel Reduktion Anschlüssen.
- Racor en Te con conexiones de doble reducción.

Code	Size	Price	Class	Packaging
510157MP	25/2,5 x 16/2 x 20/2	14,46 €	IM	12 / 48
510158MP	25/2,5 x 20/2 x 16/2	14,46 €	IM	12 / 48
510159MP	32/3 x 20/2 x 25/2,5	24,41 €	IM	8 / 32
510160MP	32/3 x 25/2,5 x 20/2	24,41 €	IM	8 / 32
512010MP	26/3 x 16/2 x 20/2	14,46 €	IM	12 / 48
512011MP	26/3 x 20/2 x 16/2	14,46 €	IM	12 / 48
512050MP	32/3 x 20/2 x 26/3	24,41 €	IM	8 / 32
512024MP	32/3 x 26/3 x 20/2	24,41 €	IM	8 / 32

- È possibile ordinare questi articoli in versione Cuphin® CW724R (aggiungere il suffisso "C" al codice).
- It is possible to order these items in Cuphin® CW724R version (adding suffix "C" at the end of the code).
- Il est possible de commander ces articles en version Cuphin® CW724R (en ajoutant le suffixe «C» au code).
- Sie können diese Artikel in Cuphin® CW724R Ausführungen (Fügen Sie das „C“ Nachsilbe, um den Code) bestellen.
- Puede pedir estos artículos en la versión Cuphin® CW724R (sufijo "C" al final del código).



MP 5608

- Raccordo diritto maschio.
- Straight male fitting.
- Raccord droit mâle.
- Durchgang AG Verbinder.
- Racor recto macho.

Code	Size	Price	Class	Packaging
510084MP	3/8" M x 16/2	5,79 €	IM	50 / 200
510001MP	1/2" M x 16/2	4,192 €	IM	40 / 160
511045MP	1/2" M x 16/2,25	4,192 €	IM	40 / 160
510105MP	3/4" M x 16/2	6,61 €	IM	30 / 120
510042MP	1/2" M x 18/2	4,851 €	IM	40 / 160
510043MP	3/4" M x 18/2	6,18 €	IM	30 / 120
510002MP	1/2" M x 20/2	4,851 €	IM	40 / 160
511046MP	1/2" M x 20/2,25	4,851 €	IM	40 / 160
511047MP	1/2" M x 20/2,5	4,851 €	IM	40 / 160
510003MP	3/4" M x 20/2	6,18 €	IM	30 / 120
511048MP	3/4" M x 20/2,25	6,18 €	IM	30 / 120
511049MP	3/4" M x 20/2,5	6,18 €	IM	30 / 120
510130MP	3/4" M x 25/2,5	8,03 €	IM	30 / 120
510131MP	1" M x 25/2,5	10,06 €	IM	20 / 80
510004MP	3/4" M x 26/3	8,03 €	IM	30 / 120
510044MP	1" M x 26/3	10,06 €	IM	20 / 80
510021MP	1" M x 32/3	12,15 €	IM	20 / 80
510106MP	1"1/4 M x 32/3	26,28 €	IM	10 / 40
510032	1"1/4 M x 40/3,5	32,13 €	IB	40
510027	1"1/2 M x 50/4	44,35 €	IB	25
510052	2" M x 63/4,5	80,28 €	IB	16

MP 5607

- Raccordo diritto con attacco FASTEC.
- Straight fitting with FASTEC connection.
- Raccord droit avec embout FASTEC.
- Durchgang Verbinder mit FASTEC Anschluss.
- Racor recto con conexión FASTEC.

Code	Size	Price	Class	Packaging
511115MP	FASTEC x 16/2	5,43 €	IM	40 / 160
511116MP	FASTEC x 16/2,25	5,43 €	IM	40 / 160
511117MP	FASTEC x 18/2	6,01 €	IM	40 / 160
511118MP	FASTEC x 20/2	6,01 €	IM	40 / 160
511119MP	FASTEC x 20/2,25	6,01 €	IM	40 / 160
511120MP	FASTEC x 20/2,5	6,01 €	IM	40 / 160
511121MP	FASTEC x 25/2,5	7,80 €	IM	30 / 120
511122MP	FASTEC x 26/3	7,80 €	IM	30 / 120

MP 5711

- Raccordo ad angolo maschio.
- Male angle fitting.
- Raccord à angle mâle.
- AG Winkel-Verbinder.
- Racor codo macho.

Code	Size	Price	Class	Packaging
511123MP	3/8" M x 16/2	5,38 €	IM	40 / 160
511001MP	1/2" M x 16/2	5,23 €	IM	40 / 160
511062MP	1/2" M x 16/2,25	5,23 €	IM	40 / 160
511021MP	1/2" M x 18/2	6,24 €	IM	30 / 120
511002MP	1/2" M x 20/2	6,24 €	IM	30 / 120
511063MP	1/2" M x 20/2,25	6,24 €	IM	30 / 120
511064MP	1/2" M x 20/2,5	6,24 €	IM	30 / 120
511003MP	3/4" M x 20/2	7,84 €	IM	20 / 80
511065MP	3/4" M x 20/2,25	7,84 €	IM	20 / 80
511066MP	3/4" x 20/2,5	7,84 €	IM	20 / 80
510141MP	3/4" M x 25/2,5	9,33 €	IM	20 / 80
511004MP	3/4" M x 26/3	9,33 €	IM	20 / 80
510229MP	1" M x 25/2,5	14,46 €	IM	15 / 120
511113MP	1" M x 26/3	14,46 €	IM	10 / 40
511013MP	1" M x 32/3	15,81 €	IM	10 / 40
510033	1"1/4 M x 40/3,5	36,35 €	IB	30
510034	1"1/2 M x 50/4	57,57 €	IB	15
510057	2" M x 63/4,5	87,51 €	IB	10

MP 5721

- Raccordo a T maschio.
- Male tee fitting.
- Raccord à T mâle.
- AG T-Stück.
- Racor Te rosca macho.

Code	Size	Price	Class	Packaging
512029MP	16/2 x 1/2" M x 16/2	9,53 €	IM	20 / 80
512066MP	18/2 x 1/2" M x 18/2	10,59 €	IM	16 / 64
512030MP	20/2 x 1/2" M x 20/2	10,59 €	IM	16 / 64
511091MP	20/2,25 x 1/2" M x 20/2,25	10,59 €	IM	16 / 64
511092MP	20/2,5 x 1/2" M x 20/2,5	10,59 €	IM	16 / 64
512031MP	16/2 x 3/4" M x 16/2	11,57 €	IM	20 / 80
511101MP	18/2 x 3/4" M x 18/2	12,09 €	IM	16 / 64
512032MP	20/2 x 3/4" M x 20/2	12,09 €	IM	16 / 64
510161MP	25/2,5 x 3/4" M x 25/2,5	14,06 €	IM	10 / 40
512067MP	26/3 x 3/4" M x 26/3	14,06 €	IM	10 / 40



- È possibile ordinare questi articoli in versione Cuphin® CW724R (aggiungere il suffisso "C" al codice).
- It is possible to order these items in Cuphin® CW724R version (adding suffix "C" at the end of the code).
- Il est possible de commander ces articles en version Cuphin® CW724R (en ajoutant le suffixe «C» au code).
- Sie können diese Artikel in Cuphin® CW724R Ausführungen (Fügen Sie das „C“ Nachsilbe, um den Code) bestellen.
- Puede pedir estos artículos en la versión Cuphin® CW724R (sufijo "C" al final del código).

MP 5613



- Raccordo diritto femmina.
- Straight female fitting.
- Raccord droit femelle.
- Durchgang IG Verbinder.
- Racor recto hembra.

Code	Size	Price	Class	Packaging
510011MP	1/2" F x 16/2	4,684 €	IM	40 / 160
511040MP	1/2" F x 16/2,25	4,684 €	IM	40 / 160
510109MP	3/4" F x 16/2	6,19 €	IM	30 / 120
510045MP	1/2" F x 18/2	5,56 €	IM	40 / 160
510046MP	3/4" F x 18/2	6,59 €	IM	30 / 120
510012MP	1/2" F x 20/2	5,56 €	IM	40 / 160
511041MP	1/2" F x 20/2,25	5,56 €	IM	40 / 160
511042MP	1/2" F x 20/2,5	5,56 €	IM	40 / 160
510013MP	3/4" F x 20/2	6,59 €	IM	30 / 120
511044MP	3/4" F x 20/2,5	6,59 €	IM	30 / 120
510132MP	3/4" F x 25/2,5	7,56 €	IM	20 / 80
510133MP	1" F x 25/2,5	9,01 €	IM	15 / 60
510014MP	3/4" F x 26/3	7,56 €	IM	20 / 80
510047MP	1" F x 26/3	9,01 €	IM	15 / 60
510022MP	1" F x 32/3	11,27 €	IM	15 / 60
510183	1"1/4 F x 40/3,5	40,91 €	IB	30
510184	1"1/2 F x 50/4	56,60 €	IB	25
510185	2" F x 63/4,5	101,14 €	IB	10

MP 5712



- Raccordo ad angolo femmina.
- Female angle fitting.
- Raccord à angle femelle.
- IG Winkel-Verbinder.
- Racor codo hembra.

Code	Size	Price	Class	Packaging
511005MP	1/2" F x 16/2	4,911 €	IM	30 / 120
511056MP	1/2" F x 16/2,25	4,911 €	IM	30 / 120
511019MP	1/2" F x 18/2	5,99 €	IM	30 / 120
511006MP	1/2" F x 20/2	5,99 €	IM	30 / 120
511057MP	1/2" F x 20/2,25	5,99 €	IM	30 / 120
511058MP	1/2" F x 20/2,5	5,99 €	IM	30 / 120
511007MP	3/4" F x 20/2	7,71 €	IM	25 / 100
511059MP	3/4" F x 20/2,25	7,71 €	IM	25 / 100
511060MP	3/4" F x 20/2,5	7,71 €	IM	25 / 100
510142MP	3/4" F x 25/2,5	9,56 €	IM	20 / 80
511008MP	3/4" F x 26/3	9,56 €	IM	20 / 80
511114MP	1" F x 26/3	14,54 €	IM	10 / 40
511014MP	1" F x 32/3	14,63 €	IM	10 / 40
510186	1"1/4 F x 40/3,5	44,31 €	IB	30
510187	1"1/2 F x 50/4	68,47 €	IB	15
510188	2" F x 63/4,5	113,18 €	IB	10

MP 5717



- Raccordo ad angolo con dado girevole a tenuta piana.
- Angle fitting with flat seal and rotating nut.
- Raccord à angle avec écrou tournant à joint plat étanche.
- Winkel-Verbindungsstück mit flach abgedichteter drehbarer Mutter.
- Racor codo con arandela y junta de estanqueidad plana.

Code	Size	Price	Class	Packaging
512109MP	3/8" F x 16/2	8,52 €	IM	30 / 120
512033MP	1/2" F x 16/2	7,83 €	IM	30 / 120
512110MP	1/2" F x 20/2	10,45 €	IM	30 / 120
512034MP	3/4" F x 16/2	8,35 €	IM	30 / 120
512111MP	3/4" F x 20/2	8,97 €	IM	30 / 120
512112MP	3/4" F x 26/3	12,61 €	IM	20 / 80
512113MP	1" F x 26/3	13,22 €	IM	10 / 40

MP 5712 L



- Raccordo ad angolo femmina lungo.
- Female angle fitting long.
- Raccord à angle femelle long.
- IG Winkel-Verbinder lang.
- Racor codo hembra largo.

Code	Size	Price	Class	Packaging
511029MP	1/2" F x 16/2	5,50 €	IM	25 / 100
511061MP	1/2" F x 16/2,25	5,50 €	IM	25 / 100
511102MP	1/2" F x 18/2	6,57 €	IM	25 / 100
511103MP	1/2" F x 20/2	6,57 €	IM	25 / 100
511104MP	1/2" F x 20/2,25	6,57 €	IM	25 / 100
511105MP	1/2" F x 20/2,5	6,57 €	IM	25 / 100



- È possibile ordinare questi articoli in versione Cuphin® CW724R (aggiungere il suffisso "C" al codice).
- It is possible to order these items in Cuphin® CW724R version (adding suffix "C" at the end of the code).
- Il est possible de commander ces articles en version Cuphin® CW724R (en ajoutant le suffixe «C» au code).
- Sie können diese Artikel in Cuphin® CW724R Ausführungen (Fügen Sie das „C“ Nachsilbe, um den Code) bestellen.
- Puede pedir estos artículos en la versión Cuphin® CW724R (sufijo "C" al final del código).

MP 5722

- Raccordo a T femmina.
- Female tee fitting.
- Raccord à T femelle.
- IG T-Stück.
- Racor Te rosca hembra.

Code	Size	Price	Class	Packaging
512022MP	16/2 x 1/2" F x 16/2	8,58 €	IM	20 / 80
511083MP	16/2,25 x 1/2" F x 16/2,25	8,58 €	IM	20 / 80
512028MP	16/2 x 3/4" F x 16/2	9,93 €	IM	16 / 64
512065MP	18/2 x 1/2" F x 18/2	10,22 €	IM	16 / 64
512045MP	18/2 x 3/4" F x 18/2	12,31 €	IM	16 / 64
512027MP	20/2 x 1/2" F x 20/2	10,22 €	IM	16 / 64
511084MP	20/2,25 x 1/2" F x 20/2,25	10,22 €	IM	16 / 64
511085MP	20/2,5 x 1/2" F x 20/2,5	10,22 €	IM	16 / 64
512023MP	20/2 x 3/4" F x 20/2	12,31 €	IM	16 / 64
511089MP	20/2,5 x 3/4" F x 20/2,5	12,31 €	IM	16 / 64
510162MP	25/2,5 x 1/2" F x 20/2	14,61 €	IM	12 / 48
510163MP	25/2,5 x 1/2" F x 25/2,5	14,25 €	IM	12 / 48
510164MP	25/2,5 x 3/4" F x 25/2,5	13,42 €	IM	10 / 40
512047MP	26/3 x 1/2" F x 20/2	14,61 €	IM	12 / 48
512046MP	26/3 x 1/2" F x 26/3	14,25 €	IM	12 / 48
512042MP	26/3 x 3/4" F x 26/3	13,42 €	IM	10 / 40
512043MP	32/3 x 3/4" F x 32/3	22,05 €	IM	10 / 40
512044MP	32/3 x 1" F x 32/3	22,07 €	IM	10 / 40
512040	40/3,5 x 3/4" F x 40/3,5	55,95 €	IB	15
512087	40/3,5 x 1" F x 40/3,5	66,91 €	IB	20
512049	40/3,5 x 1"1/4 F x 40/3,5	62,75 €	IB	12
512041	50/4 x 3/4" F x 50/4	92,49 €	IB	12
512088	50/4 x 1" F x 50/4	91,19 €	IB	12
510115	50/4 x 1"1/4 F x 50/4	92,49 €	IB	12
511124	50/4 x 1"1/2 F x 50/4	79,62 €	IB	12
510060	63/4,5 x 1" F x 63/4,5	119,81 €	IB	8
510061	63/4,5 x 1"1/4 F x 63/4,5	119,81 €	IB	8
511125	63/4,5 x 2" F x 63/4,5	136,55 €	IB	8

MP 5703

- Raccordo diritto con dado girevole a tenuta piana.
- Straight fitting with flat seal and rotating nut.
- Raccord droit avec écrou tournant à joint plat étanche.
- Gerades Verbindungsstück mit flach abgedichteter drehbarer Mutter.
- Racor recto con arandela y junta de estanqueidad plana.

Code	Size	Price	Class	Packaging
510110MP	3/8" F x 16/2	5,57 €	IM	40 / 160
510085MP	1/2" F x 16/2	5,23 €	IM	40 / 160
510087MP	1/2" F x 20/2	6,14 €	IM	30 / 120
510076MP	3/4" F x 16/2	6,14 €	IM	30 / 120
510077MP	3/4" F x 18/2	6,64 €	IM	30 / 120
510078MP	3/4" F x 20/2	6,66 €	IM	30 / 120
510195MP	3/4" F x 20/2,5	6,66 €	IM	40 / 160
510171MP	3/4" F x 25/2,5	8,06 €	IM	30 / 120
510088MP	3/4" F x 26/3	8,06 €	IM	30 / 120
510172MP	1" F x 25/2,5	9,45 €	IM	25 / 100
510079MP	1" F x 26/3	9,45 €	IM	25 / 100
510089MP	1" F x 32/3	12,78 €	IM	20 / 80
510080MP	1"1/4 F x 32/3	13,98 €	IM	15 / 60
510081	1"1/2 F x 40/3,5	43,11 €	IB	40
510098	1"1/2 F x 50/4	64,99 €	IB	30
510082	1"3/4 F x 50/4	59,71 €	IB	30
510083	2" F x 63/4,5	99,06 €	IB	16

MP 5705

- Raccordo diritto con dado girevole.
- Straight fitting with rotating nut.
- Raccord droit avec écrou pivotant.
- Durchgang-Verbinder mit drehbarer Mutter.
- Racor recto con arandela.

Code	Size	Price	Class	Packaging
510017MP	EUROK x 16/2	6,15 €	IM	30 / 120
513020MP	EUROK x 18/2	7,12 €	IM	30 / 120
510018MP	EUROK x 20/2	7,12 €	IM	30 / 120

- È possibile ordinare questi articoli in versione Cuphin® CW724R (aggiungere il suffisso "C" al codice).
- It is possible to order these items in Cuphin® CW724R version (adding suffix "C" at the end of the code).
- Il est possible de commander ces articles en version Cuphin® CW724R (en ajoutant le suffixe «C» au code).
- Sie können diese Artikel in Cuphin® CW724R Ausführungen (Fügen Sie das „C“ Nachsilbe, um den Code) bestellen.
- Puede pedir estos artículos en la versión Cuphin® CW724R (sufijo "C" al final del código).

FOCUS: U-fittings

Besides the obvious objective of distributing water to any connected component while maintaining design temperatures and pressures, certainly one of the fundamental objectives for any plumbing system is to guarantee the best hygienic conditions possible by preserving the quality of the water coming from the water main.

A plumbing system comprises several sections of pipes: from the main distribution ring, the ascending or descending vertical sections, the horizontal distribution sections to the floors, including the connections to the terminal units (i.e. basins, baths, showers, etc.). To make these connections there are several possible options. The best known are connections to a bypass or manifold (Figures 1 and 2). However, there is always an aspect that should not be underestimated in these cases: those pipe segments serving rarely used components suffer from a lack of water circulation, meaning the water in these becomes stagnant. Stagnant water, i.e. the same water sitting inside pipes over a long period of time, encourages the proliferation of bacteria, including legionella, and should therefore be avoided as much as possible.

IVAR's MP range of fittings includes the 5780 series fitting, which is essential for installations such as those shown in Figures 3 and 4, i.e. to implement "series" and "ring" type distribution systems. In both cases, the goal of these configurations is to facilitate water circulation in the pipes, thus avoiding stagnation and reducing health risks. In the case of series distribution, the component used most frequently should be in the furthest position from the column (from the point of view of distribution) so that every time this is used, the water is replaced completely through circulation in all the branches. In the case of ring distribution, the use of any user component achieves the same result, making this distribution system the most effective for reducing hygienic risk. Depending on specific standard public health regulations, which differ from region to region, there may be a requirement to build facilities for hospitals and community structures using a ring distribution system, including an automatic withdrawal point activated by timer, to ensure periodic water circulation in the pipes as well as the extension up to the terminal units with a thermal disinfection cycle (otherwise limited to the main distribution sections).

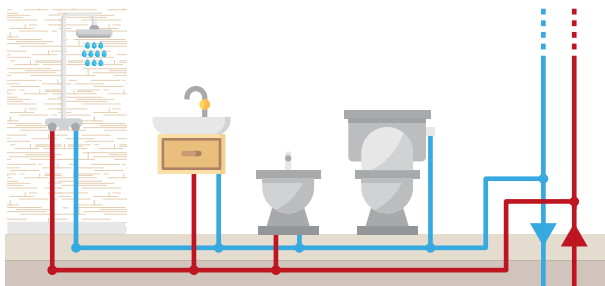

Figure 1. Bypass system

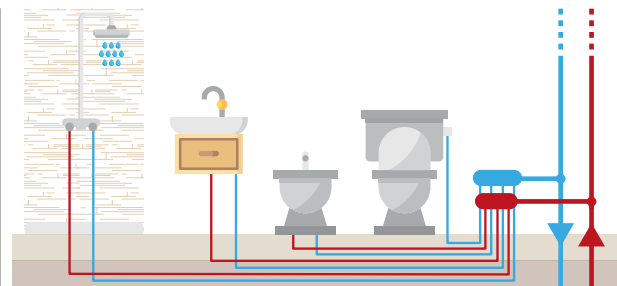

Figure 2. Manifold system

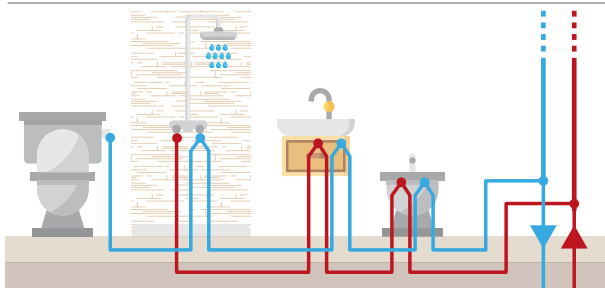

Figure 3. Series system

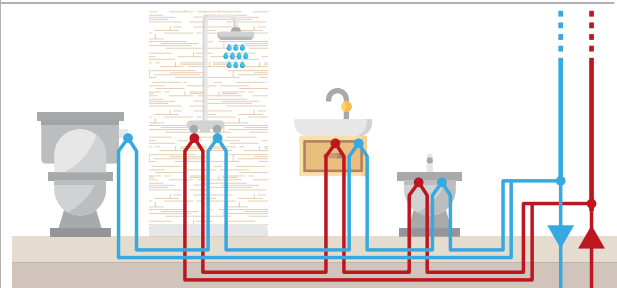

Figure 4. Ring system

MP 5780



- Raccordo murale doppio.
- Double wall fitting.
- Raccord mural double.
- Doppel Wand-Verbinder.
- Racor codo doble con base.

Code	Size	Price	Class	Packaging
510062MP	1/2" F x 16/2	24,42 €	IM	8 / 32
510064MP	1/2" F x 20/2	26,34 €	IM	8 / 32

MP 5781



- Raccordo murale doppio 90°.
- Double wall fitting 90°.
- Raccord mural double 90°.
- Doppel Wand-Verbinder 90°.
- Racor codo doble a 90° con base.

Code	Size	Price	Class	Packaging
511106MP	1/2" F x 16/2	16,40 €	IM	8 / 32
511108MP	1/2" F x 20/2	17,63 €	IM	8 / 32

- È possibile ordinare questi articoli in versione Cuphin® CW724R (aggiungere il suffisso "C" al codice).
- It is possible to order these items in Cuphin® CW724R version (adding suffix "C" at the end of the code).
- Il est possible de commander ces articles en version Cuphin® CW724R (en ajoutant le suffixe «C» au code).
- Sie können diese Artikel in Cuphin® CW724R Ausführungen (Fügen Sie das „C“ Nachsilbe, um den Code) bestellen.
- Puede pedir estos artículos en la versión Cuphin® CW724R (sufijo "C" al final del código).



MP 5760

- Raccordo murale.
- Wall fitting.
- Raccord mural.
- Wand-Verbinder.
- Racor codo con base.

Code	Size	Height	Price	Class	Packaging
513001CMP	1/2" F x 16/2	40 mm	8,44 €	IM	15 / 60
513014CMP	1/2" F x 18/2	40 mm	8,84 €	IM	15 / 60
513002CMP	1/2" F x 20/2	40 mm	8,84 €	IM	15 / 60
513001MP	1/2" F x 16/2	52 mm	8,61 €	IM	15 / 60
513001MPHD	1/2" F x 16/2 (Heavy version)	52 mm	9,90 €	IM	15 / 60
511096MP	1/2" F x 16/2,25	52 mm	8,61 €	IM	15 / 60
513014MP	1/2" F x 18/2	52 mm	9,62 €	IM	15 / 60
513002MP	1/2" F x 20/2	52 mm	9,62 €	IM	15 / 60
511097MP	1/2" F x 20/2,25	52 mm	9,62 €	IM	15 / 60
511098MP	1/2" F x 20/2,5	52 mm	9,62 €	IM	15 / 60
513003MP	3/4" F x 20/2	57 mm	12,58 €	IM	10 / 40
511099MP	3/4" F x 20/2,25	57 mm	12,58 €	IM	10 / 40
511100MP	3/4" F x 20/2,5	57 mm	12,58 €	IM	10 / 40
510167MP	3/4" F x 25/2,5	57 mm	13,31 €	IM	10 / 40
513004MP	3/4" F x 26/3	57 mm	13,31 €	IM	10 / 40
513001LMP	1/2" F x 16/2	77 mm	12,63 €	IM	10 / 40
513002LMP	1/2" F x 20/2	77 mm	13,10 €	IM	10 / 40

MP 5762

- Raccordi murali (kit con AS 1927).
- Wall fittings (kit with AS 1927).
- Raccords murals (kit avec AS 1927).
- Wand-Verbinder (Kit mit AS 1927).
- Brida y racores codo (conjunto con AS 1927).

Code	Size	Height	Price	Class	Packaging
513027CMP	1/2" F x 16/2	40 mm	27,00 €	IM	15
513028CMP	1/2" F x 18/2	40 mm	27,79 €	IM	15
513029CMP	1/2" F x 20/2	40 mm	27,79 €	IM	15
513027MP	1/2" F x 16/2	52 mm	27,33 €	IM	15
513028MP	1/2" F x 18/2	52 mm	29,35 €	IM	15
513029MP	1/2" F x 20/2	52 mm	29,35 €	IM	15
513027LMP	1/2" F x 16/2	77 mm	35,37 €	IM	15
513029LMP	1/2" F x 20/2	77 mm	36,30 €	IM	15

MP 5761

- Raccordi murali (kit con AS 1929).
- Wall fittings (kit with AS 1929).
- Raccords murals (kit avec AS 1929).
- Wand-Verbinder (Kit mit AS 1929).
- Brida y racores codo (conjunto con AS 1929).

Code	Size	Height	Price	Class	Packaging
513024CMP	1/2" F x 16/2	40 mm	23,54 €	IM	15
513026CMP	1/2" F x 18/2	40 mm	24,32 €	IM	15
513025CMP	1/2" F x 20/2	40 mm	24,32 €	IM	15
513024MP	1/2" F x 16/2	52 mm	23,89 €	IM	15
513026MP	1/2" F x 18/2	52 mm	25,87 €	IM	15
513025MP	1/2" F x 20/2	52 mm	25,87 €	IM	15
513024LMP	1/2" F x 16/2	77 mm	31,89 €	IM	15
513025LMP	1/2" F x 20/2	77 mm	32,80 €	IM	15

MP 5765

- Raccordi murali doppi (kit con AS 1929).
- Double wall fittings (kit with AS 1929).
- Raccords murals doubles (kit avec AS 1929).
- Doppel Wand-Verbinder (Kit mit AS 1929).
- Brida y racores codo dobles (conjunto con AS 1929).

Code	Size	Price	Class	Packaging
513036MP	1/2" F x 16/2	55,51 €	IM	15
513038MP	1/2" F x 20/2	59,33 €	IM	15

MP 5766

- Raccordi murali doppi (kit con AS 1927).
- Double wall fittings (kit with AS 1927).
- Raccords murals doubles (kit avec AS 1927).
- Doppel Wand-Verbinder (Kit mit AS 1927).
- Brida y racores codo dobles (conjunto con AS 1927).

Code	Size	Price	Class	Packaging
513039MP	1/2" F x 16/2	59,00 €	IM	15
513041MP	1/2" F x 20/2	62,81 €	IM	15

MP 5769

- Raccordi murali doppi 90° (kit con AS 1929).
- Double wall fittings 90° (kit with AS 1929).
- Raccords murals doubles 90° (kit avec AS 1929).
- Doppel Wand-Verbinder 90° (Kit mit AS 1929).
- Brida y racores codo dobles a 90° (conjunto con AS 1929).

Code	Size	Price	Class	Packaging
511109MP	1/2" F x 16/2	39,45 €	IM	15
511111MP	1/2" F x 20/2	41,90 €	IM	15

• È possibile ordinare questi articoli in versione Cuphin® CW724R (aggiungere il suffisso "C" al codice).
 • It is possible to order these items in Cuphin® CW724R version (adding suffix "C" at the end of the code).
 • Il est possible de commander ces articles en version Cuphin® CW724R (en ajoutant le suffixe «C» au code).
 • Sie können diese Artikel in Cuphin® CW724R Ausführungen (Fügen Sie das „C“ Nachsilbe, um den Code) bestellen.
 • Puede pedir estos artículos en la versión Cuphin® CW724R (sufijo "C" al final del código).



MP 5723



- Raccordo murale per tracce orizzontali.
- Wall fitting for horizontal chases.
- Raccord mural pour traces horizontales.
- Wand-Verbinder für waagerechte Rohrgänge.
- Racor con base para rozas horizontales.

Code	Size	Price	Class	Packaging
513005MP	16/2 x 1/2" F x 16/2	16,03 €	IM	12 / 48
513007MP	20/2 x 1/2" F x 20/2	16,70 €	IM	12 / 48

MP 5725



- Terminale murale sinistro per tracce orizzontali.
- Left wall terminal for horizontal chases.
- Partie terminale murale gauche pour traces horizontales.
- Links Wandanschluss für waagerechte Rohrgänge.
- Racor terminal con base izquierdo para rozas horizontales.

Code	Size	Price	Class	Packaging
513008MP	1/2" F x 16/2	14,32 €	IM	12 / 48
513010MP	1/2" F x 18/2	14,62 €	IM	12 / 48
513012MP	1/2" F x 20/2	14,62 €	IM	10 / 40

MP 5764



- Terminali murali per tracce orizzontali (kit con AS 1928).
- Wall terminals for horizontal chases (kit with AS 1928).
- Parties terminales murale pour traces horizontales (kit avec AS 1928).
- Wandanschlüsse für waagerechte Rohrgänge (Kit mit AS 1928).
- Brida y racores terminales con base para rozas horizontales (conjunto con AS 1928).

Code	Size	Price	Class	Packaging
513033MP	1/2" F x 16/2	34,54 €	IM	15
513034MP	1/2" F x 18/2	35,15 €	IM	15
513035MP	1/2" F x 20/2	35,15 €	IM	15

MP 5701



- Tappo.
- Plug.
- Bouchon.
- Verschluss.
- Tapón.

Code	Size	Price	Class	Packaging
510071MP	16/2	4,708 €	IM	40 / 160
510073MP	20/2	6,19 €	IM	40 / 160
510170MP	25/2,5	8,66 €	IM	35 / 140
510074MP	26/3	8,66 €	IM	35 / 140
510075MP	32/3	11,89 €	IM	20 / 80

MP 5763



- Raccordi murali per tracce orizzontali (kit con AS 1928).
- Wall fittings for horizontal chases (kit with AS 1928).
- Raccords muralis pour traces horizontales (kit avec AS 1928).
- Wand-Verbinder für waagerechte Rohrgänge (Kit mit AS 1928).
- Brida y racores con base para rozas horizontales (conjunto con AS 1928).

Code	Size	Price	Class	Packaging
513030MP	1/2" F x 16/2	37,99 €	IM	15
513032MP	1/2" F x 20/2	39,32 €	IM	15

MP 5724



- Terminale murale destro per tracce orizzontali.
- Right wall terminal for horizontal chases.
- Partie terminale murale droite pour traces horizontales.
- Rechts Wandanschluss für waagerechte Rohrgänge.
- Racor terminal con base derecho para rozas horizontales.

Code	Size	Price	Class	Packaging
513009MP	1/2" F x 16/2	14,32 €	IM	12 / 48
513011MP	1/2" F x 18/2	14,62 €	IM	12 / 48
513013MP	1/2" F x 20/2	14,62 €	IM	12 / 48

MP 5728



- Raccordo doppio T incrociato per impianti a battiscopa.
- Double crossed T fitting for skirting board plants.
- Raccord à double T croisé pour installations à la plinthe.
- Doppel T-Stück für Sockenleiste.
- Racor en Te doble cruzado para sistemas en zócalos.

Code	Size	Price	Class	Packaging
512080MP	16/2-16/2 x 16/2-16/2 x 16/2-16/2	51,66 €	IM	3 / 12
512082MP	20/2-20/2 x 16/2-16/2 x 20/2-20/2	53,51 €	IM	3 / 12
512083MP	20/2-20/2 x 16/2-16/2 x 16/2-16/2	52,59 €	IM	3 / 12
512084MP	16/2-16/2 x 20/2-20/2 x 16/2-16/2	52,59 €	IM	3 / 12
512085MP	20/2-20/2 x 20/2-20/2 x 20/2-20/2	54,44 €	IM	3 / 12
512086MP	20/2-20/2 x 20/2-20/2 x 16/2-16/2	53,51 €	IM	3 / 12
512096MP	16/2-16/2 x 16/2-16/2 x 20/2-20/2	52,59 €	IM	3 / 12
512097MP	16/2-16/2 x 20/2-20/2 x 20/2-20/2	53,51 €	IM	3 / 12

- È possibile ordinare questi articoli in versione Cuphin® CW724R (aggiungere il suffisso "C" al codice).
- It is possible to order these items in Cuphin® CW724R version (adding suffix "C" at the end of the code).
- Il est possible de commander ces articles en version Cuphin® CW724R (en ajoutant le suffixe «C» au code).
- Sie können diese Artikel in Cuphin® CW724R Ausführungen (Fügen Sie das „C“ Nachsilbe, um den Code) bestellen.
- Puede pedir estos artículos en la versión Cuphin® CW724R (sufijo "C" al final del código).

HIDDEN DISTRIBUTION FITTING

Multilayer pipes are installed in corrugated conduit in some systems, for example, when additional protection is required or in countries where installation regulations require the pipes to be removable. For connection to the terminal units in these cases, the MP 5610 series hidden distribution fittings are required. Made with a 1/2" F connection, these accommodate the corrugated protective conduit inside, keeping the pipe insulated up to the point of exit from the masonry wall. The CW617N brass fitting is fixed to the plastic box by a pair of screws, so that it can be easily disassembled for crimping and then reinserted in the box.



MP 5610 B



- Scatola di distribuzione sottotraccia con raccordo a pressare a 90°.
- Under-floor distribution box with 90° press-fitting.
- Boîte de distribution encastrée avec raccord à presser à 90°.
- Unter-Putzdose mit 90° Winkel-Pressfitting.
- Caja de distribución empotrable con racor a prensar a 90°.

Code	Size	Color	Price	Class	Packaging
500304MP	1/2" F x 16/2	■	10,98 €	IM	8 / 96
500306MP	1/2" F x 20/2	■	11,92 €	IM	8 / 96

MP 5610 R



- Scatola di distribuzione sottotraccia con raccordo a pressare a 90°.
- Under-floor distribution box with 90° press-fitting.
- Boîte de distribution encastrée avec raccord à presser à 90°.
- Unter-Putzdose mit 90° Winkel-Pressfitting.
- Caja de distribución empotrable con racor a prensar a 90°.

Code	Size	Color	Price	Class	Packaging
500304RMP	1/2" F x 16/2	■	10,98 €	IM	8 / 96
500306RMP	1/2" F x 20/2	■	11,92 €	IM	8 / 96

MP 5767



- Scatola di distribuzione sottotraccia con raccordo a pressare a 90° (Kit).
- Under-floor distribution box with 90° press-fitting (Kit).
- Boîte de distribution encastrée avec raccord à presser à 90° (Kit).
- Unter-Putzdose mit 90° Winkel-Pressfitting (Kit).
- Caja de distribución empotrable con racor a prensar a 90° (Kit).

Code	Size	Color	Price	Class	Packaging
513042MP	1/2" F x 16/2	■ - ■	24,36 €	IM	4 / 48
513044MP	1/2" F x 20/2	■ - ■	28,74 €	IM	4 / 48

AS 1925



- Dima frazionabile per scatole di distribuzione sottotraccia MP 5610 - SS 1711.
- Dividable template for under-floor distribution boxes MP 5610 - SS 1711.
- Platine de fixation pouvant être fractionnée pour les boîtes de distribution encastrée MP 5610 - SS 1711.
- Trennbare Halterung für Unterputz-Dose MP 5610 - SS 1711.
- Plantilla fraccionable para caja de distribución empotrables MP 5610 - SS 1711.

Code	Size	Price	Class	Packaging
501011	MP 5610 - SS 1711	2,882 €	JC	60

- È possibile ordinare questi articoli in versione Cuphin® CW724R (aggiungere il suffisso "C" al codice).
- It is possible to order these items in Cuphin® CW724R version (adding suffix "C" at the end of the code).
- Il est possible de commander ces articles en version Cuphin® CW724R (en ajoutant le suffixe «C» au code).
- Sie können diese Artikel in Cuphin® CW724R Ausführungen (Fügen Sie das „C“ Nachsilbe, um den Code) bestellen.
- Puede pedir estos artículos en la versión Cuphin® CW724R (sufijo "C" al final del código).

MP 5702



- Raccordo diritto con tubo in rame cromato.
- Straight fitting with copper chrome plated pipe.
- Raccord droit avec tube en cuivre chromé.
- Anschluss Durchgangsform mit verchromtem Kupferrohr.
- Racor recto con tubo de cobre cromado.

Code	Size	Price	Class	Packaging
510065MP	Ø15 x 16/2	10,57 €	IM	25 / 100
510090MP	Ø15 x 20/2	11,27 €	IM	25 / 100
510066MP	Ø18 x 20/2	11,77 €	IM	25 / 100
510091MP	Ø22 x 20/2	15,13 €	IM	20 / 80
510168MP	Ø22 x 25/2,5	15,73 €	IM	20 / 80
510067MP	Ø22 x 26/3	15,73 €	IM	20 / 80
510068MP	Ø28 x 32/3	19,29 €	IM	10 / 40

MP 5715



- Raccordo ad L con tubo di rame cromato.
- L fitting with chrome-plated copper pipe.
- Raccord en L avec tube en cuivre chromé.
- Winkel-Verbinder mit verchromtem Kupferrohr.
- Racor codo con tubo de cobre cromado.

Code	Size	Height	Price	Class	Packaging
511015MP	Ø15 x 16/2	165 mm	15,98 €	IM	100
511016MP	Ø15 x 16/2	345 mm	22,81 €	IM	60
511017MP	Ø15 x 16/2	1095 mm	54,77 €	IM	50
511025MP	Ø15 x 20/2	165 mm	18,54 €	IM	80
511026MP	Ø15 x 20/2	345 mm	25,26 €	IM	50
511027MP	Ø15 x 20/2	1095 mm	60,00 €	IM	50

MP 5716



- Raccordo a T con tubo in rame cromato.
- T fitting with chrome-plated copper pipe.
- Raccord à T avec tube en cuivre chromé.
- T-Stück mit verchromtem Kupferrohr.
- Racor en Te con tubo de cobre cromado.

Code	Size	Price	Class	Packaging
512077MP	16/2 x Ø15 x 16/2	27,55 €	IM	25
512079MP	20/2 x Ø15 x 20/2	28,43 €	IM	25

MP 5729



- Rubinetto da incasso con attacco press-fit DN 15, manopola e rosone cromati.
- Built-in valve with press-fitting connection DN 15, chromed knob and plate.
- Robinet d'encaissement avec embout de raccord à presser DN 15, poignée et rosace chromés.
- Wand-Armatur mit Pressfitting-Anschluss DN 15, verchromte Handknopf und Abdeckmanschette.
- Valvula de bola para empotrar con conexión press-fit DN 15, mando y rosetón cromados.

Code	Size	Price	Class	Packaging
510189MMP	16/2 - 16/2	45,14 €	IM	3 / 12
510192MMP	16/2,25 - 16/2,25	45,14 €	IM	3 / 12
510190MMP	18/2 - 18/2	46,26 €	IM	3 / 12
510191MMP	20/2 - 20/2	46,26 €	IM	3 / 12
510193MMP	20/2,25 - 20/2,25	46,26 €	IM	3 / 12
510194MMP	20/2,5 - 20/2,5	46,26 €	IM	3 / 12

MP 5730



- Rubinetto da incasso con attacco press-fit DN 15, cappuccio e rosone cromati.
- Built-in valve with press-fitting connection DN 15, chromed cap and plate.
- Robinet d'encaissement avec embout de raccord à presser DN 15, capuchon et rosace chromés.
- Wand-Armatur mit Pressfitting-Anschluss DN 15, verchromte Schutzkappe und Abdeckmanschette.
- Valvula de bola para empotrar con conexión press-fit DN 15, capota y rosetón cromado.

Code	Size	Price	Class	Packaging
510189CMP	16/2 - 16/2	37,32 €	IM	3 / 12
510192CMP	16/2,25 - 16/2,25	37,32 €	IM	3 / 12
510190CMP	18/2 - 18/2	38,47 €	IM	3 / 12
510191CMP	20/2 - 20/2	38,47 €	IM	3 / 12
510193CMP	20/2,25 - 20/2,25	38,47 €	IM	3 / 12
510194CMP	20/2,5 - 20/2,5	38,47 €	IM	3 / 12

AR 08 MP



- Boccole di ricambio per MULTI PRESS.
- Spare bushes for MULTI PRESS.
- Douilles de rechange pour MULTI PRESS.
- Ersatzhülsen für MULTI PRESS.
- Casquillo para MULTI PRESS.

Code	Size	Price	Class	Packaging
502120MP	16/2	1,57 €	IG	50
502121MP	18/2	1,713 €	IG	50
502122MP	20/2	1,713 €	IG	50
502123MP	25/2,5	2,383 €	IG	35
502124MP	26/3	2,383 €	IG	20
502125MP	32/3	2,599 €	IG	15
502126	40/3,5	5,39 €	IG	10
502127	50/4	7,67 €	IG	8
502128	63/4,5	10,93 €	IG	5

- È possibile ordinare questi articoli in versione Cuphin® CW724R (aggiungere il suffisso "C" al codice).
- It is possible to order these items in Cuphin® CW724R version (adding suffix "C" at the end of the code).
- Il est possible de commander ces articles en version Cuphin® CW724R (en ajoutant le suffixe «C» au code).
- Sie können diese Artikel in Cuphin® CW724R Ausführungen (Fügen Sie das „C“ Nachsilbe, um den Code) bestellen.
- Puede pedir estos artículos en la versión Cuphin® CW724R (sufijo "C" al final del código).

PRESS FITTINGS P•M•P

PLASTIC•MULTI•PRESS is the plastic press fitting designed and tested by IVAR for use with any of the 7 different crimping profiles (BE, B, TH, R, H, F and U). The body is made of PPSU, a plastic with high thermal resistance and mechanical strength that guarantees top performance and avoids problems related to corrosion that can occur with metal fittings. The material used complies with the public health regulations of several international bodies and therefore can be used for drinking water distribution. The geometry of the fitting, which was designed to provide optimal coupling between pipe and fitting after pressing and the windows on the bushing flange used to verify that the pipe and two peroxide EPDM O-rings on each end have been inserted properly are all details that help to ensure the applicability and reliability of the product.

They are available in a wide range of configurations (non-threaded figures) and sizes from 16/2 to 32/3.

Technical specifications:

Maximum operating temperature: 120 °C

Maximum operating static pressure: 10 bar

PLUS

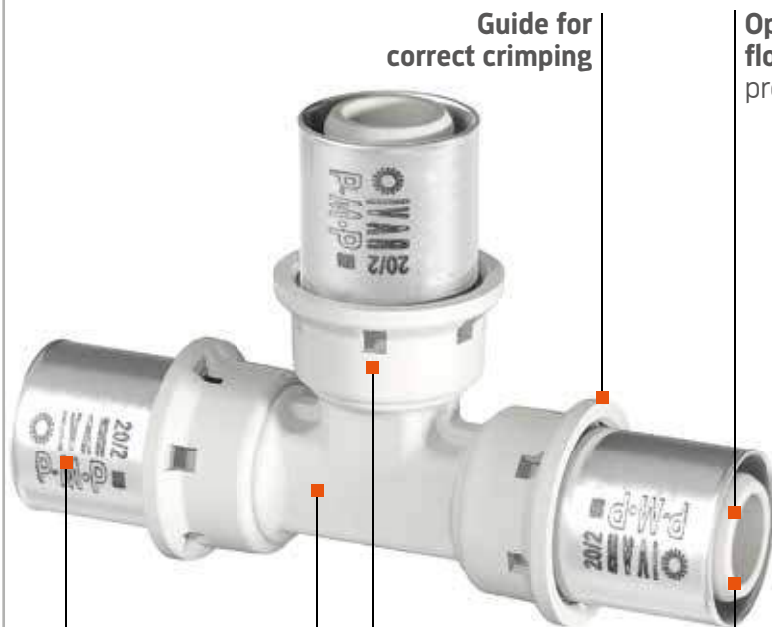

Guide for correct crimping

Optimized water flow (reduced pressure loss)



Solution-treated stainless steel to protect the crimper

Fitting can be rotated even after crimping

Extended slots to check for proper pipe insertion

Double O-Ring for maximum seal after crimping



Ø (mm)	16	20	25	26	32
Spessore Thickness Épaisseur Dicke Espesor (mm)	2	2	2,5	3	3
BE**	■	■	-	■	■
B***	■	■	-	■	■
F***	■	■	-	■	■
R**	■	■	■	■	■
H***	■	■	■	■	■
TH*	■	■	■	■	■
U*	■	■	■	-	■

* Rothenberger/Rems ** Rothenberger *** Rems

- Compatible with all TH - H/R - U - B/BE - F crimping profiles
- Maximum corrosion resistance
- Ø from 16 to 32 mm

PMP 5700 R



- **Raccordo diritto ridotto.**
- *Straight reduced fitting.*
- **Raccord droit réduit.**
- *Reduzierter Durchgangs-Verbinder.*
- **Racor recto reducido.**

Code	Size	Price	Class	Packaging
510008PMP	16/2 x 20/2	4,43 €	II	40 / 320
510135PMP	16/2 x 25/2,5	6,50 €	II	16 / 128
510009PMP	16/2 x 26/3	6,05 €	II	16 / 128
510137PMP	20/2 x 25/2,5	6,84 €	II	16 / 128
510010PMP	20/2 x 26/3	6,37 €	II	16 / 128
510023PMP	20/2 x 32/3	7,62 €	II	12 / 96
510138PMP	25/2,5 x 32/3	8,85 €	II	12 / 96
510019PMP	26/3 x 32/3	8,36 €	II	12 / 96

PMP 5700



- **Raccordo diritto.**
- *Straight fitting.*
- **Raccord droit.**
- *Kupplung.*
- **Racor recto.**

Code	Size	Price	Class	Packaging
510005PMP	16/2 x 16/2	5,30 €	II	40 / 320
510006PMP	20/2 x 20/2	7,92 €	II	24 / 192
510134PMP	25/2,5 x 25/2,5	9,83 €	II	16 / 128
510007PMP	26/3 x 26/3	8,97 €	II	16 / 128
510020PMP	32/3 x 32/3	12,49 €	II	12 / 96

PMP 5710



- **Raccordo ad angolo.**
- *Angle fitting.*
- **Raccord à angle.**
- *Winkel-Kupplung.*
- **Racor codo.**

Code	Size	Price	Class	Packaging
511009PMP	16/2 x 16/2	6,00 €	II	30 / 240
511010PMP	20/2 x 20/2	6,94 €	II	24 / 192
510140PMP	25/2,5 x 25/2,5	14,92 €	II	12 / 96
511011PMP	26/3 x 26/3	14,11 €	II	12 / 96
511012PMP	32/3 x 32/3	16,33 €	II	10 / 80

PMP 5720



- **Raccordo a T.**
- *Tee fitting.*
- **Raccord à T.**
- *T-Stück.*
- **Racor en Te.**

Code	Size	Price	Class	Packaging
512001PMP	16/2 x 16/2 x 16/2	5,99 €	II	20 / 160
512002PMP	20/2 x 20/2 x 20/2	10,40 €	II	14 / 112
510143PMP	25/2,5 x 25/2,5 x 25/2,5	16,61 €	II	8 / 64
512003PMP	26/3 x 26/3 x 26/3	15,33 €	II	8 / 64
512020PMP	32/3 x 32/3 x 32/3	21,80 €	II	6 / 48

PMP 5720 RLL



- **Raccordo a T con attacchi laterali ridotti.**
- *Tee fitting with reduced side connections.*
- **Raccord à T avec connexions latérales réduites.**
- *T-Stück mit reduzierten seitlichen Anschlüssen.*
- **Racor en Te con conexiones laterales reducidas.**

Code	Size	Price	Class	Packaging
512013PMP	16/2 x 20/2 x 16/2	7,24 €	II	14 / 112
510147PMP	20/2 x 25/2,5 x 20/2	10,85 €	II	8 / 64
512014PMP	20/2 x 26/3 x 20/2	10,40 €	II	8 / 64
512051PMP	20/2 x 32/3 x 20/2	12,89 €	II	6 / 48
510179PMP	25/2,5 x 32/3 x 25/2,5	15,14 €	II	6 / 48
512019PMP	26/3 x 32/3 x 26/3	14,27 €	II	6 / 48

PMP 5720 RCL



- **Raccordo a T con attacco centrale e laterale ridotti.**
- *Tee fitting with reduced central and side connection.*
- **Raccord à T avec connexion centrale et latérale réduites.**
- *T-Stück mit reduziertem Mittel- und Seitenanschluss.*
- **Racor en Te con conexión central y lateral reducida.**

Code	Size	Price	Class	Packaging
512009PMP	16/2 x 16/2 x 20/2	9,72 €	II	14 / 112
510154PMP	20/2 x 20/2 x 25/2,5	10,51 €	II	8 / 64
512012PMP	20/2 x 20/2 x 26/3	10,07 €	II	8 / 64
512021PMP	20/2 x 20/2 x 32/3	12,52 €	II	6 / 48
510155PMP	25/2,5 x 25/2,5 x 32/3	14,92 €	II	6 / 48
512017PMP	26/3 x 26/3 x 32/3	14,06 €	II	6 / 48

■ PMP 5720 RC

- **Raccordo a T con attacco centrale ridotto.**
- *Tee fitting with reduced central connection.*
- **Raccord à T avec connexion centrale réduite.**
- *T-Stück mit reduziertem Zentralanschluss.*
- **Racor en Te con conexión central reducida.**

Code	Size	Price	Class	Packaging
512004PMP	20/2 x 16/2 x 20/2	10,06 €	II	14 / 112
510144PMP	25/2,5 x 16/2 x 25/2,5	14,97 €	II	8 / 64
510146PMP	25/2,5 x 20/2 x 25/2,5	15,26 €	II	8 / 64
512005PMP	26/3 x 16/2 x 26/3	14,10 €	II	8 / 64
512006PMP	26/3 x 20/2 x 26/3	14,38 €	II	8 / 64
512015PMP	32/3 x 16/2 x 32/3	14,60 €	II	6 / 48
512016PMP	32/3 x 20/2 x 32/3	20,50 €	II	6 / 48
510174PMP	32/3 x 25/2,5 x 32/3	20,96 €	II	6 / 48
512018PMP	32/3 x 26/3 x 32/3	20,43 €	II	6 / 48

■ PMP 5720 RL

- **Raccordo a T con attacco laterale ridotto.**
- *Tee fitting with reduced side connection.*
- **Raccord à T avec connexion latérale réduite.**
- *T-Stück mit reduziertem seitlichen Anschluss.*
- **Racor en Te con conexión lateral reducida.**

Code	Size	Price	Class	Packaging
512007PMP	20/2 x 20/2 x 16/2	10,06 €	II	14 / 112
510148PMP	25/2,5 x 25/2,5 x 16/2	11,53 €	II	8 / 64
510150PMP	25/2,5 x 25/2,5 x 20/2	11,70 €	II	8 / 64
512048PMP	26/3 x 26/3 x 16/2	10,67 €	II	8 / 64
512008PMP	26/3 x 26/3 x 20/2	10,83 €	II	8 / 64
512052PMP	32/3 x 32/3 x 20/2	14,32 €	II	6 / 48
510151PMP	32/3 x 32/3 x 25/2,5	15,59 €	II	6 / 48
512053PMP	32/3 x 32/3 x 26/3	15,06 €	II	6 / 48

■ PMP 5720 RR

- **Raccordo a T con attacchi a doppia riduzione.**
- *Tee fitting with double reduction connections.*
- **Raccord à T avec des connexions à double réduction.**
- *T-Stück mit Doppel Reduktion Anschlüssen.*
- **Racor en Te con conexiones de doble reducción.**

Code	Size	Price	Class	Packaging
510157PMP	25/2,5 x 16/2 x 20/2	10,40 €	II	8 / 64
510158PMP	25/2,5 x 20/2 x 16/2	10,40 €	II	8 / 64
512010PMP	26/3 x 16/2 x 20/2	9,92 €	II	8 / 64
512011PMP	26/3 x 20/2 x 16/2	9,93 €	II	8 / 64
510159PMP	32/3 x 20/2 x 25/2,5	14,13 €	II	6 / 48
512050PMP	32/3 x 20/2 x 26/3	13,65 €	II	6 / 48
512024PMP	32/3 x 26/3 x 20/2	13,38 €	II	6 / 48

■ AR 08 PMP

- **Boccole di ricambio per PLASTIC MULTI PRESS.**
- *Spare bushes for PLASTIC MULTI PRESS.*
- **Douilles de rechange pour PLASTIC MULTI PRESS.**
- *Ersatzhülsen für PLASTIC MULTI PRESS.*
- **Casquillo para PLASTIC MULTI PRESS.**

Code	Size	Price	Class	Packaging
502120PMP	16/2	1,042 €	IG	50
502122PMP	20/2	1,414 €	IG	50
502123PMP	25/2,5	2,049 €	IG	50
502124PMP	26/3	2,049 €	IG	50
502125PMP	32/3	2,372 €	IG	50

PRESS FITTINGS M•P•L

MULTI PRESS LEAK is the new IVAR press fitting designed to ensure that water leaks if the press fitting was not crimped. It is for use with any of the 7 different crimping profiles (BE, B, TH, R, H, F and U). The absence of a seal if not crimped is a function particularly requested by the market to avoid problems and damage in the event that an installer forgets to crimp the fitting. A later installer will then be able to immediately identify any leaks and take remedial action by correctly crimping the fitting during the system test.

Its body is made of CW617N. Also available upon request is the version with a lead-free copper-silicon alloy or Cuphin® CW724R body, (add the suffix "C" to the code), which conforms to the positive lists of metal materials suitable for applications in contact with drinking water (4 MS Common Composition List and the UBA List defined by the German Federal Environment Agency).

Available in a broad range of configurations and sizes from 16/2 to 32/3.

Technical specifications:

Maximum operating temperature: 120 °C

Maximum operating static pressure: 10 bar

PLUS

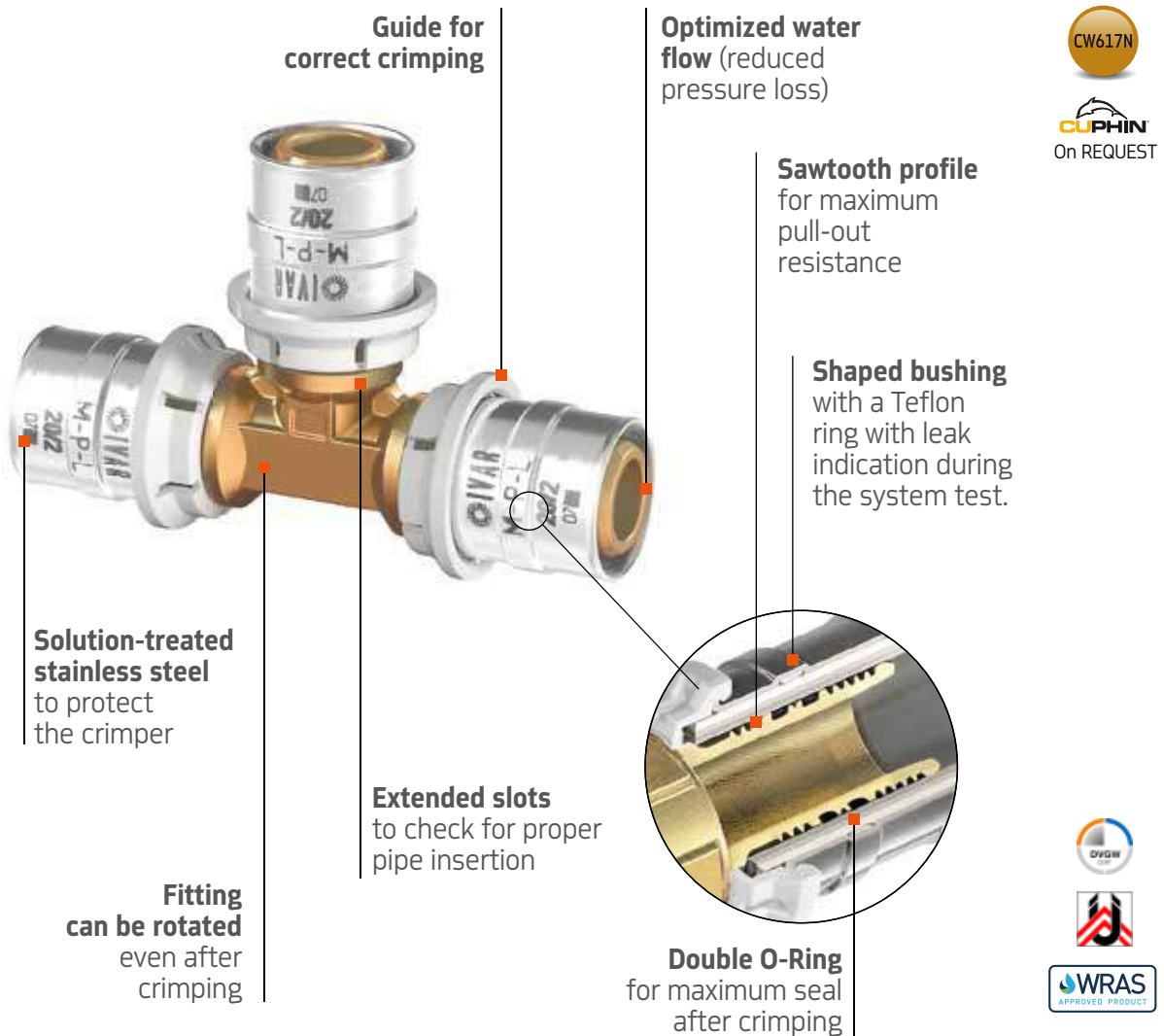

- **Compatible with all TH - H/R - U - B/BE - F crimping profiles**
- **Complete range of figures**
- **Ø from 16 to 32 mm**

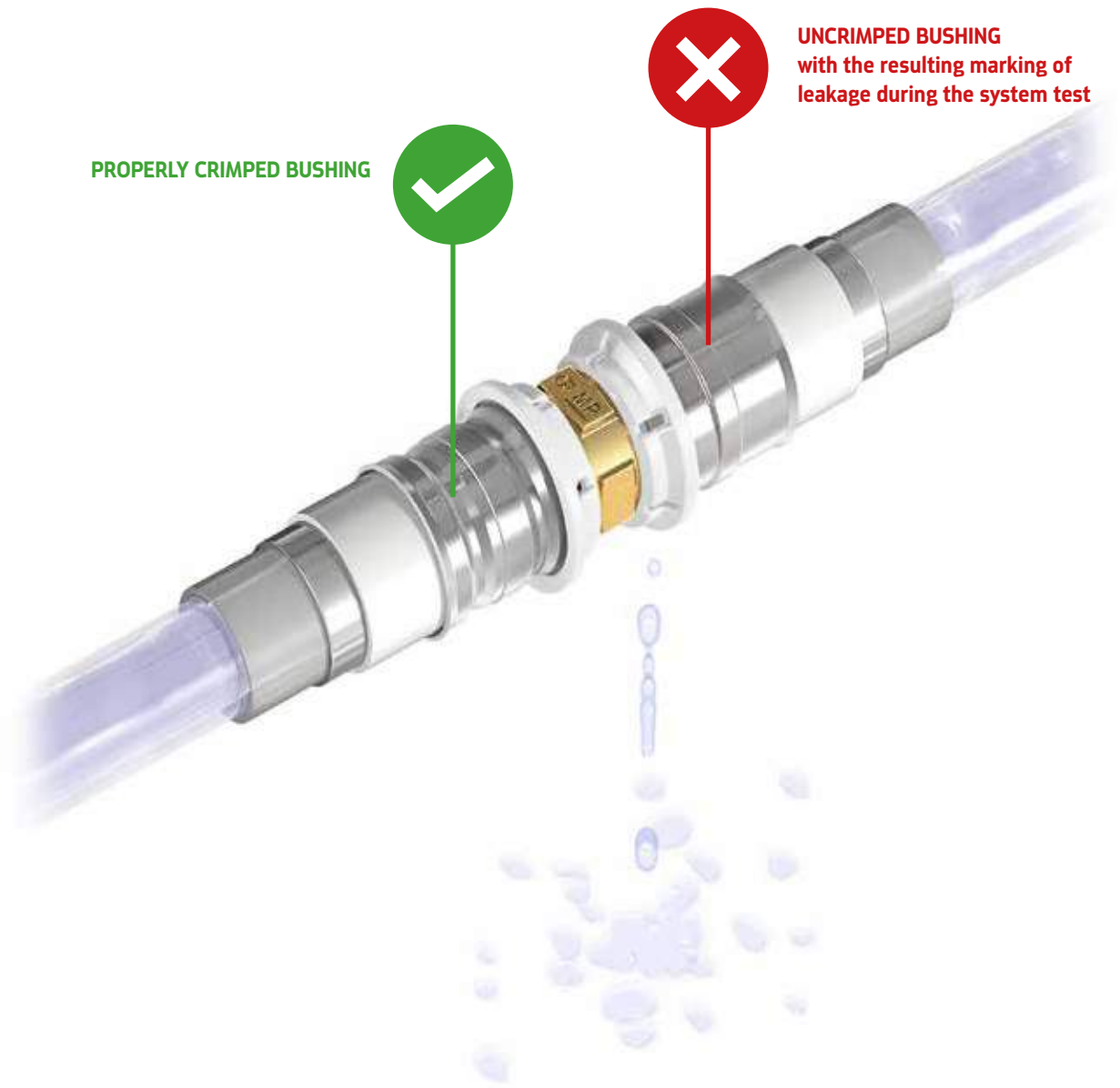

PROPERLY CRIMPED BUSHING



UNCRIMPED BUSHING
with the resulting marking of
leakage during the system test

Ø (mm)	16	20	26	32
Spessore Thickness Épaisseur Dicke Espesor (mm)	2 2,25	2 2,25 2,5	3	3
 BE**	■	■	■	■
B***	■	■	■	■
F***	■	■	■	■
R**	■	■	■	■
H***	■	■	■	■
TH*	■	■	■	■
U*	■	■	-	■

* Rothenberger/Rems

** Rothenberger

*** Rems

MPL 5700 R



- Raccordo diritto.
- Straight fitting.
- Raccord droit.
- Kupplung.
- Racor recto.

Code	Size	Price	Class	Packaging
510008MPL	16/2 x 20/2	7,15 €	I3	40 / 160
510009MPL	16/2 x 26/3	9,51 €	I3	20 / 80
510024MPL	16/2 x 32/3	12,43 €	I3	15 / 60
510010MPL	20/2 x 26/3	9,93 €	I3	20 / 80
510023MPL	20/2 x 32/3	13,25 €	I3	15 / 60
510019MPL	26/3 x 32/3	14,28 €	I3	15 / 60

MPL 5700



- Raccordo diritto.
- Straight fitting.
- Raccord droit.
- Kupplung.
- Racor recto.

Code	Size	Price	Class	Packaging
510005MPL	16/2 x 16/2	5,97 €	I3	40 / 160
510006MPL	20/2 x 20/2	7,79 €	I3	30 / 120
510007MPL	26/3 x 26/3	11,38 €	I3	20 / 80
510020MPL	32/3 x 32/3	16,59 €	I3	15 / 60

MPL 5710



- Raccordo ad angolo.
- Angle fitting.
- Raccord à angle.
- Winkel-Kupplung.
- Racor codo.

Code	Size	Price	Class	Packaging
511009MPL	16/2 x 16/2	6,85 €	I3	30 / 120
511010MPL	20/2 x 20/2	8,52 €	I3	30 / 120
511011MPL	26/3 x 26/3	12,53 €	I3	15 / 60
511012MPL	32/3 x 32/3	18,42 €	I3	10 / 40

MPL 5704



- Raccordo a 45°.
- 45° fitting.
- Raccord à 45°.
- Verbindungsstück 45°.
- Racor a 45°.

Code	Size	Price	Class	Packaging
510099MPL	26/3 x 26/3	16,51 €	I3	15 / 60
510100MPL	32/3 x 32/3	19,03 €	I3	10 / 40

MPL 5720



- Raccordo a T.
- Tee fitting.
- Raccord à T.
- T-Stück.
- Racor en Te.

Code	Size	Price	Class	Packaging
512001MPL	16/2 x 16/2 x 16/2	8,87 €	I3	20 / 80
512002MPL	20/2 x 20/2 x 20/2	12,34 €	I3	16 / 64
512003MPL	26/3 x 26/3 x 26/3	18,58 €	I3	10 / 40
512020MPL	32/3 x 32/3 x 32/3	29,17 €	I3	6 / 24

MPL 5720 RLL



- Raccordo a T con attacchi laterali ridotti.
- Tee fitting with reduced side connections.
- Raccord à T avec connexions latérales réduites.
- T-Stück mit reduzierten seitlichen Anschlüssen.
- Racor en Te con conexiones laterales reducidas.

Code	Size	Price	Class	Packaging
512013MPL	16/2 x 20/2 x 16/2	11,45 €	I3	16 / 64
512014MPL	20/2 x 26/3 x 20/2	17,03 €	I3	12 / 48
512051MPL	20/2 x 32/3 x 20/2	25,43 €	I3	8 / 32
512019MPL	26/3 x 32/3 x 26/3	26,51 €	I3	8 / 32



- È possibile ordinare questi articoli in versione Cuphin® CW724R (aggiungere il suffisso "C" al codice).
- It is possible to order these items in Cuphin® CW724R version (adding suffix "C" at the end of the code).
- Il est possible de commander ces articles en version Cuphin® CW724R (en ajoutant le suffixe «C» au code).
- Sie können diese Artikel in Cuphin® CW724R Ausführungen (Fügen Sie das „C“ Nachsilbe, um den Code) bestellen.
- Puede pedir estos artículos en la versión Cuphin® CW724R (sufijo "C" al final del código).

MPL 5720 RC

- Raccordo a T con attacco centrale ridotto.
- Tee fitting with reduced central connection.
- Raccord à T avec connexion centrale réduite.
- T-Stück mit reduziertem Zentralanschluss.
- Racor en Te con conexión central reducida.

Code	Size	Price	Class	Packaging
512004MPL	20/2 x 16/2 x 20/2	11,91 €	I3	16 / 64
512005MPL	26/3 x 16/2 x 26/3	17,03 €	I3	12 / 48
512006MPL	26/3 x 20/2 x 26/3	17,50 €	I3	12 / 48
512015MPL	32/3 x 16/2 x 32/3	24,02 €	I3	8 / 32
512016MPL	32/3 x 20/2 x 32/3	26,62 €	I3	8 / 32
512018MPL	32/3 x 26/3 x 32/3	27,96 €	I3	8 / 32

MPL 5720 RCL

- Raccordo a T con attacco centrale e laterale ridotto.
- Tee fitting with reduced central and side connection.
- Raccord à T avec connexion centrale et latérale réduites.
- T-Stück mit reduziertem Mittel- und Seitenanschluss.
- Racor en Te con conexión central y lateral reducida.

Code	Size	Price	Class	Packaging
512009MPL	16/2 x 16/2 x 20/2	11,45 €	I3	16 / 64
512012MPL	20/2 x 20/2 x 26/3	17,03 €	I3	12 / 48
512021MPL	20/2 x 20/2 x 32/3	25,43 €	I3	8 / 32
512017MPL	26/3 x 26/3 x 32/3	26,51 €	I3	8 / 32

MPL 5720 RL

- Raccordo a T con attacco laterale ridotto.
- Tee fitting with reduced side connection.
- Raccord à T avec connexion latérale réduite.
- T-Stück mit reduziertem seitlichen Anschluss.
- Racor en Te con conexión lateral reducida.

Code	Size	Price	Class	Packaging
512007MPL	20/2 x 20/2 x 16/2	11,91 €	I3	16 / 64
512048MPL	26/3 x 26/3 x 16/2	17,03 €	I3	12 / 48
512008MPL	26/3 x 26/3 x 20/2	17,49 €	I3	12 / 48
512068MPL	32/3 x 32/3 x 16/2	24,02 €	I3	8 / 32
512052MPL	32/3 x 32/3 x 20/2	26,62 €	I3	8 / 32
512053MPL	32/3 x 32/3 x 26/3	27,96 €	I3	8 / 32

MPL 5720 RR

- Raccordo a T con attacchi a doppia riduzione.
- Tee fitting with double reduction connections.
- Raccord à T avec des connexions à double réduction.
- T-Stück mit Doppel Reduktion Anschlüssen.
- Racor en Te con conexiones de doble reducción.

Code	Size	Price	Class	Packaging
512010MPL	26/3 x 16/2 x 20/2	15,49 €	I3	12 / 48
512011MPL	26/3 x 20/2 x 16/2	15,49 €	I3	12 / 48
512050MPL	32/3 x 20/2 x 26/3	25,64 €	I3	8 / 32
512024MPL	32/3 x 26/3 x 20/2	25,64 €	I3	8 / 32

MPL 5729

- Rubinetto da incasso con attacco press-fit DN 15, manopola e rosone cromati.
- Built-in valve with press-fitting connection DN 15, chromed knob and plate.
- Robinet d'encaissement avec embout de raccord à presser DN 15, poignée et rosace chromés.
- Wand-Armatur mit Pressfitting-Anschluss DN 15, verchromte Handknopf und Abdeckmanschette.
- Valvula de bola para empotrar con conexión press-fit DN 15, mando y rosetón cromados.

Code	Size	Price	Class	Packaging
510189MMPL	16/2 - 16/2	40,25 €	I3	3 / 12
510191MMPL	20/2 - 20/2	41,61 €	I3	3 / 12

MPL 5730

- Rubinetto da incasso con attacco press-fit DN 15, cappuccio e rosone cromati.
- Built-in valve with press-fitting connection DN 15, chromed cap and plate.
- Robinet d'encaissement avec embout de raccord à presser DN 15, capuchon et rosace chromés.
- Wand-Armatur mit Pressfitting-Anschluss DN 15, verchromte Schutzkappe und Abdeckmanschette.
- Valvula de bola para empotrar con conexión press-fit DN 15, capota y rosetón cromado.

Code	Size	Price	Class	Packaging
510189CMPL	16/2 - 16/2	45,70 €	I3	3 / 12
510191CMPL	20/2 - 20/2	46,94 €	I3	3 / 12



- È possibile ordinare questi articoli in versione Cuphin® CW724R (aggiungere il suffisso "C" al codice).
- It is possible to order these items in Cuphin® CW724R version (adding suffix "C" at the end of the code).
- Il est possible de commander ces articles en version Cuphin® CW724R (en ajoutant le suffixe «C» au code).
- Sie können diese Artikel in Cuphin® CW724R Ausführungen (Fügen Sie das „C“ Nachsilbe, um den Code) bestellen.
- Puede pedir estos artículos en la versión Cuphin® CW724R (sufijo "C" al final del código).

■ MPL 5608



- Raccordo diritto maschio.
- Straight male fitting.
- Raccord droit mâle.
- Durchgang AG Verbinder.
- Racor recto macho.

Code	Size	Price	Class	Packaging
510084MPL	3/8" M x 16/2	6,06 €	I3	50 / 200
510001MPL	1/2" M x 16/2	4,468 €	I3	40 / 160
510105MPL	3/4" M x 16/2	6,87 €	I3	30 / 120
510002MPL	1/2" M x 20/2	5,20 €	I3	40 / 160
510003MPL	3/4" M x 20/2	6,53 €	I3	30 / 120
510004MPL	3/4" M x 26/3	8,44 €	I3	30 / 120
510044MPL	1" M x 26/3	10,49 €	I3	20 / 80
510021MPL	1" M x 32/3	12,62 €	I3	20 / 80
510106MPL	1"1/4 M x 32/3	26,75 €	I3	10 / 40

■ MPL 5613



- Raccordo diritto femmina.
- Straight female fitting.
- Raccord droit femelle.
- Durchgang IG Verbinder.
- Racor recto hembra.

Code	Size	Price	Class	Packaging
510011MPL	1/2" F x 16/2	4,958 €	I3	40 / 160
510109MPL	3/4" F x 16/2	6,46 €	I3	30 / 120
510012MPL	1/2" F x 20/2	5,91 €	I3	40 / 160
510013MPL	3/4" F x 20/2	6,94 €	I3	30 / 120
510014MPL	3/4" F x 26/3	7,97 €	I3	20 / 80
510047MPL	1" F x 26/3	9,41 €	I3	15 / 60
510022MPL	1" F x 32/3	11,75 €	I3	15 / 60

■ MPL 5711



- Raccordo ad angolo maschio.
- Male angle fitting.
- Raccord à angle mâle.
- AG Winkel-Verbinder.
- Racor codo macho.

Code	Size	Price	Class	Packaging
511001MPL	1/2" M x 16/2	5,51 €	I3	40 / 160
511002MPL	1/2" M x 20/2	6,58 €	I3	30 / 120
511003MPL	3/4" M x 20/2	8,18 €	I3	20 / 80
511004MPL	3/4" M x 26/3	9,74 €	I3	20 / 80
511113MPL	1" M x 26/3	14,88 €	I3	10 / 40
511013MPL	1" M x 32/3	16,29 €	I3	10 / 40

■ MPL 5712



- Raccordo ad angolo femmina.
- Female angle fitting.
- Raccord à angle femelle.
- IG Winkel-Verbinder.
- Racor codo hembra.

Code	Size	Price	Class	Packaging
511005MPL	1/2" F x 16/2	5,19 €	I3	30 / 120
511006MPL	1/2" F x 20/2	6,34 €	I3	30 / 120
511007MPL	3/4" F x 20/2	8,06 €	I3	25 / 100
511008MPL	3/4" F x 26/3	9,97 €	I3	20 / 80
511114MPL	1" F x 26/3	14,95 €	I3	10 / 40
511014MPL	1" F x 32/3	15,12 €	I3	10 / 40

■ MPL 5721



- Raccordo a T maschio.
- Male tee fitting.
- Raccord à T mâle.
- AG T-Stück.
- Racor Te rosca macho.

Code	Size	Price	Class	Packaging
512029MPL	16/2 x 1/2" M x 16/2	10,06 €	I3	20 / 80
512031MPL	16/2 x 3/4" M x 16/2	12,12 €	I3	20 / 80
512030MPL	20/2 x 1/2" M x 20/2	11,27 €	I3	16 / 64
512032MPL	20/2 x 3/4" M x 20/2	12,77 €	I3	16 / 64
512067MPL	26/3 x 3/4" M x 26/3	14,89 €	I3	10 / 40

■ MPL 5712 L



- Raccordo ad angolo femmina lungo.
- Female angle fitting long.
- Raccord à angle femelle long.
- IG Winkel-Verbinder lang.
- Racor codo hembra largo.

Code	Size	Price	Class	Packaging
511029MPL	1/2" F x 16/2	5,77 €	I3	25 / 100
511103MPL	1/2" F x 20/2	6,92 €	I3	25 / 100

• È possibile ordinare questi articoli in versione Cuphin® CW724R (aggiungere il suffisso "C" al codice).
 • It is possible to order these items in Cuphin® CW724R version (adding suffix "C" at the end of the code).
 • Il est possible de commander ces articles en version Cuphin® CW724R (en ajoutant le suffixe «C» au code).
 • Sie können diese Artikel in Cuphin® CW724R Ausführungen (Fügen Sie das „C“ Nachsilbe, um den Code) bestellen.
 • Puede pedir estos artículos en la versión Cuphin® CW724R (sufijo "C" al final del código).



MPL 5722

- Raccordo a T femmina.
- Female tee fitting.
- Raccord à T femelle.
- IG T-Stück.
- Racor Te rosca hembra.

Code	Size	Price	Class	Packaging
512022MPL	16/2 x 1/2" F x 16/2	9,13 €	I3	20 / 80
512028MPL	16/2 x 3/4" F x 16/2	10,49 €	I3	16 / 64
512027MPL	20/2 x 1/2" F x 20/2	10,90 €	I3	16 / 64
512023MPL	20/2 x 3/4" F x 20/2	12,97 €	I3	16 / 64
512047MPL	26/3 x 1/2" F x 20/2	15,37 €	I3	12 / 48
512046MPL	26/3 x 1/2" F x 26/3	15,09 €	I3	12 / 48
512042MPL	26/3 x 3/4" F x 26/3	14,24 €	I3	10 / 40
512043MPL	32/3 x 3/4" F x 32/3	23,01 €	I3	10 / 40
512044MPL	32/3 x 1" F x 32/3	23,02 €	I3	10 / 40

MPL 5609

- Raccordo diritto maschio a tenuta morbida.
- Straight male soft seal fitting.
- Raccord droit mâle à étanchéité souple.
- Durchgang AG Verbinder mit O-Ring.
- Racor recto macho con junta blanda.

Code	Size	Price	Class	Packaging
510048MPL	1/2" M O-ring x 16/2	5,50 €	I3	40 / 160
510050MPL	1/2" M O-ring x 20/2	6,05 €	I3	40 / 160

MPL 5607

- Raccordo diritto con attacco FASTEC.
- Straight fitting with FASTEC connection.
- Raccord droit avec embout FASTEC.
- Durchgang Verbinder mit FASTEC Anschluß.
- Racor recto con conexión FASTEC.

Code	Size	Price	Class	Packaging
511115MPL	FASTEC x 16/2	5,71 €	I3	40 / 160
511118MPL	FASTEC x 20/2	6,36 €	I3	40 / 160
511122MPL	FASTEC x 26/3	8,20 €	I3	30 / 120

MPL 5703

- Raccordo diritto con dado girevole a tenuta piana.
- Straight fitting with flat seal and rotating nut.
- Raccord droit avec écrou tournant à joint plat étanche.
- Gerades Verbindungsstück mit flach abgedichteter drehbarer Mutter.
- Racor recto con arandela y junta de estanqueidad plana.

Code	Size	Price	Class	Packaging
510110MPL	3/8" F x 16/2	5,84 €	I3	40 / 160
510085MPL	1/2" F x 16/2	5,51 €	I3	40 / 160
510076MPL	3/4" F x 16/2	6,41 €	I3	30 / 120
510078MPL	3/4" F x 20/2	6,99 €	I3	30 / 120
510087MPL	1/2" F x 20/2	6,47 €	I3	30 / 120
510088MPL	3/4" F x 26/3	8,45 €	I3	30 / 120
510079MPL	1" F x 26/3	9,86 €	I3	25 / 100
510089MPL	1" F x 32/3	13,25 €	I3	20 / 80
510080MPL	1"1/4 F x 32/3	14,46 €	I3	15 / 60

MPL 5705

- Raccordo diritto con dado girevole.
- Straight fitting with rotating nut.
- Raccord droit avec écrou pivotant.
- Durchgang-Verbinder mit drehbarer Mutter.
- Racor recto con arandela.

Code	Size	Price	Class	Packaging
510017MPL	EUROK x 16/2	6,42 €	I3	30 / 120
510018MPL	EUROK x 20/2	7,46 €	I3	30 / 120

MPL 5717

- Raccordo ad angolo con dado girevole a tenuta piana.
- Angle fitting with flat seal and rotating nut.
- Raccord à angle avec écrou tournant à joint plat étanche.
- Winkel-Verbindungsstück mit flach abgedichteter drehbarer Mutter.
- Racor codo con arandela y junta de estanqueidad plana.

Code	Size	Price	Class	Packaging
512033MPL	1/2" F x 16/2	8,11 €	I3	30 / 120
512034MPL	3/4" F x 16/2	8,62 €	I3	30 / 120

- È possibile ordinare questi articoli in versione Cuphin® CW724R (aggiungere il suffisso "C" al codice).
- It is possible to order these items in Cuphin® CW724R version (adding suffix "C" at the end of the code).
- Il est possible de commander ces articles en version Cuphin® CW724R (en ajoutant le suffixe «C» au code).
- Sie können diese Artikel in Cuphin® CW724R Ausführungen (Fügen Sie das „C“ Nachsilbe, um den Code) bestellen.
- Puede pedir estos artículos en la versión Cuphin® CW724R (sufijo "C" al final del código).



FOCUS: U-fittings

See page 96.

MPL 5780



- Raccordo murale doppio.
- Double wall fitting.
- Raccord mural double.
- Doppel Wand-Verbinder.
- Racor codo doble con base.

Code	Size	Price	Class	Packaging
510062MPL	1/2" F x 16/2	24,96 €	I3	8 / 32
510064MPL	1/2" F x 20/2	27,01 €	I3	8 / 32

MPL 5781



- Raccordo murale doppio 90°.
- Double wall fitting 90°.
- Raccord mural double 90°.
- Doppel Wand-Verbinder 90°.
- Racor codo doble a 90° con base.

Code	Size	Price	Class	Packaging
511106MPL	1/2" F x 16/2	16,95 €	I3	8 / 32
511108MPL	1/2" F x 20/2	18,31 €	I3	8 / 32

MPL 5765



- Raccordi murali doppi (kit con AS 1929).
- Double wall fittings (kit with AS 1929).
- Raccords murals doubles (kit avec AS 1929).
- Doppel Wand-Verbinder (Kit mit AS 1929).
- Brida y racores codo dobles (conjunto con AS 1929).

Code	Size	Price	Class	Packaging
513036MPL	1/2" F x 16/2	56,60 €	I3	15
513038MPL	1/2" F x 20/2	60,68 €	I3	15

MPL 5769



- Raccordi murali doppi 90° (kit con AS 1929).
- Double wall fittings 90° (kit with AS 1929).
- Raccords murals doubles 90° (kit avec AS 1929).
- Doppel Wand-Verbinder 90° (Kit mit AS 1929).
- Brida y racores codo dobles a 90° (conjunto con AS 1929).

Code	Size	Price	Class	Packaging
511109MPL	1/2" F x 16/2	40,53 €	I3	15
511111MPL	1/2" F x 20/2	43,27 €	I3	15

MPL 5766



- Raccordi murali doppi (kit con AS 1927).
- Double wall fittings (kit with AS 1927).
- Raccords murals doubles (kit avec AS 1927).
- Doppel Wand-Verbinder (Kit mit AS 1927).
- Brida y racores codo dobles (conjunto con AS 1927).

Code	Size	Price	Class	Packaging
513039MPL	1/2" F x 16/2	60,07 €	I3	15
513041MPL	1/2" F x 20/2	64,16 €	I3	15

MPL 5764



- Terminali murali per tracce orizzontali (kit con AS 1928).
- Wall terminals for horizontal chases (kit with AS 1928).
- Parties terminales murale pour traces horizontales (kit avec AS 1928).
- Wandanschlüsse für waagerechte Rohrgänge (Kit mit AS 1928).
- Brida y racores terminales con base para rozas horizontales (conjunto con AS 1928).

Code	Size	Price	Class	Packaging
513035MPL	1/2" F x 20/2	35,84 €	I3	15

MPL 5725



- Terminale murale sinistro per tracce orizzontali.
- Left wall terminal for horizontal chases.
- Partie terminale murale gauche pour traces horizontales.
- Links Wandanschluss für waagerechte Rohrgänge.
- Racor terminal con base izquierdo para rozas horizontales.

Code	Size	Price	Class	Packaging
513008MPL	1/2" F x 16/2	14,59 €	I3	12 / 48
513012MPL	1/2" F x 20/2	14,96 €	I3	10 / 40

MPL 5724



- Terminale murale destro per tracce orizzontali.
- Right wall terminal for horizontal chases.
- Partie terminale murale droite pour traces horizontales.
- Rechts Wandanschluss für waagerechte Rohrgänge.
- Racor terminal con base derecho para rozas horizontales.

Code	Size	Price	Class	Packaging
513009MPL	1/2" F x 16/2	14,59 €	I3	12 / 48
513013MPL	1/2" F x 20/2	14,96 €	I3	12 / 48



- È possibile ordinare questi articoli in versione Cuphin® CW724R (aggiungere il suffisso "C" al codice).
- It is possible to order these items in Cuphin® CW724R version (adding suffix "C" at the end of the code).
- Il est possible de commander ces articles en version Cuphin® CW724R (en ajoutant le suffixe «C» au code).
- Sie können diese Artikel in Cuphin® CW724R Ausführungen (Fügen Sie das „C“ Nachsilbe, um den Code) bestellen.
- Puede pedir estos artículos en la versión Cuphin® CW724R (sufijo "C" al final del código).

MPL 5760

- Raccordo murale.
- Wall fitting.
- Raccord mural.
- Wand-Verbinder.
- Racor codo con base.

Code	Size	Height	Price	Class	Packaging
513001CMPL	1/2" F x 16/2	40 mm	8,72 €	I3	15 / 60
513002CMPL	1/2" F x 20/2	40 mm	9,18 €	I3	15 / 60
513001MPL	1/2" F x 16/2	52 mm	8,89 €	I3	15 / 60
513002MPL	1/2" F x 20/2	52 mm	9,97 €	I3	15 / 60
513004MPL	3/4" F x 26/3	57 mm	13,72 €	I3	10 / 40
513003MPL	3/4" F x 20/2	57 mm	12,93 €	I3	10 / 40
513001LMPL	1/2" F x 16/2	77 mm	12,92 €	I3	10 / 40
513002LMPL	1/2" F x 20/2	77 mm	13,44 €	I3	10 / 40

MPL 5761

- Raccordi murali (kit con AS 1929).
- Wall fittings (kit with AS 1929).
- Raccords murals (kit avec AS 1929).
- Wand-Verbinder (Kit mit AS 1929).
- Brida y racores codo (conjunto con AS 1929).

Code	Size	Height	Price	Class	Packaging
513024CMPL	1/2" F x 16/2	40 mm	24,08 €	I3	15
513025CMPL	1/2" F x 20/2	40 mm	24,98 €	I3	15
513024MPL	1/2" F x 16/2	52 mm	24,42 €	I3	15
513025MPL	1/2" F x 20/2	52 mm	26,56 €	I3	15
513024LMPL	1/2" F x 16/2	77 mm	32,43 €	I3	15
513025LMPL	1/2" F x 20/2	77 mm	33,49 €	I3	15

MPL 5762

- Raccordi murali (kit con AS 1927).
- Wall fittings (kit with AS 1927).
- Raccords murals (kit avec AS 1927).
- Wand-Verbinder (Kit mit AS 1927).
- Brida y racores codo (conjunto con AS 1927).

Code	Size	Height	Price	Class	Packaging
513027CMPL	1/2" F x 16/2	40 mm	27,55 €	I3	15
513029CMPL	1/2" F x 20/2	40 mm	28,46 €	I3	15
513027MPL	1/2" F x 16/2	52 mm	27,89 €	I3	15
513029MPL	1/2" F x 20/2	52 mm	30,02 €	I3	15
513027LMPL	1/2" F x 16/2	77 mm	35,91 €	I3	15
513029LMPL	1/2" F x 20/2	77 mm	36,97 €	I3	15

MPL 5728

- Raccordo doppio T incrociato per impianti a battiscopa.
- Double crossed T fitting for skirting board plants.
- Raccord à double T croisé pour installations à la plinthe.
- Doppel T-Stück für Sockenleiste.
- Racor en Te doble cruzado para sistemas en zócalos.

Code	Size	Price	Class	Packaging
512080MPL	16/2-16/2 x 16/2-16/2 x 16/2-16/2	53,04 €	I3	3 / 12
512096MPL	16/2-16/2 x 16/2-16/2 x 20/2-20/2	54,03 €	I3	3 / 12
512084MPL	16/2-16/2 x 20/2-20/2 x 16/2-16/2	54,03 €	I3	3 / 12
512097MPL	16/2-16/2 x 20/2-20/2 x 20/2-20/2	55,14 €	I3	3 / 12
512083MPL	20/2-20/2 x 16/2-16/2 x 16/2-16/2	54,03 €	I3	3 / 12
512082MPL	20/2-20/2 x 16/2-16/2 x 20/2-20/2	55,14 €	I3	3 / 12
512086MPL	20/2-20/2 x 20/2-20/2 x 16/2-16/2	55,14 €	I3	3 / 12
512085MPL	20/2-20/2 x 20/2-20/2 x 20/2-20/2	55,87 €	I3	3 / 12

MPL 5763

- Raccordi murali per tracce orizzontali (kit con AS 1928).
- Wall fittings for horizontal chases (kit with AS 1928).
- Raccords murals pour traces horizontales (kit avec AS 1928).
- Wand-Verbinder für waagerechte Rohrgänge (Kit mit AS 1928).
- Brida y racores con base para rozas horizontales (conjunto con AS 1928).

Code	Size	Price	Class	Packaging
513030MPL	1/2" F x 16/2	39,09 €	I3	15
513032MPL	1/2" F x 20/2	40,68 €	I3	15

MPL 5701

- Tappo.
- Plug.
- Bouchon.
- Verschluss.
- Tapón.

Code	Size	Price	Class	Packaging
510071MPL	16/2	4,971 €	I3	40 / 160
510073MPL	20/2	6,54 €	I3	40 / 160
510074MPL	26/3	9,05 €	I3	35 / 140
510075MPL	32/3	12,36 €	I3	20 / 80

- È possibile ordinare questi articoli in versione Cuphin® CW724R (aggiungere il suffisso "C" al codice).
- It is possible to order these items in Cuphin® CW724R version (adding suffix "C" at the end of the code).
- Il est possible de commander ces articles en version Cuphin® CW724R (en ajoutant le suffixe «C» au code).
- Sie können diese Artikel in Cuphin® CW724R Ausführungen (Fügen Sie das „C“ Nachsilbe, um den Code) bestellen.
- Puede pedir estos artículos en la versión Cuphin® CW724R (sufijo "C" al final del código).

■ MPL 5702



- Raccordo diritto con tubo in rame cromato.
- Straight fitting with copper chrome plated pipe.
- Raccord droit avec tube en cuivre chromé.
- Anschluss Durchgangsform mit verchromtem Kupferrohr.
- Racor recto con tubo de cobre cromado.

Code	Size	Price	Class	Packaging
510065MPL	Ø15 x 16/2	10,84 €	I3	25 / 100
510090MPL	Ø15 x 20/2	11,61 €	I3	25 / 100
510066MPL	Ø18 x 20/2	12,12 €	I3	25 / 100
510091MPL	Ø22 x 20/2	15,48 €	I3	20 / 80
510067MPL	Ø22 x 26/3	16,14 €	I3	20 / 80
510068MPL	Ø28 x 32/3	19,75 €	I3	10 / 40

■ MPL 5715



- Raccordo ad L con tubo di rame cromato.
- L fitting with chrome-plated copper pipe.
- Raccord en L avec tube en cuivre chromé.
- Winkel-Verbinder mit verchromtem Kupferrohr.
- Racor codo con tubo de cobre cromado.

Code	Size	Height	Price	Class	Packaging
511015MPL	Ø15 x 16/2	165 mm	16,25 €	I3	100
511016MPL	Ø15 x 16/2	345 mm	23,10 €	I3	60
511017MPL	Ø15 x 16/2	1095 mm	56,61 €	I3	50
511025MPL	Ø15 x 20/2	165 mm	18,88 €	I3	80
511026MPL	Ø15 x 20/2	345 mm	25,65 €	I3	50
511027MPL	Ø15 x 20/2	1095 mm	60,46 €	I3	50

■ MPL 5716



- Raccordo a T con tubo in rame cromato.
- T fitting with chrome-plated copper pipe.
- Raccord à T avec tube en cuivre chromé.
- T-Stück mit verchromtem Kupferrohr.
- Racor en Te con tubo de cobre cromado.

Code	Size	Price	Class	Packaging
512079MPL	20/2 x Ø15 x 20/2	28,77 €	I3	25

■ AR 08 MPL



- Boccole di ricambio per MULTI PRESS LEAK.
- Spare bushes for MULTI PRESS LEAK.
- Douilles de rechange pour MULTI PRESS LEAK.
- Ersatzhülsen für MULTI PRESS LEAK.
- Casquillo para MULTI PRESS LEAK.

Code	Size	Price	Class	Packaging
502120MPL	16/2	1,904 €	IG	50
502122MPL	20/2	2,049 €	IG	50
502124MPL	26/3	2,731 €	IG	35
502125MPL	32/3	2,935 €	IG	15



- È possibile ordinare questi articoli in versione Cuphin® CW724R (aggiungere il suffisso "C" al codice).
- It is possible to order these items in Cuphin® CW724R version (adding suffix "C" at the end of the code).
- Il est possible de commander ces articles en version Cuphin® CW724R (en ajoutant le suffixe «C» au code).
- Sie können diese Artikel in Cuphin® CW724R Ausführungen (Fügen Sie das „C“ Nachsilbe, um den Code) bestellen.
- Puede pedir estos artículos en la versión Cuphin® CW724R (sufijo "C" al final del código).

PRESS FITTINGS P•M•P•L

PLASTIC MULTI PRESS LEAK is the new plastic press fitting designed and tested by IVAR to ensure that water leaks if the press fitting was not crimped. It is for use with any of the 7 different crimping profiles (BE, B, TH, R, H, F and U). The absence of a seal if not crimped is a function particularly requested by the market to avoid problems and damage in case someone forgot to crimp the fitting. An installer will be able to immediately identify any leaks and take remedial action by correctly crimping the fitting during the system test.

The body is made of PPSU, a plastic with high thermal and mechanical resistance that guarantees top performance and avoids problems related to corrosion that can occur with metal fittings. The material used complies with the public health regulations of several international bodies and therefore can be used for drinking water distribution. They are available in a wide range of configurations (non-threaded figures) and sizes from 16/2 to 32/3.

Technical specifications:

Maximum operating temperature: 120 °C
Maximum operating static pressure: 10 bar

 PROPERLY CRIMPED BUSHING

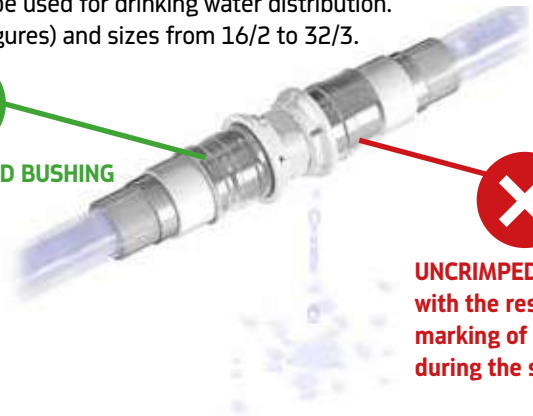

 UNCRIMPED BUSHING with the resulting marking of leakage during the system test

 PLUS

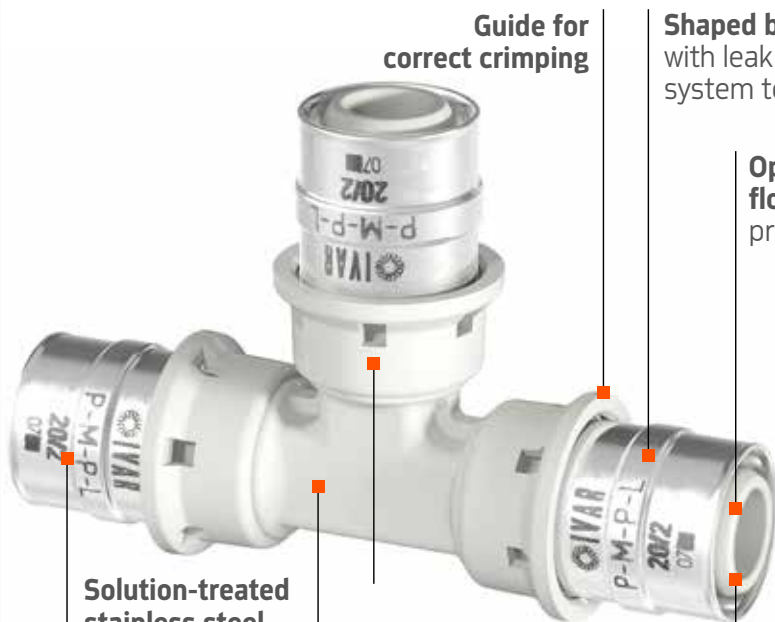

Guide for correct crimping

Shaped bushing with a Teflon ring with leak indication during the system test.

PPSU

Optimized water flow (reduced pressure loss)

Ø (mm)	16	20	26	32
Spessore (mm)	2	2	3	3
				
BE**	■	■	■	■
B***	■	■	■	■
F***	■	■	■	■
R**	■	■	■	■
H***	■	■	■	■
TH*	■	■	■	■
U*	■	■	-	■

*Rothenberger/Rems **Rothenberger ***Rems

Solution-treated stainless steel to protect the crimper

Extended slots to check for proper pipe insertion

Fitting can be rotated even after crimping

Double O-Ring for maximum seal after crimping



- Compatible with all TH - H/R - U - B/BE - F crimping profiles
- Maximum corrosion resistance
- Ø from 16 to 32 mm

■ PMPL 5700 R



- Raccordo diritto ridotto.
- Straight reduced fitting.
- Raccord droit réduit.
- Reduzierter Durchgangs-Verbinder.
- Racor recto reducido.

Code	Size	Price	Class	Packaging
510008PMPL	16/2 x 20/2	6,51 €	II	40 / 320
510009PMPL	16/2 x 26/3	8,35 €	II	16 / 128
510010PMPL	20/2 x 26/3	8,86 €	II	16 / 128
510023PMPL	20/2 x 32/3	10,48 €	II	12 / 96
510019PMPL	26/3 x 32/3	11,45 €	II	12 / 96

■ PMPL 5700



- Raccordo diritto.
- Straight fitting.
- Raccord droit.
- Kupplung.
- Racor recto.

Code	Size	Price	Class	Packaging
510005PMPL	16/2 x 16/2	5,91 €	II	40 / 320
510006PMPL	20/2 x 20/2	8,57 €	II	24 / 192
510007PMPL	26/3 x 26/3	9,67 €	II	16 / 128
510020PMPL	32/3 x 32/3	13,15 €	II	12 / 96

■ PMPL 5710



- Raccordo ad angolo.
- Angle fitting.
- Raccord à angle.
- Winkel-Kupplung.
- Racor codo.

Code	Size	Price	Class	Packaging
511009PMPL	16/2 x 16/2	6,61 €	II	30 / 240
511010PMPL	20/2 x 20/2	7,55 €	II	24 / 192
511011PMPL	26/3 x 26/3	14,83 €	II	12 / 96
511012PMPL	32/3 x 32/3	17,00 €	II	10 / 80

■ PMPL 5720



- Raccordo a T.
- Tee fitting.
- Raccord à T.
- T-Stück.
- Racor en Te.

Code	Size	Price	Class	Packaging
512001PMPL	16/2 x 16/2 x 16/2	6,89 €	II	20 / 160
512002PMPL	20/2 x 20/2 x 20/2	11,36 €	II	14 / 112
512003PMPL	26/3 x 26/3 x 26/3	16,39 €	II	8 / 64
512020PMPL	32/3 x 32/3 x 32/3	22,80 €	II	6 / 48

■ PMPL 5720 RLL



- Raccordo a T con attacchi laterali ridotti.
- Tee fitting with reduced side connections.
- Raccord à T avec connexions latérales réduites.
- T-Stück mit reduzierten seitlichen Anschlüssen.
- Racor en Te con conexiones laterales reducidas.

Code	Size	Price	Class	Packaging
512013PMPL	16/2 x 20/2 x 16/2	10,66 €	II	14 / 112
512014PMPL	20/2 x 26/3 x 20/2	14,70 €	II	8 / 64
512051PMPL	20/2 x 32/3 x 20/2	18,70 €	II	6 / 48
512019PMPL	26/3 x 32/3 x 26/3	20,19 €	II	6 / 48

■ PMPL 5720 RCL



- Raccordo a T con attacco centrale e laterale ridotti.
- Tee fitting with reduced central and side connection.
- Raccord à T avec connexion centrale et latérale réduites.
- T-Stück mit reduziertem Mittel- und Seitenanschluss.
- Racor en Te con conexión central y lateral reducida.

Code	Size	Price	Class	Packaging
512009PMPL	16/2 x 16/2 x 20/2	10,66 €	II	14 / 112
512012PMPL	20/2 x 20/2 x 26/3	14,24 €	II	8 / 64
512021PMPL	20/2 x 20/2 x 32/3	17,99 €	II	6 / 48
512017PMPL	26/3 x 26/3 x 32/3	19,84 €	II	6 / 48

PMPL 5720 RC

- Raccordo a T con attacco centrale ridotto.
- Tee fitting with reduced central connection.
- Raccord à T avec connexion centrale réduite.
- T-Stück mit reduziertem Zentralanschluss.
- Racor en Te con conexión central reducida.

Code	Size	Price	Class	Packaging
512004PMPL	20/2 x 16/2 x 20/2	11,01 €	II	14 / 112
512005PMPL	26/3 x 16/2 x 26/3	15,11 €	II	8 / 64
512006PMPL	26/3 x 20/2 x 26/3	15,41 €	II	8 / 64
512015PMPL	32/3 x 16/2 x 32/3	21,04 €	II	6 / 48
512016PMPL	32/3 x 20/2 x 32/3	21,49 €	II	6 / 48
512018PMPL	32/3 x 26/3 x 32/3	21,45 €	II	6 / 48

PMPL 5720 RR

- Raccordo a T con attacchi a doppia riduzione.
- Tee fitting with double reduction connections.
- Raccord à T avec des connexions à double réduction.
- T-Stück mit Doppel Reduktion Anschlüssen.
- Racor en Te con conexiones de doble reducción.

Code	Size	Price	Class	Packaging
512010PMPL	26/3 x 16/2 x 20/2	13,94 €	II	8 / 64
512011PMPL	26/3 x 20/2 x 16/2	13,94 €	II	8 / 64
512050PMPL	32/3 x 20/2 x 26/3	19,88 €	II	6 / 48
512024PMPL	32/3 x 26/3 x 20/2	19,01 €	II	6 / 48

PMPL 5720 RL

- Raccordo a T con attacco laterale ridotto.
- Tee fitting with reduced side connection.
- Raccord à T avec connexion latérale réduite.
- T-Stück mit reduziertem seitlichen Anschluss.
- Racor en Te con conexión lateral reducida.

Code	Size	Price	Class	Packaging
512007PMPL	20/2 x 20/2 x 16/2	11,01 €	II	14 / 112
512048PMPL	26/3 x 26/3 x 16/2	14,85 €	II	8 / 64
512008PMPL	26/3 x 26/3 x 20/2	15,11 €	II	8 / 64
512052PMPL	32/3 x 32/3 x 20/2	20,36 €	II	6 / 48
512053PMPL	32/3 x 32/3 x 26/3	21,18 €	II	6 / 48

AR 08 PMPL

- Boccole di ricambio per PLASTIC MULTI PRESS LEAK.
- Spare bushes for PLASTIC MULTI PRESS LEAK.
- Douilles de rechange pour PLASTIC MULTI PRESS LEAK.
- Ersatzhülsen für PLASTIC MULTI PRESS LEAK.
- Casquillo para PLASTIC MULTI PRESS LEAK.

Code	Size	Price	Class	Packaging
502120PMPL	16/2	2,049 €	IG	50
502122PMPL	20/2	2,18 €	IG	50
502124PMPL	26/3	2,862 €	IG	35
502125PMPL	32/3	3,067 €	IG	30

ACCESSORIES FOR M•P - M•P•L

AR 21



- Vitone per rubinetto da incasso serie MP/MPL 5729-5730.
- Headwork for built in valve series MP/MPL 5729-5730.
- Insert pour robinet à encastrement série MP/MPL 5729-5730.
- Reguliervorrichtung für Einbauhahn Serie MP/MPL 5729-5730.
- Montura para valvula de bola para empotrar serie MP/MPL 5729-5730.

Code	Size	Price	Class	Packaging
550196	DN 15	13,29 €	IG	20 / 160

AR 22



- Prolunga per rubinetto da incasso.
- Extension for built in valve.
- Rallonge pour robinet à encastrement.
- Verlängerung für Einbauhahn.
- Extensión para grifo empotrable.

Code	Size	Price	Class	Packaging
550199	DN 15	4,36 €	IG	50 / 400

AR 23



- Kit manopola e rosone cromati per rubinetto da incasso serie MP/MPL 5729-5730 con attacco press-fit DN 15.
- Kit chromed knob and plate for built-in valve series MP/MPL 5729-5730 with press-fitting connection DN 15.
- Kit poignée et rosace chromés pour robinet d'encaissement série MP/MPL 5729-5730 avec embout de raccord à presser DN 15.
- Kit verchromte Handknopf und Abdeckmanschette für Wand-Armatur Serie MP/MPL 5729-5730 mit Pressfitting-Anschluss DN 15.
- Kit mando y rosetón cromados para valvula de bola para empotrar serie MP/MPL 5729-5730 con conexión press-fit DN 15.

Code	Price	Class	Packaging
550198	24,97 €	IG	10 / 80

AR 24



- Kit cappuccio e rosone cromati per rubinetto da incasso serie MP/MPL 5729-5730 con attacco press-fit DN 15.
- Kit chromed cap and plate for built-in valve series MP/MPL 5729-5730 with press-fitting connection DN 15.
- Kit capuchon et rosace chromés pour robinet d'encaissement série MP/MPL 5729-5730 avec embout de raccord à presser DN 15.
- Kit verchromte Schutzkappe und Abdeckmanschette für Wand-Armatur Serie MP/MPL 5729-5730 mit Pressfitting-Anschluss DN 15.
- Kit capucho y rosetón cromados para valvula de bola para empotrar serie MP/MPL 5729-5730 con conexión press-fit DN 15.

Code	Price	Class	Packaging
550197	14,83 €	IG	10 / 80

AS 1929



- Staffa per raccordo murale.
- Bracket for wall fitting.
- Etrier pour raccord mural.
- Halterung für Wand-Verbinder.
- Brida para racores con base.

Code	Size	Price	Class	Packaging
500574	Distance 153 mm	3,501 €	JC	100

AS 1927



- Staffa per raccordo murale.
- Bracket for wall fitting.
- Etrier pour raccord mural.
- Halterung für Wand-Verbinder.
- Brida para racores con base.

Code	Size	Price	Class	Packaging
510000	Distance 100 / 153 mm	6,73 €	JC	2 / 50

AS 1928



- Staffa per raccordi murali per tracce orizzontali.
- Wall fitting hanger for horizontal chases.
- Etrier pour raccords muraux pour traces horizontales.
- Halterung für Wand-Verbinder für waagerechte Rohrgänge.
- Brida para racores con base para rozas horizontales.

Code	Size	Price	Class	Packaging
510037	Distance 100 / 150 mm	2,851 €	IG	2 / 30

AR 07



- Isolante per raccordo doppio T incrociato.
- Insulation for double crossed T fitting.
- Isolant pour raccord double T croisé.
- Abdichtung für Doppel-T-Stück überkreuzt.
- Aislamiento para racor en Te doble cruzado.

Code	Price	Class	Packaging
501804	5,64 €	JC	18

BASIC FITTINGS

This section also presents standard fitting elements such as elbows, tees with traditional threads and, in some cases, connections suitable for the application of screw fittings for copper, multilayer or polyethylene pipes. The figures with Eurokonus or EK connections can mount all the screw fittings of the 4000 series (TR, TP or TA) depending on the pipe used.

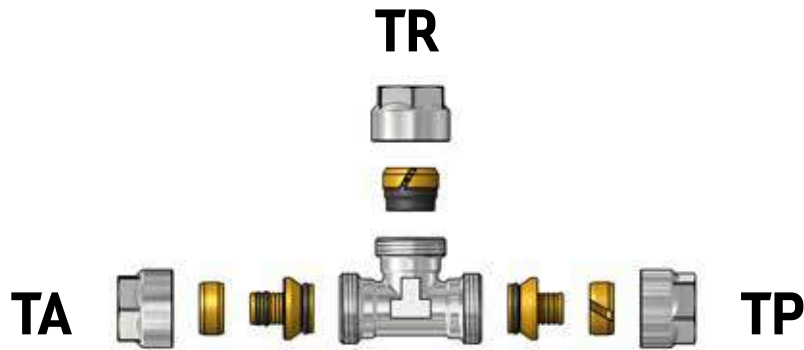

RR 4700



- Raccordo diritto maschio - maschio.
- Straight male - male fitting.
- Raccord droit mâle - mâle.
- Durchgang AG - AG Schraubverbinder.
- Racor recto macho - macho.

Code	Size	Color	Price	Class	Packaging
500377	EUROK x EUROK	Yellow	3,119 €	KA	50 / 400
500378	EUROK x EUROK	Grey	3,141 €	KA	40 / 320

RR 4608



- Raccordo diritto maschio - maschio.
- Straight male - male fitting.
- Raccord droit mâle - mâle.
- Durchgang AG - AG Schraubverbinder.
- Racor recto macho - macho.

Code	Size	Color	Price	Class	Packaging
500059	1/2" M x EUROK	Yellow	3,447 €	KA	50 / 400
500176	3/4" M x EUROK	Yellow	3,435 €	KA	50 / 200
500077	1/2" M x EUROK	Grey	3,469 €	KA	50 / 200
500177	3/4" M x EUROK	Grey	3,593 €	KA	50 / 200

RR 4710



- Raccordo ad angolo maschio - maschio.
- Male - male angle fitting.
- Raccord à angle mâle - mâle.
- AG - AG Winkel-Schraubverbinder.
- Racor codo macho - macho.

Code	Size	Color	Price	Class	Packaging
500097	EUROK x EUROK	Yellow	4,983 €	KA	40 / 320
500098	EUROK x EUROK	Grey	5,27 €	KA	40 / 160

RR 4711



- Raccordo ad angolo maschio - maschio.
- Male - male angle fitting.
- Raccord à angle mâle - mâle.
- AG - AG Winkel-Schraubverbinder.
- Racor codo macho - macho.

Code	Size	Color	Price	Class	Packaging
500099	1/2" M x EUROK	Yellow	4,746 €	KA	40 / 320
500193	3/4" M x EUROK	Yellow	6,46 €	KA	30 / 240
500118	1/2" M x EUROK	Grey	5,06 €	KA	40 / 320
500194	3/4" M x EUROK	Grey	6,63 €	KA	30 / 240

RR 4720



- Raccordo a T maschio - maschio - maschio.
- Male - male - male tee fitting.
- Raccord à T mâle - mâle - mâle.
- AG - AG - AG T-Stück.
- Racor en Te macho - macho - macho.

Code	Size	Color	Price	Class	Packaging
500135	EUROK x EUROK x EUROK	Yellow	5,84 €	KA	25 / 200
500136	EUROK x EUROK x EUROK	Grey	6,06 €	KA	25 / 200

RR 4721



- Raccordo a T maschio - maschio - maschio.
- Male - male - male tee fitting.
- Raccord à T mâle - mâle - mâle.
- AG - AG - AG T-Stück.
- Racor en Te macho - macho - macho.

Code	Size	Color	Price	Class	Packaging
500137	EUROK x 1/2" M x EUROK	Yellow	5,45 €	KA	30 / 240
500199	EUROK x 3/4" M x EUROK	Yellow	6,12 €	KA	30 / 240
500138	EUROK x 1/2" M x EUROK	Grey	5,66 €	KA	30 / 240
500181	EUROK x 3/4" M x EUROK	Grey	6,31 €	KA	30 / 240

■ RR 4613



- Raccordo diritto maschio - femmina.
- Straight male-female fitting.
- Raccord droit mâle-femelle.
- Durchgang AG x IG Schraubverbinder.
- Racor recto macho - hembra.

Code	Size	Color	Price	Class	Packaging
500080	1/2" F x EUROK	Yellow	2,893 €	KA	50 / 200
500174	3/4" F x EUROK	Yellow	3,752 €	KA	40 / 160
500081	1/2" F x EUROK	Grey	2,972 €	KA	50 / 200
500175	3/4" F x EUROK	Grey	3,887 €	KA	40 / 160

■ RR 703



- Niplo maschio - maschio.
- Male nipple - male.
- Nipple mâle - mâle.
- Anschlussstück AG - AG.
- Entrerrosca macho - macho.

Code	Size	Color	Price	Class	Packaging
501131	1/2" M x 1/2" M	Yellow	2,599 €	KA	100 / 400
501132	3/4" M x 3/4" M	Yellow	3,356 €	KA	50 / 200
501419	1"1/2 M x 1"1/2 M	Yellow	13,94 €	KA	50 / 400
501131N	1/2" M x 1/2" M	Grey	2,712 €	KA	100 / 800
501132N	3/4" M x 3/4" M	Grey	3,469 €	KA	50 / 400
501419N	1"1/2 M x 1"1/2 M	Grey	14,31 €	KA	50 / 400

■ RR 4712



- Raccordo ad angolo maschio - femmina.
- Male - female angle fitting.
- Raccord à angle mâle - femelle.
- AG - IG Winkel-Schraubverbinder.
- Racor codo macho - hembra.

Code	Size	Color	Price	Class	Packaging
500119	1/2" F x EUROK	Yellow	4,125 €	KA	40 / 320
500195	3/4" F x EUROK	Yellow	6,26 €	KA	25 / 200
500120	1/2" F x EUROK	Grey	4,26 €	KA	40 / 320
500196	3/4" F x EUROK	Grey	6,46 €	KA	25 / 200

■ AC 4604



- Raccordo diritto maschio - maschio.
- Straight male-male fitting.
- Raccord droit mâle - mâle.
- Durchgang AG x AG Schraubverbinder.
- Racor recto macho - macho.

Code	Size	Color	Price	Class	Packaging
500667	3/4" M O-ring x EUROK	Yellow	3,356 €	KA	50 / 400
500667N	3/4" M O-ring x EUROK	Grey	3,492 €	KA	50 / 400

■ RR 4722



- Raccordo a T maschio - femmina - maschio.
- Male - female - male tee fitting.
- Raccord à T mâle - femelle - mâle.
- AG - IG - AG T-Stück.
- Racor en Te macho - hembra - macho.

Code	Size	Color	Price	Class	Packaging
500139	EUROK x 1/2" F x EUROK	Yellow	5,27 €	KA	30 / 240
500197	EUROK x 3/4" F x EUROK	Yellow	6,72 €	KA	25 / 200
500140	EUROK x 1/2" F x EUROK	Grey	5,41 €	KA	30 / 240
500198	EUROK x 3/4" F x EUROK	Grey	6,87 €	KA	25 / 200

■ RF 811



- Raccordo ad L femmina - maschio.
- Female - male L fitting.
- Raccord en L femelle - mâle.
- IG - AG Winkel - Schraubverbinder.
- Racor codo hembra - macho.

Code	Size	Color	Price	Class	Packaging
501078	1/2" F x 1/2" M	Yellow	4,249 €	KA	40 / 320
501079	3/4" F x 3/4" M	Yellow	6,50 €	KA	20 / 160
501082	1" F x 1" M	Yellow	10,42 €	KA	10 / 80
506619	1"1/4 F x 1"1/4 M	Yellow	17,32 €	KA	6 / 48
506620	1"1/2 F x 1"1/2 M	Yellow	24,87 €	KA	6 / 48
506621	2" F x 2" M	Yellow	47,56 €	KA	1
501023	1/2" F x 1/2" M	Grey	4,215 €	KA	40 / 320
501024	3/4" F x 3/4" M	Grey	6,73 €	KA	20 / 160
501058	1" F x 1" M	Grey	10,76 €	KA	10 / 80
506619N	1"1/4 F x 1"1/4 M	Grey	17,61 €	KA	6 / 48
506620N	1"1/2 F x 1"1/2 M	Grey	25,23 €	KA	6 / 48
506621N	2" F x 2" M	Grey	48,26 €	KA	1

RF 800

- Manicotto femmina - femmina.
- Female-female sleeve.
- Embout femelle - femelle.
- IG x IG Muffe.
- Manguito hembra - hembra.

Code	Size	Color	Price	Class	Packaging
506610	3/8" F x 3/8" F	Yellow	2,938 €	KA	1
501094	1/2" F x 1/2" F	Yellow	2,938 €	KA	50 / 400
501095	3/4" F x 3/4" F	Yellow	3,571 €	KA	35 / 280
501096	1" F x 1" F	Yellow	6,95 €	KA	25 / 200
506611	1"1/4 F x 1"1/4 F	Yellow	8,58 €	KA	20 / 80
506612	1"1/2 F x 1"1/2 F	Yellow	14,42 €	KA	15 / 120
506613	2" F x 2" F	Yellow	23,61 €	KA	1
506610N	3/8" F x 3/8" F	Grey	3,051 €	KA	1
500915	1/2" F x 1/2" F	Grey	3,051 €	KA	50 / 400
500916	3/4" F x 3/4" F	Grey	3,616 €	KA	35 / 280
500917	1" F x 1" F	Grey	7,19 €	KA	25 / 200
506611N	1"1/4 F x 1"1/4 F	Grey	9,45 €	KA	20 / 80
506612N	1"1/2 F x 1"1/2 F	Grey	14,78 €	KA	1
506613N	2" F x 2" F	Grey	24,18 €	KA	1

RF 810

- Raccordo ad angolo femmina - femmina.
- Female - female angle fitting.
- Raccord à angle femelle - femelle.
- IG - IG Winkel-Schraubverbinder.
- Racor codo hembra - hembra.

Code	Size	Color	Price	Class	Packaging
506614	3/8" F x 3/8" F	Yellow	4,238 €	KA	1
501063	1/2" F x 1/2" F	Yellow	4,554 €	KA	40 / 320
501064	3/4" F x 3/4" F	Yellow	5,89 €	KA	20 / 160
501065	1" F x 1" F	Yellow	11,10 €	KA	10 / 80
506615	1"1/4 F x 1"1/4 F	Yellow	17,98 €	KA	10 / 80
506616	1"1/2 F x 1"1/2 F	Yellow	25,70 €	KA	5 / 40
506617	2" F x 2" F	Yellow	48,05 €	KA	1
506614N	3/8" F x 3/8" F	Grey	4,317 €	KA	1
501107	1/2" F x 1/2" F	Grey	4,769 €	KA	40 / 320
501307	3/4" F x 3/4" F	Grey	5,98 €	KA	20 / 160
500672	1" F x 1" F	Grey	11,27 €	KA	10 / 80
506615N	1"1/4 F x 1"1/4 F	Grey	18,24 €	KA	10 / 80
506616N	1"1/2 F x 1"1/2 F	Grey	26,20 €	KA	5 / 40
506617N	2" F x 2" F	Grey	48,54 €	KA	1

AC 624

- Riduzione femmina - femmina.
- Female - female reducing fitting.
- Réduction femelle - femelle.
- Reduzierstück Innengewinde - Innengewinde
- Reducción hembra - hembra.

Code	Size	Color	Price	Class	Packaging
501619	3/4" F x 3/8" F	Yellow	3,187 €	NJ	100 / 400
501618	3/4" F x 1/2" F	Yellow	3,187 €	NJ	100 / 400
501620	1" F x 1/2" F	Yellow	4,01 €	NJ	50 / 400
501621	1" F x 3/4" F	Yellow	4,01 €	NJ	50 / 400
501619N	3/4" F x 3/8" F	Grey	3,221 €	NJ	100 / 400
501618N	3/4" F x 1/2" F	Grey	3,221 €	NJ	100 / 400
501620N	1" F x 1/2" F	Grey	4,141 €	NJ	50 / 400
501621N	1" F x 3/4" F	Grey	4,141 €	NJ	50 / 400

RF 820

- Raccordo a T femmina.
- Female tee fitting.
- Raccord à T femelle.
- IG T-Anschluss.
- Racores T hembra.

Code	Size	Color	Price	Class	Packaging
506622	3/8" F x 3/8" F x 3/8" F	Yellow	4,995 €	KA	1
501066	1/2" F x 1/2" F x 1/2" F	Yellow	4,961 €	KA	25 / 200
501067	3/4" F x 3/4" F x 3/4" F	Yellow	6,20 €	KA	15 / 120
501068	1" F x 1" F x 1" F	Yellow	12,32 €	KA	10 / 80
506623	1"1/4 F x 1"1/4 F x 1"1/4 F	Yellow	22,16 €	KA	5 / 40
506624	1"1/2 F x 1"1/2 F x 1"1/2 F	Yellow	32,72 €	KA	5 / 40
506622N	3/8" F x 3/8" F x 3/8" F	Grey	5,07 €	KA	1
501041	1/2" F x 1/2" F x 1/2" F	Grey	4,938 €	KA	25 / 200
501042	3/4" F x 3/4" F x 3/4" F	Grey	6,32 €	KA	15 / 120
501043	1" F x 1" F x 1" F	Grey	12,45 €	KA	10 / 80
506623N	1"1/4 F x 1"1/4 F x 1"1/4 F	Grey	23,01 €	KA	5 / 40
506624N	1"1/2 F x 1"1/2 F x 1"1/2 F	Grey	33,23 €	KA	5 / 40

■ RM 4760



- Raccordo murale.
- Wall fitting.
- Raccord mural.
- Wand-Schraubverbinder.
- Racor codo con base.

Code	Size	Color	Price	Class	Packaging
500594	1/2" F x EUROK	■	6,12 €	KA	25 / 200
500307	3/4" F x EUROK	■	8,98 €	KA	20 / 80

■ RM 4770



- Raccordo murale doppio.
- Double wall fitting.
- Raccord mural double.
- Doppel-Wand-Schraubverbinder.
- Racor codo doble con base.

Code	Size	Color	Price	Class	Packaging
500405	1/2" F x EUROK	■	14,66 €	KA	10 / 80

■ RM 780



- Raccordo murale doppio femmina.
- Double female wall fitting.
- Raccord mural double femelle.
- Doppel IG Wand-Schraubverbinder.
- Racor codo doble hembra.

Code	Size	Color	Price	Class	Packaging
500401	1/2" F x 1/2" F	■	15,18 €	KA	10 / 80



FOCUS: U-fittings

See page 96.

■ RMK 4760



- Raccordi murali (kit con AS 1929).
- Wall fittings (kit with AS 1929).
- Raccords murals (kit avec AS 1929).
- Wand-Verbinder (Kit mit AS 1929).
- Brida y racores codo con base (conjunto con AS 1929).

Code	Size	Color	Price	Class	Packaging
506102	1/2" F x EUROK	■	15,41 €	KA	15
506103	3/4" F x EUROK	■	21,16 €	KA	15

■ RMK 4770



- Raccordi murali doppi (kit con AS 1929).
- Double wall fittings (kit with AS 1929).
- Raccords murals doubles (kit avec AS 1929).
- Doppel Wand-Verbinder (Kit mit AS 1929).
- Brida y racores codo dobles con base (conjunto con AS 1929).

Code	Size	Color	Price	Class	Packaging
506109	1/2" F x EUROK	■	33,05 €	KA	15

■ RMK 780



- Raccordi murali doppi femmina (kit con AS 1929).
- Double female wall fittings (kit with AS 1929).
- Raccords murals doubles femelle (kit avec AS 1929).
- Doppel IG Wand-Verbinder (Kit mit AS 1929).
- Brida y racores codo dobles hembra con base (conjunto con AS 1929).

Code	Size	Color	Price	Class	Packaging
506112	1/2" F x 1/2" F	■	34,16 €	KA	15

■ AS 1929



- Staffa per raccordo murale.
- Bracket for wall fitting.
- Etrier pour raccord mural.
- Halterung für Wand-Verbinder.
- Brida para racores con base.

Code	Size	Price	Class	Packaging
500574	Distance 153 mm	3,501 €	JC	100

RMK 4761

- Raccordi murali (kit con AS 1927).
- Wall fittings (kit with AS 1927).
- Raccords murals (kit avec AS 1927).
- Wand-Verbinder (Kit mit AS 1927).
- Brida y racores codo con base (conjunto con AS 1927).

Code	Size	Color	Price	Class	Packaging
506106	1/2" F x EUROK		18,61 €	KA	15
506107	3/4" F x EUROK		23,85 €	KA	15

RMK 4771

- Raccordi murali doppi (kit con AS 1927).
- Double wall fittings (kit with AS 1927).
- Raccords murals doubles (kit avec AS 1927).
- Doppel Wand-Verbinder (Kit mit AS 1927).
- Brida y racores codo dobles con base (conjunto con AS 1927).

Code	Size	Color	Price	Class	Packaging
506111	1/2" F x EUROK		36,24 €	KA	15

RMK 781

- Raccordi murali doppi femmina (kit con AS 1927).
- Double female wall fittings (kit with AS 1927).
- Raccords murals doubles femelle (kit avec AS 1927).
- Doppel IG Wand-Verbinder (Kit mit AS 1927).
- Brida y racores codo dobles hembra con base (conjunto con AS 1927).

Code	Size	Color	Price	Class	Packaging
506113	1/2" F x 1/2" F		37,34 €	KA	15

AS 1927

- Staffa per raccordo murale.
- Bracket for wall fitting.
- Etrier pour raccord mural.
- Halterung für Wand-Verbinder.
- Brida para racores con base.

Code	Size	Price	Class	Packaging
510000	Distance 100 / 153 mm	6,73 €	JC	2 / 50

RR 4723

- Raccordo doppio T incrociato per impianti a battiscopa.
- Double crossed T fitting for skirting board plants.
- Raccord à double T croisé pour installations à la plinthe.
- Doppel T-Stück für Sockenleiste.
- Racor T doble cruzado para sistemas en zócalos.

Code	Size	Color	Price	Class	Packaging
500261N	EUROK x 6		26,31 €	KA	8 / 64

RR 723

- Raccordo doppio T incrociato per impianti a battiscopa.
- Double crossed T fitting for skirting board plants.
- Raccord à double T croisé pour installations à la plinthe.
- Doppel T-Stück für Sockenleiste.
- Racor T doble cruzado para sistemas en zócalos.

Code	Size	Color	Price	Class	Packaging
500259N	1/2" F x 6		25,84 €	KA	6 / 48

RR 704

- Tubo cromato ad S per impianti a battiscopa.
- S chromed pipe for skirting board plants.
- Tube chromé à S pour installations à la plinthe.
- Verchrome S-Rohr für Sockenleiste.
- Tubo cromado S para sistemas en zócalos.

Code	Size	Price	Class	Packaging
500060	Ø15	10,23 €	JC	12 / 96

AR 07

- Isolante per raccordo doppio T incrociato.
- Insulation for double crossed T fitting.
- Isolant pour raccord double T croisé.
- Abdichtung für Doppel-T-Stück überkreuzt.
- Aislamiento para racor en Te doble cruzado.

Code	Price	Class	Packaging
501804	5,64 €	JC	18

SCREW FITTINGS

The range of IVAR screw fittings is extremely complete, with connections for different types of pipes such as copper (TR), multilayer (TA) and polyethylene (TP). The fittings are compatible with the Eurokonus standard and each type has several variants depending on the outside diameter and thickness of the pipe.

The offer is completed with pre-assembled solutions (RR, RA, RP) with male or female connection on straight or elbow terminals.

Soft copper	Semi-hard copper	Mild steel	Multilayer	Cross-linked polyethylene
45 Nm ≤ T ≤ 55 Nm	60 Nm ≤ T ≤ 80 Nm	60 Nm ≤ T ≤ 70 Nm	20 Nm ≤ T ≤ 30 Nm	30 Nm ≤ T ≤ 40 Nm
				

T = Max. tightening torque



FOCUS: Screw fittings for both multilayer and PEX pipe

1 FITTING FOR
2 TYPES OF PIPE

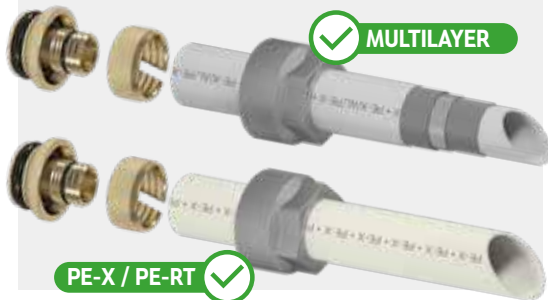

PIPE CALIBRATION AND
CHAMFERING
NOT NEEDED



LARGER INTERNAL BORE AND
**REDUCED
PRESSURE
DROPS**



NO CORROSION
DUE TO STRAY CURRENTS



TA 4420

- Raccordo EUROK per tubo multistrato e in polietilene.
- EUROK fitting for multilayer and polyethylene pipe.
- Raccord EUROK pour tube multicouches et en polyéthylène.
- EUROK-Verschraubung für Verbund- und für Polyäthylen-Rohr.
- Conexión EUROK para tubo multicapa y de polietileno.

Code	Size	Color	Price	Class	Packaging
506061	EUROK x 12/1,8	■	3,893 €	JA	40 / 320
500683	EUROK x 14/2	■	3,893 €	JA	40 / 320
500400	EUROK x 15/1,5	■	4,012 €	JA	40 / 320
500684	EUROK x 16/2	■	3,893 €	JA	40 / 320
500579	EUROK x 16/2,25	■	3,893 €	JA	40 / 320
506040	EUROK x 16,2/2,6	■	3,893 €	JA	40 / 320
500012	EUROK x 17/2	■	4,169 €	JA	40 / 320
500685	EUROK x 18/2	■	4,169 €	JA	40 / 320
500754	EUROK x 18/2,5	■	4,169 €	JA	40 / 320
500914	EUROK x 20/2	■	4,348 €	JA	40 / 320
500009	EUROK x 20/2,25	■	4,575 €	JA	40 / 320
501010	EUROK x 20/2,5	■	4,348 €	JA	40 / 320
506295	EUROK x 20/2,9	■	5,94 €	JA	40 / 320

TA 420 P

- Raccordo 1/2" F per tubo multistrato e in polietilene.
- 1/2" F fitting for multilayer and polyethylene pipe.
- Raccord 1/2" F pour tube multicouches et en polyéthylène.
- Verschraubung 1/2" IG für Verbund- und für Polyäthylen-Rohr.
- Conexión 1/2" F para tubo multicapa y de polietileno.

Code	Size	Color	Price	Class	Packaging
506265	1/2" F x 14/2	■	3,138 €	JA	50 / 400
500759	1/2" F x 16/2	■	3,138 €	JA	40 / 320
506267	1/2" F x 16/2,25	■	3,138 €	JA	50 / 400

RA 761

- Raccordo a stringere diritto maschio per tubo multistrato.
- Compression straight male fitting for multilayer pipe.
- Raccord à serrage droit mâle pour tube multicouche.
- Durchgang AG Pressanschluss für Verbundrohr.
- Racor de compresión recto macho para tubo multicapa.

Code	Size	Color	Price	Class	Packaging
500043	3/4" M x 20/2	■	7,67 €	LA	25 / 100
501361	3/4" M x 25/2,5	■	11,68 €	LA	25 / 200
500122	3/4" M x 25/3	■	11,68 €	LA	25 / 100
501084	3/4" M x 26/3	■	11,68 €	LA	25 / 100
501497	3/4" M x 32/3	■	18,45 €	LA	15 / 120
506489	1" M x 25/2,5	■	12,11 €	LA	15 / 120
506490	1" M x 25/3	■	12,11 €	LA	15 / 120
506057	1" M x 26/3	■	12,11 €	LA	15 / 120
500203	1" M x 32/3	■	15,92 €	LA	10 / 80
500043N	3/4" M x 20/2	■	7,88 €	LA	25 / 200
501361N	3/4" M x 25/2,5	■	12,01 €	LA	25 / 200
500122N	3/4" M x 25/3	■	12,01 €	LA	25 / 100
501084N	3/4" M x 26/3	■	12,01 €	LA	25 / 100
501497N	3/4" M x 32/3	■	19,01 €	LA	15 / 120
506489N	1" M x 25/2,5	■	12,45 €	LA	15 / 120
506490N	1" M x 25/3	■	12,45 €	LA	15 / 120
506057N	1" M x 26/3	■	12,45 €	LA	15 / 120
500203N	1" M x 32/3	■	16,39 €	LA	10 / 80

RA 761 N

- Raccordo per tubo multistrato EUROK x 1/2" M.
- Fitting for multilayer pipe EUROK x 1/2" M.
- Raccord pour tube multicouches EUROK x 1/2" M.
- EUROK x 1/2" AG Verschraubung für Verbundrohr.
- Racor de compresión para tubo multicapa EUROK x 1/2" M.

Code	Size	Color	Price	Class	Packaging
570000N	1/2" M x 14/2	■	6,73 €	LA	50 / 200
570001N	1/2" M x 15/1,5	■	6,73 €	LA	50 / 200
570002N	1/2" M x 16 /2	■	6,73 €	LA	50 / 200
570003N	1/2" M x 16/2,25	■	6,73 €	LA	50 / 200
570004N	1/2" M x 17/2	■	6,89 €	LA	50 / 200
570005N	1/2" M x 18/2	■	6,89 €	LA	50 / 200
570006N	1/2" M x 18/2,5	■	6,89 €	LA	50 / 200
570007N	1/2" M x 20/2	■	7,11 €	LA	50 / 200
570008N	1/2" M x 20/2,25	■	7,11 €	LA	50 / 200
570009N	1/2" M x 20/2,5	■	7,11 €	LA	25 / 100

TP 4410



- Raccordo EUROK per tubo in polietilene.
- EUROK fitting for polyethylene pipe.
- Raccord EUROK pour tube en polyéthylène.
- EUROK-Verschraubung für Polyäthylen-Rohr.
- Conexión EUROK para tubo de polietileno.

Code	Size	Color	Price	Class	Packaging
500590	EUROK x 12/1	■	3,673 €	JA	40 / 320
520041	EUROK x 12/2	■	3,673 €	JA	40 / 320
500679	EUROK x 14/2	■	3,593 €	JA	40 / 320
500148	EUROK x 15/1,7	■	3,893 €	JA	40 / 320
500769	EUROK x 15/2,5	■	3,737 €	JA	40 / 320
500591	EUROK x 16/1,5	■	3,51 €	JA	40 / 320
500680	EUROK x 16/2	■	3,51 €	JA	40 / 320
500681	EUROK x 16/2,2	■	3,51 €	JA	40 / 320
500682	EUROK x 17/2	■	3,737 €	JA	40 / 320
500145	EUROK x 18/1,8	■	3,737 €	JA	40 / 320
500650	EUROK x 18/2	■	4,169 €	JA	40 / 320
506020	EUROK x 18/2,5	■	3,737 €	JA	40 / 320
500651	EUROK x 20/2	■	4,169 €	JA	40 / 320
500649	EUROK x 20/2,8	■	4,025 €	JA	40 / 320
506200	EUROK x 20/3,4	■	4,025 €	JA	40 / 320
500753	EUROK x 21/2,5	■	4,528 €	JA	40 / 320

TP 4410 HK



- Raccordo EUROK per tubo in polietilene.
- EUROK fitting for polyethylene pipe.
- Raccord EUROK pour tube en polyéthylène.
- EUROK-Verschraubung für Polyäthylen-Rohr.
- Conexión EUROK para tubo de polietileno.

Code	Size	Price	Class	Packaging
TFEK10-1	EUROK x 10/1,3	4,671 €	JA	2

TP 410 P



- Raccordo 1/2" F per tubo in polietilene.
- 1/2" F fitting for polyethylene pipe.
- Raccord 1/2" F pour tube en polyéthylène.
- Verschraubung 1/2" IG für Polyäthylen-Rohr.
- Conexión 1/2" F para tubo de polietileno.

Code	Size	Color	Price	Class	Packaging
506268	1/2" F x 12/1,1	■	3,138 €	JA	50 / 400
506269	1/2" F x 12/2	■	3,138 €	JA	50 / 400
506272	1/2" F x 15/2,5	■	3,138 €	JA	50 / 400
506273	1/2" F x 16/1,5	■	3,138 €	JA	50 / 400
506275	1/2" F x 16/2,2	■	3,138 €	JA	50 / 400

RP 731



- Raccordo a stringere diritto maschio per tubo in polietilene.
- Compression straight male fitting for polyethylene pipe.
- Raccord à serrage droit mâle pour tube en polyéthylène.
- Durchgang AG Pressanschluss für Polyäthylenrohr.
- Racor de compresión recto macho para tubo de polietileno.

Code	Size	Color	Price	Class	Packaging
506209	3/4" M x 20/2	■	7,37 €	LA	25 / 200
501051	3/4" M x 20/2,8	■	7,37 €	LA	25 / 200
501054	3/4" M x 25/2,3	■	11,72 €	LA	25 / 100
550042	3/4" M x 25/2,5	■	11,72 €	LA	25 / 200
501052	3/4" M x 25/3,5	■	11,72 €	LA	20 / 160
501498	3/4" M x 32/4,4	■	17,80 €	LA	15 / 120
506492	1" M x 25/2,3	■	11,65 €	LA	20 / 160
506493	1" M x 25/2,5	■	11,65 €	LA	20 / 160
991310	1" M x 25/3,5	■	12,17 €	LA	20 / 160
506209N	3/4" M x 20/2,3	■	7,59 €	LA	25 / 200
501051N	3/4" M x 20/2,8	■	7,59 €	LA	25 / 200
501054N	3/4" M x 25/2,3	■	12,07 €	LA	25 / 100
550042N	3/4" M x 25/2,5	■	12,07 €	LA	25 / 200
501052N	3/4" M x 25/3,5	■	12,07 €	LA	25 / 100
501498N	3/4" M x 32/4,4	■	18,33 €	LA	15 / 120
506492N	1" M x 25/2,3	■	11,99 €	LA	20 / 160
506493N	1" M x 25/2,5	■	11,99 €	LA	20 / 160
991310N	1" M x 25/3,5	■	12,54 €	LA	20 / 160

RP 731 N



- Raccordo per tubo polietilene EUROK x 1/2" M.
- Fitting for polyethylene pipe EUROK x 1/2" M.
- Raccord pour tube polyéthylène EUROK x 1/2" M.
- EUROK x 1/2" AG Verschraubung für Polyäthylen-Rohr.
- Racor de compresión para tubo de polietileno EUROK x 1/2" M.

Code	Size	Color	Price	Class	Packaging
570020N	1/2" M x 12/1	■	6,46 €	LA	50 / 200
570021N	1/2" M x 12/2	■	6,46 €	LA	50 / 200
570022N	1/2" M x 14/2	■	6,46 €	LA	50 / 200
570023N	1/2" M x 15/1,7	■	6,46 €	LA	50 / 200
570024N	1/2" M x 15/2,5	■	6,46 €	LA	50 / 200
570025N	1/2" M x 16/1,5	■	6,46 €	LA	50 / 200
570026N	1/2" M x 16/2	■	6,46 €	LA	50 / 200
570027N	1/2" M x 16/2,2	■	6,46 €	LA	50 / 200
570028N	1/2" M x 17/2	■	6,44 €	LA	50 / 200
570029N	1/2" M x 18/1,8	■	6,44 €	LA	50 / 200
570030N	1/2" M x 18/2	■	6,44 €	LA	50 / 200
570031N	1/2" M x 20/2	■	6,73 €	LA	50 / 200
570032N	1/2" M x 20/2,8	■	6,73 €	LA	50 / 200
570033N	1/2" M x 21/2,5	■	6,98 €	LA	50 / 200

RA 861

- Raccordo a stringere ad angolo maschio per tubo multistrato.
- Compression angle male fitting for multilayer pipe.
- Raccord à serrage à angle mâle pour tube multicouche.
- Winkel AG Pressanschluss für Verbundrohr.
- Racor codo de compresión macho para tubo multicapa.

Code	Size	Color	Price	Class	Packaging
506488	3/4" M x 25/2,5	Yellow	15,20 €	LA	20 / 160
506472	3/4" M x 25/3	Yellow	15,20 €	LA	20 / 160
506473	3/4" M x 26/3	Yellow	15,20 €	LA	10 / 80
506474	3/4" M x 32/3	Yellow	18,16 €	LA	20 / 160
506486	1" M x 25/2,5	Yellow	17,04 €	LA	10 / 80
506496	1" M x 25/3	Yellow	17,04 €	LA	10 / 80
506463	1" M x 26/3	Yellow	17,04 €	LA	10 / 80
506464	1" M x 32/3	Yellow	19,66 €	LA	10 / 40
506488N	3/4" M x 25/2,5	Grey	15,51 €	LA	20 / 160
506472N	3/4" M x 25/3	Grey	15,51 €	LA	20 / 160
506473N	3/4" M x 26/3	Grey	15,51 €	LA	10 / 80
506474N	3/4" M x 32/3	Grey	18,70 €	LA	20 / 160
506486N	1" M x 25/2,5	Grey	17,63 €	LA	10 / 80
506496N	1" M x 25/3	Grey	17,63 €	LA	10 / 80
506463N	1" M x 26/3	Grey	17,63 €	LA	10 / 80
506464N	1" M x 32/3	Grey	20,34 €	LA	10 / 40

RA 862

- Raccordo a stringere ad angolo femmina per tubo multistrato.
- Compression angle female fitting for multilayer pipe.
- Raccord à serrage à angle femelle pour tube multicouche.
- Winkel IG Pressanschluss für Verbundrohr.
- Racor codo de compresión hembra para tubo multicapa.

Code	Size	Color	Price	Class	Packaging
506487	3/4" F x 25/2,5	Yellow	16,57 €	LA	20 / 160
506469	3/4" F x 25/3	Yellow	16,57 €	LA	20 / 160
506470	3/4" F x 26/3	Yellow	16,57 €	LA	10 / 80
506471	3/4" F x 32/3	Yellow	19,20 €	LA	10 / 80
506485	1" F x 25/2,5	Yellow	19,15 €	LA	10 / 80
506499	1" F x 25/3	Yellow	19,15 €	LA	10 / 80
506461	1" F x 26/3	Yellow	19,15 €	LA	10 / 80
506462	1" F x 32/3	Yellow	20,77 €	LA	10 / 80
506487N	3/4" F x 25/2,5	Grey	17,07 €	LA	15 / 120
506469N	3/4" F x 25/3	Grey	17,07 €	LA	20 / 160
506470N	3/4" F x 26/3	Grey	17,07 €	LA	10 / 80
506471N	3/4" F x 32/3	Grey	19,80 €	LA	20 / 160
506485N	1" F x 25/2,5	Grey	19,73 €	LA	10 / 80
506499N	1" F x 25/3	Grey	19,73 €	LA	10 / 80
506461N	1" F x 26/3	Grey	19,73 €	LA	10 / 80
506462N	1" F x 32/3	Grey	21,42 €	LA	10 / 80

RA 762

- Raccordo a stringere diritto femmina per tubo multistrato.
- Compression straight female fitting for multilayer pipe.
- Raccord à serrage droit femelle pour tube multicouche.
- Durchgang IG Pressanschluss für Verbundrohr.
- Racor de compresión recto hembra para tubo multicapa.

Code	Size	Color	Price	Class	Packaging
506484	3/4" F x 25/2,5	Yellow	11,40 €	LA	20 / 160
506454	3/4" F x 25/3	Yellow	11,40 €	LA	20 / 160
506455	3/4" F x 26/3	Yellow	11,40 €	LA	20 / 80
506456	3/4" F x 32/3	Yellow	14,88 €	LA	10 / 80
506483	1" F x 25/2,5	Yellow	12,72 €	LA	15 / 120
506491	1" F x 25/3	Yellow	12,72 €	LA	15 / 120
506450	1" F x 26/3	Yellow	12,72 €	LA	15 / 120
506451	1" F x 32/3	Yellow	16,06 €	LA	15 / 60
506484N	3/4" F x 25/2,5	Grey	12,25 €	LA	20 / 160
506454N	3/4" F x 25/3	Grey	12,25 €	LA	20 / 160
506455N	3/4" F x 26/3	Grey	12,25 €	LA	20 / 160
506456N	3/4" F x 32/3	Grey	15,30 €	LA	10 / 80
506483N	1" F x 25/2,5	Grey	13,12 €	LA	15 / 120
506491N	1" F x 25/3	Grey	13,12 €	LA	15 / 120
506450N	1" F x 26/3	Grey	13,12 €	LA	15 / 120
506451N	1" F x 32/3	Grey	16,54 €	LA	15 / 60

RP 732

- Raccordo a stringere diritto femmina per tubo in polietilene.
- Compression straight female fitting for polyethylene pipe.
- Raccord à serrage droit femelle pour tube en polyéthylène.
- Durchgang IG Pressanschluss für Polyäthylenrohr.
- Racor de compresión recto hembra para tubo de polietileno.

Code	Size	Color	Price	Class	Packaging
506457	3/4" Fx25/2,3	Yellow	11,40 €	LA	15 / 60
506458	3/4" Fx25/2,5	Yellow	11,40 €	LA	15 / 60
506459	3/4" Fx25/3,5	Yellow	11,40 €	LA	15 / 60
506460	3/4" Fx32/4,4	Yellow	14,41 €	LA	15 / 60
506494	1" F x 25/2,3	Yellow	12,57 €	LA	15 / 60
506495	1" F x 25/2,5	Yellow	12,57 €	LA	15 / 60
506452	1" F x 25/3,5	Yellow	12,72 €	LA	15 / 60
506453	1" F x 32/4,4	Yellow	15,75 €	LA	15 / 60
506457N	3/4" F x 25/2,3	Grey	11,75 €	LA	15 / 60
506458N	3/4" F x 25/2,5	Grey	11,75 €	LA	15 / 60
506459N	3/4" F x 25/3,5	Grey	11,75 €	LA	15 / 60
506460N	3/4" F x 32/4,4	Grey	14,83 €	LA	15 / 60
506494N	1" F x 25/2,3	Grey	12,94 €	LA	15 / 60
506495N	1" F x 25/2,5	Grey	12,94 €	LA	15 / 60
506452N	1" F x 25/3,5	Grey	13,12 €	LA	15 / 60
506453N	1" F x 32/4,4	Grey	16,23 €	LA	15 / 60

■ TR 4430



- Raccordo EUROK per tubo rame ed acciaio dolce.
- EUROK fitting for copper and mild steel pipe.
- Raccord EUROK pour tube en cuivre et en acier doux.
- EUROK-Verschraubung für Kupferrohre und Weichstahlrohre.
- Conexión EUROK para tubo de cobre y acero dulce.

Code	Size	Color	Price	Class	Packaging
500998	EUROK x 10/1	■	3,282 €	JA	40 / 320
500157	EUROK x 12/1	■	2,712 €	JA	40 / 320
500024	EUROK x 14/1	■	2,671 €	JA	40 / 320
500025	EUROK x 15/1	■	2,671 €	JA	40 / 320
500026	EUROK x 16/1	■	2,671 €	JA	40 / 320

■ TR 4430-18



- Raccordo EUROK per tubo rame ed acciaio dolce.
- EUROK fitting for copper and mild steel pipe.
- Raccord EUROK pour tube en cuivre et en acier doux.
- EUROK-Verschraubung für Kupferrohre und Weichstahlrohre.
- Conexión EUROK para tubo de cobre y acero dulce.

Code	Size	Color	Price	Class	Packaging
500417	EUROK x 18/1	■	4,30 €	JA	40 / 320

■ TR 430 P



- Raccordo 1/2" F a stringere per tubo rame ed acciaio dolce con bussola in NBR.
- 1/2" F fitting for copper and mild steel pipe with NBR bushing.
- Raccord 1/2" F pour tube en cuivre et en acier doux avec douille en NBR.
- Verschraubung 1/2" IG für Kupferrohre und Weichstahlrohre mit Hülsen aus NBR.
- Conexión 1/2" F para tubo de cobre y acero dulce con buje en NBR.

Code	Size	Color	Price	Class	Packaging
506260	1/2" F x 10/1	■	2,659 €	JA	50 / 400
506261	1/2" F x 12/1	■	2,659 €	JA	50 / 400
506262	1/2" F x 14/1	■	2,659 €	JA	50 / 400
506263	1/2" F x 15/1	■	2,935 €	JA	50 / 400
506264	1/2" F x 16/1	■	2,935 €	JA	50 / 400

■ RR 781 N



- Raccordo per tubo rame ed acciaio dolce EUROK x 1/2" M.
- Fitting for copper and mild steel pipe EUROK x 1/2" M.
- Raccord pour tube en cuivre et en acier doux EUROK x 1/2" M.
- EUROK x 1/2" AG Verschraubung für Kupferrohre und Weichstahlrohre.
- Racor de compresión para tubo de cobre y acero dulce EUROK x 1/2" M.

Code	Size	Color	Price	Class	Packaging
570051N	1/2" M x 10/1	■	5,27 €	LA	50 / 400
570053N	1/2" M x 12/1	■	5,27 €	LA	50 / 400
570054N	1/2" M x 14/1	■	5,27 €	LA	50 / 400
570055N	1/2" M x 15/1	■	5,27 €	LA	40 / 320
570056N	1/2" M x 16/1	■	5,27 €	LA	50 / 400
570057N	1/2" M x 18/1	■	6,73 €	LA	50 / 400

■ TR 401



- Raccordo per tubo rame ed acciaio dolce con ogiva ricotta.
- Fitting for copper and mild steel pipe with annealed ogive.
- Raccord pour tube en cuivre et en acier doux avec ogive recuite.
- Verschraubung für Kupferrohre und Weichstahlrohre mit geglühtem Klemmring.
- Conexión para tubo de cobre y acero dulce con ojiva recocida.

Code	Size	Color	Price	Class	Packaging
501047	G 1/2" x 15/1	■	2,06 €	JA	100 / 800

■ TR 402



- Raccordo per tubo rame ed acciaio dolce con ogiva e o-ring.
- Fitting for copper and mild steel with ogive and o-ring.
- Raccord pour tube en cuivre et en acier doux avec ogive et joint torique.
- Verschraubung für Kupferrohre und Weichstahlrohre mit Klemmring und O-Ring.
- Conexión para tubo de cobre y acero dulce con ojiva y o-ring.

Code	Size	Color	Price	Class	Packaging
501009	G 1/2" x 15/1	■	2,192 €	JA	100 / 800

UNDER-FLOOR FITTINGS

The widespread use of cross-linked polyethylene pipes has made it necessary to introduce some measures in systems to minimise problems deriving from the use of this type of pipe. In fact one of the main defects is the high elastic return which determines a certain difficulty in attaching DHW taps and fittings and radiator valves to the walls. The use of hydraulic junction boxes (similar to household electric systems) greatly simplifies use of the polyethylene pipe, also giving it an incomparable aesthetic result. The junction boxes, with their template, have fixed centre distances for the connections of sanitary appliances and, thanks to the numerous grooves for anchoring to the template, allow you to choose the fixing depth of the fittings in the wall, depending on the thickness of the intended covering. When using for radiator junctions, the use of RR 702 chrome-plated extensions and of AGE06/07 plates definitely give the junction a pleasant aspect (no longer cracked walls, inclined pipes, hanging radiators). The junction boxes make it possible to crimp the conduit (always recommended for thermal expansion problems), forming a unique element making it possible to pull off the pipe when necessary and to replace it with a new one without needing to break the wall. All the hot dipped galvanised iron templates are fractionable in case of single use. The SS1711 boxes can be coupled one to another by grooved guides to obtain a minimum centre distance of 38 mm for use in heating with single pipe valves and 3- and 4-way distributors. The supplied template allows you to obtain centre distances of 38, 50, 100, 153 mm to meet all the junction requirements both in heating and in DHW.

Boxes with 105 ° fitting SS1730 - SS1735 are equipped with sealed rubber cap insulating the box from the circuit. Should the fitting drip, the leak can be immediately identified in the box and does not extend through the conduit.

The junctions have EUROKONUS thread and make it possible to use all the fittings for polyethylene, multilayer and even copper pipes. Using the last two types of pipe makes it impossible to pull off the pipe due to its greater rigidity, but all the other features of the system carried out professionally and aesthetically remain unchanged.



■ SS 1711 B



- Scatola di distribuzione sottotraccia con raccordo maschio EUROK a 90°.
- Under-floor distribution box with 90° EUROK male fitting.
- Boîte de distribution encastrée avec raccord EUROK mâle à 90°.
- Unterputz-Dose mit 90° Winkel mit AG-Anschluss EUROK.
- Caja de distribución empotrable con racor macho EUROK a 90°.

Code	Size	Color	Price	Class	Packaging
500131	1/2" F x EUROK	■	7,70 €	MA	8 / 96

■ SS 1711 R



- Scatola di distribuzione sottotraccia con raccordo maschio EUROK a 90°.
- Under-floor distribution box with 90° EUROK male fitting.
- Boîte de distribution encastrée avec raccord EUROK mâle à 90°.
- Unterputz-Dose mit 90° Winkel mit AG-Anschluss EUROK.
- Caja de distribución empotrable con racor macho EUROK a 90°.

Code	Size	Color	Price	Class	Packaging
500131R	1/2" F x EUROK	■	7,70 €	MA	8 / 96

■ SS 1710 B



- Scatole di distribuzione sottotraccia con raccordo maschio EUROK a 90° complete di dima.
- Under-floor distribution boxes with 90° EUROK male fitting equipped with template.
- Boîtes de distribution encastrées avec raccord EUROK mâle à 90° fournies avec platine de fixation.
- Unterputz-Dosen mit 90° Winkel mit AG-Anschluss EUROK und Halterung.
- Cajas de distribución empotrable con racor macho EUROK a 90° con plantilla.

Code	Size	Color	Price	Class	Packaging
500132	1/2" F x EUROK	■	8,81 €	MA	8 / 96

■ SS 1710 R



- Scatole di distribuzione sottotraccia con raccordo maschio EUROK a 90° complete di dima.
- Under-floor distribution boxes with 90° EUROK male fitting equipped with template.
- Boîtes de distribution encastrées avec raccord EUROK mâle à 90° fournies avec platine de fixation.
- Unterputz-Dosen mit 90° Winkel mit AG-Anschluss EUROK und Halterung.
- Cajas de distribución empotrable con racor macho EUROK a 90° con plantilla.

Code	Size	Color	Price	Class	Packaging
500132R	1/2" F x EUROK	■	8,81 €	MA	8 / 96

■ SS 1710 BR



- Scatole di distribuzione sottotraccia con raccordo maschio EUROK a 90° complete di dima.
- Under-floor distribution boxes with 90° EUROK male fitting equipped with template.
- Boîtes de distribution encastrées avec raccord EUROK mâle à 90° fournies avec platine de fixation.
- Unterputz-Dosen mit 90° Winkel mit AG-Anschluss EUROK und Halterung.
- Cajas de distribución empotrable con racor macho EUROK a 90° con plantilla.

Code	Size	Color	Price	Class	Packaging
520060	1/2" F x EUROK	■ - ■	8,81 €	MA	8 / 96

■ AS 1925



- Dima frazionabile per scatole di distribuzione sottotraccia MP 5610 - SS 1711.
- Dividable template for under-floor distribution boxes MP 5610 - SS 1711.
- Platine de fixation pouvant être fractionnée pour les boîtes de distribution encastrée MP 5610 - SS 1711.
- Trennbare Halterung für Unterputz-Dose MP 5610 - SS 1711.
- Plantilla fraccionable para caja de distribución empotrables MP 5610 - SS 1711.

Code	Size	Price	Class	Packaging
501011	MP 5610 - SS 1711	2,882 €	JC	60

SS 1731

- Scatola di distribuzione sottotraccia con raccordo maschio EUROK a 105°.
- Under-floor distribution box with 105° EUROK male fitting.
- Boîte de distribution encastrée avec raccord EUROK mâle à 105°.
- Verteilerkasten Unterspur mit Y-AG-Anschluss EUROK.
- Caja de distribución empotrable con racor macho EUROK a 105°.

Code	Size	Color	Price	Class	Packaging
500155	1/2" F x EUROK	■	11,04 €	MA	6 / 72

SS 1740

- Scatola di distribuzione sottotraccia a 2 uscite maschio EUROK per collegamento in serie.
- Under-floor distribution box with double EUROK male output for serial connections.
- Boîte de distribution encastrée à deux sorties EUROK mâle pour raccordement en série.
- Unterputz-Dose mit 2 AG-Anschlüsse EUROK für Verbindungsreihe.
- Caja de distribución empotrable de 2 salidas macho EUROK para la conexión en serie.

Code	Size	Color	Price	Class	Packaging
500154	1/2" F x EUROK	■	16,00 €	MA	6 / 72

SS 1730

- Scatole di distribuzione sottotraccia con raccordo maschio EUROK a 105° complete di dima.
- Under-floor distribution boxes with 105° EUROK male fitting equipped with template.
- Boîtes de distribution encastrées avec raccord EUROK mâle à 105° fournies avec platine de fixation.
- Unterputz-Dosen mit 105° Verbinder mit AG-Anschluss EUROK und Halterung.
- Cajas de distribución empotrable con racor macho EUROK a 105° con plantilla.

Code	Size	Color	Price	Class	Packaging
500156	1/2" F x EUROK	■	12,90 €	MA	6 / 72

SS 1735

- Scatole di distribuzione a tenuta stagna con raccordo maschio EUROK.
- Watertight under-floor distribution box with EUROK male fitting.
- Boîtes de distribution avec raccord EUROK mâle.
- Dichte Unterputz-Dosen mit AG-Anschluss EUROK.
- Cajas de distribución estancas con racor macho EUROK.

Code	Size	Color	Price	Class	Packaging
501365	1/2" F x EUROK	■	13,75 €	MA	6 / 72

AS 1926

- Dima frazionabile per scatole di distribuzione sottotraccia SS 1730 / 1735.
- Divisible template for under-floor distribution boxes SS 1730 / 1735.
- Platine de fixation pouvant être fractionnée pour les boîtes de distribution encastrée SS 1730 / 1735.
- Trennbare Halterung für Unterputz-Dose SS 1730 / 1735.
- Plantilla fraccionable para cajas de distribución empotrables SS 1730 / 1735.

Code	Size	Price	Class	Packaging
550038	SS 1730 - SS 1735	4,633 €	JC	50

RR 702

- Tubo di raccordo in rame cromato a tenuta morbida per scatole di distribuzione sottotraccia.
- Chrome-plated copper connection pipe with soft seal for concealed distribution boxes.
- Tube de raccord en cuivre chromé à étanchéité souple pour boîtes de distribution encastrées.
- Verbindungsrohr aus verchromtem Kupfer mit O-Ring für Anschlussbox für Unterputzanwendung.
- Tubo de conexión con cobre plateado con asiento blando para la caja de distribución bajo el yeso.

Code	Size	Color	Price	Class	Packaging
520003	Ø15 x 1/2" M - 108 mm	■	9,21 €	JC	35 / 280
520001	Ø15 x 1/2" M - 175 mm	■	11,13 €	JC	30 / 240

TOOLS AND GENERAL ACCESSORIES

AR 32



- Cesoia per tubi di plastica TC 32 Professional.
- Shear for plastic pipe TC 32 Professional.
- Coupe-tube pour tuyaux en plastique TC 32 Professional.
- Kunststoffrohr-Scher TC 32 Professional.
- Tijeras para tubos de plástico TC 32 Professional.



Code	Price	Class	Packaging
52040	111,66 €	IR	1

AR 32 L



- Lama di ricambio TC 32.
- Spare blade for TC 32.
- Lame de rechange pour TC 32.
- Kunststoffrohr-Scher TC 32 Professional.
- Tijeras para tubos de plástico TC 32 Professional.



Code	Price	Class	Packaging
52041	42,34 €	IR	1

AR 42



- Tagliatubi TC 42 PRO MSR.
- Pipe cutter TC 42 PRO MSR.
- Coupe-tube TC 42 PRO MSR.
- Rohrabschneider TC 42 PRO MSR.
- Cortatubos TC 42 PRO MSR.



Code	Price	Class	Packaging
70109	182,77 €	IR	1

AR 42 L



- Lama di ricambio TC 42 (5 pezzi).
- Spare blade for TC 42 (5 pcs).
- Lame de rechange pour TC 42 (5 pcs).
- Ersatzmesser für TC 42 (5 stk).
- Cuchilla de TC 42 (5 pz).



Code	Price	Class	Packaging
070188D	104,98 €	IR	1

AR 67



- Tagliatubi TC 67 PL.
- Pipe cutter TC 67 PL.
- Coupe-tube TC 67 PL.
- Rohrabschneider TC 67 PL.
- Cortatubos TC 67 PL.



Code	Price	Class	Packaging
70031	249,40 €	IR	1

AR 64



- Tagliatubi PLASTICUT MSR Set.
- Pipe cutter PLASTICUT MSR Set.
- Coupe-tube PLASTICUT MSR Set.
- Rohrabschneider PLASTICUT MSR Set.
- Cortatubos PLASTICUT MSR Set.



Code	Size	Price	Class	Packaging
88700	16 - 20 - 25/26 mm	158,04 €	IR	1

AR 43



- Cesoia per tubi di plastica TC 42 Professional.
- Shear for plastic pipe TC 42 Professional.
- Coupe-tube pour tuyaux en plastique TC 42 Professional.
- Kunststoffrohr-Scher TC 42 Professional.
- Tijeras para tubos de plástico TC 42 Professional.



Code	Price	Class	Packaging
52000	154,98 €	IR	1

AR 43 L



- Lama di ricambio TC 42 Professional.
- Spare blade for TC 42 Professional.
- Lame de rechange pour TC 42 Professional.
- Ersatzmesser für TC 42 Professional.
- Cuchilla de TC 42 Professional.



Code	Price	Class	Packaging
52042	85,10 €	IR	1

AR 63



- Cesoia per tubi di plastica TC 63 Professional.
- Shear for plastic pipe TC 63 Professional.
- Coupe-tube pour tuyaux en plastique TC 63 Professional.
- Kunststoffrohr-Scher TC 63 Professional.
- Tijeras para tubos de plástico TC 63 Professional.



Code	Price	Class	Packaging
52030	232,72 €	IR	1

AR 63 L



- Lama di ricambio TC 63 Professional.
- Spare blade for TC 63 Professional.
- Lame de rechange pour TC 63 Professional.
- Ersatzmesser für TC 63 Professional.
- Cuchilla de TC 63 Professional.



Code	Price	Class	Packaging
52031	163,87 €	IR	1

AR 01

- Calibratore per tubo multistrato.
- Caliper for multilayer pipe.
- Calibrateur pour tubes multicouches.
- Kaliber für Verbundrohr.
- Calibrador para tubo multicapa.

Code	Size	Price	Class	Packaging
500406	Pipe from Ø16/2 to Ø32/3 mm	160,41 €	IR	1
500407	40/3,5	160,41 €	IR	1
500408	50/4	187,35 €	IR	1
500409	63/4,5	245,76 €	IR	1

AR 02

- Kit calibratori per tubo multistrato completo di valigetta in materiale plastico.
- Kit of calipers for multilayer pipe complete with plastic carrying case.
- Kit calibreurs pour tube multicouches avec coffret en plastique.
- Kalibrierungssatz für mehrschichtige Rohre mit Plastikkoffer.
- Kit calibradores para tubo multicapa con maletín de plástico.

Code	Size	Price	Class	Packaging
501797	Ø14/2 - Ø16/2 - Ø18/2 - Ø20/2 - Ø26/3 - Ø32/3 - Ø40/3,5 - Ø50/4 - Ø63/4,5	842,42 €	IR	1

AR 09

- Impugnatura per calibratore per tubo multistrato.
- Grip for multilayer pipe caliper.
- Poignée pour calibrateur pour tubes multicouches.
- Griff für das Kalibrierungsgerät für mehrschichtige Rohre.
- Empuñadura para calibrador para tubo multicapa.

Code	Price	Class	Packaging
IM0001	60,76 €	IR	1

AR 04

- Calibratori per tubo multistrato.
- Calipers for multilayer pipe.
- Calibreurs pour tubes multicouches.
- Kalibere für Verbundrohr.
- Calibradores para tubo multicapa.

Code	Size	Price	Class	Packaging
CA0001	14/2	57,44 €	IR	1
CA0002	16/2	58,56 €	IR	1
CA0013	16/2,25	58,56 €	IR	1
CA0003	18/2	60,76 €	IR	1
CA0004	20/2	64,08 €	IR	1
CA0015	20/2,25	64,08 €	IR	1
CA0016	20/2,5	64,08 €	IR	1
CA0017	25/2,5	77,35 €	IR	1
CA0005	26/3	77,35 €	IR	1
CA0006	32/3	97,23 €	IR	1
CA0007	40/3,5	141,42 €	IR	1
CA0008	50/4	224,28 €	IR	1
CA0009	63/4,5	386,69 €	IR	1

HD17

- Svolgirotolo per tubo in polietilene e multistrato.
- Roll distributor for polyethylene and multilayer pipe.
- Derouleur pour tubes en polyéthylène et multicouche.
- Abroller für Polyethylen- und Verbundrohr.
- Desbobinadora para tubo de polietileno y multicapa.

Code	Size	Price	Class	Packaging
HD17	Pipe from Ø16 to Ø26 mm	524,92 €	IR	1

AC 670

- Chiave per raccordi a stringere.
- Wrench for compression fittings.
- Clé pour raccords à serrage.
- Schlüssel für Pressanschlüsse.
- Llave para accesorios de compresión.

Code	Size	Price	Class	Packaging
501181	24-27 mm	37,66 €	JC	15

AC 671

- Chiave per nipples girevoli.
- Wrench for rotating nipples.
- Clé pour nipples pivotants.
- Schlüssel für drehbare Anschlussstücke.
- Llave para enterroscas giratorias.

Code	Size	Price	Class	Packaging
500030	27-30 mm	6,49 €	JC	20 / 160
500029	37-48 mm	9,24 €	JC	20

AR 75



- Pinza automatica regolabile ROGRIP M.
- Quickly adjustable water pump plier ROGRIP M.
- Pince multiprise à réglage rapide ROGRIP M.
- Schnellverstellbare Wasserpumpenzange ROGRIP M.
- Tenazas de canal con ajuste rápido ROGRIP M.

Code	Size	Price	Class	Packaging
1000002699	10" - Ø 2"	55,53 €	IR	1

AR 77



- Giratubi 90°.
- Pipe Wrench 90°.
- Clé Serre-tube 90°.
- Rhorzange 90°.
- Llaves suecas 90°.

Code	Size	Price	Class	Packaging
070110X	1"	115,19 €	IR	1
070111X	1"1/2	164,26 €	IR	1
070112X	2"	260,86 €	IR	1

AR 76



- Chiave fissa e chiave a cricco ad anello snodata ROCLICK.
- Combined open-ended / hinged ratchet wrench ROCLICK.
- Clé combinée à fourche et cliquet articulé ROCLICK.
- Kombi Maul-/Gelenk-Ratschenschlüssel ROCLICK.
- Combinación llave fija / carraca articulada ROCLICK.

Code	Size	Price	Class	Packaging
70490	8-10-11-13-14-17-19	413,63 €	IR	1

AR 50



- Curvatubi TUBE BENDER MSR 32 SET.
- TUBE BENDER MSR 32 SET.
- Cintreuse TUBE BENDER MSR 32 SET.
- Biegegerät TUBE BENDER MSR 32 SET.
- Curvadora TUBE BENDER MSR 32 SET.

Code	Size	Price	Class	Packaging
23095	14-16-18-20-26-32 mm	1.189,04 €	IR	1
23065	14-16-18-20-25-32 mm	1.145,85 €	IR	1

AR 1920



- Anima flessibile interna per la curvatura rapida dei tubi.
- Flexible internal core for rapid pipe bends.
- Noyau flexible interne pour le cintrage rapide des tubes.
- Flexibler Kern für Inneranwendung zum Schnellbiegen des Rohres.
- Alma flexible interior para la rápida curva de los tubos.

Code	Size	Price	Class	Packaging
140069	16/2	9,03 €	IR	1
140060	16/2	24,59 €	IR	1
140068	18/2	12,00 €	IR	1
140066	18/2	26,27 €	IR	1
140081	20/2	12,00 €	IR	1
140082	20/2	26,27 €	IR	1
140043	26/3	15,70 €	IR	1
140042	32/3	15,70 €	IR	1

AR 1921



- Anima flessibile esterna per la curvatura rapida dei tubi.
- Flexible external core for rapid pipe bends.
- Noyau flexible externe pour le cintrage rapide des tubes.
- Flexibler Kern für Außenanwendung zum Schnellbiegen des Rohres.
- Alma flexible exterior para la rápida curva de los tubos.

Code	Size	Price	Class	Packaging
140045	16/2	9,63 €	IR	1
140044	18/2	16,11 €	IR	1
140039	20/2	16,11 €	IR	1

AR 37

- Pressatrice ROMAX 4000 a batteria completa di valigetta, batteria e caricabatterie.
- ROMAX 4000 battery-pressmachine with transport case, battery and charger.
- Machine à sertir ROMAX 4000 à batteries complet de valise, batterie et chargeur.
- Batteriebetriebene Pressmaschine ROMAX 4000 komplett mit Koffer, Akku und Ladegerät.
- Prensa con batería ROMAX 4000 dotada de caso, batería y cargador.



Code	Size	Price	Class	Packaging
1000002683	Ø 12-108 mm - 32 kN / 40 mm	3.486,04 €	IR	1

AR 37 B

- Batteria per ROMAX 4000.
- Battery for ROMAX 4000.
- Batterie pour ROMAX 4000.
- Akku für ROMAX 4000.
- Batería para ROMAX 4000.



Code	Price	Class	Packaging
1000002548	503,27 €	IR	1

AR 37 C

- Caricabatteria per ROMAX 4000.
- Charger for ROMAX 4000.
- Chargeur pour ROMAX 4000.
- Ladegerät für ROMAX 4000.
- Cargador para ROMAX 4000.



Code	Price	Class	Packaging
1000001654	339,78 €	IR	1

AR 120

- Ganascia madre per catene ZSB1.
- Intermediate jaw for pressing collars ZSB1.
- Mâchoire intermédiaire pour chaînes de sertissage ZSB1.
- Zwischenbacke für Pressschlingen ZSB1.
- Mordaza intermedia para collares de presión.



Code	Price	Class	Packaging
1000001126	967,56 €	IR	1

AR 10 R

- Pinze per raccordi a pressare.
- Jaws for press fittings.
- Pincés pour raccords à presser.
- Zangen für Pressanschlüsse.
- Pinzas para accesorios a presnar.



Code	Size	Price	Class	Packaging
501741RBE	Ø16 BE	694,10 €	IR	1
501743RBE	Ø20 BE	694,10 €	IR	1
501744RBE	Ø26 BE	694,10 €	IR	1
501745RBE	Ø32 BE	694,10 €	IR	1
501741RR	Ø16 R	390,75 €	IR	1
501742RR	Ø18 R	390,75 €	IR	1
501743RR	Ø20 R	390,75 €	IR	1
501730RR	Ø25 R	511,65 €	IR	1
501744RR	Ø26 R	390,75 €	IR	1
501745RR	Ø32 R	390,75 €	IR	1
501741RTH	Ø16 TH	318,16 €	IR	1
501742RTH	Ø18 TH	390,75 €	IR	1
501743RTH	Ø20 TH	318,16 €	IR	1
501730RTH	Ø25 TH	390,75 €	IR	1
501744RTH	Ø26 TH	318,16 €	IR	1
501745RTH	Ø32 TH	318,16 €	IR	1
501746RTH	Ø40 TH	792,80 €	IR	1
501741RU	Ø16 U	390,75 €	IR	1
501742RU	Ø18 U	390,75 €	IR	1
501743RU	Ø20 U	390,75 €	IR	1
501730RU	Ø25 U	390,75 €	IR	1
501745RU	Ø32 U	390,75 €	IR	1
501746RU	Ø40 U	792,80 €	IR	1

AR 110

- Catene.
- Pressing collars.
- Chaines de sertissage Standard.
- Pressschlingen Standard.
- Collares de presión.



Code	Size	Price	Class	Packaging
1000001810	Ø50 TH	1.534,85 €	IR	1
1000001811	Ø63 TH	1.534,85 €	IR	1

AR 55



- Sistema di congelamento per tubi in rame e acciaio ROFROST® TURBO.
- ROFROST® TURBO pipe freezing system for copper, steel, stainless steel pipes.
- Appareil de congélation des tubes pour les tubes en cuivre et acier ROFROST® TURBO.
- Rohrefriersysteme für Kupfer- und Stahlrohre ROFROST® TURBO.
- Sistema de congelador para tubos de cobre y acero ROFROST® TURBO.

Code	Size	Price	Class	Packaging
1500003000	1"1/4	3.690,82 €	IR	1
1500003001	3/4" - 2"	5.231,35 €	IR	1

AR 70



- Telecamera ROSCOPE® i2000 Modul 25/16 per ispezioni di tubi da Ø 50 a 100 mm.
- ROSCOPE® i2000 Module 25/16 high-performance camera for the inspection of pipes from Ø 50 up to 100 mm.
- Caméra haute performance Module ROSCOPE® i2000 25/16 pour l'inspection de tubes de Ø 50 à 100 mm.
- Hochleistungskamera ROSCOPE® i2000 Modul 25/16 zur Inspektion von Rohren Ø 50 bis 100 mm.
- Cámara de alto rendimiento Conjunto ROSCOPE® i2000 Modul 25/16 para la inspección de tuberías de Ø 50 hasta 100 mm.

Code	Size	Price	Class	Packaging
1000000842	Pipe from Ø 50 to Ø 100 mm	8.242,85 €	IR	1

AR 73



- Pompa provaimpianti elettrica autoadescante RP PRO III.
- Self-priming electric testing pump RP PRO III.
- Pompe électrique de remplissage et contrôle à auto-aspirante RP PRO III.
- Selbstansaugende elektrische Befüll- und Prüfpumpe RP PRO III.
- Bomba de comprobación con autocebado y llenado eléctrico RP PRO III.

Code	Max inlet pressure	Price	Class	Packaging
61185	40 bar	2.084,06 €	IR	1

AR 60



- Compressore ROPULS per la pulizia e la manutenzione di impianti di riscaldamento e acqua potabile secondo EN 806 / DIN 1988-2.
- ROPULS flushing compressor for scouring and cleaning of heating systems and flushing of drinking water pipes according to EN 806 / DIN 1988-2.
- Compresseur nettoyeur ROPULS pour le débouillage et le nettoyage de systèmes de chauffage et pour le rinçage de conduites d'eau potable selon la EN 806/ DiN 1988-2.
- Spülkompressor ROPULS zum Entschlammn und Reinigen von Heizungssystemen und zum Spülen von Trinkwasserleitungen nach EN 806 / DIN 1988-2.
- Compresor de limpieza por barrido ROPULS para el abastecimiento y la limpieza de sistemas de calefacción y el barrido de instalaciones de agua potable según DIN 1988-2.

Code	Size	Price	Class	Packaging
1000001134	Pipe max Ø DN 50 / 2"	7.137,81 €	IR	1
1000000145	Pipe max Ø DN 50 / 2"	6.909,03 €	IR	1

AR 71



- Pompa provaimpianti compatta TP 25.
- TP 25 small and robust precision testing pump for pressure testing.
- Petite pompe de précision TP 25 robuste pour épreuve de pression.
- Kleine und robuste Präzisionsprüfpumpe TP 25 für die Druckprüfung.
- Bomba de comprobación de presión precisa, pequeña y sólida TP 25.

Code	Size	Price	Class	Packaging
60250	Tank 7 l	666,63 €	IR	1

AR 72



- Pompa provaimpianti di precisione RP 50-S in struttura monoblocco.
- Robust precision testing pump RP 50-S for pressure testing of water lines and containers with very high testing standards.
- Pompe d'épreuve de précision robuste RP 50-S pour l'épreuve des conduites d'eau et des réservoirs avec exigences élevées de contrôle.
- Robuste Präzisionsprüfpumpe RP 50-S für die Druckprüfung von Wasserleitungen und Behältern mit hohen Prüfanforderungen.
- Sólida bomba RP 50-S para realizar comprobaciones de precisión sobre la presión de tuberías de agua y contenedores con niveles de exigencia muy altos.

Code	Size	Price	Class	Packaging
60200	Tank 12 l	932,87 €	IR	1

AR 74



- Unità elettrica ROSOLAR PUMP per risciacquare, riempire e svuotare impianti a circuito chiuso.
- ROSOLAR solar filling pump.
- Pompe de remplissage solaire ROSOLAR PUMP.
- Solar Befüllpumpe ROSOLAR PUMP.
- Bomba de llenar para rellenar, limpiar y ventilar sistemas solares y geotérmicos ROSOLAR PUMP.

Code	Size	Price	Class	Packaging
1500000135	3/4" - Tank 30 l	1.789,74 €	IR	1

PT 5706



- Tappo autofilettante.
- Self-threading plug.
- Bouchon à vis.
- Abdruckstopf.
- Tapón autorroscante.

Code	Size	Color	Price	Class	Packaging
510112	16/2	■	13,90 €	JC	200
510114	20/2	■	14,20 €	JC	200

MANIFOLDS

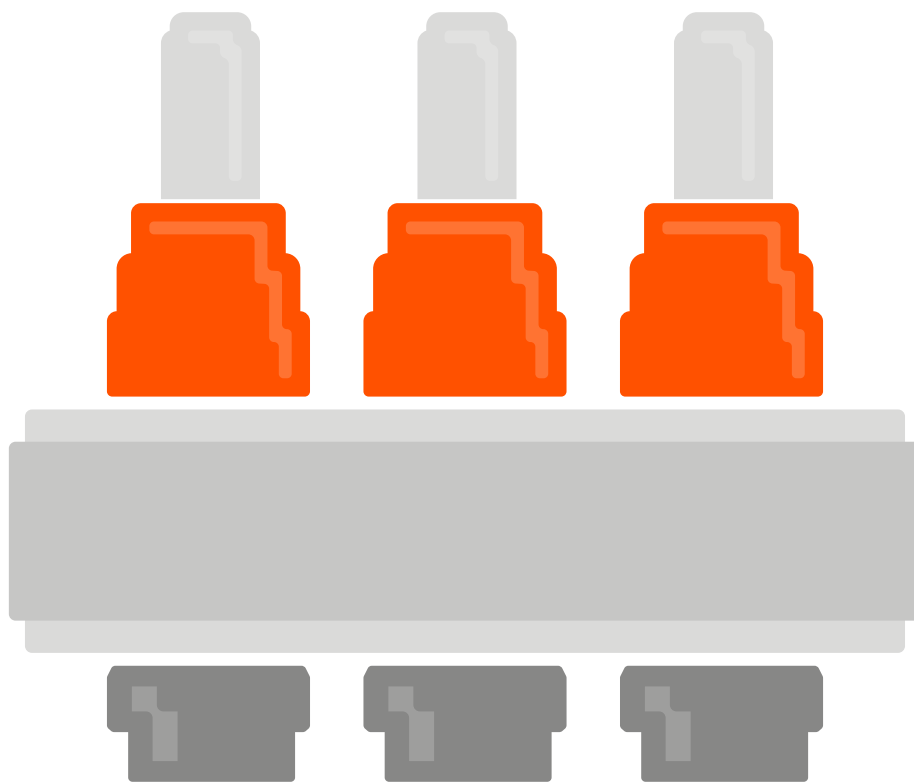

pim.ivar-group.com/short/IT-03

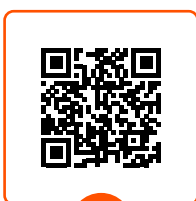

DOWNLOAD
Focus tecnici



pim.ivar-group.com/short/FR-03

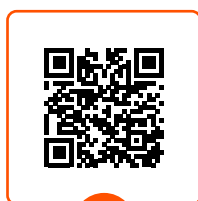

DOWNLOAD
Détails techniques



pim.ivar-group.com/short/DE-03









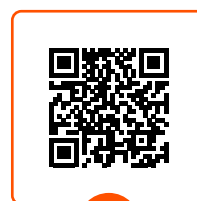



DOWNLOAD
Technische Details



pim.ivar-group.com/short/ES-03



DOWNLOAD
Profundizaciones técnicas

	Collettori componibili EASY•RADIANT <i>Modular manifolds EASY•RADIANT</i> Collecteurs à éléments EASY•RADIANT <i>Einbauverteiler EASY•RADIANT</i> Colectores componibles EASY•RADIANT	138
	Collettori da barra in ottone <i>Brass-rod manifolds</i> Collecteurs de barre en laiton <i>Verteiler aus Messingstangen</i> Colectores de barra de latón	142
	Collettori in acciaio inox <i>Stainless steel manifolds</i> Collecteurs en acier inox <i>Edelstahl-Verteiler</i> Colectores de acero inoxidable	178
	Collettori in tecnopolimero <i>Technopolymer manifolds</i> Collecteurs en technopolymère <i>Technopolymerverteiler</i> Colectores en tecnopolímero	200
	Cassette <i>Cabinets</i> Cassettes <i>Kasten</i> Cajas	204
	Terminali per collettori <i>Terminals for manifolds</i> Parties terminales pour collecteurs <i>Verteilerendstücke</i> Terminales para colectores	206
	Valvole di sfiato <i>Air vent valves</i> Purgeurs d'air <i>Entlüftungsventile</i> Válvulas purgadoras	207
	Staffe <i>Brackets</i> Étriers <i>Wandalterungen</i> Soportes	208
	Valvole di bypass <i>Bypass valves</i> Vannes de bypass <i>Bypass-Ventile</i> Válvulas de bypass	210
	Raccordi e tappi <i>Fittings and plugs</i> Raccords et bouchons <i>Verbinder und Verschlüsse</i> Racores y tapones	212

Ricambi e articoli complementari
Spare parts and complementary items
Pièces détachées et articles complémentaires
Ersatzteile und Komplementärartikeln
Repuestos y artículos complementarios
217

Valvole a sfera
Ball valves
Vannes à bille
Kugelventile
Válvulas de bola
221

Valvole di zona
Zone valves
Vannes de zone
Zonenventile
Válvulas de zona
226

EASY•RADIANT

The EASY•RADIANT series manifolds are used for distribution of the heat transfer fluid in radiant systems. They are equipped with Fluxer balancing devices on flow manifold and thermostatic inserts on return manifold. EASY•RADIANT series features the option for practical and simple interconnection with one another. Thanks to the offset design of the threads, manifolds remain aligned and the action of an O-ring ensures perfect sealing efficiency. This means there is no need for additional sealing elements such as hemp or PTFE or the use of additional sealants.

Materials

Brass parts: yellow CW617N

Sealing elements: peroxide EPDM



Technical specifications

Max. fluid temperature inside manifold: 90 °C

Maximum operating pressure: 10 bar

Outlet centre-to-centre distance: 40 mm

PLUS

- Automatic alignment thanks to offset threads 
- Offset female thread to house and safeguard the O-ring during installation
- Available with 3, 4 or 5 outlets and main fitting 1"
- Versions with outlets 3/4" EK and M24
- O-ring for soft seal: no additional sealant required 

MANIFOLDS KIT WIDTH AND SUITABLE CABINET

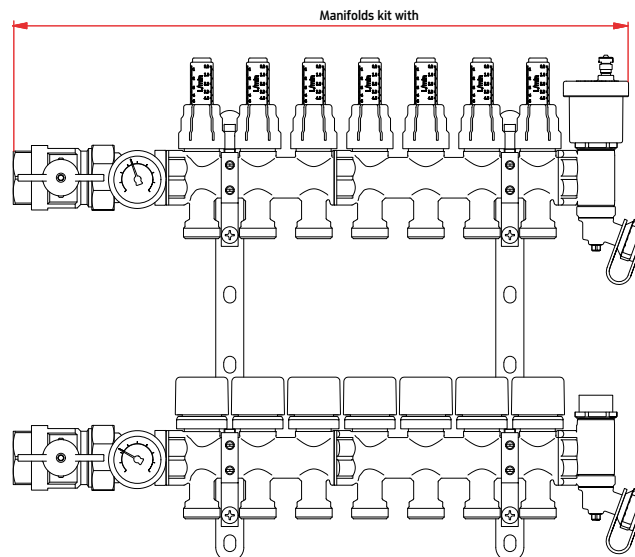

Manifold ways	3	4	5	6	7	8	9	10	11	12	13
1" manifolds kit width	280 mm	320 mm	360 mm	400 mm	440 mm	480 mm	520 mm	560 mm	600 mm	640 mm	680 mm
 Cabinet code Cabinet width	200130 500 mm	200130 500 mm	200130 500 mm	200130 500 mm	200131 700 mm	200131 700 mm	200131 700 mm	200131 700 mm	200131 700 mm	200132 850 mm	200132 850 mm
 Cabinet code Cabinet width	200086 500 mm	200086 500 mm	200086 500 mm	200086 500 mm	200686 600 mm	200686 600 mm	200186 700 mm	200186 700 mm	200186 700 mm	200786 800 mm	200786 800 mm

EXAMPLES OF APPLICATION FOR EASY•RADIANT MANIFOLD ACCESSORIES



FLUXER®

Fluxer is the IVAR device for balancing and the display of flow rates on single circuits.

Glass panel replaceable also with system in operation
Possibility of shutoff and position memory

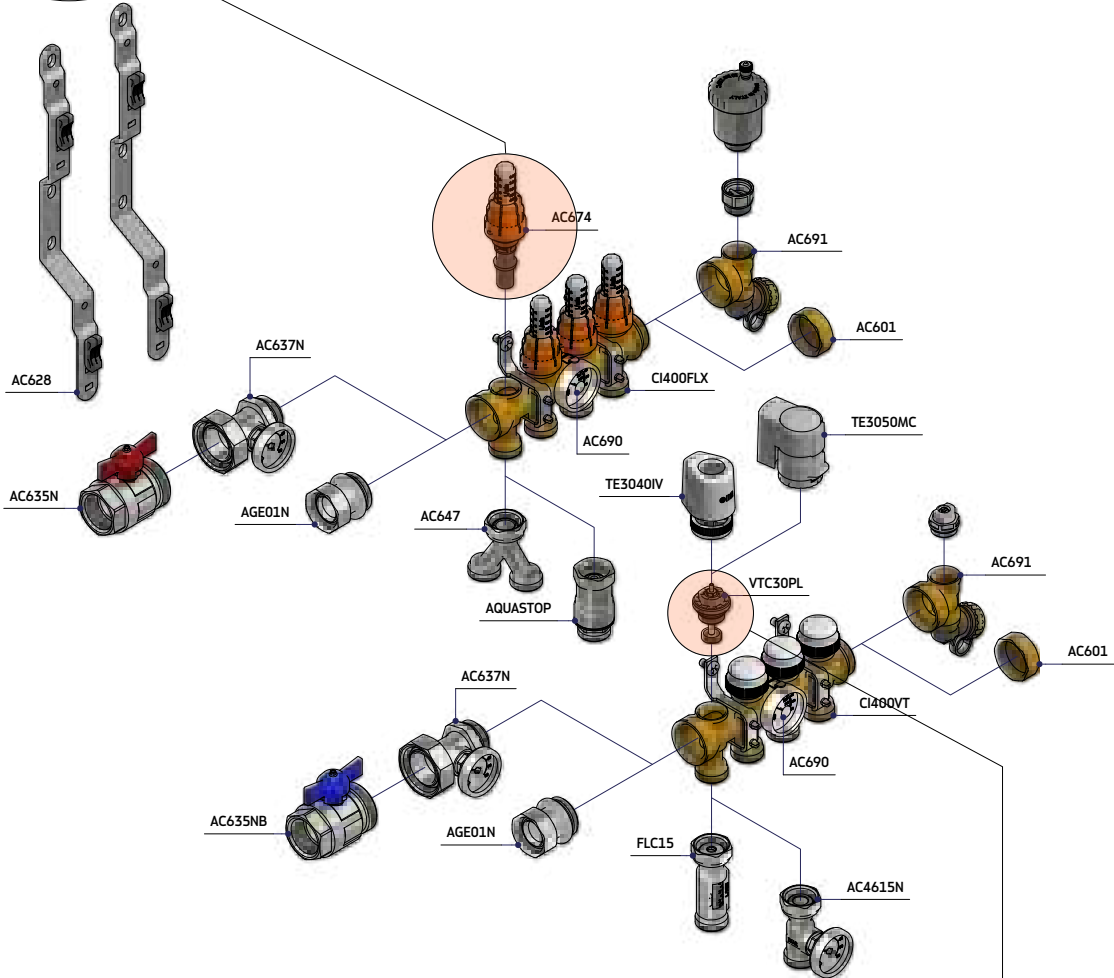

INSERT WITH THERMOSTATIC CONTROL OPTION

The manifolds with thermostat control option are supplied with a control knob serving to protect the thread and possible shutoff of the bypass circuit.



The control rod can also be replaced with the system in operation.



■ CI 400 KC



0-2,5 l/min ON REQUEST

- Kit EASY RADIANT (interasse 40 mm) composto da collettore componibile di mandata con misuratori/regolatori di portata FLUXER (0-5 l/min), collettore componibile di ritorno con valvole di intercettazione con cappuccio di protezione per vitone termostattizzabile e attacchi EUROK.
- EASY RADIANT kit (centre-to-centre distance 40 mm) made of modular flow manifold with flow meters/adjusters FLUXER (0-5 l/min), modular return manifold with isolation valves with protection cap for thermostatic insert and EUROK connections.
- Kit EASY RADIANT (empattement 40 mm) composé d'un collecteur à éléments d'envoi avec débit-mètres/régulateurs FLUXER (0-5 l/min), un collecteur à éléments de retour avec des vannes d'interception avec capuchon de protection pour insert thermostatisable et embouts EUROK.
- EASY RADIANT-Bausatz (Radstand 40 mm) besteht aus Vorlauf-Einbauverteiler mit Durchflussmengenmesser FLUXER (0-5 l/min), Rücklauf-Einbauverteiler mit Absperbarenventilen mit Schutzkappe für Thermostat-Reguliovorrichtung und EUROK Anschließen.
- Conjunto EASY RADIANT (distancia entre ejes 40 mm) dotado de colector componible de impulsión con medidores/reguladores de caudal FLUXER (0-5 l/min), colector componible de retorno con válvulas de cierre con tapa de protección para tornillo termostatzable y conexiones EUROK.

Code	Ways	Size	OC distance	Color	Price	Class	Packaging
506875	3	1" x EUROK	40 mm	Yellow	128,68 €	OH	1 / 8
506876	4	1" x EUROK	40 mm	Yellow	161,28 €	OH	1 / 8
506877	5	1" x EUROK	40 mm	Yellow	193,89 €	OH	1 / 8

■ CI 400 FLX



0-2,5 l/min ON REQUEST

- Collettore componibile serie EASY RADIANT (interasse 40 mm) di mandata con misuratore/regolatore portata FLUXER (0-5 l/min) e attacchi EUROK.
- Modular flow manifold EASY RADIANT series (centre-to-centre distance 40 mm) with flow meter/adjuster FLUXER (0-5 l/min) and EUROK connections.
- Collecteur à éléments série EASY RADIANT (empattement 40 mm) d'envoi avec débit-mètre/régulateur FLUXER (0-5 l/min) et embouts EUROK.
- Vorlauf-Einbauverteiler Serie EASY RADIANT (Radstand 40 mm) mit Durchflussmengenmesser FLUXER (0-5 l/min) und EUROK Anschließen.
- Colector componible serie EASY RADIANT (distancia entre ejes 40 mm) de impulsión con medidor/regulador de caudal FLUXER (0-5 l/min) y conexiones EUROK.

Code	Ways	Size	OC distance	Color	Price	Class	Packaging
506862	3	1" x EUROK	40 mm	Yellow	71,45 €	OH	18
506863	4	1" x EUROK	40 mm	Yellow	89,89 €	OH	15
506864	5	1" x EUROK	40 mm	Yellow	108,33 €	OH	15

■ CI 400 VT



- Collettore componibile serie EASY RADIANT (interasse 40 mm) di ritorno con valvole di intercettazione con cappuccio di protezione per vitone termostattizzabile e attacchi EUROK.
- Modular return manifold EASY RADIANT series (centre-to-centre distance 40 mm) with isolation valves with protection cap for thermostatic insert and EUROK connections.
- Collecteur à éléments série EASY RADIANT (empattement 40 mm) de retour avec vannes d'interception avec capuchon de protection pour insert thermostatisable et embouts EUROK.
- Rücklauf-Einbauverteiler Serie EASY RADIANT (Radstand 40 mm) mit Absperbarenventilen mit Schutzkappe für Thermostat-Reguliovorrichtung und EUROK Anschließen.
- Colector componible serie EASY RADIANT (distancia entre ejes 40 mm) de retorno con válvulas de cierre con tapa de protección para tornillo termostatzable y conexiones EUROK.

Code	Ways	Size	OC distance	Color	Price	Class	Packaging
506865C	3	1" x EUROK	40 mm	Yellow	57,23 €	OH	20
506866C	4	1" x EUROK	40 mm	Yellow	71,40 €	OH	18
506867C	5	1" x EUROK	40 mm	Yellow	85,56 €	OH	12



- Cassetta non inclusa >> p. 204
- Cabinet not included >> p. 204
- Casette pas inclus >> p. 204
- Kasten nicht enthalten >> p. 204
- Caja no incluida >> p. 204



- Raccordo per tubo multistrato >> p. 66,123,212,428
- Fitting for multilayer pipe >> p. 66,123,212,428
- Raccord pour tube multicouche >> p. 66,123,212,428
- Verschraubung für Verbundrohr >> p. 66,123,212,428
- Conexión para tubo multicapa >> p. 66,123,212,428



- Raccordo per tubo in polietilene >> p. 66,124,212,428
- Fitting for polyethylene pipe >> p. 66,124,212,428
- Raccord pour tube en polyéthylène >> p. 66,124,212,428
- Verschraubung für PEX-Rohr >> p. 66,124,212,428
- Conexión para tubo de polietileno >> p. 66,124,212,428



- Valvole a sfera >> p. 221,308,323
- Ball valves >> p. 221,308,323
- Vannes à bille >> p. 221,308,323
- Kugelventile >> p. 221,308,323
- Válvulas de bola >> p. 221,308,323

AC 691

- **Kit di terminali orientabili per collettori EASY-RADIANT con rubinetti di scarico, valvola di ritegno, valvola di sfianto automatica e manuale.**
- *Kit of swiveling terminals for EASY-RADIANT manifolds with drainage valves, check valve, automatic and manual air vent valves.*
- **Kit de terminals orientables pour collecteurs EASY-RADIANT avec robinets de vidange, clapet de retenue, purgeur automatique et manuel.**
- *Verstellbare Endstück-Kit für EASY-RADIANT Verteiler mit Entleerungshahn, Rückschlagventil, automatischem und manuellem Entlüftungsventil.*
- **Kit de terminales orientables para colectores EASY-RADIANT con llaves de descarga, válvula de retención, válvula purgadora automática y manual.**

Code	Size	Price	Class	Packaging
500134	1" F	44,60 €	NJ	1

AC 628

- **Staffa doppia per collettori componibili serie EASY-LOCK / BASIC / EASY-RADIANT.**
- *Double bracket for modular manifolds EASY-LOCK / BASIC / EASY-RADIANT series.*
- **Étrier double pour collecteurs à éléments de la série EASY-LOCK / BASIC / EASY-RADIANT.**
- *Doppelt Wandalterung für Einbauverteiler der Serie EASY-LOCK / BASIC / EASY-RADIANT.*
- **Soporte doble para colectores componibles de la serie EASY-LOCK / BASIC / EASY-RADIANT.**

Code	OC distance	Depth	Manifolds type	Price	Class	Packaging
501632	200 mm	80 mm	1" (EASY-LOCK / BASIC / EASY-RADIANT series)	8,07 €	NJ	2 / 70
501639	200 mm	95 mm	1" (EASY-LOCK / BASIC / EASY-RADIANT series)	7,54 €	NJ	2 / 70

AC 694

- **Copertura isolante per collettori EASY-RADIANT, adatta per impianti di riscaldamento/raffrescamento radiante.**
- *Insulating cover for EASY-RADIANT manifolds, suitable for radiant heating/cooling systems.*
- **Couverture isolante pour collecteurs EASY-RADIANT, adaptée pour systèmes radiants de chauffage/refroidissement.**
- *Isolierabdeckung für Verteiler EASY-RADIANT, geeignet für Fussbodenheizung- und Kühlung Systeme.*
- **Cubierta de aislamiento para colectores EASY-RADIANT, adecuada para sistemas de calefacción y enfriamiento radiante.**

Code	Ways	Manifolds type	Price	Class	Packaging
506547	12	1"	20,96 €	NJ	5

TE 3040 IV

- **Testa elettrotermica normalmente chiusa (2 fili). Compatibile con tutti i vitoni termostattizzabili IVAR e i collettori con interasse \geq 40 mm.**
- *Electrothermal head normally closed (2 wires). Suitable for all IVAR thermostatic inserts and manifolds with centre-to-centre distance \geq 40 mm.*
- **Tête électrothermique normalement fermée (2 fils). Adaptée pour tous les inserts thermostatisables IVAR et aux collecteurs avec entraxe \geq 40 mm.**
- *Elektrothermischer Stellantrieb stromlos-zu (2 Kabel). Geeignet für alle Thermostat-Regulievorrichtungen IVAR und für Verteiler mit Achsabstand \geq 40 mm.*
- **Cabeza electrotrémica normalmente cerrada (de 2 hilos). Adecuada para todos los tornillos termostattizables IVAR y los colectores con distancia entre centros \geq 40 mm.**

Code	Size	Price	Class	Packaging
501508E	M30 x 1,5 ; ON / OFF (230 V AC)	29,64 €	AC	100

TE 3050 MC

- **Testa elettrotermica normalmente chiusa con contatto di fine corsa (4 fili). Compatibile con tutti i vitoni termostattizzabili IVAR e i collettori con interasse \geq 40 mm.**
- *Electrothermal head normally closed with limit switch contact (4 wires). Suitable for all IVAR thermostatic inserts and manifolds with centre-to-centre distance \geq 40 mm.*
- **Tête électrothermique normalement fermée avec contact de fin de course (4 fils). Adaptée pour tous les inserts thermostatisables IVAR et aux collecteurs avec entraxe \geq 40 mm.**
- *Elektrothermischer Stellantrieb stromlos-zu mit Endschalterkontakt (4 Kabel). Geeignet für alle Thermostat-Regulievorrichtungen IVAR und für Verteiler mit Achsabstand \geq 40 mm.*
- **Cabeza electrotrémica normalmente cerrada con contacto de fin de carrera (de 4 hilos). Adecuada para todos los tornillos termostattizables IVAR y los colectores con distancia entre centros \geq 40 mm.**

Code	Size	Price	Class	Packaging
500808MC	M30 x 1,5 ; ON / OFF (230 V AC)	43,43 €	AC	100

BRASS-ROD MANIFOLDS

Bar manifolds are machined and undergo stress relieving heat treatment after mechanical processing. They are then assembled with automated processes and tested individually. A complete set of sizes are available, with versions and accessories for control of the single ways. They can be purchased pre-assembled on standard or lowered brackets in delivery/return kits. Numerous accessories complete the manifold with all components required for optimal system operation: ball shutoff valves, air purge valves, filler-drain valves, bypass valves, housing cabinets and individual isolation.

Materials

Body: brass CW617N
 Seals and O-rings: peroxide EPDM
 Shutoff knobs and caps: ABS

Technical specifications

Max. fluid temperature: 120 °C; versions with FLUXER: 90 °C
 Maximum operating pressure: 10 bar

PLUS

- Subject to stress relieving heat treatment to remove residual tension due to mechanical processing.
- Each manifold is tested to guarantee grip on assembled components and on 100% of production.
- Compatible with both low and high temperatures.

MANIFOLDS KIT WIDTH AND SUITABLE CABINET

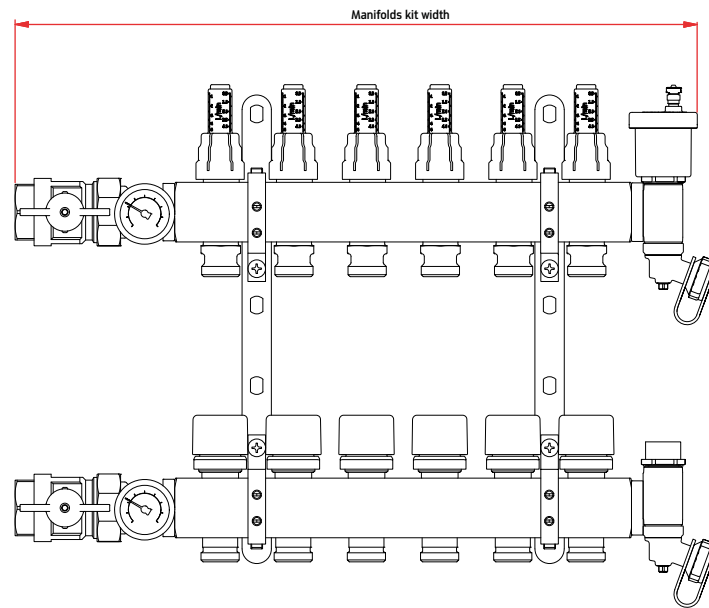

Manifold ways	2	3	4	5	6	7	8	9	10	11	12	13
1" manifolds kit width	266 mm	316 mm	366 mm	416 mm	466 mm	516 mm	566 mm	616 mm	666 mm	716 mm	766 mm	816 mm
 AC 840 E	Cabinet code	200130	200130	200130	200131	200131	200131	200131	200132	200132	200133	200133
	Cabinet width	500 mm	500 mm	500 mm	700 mm	700 mm	700 mm	700 mm	850 mm	850 mm	1.000 mm	1.000 mm
 AC 840	Cabinet code	200086	200086	200086	200686	200686	200186	200186	200786	200786	200286	200286
	Cabinet width	500 mm	500 mm	500 mm	600 mm	600 mm	700 mm	700 mm	800 mm	800 mm	900 mm	1.000 mm

Manifold ways	2	3	4	5	6	7	8	9	10	11	12
1 1/4" manifolds kit width	300 mm	350 mm	400 mm	450 mm	500 mm	550 mm	600 mm	650 mm	700 mm	750 mm	800 mm
 AC 840	Cabinet code	200086	200086	200086	200686	200686	200186	200186	200786	200786	200286
	Cabinet width	500 mm	500 mm	500 mm	600 mm	600 mm	700 mm	700 mm	800 mm	800 mm	900 mm

EXAMPLES OF APPLICATION FOR BRASS ROD MANIFOLD ACCESSORIES



FLUXER®

Fluxer is the IVAR device for balancing and the display of flow rates on single circuits.

Glass panel replaceable even with system in operation
Isolation and position memory possible

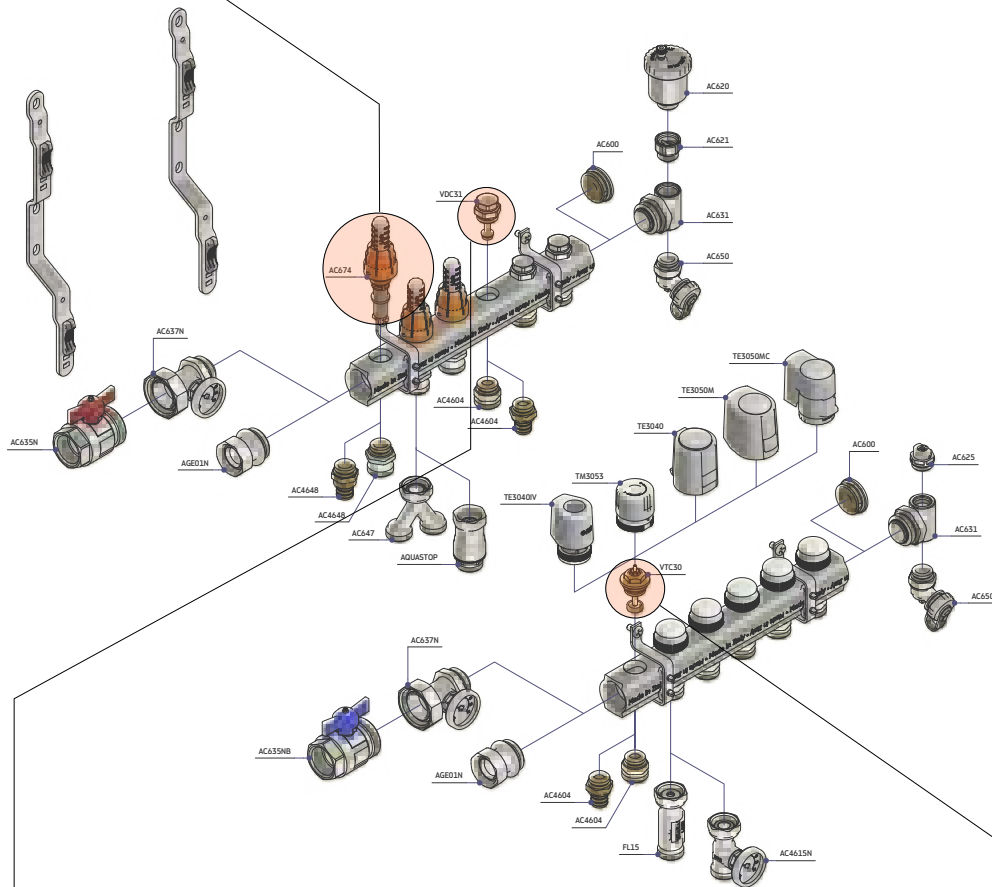

INSERT WITH THERMOSTATIC CONTROL OPTION

The manifolds with thermostat control option are supplied with a control knob to protect the thread and possible isolation of the bypass circuit.



LOCKSHIELD

Used for the control and static balancing of circuits, equipped with a screw with micrometric thread for gradual opening of the shutter and position memory. The position memory enables shutoff of the circuit, leaving the grub screw position unchanged for subsequent re-opening.

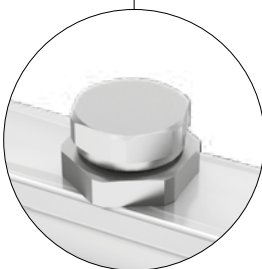

The control rod can also be replaced with the system in operation.

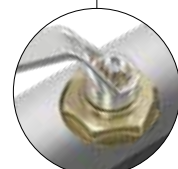

SINGLE MANIFOLD DIMENSIONS

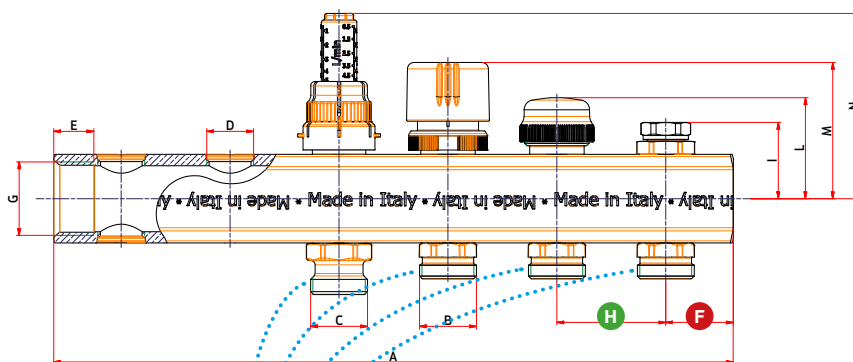

Centre-to-centre distance

$$A = (\text{WAYS} - 1) \times H + (2 \times F)$$

Distance between centreline of last way and end of manifold

Size	3/4"	1"	1"1/4
A	$(\text{WAYS} - 1) \times H + (2 \times F)$		
B	EUROK	EUROK	EUROK
C	EUROK	EUROK	EUROK
D	1/2" F	1/2" F	1/2" F
E	15 mm	18 mm	19 mm
F	26,5 mm	31 mm	32 mm
G	3/4"	1"	1"1/4
H	40 mm	50 mm	50 mm
I	-	36 mm	41 mm
L	-	46,5 mm	51,5 mm
M	-	66,5 mm	72 mm
N	-	88 mm	93,5 mm

CS 500 N

- Collettore semplice.
- Plain manifold.
- Collecteur simple.
- Verteilerbalken.
- Colector simple.

Code	Ways	Size	Color	Price	Class	Packaging
500032N	2	3/4" x 1/2" F	■	16,79 €	NA	45
500033N	3	3/4" x 1/2" F	■	22,94 €	NA	30
500034N	4	3/4" x 1/2" F	■	29,03 €	NA	30
500035N	5	3/4" x 1/2" F	■	35,27 €	NA	30
500036N	6	3/4" x 1/2" F	■	41,47 €	NA	20
500037N	7	3/4" x 1/2" F	■	47,65 €	NA	20
500038N	8	3/4" x 1/2" F	■	53,79 €	NA	20
500039N	9	3/4" x 1/2" F	■	59,92 €	NA	20
500040N	10	3/4" x 1/2" F	■	66,14 €	NA	20
500041N	11	3/4" x 1/2" F	■	72,33 €	NA	18
500042N	12	3/4" x 1/2" F	■	78,39 €	NA	18
501402N	2	1" x 1/2" F	■	19,37 €	NA	64
501403N	3	1" x 1/2" F	■	27,02 €	NA	40
501404N	4	1" x 1/2" F	■	34,60 €	NA	32
501405N	5	1" x 1/2" F	■	42,31 €	NA	25
501406N	6	1" x 1/2" F	■	49,90 €	NA	24
501407N	7	1" x 1/2" F	■	57,48 €	NA	15
501408N	8	1" x 1/2" F	■	65,22 €	NA	15
501409N	9	1" x 1/2" F	■	72,85 €	NA	15
501410N	10	1" x 1/2" F	■	80,54 €	NA	15
501411N	11	1" x 1/2" F	■	88,15 €	NA	15
501412N	12	1" x 1/2" F	■	95,74 €	NA	15
501413N	13	1" x 1/2" F	■	103,46 €	NA	15
500792N	2	1"1/4 x 1/2" F	■	28,43 €	NA	10
500793N	3	1"1/4 x 1/2" F	■	39,67 €	NA	10
500794N	4	1"1/4 x 1/2" F	■	50,91 €	NA	10
500795N	5	1"1/4 x 1/2" F	■	62,17 €	NA	8
500796N	6	1"1/4 x 1/2" F	■	73,40 €	NA	8
500797N	7	1"1/4 x 1/2" F	■	84,55 €	NA	10
500798N	8	1"1/4 x 1/2" F	■	95,89 €	NA	10
500799N	9	1"1/4 x 1/2" F	■	107,12 €	NA	8
500800N	10	1"1/4 x 1/2" F	■	118,38 €	NA	8
500801N	11	1"1/4 x 1/2" F	■	129,62 €	NA	8
500802N	12	1"1/4 x 1/2" F	■	140,81 €	NA	8
500803N	13	1"1/4 x 1/2" F	■	152,06 €	NA	8



- È possibile ordinare questo articolo in versione gialla utilizzando il medesimo codice, ma omettendo la "N" finale (prezzo su richiesta).
- It is possible to order this item in yellow version; please use the same reference code without the "N" at the end (price on request).
- Il est possible de commander cet article en version jaune en utilisant le même code, mais en omettant le "N" final (prix sur demande).
- Gelbe Ausführung verfügbar. Dieselbe o.g. Bestellnummer aber bitte „N“ am Ende weglassen (Preis auf Anfrage).
- Puede pedir este artículo en la versión amarilla con el mismo código, pero sin la „N“ al final (precio disponible bajo petición).

CS 501 N

- Collettore semplice con attacco supplementare per valvola di sfiato aria.
- Plain manifold with additional connection for air vent valve.
- Collecteur simple avec embout supplémentaire pour purgeur d'air.
- Verteilerbalken mit zusätzliche Bohrung für Entlüftungsventil.
- Colector de distribución con conexión adicional para válvula de purga del aire.

Code	Ways	Size	Color	Price	Class	Packaging
507002N	2	1" x 1/2" F	■	19,37 €	NA	64
507003N	3	1" x 1/2" F	■	27,02 €	NA	40
507004N	4	1" x 1/2" F	■	34,60 €	NA	32
507005N	5	1" x 1/2" F	■	42,31 €	NA	25
507006N	6	1" x 1/2" F	■	49,90 €	NA	22
507007N	7	1" x 1/2" F	■	57,48 €	NA	15
507008N	8	1" x 1/2" F	■	65,22 €	NA	15
507009N	9	1" x 1/2" F	■	72,85 €	NA	15
507010N	10	1" x 1/2" F	■	80,54 €	NA	15
507011N	11	1" x 1/2" F	■	88,15 €	NA	15
507012N	12	1" x 1/2" F	■	95,74 €	NA	15
507013N	13	1" x 1/2" F	■	103,46 €	NA	15
400362N	2	1"1/4 x 1/2" F	■	28,43 €	NA	12
400363N	3	1"1/4 x 1/2" F	■	39,67 €	NA	12
400364N	4	1"1/4 x 1/2" F	■	50,91 €	NA	10
400365N	5	1"1/4 x 1/2" F	■	62,17 €	NA	10
400366N	6	1"1/4 x 1/2" F	■	73,40 €	NA	10
400367N	7	1"1/4 x 1/2" F	■	84,55 €	NA	10
400368N	8	1"1/4 x 1/2" F	■	95,89 €	NA	10
400369N	9	1"1/4 x 1/2" F	■	107,12 €	NA	8
400370N	10	1"1/4 x 1/2" F	■	118,38 €	NA	8
400371N	11	1"1/4 x 1/2" F	■	129,62 €	NA	8
400372N	12	1"1/4 x 1/2" F	■	140,81 €	NA	8
400373N	13	1"1/4 x 1/2" F	■	152,06 €	NA	8



- È possibile ordinare questo articolo in versione gialla utilizzando il medesimo codice, ma omettendo la "N" finale (prezzo su richiesta).
- It is possible to order this item in yellow version; please use the same reference code without the "N" at the end (price on request).
- Il est possible de commander cet article en version jaune en utilisant le même code, mais en omettant le "N" final (prix sur demande).
- Gelbe Ausführung verfügbar. Dieselbe o.g. Bestellnummer aber bitte „N“ am Ende weglassen (Preis auf Anfrage).
- Puede pedir este artículo en la versión amarilla con el mismo código, pero sin la „N“ al final (precio disponible bajo petición).

CS 502 N

- Collettore semplice con attacchi EUROK.
- Plain manifold with EUROK connections.
- Collecteur simple avec embouts EUROK.
- Verteilerbalken mit EUROK Anschlussnippeln.
- Colector simple con conexiones EUROK.

Code	Ways	Size	Color	Price	Class	Packaging
400812N	2	3/4" x EUROK	■	22,94 €	NA	50
400813N	3	3/4" x EUROK	■	32,14 €	NA	38
400814N	4	3/4" x EUROK	■	41,30 €	NA	25
400815N	5	3/4" x EUROK	■	50,51 €	NA	22
400816N	6	3/4" x EUROK	■	59,73 €	NA	18
400817N	7	3/4" x EUROK	■	68,88 €	NA	16
400818N	8	3/4" x EUROK	■	78,09 €	NA	16
400819N	9	3/4" x EUROK	■	87,20 €	NA	14
400820N	10	3/4" x EUROK	■	96,40 €	NA	14
400392N	2	1" x EUROK	■	26,80 €	NA	35
400393N	3	1" x EUROK	■	38,04 €	NA	28
400394N	4	1" x EUROK	■	49,36 €	NA	20
400395N	5	1" x EUROK	■	60,58 €	NA	15
400396N	6	1" x EUROK	■	71,82 €	NA	15
400397N	7	1" x EUROK	■	83,01 €	NA	12
400398N	8	1" x EUROK	■	94,31 €	NA	12
400399N	9	1" x EUROK	■	105,55 €	NA	12
400400N	10	1" x EUROK	■	116,80 €	NA	12
400401N	11	1" x EUROK	■	128,10 €	NA	10
400402N	12	1" x EUROK	■	139,33 €	NA	10
400403N	13	1" x EUROK	■	150,57 €	NA	10
400432N	2	1"1/4 x EUROK	■	35,45 €	NA	10
400433N	3	1"1/4 x EUROK	■	50,09 €	NA	10
400434N	4	1"1/4 x EUROK	■	64,81 €	NA	10
400435N	5	1"1/4 x EUROK	■	79,42 €	NA	8
400436N	6	1"1/4 x EUROK	■	94,06 €	NA	6
400437N	7	1"1/4 x EUROK	■	108,65 €	NA	6
400438N	8	1"1/4 x EUROK	■	123,41 €	NA	6
400439N	9	1"1/4 x EUROK	■	138,07 €	NA	6
400440N	10	1"1/4 x EUROK	■	152,66 €	NA	6
400441N	11	1"1/4 x EUROK	■	167,36 €	NA	5
400442N	12	1"1/4 x EUROK	■	182,01 €	NA	5
400443N	13	1"1/4 x EUROK	■	196,73 €	NA	5



- È possibile ordinare questo articolo in versione gialla utilizzando il medesimo codice, ma omettendo la "N" finale (prezzo su richiesta).
- It is possible to order this item in yellow version; please use the same reference code without the "N" at the end (price on request).
- Il est possible de commander cet article en version jaune en utilisant le même code, mais en omettant le "N" final (prix sur demande).
- Gelbe Ausführung verfügbar. Dieselbe o.g. Bestellnummer aber bitte „N“ am Ende weglassen (Preis auf Anfrage).
- Puede pedir este artículo en la versión amarilla con el mismo código, pero sin la „N“ al final (precio disponible bajo petición).

CI 552 N

- Collettore di mandata con detentori a doppia regolazione micrometrica e attacchi EUROK.
- Flow manifold with micrometric dually adjusted lockshields and EUROK connections.
- Collecteur d'envoi avec inserts à double réglage micrométrique et embouts EUROK.
- Zulaufußbodenheizungsverteilerbalken mit doppelfeinvorein Stellbareausgleichoberteile und EUROK Anschließen.
- Colector de impulsión con detentores de doble regulación micrométrica y conexiones EUROK.

Code	Ways	Size	Color	Price	Class	Packaging
400042N	2	1" x EUROK	■	37,69 €	NC	12
400043N	3	1" x EUROK	■	54,38 €	NC	12
400044N	4	1" x EUROK	■	71,02 €	NC	8
400045N	5	1" x EUROK	■	87,70 €	NC	6
400046N	6	1" x EUROK	■	104,37 €	NC	6
400047N	7	1" x EUROK	■	121,06 €	NC	6
400048N	8	1" x EUROK	■	137,68 €	NC	6
400049N	9	1" x EUROK	■	154,40 €	NC	6
400050N	10	1" x EUROK	■	171,01 €	NC	6
400051N	11	1" x EUROK	■	187,73 €	NC	6
400052N	12	1" x EUROK	■	204,45 €	NC	6
400053N	13	1" x EUROK	■	221,06 €	NC	6
400082N	2	1"1/4 x EUROK	■	46,22 €	NC	12
400083N	3	1"1/4 x EUROK	■	66,42 €	NC	10
400084N	4	1"1/4 x EUROK	■	86,67 €	NC	8
400085N	5	1"1/4 x EUROK	■	106,92 €	NC	8
400086N	6	1"1/4 x EUROK	■	127,19 €	NC	6
400087N	7	1"1/4 x EUROK	■	147,37 €	NC	5
400088N	8	1"1/4 x EUROK	■	167,76 €	NC	5
400089N	9	1"1/4 x EUROK	■	187,92 €	NC	4
400090N	10	1"1/4 x EUROK	■	208,13 €	NC	4
400091N	11	1"1/4 x EUROK	■	228,49 €	NC	4
400092N	12	1"1/4 x EUROK	■	248,66 €	NC	4
400093N	13	1"1/4 x EUROK	■	268,86 €	NC	4



- È possibile ordinare questo articolo in versione gialla utilizzando il medesimo codice, ma omettendo la "N" finale (prezzo su richiesta).
- It is possible to order this item in yellow version; please use the same reference code without the "N" at the end (price on request).
- Il est possible de commander cet article en version jaune en utilisant le même code, mais en omettant le "N" final (prix sur demande).
- Gelbe Ausführung verfügbar. Dieselbe o.g. Bestellnummer aber bitte „N“ am Ende weglassen (Preis auf Anfrage).
- Puede pedir este artículo en la versión amarilla con el mismo código, pero sin la „N“ al final (precio disponible bajo petición).

CI 553 N

- Collettore di mandata con detentori a doppia regolazione micrometrica, attacchi EUROK, attacchi supplementari per valvola di sfioro aria e valvola di carico/scarico.
- Flow manifold with micrometric dually adjusted lockshields, EUROK connections, additional connections for air vent valve and filling/drainage valve.
- Collecteur d'envoi avec inserts à double réglage micrométrique, embouts EUROK, embouts supplémentaires pour purgeur d'air et robinet de remplissage/vidange.
- Zulauffussbodenheizungsverteilerbalken mit doppelfeinvorein Stellbareausgleichoberteile, EUROK Anschlüsse und zusätzliche Anschlüsse für Entlüftungsventil und Lade-/Entladeventil.
- Colector de impulsión con detentores de doble regulación micrométrica, conexiones EUROK, conexiones adicionales para válvula de purga del aire y válvula para la carga/descarga.

Code	Ways	Size	Color	Price	Class	Packaging
500962N	2	1" x EUROK	■	46,22 €	NC	12
500963N	3	1" x EUROK	■	62,83 €	NC	8
500964N	4	1" x EUROK	■	79,53 €	NC	6
500965N	5	1" x EUROK	■	96,15 €	NC	6
500966N	6	1" x EUROK	■	112,85 €	NC	6
500967N	7	1" x EUROK	■	129,58 €	NC	6
500968N	8	1" x EUROK	■	146,19 €	NC	6
500969N	9	1" x EUROK	■	162,90 €	NC	6
500970N	10	1" x EUROK	■	179,51 €	NC	6
500971N	11	1" x EUROK	■	196,22 €	NC	6
500972N	12	1" x EUROK	■	212,95 €	NC	6
400002N	2	1"1/4 x EUROK	■	58,05 €	NC	10
400003N	3	1"1/4 x EUROK	■	78,28 €	NC	8
400004N	4	1"1/4 x EUROK	■	98,58 €	NC	8
400005N	5	1"1/4 x EUROK	■	118,80 €	NC	6
400006N	6	1"1/4 x EUROK	■	139,06 €	NC	5
400007N	7	1"1/4 x EUROK	■	159,30 €	NC	5
400008N	8	1"1/4 x EUROK	■	179,51 €	NC	4
400009N	9	1"1/4 x EUROK	■	199,77 €	NC	4
400010N	10	1"1/4 x EUROK	■	220,04 €	NC	4
400011N	11	1"1/4 x EUROK	■	240,34 €	NC	4
400012N	12	1"1/4 x EUROK	■	260,50 €	NC	4



- È possibile ordinare questo articolo in versione gialla utilizzando il medesimo codice, ma omettendo la "N" finale (prezzo su richiesta).
- It is possible to order this item in yellow version; please use the same reference code without the "N" at the end (price on request).
- Il est possible de commander cet article en version jaune en utilisant le même code, mais en omettant le "N" final (prix sur demande).
- Gelbe Ausführung verfügbar. Dieselbe o.g. Bestellnummer aber bitte „N“ am Ende weglassen (Preis auf Anfrage).
- Puede pedir este artículo en la versión amarilla con el mismo código, pero sin la „N“ al final (precio disponible bajo petición).

CI 600 N



- Collettore di mandata con misuratore/regolatore portata FLUXER (0-5 l/min) e attacchi EUROK.
- Flow manifold with flow meter/adjuster FLUXER (0-5 l/min) and EUROK connections.
- Collecteur d'envoi avec débit-mètre/régulateur FLUXER (0-5 l/min) et embouts EUROK.
- Vorlaufverteiler mit Durchflussmengenmesser FLUXER (0-5 l/min) und EUROK Anschlüssen.
- Colector de impulsión medidor/regulador de caudal FLUXER (0-5 l/min) y conexiones EUROK.



0-2,5 l/min ON REQUEST

Code	Ways	Size	Color	Price	Class	Packaging
502372N	2	1" x EUROK	■	66,42 €	NE	12
502373N	3	1" x EUROK	■	97,97 €	NE	12
502374N	4	1" x EUROK	■	129,10 €	NE	8
502375N	5	1" x EUROK	■	160,46 €	NE	6
502376N	6	1" x EUROK	■	191,98 €	NE	6
502377N	7	1" x EUROK	■	223,34 €	NE	6
502378N	8	1" x EUROK	■	254,86 €	NE	6
502379N	9	1" x EUROK	■	286,64 €	NE	6
502380N	10	1" x EUROK	■	316,40 €	NE	6
502381N	11	1" x EUROK	■	349,71 €	NE	6
502382N	12	1" x EUROK	■	380,69 €	NE	6
502383N	13	1" x EUROK	■	414,86 €	NE	6
502392N	2	1"1/4 x EUROK	■	71,81 €	NE	8
502393N	3	1"1/4 x EUROK	■	105,12 €	NE	6
502394N	4	1"1/4 x EUROK	■	138,58 €	NE	5
502395N	5	1"1/4 x EUROK	■	171,95 €	NE	5
502396N	6	1"1/4 x EUROK	■	205,30 €	NE	5
502397N	7	1"1/4 x EUROK	■	238,74 €	NE	5
502398N	8	1"1/4 x EUROK	■	272,04 €	NE	5
502399N	9	1"1/4 x EUROK	■	305,38 €	NE	5
502400N	10	1"1/4 x EUROK	■	338,74 €	NE	5
502401N	11	1"1/4 x EUROK	■	372,14 €	NE	5
502402N	12	1"1/4 x EUROK	■	405,49 €	NE	5
502403N	13	1"1/4 x EUROK	■	438,93 €	NE	5



- È possibile ordinare questo articolo in versione gialla utilizzando il medesimo codice, ma omettendo la "N" finale (prezzo su richiesta).
- It is possible to order this item in yellow version; please use the same reference code without the "N" at the end (price on request).
- Il est possible de commander cet article en version jaune en utilisant le même code, mais en omettant le "N" final (prix sur demande).
- Gelbe Ausführung verfügbar. Dieselbe o.g. Bestellnummer aber bitte „N“ am Ende weglassen (Preis auf Anfrage).
- Puede pedir este artículo en la versión amarilla con el mismo código, pero sin la „N“ al final (precio disponible bajo petición).

CI 601 N

0-2,5 l/min ON REQUEST

- Collettore di mandata con misuratore/regolatore portata FLUXER (0-5 l/min), attacchi EUROK, attacchi supplementari per valvola di sfiato aria e valvola di carico/scarico.
- Flow manifold with flow meter/adjuster FLUXER (0-5 l/min), EUROK connections, additional connections for air vent valve and filling/drainage valve.
- Collecteur d'envoi avec débit-mètre/régulateur FLUXER (0-5 l/min), embouts EUROK, embouts supplémentaires pour purgeur d'air et robinet de remplissage/vidange.
- Vorlaufverteiler mit Durchflussmengenmesser FLUXER (0-5 l/min), EUROK Anschlüssen und zusätzliche Anschlüsse für Entlüftungsventil und Lade-/Entladeventil.
- Colector de impulsión medidor/regulador de caudal FLUXER (0-5 l/min), conexiones EUROK, conexiones adicionales para válvula de purga del aire y válvula para la carga/descarga.

Code	Ways	Size	Color	Price	Class	Packaging
502082N	2	1" x EUROK	■	73,92 €	NE	12
502083N	3	1" x EUROK	■	105,47 €	NE	8
502084N	4	1" x EUROK	■	136,62 €	NE	6
502085N	5	1" x EUROK	■	168,00 €	NE	6
502086N	6	1" x EUROK	■	199,48 €	NE	6
502087N	7	1" x EUROK	■	230,85 €	NE	6
502088N	8	1" x EUROK	■	262,36 €	NE	6
502089N	9	1" x EUROK	■	294,20 €	NE	6
502090N	10	1" x EUROK	■	323,91 €	NE	6
502091N	11	1" x EUROK	■	357,27 €	NE	6
502092N	12	1" x EUROK	■	388,25 €	NE	6
502182N	2	1"1/4 x EUROK	■	82,67 €	NE	6
502183N	3	1"1/4 x EUROK	■	116,02 €	NE	6
502184N	4	1"1/4 x EUROK	■	149,47 €	NE	5
502185N	5	1"1/4 x EUROK	■	182,85 €	NE	5
502186N	6	1"1/4 x EUROK	■	216,16 €	NE	5
502187N	7	1"1/4 x EUROK	■	249,61 €	NE	5
502188N	8	1"1/4 x EUROK	■	282,94 €	NE	5
502189N	9	1"1/4 x EUROK	■	316,30 €	NE	5
502190N	10	1"1/4 x EUROK	■	349,64 €	NE	5
502191N	11	1"1/4 x EUROK	■	383,01 €	NE	5
502192N	12	1"1/4 x EUROK	■	416,36 €	NE	5



- È possibile ordinare questo articolo in versione gialla utilizzando il medesimo codice, ma omettendo la "N" finale (prezzo su richiesta).
- It is possible to order this item in yellow version; please use the same reference code without the "N" at the end (price on request).
- Il est possible de commander cet article en version jaune en utilisant le même code, mais en omettant le "N" final (prix sur demande).
- Gelbe Ausführung verfügbar. Dieselbe o.g. Bestellnummer aber bitte „N“ am Ende weglassen (Preis auf Anfrage).
- Puede pedir este artículo en la versión amarilla con el mismo código, pero sin la „N“ al final (precio disponible bajo petición).

CI 554 CN



- Collettore di ritorno con valvole di intercettazione con cappuccio di protezione per vite termostattabile e attacchi EUROK.
- Return manifold with isolation valves with protection cap for thermostatic insert and EUROK connections.
- Collecteur de retour avec vannes d'interception avec capuchon de protection pour insert thermostatisable et embouts EUROK.
- Rücklauf-fussbodenheizungsverteilerbalken mit Absperbarenventilen mit Schutzkappe für Thermostat-Reguliovorrichtung und EUROK Anschlüsse.
- Colector de retorno con válvulas de cierre con tapa de protección para tornillo termostaticable y conexiones EUROK.

Code	Ways	Size	Color	Price	Class	Packaging
501650CN	2	1" x EUROK	■	42,89 €	NC	12
501651CN	3	1" x EUROK	■	62,29 €	NC	12
501652CN	4	1" x EUROK	■	81,67 €	NC	8
501653CN	5	1" x EUROK	■	101,01 €	NC	6
501654CN	6	1" x EUROK	■	120,39 €	NC	6
501655CN	7	1" x EUROK	■	139,78 €	NC	6
501656CN	8	1" x EUROK	■	159,09 €	NC	6
501657CN	9	1" x EUROK	■	178,45 €	NC	6
501658CN	10	1" x EUROK	■	197,83 €	NC	6
501659CN	11	1" x EUROK	■	217,20 €	NC	6
501660CN	12	1" x EUROK	■	236,54 €	NC	6
501661CN	13	1" x EUROK	■	255,93 €	NC	6
400122CN	2	1"1/4 x EUROK	■	52,47 €	NC	12
400123CN	3	1"1/4 x EUROK	■	75,95 €	NC	10
400124CN	4	1"1/4 x EUROK	■	99,61 €	NC	8
400125CN	5	1"1/4 x EUROK	■	123,11 €	NC	8
400126CN	6	1"1/4 x EUROK	■	146,67 €	NC	6
400127CN	7	1"1/4 x EUROK	■	170,13 €	NC	5
400128CN	8	1"1/4 x EUROK	■	193,76 €	NC	5
400129CN	9	1"1/4 x EUROK	■	217,20 €	NC	4
400130CN	10	1"1/4 x EUROK	■	240,78 €	NC	4
400131CN	11	1"1/4 x EUROK	■	264,34 €	NC	4
400132CN	12	1"1/4 x EUROK	■	287,87 €	NC	4
400133CN	13	1"1/4 x EUROK	■	311,37 €	NC	4



- È possibile ordinare questo articolo in versione gialla utilizzando il medesimo codice, ma omettendo la "N" finale (prezzo su richiesta).
- It is possible to order this item in yellow version; please use the same reference code without the "N" at the end (price on request).
- Il est possible de commander cet article en version jaune en utilisant le même code, mais en omettant le "N" final (prix sur demande).
- Gelbe Ausführung verfügbar. Dieselbe o.g. Bestellnummer aber bitte „N“ am Ende weglassen (Preis auf Anfrage).
- Puede pedir este artículo en la versión amarilla con el mismo código, pero sin la „N“ al final (precio disponible bajo petición).

CI 555 CN

- Collettore di ritorno con valvole di intercettazione con cappuccio di protezione per vitone termostattizzabile, attacchi EUROK, attacchi supplementari per valvola di sfiato aria e valvola di carico/scarico.
- Return manifold with isolation valves with protection cap for thermostatic insert, EUROK connections, additional connections for air vent valve and filling/drainage valve.
- Collecteur de retour avec vannes d'interception avec capuchon de protection pour insert thermostatisable, embouts EUROK, embouts supplémentaires pour purgeur d'air et robinet de remplissage/vidange.
- Rücklauf-fussbodenheizungsverteilerbalken mit Absperbarentilfen mit Schutzkappe für Thermostat-Reguliervorrichtung, EUROK Anschlüssen und zusätzliche Anschlüsse für Entlüftungsventil und Lade-/Entladeventil.
- Colector de retorno con válvulas de cierre con tapa de protección para tornillo termostaticable, conexiones EUROK, conexiones adicionales para válvula de purga del aire y válvula para la carga/descarga.

Code	Ways	Size	Color	Price	Class	Packaging
500462CN	2	1" x EUROK	■	53,54 €	NC	12
500463CN	3	1" x EUROK	■	73,83 €	NC	8
500464CN	4	1" x EUROK	■	94,19 €	NC	6
500465CN	5	1" x EUROK	■	114,56 €	NC	6
500466CN	6	1" x EUROK	■	134,97 €	NC	6
500467CN	7	1" x EUROK	■	155,27 €	NC	6
500468CN	8	1" x EUROK	■	175,53 €	NC	6
500469CN	9	1" x EUROK	■	195,89 €	NC	6
500470CN	10	1" x EUROK	■	216,20 €	NC	6
500471CN	11	1" x EUROK	■	236,54 €	NC	6
500472CN	12	1" x EUROK	■	256,80 €	NC	6
400022CN	2	1"1/4 x EUROK	■	63,78 €	NC	1
400023CN	3	1"1/4 x EUROK	■	87,25 €	NC	1
400024CN	4	1"1/4 x EUROK	■	110,91 €	NC	1
400025CN	5	1"1/4 x EUROK	■	134,39 €	NC	1
400026CN	6	1"1/4 x EUROK	■	158,00 €	NC	1
400027CN	7	1"1/4 x EUROK	■	181,47 €	NC	1
400028CN	8	1"1/4 x EUROK	■	205,02 €	NC	5
400029CN	9	1"1/4 x EUROK	■	228,53 €	NC	8
400030CN	10	1"1/4 x EUROK	■	252,11 €	NC	8
400031CN	11	1"1/4 x EUROK	■	275,65 €	NC	8
400032CN	12	1"1/4 x EUROK	■	299,18 €	NC	8



- È possibile ordinare questo articolo in versione gialla utilizzando il medesimo codice, ma omettendo la "N" finale (prezzo su richiesta).
- It is possible to order this item in yellow version; please use the same reference code without the "N" at the end (price on request).
- Il est possible de commander cet article en version jaune en utilisant le même code, mais en omettant le "N" final (prix sur demande).
- Gelbe Ausführung verfügbar. Dieselbe o.g. Bestellnummer aber bitte „N“ am Ende weglassen (Preis auf Anfrage).
- Puede pedir este artículo en la versión amarilla con el mismo código, pero sin la „N“ al final (precio disponible bajo petición).

CI 554 MN



- Collettore di ritorno con valvole di intercettazione a manovra manuale e attacchi EUROK.
- Return manifold with manually operated isolation valves and EUROK connections.
- Collecteur de retour avec vannes d'interception à manoeuvre manuelle et embouts EUROK.
- Rücklauf-fussbodenheizungsverteilerbalken mit Absperbarenventilen mit manueller Hebel und EUROK Anschlüssen.
- Colector de retorno con válvulas de cierre con cabeza manual y conexiones EUROK.

Code	Ways	Size	Color	Price	Class	Packaging
501650MN	2	1" x EUROK	■	44,45 €	NC	12
501651MN	3	1" x EUROK	■	64,66 €	NC	12
501652MN	4	1" x EUROK	■	84,80 €	NC	8
501653MN	5	1" x EUROK	■	104,89 €	NC	6
501654MN	6	1" x EUROK	■	125,06 €	NC	6
501655MN	7	1" x EUROK	■	145,26 €	NC	6
501656MN	8	1" x EUROK	■	165,33 €	NC	6
501657MN	9	1" x EUROK	■	185,43 €	NC	6
501658MN	10	1" x EUROK	■	205,56 €	NC	6
501659MN	11	1" x EUROK	■	225,77 €	NC	6
501660MN	12	1" x EUROK	■	245,83 €	NC	6
501661MN	13	1" x EUROK	■	266,04 €	NC	6
400122MN	2	1"1/4 x EUROK	■	53,92 €	NC	10
400123MN	3	1"1/4 x EUROK	■	78,17 €	NC	8
400124MN	4	1"1/4 x EUROK	■	102,55 €	NC	8
400125MN	5	1"1/4 x EUROK	■	126,81 €	NC	6
400126MN	6	1"1/4 x EUROK	■	151,09 €	NC	6
400127MN	7	1"1/4 x EUROK	■	175,34 €	NC	5
400128MN	8	1"1/4 x EUROK	■	199,64 €	NC	5
400129MN	9	1"1/4 x EUROK	■	223,88 €	NC	5
400130MN	10	1"1/4 x EUROK	■	248,22 €	NC	5
400131MN	11	1"1/4 x EUROK	■	272,52 €	NC	5
400132MN	12	1"1/4 x EUROK	■	296,76 €	NC	5
400133MN	13	1"1/4 x EUROK	■	320,98 €	NC	5



- È possibile ordinare questo articolo in versione gialla utilizzando il medesimo codice, ma omettendo la "N" finale (prezzo su richiesta).
- It is possible to order this item in yellow version; please use the same reference code without the "N" at the end (price on request).
- Il est possible de commander cet article en version jaune en utilisant le même code, mais en omettant le "N" final (prix sur demande).
- Gelbe Ausführung verfügbar. Dieselbe o.g. Bestellnummer aber bitte „N“ am Ende weglassen (Preis auf Anfrage).
- Puede pedir este artículo en la versión amarilla con el mismo código, pero sin la „N“ al final (precio disponible bajo petición).

CI 555 MN

- Collettore di ritorno con valvole di intercettazione a manovra manuale, attacchi EUROK, attacchi supplementari per valvola di sfiato aria e valvola di carico/scarico.
- Return manifold with manually operated isolation valves, EUROK connections, additional connections for air vent valve and filling/drainage valve.
- Collecteur de retour avec vannes d'interception à manoeuvre manuelle, embouts EUROK, embouts supplémentaires pour purgeur d'air et robinet de remplissage/vidange.
- Rücklauf-fussbodenheizungsverteilerbalken mit Absperbareventilen mit manueller Hebel, EUROK Anschlüssen und zusätzliche Anschlüsse für Entlüftungsventil und Lade-/Entladeventil.
- Colector de retorno con válvulas de cierre con cabeza manual, conexiones EUROK, conexiones adicionales para válvula de purga del aire y válvula para la carga/descarga.

Code	Ways	Size	Color	Price	Class	Packaging
500462MN	2	1" x EUROK	■	52,51 €	NC	12
500463MN	3	1" x EUROK	■	72,73 €	NC	8
500464MN	4	1" x EUROK	■	92,85 €	NC	6
500465MN	5	1" x EUROK	■	113,00 €	NC	6
500466MN	6	1" x EUROK	■	133,13 €	NC	6
500467MN	7	1" x EUROK	■	153,34 €	NC	6
500468MN	8	1" x EUROK	■	173,40 €	NC	6
500469MN	9	1" x EUROK	■	193,50 €	NC	6
500470MN	10	1" x EUROK	■	213,67 €	NC	6
500471MN	11	1" x EUROK	■	233,89 €	NC	6
500472MN	12	1" x EUROK	■	253,93 €	NC	6
400022MN	2	1"1/4 x EUROK	■	65,26 €	NC	8
400023MN	3	1"1/4 x EUROK	■	89,48 €	NC	1
400024MN	4	1"1/4 x EUROK	■	113,87 €	NC	1
400025MN	5	1"1/4 x EUROK	■	138,12 €	NC	1
400026MN	6	1"1/4 x EUROK	■	162,40 €	NC	1
400027MN	7	1"1/4 x EUROK	■	186,66 €	NC	1
400028MN	8	1"1/4 x EUROK	■	210,96 €	NC	5
400029MN	9	1"1/4 x EUROK	■	235,20 €	NC	5
400030MN	10	1"1/4 x EUROK	■	259,54 €	NC	5
400031MN	11	1"1/4 x EUROK	■	283,82 €	NC	5
400032MN	12	1"1/4 x EUROK	■	308,08 €	NC	5



- È possibile ordinare questo articolo in versione gialla utilizzando il medesimo codice, ma omettendo la "N" finale (prezzo su richiesta).
- It is possible to order this item in yellow version; please use the same reference code without the "N" at the end (price on request).
- Il est possible de commander cet article en version jaune en utilisant le même code, mais en omettant le "N" final (prix sur demande).
- Gelbe Ausführung verfügbar. Dieselbe o.g. Bestellnummer aber bitte „N“ am Ende weglassen (Preis auf Anfrage).
- Puede pedir este artículo en la versión amarilla con el mismo código, pero sin la „N“ al final (precio disponible bajo petición).

CI 562 CN



- Kit composto da collettore di mandata con detentori a doppia regolazione micrometrica, collettore di ritorno con valvole di intercettazione con cappuccio di protezione per vitone termostattizzabile, staffe e attacchi EUROK.
- Kit made of flow manifold with double micrometric adjustment lockshields, return manifold with isolation valves with protection cap for thermostatic insert, brackets and EUROK connections.
- Kit composé d'un collecteur d'envoi avec inserts à double réglage micrométrique, un collecteur de retour avec des vannes d'interception avec capuchon de protection pour insert thermostatisable, étriers et embouts EUROK.
- Bausatz besteht aus Zulauffusverteiler mit doppelfeinvorein Stellbarenausgleichoberteile, Rücklaufverteiler mit Absperbareventilen mit Schutzkappe für Thermostat-Reguliovorrichtung, Haltebügel und EUROK Anschließen.
- Conjunto dotado de colector de impulsión con detentores de doble regulación micrométrica, colector de retorno con válvulas de cierre con tapa de protección para tornillo termostattizable, abrazaderas y conexiones EUROK.

Code	Ways	Size	Depth	Suitable Cabinet	Cabinet width	Color	Price	Class	Packaging
400242CNP80	2	1" x EUROK	80 mm	200086	500 mm	■	100,72 €	NC	1
400243CNP80	3	1" x EUROK	80 mm	200086	500 mm	■	136,78 €	NC	1
400244CNP80	4	1" x EUROK	80 mm	200086	500 mm	■	172,77 €	NC	1
400245CNP80	5	1" x EUROK	80 mm	200086	500 mm	■	208,67 €	NC	1
400246CNP80	6	1" x EUROK	80 mm	200086	500 mm	■	244,71 €	NC	1
400247CNP80	7	1" x EUROK	80 mm	200086	500 mm	■	280,71 €	NC	1
400248CNP80	8	1" x EUROK	80 mm	200086	500 mm	■	316,65 €	NC	1
400249CNP80	9	1" x EUROK	80 mm	200686	600 mm	■	352,71 €	NC	1
400250CNP80	10	1" x EUROK	80 mm	200686	600 mm	■	388,65 €	NC	1
400251CNP80	11	1" x EUROK	80 mm	200186	700 mm	■	424,71 €	NC	1
400252CNP80	12	1" x EUROK	80 mm	200186	700 mm	■	460,67 €	NC	1
400253CNP80	13	1" x EUROK	80 mm	200786	800 mm	■	496,76 €	NC	1
400242CN	2	1" x EUROK	110 mm	200086	500 mm	■	100,72 €	NC	1
400243CN	3	1" x EUROK	110 mm	200086	500 mm	■	136,78 €	NC	1
400244CN	4	1" x EUROK	110 mm	200086	500 mm	■	172,77 €	NC	1
400245CN	5	1" x EUROK	110 mm	200086	500 mm	■	208,67 €	NC	1
400246CN	6	1" x EUROK	110 mm	200086	500 mm	■	244,71 €	NC	1
400247CN	7	1" x EUROK	110 mm	200086	500 mm	■	280,71 €	NC	1
400248CN	8	1" x EUROK	110 mm	200086	500 mm	■	316,65 €	NC	1
400249CN	9	1" x EUROK	110 mm	200686	600 mm	■	352,71 €	NC	1
400250CN	10	1" x EUROK	110 mm	200686	600 mm	■	388,65 €	NC	1
400251CN	11	1" x EUROK	110 mm	200186	700 mm	■	424,71 €	NC	1
400252CN	12	1" x EUROK	110 mm	200186	700 mm	■	460,67 €	NC	1
400253CN	13	1" x EUROK	110 mm	200786	800 mm	■	496,76 €	NC	1
400282CN	2	1"1/4 x EUROK	110 mm	200086	500 mm	■	118,84 €	NC	1
400283CN	3	1"1/4 x EUROK	110 mm	200086	500 mm	■	162,56 €	NC	1
400284CN	4	1"1/4 x EUROK	110 mm	200086	500 mm	■	206,43 €	NC	1
400285CN	5	1"1/4 x EUROK	110 mm	200086	500 mm	■	250,15 €	NC	1
400286CN	6	1"1/4 x EUROK	110 mm	200086	500 mm	■	294,08 €	NC	1
400287CN	7	1"1/4 x EUROK	110 mm	200086	500 mm	■	337,73 €	NC	1
400288CN	8	1"1/4 x EUROK	110 mm	200086	500 mm	■	381,67 €	NC	1
400289CN	9	1"1/4 x EUROK	110 mm	200686	600 mm	■	425,35 €	NC	1
400290CN	10	1"1/4 x EUROK	110 mm	200686	600 mm	■	469,13 €	NC	1
400291CN	11	1"1/4 x EUROK	110 mm	200186	700 mm	■	512,99 €	NC	1
400292CN	12	1"1/4 x EUROK	110 mm	200186	700 mm	■	556,72 €	NC	1
400293CN	13	1"1/4 x EUROK	110 mm	200786	800 mm	■	600,44 €	NC	1



- Cassetta non inclusa >>p. 204,503
- Cabinet not included >>p. 204,503
- Cassetta pas inclus >>p. 204,503
- Kasten nicht enthalten >>p. 204,503
- Caja no incluida >>p. 204,503



- È possibile ordinare questo articolo in versione gialla utilizzando il medesimo codice, ma omettendo la "N" finale (prezzo su richiesta).
- It is possible to order this item in yellow version; please use the same reference code without the "N" at the end (price on request).
- Il est possible de commander cet article en version jaune en utilisant le même code, mais en omettant le "N" final (prix sur demande).
- Gelbe Ausführung verfügbar. Dieselbe o.g. Bestellnummer aber bitte „N“ am Ende weglassen (Preis auf Anfrage).
- Puede pedir este artículo en la versión amarilla con el mismo código, pero sin la „N“ al final (precio disponible bajo petición).

CI 594 CN

- Kit composto da collettore di mandata con detentori a doppia regolazione micrometrica, collettore di ritorno con valvole di intercettazione con cappuccio di protezione per vitone termostattabile, staffe, attacchi supplementari per valvole di carico/scarico e valvole di sfiato aria, attacchi EUROK.
- Kit made of flow manifold with double micrometric adjustment lockshields, return manifold with isolation valves with protection cap for thermostatic insert, brackets, additional connections for filling/drainage valves and air vent valves, EUROK connections.
- Kit composé d'un collecteur d'envoi avec inserts à double réglage micrométrique, un collecteur de retour avec des vannes d'interception avec capuchon de protection pour insert thermostatisable, étriers, embouts supplémentaires pour robinets de remplissage/vidange et purgeurs d'air, embouts EUROK.
- Bausatz besteht aus Zulauffusverteiler mit doppelfeinvorein Stellbarenausgleichoberteile, Rücklaufverteiler mit Absperbarenventilen mit Schutzkappe für Thermostat-Regulievorrichtung, Haltebügel, zusätzliche Anschlüsse für Lade-/Entladeventile und Entlüftungsventile, EUROK Anschlüssen.
- Conjunto dotado de colector de impulsión con detentores de doble regulación micrométrica, colector de retorno con válvulas de cierre con tapa de protección para tornillo termostattizable, abrazaderas, conexiones adicionales para válvulas para la carga/descarga y válvulas de purga de aire, conexiones EUROK.

Code	Ways	Size	Depth	Suitable Cabinet	Cabinet width	Color	Price	Class	Packaging
500922CNP80	2	1" x EUROK	80 mm	200086	500 mm	■	116,89 €	NC	1
500923CNP80	3	1" x EUROK	80 mm	200086	500 mm	■	152,93 €	NC	1
500924CNP80	4	1" x EUROK	80 mm	200086	500 mm	■	188,94 €	NC	1
500925CNP80	5	1" x EUROK	80 mm	200086	500 mm	■	224,84 €	NC	1
500926CNP80	6	1" x EUROK	80 mm	200086	500 mm	■	260,84 €	NC	1
500927CNP80	7	1" x EUROK	80 mm	200086	500 mm	■	296,91 €	NC	1
500928CNP80	8	1" x EUROK	80 mm	200086	500 mm	■	332,85 €	NC	1
500929CNP80	9	1" x EUROK	80 mm	200686	600 mm	■	368,90 €	NC	1
500930CNP80	10	1" x EUROK	80 mm	200686	600 mm	■	404,85 €	NC	1
500931CNP80	11	1" x EUROK	80 mm	200186	700 mm	■	440,85 €	NC	1
500932CNP80	12	1" x EUROK	80 mm	200186	700 mm	■	476,79 €	NC	1
500922CN	2	1" x EUROK	110 mm	200086	500 mm	■	116,89 €	NC	1
500923CN	3	1" x EUROK	110 mm	200086	500 mm	■	152,93 €	NC	1
500924CN	4	1" x EUROK	110 mm	200086	500 mm	■	188,94 €	NC	1
500925CN	5	1" x EUROK	110 mm	200086	500 mm	■	224,84 €	NC	1
500926CN	6	1" x EUROK	110 mm	200086	500 mm	■	260,84 €	NC	1
500927CN	7	1" x EUROK	110 mm	200086	500 mm	■	296,91 €	NC	1
500928CN	8	1" x EUROK	110 mm	200086	500 mm	■	332,85 €	NC	1
500929CN	9	1" x EUROK	110 mm	200686	600 mm	■	368,90 €	NC	1
500930CN	10	1" x EUROK	110 mm	200686	600 mm	■	404,85 €	NC	1
500931CN	11	1" x EUROK	110 mm	200186	700 mm	■	440,85 €	NC	1
500932CN	12	1" x EUROK	110 mm	200186	700 mm	■	476,79 €	NC	1
400342CN	2	1"1/4 x EUROK	110 mm	200086	500 mm	■	141,46 €	NC	1
400343CN	3	1"1/4 x EUROK	110 mm	200086	500 mm	■	185,20 €	NC	1
400344CN	4	1"1/4 x EUROK	110 mm	200086	500 mm	■	229,07 €	NC	1
400345CN	5	1"1/4 x EUROK	110 mm	200086	500 mm	■	272,79 €	NC	1
400346CN	6	1"1/4 x EUROK	110 mm	200086	500 mm	■	316,65 €	NC	1
400347CN	7	1"1/4 x EUROK	110 mm	200086	500 mm	■	360,38 €	NC	1
400348CN	8	1"1/4 x EUROK	110 mm	200086	500 mm	■	404,30 €	NC	1
400349CN	9	1"1/4 x EUROK	110 mm	200686	600 mm	■	447,99 €	NC	1
400350CN	10	1"1/4 x EUROK	110 mm	200686	600 mm	■	491,75 €	NC	1
400351CN	11	1"1/4 x EUROK	110 mm	200186	700 mm	■	535,60 €	NC	1
400352CN	12	1"1/4 x EUROK	110 mm	200186	700 mm	■	579,35 €	NC	1



- Cassetta non inclusa >>p. 204,503
- Cabinet not included >>p. 204,503
- Casette pas inclus >>p. 204,503
- Kasten nicht enthalten >>p. 204,503
- Caja no incluida >>p. 204,503



- È possibile ordinare questo articolo in versione gialla utilizzando il medesimo codice, ma omettendo la "N" finale (prezzo su richiesta).
- It is possible to order this item in yellow version; please use the same reference code without the "N" at the end (price on request).
- Il est possible de commander cet article en version jaune en utilisant le même code, mais en omettant le "N" final (prix sur demande).
- Gelbe Ausführung verfügbar. Dieselbe o.g. Bestellnummer aber bitte „N“ am Ende weglassen (Preis auf Anfrage).
- Puede pedir este artículo en la versión amarilla con el mismo código, pero sin la „N“ al final (precio disponible bajo petición).

CI 562 MN



- Kit composto da collettore di mandata con detentori a doppia regolazione micrometrica, collettore di ritorno con valvole di intercettazione a manovra manuale, staffe e attacchi EUROK.
- Kit made of flow manifold with double micrometric adjustment lockshields, return manifold with manually operated isolation valves, brackets and EUROK connections.
- Kit composé d'un collecteur d'envoi avec inserts à double réglage micrométrique, un collecteur de retour avec des vannes d'interception à manoeuvre manuelle, étriers et embouts EUROK.
- Bausatz besteht aus Zulaufverteiler mit doppelfeinvorein Stellbarenausgleicherteile, Rücklaufverteiler mit Absperbarenventilen mit manueller Hebel, Haltebügel und EUROK Anschlüssen.
- Conjunto dotado de colector de impulsión con detentores de doble regulación micrométrica, colector de retorno con válvulas de cierre con cabeza manual, abrazaderas y conexiones EUROK.

Code	Ways	Size	Depth	Suitable Cabinet	Cabinet width	Color	Price	Class	Packaging
400242MNP80	2	1" x EUROK	80 mm	200086	500 mm	■	102,27 €	NC	1
400243MNP80	3	1" x EUROK	80 mm	200086	500 mm	■	139,06 €	NC	1
400244MNP80	4	1" x EUROK	80 mm	200086	500 mm	■	175,86 €	NC	1
400245MNP80	5	1" x EUROK	80 mm	200086	500 mm	■	212,60 €	NC	1
400246MNP80	6	1" x EUROK	80 mm	200086	500 mm	■	249,41 €	NC	1
400247MNP80	7	1" x EUROK	80 mm	200086	500 mm	■	286,20 €	NC	1
400248MNP80	8	1" x EUROK	80 mm	200086	500 mm	■	322,93 €	NC	1
400249MNP80	9	1" x EUROK	80 mm	200686	600 mm	■	359,71 €	NC	1
400250MNP80	10	1" x EUROK	80 mm	200686	600 mm	■	396,39 €	NC	1
400251MNP80	11	1" x EUROK	80 mm	200186	700 mm	■	433,25 €	NC	1
400252MNP80	12	1" x EUROK	80 mm	200186	700 mm	■	470,00 €	NC	1
400253MNP80	13	1" x EUROK	80 mm	200786	800 mm	■	506,82 €	NC	1
400242MN	2	1" x EUROK	110 mm	200086	500 mm	■	102,27 €	NC	1
400243MN	3	1" x EUROK	110 mm	200086	500 mm	■	139,06 €	NC	1
400244MN	4	1" x EUROK	110 mm	200086	500 mm	■	175,86 €	NC	1
400245MN	5	1" x EUROK	110 mm	200086	500 mm	■	212,60 €	NC	1
400246MN	6	1" x EUROK	110 mm	200086	500 mm	■	249,41 €	NC	1
400247MN	7	1" x EUROK	110 mm	200086	500 mm	■	286,20 €	NC	1
400248MN	8	1" x EUROK	110 mm	200086	500 mm	■	322,93 €	NC	1
400249MN	9	1" x EUROK	110 mm	200686	600 mm	■	359,71 €	NC	1
400250MN	10	1" x EUROK	110 mm	200686	600 mm	■	396,39 €	NC	1
400251MN	11	1" x EUROK	110 mm	200186	700 mm	■	433,25 €	NC	1
400252MN	12	1" x EUROK	110 mm	200186	700 mm	■	470,00 €	NC	1
400253MN	13	1" x EUROK	110 mm	200786	800 mm	■	506,82 €	NC	1
400282MN	2	1"1/4 x EUROK	110 mm	200086	500 mm	■	120,35 €	NC	1
400283MN	3	1"1/4 x EUROK	110 mm	200086	500 mm	■	164,78 €	NC	1
400284MN	4	1"1/4 x EUROK	110 mm	200086	500 mm	■	209,39 €	NC	1
400285MN	5	1"1/4 x EUROK	110 mm	200086	500 mm	■	253,87 €	NC	1
400286MN	6	1"1/4 x EUROK	110 mm	200086	500 mm	■	298,49 €	NC	1
400287MN	7	1"1/4 x EUROK	110 mm	200086	500 mm	■	342,94 €	NC	1
400288MN	8	1"1/4 x EUROK	110 mm	200086	500 mm	■	387,61 €	NC	1
400289MN	9	1"1/4 x EUROK	110 mm	200686	600 mm	■	432,04 €	NC	1
400290MN	10	1"1/4 x EUROK	110 mm	200686	600 mm	■	476,54 €	NC	1
400291MN	11	1"1/4 x EUROK	110 mm	200186	700 mm	■	521,11 €	NC	1
400292MN	12	1"1/4 x EUROK	110 mm	200186	700 mm	■	565,62 €	NC	1
400293MN	13	1"1/4 x EUROK	110 mm	200786	800 mm	■	610,06 €	NC	1



- Cassetta non inclusa >>p. 204,503
- Cabinet not included >>p. 204,503
- Cassetta pas inclus >>p. 204,503
- Kasten nicht enthalten >>p. 204,503
- Caja no incluida >>p. 204,503



- È possibile ordinare questo articolo in versione gialla utilizzando il medesimo codice, ma omettendo la "N" finale (prezzo su richiesta).
- It is possible to order this item in yellow version; please use the same reference code without the "N" at the end (price on request).
- Il est possible de commander cet article en version jaune en utilisant le même code, mais en omettant le "N" final (prix sur demande).
- Gelbe Ausführung verfügbar. Dieselbe o.g. Bestellnummer aber bitte „N“ am Ende weglassen (Preis auf Anfrage).
- Puede pedir este artículo en la versión amarilla con el mismo código, pero sin la „N“ al final (precio disponible bajo petición).

CI 594 MN

- **Kit composto da collettore di mandata con detentori a doppia regolazione micrometrica, collettore di ritorno con valvole di intercettazione a manovra manuale, staffe, attacchi supplementari per valvole di carico/scarico e valvole di sfiato aria, attacchi EUROK.**
- *Kit made of flow manifold with double micrometric adjustment lockshields, return manifold with manually operated isolation valves, brackets, additional connections for filling/drainage valves and air vent valves, EUROK connections.*
- **Kit composé d'un collecteur d'envoi avec inserts à double réglage micrométrique, un collecteur de retour avec des vannes d'interception à manoeuvre manuelle, étriers, embouts supplémentaires pour robinets de remplissage/vidange et purgeurs d'air, embouts EUROK.**
- *Bausatz besteht aus Zulaufverteiler mit doppelfeinvorein Stellbarenausgleichoberteile, Rücklaufverteiler mit Absperbareventilen mit manueller Hebel, Haltebügel, zusätzliche Anschlüsse für Lade-/Entladeventile und Entlüftungsventile, EUROK Anschlüsse.*
- **Conjunto dotado de colector de impulsión con detentores de doble regulación micrométrica, colector de retorno con válvulas de cierre con cabeza manual, abrazaderas, conexiones adicionales para válvulas para la carga/descarga y válvulas de purga de aire, conexiones EUROK.**



Code	Ways	Size	Depth	Suitable Cabinet	Cabinet width	Color	Price	Class	Packaging
500922MNP80	2	1" x EUROK	80 mm	200086	500 mm	■	118,45 €	NC	1
500923MNP80	3	1" x EUROK	80 mm	200086	500 mm	■	155,22 €	NC	1
500924MNP80	4	1" x EUROK	80 mm	200086	500 mm	■	192,04 €	NC	1
500925MNP80	5	1" x EUROK	80 mm	200086	500 mm	■	228,73 €	NC	1
500926MNP80	6	1" x EUROK	80 mm	200086	500 mm	■	265,58 €	NC	1
500927MNP80	7	1" x EUROK	80 mm	200086	500 mm	■	302,33 €	NC	1
500928MNP80	8	1" x EUROK	80 mm	200086	500 mm	■	339,11 €	NC	1
500929MNP80	9	1" x EUROK	80 mm	200686	600 mm	■	375,89 €	NC	1
500930MNP80	10	1" x EUROK	80 mm	200686	600 mm	■	412,55 €	NC	1
500931MNP80	11	1" x EUROK	80 mm	200186	700 mm	■	449,41 €	NC	1
500932MNP80	12	1" x EUROK	80 mm	200186	700 mm	■	486,18 €	NC	1
500922MN	2	1" x EUROK	110 mm	200086	500 mm	■	118,45 €	NC	1
500923MN	3	1" x EUROK	110 mm	200086	500 mm	■	155,22 €	NC	1
500924MN	4	1" x EUROK	110 mm	200086	500 mm	■	192,04 €	NC	1
500925MN	5	1" x EUROK	110 mm	200086	500 mm	■	228,73 €	NC	1
500926MN	6	1" x EUROK	110 mm	200086	500 mm	■	265,58 €	NC	1
500927MN	7	1" x EUROK	110 mm	200086	500 mm	■	302,33 €	NC	1
500928MN	8	1" x EUROK	110 mm	200086	500 mm	■	339,11 €	NC	1
500929MN	9	1" x EUROK	110 mm	200686	600 mm	■	375,89 €	NC	1
500930MN	10	1" x EUROK	110 mm	200686	600 mm	■	412,55 €	NC	1
500931MN	11	1" x EUROK	110 mm	200186	700 mm	■	449,41 €	NC	1
500932MN	12	1" x EUROK	110 mm	200186	700 mm	■	486,18 €	NC	1
400342MN	2	1"1/4 x EUROK	110 mm	200086	500 mm	■	142,92 €	NC	1
400343MN	3	1"1/4 x EUROK	110 mm	200086	500 mm	■	187,39 €	NC	1
400344MN	4	1"1/4 x EUROK	110 mm	200086	500 mm	■	232,01 €	NC	1
400345MN	5	1"1/4 x EUROK	110 mm	200086	500 mm	■	276,49 €	NC	1
400346MN	6	1"1/4 x EUROK	110 mm	200086	500 mm	■	321,13 €	NC	1
400347MN	7	1"1/4 x EUROK	110 mm	200086	500 mm	■	365,60 €	NC	1
400348MN	8	1"1/4 x EUROK	110 mm	200086	500 mm	■	410,25 €	NC	1
400349MN	9	1"1/4 x EUROK	110 mm	200686	600 mm	■	454,64 €	NC	1
400350MN	10	1"1/4 x EUROK	110 mm	200686	600 mm	■	499,14 €	NC	1
400351MN	11	1"1/4 x EUROK	110 mm	200186	700 mm	■	543,73 €	NC	1
400352MN	12	1"1/4 x EUROK	110 mm	200186	700 mm	■	588,26 €	NC	1



- **Cassetta non inclusa >>p. 204,503**
- *Cabinet not included >>p. 204,503*
- **Cassette pas inclus >>p. 204,503**
- *Kasten nicht enthalten >>p. 204,503*
- **Caja no incluida >>p. 204,503**



- **È possibile ordinare questo articolo in versione gialla utilizzando il medesimo codice, ma omettendo la "N" finale (prezzo su richiesta).**
- *It is possible to order this item in yellow version; please use the same reference code without the "N" at the end (price on request).*
- **Il est possible de commander cet article en version jaune en utilisant le même code, mais en omettant le "N" final (prix sur demande).**
- *Gelbe Ausführung verfügbar. Dieselbe o.g. Bestellnummer aber bitte „N“ am Ende weglassen (Preis auf Anfrage).*
- **Puede pedir este artículo en la versión amarilla con el mismo código, pero sin la „N“ al final (precio disponible bajo petición).**

CI 595 CN



0-2.5 l/min ON REQUEST

- Kit composto da collettore di mandata con misuratori/regolatori di portata FLUXER (0-5 l/min), collettore di ritorno con valvole di intercettazione con cappuccio di protezione per vitone termostattizzabile, staffe e attacchi EUROK.
- Kit made of flow manifold with flow meters/adjusters FLUXER (0-5 l/min), return manifold with isolation valves with protection cap for thermostatic insert, brackets and EUROK connections.
- Kit composé d'un collecteur d'envoi avec débit-mètres/régulateurs FLUXER (0-5 l/min), un collecteur de retour avec des vannes d'interception avec capuchon de protection pour insert thermostatisable, étriers et embouts EUROK.
- Bausatz besteht aus Zulauffusverteiler mit Durchflussmengenmesser FLUXER (0-5 l/min), Rücklaufverteiler mit Absperbarentilen mit Schutzkappe für Thermostat-Regulivorrichtung, Haltebügel und EUROK Anschließen.
- Conjunto dotado de colector de impulsión con medidores/reguladores de caudal FLUXER (0-5 l/min), colector de retorno con válvulas de cierre con tapa de protección para tornillo termostatzable, abrazaderas y conexiones EUROK.

Code	Ways	Size	Depth	Suitable Cabinet	Cabinet width	Color	Price	Class	Packaging
500082CNP80	2	1" x EUROK	80 mm	200086	500 mm	■	125,33 €	NE	1
500083CNP80	3	1" x EUROK	80 mm	200086	500 mm	■	174,97 €	NE	1
500084CNP80	4	1" x EUROK	80 mm	200086	500 mm	■	224,15 €	NE	1
500085CNP80	5	1" x EUROK	80 mm	200086	500 mm	■	273,70 €	NE	1
500086CNP80	6	1" x EUROK	80 mm	200086	500 mm	■	323,25 €	NE	1
500087CNP80	7	1" x EUROK	80 mm	200086	500 mm	■	372,71 €	NE	1
500088CNP80	8	1" x EUROK	80 mm	200086	500 mm	■	422,26 €	NE	1
500089CNP80	9	1" x EUROK	80 mm	200686	600 mm	■	472,10 €	NE	1
500090CNP80	10	1" x EUROK	80 mm	200686	600 mm	■	519,94 €	NE	1
500091CNP80	11	1" x EUROK	80 mm	200186	700 mm	■	571,34 €	NE	1
500092CNP80	12	1" x EUROK	80 mm	200186	700 mm	■	620,39 €	NE	1
500093CNP80	13	1" x EUROK	80 mm	200786	800 mm	■	672,69 €	NE	1
500082CN	2	1" x EUROK	110 mm	200086	500 mm	■	125,33 €	NE	1
500083CN	3	1" x EUROK	110 mm	200086	500 mm	■	174,97 €	NE	1
500084CN	4	1" x EUROK	110 mm	200086	500 mm	■	224,15 €	NE	1
500085CN	5	1" x EUROK	110 mm	200086	500 mm	■	273,70 €	NE	1
500086CN	6	1" x EUROK	110 mm	200086	500 mm	■	323,25 €	NE	1
500087CN	7	1" x EUROK	110 mm	200086	500 mm	■	372,71 €	NE	1
500088CN	8	1" x EUROK	110 mm	200086	500 mm	■	422,26 €	NE	1
500089CN	9	1" x EUROK	110 mm	200686	600 mm	■	472,10 €	NE	1
500090CN	10	1" x EUROK	110 mm	200686	600 mm	■	519,94 €	NE	1
500091CN	11	1" x EUROK	110 mm	200186	700 mm	■	571,34 €	NE	1
500092CN	12	1" x EUROK	110 mm	200186	700 mm	■	620,39 €	NE	1
500093CN	13	1" x EUROK	110 mm	200786	800 mm	■	672,69 €	NE	1
502142CN	2	1"1/4 x EUROK	110 mm	200086	500 mm	■	139,69 €	NE	1
502143CN	3	1"1/4 x EUROK	110 mm	200086	500 mm	■	194,96 €	NE	1
502144CN	4	1"1/4 x EUROK	110 mm	200086	500 mm	■	250,41 €	NE	1
502145CN	5	1"1/4 x EUROK	110 mm	200086	500 mm	■	305,68 €	NE	1
502146CN	6	1"1/4 x EUROK	110 mm	200086	500 mm	■	361,08 €	NE	1
502147CN	7	1"1/4 x EUROK	110 mm	200086	500 mm	■	416,50 €	NE	1
502148CN	8	1"1/4 x EUROK	110 mm	200086	500 mm	■	471,81 €	NE	1
502149CN	9	1"1/4 x EUROK	110 mm	200686	600 mm	■	527,12 €	NE	1
502150CN	10	1"1/4 x EUROK	110 mm	200686	600 mm	■	582,40 €	NE	1
502151CN	11	1"1/4 x EUROK	110 mm	200186	700 mm	■	637,86 €	NE	1
502152CN	12	1"1/4 x EUROK	110 mm	200186	700 mm	■	693,12 €	NE	1
502153CN	13	1"1/4 x EUROK	110 mm	200786	800 mm	■	748,55 €	NE	1



- Cassetta non inclusa >>p. 204,503
- Cabinet not included >>p. 204,503
- Casette pas inclus >>p. 204,503
- Kasten nicht enthalten >>p. 204,503
- Caja no incluida >>p. 204,503



- È possibile ordinare questo articolo in versione gialla utilizzando il medesimo codice, ma omettendo la "N" finale (prezzo su richiesta).
- It is possible to order this item in yellow version; please use the same reference code without the "N" at the end (price on request).
- Il est possible de commander cet article en version jaune en utilisant le même code, mais en omettant le "N" final (prix sur demande).
- Gelbe Ausführung verfügbar. Dieselse o.g. Bestellnummer aber bitte „N“ am Ende weglassen (Preis auf Anfrage).
- Puede pedir este artículo en la versión amarilla con el mismo código, pero sin la „N“ al final (precio disponible bajo petición).

CI 596 CN

0-2,5 l/min ON REQUEST

- Kit composto da collettore di mandata con misuratori/regolatori di portata FLUXER (0-5 l/min), collettore di ritorno con valvole di intercettazione con cappuccio di protezione per vitone termostattabile, staffe, attacchi supplementari per valvole di carico/scarico e valvole di sfiato aria, attacchi EUROK.
- Kit made of flow manifold with flow meters/adjusters FLUXER (0-5 l/min), return manifold with isolation valves with protection cap for thermostatic insert, brackets, additional connections for filling/drainage valves and air vent valves, EUROK connections.
- Kit composé d'un collecteur d'envoi avec débit-mètres/régulateurs FLUXER (0-5 l/min), un collecteur de retour avec des vannes d'interception avec capuchon de protection pour insert thermostatisable, étriers, embouts supplémentaires pour robinets de remplissage/vidange et purgeurs d'air, embouts EUROK.
- Bausatz besteht aus Zulauffusverteiler mit Durchflussmengenmesser FLUXER (0-5 l/min), Rücklaufverteiler mit Absperbarentventilen mit Schutzkappe für Thermostat-Regulievorrichtung, Haltebügel, zusätzliche Anschlüsse für Lade-/Entladeventile und Entlüftungsventile, EUROK Anschlüsse.
- Conjunto dotado de colector de impulsión con medidores/reguladores de caudal FLUXER (0-5 l/min), colector de retorno con válvulas de cierre con tapa de protección para tornillo termostattizable, abrazaderas, conexiones adicionales para válvulas para la carga/descarga y válvulas de purga de aire, conexiones EUROK.

Code	Ways	Size	Depth	Suitable Cabinet	Cabinet width	Color	Price	Class	Packaging
502252CNP80	2	1" x EUROK	80 mm	200086	500 mm	■	146,44 €	NE	1
502253CNP80	3	1" x EUROK	80 mm	200086	500 mm	■	196,10 €	NE	1
502254CNP80	4	1" x EUROK	80 mm	200086	500 mm	■	245,27 €	NE	1
502255CNP80	5	1" x EUROK	80 mm	200086	500 mm	■	294,82 €	NE	1
502256CNP80	6	1" x EUROK	80 mm	200086	500 mm	■	344,37 €	NE	1
502257CNP80	7	1" x EUROK	80 mm	200086	500 mm	■	393,83 €	NE	1
502258CNP80	8	1" x EUROK	80 mm	200086	500 mm	■	443,37 €	NE	1
502259CNP80	9	1" x EUROK	80 mm	200686	600 mm	■	493,27 €	NE	1
502260CNP80	10	1" x EUROK	80 mm	200686	600 mm	■	541,09 €	NE	1
502261CNP80	11	1" x EUROK	80 mm	200186	700 mm	■	592,47 €	NE	1
502262CNP80	12	1" x EUROK	80 mm	200186	700 mm	■	641,48 €	NE	1
502252CN	2	1" x EUROK	110 mm	200086	500 mm	■	146,44 €	NE	1
502253CN	3	1" x EUROK	110 mm	200086	500 mm	■	196,10 €	NE	1
502254CN	4	1" x EUROK	110 mm	200086	500 mm	■	245,27 €	NE	1
502255CN	5	1" x EUROK	110 mm	200086	500 mm	■	294,82 €	NE	1
502256CN	6	1" x EUROK	110 mm	200086	500 mm	■	344,37 €	NE	1
502257CN	7	1" x EUROK	110 mm	200086	500 mm	■	393,83 €	NE	1
502258CN	8	1" x EUROK	110 mm	200086	500 mm	■	443,37 €	NE	1
502259CN	9	1" x EUROK	110 mm	200686	600 mm	■	493,27 €	NE	1
502260CN	10	1" x EUROK	110 mm	200686	600 mm	■	541,09 €	NE	1
502261CN	11	1" x EUROK	110 mm	200186	700 mm	■	592,47 €	NE	1
502262CN	12	1" x EUROK	110 mm	200186	700 mm	■	641,48 €	NE	1
502272CN	2	1"1/4 x EUROK	110 mm	200086	500 mm	■	160,86 €	NE	1
502273CN	3	1"1/4 x EUROK	110 mm	200086	500 mm	■	216,12 €	NE	1
502274CN	4	1"1/4 x EUROK	110 mm	200086	500 mm	■	271,56 €	NE	1
502275CN	5	1"1/4 x EUROK	110 mm	200086	500 mm	■	326,84 €	NE	1
502276CN	6	1"1/4 x EUROK	110 mm	200086	500 mm	■	382,21 €	NE	1
502277CN	7	1"1/4 x EUROK	110 mm	200086	500 mm	■	437,62 €	NE	1
502278CN	8	1"1/4 x EUROK	110 mm	200086	500 mm	■	492,93 €	NE	1
502279CN	9	1"1/4 x EUROK	110 mm	200686	600 mm	■	548,23 €	NE	1
502280CN	10	1"1/4 x EUROK	110 mm	200686	600 mm	■	603,50 €	NE	1
502281CN	11	1"1/4 x EUROK	110 mm	200186	700 mm	■	658,98 €	NE	1
502282CN	12	1"1/4 x EUROK	110 mm	200186	700 mm	■	714,25 €	NE	1



- Cassetta non inclusa >>p. 204,503
- Cabinet not included >>p. 204,503
- Casette pas inclus >>p. 204,503
- Kasten nicht enthalten >>p. 204,503
- Caja no incluida >>p. 204,503



- È possibile ordinare questo articolo in versione gialla utilizzando il medesimo codice, ma omettendo la "N" finale (prezzo su richiesta).
- It is possible to order this item in yellow version; please use the same reference code without the "N" at the end (price on request).
- Il est possible de commander cet article en version jaune en utilisant le même code, mais en omettant le "N" final (prix sur demande).
- Gelbe Ausführung verfügbar. Dieselbe o.g. Bestellnummer aber bitte „N“ am Ende weglassen (Preis auf Anfrage).
- Puede pedir este artículo en la versión amarilla con el mismo código, pero sin la „N“ al final (precio disponible bajo petición).

CI 595 MN



0-2,5 l/min ON REQUEST

- Kit composto da collettore di mandata con misuratori/regolatori di portata FLUXER (0-5 l/min), collettore di ritorno con valvole di intercettazione a manovra manuale, staffe e attacchi EUROK.
- Kit made of flow manifold with flow meters/adjusters FLUXER (0-5 l/min), return manifold with manually operated isolation valves, brackets and EUROK connections.
- Kit composé d'un collecteur d'envoi avec débit-mètres/régulateurs FLUXER (0-5 l/min), un collecteur de retour avec des vannes d'interception à manoeuvre manuelle, étriers et embouts EUROK.
- Bausatz besteht aus Zulaufverteiler mit Durchflussmengenmesser FLUXER (0-5 l/min), Rücklaufverteiler mit Absperbarentilen mit manueller Hebel, Haltebügel und EUROK Anschlüssen.
- Conjunto dotado de colector de impulsión con medidores/reguladores de caudal FLUXER (0-5 l/min), colector de retorno con válvulas de cierre con cabeza manual, abrazaderas y conexiones EUROK.

Code	Ways	Size	Depth	Suitable Cabinet	Cabinet width	Color	Price	Class	Packaging
500082MNP80	2	1" x EUROK	80 mm	200086	500 mm	■	126,75 €	NE	1
500083MNP80	3	1" x EUROK	80 mm	200086	500 mm	■	177,20 €	NE	1
500084MNP80	4	1" x EUROK	80 mm	200086	500 mm	■	227,13 €	NE	1
500085MNP80	5	1" x EUROK	80 mm	200086	500 mm	■	277,34 €	NE	1
500086MNP80	6	1" x EUROK	80 mm	200086	500 mm	■	327,65 €	NE	1
500087MNP80	7	1" x EUROK	80 mm	200086	500 mm	■	377,82 €	NE	1
500088MNP80	8	1" x EUROK	80 mm	200086	500 mm	■	428,03 €	NE	1
500089MNP80	9	1" x EUROK	80 mm	200686	600 mm	■	478,65 €	NE	1
500090MNP80	10	1" x EUROK	80 mm	200686	600 mm	■	527,18 €	NE	1
500091MNP80	11	1" x EUROK	80 mm	200186	700 mm	■	579,37 €	NE	1
500092MNP80	12	1" x EUROK	80 mm	200186	700 mm	■	629,10 €	NE	1
500093MNP80	13	1" x EUROK	80 mm	200786	800 mm	■	682,12 €	NE	1
500082MN	2	1" x EUROK	110 mm	200086	500 mm	■	126,75 €	NE	1
500083MN	3	1" x EUROK	110 mm	200086	500 mm	■	177,20 €	NE	1
500084MN	4	1" x EUROK	110 mm	200086	500 mm	■	227,13 €	NE	1
500085MN	5	1" x EUROK	110 mm	200086	500 mm	■	277,34 €	NE	1
500086MN	6	1" x EUROK	110 mm	200086	500 mm	■	327,65 €	NE	1
500087MN	7	1" x EUROK	110 mm	200086	500 mm	■	377,82 €	NE	1
500088MN	8	1" x EUROK	110 mm	200086	500 mm	■	428,03 €	NE	1
500089MN	9	1" x EUROK	110 mm	200686	600 mm	■	478,65 €	NE	1
500090MN	10	1" x EUROK	110 mm	200686	600 mm	■	527,18 €	NE	1
500091MN	11	1" x EUROK	110 mm	200186	700 mm	■	579,37 €	NE	1
500092MN	12	1" x EUROK	110 mm	200186	700 mm	■	629,10 €	NE	1
500093MN	13	1" x EUROK	110 mm	200786	800 mm	■	682,12 €	NE	1
502142MN	2	1"1/4 x EUROK	110 mm	200086	500 mm	■	141,11 €	NE	1
502143MN	3	1"1/4 x EUROK	110 mm	200086	500 mm	■	197,02 €	NE	1
502144MN	4	1"1/4 x EUROK	110 mm	200086	500 mm	■	253,19 €	NE	1
502145MN	5	1"1/4 x EUROK	110 mm	200086	500 mm	■	309,18 €	NE	1
502146MN	6	1"1/4 x EUROK	110 mm	200086	500 mm	■	365,25 €	NE	1
502147MN	7	1"1/4 x EUROK	110 mm	200086	500 mm	■	421,31 €	NE	1
502148MN	8	1"1/4 x EUROK	110 mm	200086	500 mm	■	477,33 €	NE	1
502149MN	9	1"1/4 x EUROK	110 mm	200686	600 mm	■	533,37 €	NE	1
502150MN	10	1"1/4 x EUROK	110 mm	200686	600 mm	■	589,30 €	NE	1
502151MN	11	1"1/4 x EUROK	110 mm	200186	700 mm	■	645,44 €	NE	1
502152MN	12	1"1/4 x EUROK	110 mm	200186	700 mm	■	701,44 €	NE	1
502153MN	13	1"1/4 x EUROK	110 mm	200786	800 mm	■	757,52 €	NE	1



- Cassetta non inclusa >>p. 204,503
- Cabinet not included >>p. 204,503
- Casette pas inclus >>p. 204,503
- Kasten nicht enthalten >>p. 204,503
- Caja no incluida >>p. 204,503



- È possibile ordinare questo articolo in versione gialla utilizzando il medesimo codice, ma omettendo la "N" finale (prezzo su richiesta).
- It is possible to order this item in yellow version; please use the same reference code without the "N" at the end (price on request).
- Il est possible de commander cet article en version jaune en utilisant le même code, mais en omettant le "N" final (prix sur demande).
- Gelbe Ausführung verfügbar. Dieselbe o.g. Bestellnummer aber bitte „N“ am Ende weglassen (Preis auf Anfrage).
- Puede pedir este artículo en la versión amarilla con el mismo código, pero sin la „N“ al final (precio disponible bajo petición).

CI 596 MN

0-2,5 l/min ON REQUEST

- Kit composto da collettore di mandata con misuratori/regolatori di portata FLUXER (0-5 l/min), collettore di ritorno con valvole di intercettazione a manovra manuale, staffe, attacchi supplementari per valvole di carico/scarico e valvole di sfiato aria, attacchi EUROK.
- Kit made of flow manifold with flow meters/adjusters FLUXER (0-5 l/min), return manifold with manually operated isolation valves, brackets, additional connections for filling/drainage valves and air vent valves, EUROK connections.
- Kit composé d'un collecteur d'envoi avec débit-mètres/régulateurs FLUXER (0-5 l/min), un collecteur de retour avec des vannes d'interception à manoeuvre manuelle, étriers, embouts supplémentaires pour robinets de remplissage/vidange et purgeurs d'air, embouts EUROK.
- Bausatz besteht aus Zulaufverteiler mit Durchflussmengenmesser FLUXER (0-5 l/min), Rücklaufverteiler mit Absperbareventilen mit manueller Hebel, Haltebügel, zusätzliche Anschlüsse für Lade-/Entladeventile und Entlüftungsventile, EUROK Anschlüssen.
- Conjunto dotado de colector de impulsión con medidores/reguladores de caudal FLUXER (0-5 l/min), colector de retorno con válvulas de cierre con cabeza manual, abrazaderas, conexiones adicionales para válvulas para la carga/descarga y válvulas de purga de aire, conexiones EUROK.

Code	Ways	Size	Depth	Suitable Cabinet	Cabinet width	Color	Price	Class	Packaging
502252MNP80	2	1" x EUROK	80 mm	200086	500 mm	■	147,91 €	NE	1
502253MNP80	3	1" x EUROK	80 mm	200086	500 mm	■	198,32 €	NE	1
502254MNP80	4	1" x EUROK	80 mm	200086	500 mm	■	248,23 €	NE	1
502255MNP80	5	1" x EUROK	80 mm	200086	500 mm	■	298,43 €	NE	1
502256MNP80	6	1" x EUROK	80 mm	200086	500 mm	■	348,76 €	NE	1
502257MNP80	7	1" x EUROK	80 mm	200086	500 mm	■	398,92 €	NE	1
502258MNP80	8	1" x EUROK	80 mm	200086	500 mm	■	449,19 €	NE	1
502259MNP80	9	1" x EUROK	80 mm	200686	600 mm	■	499,77 €	NE	1
502260MNP80	10	1" x EUROK	80 mm	200686	600 mm	■	548,36 €	NE	1
502261MNP80	11	1" x EUROK	80 mm	200186	700 mm	■	600,48 €	NE	1
502262MNP80	12	1" x EUROK	80 mm	200186	700 mm	■	650,22 €	NE	1
502252MN	2	1" x EUROK	110 mm	200086	500 mm	■	147,91 €	NE	1
502253MN	3	1" x EUROK	110 mm	200086	500 mm	■	198,32 €	NE	1
502254MN	4	1" x EUROK	110 mm	200086	500 mm	■	248,23 €	NE	1
502255MN	5	1" x EUROK	110 mm	200086	500 mm	■	298,43 €	NE	1
502256MN	6	1" x EUROK	110 mm	200086	500 mm	■	348,76 €	NE	1
502257MN	7	1" x EUROK	110 mm	200086	500 mm	■	398,92 €	NE	1
502258MN	8	1" x EUROK	110 mm	200086	500 mm	■	449,19 €	NE	1
502259MN	9	1" x EUROK	110 mm	200686	600 mm	■	499,77 €	NE	1
502260MN	10	1" x EUROK	110 mm	200686	600 mm	■	548,36 €	NE	1
502261MN	11	1" x EUROK	110 mm	200186	700 mm	■	600,48 €	NE	1
502262MN	12	1" x EUROK	110 mm	200186	700 mm	■	650,22 €	NE	1
502272MN	2	1"1/4 x EUROK	110 mm	200086	500 mm	■	162,21 €	NE	1
502273MN	3	1"1/4 x EUROK	110 mm	200086	500 mm	■	218,19 €	NE	1
502274MN	4	1"1/4 x EUROK	110 mm	200086	500 mm	■	274,30 €	NE	1
502275MN	5	1"1/4 x EUROK	110 mm	200086	500 mm	■	330,28 €	NE	1
502276MN	6	1"1/4 x EUROK	110 mm	200086	500 mm	■	386,35 €	NE	1
502277MN	7	1"1/4 x EUROK	110 mm	200086	500 mm	■	442,44 €	NE	1
502278MN	8	1"1/4 x EUROK	110 mm	200086	500 mm	■	498,47 €	NE	1
502279MN	9	1"1/4 x EUROK	110 mm	200686	600 mm	■	554,47 €	NE	1
502280MN	10	1"1/4 x EUROK	110 mm	200686	600 mm	■	610,51 €	NE	1
502281MN	11	1"1/4 x EUROK	110 mm	200186	700 mm	■	666,54 €	NE	1
502282MN	12	1"1/4 x EUROK	110 mm	200186	700 mm	■	722,56 €	NE	1



- Cassetta non inclusa >>p. 204,503
- Cabinet not included >>p. 204,503
- Casette pas inclus >>p. 204,503
- Kasten nicht enthalten >>p. 204,503
- Caja no incluida >>p. 204,503



- È possibile ordinare questo articolo in versione gialla utilizzando il medesimo codice, ma omettendo la "N" finale (prezzo su richiesta).
- It is possible to order this item in yellow version; please use the same reference code without the "N" at the end (price on request).
- Il est possible de commander cet article en version jaune en utilisant le même code, mais en omettant le "N" final (prix sur demande).
- Gelbe Ausführung verfügbar. Dieselbe o.g. Bestellnummer aber bitte „N“ am Ende weglassen (Preis auf Anfrage).
- Puede pedir este artículo en la versión amarilla con el mismo código, pero sin la „N“ al final (precio disponible bajo petición).

KC 01 KC (1")



- Kit composto da collettore di mandata con detentori a doppia regolazione micrometrica, collettore di ritorno con valvole di intercettazione a manovra manuale, staffe, terminali, valvole di carico/scarico, valvole di sfiato aria e attacchi EUROK.
- Kit made of flow manifold with double micrometric adjustment lockshields, return manifold with manually operated isolation valves, brackets, terminals, filling/drainage valves, air vent valves and EUROK connections.
- Kit composé d'un collecteur d'envoi avec inserts à double réglage micrométrique, un collecteur de retour avec des vannes d'interception à manoeuvre manuelle, étriers, parties terminales, robinets de remplissage/vidange, purgeurs d'air et embouts EUROK.
- Bausatz besteht aus Zulaufverteiler mit doppelfeinvorein Stellbareausgleicherteile, Rücklaufverteiler mit Absperbareventilen mit manueller Hebel, Haltebügel, Endstücke, Lade-/Entladeventilen, Entlüftungsventilen und EUROK Anschlüssen.
- Conjunto dotado de colector de impulsión con detentores de doble regulación micrométrica, colector de retorno con válvulas de cierre con cabeza manual, abrazaderas, terminales, válvulas para la carga/descarga, válvulas de purga de aire y conexiones EUROK.

Code	Ways	Size	Depth	Suitable Cabinet	Cabinet width	Color	Price	Class	Packaging
507162KC	2	1" x EUROK	80 mm	200086	500 mm	■	158,09 €	N3	1
507163KC	3	1" x EUROK	80 mm	200086	500 mm	■	192,69 €	N3	1
507164KC	4	1" x EUROK	80 mm	200086	500 mm	■	227,32 €	N3	1
507165KC	5	1" x EUROK	80 mm	200686	600 mm	■	261,87 €	N3	1
507166KC	6	1" x EUROK	80 mm	200686	600 mm	■	296,50 €	N3	1
507167KC	7	1" x EUROK	80 mm	200186	700 mm	■	331,10 €	N3	1
507168KC	8	1" x EUROK	80 mm	200186	700 mm	■	365,66 €	N3	1
507169KC	9	1" x EUROK	80 mm	200786	800 mm	■	400,25 €	N3	1
507170KC	10	1" x EUROK	80 mm	200786	800 mm	■	434,74 €	N3	1
507171KC	11	1" x EUROK	80 mm	200286	900 mm	■	469,41 €	N3	1
507172KC	12	1" x EUROK	80 mm	200286	900 mm	■	503,98 €	N3	1
507173KC	13	1" x EUROK	80 mm	200886	1000 mm	■	538,63 €	N3	1

KC 01 KC (1 1/4")



- Kit composto da collettore di mandata con detentori a doppia regolazione micrometrica, collettore di ritorno con valvole di intercettazione a manovra manuale, staffe, valvole di carico/scarico, valvole di sfiato aria, tappi e attacchi EUROK.
- Kit made of flow manifold with double micrometric adjustment lockshields, return manifold with manually operated isolation valves, brackets, filling/drainage valves, air vent valves, plugs and EUROK connections.
- Kit composé d'un collecteur d'envoi avec inserts à double réglage micrométrique, un collecteur de retour avec des vannes d'interception à manoeuvre manuelle, étriers, robinets de remplissage/vidange, purgeurs d'air, bouchons et embouts EUROK.
- Bausatz besteht aus Zulaufverteiler mit doppelfeinvorein Stellbareausgleicherteile, Rücklaufverteiler mit Absperbareventilen mit manueller Hebel, Haltebügel, Lade-/Entladeventilen, Entlüftungsventilen, Verschlüssen und EUROK Anschlüssen.
- Conjunto dotado de colector de impulsión con detentores de doble regulación micrométrica, colector de retorno con válvulas de cierre con cabeza manual, abrazaderas, válvulas para la carga/ descarga, válvulas de purga de aire, tapones y conexiones EUROK.

Code	Ways	Size	Depth	Suitable Cabinet	Cabinet width	Color	Price	Class	Packaging
508162KC	2	1"1/4 x EUROK	110 mm	200086	500 mm	■	163,41 €	N3	1
508163KC	3	1"1/4 x EUROK	110 mm	200086	500 mm	■	205,23 €	N3	1
508164KC	4	1"1/4 x EUROK	110 mm	200086	500 mm	■	247,21 €	N3	1
508165KC	5	1"1/4 x EUROK	110 mm	200686	600 mm	■	289,03 €	N3	1
508166KC	6	1"1/4 x EUROK	110 mm	200686	600 mm	■	331,03 €	N3	1
508167KC	7	1"1/4 x EUROK	110 mm	200186	700 mm	■	372,85 €	N3	1
508168KC	8	1"1/4 x EUROK	110 mm	200186	700 mm	■	414,85 €	N3	1
508169KC	9	1"1/4 x EUROK	110 mm	200786	800 mm	■	456,62 €	N3	1
508170KC	10	1"1/4 x EUROK	110 mm	200786	800 mm	■	498,48 €	N3	1
508171KC	11	1"1/4 x EUROK	110 mm	200286	900 mm	■	540,41 €	N3	1
508172KC	12	1"1/4 x EUROK	110 mm	200286	900 mm	■	582,30 €	N3	1



- Cassetta non inclusa >>p. 204,503
- Cabinet not included >>p. 204,503
- Casette pas inclus >>p. 204,503
- Kasten nicht enthalten >>p. 204,503
- Caja no incluida >>p. 204,503

KC 02 KC (1")

0-2.5 l/min ON REQUEST

- Kit composto da collettore di mandata con misuratori/regolatori di portata FLUXER (0-5 l/min), collettore di ritorno con valvole di intercettazione a manovra manuale, staffe, terminali, valvole di carico/scarico, valvole di sfianto aria e attacchi EUROK.
- Kit made of flow manifold with flow meters/adjusters FLUXER (0-5 l/min), return manifold with manually operated isolation valves, brackets, terminals, filling/drainage valves, air vent valves and EUROK connections.
- Kit composé d'un collecteur d'envoi avec débit-mètres/régulateurs FLUXER (0-5 l/min), un collecteur de retour avec des vannes d'interception à manoeuvre manuelle, étriers, parties terminales, robinets de remplissage/vidange, purgeurs d'air et embouts EUROK.
- Bausatz besteht aus Zulaufverteiler mit Durchflussmengenmesser FLUXER (0-5 l/min), Rücklaufverteiler mit Absperbarentilen mit manueller Hebel, Haltebügel, Endstücke, Lade-/Entladeventilen, Entlüftungsventilen und EUROK Anschlüssen.
- Conjunto dotado de colector de impulsión con medidores/reguladores de caudal FLUXER (0-5 l/min), colector de retorno con válvulas de cierre con cabeza manual, abrazaderas, terminales, válvulas para la carga/descarga, válvulas de purga de aire y conexiones EUROK.

Code	Ways	Size	Depth	Suitable Cabinet	Cabinet width	Color	Price	Class	Packaging
507182KC	2	1" x EUROK	80 mm	200086	500 mm	■	184,51 €	N3	1
507183KC	3	1" x EUROK	80 mm	200086	500 mm	■	233,31 €	N3	1
507184KC	4	1" x EUROK	80 mm	200086	500 mm	■	281,62 €	N3	1
507185KC	5	1" x EUROK	80 mm	200686	600 mm	■	330,17 €	N3	1
507186KC	6	1" x EUROK	80 mm	200686	600 mm	■	378,87 €	N3	1
507187KC	7	1" x EUROK	80 mm	200186	700 mm	■	427,40 €	N3	1
507188KC	8	1" x EUROK	80 mm	200186	700 mm	■	475,97 €	N3	1
507189KC	9	1" x EUROK	80 mm	200786	800 mm	■	524,95 €	N3	1
507190KC	10	1" x EUROK	80 mm	200786	800 mm	■	571,88 €	N3	1
507191KC	11	1" x EUROK	80 mm	200286	900 mm	■	622,38 €	N3	1
507192KC	12	1" x EUROK	80 mm	200286	900 mm	■	670,50 €	N3	1
507193KC	13	1" x EUROK	80 mm	200886	1000 mm	■	721,80 €	N3	1

KC 02 KC (1"1/4)

0-2.5 l/min ON REQUEST

- Kit composto da collettore di mandata con misuratori/regolatori di portata FLUXER (0-5 l/min), collettore di ritorno con valvole di intercettazione a manovra manuale, staffe, valvole di carico/scarico, valvole di sfianto aria, tappi e attacchi EUROK.
- Kit made of flow manifold with flow meters/adjusters FLUXER (0-5 l/min), return manifold with manually operated isolation valves, brackets, filling/drainage valves, air vent valves, plugs and EUROK connections.
- Kit composé d'un collecteur d'envoi avec débit-mètres/régulateurs FLUXER (0-5 l/min), un collecteur de retour avec des vannes d'interception à manoeuvre manuelle, étriers, robinets de remplissage/vidange, purgeurs d'air, bouchons et embouts EUROK.
- Bausatz besteht aus Zulaufverteiler mit Durchflussmengenmesser FLUXER (0-5 l/min), Rücklaufverteiler mit Absperbarentilen mit manueller Hebel, Haltebügel, Lade-/Entladeventilen, Entlüftungsventilen, Verschlüssen und EUROK Anschlüssen.
- Conjunto dotado de colector de impulsión con medidores/reguladores de caudal FLUXER (0-5 l/min), colector de retorno con válvulas de cierre con cabeza manual, abrazaderas, válvulas para la carga/ descarga, válvulas de purga de aire, tapones y conexiones EUROK.

Code	Ways	Size	Depth	Suitable Cabinet	Cabinet width	Color	Price	Class	Packaging
508182KC	2	1"1/4 x EUROK	110 mm	200086	500 mm	■	185,89 €	N3	1
508183KC	3	1"1/4 x EUROK	110 mm	200086	500 mm	■	240,07 €	N3	1
508184KC	4	1"1/4 x EUROK	110 mm	200086	500 mm	■	294,33 €	N3	1
508185KC	5	1"1/4 x EUROK	110 mm	200686	600 mm	■	348,48 €	N3	1
508186KC	6	1"1/4 x EUROK	110 mm	200686	600 mm	■	402,73 €	N3	1
508187KC	7	1"1/4 x EUROK	110 mm	200186	700 mm	■	456,98 €	N3	1
508188KC	8	1"1/4 x EUROK	110 mm	200186	700 mm	■	511,19 €	N3	1
508189KC	9	1"1/4 x EUROK	110 mm	200786	800 mm	■	565,37 €	N3	1
508190KC	10	1"1/4 x EUROK	110 mm	200786	800 mm	■	619,60 €	N3	1
508191KC	11	1"1/4 x EUROK	110 mm	200286	900 mm	■	673,79 €	N3	1
508192KC	12	1"1/4 x EUROK	110 mm	200286	900 mm	■	727,98 €	N3	1



- Cassetta non inclusa >> p. 204,503
- Cabinet not included >> p. 204,503
- Casette pas inclus >> p. 204,503
- Kasten nicht enthalten >> p. 204,503
- Caja no incluida >> p. 204,503

KC 01 A (1")

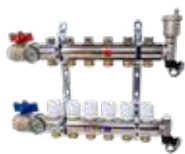

- Kit composto da collettore di mandata con detentori a doppia regolazione micrometrica, collettore di ritorno con valvole di intercettazione a manovra manuale, staffe, valvole a sfera diritte con bocchettone, termometri, terminali, valvole di carico/scarico, valvole di sfiato aria e attacchi EUROK.
- Kit made of flow manifold with double micrometric adjustment lockshields, return manifold with manually operated isolation valves, brackets, straight ball valves with fitting, thermometers, terminals, filling/drainage valves, air vent valves and EUROK connections.
- Kit composé d'un collecteur d'envoi avec inserts à double réglage micrométrique, un collecteur de retour avec des vannes d'interception à manoeuvre manuelle, étriers, vannes à bille droites avec raccord, thermomètres, parties terminales, robinets de remplissage/vidange, purgeurs d'air et embouts EUROK.
- Bausatz besteht aus Zulaufverteiler mit doppelfeinvorein Stellbareausgleicherteile, Rücklaufverteiler mit Absperbareventilen mit manueller Hebel, Haltebügel, Durchgangs-Kugelventilen mit Verschraubung, Thermometer, Endstücke, Lade-/Entladeventilen, Entlüftungsventilen und EUROK Anschlüssen.
- Conjunto dotado de colector de impulsión con detentores de doble regulación micrométrica, colector de retorno con válvulas de cierre con cabeza manual, abrazaderas, válvulas de bola rectas con manguito de unión, termómetros, terminales, válvulas para la carga/descarga, válvulas de purga de aire y conexiones EUROK.

Code	Ways	Size	Depth	Suitable Cabinet	Cabinet width	Color	Price	Class	Packaging
507162AIV	2	1" x EUROK	80 mm	200086	500 mm	■	259,34 €	N3	1
507163AIV	3	1" x EUROK	80 mm	200086	500 mm	■	293,92 €	N3	1
507164AIV	4	1" x EUROK	80 mm	200086	500 mm	■	328,58 €	N3	1
507165AIV	5	1" x EUROK	80 mm	200686	600 mm	■	363,11 €	N3	1
507166AIV	6	1" x EUROK	80 mm	200686	600 mm	■	397,75 €	N3	1
507167AIV	7	1" x EUROK	80 mm	200186	700 mm	■	432,35 €	N3	1
507168AIV	8	1" x EUROK	80 mm	200186	700 mm	■	466,92 €	N3	1
507169AIV	9	1" x EUROK	80 mm	200786	800 mm	■	501,49 €	N3	1
507170AIV	10	1" x EUROK	80 mm	200786	800 mm	■	536,00 €	N3	1
507171AIV	11	1" x EUROK	80 mm	200286	900 mm	■	570,68 €	N3	1
507172AIV	12	1" x EUROK	80 mm	200286	900 mm	■	605,23 €	N3	1
507173AIV	13	1" x EUROK	80 mm	200886	1000 mm	■	639,86 €	N3	1

KC 01 A (1"1/4)



- Kit composto da collettore di mandata con detentori a doppia regolazione micrometrica, collettore di ritorno con valvole di intercettazione a manovra manuale, staffe, valvole a sfera diritte con bocchettone, termometri, valvole di carico/scarico, valvole di sfiato aria, tappi e attacchi EUROK.
- Kit made of flow manifold with double micrometric adjustment lockshields, return manifold with manually operated isolation valves, brackets, straight ball valves with fitting, thermometers, filling/drainage valves, air vent valves, plugs and EUROK connections.
- Kit composé d'un collecteur d'envoi avec inserts à double réglage micrométrique, un collecteur de retour avec des vannes d'interception à manoeuvre manuelle, étriers, vannes à bille droites avec raccord, thermomètres, robinets de remplissage/vidange, purgeurs d'air, bouchons et embouts EUROK.
- Bausatz besteht aus Zulaufverteiler mit doppelfeinvorein Stellbareausgleicherteile, Rücklaufverteiler mit Absperbareventilen mit manueller Hebel, Haltebügel, Durchgangs-Kugelventilen mit Verschraubung, Thermometer, Lade-/Entladeventilen, Entlüftungsventilen, Verschlüssen und EUROK Anschlüssen.
- Conjunto dotado de colector de impulsión con detentores de doble regulación micrométrica, colector de retorno con válvulas de cierre con cabeza manual, abrazaderas, válvulas de bola rectas con manguito de unión, termómetros, válvulas para la carga/descarga, válvulas de purga de aire, tapones y conexiones EUROK.

Code	Ways	Size	Depth	Suitable Cabinet	Cabinet width	Color	Price	Class	Packaging
508162AIV	2	1"1/4 x EUROK	110 mm	200086	500 mm	■	311,71 €	N3	1
508163AIV	3	1"1/4 x EUROK	110 mm	200086	500 mm	■	353,53 €	N3	1
508164AIV	4	1"1/4 x EUROK	110 mm	200086	500 mm	■	395,51 €	N3	1
508165AIV	5	1"1/4 x EUROK	110 mm	200686	600 mm	■	437,33 €	N3	1
508166AIV	6	1"1/4 x EUROK	110 mm	200686	600 mm	■	479,33 €	N3	1
508167AIV	7	1"1/4 x EUROK	110 mm	200186	700 mm	■	521,17 €	N3	1
508168AIV	8	1"1/4 x EUROK	110 mm	200186	700 mm	■	563,15 €	N3	1
508169AIV	9	1"1/4 x EUROK	110 mm	200786	800 mm	■	604,91 €	N3	1
508170AIV	10	1"1/4 x EUROK	110 mm	200786	800 mm	■	646,77 €	N3	1
508171AIV	11	1"1/4 x EUROK	110 mm	200286	900 mm	■	688,74 €	N3	1
508172AIV	12	1"1/4 x EUROK	110 mm	200286	900 mm	■	730,60 €	N3	1



- Cassetta non inclusa >>p. 204,503
- Cabinet not included >>p. 204,503
- Casette pas inclus >>p. 204,503
- Kasten nicht enthalten >>p. 204,503
- Caja no incluida >>p. 204,503

KC 02 A (1")

0-2,5 l/min ON REQUEST

- **Kit composto da collettore di mandata con misuratori/regolatori di portata FLUXER (0-5 l/min), collettore di ritorno con valvole di intercettazione a manovra manuale, staffe, valvole a sfera diritte con bocchettone, termometri, terminali, valvole di carico/scarico, valvole di sfianto aria e attacchi EUROK.**
- **Kit made of flow manifold with flow meters/adjusters FLUXER (0-5 l/min), return manifold with manually operated isolation valves, brackets, straight ball valves with fitting, thermometers, terminals, filling/drainage valves, air vent valves and EUROK connections.**
- **Kit composé d'un collecteur d'envoi avec débit-mètres/régulateurs FLUXER (0-5 l/min), un collecteur de retour avec des vannes d'interception à manoeuvre manuelle, étriers, vannes à bille droites avec raccord, thermomètres, parties terminales, robinets de remplissage/vidange, purgeurs d'air et embouts EUROK.**
- **Bausatz besteht aus Zulaufverteiler mit Durchflussmengenmesser FLUXER (0-5 l/min), Rücklaufverteiler mit Absperbarentilen mit manueller Hebel, Haltebügel, Durchgangs-Kugelventilen mit Verschraubung, Thermometer, Endstücke, Lade-/Entladeventilen, Entlüftungsventilen und EUROK Anschlüssen.**
- **Conjunto dotado de colector de impulsión con medidores/reguladores de caudal FLUXER (0-5 l/min), colector de retorno con válvulas de cierre con cabeza manual, abrazaderas, válvulas de bola rectas con manguito de unión, termómetros, terminales, válvulas para la carga/descarga, válvulas de purga de aire y conexiones EUROK.**

Code	Ways	Size	Depth	Suitable Cabinet	Cabinet width	Color	Price	Class	Packaging
507182AIV	2	1" x EUROK	80 mm	200086	500 mm	■	285,74 €	N3	1
507183AIV	3	1" x EUROK	80 mm	200086	500 mm	■	334,56 €	N3	1
507184AIV	4	1" x EUROK	80 mm	200086	500 mm	■	382,87 €	N3	1
507185AIV	5	1" x EUROK	80 mm	200686	600 mm	■	431,43 €	N3	1
507186AIV	6	1" x EUROK	80 mm	200686	600 mm	■	480,13 €	N3	1
507187AIV	7	1" x EUROK	80 mm	200186	700 mm	■	528,65 €	N3	1
507188AIV	8	1" x EUROK	80 mm	200186	700 mm	■	577,23 €	N3	1
507189AIV	9	1" x EUROK	80 mm	200786	800 mm	■	626,21 €	N3	1
507190AIV	10	1" x EUROK	80 mm	200786	800 mm	■	673,13 €	N3	1
507191AIV	11	1" x EUROK	80 mm	200286	900 mm	■	723,64 €	N3	1
507192AIV	12	1" x EUROK	80 mm	200286	900 mm	■	771,76 €	N3	1
507193AIV	13	1" x EUROK	80 mm	200886	1000 mm	■	823,06 €	N3	1

KC 02 A (1"1/4)

0-2,5 l/min ON REQUEST

- **Kit composto da collettore di mandata con misuratori/regolatori di portata FLUXER (0-5 l/min), collettore di ritorno con valvole di intercettazione a manovra manuale, staffe, valvole a sfera diritte con bocchettone, termometri, valvole di carico/scarico, valvole di sfianto aria, tappi e attacchi EUROK.**
- **Kit made of flow manifold with flow meters/adjusters FLUXER (0-5 l/min), return manifold with manually operated isolation valves, brackets, straight ball valves with fitting, thermometers, filling/drainage valves, air vent valves, plugs and EUROK connections.**
- **Kit composé d'un collecteur d'envoi avec débit-mètres/régulateurs FLUXER (0-5 l/min), un collecteur de retour avec des vannes d'interception à manoeuvre manuelle, étriers, vannes à bille droites avec raccord, thermomètres, robinets de remplissage/vidange, purgeurs d'air, bouchons et embouts EUROK.**
- **Bausatz besteht aus Zulaufverteiler mit Durchflussmengenmesser FLUXER (0-5 l/min), Rücklaufverteiler mit Absperbarentilen mit manueller Hebel, Haltebügel, Durchgangs-Kugelventilen mit Verschraubung, Thermometer, Lade-/Entladeventilen, Entlüftungsventilen, Verschlüssen und EUROK Anschlüssen.**
- **Conjunto dotado de colector de impulsión con medidores/reguladores de caudal FLUXER (0-5 l/min), colector de retorno con válvulas de cierre con cabeza manual, abrazaderas, válvulas de bola rectas con manguito de unión, termómetros, válvulas para la carga/descarga, válvulas de purga de aire, tapones y conexiones EUROK.**

Code	Ways	Size	Depth	Suitable Cabinet	Cabinet width	Color	Price	Class	Packaging
508182AIV	2	1"1/4 x EUROK	110 mm	200086	500 mm	■	334,19 €	N3	1
508183AIV	3	1"1/4 x EUROK	110 mm	200086	500 mm	■	388,35 €	N3	1
508184AIV	4	1"1/4 x EUROK	110 mm	200086	500 mm	■	442,63 €	N3	1
508185AIV	5	1"1/4 x EUROK	110 mm	200686	600 mm	■	496,80 €	N3	1
508186AIV	6	1"1/4 x EUROK	110 mm	200686	600 mm	■	551,02 €	N3	1
508187AIV	7	1"1/4 x EUROK	110 mm	200186	700 mm	■	605,28 €	N3	1
508188AIV	8	1"1/4 x EUROK	110 mm	200186	700 mm	■	659,48 €	N3	1
508189AIV	9	1"1/4 x EUROK	110 mm	200786	800 mm	■	713,69 €	N3	1
508190AIV	10	1"1/4 x EUROK	110 mm	200786	800 mm	■	767,88 €	N3	1
508191AIV	11	1"1/4 x EUROK	110 mm	200286	900 mm	■	822,08 €	N3	1
508192AIV	12	1"1/4 x EUROK	110 mm	200286	900 mm	■	876,26 €	N3	1



- **Cassetta non inclusa >>p. 204,503**
- **Cabinet not included >>p. 204,503**
- **Cassette pas inclus >>p. 204,503**
- **Kasten nicht enthalten >>p. 204,503**
- **Caja no incluida >>p. 204,503**

KC 01 AS (1")



- Kit composto da collettore di mandata con detentori a doppia regolazione micrometrica, collettore di ritorno con valvole di intercettazione a manovra manuale, staffe, valvole a sfera a squadra con bocchettone, termometri, terminali, valvole di carico/scarico, valvole di sfio aria e attacchi EUROK.
- Kit made of flow manifold with double micrometric adjustment lockshields, return manifold with manually operated isolation valves, brackets, square ball valves with fitting, thermometers, terminals, filling/drainage valves, air vent valves and EUROK connections.
- Kit composé d'un collecteur d'envoi avec inserts à double réglage micrométrique, un collecteur de retour avec des vannes d'interception à manoeuvre manuelle, étriers, vannes à bille équerre avec raccord, thermomètres, parties terminales, robinets de remplissage/vidange, purgeurs d'air et embouts EUROK.
- Bausatz besteht aus Zulauffusverteiler mit doppelfeinvorein Stellbarenausgleicherteile, Rücklaufverteiler mit Absperbareventilen mit manueller Hebel, Haltebügel, Eck-Kugelventilen mit Verschraubung, Thermometer, Endstücke, Lade-/Entladeventilen, Entlüftungsventilen und EUROK Anschlüssen.
- Conjunto dotado de colector de impulsión con detentores de doble regulación micrométrica, colector de retorno con válvulas de cierre con cabeza manual, abrazaderas, válvulas de bola de escuadra con manguito de unión, termómetros, terminales, válvulas para la carga/descarga, válvulas de purga de aire y conexiones EUROK.

Code	Ways	Size	Depth	Suitable Cabinet	Cabinet width	Color	Price	Class	Packaging
507162ASIV	2	1" x EUROK	80 mm	200086	500 mm	■	268,94 €	N3	1
507163ASIV	3	1" x EUROK	80 mm	200086	500 mm	■	303,52 €	N3	1
507164ASIV	4	1" x EUROK	80 mm	200086	500 mm	■	338,16 €	N3	1
507165ASIV	5	1" x EUROK	80 mm	200686	600 mm	■	372,71 €	N3	1
507166ASIV	6	1" x EUROK	80 mm	200686	600 mm	■	407,37 €	N3	1
507167ASIV	7	1" x EUROK	80 mm	200186	700 mm	■	441,97 €	N3	1
507168ASIV	8	1" x EUROK	80 mm	200186	700 mm	■	476,51 €	N3	1
507169ASIV	9	1" x EUROK	80 mm	200786	800 mm	■	511,10 €	N3	1
507170ASIV	10	1" x EUROK	80 mm	200786	800 mm	■	545,60 €	N3	1
507171ASIV	11	1" x EUROK	80 mm	200286	900 mm	■	580,28 €	N3	1
507172ASIV	12	1" x EUROK	80 mm	200286	900 mm	■	614,83 €	N3	1
507173ASIV	13	1" x EUROK	80 mm	200886	1000 mm	■	649,47 €	N3	1

KC 01 AS (1"1/4)



- Kit composto da collettore di mandata con detentori a doppia regolazione micrometrica, collettore di ritorno con valvole di intercettazione a manovra manuale, staffe, valvole a sfera a squadra con bocchettone, termometri, valvole di carico/scarico, valvole di sfio aria, tappi e attacchi EUROK.
- Kit made of flow manifold with double micrometric adjustment lockshields, return manifold with manually operated isolation valves, brackets, square ball valves with fitting, thermometers, filling/drainage valves, air vent valves, plugs and EUROK connections.
- Kit composé d'un collecteur d'envoi avec inserts à double réglage micrométrique, un collecteur de retour avec des vannes d'interception à manoeuvre manuelle, étriers, vannes à bille équerre avec raccord, thermomètres, robinets de remplissage/vidange, purgeurs d'air, bouchons et embouts EUROK.
- Bausatz besteht aus Zulauffusverteiler mit doppelfeinvorein Stellbarenausgleicherteile, Rücklaufverteiler mit Absperbareventilen mit manueller Hebel, Haltebügel, Eck-Kugelventilen mit Verschraubung, Thermometer, Lade-/Entladeventilen, Entlüftungsventilen, Verschlüssen und EUROK Anschlüssen.
- Conjunto dotado de colector de impulsión con detentores de doble regulación micrométrica, colector de retorno con válvulas de cierre con cabeza manual, abrazaderas, válvulas de bola de escuadra con manguito de unión, termómetros, válvulas para la carga/descarga, válvulas de purga de aire, tapones y conexiones EUROK.

Code	Ways	Size	Depth	Suitable Cabinet	Cabinet width	Color	Price	Class	Packaging
508162ASIV	2	1"1/4 x EUROK	110 mm	200086	500 mm	■	321,32 €	N3	1
508163ASIV	3	1"1/4 x EUROK	110 mm	200086	500 mm	■	363,13 €	N3	1
508164ASIV	4	1"1/4 x EUROK	110 mm	200086	500 mm	■	405,12 €	N3	1
508165ASIV	5	1"1/4 x EUROK	110 mm	200686	600 mm	■	446,94 €	N3	1
508166ASIV	6	1"1/4 x EUROK	110 mm	200686	600 mm	■	488,95 €	N3	1
508167ASIV	7	1"1/4 x EUROK	110 mm	200186	700 mm	■	530,76 €	N3	1
508168ASIV	8	1"1/4 x EUROK	110 mm	200186	700 mm	■	572,74 €	N3	1
508169ASIV	9	1"1/4 x EUROK	110 mm	200786	800 mm	■	614,52 €	N3	1
508170ASIV	10	1"1/4 x EUROK	110 mm	200786	800 mm	■	656,38 €	N3	1
508171ASIV	11	1"1/4 x EUROK	110 mm	200286	900 mm	■	698,32 €	N3	1
508172ASIV	12	1"1/4 x EUROK	110 mm	200286	900 mm	■	740,18 €	N3	1



- Cassetta non inclusa >>p. 204,503
- Cabinet not included >>p. 204,503
- Casette pas inclus >>p. 204,503
- Kasten nicht enthalten >>p. 204,503
- Caja no incluida >>p. 204,503

KC 02 AS (1")

0-2.5 l/min ON REQUEST

- Kit composto da collettore di mandata con misuratori/regolatori di portata FLUXER (0-5 l/min), collettore di ritorno con valvole di intercettazione a manovra manuale, staffe, valvole a sfera a squadra con bocchettone, termometri, terminali, valvole di carico/scarico, valvole di sfio aria e attacchi EUROK.
- Kit made of flow manifold with flow meters/adjusters FLUXER (0-5 l/min), return manifold with manually operated isolation valves, brackets, square ball valves with fitting, thermometers, terminals, filling/drainage valves, air vent valves and EUROK connections.
- Kit composé d'un collecteur d'envoi avec débit-mètres/régulateurs FLUXER (0-5 l/min), un collecteur de retour avec des vannes d'interception à manoeuvre manuelle, étriers, vannes à bille équerre avec raccord, thermomètres, parties terminales, robinets de remplissage/vidange, purgeurs d'air et embouts EUROK.
- Bausatz besteht aus Zulauffusverteiler mit Durchflussmengenmesser FLUXER (0-5 l/min), Rücklaufverteiler mit Absperbareventilen mit manueller Hebel, Haltebügel, Eck-Kugelventilen mit Verschraubung, Thermometer, Endstücke, Lade-/Entladeventilen, Entlüftungsventilen und EUROK Anschlüssen.
- Conjunto dotado de colector de impulsión con medidores/reguladores de caudal FLUXER (0-5 l/min), colector de retorno con válvulas de cierre con cabeza manual, abrazaderas, válvulas de bola de escuadra con manguito de unión, termómetros, terminales, válvulas para la carga/descarga, válvulas de purga de aire y conexiones EUROK.

Code	Ways	Size	Depth	Suitable Cabinet	Cabinet width	Color	Price	Class	Packaging
507182ASIV	2	1" x EUROK	80 mm	200086	500 mm	■	295,35 €	N3	1
507183ASIV	3	1" x EUROK	80 mm	200086	500 mm	■	344,15 €	N3	1
507184ASIV	4	1" x EUROK	80 mm	200086	500 mm	■	392,46 €	N3	1
507185ASIV	5	1" x EUROK	80 mm	200686	600 mm	■	441,03 €	N3	1
507186ASIV	6	1" x EUROK	80 mm	200686	600 mm	■	489,71 €	N3	1
507187ASIV	7	1" x EUROK	80 mm	200186	700 mm	■	538,24 €	N3	1
507188ASIV	8	1" x EUROK	80 mm	200186	700 mm	■	586,81 €	N3	1
507189ASIV	9	1" x EUROK	80 mm	200786	800 mm	■	635,81 €	N3	1
507190ASIV	10	1" x EUROK	80 mm	200786	800 mm	■	682,73 €	N3	1
507191ASIV	11	1" x EUROK	80 mm	200286	900 mm	■	733,22 €	N3	1
507192ASIV	12	1" x EUROK	80 mm	200286	900 mm	■	781,35 €	N3	1
507193ASIV	13	1" x EUROK	80 mm	200886	1000 mm	■	832,64 €	N3	1

KC 02 AS (1"1/4)

0-2.5 l/min ON REQUEST

- Kit composto da collettore di mandata con misuratori/regolatori di portata FLUXER (0-5 l/min), collettore di ritorno con valvole di intercettazione a manovra manuale, staffe, valvole a sfera a squadra con bocchettone, termometri, valvole di carico/scarico, valvole di sfio aria, tappi e attacchi EUROK.
- Kit made of flow manifold with flow meters/adjusters FLUXER (0-5 l/min), return manifold with manually operated isolation valves, brackets, square ball valves with fitting, thermometers, filling/drainage valves, air vent valves, plugs and EUROK connections.
- Kit composé d'un collecteur d'envoi avec débit-mètres/régulateurs FLUXER (0-5 l/min), un collecteur de retour avec des vannes d'interception à manoeuvre manuelle, étriers, vannes à bille équerre avec raccord, thermomètres, robinets de remplissage/vidange, purgeurs d'air, bouchons et embouts EUROK.
- Bausatz besteht aus Zulauffusverteiler mit Durchflussmengenmesser FLUXER (0-5 l/min), Rücklaufverteiler mit Absperbareventilen mit manueller Hebel, Haltebügel, Eck-Kugelventilen mit Verschraubung, Thermometer, Lade-/Entladeventilen, Entlüftungsventilen, Verschlüssen und EUROK Anschlüssen.
- Conjunto dotado de colector de impulsión con medidores/reguladores de caudal FLUXER (0-5 l/min), colector de retorno con válvulas de cierre con cabeza manual, abrazaderas, válvulas de bola de escuadra con manguito de unión, termómetros, válvulas para la carga/descarga, válvulas de purga de aire, tapones y conexiones EUROK.

Code	Ways	Size	Depth	Suitable Cabinet	Cabinet width	Color	Price	Class	Packaging
508182ASIV	2	1"1/4 x EUROK	110 mm	200086	500 mm	■	339,50 €	N3	1
508183ASIV	3	1"1/4 x EUROK	110 mm	200086	500 mm	■	393,66 €	N3	1
508184ASIV	4	1"1/4 x EUROK	110 mm	200086	500 mm	■	447,93 €	N3	1
508185ASIV	5	1"1/4 x EUROK	110 mm	200686	600 mm	■	502,08 €	N3	1
508186ASIV	6	1"1/4 x EUROK	110 mm	200686	600 mm	■	556,34 €	N3	1
508187ASIV	7	1"1/4 x EUROK	110 mm	200186	700 mm	■	610,60 €	N3	1
508188ASIV	8	1"1/4 x EUROK	110 mm	200186	700 mm	■	664,79 €	N3	1
508189ASIV	9	1"1/4 x EUROK	110 mm	200786	800 mm	■	718,96 €	N3	1
508190ASIV	10	1"1/4 x EUROK	110 mm	200786	800 mm	■	773,19 €	N3	1
508191ASIV	11	1"1/4 x EUROK	110 mm	200286	900 mm	■	827,39 €	N3	1
508192ASIV	12	1"1/4 x EUROK	110 mm	200286	900 mm	■	881,58 €	N3	1



- Cassetta non inclusa >>p. 204,503
- Cabinet not included >>p. 204,503
- Casette pas inclus >>p. 204,503
- Kasten nicht enthalten >>p. 204,503
- Caja no incluida >>p. 204,503

MANIFOLDS KIT WIDTH AND SUITABLE CABINET

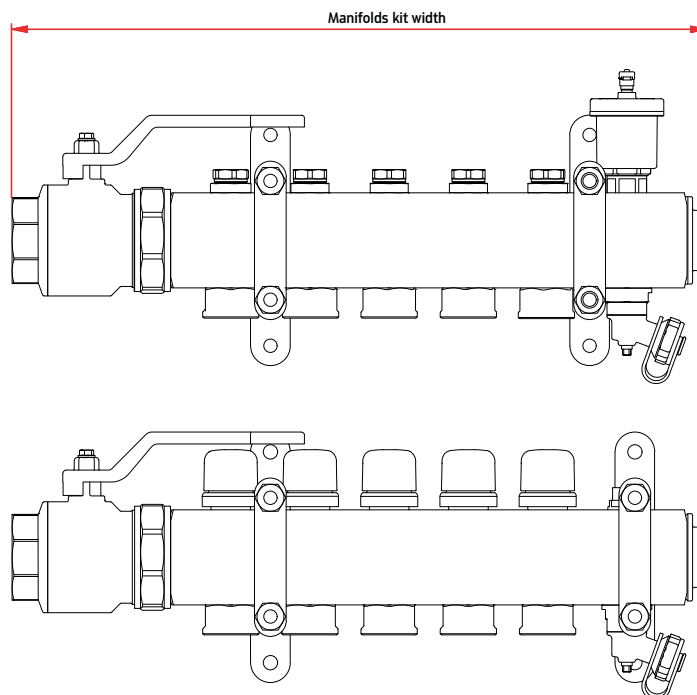

Manifold ways	2	3	4	5	6	7	8	9	10	11	12
1"1/2 manifolds kit width	305 mm	355 mm	405 mm	455 mm	505 mm	555 mm	605 mm	655 mm	705 mm	755 mm	805 mm
Cabinet code	200089	200590	200590	200090	200090	200690	200690	200190	200190	200790	200790
Cabinet width	500 mm	600 mm	600 mm	700 mm	700 mm	800 mm	800 mm	900 mm	900 mm	1.000 mm	1.000 mm

1"1/2 SINGLE MANIFOLD DIMENSIONS

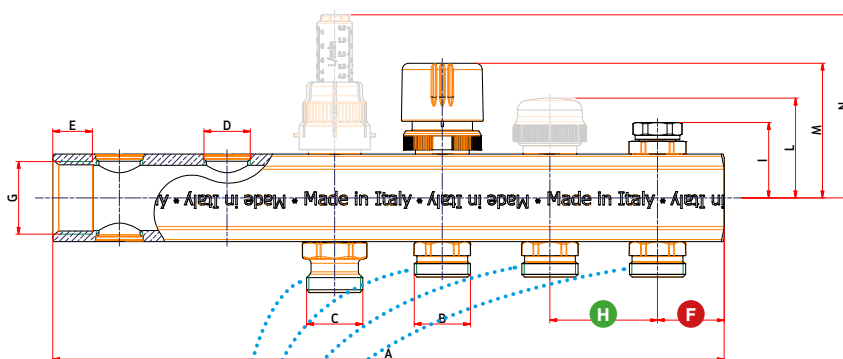

Size	1"1/2
A	$(WAYS - 1) \times H + (2 \times F)$
B	3/4" F
C	-
D	3/4" F
E	21 mm
F	38 mm
G	1"1/2
H	50 mm
I	45,5 mm
L	-
M	77 mm
N	-

Centre-to-centre distance

$$A = (WAYS - 1) \times H + (2 \times F)$$

Distance between centreline of last way and end of manifold

CS 500 (1"1/2)

- Collettore semplice.
- Plain manifold.
- Collecteur simple.
- Verteilerbalken.
- Colector simple.

Code	Ways	Size	Color	Price	Class	Packaging
560022	2	1"1/2 x 3/4" F		49,55 €	NA	1
560023	3	1"1/2 x 3/4" F		67,71 €	NA	1
560024	4	1"1/2 x 3/4" F		85,83 €	NA	1
560025	5	1"1/2 x 3/4" F		103,99 €	NA	1
560026	6	1"1/2 x 3/4" F		122,07 €	NA	1
560027	7	1"1/2 x 3/4" F		140,26 €	NA	1
560028	8	1"1/2 x 3/4" F		158,30 €	NA	1
560029	9	1"1/2 x 3/4" F		176,47 €	NA	1
560030	10	1"1/2 x 3/4" F		194,60 €	NA	1
560031	11	1"1/2 x 3/4" F		212,68 €	NA	1
560032	12	1"1/2 x 3/4" F		230,80 €	NA	1
560033	13	1"1/2 x 3/4" F		249,01 €	NA	1

CS 501 (1"1/2)

- Collettore semplice con attacco supplementare per valvola di sfiato aria.
- Plain manifold with additional connection for air vent valve.
- Collecteur simple avec embout supplémentaire pour purgeur d'air.
- Verteilerbalken mit zusätzliche Bohrung für Entlüftungsventil.
- Colector de distribución con conexión adicional para válvula de purga del aire.

Code	Ways	Size	Color	Price	Class	Packaging
560022S	2	1"1/2 x 3/4" F		49,55 €	NA	1
560023S	3	1"1/2 x 3/4" F		67,71 €	NA	1
560024S	4	1"1/2 x 3/4" F		85,83 €	NA	1
560025S	5	1"1/2 x 3/4" F		103,99 €	NA	1
560026S	6	1"1/2 x 3/4" F		122,07 €	NA	1
560027S	7	1"1/2 x 3/4" F		140,26 €	NA	1
560028S	8	1"1/2 x 3/4" F		158,30 €	NA	1
560029S	9	1"1/2 x 3/4" F		176,47 €	NA	1
560030S	10	1"1/2 x 3/4" F		194,60 €	NA	1
560031S	11	1"1/2 x 3/4" F		212,68 €	NA	1
560032S	12	1"1/2 x 3/4" F		230,80 €	NA	1
560033S	13	1"1/2 x 3/4" F		249,01 €	NA	1

■ CI 552 (1"1/2)



- Collettore di mandata con detentori a doppia regolazione micrometrica e attacchi 3/4" F.
- Flow manifold with micrometric dually adjusted lockshields and 3/4" F connections.
- Collecteur d'envoi avec inserts à double réglage micrométrique et embouts 3/4" F.
- Zulauffussbodenheizungsverteilerbalken mit doppelfeinvorein Stellbarenausgleichoberteile und 3/4" IG Anschlüssen.
- Colector de impulsión con detentores de doble regulación micrométrica y conexiones 3/4" F.

Code	Ways	Size	Color	Price	Class	Packaging
560002	2	1"1/2 x 3/4" F	■	71,09 €	NC	1
560003	3	1"1/2 x 3/4" F	■	99,94 €	NC	1
560004	4	1"1/2 x 3/4" F	■	128,70 €	NC	1
560005	5	1"1/2 x 3/4" F	■	157,56 €	NC	1
560006	6	1"1/2 x 3/4" F	■	186,42 €	NC	1
560007	7	1"1/2 x 3/4" F	■	215,23 €	NC	1
560008	8	1"1/2 x 3/4" F	■	244,09 €	NC	1
560009	9	1"1/2 x 3/4" F	■	272,85 €	NC	1
560010	10	1"1/2 x 3/4" F	■	301,71 €	NC	1
560011	11	1"1/2 x 3/4" F	■	330,46 €	NC	1
560012	12	1"1/2 x 3/4" F	■	359,33 €	NC	1
560013	13	1"1/2 x 3/4" F	■	388,18 €	NC	1

■ CI 553 (1"1/2)



- Collettore di mandata con detentori a doppia regolazione micrometrica, attacchi 3/4" F, attacchi supplementari per valvola di sfiato aria e valvola di carico/scarico.
- Flow manifold with micrometric dually adjusted lockshields, 3/4" F connections, additional connections for air vent valve and filling/drainage valve.
- Collecteur d'envoi avec inserts à double réglage micrométrique, embouts 3/4" F, embouts supplémentaires pour purgeur d'air et robinet de remplissage/vidange.
- Zulauffussbodenheizungsverteilerbalken mit doppelfeinvorein Stellbarenausgleichoberteile, 3/4" IG Anschlüssen und zusätzliche Anschlüsse für Entlüftungsventil und Lade-/Entladeventil.
- Colector de impulsión con detentores de doble regulación micrométrica, conexiones 3/4" F, conexiones adicionales para válvula de purga del aire y válvula para la carga/descarga.

Code	Ways	Size	Color	Price	Class	Packaging
560002S	2	1"1/2 x 3/4" F	■	88,47 €	NC	1
560003S	3	1"1/2 x 3/4" F	■	117,32 €	NC	1
560004S	4	1"1/2 x 3/4" F	■	146,09 €	NC	1
560005S	5	1"1/2 x 3/4" F	■	174,95 €	NC	1
560006S	6	1"1/2 x 3/4" F	■	203,82 €	NC	1
560007S	7	1"1/2 x 3/4" F	■	232,57 €	NC	1
560008S	8	1"1/2 x 3/4" F	■	261,41 €	NC	1
560009S	9	1"1/2 x 3/4" F	■	290,23 €	NC	1
560010S	10	1"1/2 x 3/4" F	■	319,04 €	NC	1
560011S	11	1"1/2 x 3/4" F	■	347,85 €	NC	1
560012S	12	1"1/2 x 3/4" F	■	376,70 €	NC	1

CI 554 C (1"1/2)

- Collettore di ritorno con valvole di intercettazione con cappuccio di protezione per vitone termostattizzabile e attacchi 3/4" F.
- Return manifold with isolation valves with protection cap for thermostatic insert and 3/4" F connections.
- Collecteur de retour avec vannes d'interception avec capuchon de protection pour insert thermostatisable et embouts 3/4" F.
- Rücklauf-fussbodenheizungsverteilerbalken mit Absperbarenventilen mit Schutzkappe für Thermostat-Reguliovorrichtung und 3/4" IG Anschlüssen.
- Colector de retorno con válvulas de cierre con tapa de protección para tornillo termostatzable y conexiones 3/4" F.

Code	Ways	Size	Color	Price	Class	Packaging
560042C	2	1"1/2 x 3/4" F	■	79,82 €	NC	1
560043C	3	1"1/2 x 3/4" F	■	113,37 €	NC	1
560044C	4	1"1/2 x 3/4" F	■	146,98 €	NC	1
560045C	5	1"1/2 x 3/4" F	■	180,54 €	NC	1
560046C	6	1"1/2 x 3/4" F	■	214,09 €	NC	1
560047C	7	1"1/2 x 3/4" F	■	247,67 €	NC	1
560048C	8	1"1/2 x 3/4" F	■	281,30 €	NC	1
560049C	9	1"1/2 x 3/4" F	■	314,86 €	NC	1
560050C	10	1"1/2 x 3/4" F	■	348,45 €	NC	1
560051C	11	1"1/2 x 3/4" F	■	382,02 €	NC	1
560052C	12	1"1/2 x 3/4" F	■	415,58 €	NC	1
560053C	13	1"1/2 x 3/4" F	■	449,14 €	NC	1

CI 555 C (1"1/2)

- Collettore di ritorno con valvole di intercettazione con cappuccio di protezione per vitone termostattizzabile, attacchi 3/4" F, attacchi supplementari per valvola di sfiato aria e valvola di carico/scarico.
- Return manifold with isolation valves with protection cap for thermostatic insert, 3/4" F connections, additional connections for air vent valve and filling/drainage valve.
- Collecteur de retour avec vannes d'interception avec capuchon de protection pour insert thermostatisable, embouts 3/4" F, embouts supplémentaires pour purgeur d'air et robinet de remplissage/vidange.
- Rücklauf-fussbodenheizungsverteilerbalken mit Absperbarenventilen mit Schutzkappe für Thermostat-Reguliovorrichtung, 3/4" IG Anschlüssen und zusätzliche Anschlüsse für Entlüftungsventil und Lade-/Entladeventil.
- Colector de retorno con válvulas de cierre con tapa de protección para tornillo termostatzable, conexiones 3/4" F, conexiones adicionales para válvula de purga del aire y válvula para la carga/descarga.

Code	Ways	Size	Color	Price	Class	Packaging
560042SC	2	1"1/2 x 3/4" F	■	97,18 €	NC	1
560043SC	3	1"1/2 x 3/4" F	■	130,74 €	NC	1
560044SC	4	1"1/2 x 3/4" F	■	164,31 €	NC	1
560045SC	5	1"1/2 x 3/4" F	■	197,93 €	NC	1
560046SC	6	1"1/2 x 3/4" F	■	231,49 €	NC	1
560047SC	7	1"1/2 x 3/4" F	■	265,08 €	NC	1
560048SC	8	1"1/2 x 3/4" F	■	298,65 €	NC	1
560049SC	9	1"1/2 x 3/4" F	■	332,21 €	NC	1
560050SC	10	1"1/2 x 3/4" F	■	365,79 €	NC	1
560051SC	11	1"1/2 x 3/4" F	■	399,41 €	NC	1
560052SC	12	1"1/2 x 3/4" F	■	432,98 €	NC	1

■ CI 554 M (1"1/2)



- Collettore di ritorno con valvole di intercettazione a manovra manuale e attacchi 3/4" F.
- Return manifold with manually operated isolation valves and 3/4" F connections.
- Collecteur de retour avec vannes d'interception à manoeuvre manuelle et embouts 3/4" F.
- Rücklauf-fussbodenheizungsverteilerbalken mit Absperbarenventilen mit manueller Hebel und 3/4" IG Anschließen.
- Colector de retorno con válvulas de cierre con cabeza manual y conexiones 3/4" F.

Code	Ways	Size	Color	Price	Class	Packaging
560042M	2	1"1/2 x 3/4" F	■	81,42 €	NC	1
560043M	3	1"1/2 x 3/4" F	■	115,78 €	NC	1
560044M	4	1"1/2 x 3/4" F	■	150,15 €	NC	1
560045M	5	1"1/2 x 3/4" F	■	184,52 €	NC	1
560046M	6	1"1/2 x 3/4" F	■	218,90 €	NC	1
560047M	7	1"1/2 x 3/4" F	■	253,32 €	NC	1
560048M	8	1"1/2 x 3/4" F	■	287,65 €	NC	1
560049M	9	1"1/2 x 3/4" F	■	322,06 €	NC	1
560050M	10	1"1/2 x 3/4" F	■	356,40 €	NC	1
560051M	11	1"1/2 x 3/4" F	■	390,79 €	NC	1
560052M	12	1"1/2 x 3/4" F	■	425,21 €	NC	1
560053M	13	1"1/2 x 3/4" F	■	459,54 €	NC	1

■ CI 555 M (1"1/2)



- Collettore di ritorno con valvole di intercettazione a manovra manuale, attacchi 3/4" F, attacchi supplementari per valvola di sfogo aria e valvola di carico/scarico.
- Return manifold with manually operated isolation valves, 3/4" F connections, additional connections for air vent valve and filling/drainage valve.
- Collecteur de retour avec vannes d'interception à manoeuvre manuelle, embouts 3/4" F, embouts supplémentaires pour purgeur d'air et robinet de remplissage/vidange.
- Rücklauf-fussbodenheizungsverteilerbalken mit Absperbarenventilen mit manueller Hebel, 3/4" IG Anschließen und zusätzliche Anschlüsse für Entlüftungsventil und Lade-/Entladeventil.
- Colector de retorno con válvulas de cierre con cabeza manual, conexiones 3/4" F, conexiones adicionales para válvula de purga del aire y válvula para la carga/descarga.

Code	Ways	Size	Color	Price	Class	Packaging
560042SM	2	1"1/2 x 3/4" F	■	98,76 €	NC	1
560043SM	3	1"1/2 x 3/4" F	■	133,16 €	NC	1
560044SM	4	1"1/2 x 3/4" F	■	167,52 €	NC	1
560045SM	5	1"1/2 x 3/4" F	■	201,92 €	NC	1
560046SM	6	1"1/2 x 3/4" F	■	236,26 €	NC	1
560047SM	7	1"1/2 x 3/4" F	■	270,65 €	NC	1
560048SM	8	1"1/2 x 3/4" F	■	305,05 €	NC	1
560049SM	9	1"1/2 x 3/4" F	■	339,41 €	NC	1
560050SM	10	1"1/2 x 3/4" F	■	373,80 €	NC	1
560051SM	11	1"1/2 x 3/4" F	■	408,18 €	NC	1
560052SM	12	1"1/2 x 3/4" F	■	442,54 €	NC	1

■ KSA 005 (1"1/2)

- **Kit composto da collettori di mandata e ritorno con detentori a doppia regolazione micrometrica, staffe, tappi e attacchi 3/4" F.**
- *Kit made of flow and return manifolds with double micrometric adjustment lockshields, brackets, plugs and 3/4" F connections.*
- **Kit composé de collecteurs d'envoi et de retour avec inserts à double réglage micrométrique, étriers, bouchons et embouts 3/4" F.**
- *Bausatz besteht aus Zulauffus- und Rücklaufverteiler mit doppelfeinvorein Stellbareausgleichoberteile, Haltebügel, Verschlüssen und 3/4" IG Anschlüssen.*
- **Conjunto dotado de colectores de impulsión y de retorno con detentores de doble regulación micrométrica, abrazaderas, tapones y conexiones 3/4" F.**

Code	Ways	Size	Depth	Suitable Cabinet	Cabinet width	Color	Price	Class	Packaging
KSA0005B02	2	1"1/2 x 3/4" F	120 mm	200089	500 mm	■	255,99 €	NC	1
KSA0005B03	3	1"1/2 x 3/4" F	120 mm	200089	500 mm	■	319,48 €	NC	1
KSA0005B04	4	1"1/2 x 3/4" F	120 mm	200089	500 mm	■	382,74 €	NC	1
KSA0005B05	5	1"1/2 x 3/4" F	120 mm	200089	500 mm	■	446,23 €	NC	1
KSA0005B06	6	1"1/2 x 3/4" F	120 mm	200590	600 mm	■	509,73 €	NC	1
KSA0005B07	7	1"1/2 x 3/4" F	120 mm	200590	600 mm	■	573,11 €	NC	1
KSA0005B08	8	1"1/2 x 3/4" F	120 mm	200090	700 mm	■	636,61 €	NC	1
KSA0005B09	9	1"1/2 x 3/4" F	120 mm	200090	700 mm	■	699,88 €	NC	1
KSA0005B10	10	1"1/2 x 3/4" F	120 mm	200690	800 mm	■	763,38 €	NC	1
KSA0005B11	11	1"1/2 x 3/4" F	120 mm	200690	800 mm	■	826,62 €	NC	1
KSA0005B12	12	1"1/2 x 3/4" F	120 mm	200190	900 mm	■	890,11 €	NC	1
KSA0005B13	13	1"1/2 x 3/4" F	120 mm	200190	900 mm	■	953,61 €	NC	1

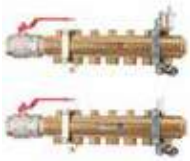
■ KSA 003 (1"1/2)

- **Kit composto da collettori di mandata e ritorno con detentori a doppia regolazione micrometrica, staffe, valvole a sfera diritte con bocchettone, valvole di carico/scarico, valvole di sfiato aria, tappi e attacchi 3/4" F.**
- *Kit made of flow and return manifolds with double micrometric adjustment lockshields, brackets, straight ball valves with fitting, filling/drainage valves, air vent valves, plugs and 3/4" F connections.*
- **Kit composé de collecteurs d'envoi et de retour avec inserts à double réglage micrométrique, étriers, vannes à bille droites avec raccord, robinets de remplissage/vidange, purgeurs d'air, bouchons et embouts 3/4" F.**
- *Bausatz besteht aus Zulauffus- und Rücklaufverteiler mit doppelfeinvorein Stellbareausgleichoberteile, Haltebügel, Durchgangs-Kugelventilen mit Verschraubung, Lade-/Entladeventilen, Entlüftungsventilen, Verschlüssen und 3/4" IG Anschlüssen.*
- **Conjunto dotado de colectores de impulsión y de retorno con detentores de doble regulación micrométrica, abrazaderas, válvulas de bola rectas con manguito de unión, válvulas para la carga/descarga, válvulas de purga de aire, tapones y conexiones 3/4" F.**

Code	Ways	Size	Depth	Suitable Cabinet	Cabinet width	Color	Price	Class	Packaging
KSA0003B02	2	1"1/2 x 3/4" F	120 mm	200089	500 mm	■	672,56 €	NC	1
KSA0003B03	3	1"1/2 x 3/4" F	120 mm	200590	600 mm	■	736,06 €	NC	1
KSA0003B04	4	1"1/2 x 3/4" F	120 mm	200590	600 mm	■	799,33 €	NC	1
KSA0003B05	5	1"1/2 x 3/4" F	120 mm	200090	700 mm	■	862,80 €	NC	1
KSA0003B06	6	1"1/2 x 3/4" F	120 mm	200090	700 mm	■	926,29 €	NC	1
KSA0003B07	7	1"1/2 x 3/4" F	120 mm	200690	800 mm	■	989,59 €	NC	1
KSA0003B08	8	1"1/2 x 3/4" F	120 mm	200690	800 mm	■	1.053,06 €	NC	1
KSA0003B09	9	1"1/2 x 3/4" F	120 mm	200190	900 mm	■	1.116,44 €	NC	1
KSA0003B10	10	1"1/2 x 3/4" F	120 mm	200190	900 mm	■	1.179,84 €	NC	1
KSA0003B11	11	1"1/2 x 3/4" F	120 mm	200790	1000 mm	■	1.243,19 €	NC	1
KSA0003B12	12	1"1/2 x 3/4" F	120 mm	200790	1000 mm	■	1.306,69 €	NC	1



- **Cassetta non inclusa >>p. 204,316,396,503**
- *Cabinet not included >>p. 204,316,396,503*
- **Cassette pas inclus >>p. 204,316,396,503**
- *Kasten nicht enthalten >>p. 204,316,396,503*
- **Caja no incluida >>p. 204,316,396,503**

■ KSA 034 (1"1/2)



- Kit composto da collettore di mandata con detentori a doppia regolazione micrometrica, collettore di ritorno con valvole di intercettazione a manovra manuale, staffe, tappi e attacchi 3/4" F.
- Kit made of flow manifold with double micrometric adjustment lockshields, return manifold with manually operated isolation valves, brackets, plugs and 3/4" F connections.
- Kit composé d'un collecteur d'envoi avec inserts à double réglage micrométrique, un collecteur de retour avec des vannes d'interception à manoeuvre manuelle, étriers, bouchons et embouts 3/4" F.
- Bausatz besteht aus Zulauffusverteiler mit doppelfeinvorein Stellbarenausgleicherteile, Rücklaufverteiler mit Absperbarentilen mit manueller Hebel, Haltebügel, Verschlüssen und 3/4" IG Anschließen.
- Conjunto dotado de colector de impulsión con detentores de doble regulación micrométrica, colector de retorno con válvulas de cierre con cabeza manual, abrazaderas, tapones y conexiones 3/4" F.

Code	Ways	Size	Depth	Suitable Cabinet	Cabinet width	Color	Price	Class	Packaging
KSA0034B02	2	1"1/2 x 3/4" F	120 mm	200089	500 mm		266,94 €	NC	1
KSA0034B03	3	1"1/2 x 3/4" F	120 mm	200089	500 mm		335,93 €	NC	1
KSA0034B04	4	1"1/2 x 3/4" F	120 mm	200089	500 mm		404,66 €	NC	1
KSA0034B05	5	1"1/2 x 3/4" F	120 mm	200089	500 mm		473,65 €	NC	1
KSA0034B06	6	1"1/2 x 3/4" F	120 mm	200590	600 mm		542,64 €	NC	1
KSA0034B07	7	1"1/2 x 3/4" F	120 mm	200590	600 mm		611,50 €	NC	1
KSA0034B08	8	1"1/2 x 3/4" F	120 mm	200090	700 mm		680,49 €	NC	1
KSA0034B09	9	1"1/2 x 3/4" F	120 mm	200090	700 mm		749,22 €	NC	1
KSA0034B10	10	1"1/2 x 3/4" F	120 mm	200690	800 mm		818,20 €	NC	1
KSA0034B11	11	1"1/2 x 3/4" F	120 mm	200690	800 mm		886,94 €	NC	1
KSA0034B12	12	1"1/2 x 3/4" F	120 mm	200190	900 mm		955,91 €	NC	1
KSA0034B13	13	1"1/2 x 3/4" F	120 mm	200190	900 mm		1.024,88 €	NC	1

■ KSA 035 (1"1/2)



- Kit composto da collettore di mandata con detentori a doppia regolazione micrometrica, collettore di ritorno con valvole di intercettazione a manovra manuale, staffe, valvole a sfera diritte con bocchettone, valvole di carico/scarico, valvole di sfogo aria, tappi e attacchi 3/4" F.
- Kit made of flow manifold with double micrometric adjustment lockshields, return manifold with manually operated isolation valves, brackets, straight ball valves with fitting, filling/drainage valves, air vent valves, plugs and 3/4" F connections.
- Kit composé d'un collecteur d'envoi avec inserts à double réglage micrométrique, un collecteur de retour avec des vannes d'interception à manoeuvre manuelle, étriers, vannes à bille droites avec raccord, robinets de remplissage/vidange, purgeurs d'air, bouchons et embouts 3/4" F.
- Bausatz besteht aus Zulauffusverteiler mit doppelfeinvorein Stellbarenausgleicherteile, Rücklaufverteiler mit Absperbarentilen mit manueller Hebel, Haltebügel, Durchgangs-Kugelventilen mit Verschraubung, Lade-/Entladeventilen, Entlüftungsventilen, Verschlüssen und 3/4" IG Anschließen.
- Conjunto dotado de colector de impulsión con detentores de doble regulación micrométrica, colector de retorno con válvulas de cierre con cabeza manual, abrazaderas, válvulas de bola rectas con manguito de unión, válvulas para la carga/descarga, válvulas de purga de aire, tapones y conexiones 3/4" F.

Code	Ways	Size	Depth	Suitable Cabinet	Cabinet width	Color	Price	Class	Packaging
KSA0035B02	2	1"1/2 x 3/4" F	120 mm	200089	500 mm		683,54 €	NC	1
KSA0035B03	3	1"1/2 x 3/4" F	120 mm	200590	600 mm		752,52 €	NC	1
KSA0035B04	4	1"1/2 x 3/4" F	120 mm	200590	600 mm		821,25 €	NC	1
KSA0035B05	5	1"1/2 x 3/4" F	120 mm	200090	700 mm		890,23 €	NC	1
KSA0035B06	6	1"1/2 x 3/4" F	120 mm	200090	700 mm		959,19 €	NC	1
KSA0035B07	7	1"1/2 x 3/4" F	120 mm	200690	800 mm		1.027,97 €	NC	1
KSA0035B08	8	1"1/2 x 3/4" F	120 mm	200690	800 mm		1.096,92 €	NC	1
KSA0035B09	9	1"1/2 x 3/4" F	120 mm	200190	900 mm		1.165,78 €	NC	1
KSA0035B10	10	1"1/2 x 3/4" F	120 mm	200190	900 mm		1.234,68 €	NC	1
KSA0035B11	11	1"1/2 x 3/4" F	120 mm	200790	1000 mm		1.303,51 €	NC	1
KSA0035B12	12	1"1/2 x 3/4" F	120 mm	200790	1000 mm		1.372,49 €	NC	1



- Cassetta non inclusa >> p. 204,316,396,503
- Cabinet not included >> p. 204,316,396,503
- Casette pas inclus >> p. 204,316,396,503
- Kasten nicht enthalten >> p. 204,316,396,503
- Caja no incluida >> p. 204,316,396,503

■ KSA 036 (1"1/2)

- **Kit collettori semplici con staffe, tappi e attacchi con valvole di intercettazione a sfera.**
- *Plain manifolds kit with brackets, plugs and connections with isolation ball valves.*
- **Kit de collecteurs simples avec étriers, bouchons et embouts avec vannes d'interception à bille.**
- *Heizkörper-verteiler-kit mit Haltebügel, Verschlüssen und Kugelabsperbarentiln.*
- **Conjunto de colectores simples con abrazaderas, tapones y conexiones con válvulas de interceptación de bola.**

Code	Ways	Size	Depth	Suitable Cabinet	Cabinet width	Color	Price	Class	Packaging
KSA0036B02	2	1"1/2 x 3/4" F	130 mm	200089	500 mm	■	325,45 €	NA	1
KSA0036B03	3	1"1/2 x 3/4" F	130 mm	200089	500 mm	■	420,63 €	NA	1
KSA0036B04	4	1"1/2 x 3/4" F	130 mm	200089	500 mm	■	515,57 €	NA	1
KSA0036B05	5	1"1/2 x 3/4" F	130 mm	200089	500 mm	■	610,77 €	NA	1
KSA0036B06	6	1"1/2 x 3/4" F	130 mm	200590	600 mm	■	705,96 €	NA	1
KSA0036B07	7	1"1/2 x 3/4" F	130 mm	200590	600 mm	■	801,01 €	NA	1
KSA0036B08	8	1"1/2 x 3/4" F	130 mm	200090	700 mm	■	896,23 €	NA	1
KSA0036B09	9	1"1/2 x 3/4" F	130 mm	200090	700 mm	■	991,16 €	NA	1
KSA0036B10	10	1"1/2 x 3/4" F	130 mm	200690	800 mm	■	1.086,35 €	NA	1
KSA0036B11	11	1"1/2 x 3/4" F	130 mm	200690	800 mm	■	1.181,28 €	NA	1
KSA0036B12	12	1"1/2 x 3/4" F	130 mm	200190	900 mm	■	1.276,47 €	NA	1
KSA0036B13	13	1"1/2 x 3/4" F	130 mm	200190	900 mm	■	1.371,64 €	NA	1

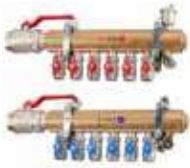
■ KSA 037 (1"1/2)

- **Kit collettori semplici con staffe, valvole a sfera diritte con bocchettone, valvole di carico/scarico, valvole di sfianto aria, tappi e attacchi con valvole di intercettazione a sfera.**
- *Plain manifolds kit with brackets, straight ball valves with fitting, filling/drainage valves, air vent valves, plugs and connections with isolation ball valves.*
- **Kit de collecteurs simples avec étriers, vannes à bille droites avec raccord, robinets de remplissage/vidange, purgeurs d'air, bouchons et embouts avec vannes d'interception à bille.**
- *Heizkörper-verteiler-kit mit Haltebügel, Durchgangs-Kugelventilen mit Verschraubung, Lade-/Entladeventilen, Entlüftungsventilen, Verschlüssen und Kugelabsperbarentiln.*
- **Conjunto de colectores simples con abrazaderas, válvulas de bola rectas con manguito de unión, válvulas para la carga/descarga, válvulas de purga de aire, tapones y conexiones con válvulas de interceptación de bola.**

Code	Ways	Size	Depth	Suitable Cabinet	Cabinet width	Color	Price	Class	Packaging
KSA0037B02	2	1"1/2 x 3/4" F	130 mm	200089	500 mm	■	761,64 €	NA	1
KSA0037B03	3	1"1/2 x 3/4" F	130 mm	200590	600 mm	■	856,82 €	NA	1
KSA0037B04	4	1"1/2 x 3/4" F	130 mm	200590	600 mm	■	951,75 €	NA	1
KSA0037B05	5	1"1/2 x 3/4" F	130 mm	200090	700 mm	■	1.046,93 €	NA	1
KSA0037B06	6	1"1/2 x 3/4" F	130 mm	200090	700 mm	■	1.142,14 €	NA	1
KSA0037B07	7	1"1/2 x 3/4" F	130 mm	200690	800 mm	■	1.237,11 €	NA	1
KSA0037B08	8	1"1/2 x 3/4" F	130 mm	200690	800 mm	■	1.332,27 €	NA	1
KSA0037B09	9	1"1/2 x 3/4" F	130 mm	200190	900 mm	■	1.427,33 €	NA	1
KSA0037B10	10	1"1/2 x 3/4" F	130 mm	200190	900 mm	■	1.522,44 €	NA	1
KSA0037B11	11	1"1/2 x 3/4" F	130 mm	200790	1000 mm	■	1.617,47 €	NA	1
KSA0037B12	12	1"1/2 x 3/4" F	130 mm	200790	1000 mm	■	1.712,66 €	NA	1



- **Cassette non inclusa >>p. 204,316,396,503**
- *Cabinet not included >>p. 204,316,396,503*
- **Cassette pas inclus >>p. 204,316,396,503**
- *Kasten nicht enthalten >>p. 204,316,396,503*
- **Caja no incluida >>p. 204,316,396,503**

STAINLESS STEEL MANIFOLDS

IVAR steel manifolds are a valid alternative to traditional brass manifolds. They are used for the distribution of heating fluid both in radiant panel systems and radiators, and are compatible also with cooling systems, where suitable insulation is recommended to avoid the effects of surface condensation.

Thanks to micrometric lockshields or flow rate controllers, IVAR's Fluxer stainless-steel manifolds guarantee perfect system balancing, avoiding energy waste and ensuring maximum ambient comfort. They are equipped with manual shutoff valves or valves with electrothermal head for the control of individual circuits.

The manifolds, in AISI 304 high gauge stainless steel, are supplied in flow-return kits, in all the same configurations as available for the brass manifolds. With 1" head fittings and 3/4" BSP EUROK branches, they are available with 2 to 13 ways and are perfectly compatible with all the accessories available for the brass bar manifolds..

Materials

Body: AISI 304 stainless steel
Seals and O-rings: peroxide EPDM
Shutoff knobs and caps: ABS

Technical specifications

Max. fluid temperature: 90 °C
Maximum operating pressure: 10 bar

PLUS

- Large transit section for increased flow rate.
- Lightweight and easy to install.
- Compatible with both low and high temperatures.
- Optimal mechanical resistance to corrosion
- Competitive price

MANIFOLD KIT DIMENSIONS AND SUITABLE CABINET

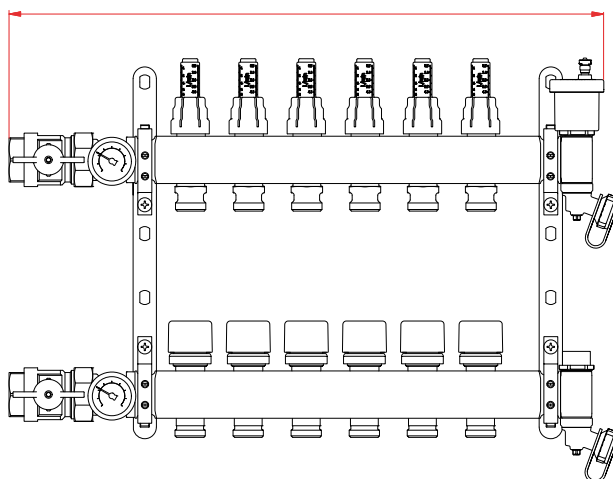

Manifold ways	2	3	4	5	6	7	8	9	10	11	12	13
1" manifolds kit width	328 mm	378 mm	428 mm	478 mm	528 mm	578 mm	628 mm	678 mm	728 mm	778 mm	828 mm	878 mm
 Cabinet code	200130	200130	200130	200131	200131	200131	200131	200132	200132	200133	200133	200133
Cabinet width	500 mm	500 mm	500 mm	700 mm	700 mm	700 mm	700 mm	850 mm	850 mm	1.000 mm	1.000 mm	1.000 mm
 Cabinet code	200086	200086	200086	200686	200686	200186	200186	200786	200786	200286	200286	200886
Cabinet width	500 mm	500 mm	500 mm	600 mm	600 mm	700 mm	700 mm	800 mm	800 mm	900 mm	900 mm	1.000 mm

Manifold ways	2	3	4	5	6	7	8	9	10	11	12
1"1/4 manifolds kit width	352 mm	402 mm	452 mm	502 mm	552 mm	602 mm	652 mm	702 mm	752 mm	802 mm	852 mm
 Cabinet code	200086	200086	200086	200686	200686	200186	200186	200786	200786	200286	200286
Cabinet width	500 mm	500 mm	500 mm	600 mm	600 mm	700 mm	700 mm	800 mm	800 mm	900 mm	900 mm

EXAMPLES OF APPLICATION FOR STAINLESS-STEEL MANIFOLD ACCESSORIES

FLUXER®

Fluxer is the IVAR device for balancing and the display of flow rates on single circuits.



Glass panel replaceable also with system in operation
Possibility of shutoff and position memory

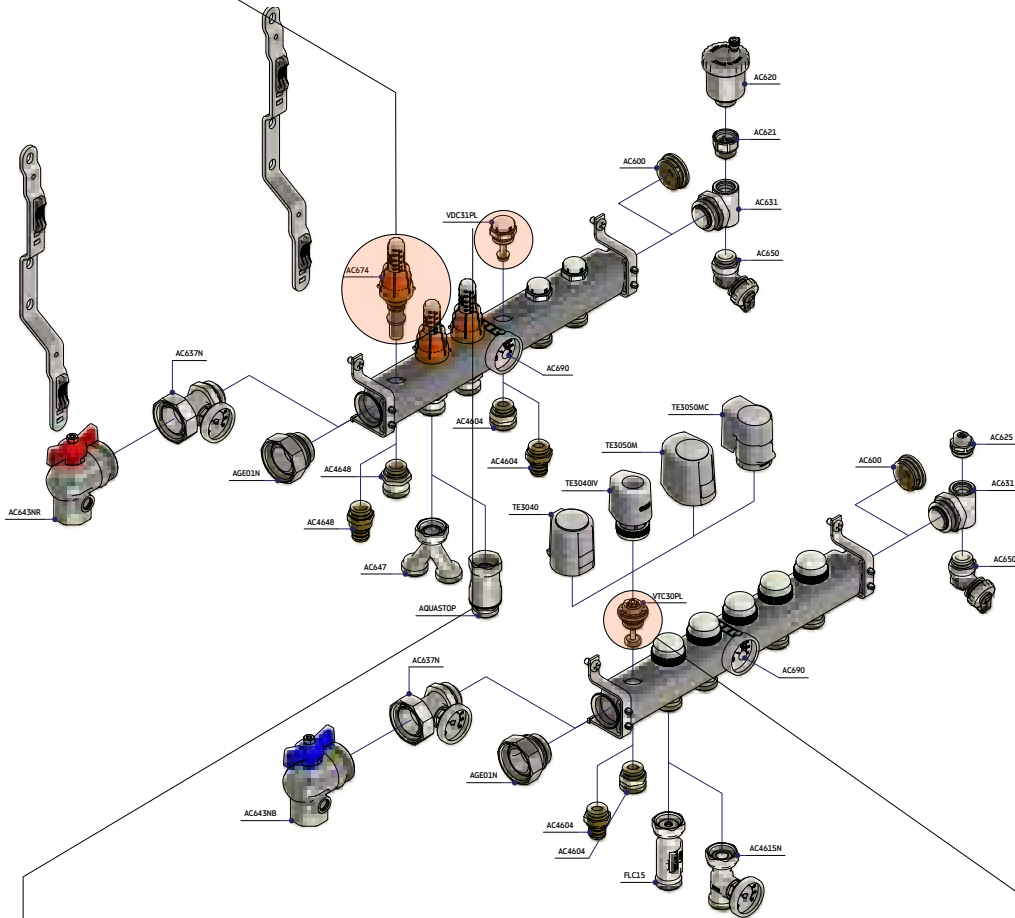

INSERT WITH THERMOSTATIC CONTROL OPTION

The manifolds with thermostat control option are supplied with a control knob serving to protect the thread and possible shutoff of the bypass circuit.



LOCKSHIELD

Used for the control and static balancing of circuits, equipped with a screw with micrometric thread for gradual opening of the shutter and position memory. The position memory enables shutoff of the circuit, leaving the grub screw position unchanged for subsequent re-opening.

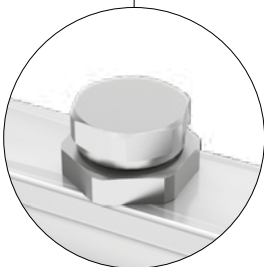

The control rod can also be replaced with the system in operation.





FOCUS: Outlets misalignment (for 1" manifolds only)

F1 distance is 40 mm long, while F2 distance is 65 mm long. When you rotate 180° one of the two manifolds, you get the outputs misaligned. This feature makes the installation of pipes very simple.

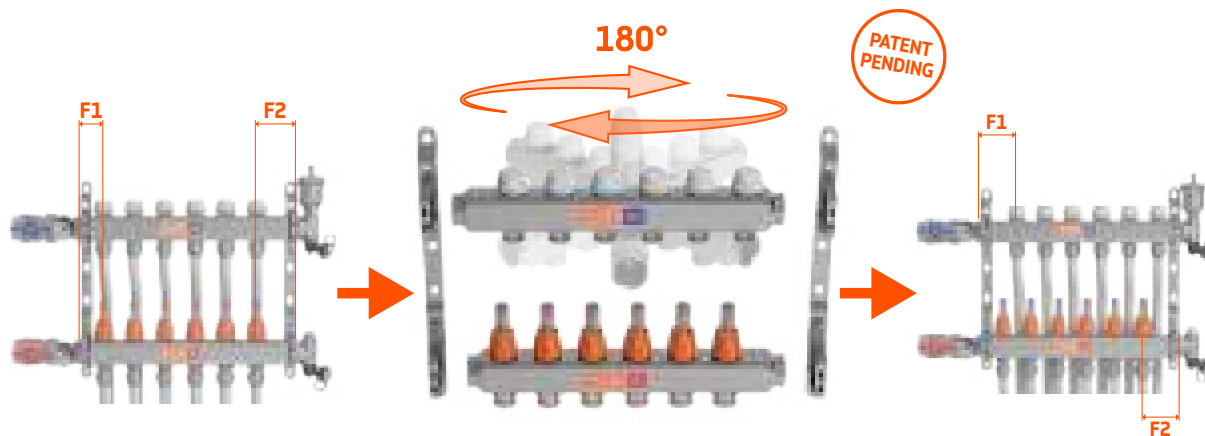

G 1" 1/4

G 1"

NOW AVAILABLE

1" SINGLE MANIFOLD DIMENSIONS

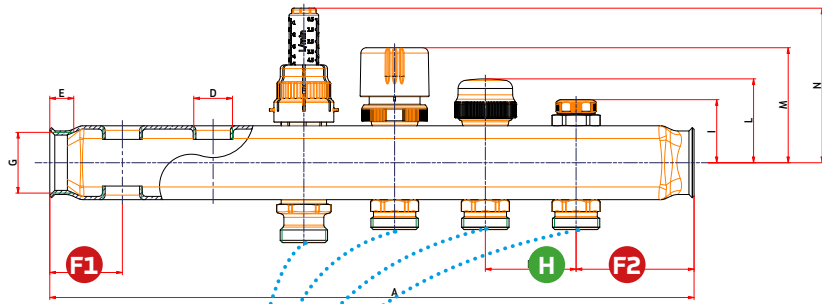

Size	1"
A	$(WAYS - 1) \times H + F1 + F2$
B	EUROK
C	EUROK
D	1/2" F
E	13 mm
F1	40 mm
F2	65 mm
G	1"
H	50 mm
I	36 mm
L	46,5 mm
M	66,5 mm
N	88 mm

$$A = (WAYS - 1) \times H + F1 + F2$$

Centre-to-centre distance

Distance between centreline of last way and end of manifold

1"1/4 SINGLE MANIFOLD DIMENSIONS

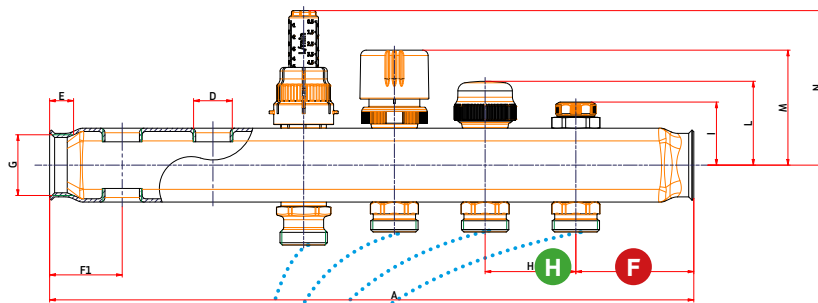

Size	1"1/4
A	$(WAYS - 1) \times H + (2 \times F)$
B	EUROK
C	EUROK
D	1/2" F
E	13 mm
F	57,5 mm
G	1"1/4
H	50 mm
I	41 mm
L	51,5 mm
M	72 mm
N	93,5 mm

$$A = (WAYS - 1) \times H + (2 \times F)$$

Centre-to-centre distance

Distance between centreline of last way and end of manifold

CS 580



- Collettore semplice con attacchi EUROK.
- Plain manifold with EUROK connections.
- Collecteur simple avec embouts EUROK.
- Verteilerbalken mit EUROK Anschlussnippeln.
- Colector simple con conexiones EUROK.

Code	Ways	Size	Price	Class	Packaging
503622	2	1" x EUROK	35,81 €	OA	36
503623	3	1" x EUROK	44,38 €	OA	26
503624	4	1" x EUROK	52,92 €	OA	18
503625	5	1" x EUROK	61,47 €	OA	16
503626	6	1" x EUROK	70,01 €	OA	14
503627	7	1" x EUROK	78,58 €	OA	14
503628	8	1" x EUROK	87,12 €	OA	14
503629	9	1" x EUROK	95,68 €	OA	14
503630	10	1" x EUROK	104,22 €	OA	14
503631	11	1" x EUROK	112,79 €	OA	14
503632	12	1" x EUROK	121,33 €	OA	14
503633	13	1" x EUROK	129,88 €	OA	14

- Versione 1"1/4 disponibile su richiesta.
- 1"1/4 version available on request.
- Version 1"1/4 disponible sur demande.
- 1"1/4 Ausführung auf Anfrage erhältlich.
- Versión de 1"1/4 disponible bajo pedido.

CI 599

- Collettore di mandata con detentori a doppia regolazione micrometrica e attacchi EUROK.
- Flow manifold with micrometric dually adjusted lockshields and EUROK connections.
- Collecteur d'envoi avec inserts à double réglage micrométrique et embouts EUROK.
- Zulauffussbodenheizungsverteilerbalken mit doppelfeinvorein Stellbareausgleichoberteile und EUROK Anschlüssen.
- Colector de impulsión con detentores de doble regulación micrométrica y conexiones EUROK.

Code	Ways	Size	Price	Class	Packaging
503342	2	1" x EUROK	51,73 €	OB	12
503343	3	1" x EUROK	68,60 €	OB	12
503344	4	1" x EUROK	85,51 €	OB	8
503345	5	1" x EUROK	102,40 €	OB	6
503346	6	1" x EUROK	119,28 €	OB	6
503347	7	1" x EUROK	136,17 €	OB	6
503348	8	1" x EUROK	153,06 €	OB	6
503349	9	1" x EUROK	169,94 €	OB	6
503350	10	1" x EUROK	186,82 €	OB	6
503351	11	1" x EUROK	203,71 €	OB	6
503352	12	1" x EUROK	220,61 €	OB	6
503353	13	1" x EUROK	240,45 €	OB	6
503354	14	1" x EUROK	278,16 €	OB	6
503355	15	1" x EUROK	307,35 €	OB	6
503356	16	1" x EUROK	345,68 €	OB	6

CI 599 SP

- Collettore di mandata con detentori a doppia regolazione micrometrica, attacchi EUROK, attacchi supplementari per valvola di sfioro aria e valvola di carico/scarico.
- Flow manifold with micrometric dually adjusted lockshields, EUROK connections, additional connections for air vent valve and filling/drainage valve.
- Collecteur d'envoi avec inserts à double réglage micrométrique, embouts EUROK, embouts supplémentaires pour purgeur d'air et robinet de remplissage/vidange.
- Zulauffussbodenheizungsverteilerbalken mit doppelfeinvorein Stellbareausgleichoberteile, EUROK Anschlüssen und zusätzliche Anschlüsse für Entlüftungsventil und Lade-/Entladeventil.
- Colector de impulsión con detentores de doble regulación micrométrica, conexiones EUROK, conexiones adicionales para válvula de purga del aire y válvula para la carga/descarga.

Code	Ways	Size	Price	Class	Packaging
503402	2	1" x EUROK	53,62 €	OB	12
503403	3	1" x EUROK	71,00 €	OB	12
503404	4	1" x EUROK	88,40 €	OB	8
503405	5	1" x EUROK	105,78 €	OB	6
503406	6	1" x EUROK	123,17 €	OB	6
503407	7	1" x EUROK	140,56 €	OB	6
503408	8	1" x EUROK	157,95 €	OB	6
503409	9	1" x EUROK	175,34 €	OB	6
503410	10	1" x EUROK	192,72 €	OB	6
503411	11	1" x EUROK	210,11 €	OB	6
503412	12	1" x EUROK	229,90 €	OB	6
503413	13	1" x EUROK	254,60 €	OB	6
503414	14	1" x EUROK	296,51 €	OB	6
503415	15	1" x EUROK	334,73 €	OB	6

- Versione 1"1/4 disponibile su richiesta.
- 1"1/4 version available on request.
- Version 1"1/4 disponible sur demande.
- 1"1/4 Ausführung auf Anfrage erhältlich.
- Versión de 1"1/4 disponible bajo pedido.

CI 598

- Collettore di mandata con misuratore/regolatore portata FLUXER (0-5 l/min) e attacchi EUROK.
- Flow manifold with flow meter/adjuster FLUXER (0-5 l/min) and EUROK connections.
- Collecteur d'envoi avec débit-mètre/régulateur FLUXER (0-5 l/min) et embouts EUROK.
- Vorlaufverteiler mit Durchflussmengenmesser FLUXER (0-5 l/min) und EUROK Anschlüssen.
- Colector de impulsión medidor/regulador de caudal FLUXER (0-5 l/min) y conexiones EUROK.



0-2,5 l/min ON REQUEST

Code	Ways	Size	Price	Class	Packaging
503322	2	1" x EUROK	58,91 €	OB	12
503323	3	1" x EUROK	79,38 €	OB	10
503324	4	1" x EUROK	99,88 €	OB	8
503325	5	1" x EUROK	120,36 €	OB	6
503326	6	1" x EUROK	140,82 €	OB	6
503327	7	1" x EUROK	161,32 €	OB	6
503328	8	1" x EUROK	181,78 €	OB	6
503329	9	1" x EUROK	202,26 €	OB	6
503330	10	1" x EUROK	222,75 €	OB	6
503331	11	1" x EUROK	243,23 €	OB	6
503332	12	1" x EUROK	263,70 €	OB	6
503333	13	1" x EUROK	287,14 €	OB	6
503334	14	1" x EUROK	328,46 €	OB	6
503335	15	1" x EUROK	361,24 €	OB	6
503336	16	1" x EUROK	403,13 €	OB	6
503442	2	1"1/4 x EUROK	64,08 €	OB	1
503443	3	1"1/4 x EUROK	88,71 €	OB	1
503444	4	1"1/4 x EUROK	113,34 €	OB	1
503445	5	1"1/4 x EUROK	137,95 €	OB	1
503446	6	1"1/4 x EUROK	162,57 €	OB	1
503447	7	1"1/4 x EUROK	187,21 €	OB	1
503448	8	1"1/4 x EUROK	211,83 €	OB	1
503449	9	1"1/4 x EUROK	236,44 €	OB	1
503450	10	1"1/4 x EUROK	261,06 €	OB	1
503451	11	1"1/4 x EUROK	285,69 €	OB	1
503452	12	1"1/4 x EUROK	310,31 €	OB	1
503453	13	1"1/4 x EUROK	334,93 €	OB	1
503454	14	1"1/4 x EUROK	359,55 €	OB	1
503455	15	1"1/4 x EUROK	384,19 €	OB	1
503456	16	1"1/4 x EUROK	408,81 €	OB	1

CI 598 SP

0-2,5 l/min ON REQUEST

- Collettore di mandata con misuratore/regolatore portata FLUXER (0-5 l/min), attacchi EUROK, attacchi supplementari per valvola di sfiato aria e valvola di carico/scarico.
- Flow manifold with flow meter/adjuster FLUXER (0-5 l/min), EUROK connections, additional connections for air vent valve and filling/drainage valve.
- Collecteur d'envoi avec débit-mètre/régulateur FLUXER (0-5 l/min), embouts EUROK, embouts supplémentaires pour purgeur d'air et robinet de remplissage/vidange.
- Vorlaufverteiler mit Durchflussmengenmesser FLUXER (0-5 l/min), EUROK Anschlüssen und zusätzliche Anschlüsse für Entlüftungsventil und Lade-/Entladeventil.
- Colector de impulsión medidor/regulador de caudal FLUXER (0-5 l/min), conexiones EUROK, conexiones adicionales para válvula de purga del aire y válvula para la carga/descarga.

Code	Ways	Size	Price	Class	Packaging
503382	2	1" x EUROK	60,79 €	OB	12
503383	3	1" x EUROK	83,30 €	OB	12
503384	4	1" x EUROK	105,80 €	OB	8
503385	5	1" x EUROK	128,30 €	OB	6
503386	6	1" x EUROK	150,79 €	OB	6
503387	7	1" x EUROK	173,30 €	OB	6
503388	8	1" x EUROK	195,81 €	OB	6
503389	9	1" x EUROK	218,30 €	OB	6
503390	10	1" x EUROK	240,81 €	OB	6
503391	11	1" x EUROK	263,31 €	OB	6
503392	12	1" x EUROK	273,00 €	OB	6
503393	13	1" x EUROK	301,29 €	OB	6
503394	14	1" x EUROK	346,80 €	OB	6
503395	15	1" x EUROK	388,60 €	OB	6
503462	2	1"1/4 x EUROK	64,04 €	OB	1
503463	3	1"1/4 x EUROK	89,52 €	OB	1
503464	4	1"1/4 x EUROK	115,01 €	OB	1
503465	5	1"1/4 x EUROK	140,50 €	OB	1
503466	6	1"1/4 x EUROK	166,00 €	OB	1
503467	7	1"1/4 x EUROK	191,49 €	OB	1
503468	8	1"1/4 x EUROK	216,96 €	OB	1
503469	9	1"1/4 x EUROK	242,45 €	OB	1
503470	10	1"1/4 x EUROK	267,95 €	OB	1
503471	11	1"1/4 x EUROK	293,44 €	OB	1
503472	12	1"1/4 x EUROK	318,91 €	OB	1
503473	13	1"1/4 x EUROK	344,40 €	OB	1
503474	14	1"1/4 x EUROK	369,89 €	OB	1
503475	15	1"1/4 x EUROK	395,36 €	OB	1



CI 583

- Collettore di ritorno con valvole di intercettazione con cappuccio di protezione per vitone termostattabile e attacchi EUROK.
- Return manifold with isolation valves with protection cap for thermostatic insert and EUROK connections.
- Collecteur de retour avec vannes d'interception avec capuchon de protection pour insert thermostatisable et embouts EUROK.
- Rücklauf-fussbodenheizungsverteilerbalken mit Absperbarenventilen mit Schutzkappe für Thermostat-Reguliovorrichtung und EUROK Anschlüssen.
- Colector de retorno con válvulas de cierre con tapa de protección para tornillo termostatizable y conexiones EUROK.

Code	Ways	Size	Price	Class	Packaging
503182	2	1" x EUROK	47,87 €	OB	12
503183	3	1" x EUROK	63,61 €	OB	12
503184	4	1" x EUROK	79,33 €	OB	8
503185	5	1" x EUROK	95,08 €	OB	6
503186	6	1" x EUROK	110,81 €	OB	6
503187	7	1" x EUROK	126,54 €	OB	6
503188	8	1" x EUROK	142,28 €	OB	6
503189	9	1" x EUROK	158,01 €	OB	6
503190	10	1" x EUROK	173,73 €	OB	6
503191	11	1" x EUROK	189,49 €	OB	6
503192	12	1" x EUROK	205,21 €	OB	6
503193	13	1" x EUROK	223,88 €	OB	6
503194	14	1" x EUROK	257,67 €	OB	6
503195	15	1" x EUROK	285,33 €	OB	6
503196	16	1" x EUROK	321,36 €	OB	6
503482	2	1"1/4 x EUROK	54,95 €	OB	1
503483	3	1"1/4 x EUROK	75,18 €	OB	1
503484	4	1"1/4 x EUROK	95,42 €	OB	1
503485	5	1"1/4 x EUROK	115,64 €	OB	1
503486	6	1"1/4 x EUROK	135,88 €	OB	1
503487	7	1"1/4 x EUROK	156,10 €	OB	1
503488	8	1"1/4 x EUROK	176,33 €	OB	1
503489	9	1"1/4 x EUROK	196,55 €	OB	1
503490	10	1"1/4 x EUROK	216,80 €	OB	1
503491	11	1"1/4 x EUROK	237,02 €	OB	1
503492	12	1"1/4 x EUROK	257,26 €	OB	1
503493	13	1"1/4 x EUROK	277,48 €	OB	1
503494	14	1"1/4 x EUROK	297,72 €	OB	1
503495	15	1"1/4 x EUROK	317,96 €	OB	1
503496	16	1"1/4 x EUROK	338,16 €	OB	1

CI 583 SP

- Collettore di ritorno con valvole di intercettazione con cappuccio di protezione per vitone termostattizzabile, attacchi EUROK, attacchi supplementari per valvola di sfiato aria e valvola di carico/scarico.
- Return manifold with isolation valves with protection cap for thermostatic insert, EUROK connections, additional connections for air vent valve and filling/drainage valve.
- Collecteur de retour avec vannes d'interception avec capuchon de protection pour insert thermostatisable, embouts EUROK, embouts supplémentaires pour purgeur d'air et robinet de remplissage/vidange.
- Rücklauf-fussbodenheizungsverteilerbalken mit Absperbarenventilen mit Schutzkappe für Thermostat-Reguliervorrichtung, EUROK Anschlüssen und zusätzliche Anschlüsse für Entlüftungsventil und Lade-/Entladeventil.
- Colector de retorno con válvulas de cierre con tapa de protección para tornillo termostaticable, conexiones EUROK, conexiones adicionales para válvula de purga del aire y válvula para la carga/descarga.

Code	Ways	Size	Price	Class	Packaging
503362	2	1" x EUROK	49,77 €	OB	12
503363	3	1" x EUROK	66,00 €	OB	12
503364	4	1" x EUROK	82,25 €	OB	8
503365	5	1" x EUROK	98,49 €	OB	6
503366	6	1" x EUROK	114,74 €	OB	6
503367	7	1" x EUROK	130,99 €	OB	6
503368	8	1" x EUROK	147,23 €	OB	6
503369	9	1" x EUROK	163,48 €	OB	6
503370	10	1" x EUROK	179,72 €	OB	6
503371	11	1" x EUROK	195,98 €	OB	6
503372	12	1" x EUROK	214,51 €	OB	6
503373	13	1" x EUROK	238,02 €	OB	6
503374	14	1" x EUROK	276,03 €	OB	6
503375	15	1" x EUROK	312,69 €	OB	6
514362	2	1"1/4 x EUROK	56,85 €	OB	1
514363	3	1"1/4 x EUROK	77,98 €	OB	1
514364	4	1"1/4 x EUROK	99,08 €	OB	1
514365	5	1"1/4 x EUROK	120,20 €	OB	1
514366	6	1"1/4 x EUROK	141,34 €	OB	1
514367	7	1"1/4 x EUROK	162,45 €	OB	1
514368	8	1"1/4 x EUROK	183,56 €	OB	1
514369	9	1"1/4 x EUROK	204,69 €	OB	1
514370	10	1"1/4 x EUROK	225,81 €	OB	1
514371	11	1"1/4 x EUROK	246,92 €	OB	1
514372	12	1"1/4 x EUROK	268,04 €	OB	1
514373	13	1"1/4 x EUROK	289,17 €	OB	1
514374	14	1"1/4 x EUROK	310,29 €	OB	1
514375	15	1"1/4 x EUROK	331,40 €	OB	1



CS 584



- Kit collettori semplici con staffe e attacchi EUROK.
- Plain manifolds kit with brackets and EUROK connections.
- Kit de collecteurs simples avec étriers et embouts EUROK.
- Heizkörper-verteiler-kit mit Haltebügel und EUROK Anschlüssen.
- Conjunto de colectores simples con abrazaderas y conexiones EUROK.

Code	Ways	Size	Depth	Suitable Cabinet	Cabinet width	Price	Class	Packaging
503502P80	2	1" x EUROK	80 mm	200086	500 mm	97,13 €	OA	1
503503P80	3	1" x EUROK	80 mm	200086	500 mm	114,24 €	OA	1
503504P80	4	1" x EUROK	80 mm	200086	500 mm	131,36 €	OA	1
503505P80	5	1" x EUROK	80 mm	200086	500 mm	148,45 €	OA	1
503506P80	6	1" x EUROK	80 mm	200086	500 mm	165,56 €	OA	1
503507P80	7	1" x EUROK	80 mm	200086	500 mm	182,66 €	OA	1
503508P80	8	1" x EUROK	80 mm	200086	500 mm	199,77 €	OA	1
503509P80	9	1" x EUROK	80 mm	200686	600 mm	216,86 €	OA	1
503510P80	10	1" x EUROK	80 mm	200686	600 mm	233,97 €	OA	1
503511P80	11	1" x EUROK	80 mm	200186	700 mm	251,07 €	OA	1
503512P80	12	1" x EUROK	80 mm	200186	700 mm	268,18 €	OA	1
503513P80	13	1" x EUROK	80 mm	200786	800 mm	285,29 €	OA	1
503502	2	1" x EUROK	110 mm	200086	500 mm	97,13 €	OA	1
503503	3	1" x EUROK	110 mm	200086	500 mm	114,24 €	OA	1
503504	4	1" x EUROK	110 mm	200086	500 mm	131,36 €	OA	1
503505	5	1" x EUROK	110 mm	200086	500 mm	148,45 €	OA	1
503506	6	1" x EUROK	110 mm	200086	500 mm	165,56 €	OA	1
503507	7	1" x EUROK	110 mm	200086	500 mm	182,66 €	OA	1
503508	8	1" x EUROK	110 mm	200086	500 mm	199,77 €	OA	1
503509	9	1" x EUROK	110 mm	200686	600 mm	216,86 €	OA	1
503510	10	1" x EUROK	110 mm	200686	600 mm	233,97 €	OA	1
503511	11	1" x EUROK	110 mm	200186	700 mm	251,07 €	OA	1
503512	12	1" x EUROK	110 mm	200186	700 mm	268,18 €	OA	1
503513	13	1" x EUROK	110 mm	200786	800 mm	285,29 €	OA	1



- Cassetta non inclusa >>p. 204,503
- Cabinet not included >>p. 204,503
- Casette pas inclus >>p. 204,503
- Kasten nicht enthalten >>p. 204,503
- Caja no incluida >>p. 204,503

- Versione 1"1/4 disponibile su richiesta.
- 1"1/4 version available on request.
- Version 1"1/4 disponible sur demande.
- 1"1/4 Ausführung auf Anfrage erhältlich.
- Versión de 1"1/4 disponible bajo pedido.

CI 590 C

- **Kit composto da collettore di mandata con detentori a doppia regolazione micrometrica, collettore di ritorno con valvole di intercettazione con cappuccio di protezione per vitone termostatico, staffe, valvole di carico/scarico, valvole di sfiato aria, tappi e attacchi EUROK.**
- *Kit made of flow manifold with double micrometric adjustment lockshields, return manifold with isolation valves with protection cap for thermostatic insert, brackets, filling/drainage valves, air vent valves, plugs and EUROK connections.*
- **Kit composé d'un collecteur d'envoi avec inserts à double réglage micrométrique, un collecteur de retour avec des vannes d'interception avec capuchon de protection pour insert thermostatique, étriers, robinets de remplissage/vidange, purgeurs d'air, bouchons et embouts EUROK.**
- *Bausatz besteht aus Zulauffusverteiler mit doppelfeinvorein Stellbareausgleichoberteile, Rücklaufverteiler mit Absperbareventile mit Schutzkappe für Thermostat-Regulievorrichtung, Haltebügel, Lade-/Entladeventilen, Entlüftungsventilen, Verschlüssen und EUROK Anschlüssen.*
- **Conjunto dotado de colector de impulsión con detentores de doble regulación micrométrica, colector de retorno con válvulas de cierre con tapa de protección para tornillo termostático, abrazaderas, válvulas para la carga/descarga, válvulas de purga de aire, tapones y conexiones EUROK.**

Code	Ways	Size	Depth	Suitable Cabinet	Cabinet width	Price	Class	Packaging
503282P80	2	1" x EUROK	80 mm	200086	500 mm	120,91 €	OB	1
503283P80	3	1" x EUROK	80 mm	200086	500 mm	149,47 €	OB	1
503284P80	4	1" x EUROK	80 mm	200086	500 mm	178,01 €	OB	1
503285P80	5	1" x EUROK	80 mm	200086	500 mm	206,55 €	OB	1
503286P80	6	1" x EUROK	80 mm	200086	500 mm	235,11 €	OB	1
503287P80	7	1" x EUROK	80 mm	200086	500 mm	263,66 €	OB	1
503288P80	8	1" x EUROK	80 mm	200686	600 mm	292,20 €	OB	1
503289P80	9	1" x EUROK	80 mm	200686	600 mm	320,75 €	OB	1
503290P80	10	1" x EUROK	80 mm	200186	700 mm	349,31 €	OB	1
503291P80	11	1" x EUROK	80 mm	200186	700 mm	377,84 €	OB	1
503292P80	12	1" x EUROK	80 mm	200786	800 mm	426,72 €	OB	1
503282	2	1" x EUROK	110 mm	200086	500 mm	120,91 €	OB	1
503283	3	1" x EUROK	110 mm	200086	500 mm	149,47 €	OB	1
503284	4	1" x EUROK	110 mm	200086	500 mm	178,01 €	OB	1
503285	5	1" x EUROK	110 mm	200086	500 mm	206,55 €	OB	1
503286	6	1" x EUROK	110 mm	200086	500 mm	235,11 €	OB	1
503287	7	1" x EUROK	110 mm	200086	500 mm	263,66 €	OB	1
503288	8	1" x EUROK	110 mm	200686	600 mm	292,20 €	OB	1
503289	9	1" x EUROK	110 mm	200686	600 mm	320,75 €	OB	1
503290	10	1" x EUROK	110 mm	200186	700 mm	349,31 €	OB	1
503291	11	1" x EUROK	110 mm	200186	700 mm	377,84 €	OB	1
503292	12	1" x EUROK	110 mm	200786	800 mm	426,72 €	OB	1



- **Cassette non inclusa >>p. 204,503**
- *Cabinet not included >>p. 204,503*
- **Cassette pas inclus >>p. 204,503**
- *Kasten nicht enthalten >>p. 204,503*
- **Caja no incluida >>p. 204,503**

- **Versione 1"1/4 disponibile su richiesta.**
- *1"1/4 version available on request.*
- **Version 1"1/4 disponible sur demande.**
- *1"1/4 Ausführung auf Anfrage erhältlich.*
- **Versión de 1"1/4 disponible bajo pedido.**

CI 588 C



- Kit composto da collettore di mandata con detentori a doppia regolazione micrometrica, collettore di ritorno con valvole di intercettazione con cappuccio di protezione per vitone termostatico, staffe e attacchi EUROK.
- Kit made of flow manifold with double micrometric adjustment lockshields, return manifold with isolation valves with protection cap for thermostatic insert, brackets and EUROK connections.
- Kit composé d'un collecteur d'envoi avec inserts à double réglage micrométrique, un collecteur de retour avec des vannes d'interception avec capuchon de protection pour insert thermostatique, étriers et embouts EUROK.
- Bausatz besteht aus Zulauffusverteiler mit doppelfeinvorein Stellbarenausgleicherteile, Rücklaufverteiler mit Absperbareventile mit Schutzkappe für Thermostat-Regulivorrichtung, Haltebügel und EUROK Anschlüssen.
- Conjunto dotado de colector de impulsión con detentores de doble regulación micrométrica, colector de retorno con válvulas de cierre con tapa de protección para tornillo termostático, abrazaderas y conexiones EUROK.

Code	Ways	Size	Depth	Suitable Cabinet	Cabinet width	Price	Class	Packaging
503572P80	2	1" x EUROK	80 mm	200086	500 mm	97,89 €	OB	1
503573P80	3	1" x EUROK	80 mm	200086	500 mm	125,35 €	OB	1
503574P80	4	1" x EUROK	80 mm	200086	500 mm	152,84 €	OB	1
503575P80	5	1" x EUROK	80 mm	200086	500 mm	180,31 €	OB	1
503576P80	6	1" x EUROK	80 mm	200086	500 mm	207,78 €	OB	1
503577P80	7	1" x EUROK	80 mm	200086	500 mm	235,23 €	OB	1
503578P80	8	1" x EUROK	80 mm	200086	500 mm	262,71 €	OB	1
503579P80	9	1" x EUROK	80 mm	200686	600 mm	290,18 €	OB	1
503580P80	10	1" x EUROK	80 mm	200686	600 mm	317,68 €	OB	1
503581P80	11	1" x EUROK	80 mm	200186	700 mm	345,14 €	OB	1
503582P80	12	1" x EUROK	80 mm	200186	700 mm	372,62 €	OB	1
503583P80	13	1" x EUROK	80 mm	200786	800 mm	421,14 €	OB	1
503572	2	1" x EUROK	110 mm	200086	500 mm	97,89 €	OB	1
503573	3	1" x EUROK	110 mm	200086	500 mm	125,35 €	OB	1
503574	4	1" x EUROK	110 mm	200086	500 mm	152,84 €	OB	1
503575	5	1" x EUROK	110 mm	200086	500 mm	180,31 €	OB	1
503576	6	1" x EUROK	110 mm	200086	500 mm	207,78 €	OB	1
503577	7	1" x EUROK	110 mm	200086	500 mm	235,23 €	OB	1
503578	8	1" x EUROK	110 mm	200086	500 mm	262,71 €	OB	1
503579	9	1" x EUROK	110 mm	200686	600 mm	290,18 €	OB	1
503580	10	1" x EUROK	110 mm	200686	600 mm	317,68 €	OB	1
503581	11	1" x EUROK	110 mm	200186	700 mm	345,14 €	OB	1
503582	12	1" x EUROK	110 mm	200186	700 mm	372,62 €	OB	1
503583	13	1" x EUROK	110 mm	200786	800 mm	421,14 €	OB	1



- Cassetta non inclusa >>p. 204,503
- Cabinet not included >>p. 204,503
- Casette pas inclus >>p. 204,503
- Kasten nicht enthalten >>p. 204,503
- Caja no incluida >>p. 204,503

- Versione 1"1/4 disponibile su richiesta.
- 1"1/4 version available on request.
- Version 1"1/4 disponible sur demande.
- 1"1/4 Ausführung auf Anfrage erhältlich.
- Versión de 1"1/4 disponible bajo pedido.

CI 585 C

- Kit composto da collettore di mandata con detentori a doppia regolazione micrometrica, collettore di ritorno con valvole di intercettazione con cappuccio di protezione per vite termostatico, staffe, attacchi supplementari per valvole di carico/scarico e valvole di sfogo aria, attacchi EUROK.
- Kit made of flow manifold with double micrometric adjustment lockshields, return manifold with isolation valves with protection cap for thermostatic insert, brackets, additional connections for filling/drainage valves and air vent valves, EUROK connections.
- Kit composé d'un collecteur d'envoi avec inserts à double réglage micrométrique, un collecteur de retour avec des vannes d'interception avec capuchon de protection pour insert thermostatique, étriers, embouts supplémentaires pour robinets de remplissage/vidange et purgeurs d'air, embouts EUROK.
- Bausatz besteht aus Zulauffusverteiler mit doppelfeinvorein Stellbareausgleichoberteile, Rücklaufverteiler mit Absperbareventile mit Schutzkappe für Thermostat-Regulievorrichtung, Haltebügel, zusätzliche Anschlüsse für Lade-/Entladeventile und Entlüftungsventile, EUROK Anschlüssen.
- Conjunto dotado de colector de impulsión con detentores de doble regulación micrométrica, colector de retorno con válvulas de cierre con tapa de protección para tornillo termostático, abrazaderas, conexiones adicionales para válvulas para la carga/descarga y válvulas de purga de aire, conexiones EUROK.

Code	Ways	Size	Depth	Suitable Cabinet	Cabinet width	Price	Class	Packaging
503522P80	2	1" x EUROK	80 mm	200086	500 mm	100,51 €	OB	1
503523P80	3	1" x EUROK	80 mm	200086	500 mm	129,06 €	OB	1
503524P80	4	1" x EUROK	80 mm	200086	500 mm	157,61 €	OB	1
503525P80	5	1" x EUROK	80 mm	200086	500 mm	186,14 €	OB	1
503526P80	6	1" x EUROK	80 mm	200086	500 mm	214,71 €	OB	1
503527P80	7	1" x EUROK	80 mm	200086	500 mm	243,26 €	OB	1
503528P80	8	1" x EUROK	80 mm	200686	600 mm	271,79 €	OB	1
503529P80	9	1" x EUROK	80 mm	200686	600 mm	300,35 €	OB	1
503530P80	10	1" x EUROK	80 mm	200186	700 mm	328,90 €	OB	1
503531P80	11	1" x EUROK	80 mm	200186	700 mm	357,45 €	OB	1
503532P80	12	1" x EUROK	80 mm	200786	800 mm	406,33 €	OB	1
503522	2	1" x EUROK	110 mm	200086	500 mm	100,51 €	OB	1
503523	3	1" x EUROK	110 mm	200086	500 mm	129,06 €	OB	1
503524	4	1" x EUROK	110 mm	200086	500 mm	157,61 €	OB	1
503525	5	1" x EUROK	110 mm	200086	500 mm	186,14 €	OB	1
503526	6	1" x EUROK	110 mm	200086	500 mm	214,71 €	OB	1
503527	7	1" x EUROK	110 mm	200086	500 mm	243,26 €	OB	1
503528	8	1" x EUROK	110 mm	200686	600 mm	271,79 €	OB	1
503529	9	1" x EUROK	110 mm	200686	600 mm	300,35 €	OB	1
503530	10	1" x EUROK	110 mm	200186	700 mm	328,90 €	OB	1
503531	11	1" x EUROK	110 mm	200186	700 mm	357,45 €	OB	1
503532	12	1" x EUROK	110 mm	200786	800 mm	406,33 €	OB	1



- Cassetta non inclusa >>p. 204,503
- Cabinet not included >>p. 204,503
- Casette pas inclus >>p. 204,503
- Kasten nicht enthalten >>p. 204,503
- Caja no incluida >>p. 204,503

- Versione 1"1/4 disponibile su richiesta.
- 1"1/4 version available on request.
- Version 1"1/4 disponible sur demande.
- 1"1/4 Ausführung auf Anfrage erhältlich.
- Versión de 1"1/4 disponible bajo pedido.

CI 591 C



- Kit composto da collettore di mandata con detentori a doppia regolazione micrometrica, collettore di ritorno con valvole di intercettazione con cappuccio di protezione per vitone termostatico, staffe, terminali, valvole di carico/scarico, valvole di sfiato aria e attacchi EUROK.
- Kit made of flow manifold with double micrometric adjustment lockshields, return manifold with isolation valves with protection cap for thermostatic insert, brackets, terminals, filling/drainage valves, air vent valves and EUROK connections.
- Kit composé d'un collecteur d'envoi avec inserts à double réglage micrométrique, un collecteur de retour avec des vannes d'interception avec capuchon de protection pour insert thermostatique, étriers, parties terminales, robinets de remplissage/vidange, purgeurs d'air et embouts EUROK.
- Bausatz besteht aus Zulauffusverteiler mit doppelfeinvorein Stellbareausgleichoberteile, Rücklaufverteiler mit Absperbareventile mit Schutzkappe für Thermostat-Regulievorrichtung, Haltebügel, Endstücke, Lade-/Entladeventilen, Entlüftungsventilen und EUROK Anschlüssen.
- Conjunto dotado de colector de impulsión con detentores de doble regulación micrométrica, colector de retorno con válvulas de cierre con tapa de protección para tornillo termostático, abrazaderas, terminales, válvulas para la carga/descarga, válvulas de purga de aire y conexiones EUROK.

Code	Ways	Size	Depth	Suitable Cabinet	Cabinet width	Price	Class	Packaging
503222P80	2	1" x EUROK	80 mm	200086	500 mm	128,92 €	OB	1
503223P80	3	1" x EUROK	80 mm	200086	500 mm	156,40 €	OB	1
503224P80	4	1" x EUROK	80 mm	200086	500 mm	183,88 €	OB	1
503225P80	5	1" x EUROK	80 mm	200686	600 mm	211,37 €	OB	1
503226P80	6	1" x EUROK	80 mm	200686	600 mm	238,83 €	OB	1
503227P80	7	1" x EUROK	80 mm	200186	700 mm	266,28 €	OB	1
503228P80	8	1" x EUROK	80 mm	200186	700 mm	293,75 €	OB	1
503229P80	9	1" x EUROK	80 mm	200786	800 mm	321,25 €	OB	1
503230P80	10	1" x EUROK	80 mm	200786	800 mm	348,72 €	OB	1
503231P80	11	1" x EUROK	80 mm	200286	900 mm	376,19 €	OB	1
503232P80	12	1" x EUROK	80 mm	200286	900 mm	403,66 €	OB	1
503233P80	13	1" x EUROK	80 mm	200886	1000 mm	452,19 €	OB	1
503222	2	1" x EUROK	110 mm	200086	500 mm	128,92 €	OB	1
503223	3	1" x EUROK	110 mm	200086	500 mm	156,40 €	OB	1
503224	4	1" x EUROK	110 mm	200086	500 mm	183,88 €	OB	1
503225	5	1" x EUROK	110 mm	200686	600 mm	211,37 €	OB	1
503226	6	1" x EUROK	110 mm	200686	600 mm	238,83 €	OB	1
503227	7	1" x EUROK	110 mm	200186	700 mm	266,28 €	OB	1
503228	8	1" x EUROK	110 mm	200186	700 mm	293,75 €	OB	1
503229	9	1" x EUROK	110 mm	200786	800 mm	321,25 €	OB	1
503230	10	1" x EUROK	110 mm	200786	800 mm	348,72 €	OB	1
503231	11	1" x EUROK	110 mm	200286	900 mm	376,19 €	OB	1
503232	12	1" x EUROK	110 mm	200286	900 mm	403,66 €	OB	1
503233	13	1" x EUROK	110 mm	200886	1000 mm	452,19 €	OB	1



- Cassetta non inclusa >>p. 204,503
- Cabinet not included >>p. 204,503
- Casette pas inclus >>p. 204,503
- Kasten nicht enthalten >>p. 204,503
- Caja no incluida >>p. 204,503

- Versione 1"1/4 disponibile su richiesta.
- 1"1/4 version available on request.
- Version 1"1/4 disponible sur demande.
- 1"1/4 Ausführung auf Anfrage erhältlich.
- Versión de 1"1/4 disponible bajo pedido.

CI 587 C

0-2,5 l/min ON REQUEST

- Kit composto da collettore di mandata con misuratori/regolatori di portata FLUXER (0-5 l/min), collettore di ritorno con valvole di intercettazione con cappuccio di protezione per vitone termostatico, staffe, valvole di carico/scarico, valvole di sfiato aria, tappi e attacchi EUROK.
- Kit made of flow manifold with flow meters/adjusters FLUXER (0-5 l/min), return manifold with isolation valves with protection cap for thermostatic insert, brackets, filling/drainage valves, air vent valves, plugs and EUROK connections.
- Kit composé d'un collecteur d'envoi avec débit-mètres/régulateurs FLUXER (0-5 l/min), un collecteur de retour avec des vannes d'interception avec capuchon de protection pour insert thermostatique, étriers, robinets de remplissage/vidange, purgeurs d'air, bouchons et embouts EUROK.
- Bausatz besteht aus Zulauffusverteiler mit Durchflussmengenmesser FLUXER (0-5 l/min), Rücklaufverteiler mit Absperbareventile mit Schutzkappe für Thermostat-Regulievorrichtung, Haltebügel, Lade-/Entladeventilen, Entlüftungsventilen, Verschlüssen und EUROK Anschlüssen.
- Conjunto dotado de colector de impulsión con medidores/reguladores de caudal FLUXER (0-5 l/min), colector de retorno con válvulas de cierre con tapa de protección para tornillo termostático, abrazaderas, válvulas para la carga/descarga, válvulas de purga de aire, tapones y conexiones EUROK.

Code	Ways	Size	Depth	Suitable Cabinet	Cabinet width	Price	Class	Packaging
503262P80	2	1" x EUROK	80 mm	200086	500 mm	143,98 €	OB	1
503263P80	3	1" x EUROK	80 mm	200086	500 mm	181,59 €	OB	1
503264P80	4	1" x EUROK	80 mm	200086	500 mm	219,20 €	OB	1
503265P80	5	1" x EUROK	80 mm	200086	500 mm	256,80 €	OB	1
503266P80	6	1" x EUROK	80 mm	200086	500 mm	294,41 €	OB	1
503267P80	7	1" x EUROK	80 mm	200086	500 mm	332,03 €	OB	1
503268P80	8	1" x EUROK	80 mm	200686	600 mm	369,62 €	OB	1
503269P80	9	1" x EUROK	80 mm	200686	600 mm	407,23 €	OB	1
503270P80	10	1" x EUROK	80 mm	200186	700 mm	444,84 €	OB	1
503271P80	11	1" x EUROK	80 mm	200186	700 mm	482,43 €	OB	1
503272P80	12	1" x EUROK	80 mm	200786	800 mm	542,75 €	OB	1
503262	2	1" x EUROK	110 mm	200086	500 mm	143,98 €	OB	1
503263	3	1" x EUROK	110 mm	200086	500 mm	181,59 €	OB	1
503264	4	1" x EUROK	110 mm	200086	500 mm	219,20 €	OB	1
503265	5	1" x EUROK	110 mm	200086	500 mm	256,80 €	OB	1
503266	6	1" x EUROK	110 mm	200086	500 mm	294,41 €	OB	1
503267	7	1" x EUROK	110 mm	200086	500 mm	332,03 €	OB	1
503268	8	1" x EUROK	110 mm	200686	600 mm	369,62 €	OB	1
503269	9	1" x EUROK	110 mm	200686	600 mm	407,23 €	OB	1
503270	10	1" x EUROK	110 mm	200186	700 mm	444,84 €	OB	1
503271	11	1" x EUROK	110 mm	200186	700 mm	482,43 €	OB	1
503272	12	1" x EUROK	110 mm	200786	800 mm	542,75 €	OB	1



- Cassetta non inclusa >>p. 204,503
- Cabinet not included >>p. 204,503
- Casette pas inclus >>p. 204,503
- Kasten nicht enthalten >>p. 204,503
- Caja no incluida >>p. 204,503

- Versione 1"1/4 disponibile su richiesta.
- 1"1/4 version available on request.
- Version 1"1/4 disponible sur demande.
- 1"1/4 Ausführung auf Anfrage erhältlich.
- Versión de 1"1/4 disponible bajo pedido.

CI 589 C



0-2,5 l/min ON REQUEST

- Kit composto da collettore di mandata con misuratori/regolatori di portata FLUXER (0-5 l/min), collettore di ritorno con valvole di intercettazione con cappuccio di protezione per vitone termostatico, staffe e attacchi EUROK.
- Kit made of flow manifold with flow meters/adjusters FLUXER (0-5 l/min), return manifold with isolation valves with protection cap for thermostatic insert, brackets and EUROK connections.
- Kit composé d'un collecteur d'envoi avec débit-mètres/régulateurs FLUXER (0-5 l/min), un collecteur de retour avec des vannes d'interception avec capuchon de protection pour insert thermostatique, étriers et embouts EUROK.
- Bausatz besteht aus Zulaufverteiler mit Durchflussmengenmesser FLUXER (0-5 l/min), Rücklaufverteiler mit Absperbareventile mit Schutzkappe für Thermostat-Regulievorrichtung, Haltebügel und EUROK Anschließen.
- Conjunto dotado de colector de impulsión con medidores/reguladores de caudal FLUXER (0-5 l/min), colector de retorno con válvulas de cierre con tapa de protección para tornillo termostático, abrazaderas y conexiones EUROK.

Code	Ways	Size	Depth	Suitable Cabinet	Cabinet width	Price	Class	Packaging
503202P80	2	1" x EUROK	80 mm	200086	500 mm	120,98 €	OB	1
503203P80	3	1" x EUROK	80 mm	200086	500 mm	157,50 €	OB	1
503204P80	4	1" x EUROK	80 mm	200086	500 mm	194,03 €	OB	1
503205P80	5	1" x EUROK	80 mm	200086	500 mm	230,58 €	OB	1
503206P80	6	1" x EUROK	80 mm	200086	500 mm	267,06 €	OB	1
503207P80	7	1" x EUROK	80 mm	200086	500 mm	303,60 €	OB	1
503208P80	8	1" x EUROK	80 mm	200086	500 mm	340,13 €	OB	1
503209P80	9	1" x EUROK	80 mm	200686	600 mm	376,65 €	OB	1
503210P80	10	1" x EUROK	80 mm	200686	600 mm	413,18 €	OB	1
503211P80	11	1" x EUROK	80 mm	200186	700 mm	449,72 €	OB	1
503212P80	12	1" x EUROK	80 mm	200186	700 mm	488,63 €	OB	1
503213P80	13	1" x EUROK	80 mm	200786	800 mm	548,95 €	OB	1
503202	2	1" x EUROK	110 mm	200086	500 mm	120,98 €	OB	1
503203	3	1" x EUROK	110 mm	200086	500 mm	157,50 €	OB	1
503204	4	1" x EUROK	110 mm	200086	500 mm	194,03 €	OB	1
503205	5	1" x EUROK	110 mm	200086	500 mm	230,58 €	OB	1
503206	6	1" x EUROK	110 mm	200086	500 mm	267,06 €	OB	1
503207	7	1" x EUROK	110 mm	200086	500 mm	303,60 €	OB	1
503208	8	1" x EUROK	110 mm	200086	500 mm	340,13 €	OB	1
503209	9	1" x EUROK	110 mm	200686	600 mm	376,65 €	OB	1
503210	10	1" x EUROK	110 mm	200686	600 mm	413,18 €	OB	1
503211	11	1" x EUROK	110 mm	200186	700 mm	449,72 €	OB	1
503212	12	1" x EUROK	110 mm	200186	700 mm	488,63 €	OB	1
503213	13	1" x EUROK	110 mm	200786	800 mm	548,95 €	OB	1
514202	2	1"1/4 x EUROK	110 mm	200086	500 mm	133,16 €	OB	1
514203	3	1"1/4 x EUROK	110 mm	200086	500 mm	179,01 €	OB	1
514204	4	1"1/4 x EUROK	110 mm	200086	500 mm	224,88 €	OB	1
514205	5	1"1/4 x EUROK	110 mm	200086	500 mm	270,73 €	OB	1
514206	6	1"1/4 x EUROK	110 mm	200086	500 mm	316,58 €	OB	1
514207	7	1"1/4 x EUROK	110 mm	200086	500 mm	362,44 €	OB	1
514208	8	1"1/4 x EUROK	110 mm	200086	500 mm	408,29 €	OB	1
514209	9	1"1/4 x EUROK	110 mm	200686	600 mm	454,15 €	OB	1
514210	10	1"1/4 x EUROK	110 mm	200686	600 mm	500,01 €	OB	1
514211	11	1"1/4 x EUROK	110 mm	200186	700 mm	545,86 €	OB	1
514212	12	1"1/4 x EUROK	110 mm	200186	700 mm	591,71 €	OB	1
514213	13	1"1/4 x EUROK	110 mm	200786	800 mm	637,57 €	OB	1



- Cassetta non inclusa >> p. 204,503
- Cabinet not included >> p. 204,503
- Casette pas inclus >> p. 204,503
- Kasten nicht enthalten >> p. 204,503
- Caja no incluida >> p. 204,503

CI 586 C

0-2,5 l/min ON REQUEST

- Kit composto da collettore di mandata con misuratori/regolatori di portata FLUXER (0-5 l/min), collettore di ritorno con valvole di intercettazione con cappuccio di protezione per vitone termostatico, staffe, attacchi supplementari per valvole di carico/scarico e valvole di sfiato aria, attacchi EUROK.
- Kit made of flow manifold with flow meters/adjusters FLUXER (0-5 l/min), return manifold with isolation valves with protection cap for thermostatic insert, brackets, additional connections for filling/drainage valves and air vent valves, EUROK connections.
- Kit composé d'un collecteur d'envoi avec débit-mètres/régulateurs FLUXER (0-5 l/min), un collecteur de retour avec des vannes d'interception avec capuchon de protection pour insert thermostatique, étriers, embouts supplémentaires pour robinets de remplissage/vidange et purgeurs d'air, embouts EUROK.
- Bausatz besteht aus Zulauffusverteiler mit Durchflussmengenmesser FLUXER (0-5 l/min), Rücklaufverteiler mit Absperrbarenventile mit Schutzkappe für Thermostat-Regulievorrichtung, Haltebügel, zusätzliche Anschlüsse für Lade-/Entladeventile und Entlüftungsventile, EUROK Anschlüsse.
- Conjunto dotado de colector de impulsión con medidores/reguladores de caudal FLUXER (0-5 l/min), colector de retorno con válvulas de cierre con tapa de protección para tornillo termostático, abrazaderas, conexiones adicionales para válvulas para la carga/descarga y válvulas de purga de aire, conexiones EUROK.

Code	Ways	Size	Depth	Suitable Cabinet	Cabinet width	Price	Class	Packaging
503542P80	2	1" x EUROK	80 mm	200086	500 mm	123,58 €	OB	1
503543P80	3	1" x EUROK	80 mm	200086	500 mm	161,19 €	OB	1
503544P80	4	1" x EUROK	80 mm	200086	500 mm	198,79 €	OB	1
503545P80	5	1" x EUROK	80 mm	200086	500 mm	236,40 €	OB	1
503546P80	6	1" x EUROK	80 mm	200086	500 mm	274,01 €	OB	1
503547P80	7	1" x EUROK	80 mm	200086	500 mm	311,62 €	OB	1
503548P80	8	1" x EUROK	80 mm	200686	600 mm	349,23 €	OB	1
503549P80	9	1" x EUROK	80 mm	200686	600 mm	386,82 €	OB	1
503550P80	10	1" x EUROK	80 mm	200186	700 mm	424,44 €	OB	1
503551P80	11	1" x EUROK	80 mm	200186	700 mm	462,02 €	OB	1
503552P80	12	1" x EUROK	80 mm	200786	800 mm	522,35 €	OB	1
503542	2	1" x EUROK	110 mm	200086	500 mm	123,58 €	OB	1
503543	3	1" x EUROK	110 mm	200086	500 mm	161,19 €	OB	1
503544	4	1" x EUROK	110 mm	200086	500 mm	198,79 €	OB	1
503545	5	1" x EUROK	110 mm	200086	500 mm	236,40 €	OB	1
503546	6	1" x EUROK	110 mm	200086	500 mm	274,01 €	OB	1
503547	7	1" x EUROK	110 mm	200086	500 mm	311,62 €	OB	1
503548	8	1" x EUROK	110 mm	200686	600 mm	349,23 €	OB	1
503549	9	1" x EUROK	110 mm	200686	600 mm	386,82 €	OB	1
503550	10	1" x EUROK	110 mm	200186	700 mm	424,44 €	OB	1
503551	11	1" x EUROK	110 mm	200186	700 mm	462,02 €	OB	1
503552	12	1" x EUROK	110 mm	200786	800 mm	522,35 €	OB	1
514222	2	1"1/4 x EUROK	110 mm	200086	500 mm	131,29 €	OB	1
514223	3	1"1/4 x EUROK	110 mm	200086	500 mm	176,89 €	OB	1
514224	4	1"1/4 x EUROK	110 mm	200086	500 mm	222,51 €	OB	1
514225	5	1"1/4 x EUROK	110 mm	200086	500 mm	268,12 €	OB	1
514226	6	1"1/4 x EUROK	110 mm	200086	500 mm	313,71 €	OB	1
514227	7	1"1/4 x EUROK	110 mm	200086	500 mm	359,31 €	OB	1
514228	8	1"1/4 x EUROK	110 mm	200686	600 mm	404,91 €	OB	1
514229	9	1"1/4 x EUROK	110 mm	200686	600 mm	450,52 €	OB	1
514230	10	1"1/4 x EUROK	110 mm	200186	700 mm	496,14 €	OB	1
514231	11	1"1/4 x EUROK	110 mm	200186	700 mm	541,73 €	OB	1
514232	12	1"1/4 x EUROK	110 mm	200786	800 mm	587,33 €	OB	1



- Cassetta non inclusa >>p. 204,503
- Cabinet not included >>p. 204,503
- Casette pas inclus >>p. 204,503
- Kasten nicht enthalten >>p. 204,503
- Caja no incluida >>p. 204,503

CI 592 C



0-2,5 l/min ON REQUEST

- Kit composto da collettore di mandata con misuratori/regolatori di portata FLUXER (0-5 l/min), collettore di ritorno con valvole di intercettazione con cappuccio di protezione per vitone termostatico, staffe, terminali, valvole di carico/scarico, valvole di sfiato aria e attacchi EUROK.
- Kit made of flow manifold with flow meters/adjusters FLUXER (0-5 l/min), return manifold with isolation valves with protection cap for thermostatic insert, brackets, terminals, filling/drainage valves, air vent valves and EUROK connections.
- Kit composé d'un collecteur d'envoi avec débit-mètres/régulateurs FLUXER (0-5 l/min), un collecteur de retour avec des vannes d'interception avec capuchon de protection pour insert thermostatique, étriers, parties terminales, robinets de remplissage/vidange, purgeurs d'air et embouts EUROK.
- Bausatz besteht aus Zulauffusverteiler mit Durchflussmengenmesser FLUXER (0-5 l/min), Rücklaufverteiler mit Absperbareventile mit Schutzkappe für Thermostat-Regulievorrichtung, Haltebügel, Endstücke, Lade-/Entladeventilen, Entlüftungsventilen und EUROK Anschlüssen.
- Conjunto dotado de colector de impulsión con medidores/reguladores de caudal FLUXER (0-5 l/min), colector de retorno con válvulas de cierre con tapa de protección para tornillo termostático, abrazaderas, terminales, válvulas para la carga/descarga, válvulas de purga de aire y conexiones EUROK.

Code	Ways	Size	Depth	Suitable Cabinet	Cabinet width	Price	Class	Packaging
503242P80	2	1" x EUROK	80 mm	200086	500 mm	152,02 €	OB	1
503243P80	3	1" x EUROK	80 mm	200086	500 mm	188,55 €	OB	1
503244P80	4	1" x EUROK	80 mm	200086	500 mm	225,06 €	OB	1
503245P80	5	1" x EUROK	80 mm	200686	600 mm	261,61 €	OB	1
503246P80	6	1" x EUROK	80 mm	200686	600 mm	298,13 €	OB	1
503247P80	7	1" x EUROK	80 mm	200186	700 mm	334,65 €	OB	1
503248P80	8	1" x EUROK	80 mm	200186	700 mm	371,18 €	OB	1
503249P80	9	1" x EUROK	80 mm	200786	800 mm	407,72 €	OB	1
503250P80	10	1" x EUROK	80 mm	200786	800 mm	444,25 €	OB	1
503251P80	11	1" x EUROK	80 mm	200286	900 mm	480,78 €	OB	1
503252P80	12	1" x EUROK	80 mm	200286	900 mm	519,68 €	OB	1
503253P80	13	1" x EUROK	80 mm	200886	1000 mm	580,01 €	OB	1
503242	2	1" x EUROK	110 mm	200086	500 mm	152,02 €	OB	1
503243	3	1" x EUROK	110 mm	200086	500 mm	188,55 €	OB	1
503244	4	1" x EUROK	110 mm	200086	500 mm	225,06 €	OB	1
503245	5	1" x EUROK	110 mm	200686	600 mm	261,61 €	OB	1
503246	6	1" x EUROK	110 mm	200686	600 mm	298,13 €	OB	1
503247	7	1" x EUROK	110 mm	200186	700 mm	334,65 €	OB	1
503248	8	1" x EUROK	110 mm	200186	700 mm	371,18 €	OB	1
503249	9	1" x EUROK	110 mm	200786	800 mm	407,72 €	OB	1
503250	10	1" x EUROK	110 mm	200786	800 mm	444,25 €	OB	1
503251	11	1" x EUROK	110 mm	200286	900 mm	480,78 €	OB	1
503252	12	1" x EUROK	110 mm	200286	900 mm	519,68 €	OB	1
503253	13	1" x EUROK	110 mm	200886	1000 mm	580,01 €	OB	1



- Cassetta non inclusa >>p. 204,503
- Cabinet not included >>p. 204,503
- Casette pas inclus >>p. 204,503
- Kasten nicht enthalten >>p. 204,503
- Caja no incluida >>p. 204,503

- Versione 1"1/4 disponibile su richiesta.
- 1"1/4 version available on request.
- Version 1"1/4 disponible sur demande.
- 1"1/4 Ausführung auf Anfrage erhältlich.
- Versión de 1"1/4 disponible bajo pedido.

CI 592 KC (1")

0-2,5 l/min ON REQUEST

- Kit composto da collettore di mandata con misuratori/regolatori di portata FLUXER (0-5 l/min), collettore di ritorno con valvole di intercettazione con cappuccio di protezione per vitone termostatico, staffe, terminali, valvole di carico/scarico, valvole di sfiato aria e attacchi EUROK.
- Kit made of flow manifold with flow meters/adjusters FLUXER (0-5 l/min), return manifold with isolation valves with protection cap for thermostatic insert, brackets, terminals, filling/drainage valves, air vent valves and EUROK connections.
- Kit composé d'un collecteur d'envoi avec débit-mètres/régulateurs FLUXER (0-5 l/min), un collecteur de retour avec des vannes d'interception avec capuchon de protection pour insert thermostatique, étriers, parties terminales, robinets de remplissage/vidange, purgeurs d'air et embouts EUROK.
- Bausatz besteht aus Zulauffusverteiler mit Durchflussmengenmesser FLUXER (0-5 l/min), Rücklaufverteiler mit Absperbareventile mit Schutzkappe für Thermostat-Regulievorrichtung, Haltebügel, Endstücke, Lade-/Entladeventilen, Entlüftungsventilen und EUROK Anschlüssen.
- Conjunto dotado de colector de impulsión con medidores/reguladores de caudal FLUXER (0-5 l/min), colector de retorno con válvulas de cierre con tapa de protección para tornillo termostático, abrazaderas, terminales, válvulas para la carga/descarga, válvulas de purga de aire y conexiones EUROK.

Code	Ways	Size	Depth	Suitable Cabinet	Cabinet width	Price	Class	Packaging
503242KC	2	1" x EUROK	80 mm	200086	500 mm	162,27 €	OB	1
503243KC	3	1" x EUROK	80 mm	200086	500 mm	198,80 €	OB	1
503244KC	4	1" x EUROK	80 mm	200086	500 mm	235,35 €	OB	1
503245KC	5	1" x EUROK	80 mm	200686	600 mm	271,87 €	OB	1
503246KC	6	1" x EUROK	80 mm	200686	600 mm	308,39 €	OB	1
503247KC	7	1" x EUROK	80 mm	200186	700 mm	344,90 €	OB	1
503248KC	8	1" x EUROK	80 mm	200186	700 mm	381,43 €	OB	1
503249KC	9	1" x EUROK	80 mm	200786	800 mm	417,98 €	OB	1
503250KC	10	1" x EUROK	80 mm	200786	800 mm	454,50 €	OB	1
503251KC	11	1" x EUROK	80 mm	200286	900 mm	491,03 €	OB	1
503252KC	12	1" x EUROK	80 mm	200286	900 mm	529,96 €	OB	1
503253KC	13	1" x EUROK	80 mm	200886	1000 mm	590,27 €	OB	1

CI 592 KC (1"1/4)

0-2,5 l/min ON REQUEST

- Kit composto da collettore di mandata con misuratori/regolatori di portata FLUXER (0-5 l/min), collettore di ritorno con valvole di intercettazione con cappuccio di protezione per vitone termostatico, staffe, valvole di carico/scarico, valvole di sfiato aria, tappi e attacchi EUROK.
- Kit made of flow manifold with flow meters/adjusters FLUXER (0-5 l/min), return manifold with isolation valves with protection cap for thermostatic insert, brackets, filling/drainage valves, air vent valves, plugs and EUROK connections.
- Kit composé d'un collecteur d'envoi avec débit-mètres/régulateurs FLUXER (0-5 l/min), un collecteur de retour avec des vannes d'interception avec capuchon de protection pour insert thermostatique, étriers, robinets de remplissage/vidange, purgeurs d'air, bouchons et embouts EUROK.
- Bausatz besteht aus Zulauffusverteiler mit Durchflussmengenmesser FLUXER (0-5 l/min), Rücklaufverteiler mit Absperbareventile mit Schutzkappe für Thermostat-Regulievorrichtung, Haltebügel, Lade-/Entladeventilen, Entlüftungsventilen, Verschlüssen und EUROK Anschlüssen.
- Conjunto dotado de colector de impulsión con medidores/reguladores de caudal FLUXER (0-5 l/min), colector de retorno con válvulas de cierre con tapa de protección para tornillo termostático, abrazaderas, válvulas para la carga/ descarga, válvulas de purga de aire, tapones y conexiones EUROK.

Code	Ways	Size	Depth	Suitable Cabinet	Cabinet width	Price	Class	Packaging
514242KC	2	1"1/4 x EUROK	110 mm	200086	500 mm	169,50 €	OB	1
514243KC	3	1"1/4 x EUROK	110 mm	200086	500 mm	215,10 €	OB	1
514244KC	4	1"1/4 x EUROK	110 mm	200086	500 mm	260,71 €	OB	1
514245KC	5	1"1/4 x EUROK	110 mm	200686	600 mm	306,32 €	OB	1
514246KC	6	1"1/4 x EUROK	110 mm	200686	600 mm	351,92 €	OB	1
514247KC	7	1"1/4 x EUROK	110 mm	200186	700 mm	397,51 €	OB	1
514248KC	8	1"1/4 x EUROK	110 mm	200186	700 mm	443,12 €	OB	1
514249KC	9	1"1/4 x EUROK	110 mm	200786	800 mm	488,73 €	OB	1
514250KC	10	1"1/4 x EUROK	110 mm	200786	800 mm	534,33 €	OB	1
514251KC	11	1"1/4 x EUROK	110 mm	200286	900 mm	579,94 €	OB	1
514252KC	12	1"1/4 x EUROK	110 mm	200286	900 mm	625,53 €	OB	1



- Cassetta non inclusa >> p. 204,503
- Cabinet not included >> p. 204,503
- Casette pas inclus >> p. 204,503
- Kasten nicht enthalten >> p. 204,503
- Caja no incluida >> p. 204,503

KCA 02 A (1")



0-2.5 l/min ON REQUEST

- Kit composto da collettore di mandata con misuratori/regolatori di portata FLUXER (0-5 l/min), collettore di ritorno con valvole di intercettazione con cappuccio di protezione per vitone termostatico, staffe, valvole a sfera diritte con bocchettone, termometri, terminali, valvole di carico/scarico, valvole di sfiato aria e attacchi EUROK.
- Kit made of flow manifold with flow meters/adjusters FLUXER (0-5 l/min), return manifold with isolation valves with protection cap for thermostatic insert, brackets, straight ball valves with fitting, thermometers, terminals, filling/drainage valves, air vent valves and EUROK connections.
- Kit composé d'un collecteur d'envoi avec débit-mètres/régulateurs FLUXER (0-5 l/min), un collecteur de retour avec des vannes d'interception avec capuchon de protection pour insert thermostatique, étriers, vannes à bille droites avec raccord, thermomètres, parties terminales, robinets de remplissage/vidange, purgeurs d'air et embouts EUROK.
- Bausatz besteht aus Zulaufverteiler mit Durchflussmengenmesser FLUXER (0-5 l/min), Rücklaufverteiler mit Absperbareventilen mit Schutzkappe für Thermostat-Regulievorrichtung, Haltebügel, Durchgangs-Kugelventilen mit Verschraubung, Thermometer, Endstücke, Lade-/Entladeventilen, Entlüftungsventilen und EUROK Anschlüssen.
- Conjunto dotado de colector de impulsión con medidores/reguladores de caudal FLUXER (0-5 l/min), colector de retorno con válvulas de cierre con tapa de protección para tornillo termostático, abrazaderas, válvulas de bola rectas con manguito de unión, termómetros, terminales, válvulas para la carga/descarga, válvulas de purga de aire y conexiones EUROK.

Code	Ways	Size	Depth	Suitable Cabinet	Cabinet width	Price	Class	Packaging
503202AIV	2	1" x EUROK	80 mm	200086	500 mm	277,93 €	OB	1
503203AIV	3	1" x EUROK	80 mm	200086	500 mm	314,47 €	OB	1
503204AIV	4	1" x EUROK	80 mm	200086	500 mm	351,01 €	OB	1
503205AIV	5	1" x EUROK	80 mm	200686	600 mm	387,53 €	OB	1
503206AIV	6	1" x EUROK	80 mm	200686	600 mm	424,06 €	OB	1
503207AIV	7	1" x EUROK	80 mm	200186	700 mm	460,59 €	OB	1
503208AIV	8	1" x EUROK	80 mm	200186	700 mm	497,11 €	OB	1
503209AIV	9	1" x EUROK	80 mm	200786	800 mm	533,65 €	OB	1
503210AIV	10	1" x EUROK	80 mm	200786	800 mm	570,19 €	OB	1
503211AIV	11	1" x EUROK	80 mm	200286	900 mm	606,71 €	OB	1
503212AIV	12	1" x EUROK	80 mm	200286	900 mm	645,64 €	OB	1
503213AIV	13	1" x EUROK	80 mm	200886	1000 mm	705,96 €	OB	1



- Cassetta non inclusa >>p. 204,503
- Cabinet not included >>p. 204,503
- Casette pas inclus >>p. 204,503
- Kasten nicht enthalten >>p. 204,503
- Caja no incluida >>p. 204,503

- Versione 1"1/4 disponibile su richiesta.
- 1"1/4 version available on request.
- Version 1"1/4 disponible sur demande.
- 1"1/4 Ausführung auf Anfrage erhältlich.
- Versión de 1"1/4 disponible bajo pedido.

KCA 02 AS (1")

0-2,5 l/min ON REQUEST

- Kit composto da collettore di mandata con misuratori/regolatori di portata FLUXER (0-5 l/min), collettore di ritorno con valvole di intercettazione con cappuccio di protezione per vitone termostatico, staffe, valvole a sfera a squadra con bocchettone, termometri, terminali, valvole di carico/ scarico, valvole di sfiato aria e attacchi EUROK.
- Kit made of flow manifold with flow meters/adjusters FLUXER (0-5 l/min), return manifold with isolation valves with protection cap for thermostatic insert, brackets, square ball valves with fitting, thermometers, terminals, filling/drainage valves, air vent valves and EUROK connections.
- Kit composé d'un collecteur d'envoi avec débit-mètres/régulateurs FLUXER (0-5 l/min), un collecteur de retour avec des vannes d'interception avec capuchon de protection pour insert thermostatique, étriers, vannes à bille équerre avec raccord, thermomètres, parties terminales, robinets de remplissage/vidange, purgeurs d'air et embouts EUROK.
- Bausatz besteht aus Zulaufverteiler mit Durchflussmengenmesser FLUXER (0-5 l/min), Rücklaufverteiler mit Absperbarentilen mit Schutzkappe für Thermostat-Reguliovorrichtung, Haltebügel, Eck-Kugelventilen mit Verschraubung, Thermometer, Endstücke, Lade-/Entladeventilen, Entlüftungsventilen und EUROK Anschließen.
- Conjunto dotado de colector de impulsión con medidores/reguladores de caudal FLUXER (0-5 l/min), colector de retorno con válvulas de cierre con tapa de protección para tornillo termostático, abrazaderas, válvulas de bola de escuadra con manguito de unión, termómetros, terminales, válvulas para la carga/descarga, válvulas de purga de aire y conexiones EUROK.

Code	Ways	Size	Depth	Suitable Cabinet	Cabinet width	Price	Class	Packaging
503202ASIV	2	1" x EUROK	80 mm	200086	500 mm	287,45 €	OB	1
503203ASIV	3	1" x EUROK	80 mm	200086	500 mm	323,99 €	OB	1
503204ASIV	4	1" x EUROK	80 mm	200086	500 mm	360,52 €	OB	1
503205ASIV	5	1" x EUROK	80 mm	200686	600 mm	397,05 €	OB	1
503206ASIV	6	1" x EUROK	80 mm	200686	600 mm	433,57 €	OB	1
503207ASIV	7	1" x EUROK	80 mm	200186	700 mm	470,09 €	OB	1
503208ASIV	8	1" x EUROK	80 mm	200186	700 mm	506,64 €	OB	1
503209ASIV	9	1" x EUROK	80 mm	200786	800 mm	543,17 €	OB	1
503210ASIV	10	1" x EUROK	80 mm	200786	800 mm	579,69 €	OB	1
503211ASIV	11	1" x EUROK	80 mm	200286	900 mm	616,22 €	OB	1
503212ASIV	12	1" x EUROK	80 mm	200286	900 mm	655,14 €	OB	1
503213ASIV	13	1" x EUROK	80 mm	200886	1000 mm	715,46 €	OB	1



- Cassetta non inclusa >>p. 204,503
- Cabinet not included >>p. 204,503
- Casette pas inclus >>p. 204,503
- Kasten nicht enthalten >>p. 204,503
- Caja no incluida >>p. 204,503
- Versione 1"1/4 disponibile su richiesta.
- 1"1/4 version available on request.
- Version 1"1/4 disponible sur demande.
- 1"1/4 Ausführung auf Anfrage erhältlich.
- Versión de 1"1/4 disponible bajo pedido.

TECHNOPOLYMER MANIFOLDS

The CP 002 KC family of manifolds are modular and manufactured from reinforced polyamide. Their main feature is the presence of a dual chamber which makes them particularly suitable for radiant cooling applications. Air chambers are arranged around the central chamber in which the water flows, providing insulation and condensation protection: the cold water circulating in cooling mode is isolated from direct contact with the environment by these chambers, preventing dripping condensation which can occur during summer due to high ambient temperatures and humidity levels. As such, when appropriate dehumidification systems are used, it is possible to circulate water at temperatures as low as 14 °C.

The manifolds kit is equipped with Fluxer on the flow manifold for correct balancing of the distribution ways and flow-rate read-out, as well as thermostatic cartridges on the return to allow the individual circuits to be shut off via electrothermic heads, where required. The flow and return manifolds are also equipped with additional way with fill/drain valve and automatic air bleed valve.

The manifolds are equipped with integrated single brackets, allowing the two manifolds to be fastened at the most suitable centre distance depending on the available space.

Materials

Body: PA66

Seals and O-rings: peroxide EPDM

Shutoff knobs and caps: ABS

Technical specifications

Max % glycol: 50 %

Standard working pressure: 1.5÷2.5 bar

Maximum working pressure: 6 bar

Temperature range: 4÷70 °C

Main fitting: 1"

Branch fittings: 3/4" EK

Branch centre distance: 50 mm

⊕ PLUS

- Rugged and lightweight composite materials.
- Resistance to chemicals, UV rays and corrosion.
- Suitable both for radiant heating and cooling systems.
- Dual-chamber system (⊕ FOCUS) with insulation and anti-condensation function.
- Operating with water down to 14°C in cooling mode when used with suitable dehumidification systems
- Integrated single brackets for greater freedom of fastening of the manifolds

⊕ FOCUS on the 1" VERSION: Dual-chamber system

The cold water circulating in cooling mode is isolated from direct contact with the environment, preventing dripping condensation which can occur during summer due to high ambient temperatures and humidity levels.

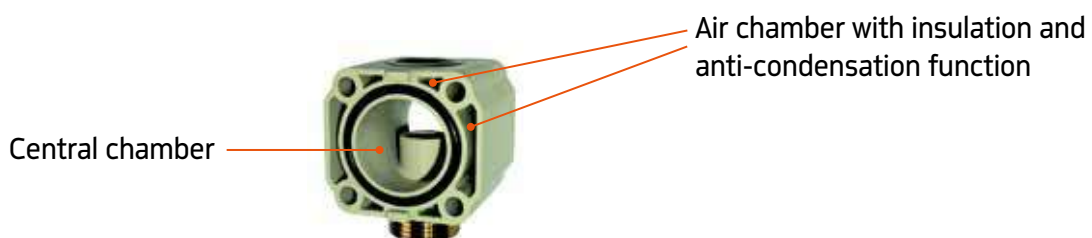

MANIFOLD KIT DIMENSIONS AND SUITABLE CABINET

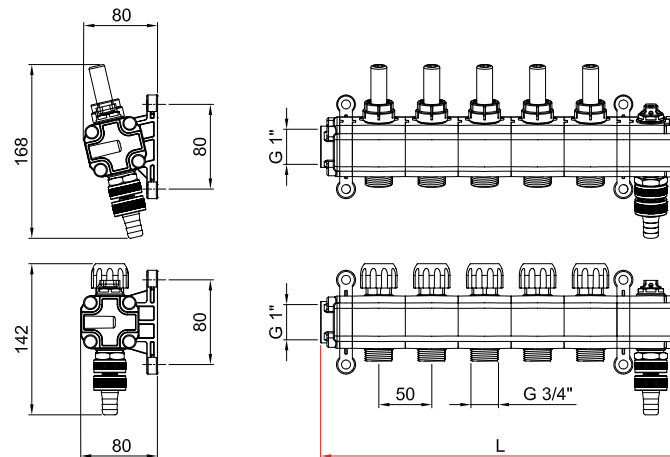

Manifold ways	2	3	4	5	6	7	8	9	10	11	12	13	14
1" manifolds kit width	190 mm	240 mm	290 mm	340 mm	390 mm	440 mm	490 mm	540 mm	590 mm	640 mm	690 mm	740 mm	790 mm
Cabinet code Cabinet width	200130 500 mm	200130 500 mm	200130 500 mm	200131 700 mm	200131 700 mm	200131 700 mm	200131 700 mm	200132 850 mm	200132 850 mm	200133 1.000 mm	200133 1.000 mm	200133 1.000 mm	200133 1.000 mm
Cabinet code Cabinet width	200086 500 mm	200086 500 mm	200086 500 mm	200686 600 mm	200686 600 mm	200186 700 mm	200186 700 mm	200786 800 mm	200786 800 mm	200286 900 mm	200286 900 mm	200886 1.000 mm	200886 1.000 mm

CP 002 KC (1")

- Kit composto da collettore di mandata con camera d'aria e misuratori/regolatori di portata FLUXER (0-5 l/min), collettore di ritorno con camera d'aria, valvole di intercettazione a manovra manuale, staffe integrate, termometri, valvole di carico/scarico, valvole di sfiato aria, tappi incorporati e attacchi EUROK.
- Kit made of flow manifold with air chamber and flow meters/adjusters FLUXER (0-5 l/min), return manifold with air chamber, manually operated isolation valves, integrated brackets, thermometers, filling/drainage valves, air vent valves, incorporated plugs and EUROK connections.
- Kit composé d'un collecteur d'envoi avec chambre à air et débit-mètres/régulateurs FLUXER (0-5 l/min), un collecteur de retour avec chambre à air, vannes d'interception à manoeuvre manuelle, étriers intégrés, thermomètres, robinets de remplissage/vidange, purgeurs d'air, bouchons incorporés et embouts EUROK.
- Bausatz besteht aus Zulauffusverteiler mit Luftkammer und Durchflussmengenmesser FLUXER (0-5 l/min), Rücklaufverteiler mit Luftkammer, Absperrventile mit manueller Hebel, integrierten Haltebügel, Thermometer, Lade-/Entladeventilen, Entlüftungsventilen, eingebaute Verschlüssen und EUROK Anschlüssen.
- Conjunto dotado de colector de impulsión con cámara de aire y medidores/reguladores de caudal FLUXER (0-5 l/min), colector de retorno con cámara de aire, válvulas de cierre con cabeza manual, abrazaderas integradas, termómetros, válvulas para la carga/descarga, válvulas de purga de aire, tapones incorporados y conexiones EUROK.

Code	Ways	Size	Depth	Suitable Cabinet	Cabinet width	Price	Class	Packaging
400742	2	1" x EUROK	85 mm	200086	500 mm	259,90 €	NV	1
400743	3	1" x EUROK	85 mm	200086	500 mm	316,40 €	NV	1
400744	4	1" x EUROK	85 mm	200086	500 mm	375,16 €	NV	1
400745	5	1" x EUROK	85 mm	200686	600 mm	432,79 €	NV	1
400746	6	1" x EUROK	85 mm	200686	600 mm	491,55 €	NV	1
400747	7	1" x EUROK	85 mm	200186	700 mm	549,18 €	NV	1
400748	8	1" x EUROK	85 mm	200186	700 mm	612,46 €	NV	1
400749	9	1" x EUROK	85 mm	200786	800 mm	668,96 €	NV	1
400750	10	1" x EUROK	85 mm	200786	800 mm	728,85 €	NV	1
400751	11	1" x EUROK	85 mm	200286	900 mm	785,35 €	NV	1
400752	12	1" x EUROK	85 mm	200286	900 mm	847,50 €	NV	1
400753	13	1" x EUROK	85 mm	200886	1000 mm	909,65 €	NV	1
400754	14	1" x EUROK	85 mm	200886	1000 mm	971,80 €	NV	1



- Cassetta non inclusa >> p. 204,503
- Cabinet not included >> p. 204,503
- Cassette pas inclus >> p. 204,503
- Kasten nicht enthalten >> p. 204,503
- Caja no incluida >> p. 204,503

CP 001 polymer manifolds are specially designed for radiant cooling systems, where they make a significant contribution to the reduction of surface condensation. They are produced in glass fibre reinforced polyamide and are supplied pre-assembled in kits on double brackets or double lowered brackets. Available in 1"1/4 version, complete with Fluxer (0-5 l/min) for flow rate control and inserts with option of thermostat control on the return manifold.

Materials

Body: PAS777
 Seals and O-rings: peroxide EPDM
 Shutoff knobs and caps: ABS

Technical specifications

Fluid temperature: -10 - 82 °C
 Maximum operating pressure: 4 bar

⊕ PLUS

- Rugged and lightweight composite materials.
- Limited formation of condensation.
- Resistance to chemicals, UV rays and corrosion.
- Suitable both for radiant heating and cooling systems.

MANIFOLDS KIT WIDTH AND SUITABLE CABINET

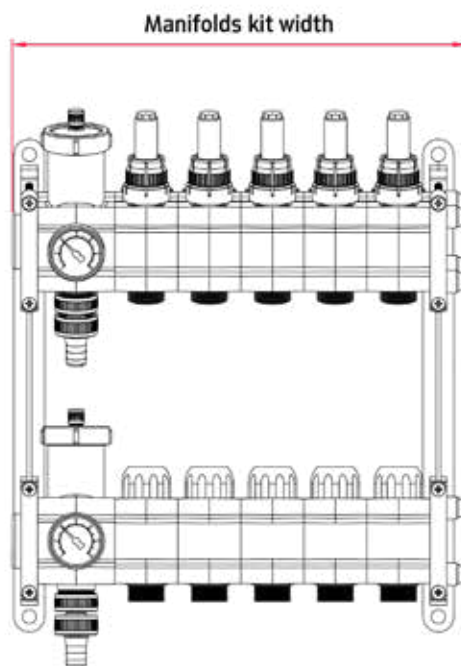

Manifold ways	2	3	4	5	6	7	8	9	10	11	12	13	14	15	16
1"1/4 manifolds kit width	266 mm	311 mm	356 mm	401 mm	446 mm	491 mm	536 mm	581 mm	626 mm	671 mm	716 mm	761 mm	806 mm	851 mm	896 mm
Cabinet code	200086	200086	200086	200686	200686	200186	200186	200786	200786	200286	200286	200886	200886	200386	200386
Cabinet width	500 mm	500 mm	500 mm	600 mm	600 mm	700 mm	700 mm	800 mm	800 mm	900 mm	900 mm	1000 mm	1000 mm	1100 mm	1100 mm

CP 001 (1"1/4)

0-2,5 l/min ON REQUEST

- Kit composto da collettore di mandata con misuratori/regolatori di portata FLUXER (0-5 l/min), collettore di ritorno con valvole di intercettazione a manovra manuale, staffe, termometri, valvole di carico/scarico, valvole di sfiato aria, tappi incorporati e attacchi EUROK.
- Kit made of flow manifold with flow meters/adjusters FLUXER (0-5 l/min), return manifold with manually operated isolation valves, brackets, thermometers, filling/drainage valves, air vent valves, incorporated plugs and EUROK connections.
- Kit composé d'un collecteur d'envoi avec débit-mètres/régulateurs FLUXER (0-5 l/min), un collecteur de retour avec des vannes d'interception à manoeuvre manuelle, étriers, thermomètres, robinets de remplissage/vidange, purgeurs d'air, bouchons incorporés et embouts EUROK.
- Bausatz besteht aus Zulaufverteiler mit Durchflussmengenmesser FLUXER (0-5 l/min), Rücklaufverteiler mit Absperbareventile mit manueller Hebel, Haltebügel, Thermometer, Lade-/Entladeventilen, Entlüftungsventilen, eingebaute Verschlüssen und EUROK Anschlüssen.
- Conjunto dotado de colector de impulsión con medidores/reguladores de caudal FLUXER (0-5 l/min), colector de retorno con válvulas de cierre con cabeza manual, abrazaderas, termómetros, válvulas para la carga/descarga, válvulas de purga de aire, tapones incorporados y conexiones EUROK.



Code	Ways	Size	Depth	Suitable Cabinet	Cabinet width	Price	Class	Packaging
410702	2	1"1/4 x EUROK	95 mm	200086	500 mm	263,29 €	NV	1
410703	3	1"1/4 x EUROK	95 mm	200086	500 mm	327,70 €	NV	1
410704	4	1"1/4 x EUROK	95 mm	200086	500 mm	396,63 €	NV	1
410705	5	1"1/4 x EUROK	95 mm	200686	600 mm	463,30 €	NV	1
410706	6	1"1/4 x EUROK	95 mm	200686	600 mm	529,97 €	NV	1
410707	7	1"1/4 x EUROK	95 mm	200186	700 mm	598,90 €	NV	1
410708	8	1"1/4 x EUROK	95 mm	200186	700 mm	668,96 €	NV	1
410709	9	1"1/4 x EUROK	95 mm	200786	800 mm	739,02 €	NV	1
410710	10	1"1/4 x EUROK	95 mm	200786	800 mm	811,34 €	NV	1
410711	11	1"1/4 x EUROK	95 mm	200286	900 mm	878,01 €	NV	1
410712	12	1"1/4 x EUROK	95 mm	200286	900 mm	950,33 €	NV	1
410713	13	1"1/4 x EUROK	95 mm	200886	1000 mm	1.023,78 €	NV	1
410714	14	1"1/4 x EUROK	95 mm	200886	1000 mm	1.092,71 €	NV	1
410715	15	1"1/4 x EUROK	95 mm	200386	1100 mm	1.162,77 €	NV	1
410716	16	1"1/4 x EUROK	95 mm	200386	1100 mm	1.356,00 €	NV	1



- Cassetta non inclusa >> p. 204,503
- Cabinet not included >> p. 204,503
- Casette pas inclus >> p. 204,503
- Kasten nicht enthalten >> p. 204,503
- Caja no incluida >> p. 204,503

CABINETS

AC 830



- Cassetta murale ad incasso per collettori e moduli MC / IVAR-SAT / MULTIMIX / MULTIMIX-C con altezza e profondità variabili.
- Wall fitted cabinet for manifolds and MC / IVAR-SAT / MULTIMIX / MULTIMIX-C modules with variable height and depth.
- Casette murale encastrabile pour collecteurs et modules MC / IVAR-SAT / MULTIMIX / MULTIMIX-C avec hauteur et profondeur variables.
- Einbauwandkasten für Verteiler und Module MC / IVAR-SAT / MULTIMIX / MULTIMIX-C mit variabler Höhe und Tiefe.
- Caja mural de empotrar para colectores y modulos MC / IVAR-SAT / MULTIMIX / MULTIMIX-C de altura y profundidad variables.

Code	Height	Width	Depth	Module	Price	Class	Packaging
200089	860-960 mm	500 mm	110-160 mm	2-way Multimix/Multimix-C	309,94 €	NZ	1
200590	860-960 mm	600 mm	110-160 mm	MC4 series (3/4")	335,14 €	NZ	1
200090	860-960 mm	700 mm	110-160 mm	MC 1/11/12/13/14 - MC4 series (1") - IVAR-SAT H/L/LE - 3-way Multimix/Multimix-C	342,76 €	NZ	1
200690	860-960 mm	800 mm	110-160 mm		387,93 €	NZ	1
200190	860-960 mm	900 mm	110-160 mm	MC2 series - IVAR-SAT HL/HLE	452,88 €	NZ	1
200790	860-960 mm	1000 mm	110-160 mm		483,93 €	NZ	1
200290	860-960 mm	1100 mm	110-160 mm		561,33 €	NZ	1
200890	860-960 mm	1200 mm	110-160 mm		615,85 €	NZ	1
200390	860-960 mm	1300 mm	110-160 mm		669,38 €	NZ	1
200490	860-960 mm	1500 mm	110-160 mm		817,65 €	NZ	1

AC 840



- Cassetta murale ad incasso per collettori e moduli MC con altezza e profondità variabili.
- Wall fitted cabinet for manifolds and MC modules with variable height and depth.
- Casette murale encastrabile pour collecteurs et modules MC avec hauteur et profondeur variables.
- Einbauwandkasten für Verteiler und Module MC mit variabler Höhe und Tiefe.
- Caja mural de empotrar para colectores y modulos MC de altura y profundidad variables.

Code	Height	Width	Depth	Module	Price	Class	Packaging
200086	600-700 mm	500 mm	80-130 mm	MC3 series	231,99 €	NZ	1
200686	600-700 mm	600 mm	80-130 mm		240,63 €	NZ	1
200186	600-700 mm	700 mm	80-130 mm	MC15	275,12 €	NZ	1
200786	600-700 mm	800 mm	80-130 mm		305,92 €	NZ	1
200286	600-700 mm	900 mm	80-130 mm		361,98 €	NZ	1
200886	600-700 mm	1000 mm	80-130 mm		374,99 €	NZ	1
200386	600-700 mm	1100 mm	80-130 mm		404,92 €	NZ	1
200986	600-700 mm	1200 mm	80-130 mm		439,37 €	NZ	1
200486	600-700 mm	1300 mm	80-130 mm		547,49 €	NZ	1
200586	600-700 mm	1500 mm	80-130 mm		615,12 €	NZ	1

AC 840 E



- Cassetta murale ad incasso in lamiera zincata con copertura verniciata bianca, piedini scorrevoli per la regolazione in altezza e rete per intonaco. Il fissaggio telescopico della copertura permette la compensazione dello spessore dell'intonaco, estendendo la profondità da 80 a 130 mm.
- Wall-mounted cabinet in galvanized sheet with white painted cover, sliding feet for height adjustment and mesh for plastering. The telescopic fixing of the cover allows compensation of the plaster thickness, extending the depth from 80 to 130 mm.
- Boîtier encastré mural en tôle galvanisée avec couvercle peint blanc, pieds coulissants pour réglage en hauteur et treillis pour plâtre. La fixation télescopique du couvercle permet la compensation de l'épaisseur du plâtre, en prolongeant la profondeur de 80 à 130 mm.
- Einbau-Wandkasten aus verzinktem Blech mit weiß lackiertem Deckel, Schiebefüßen zur Höhenverstellung und Netz für Gips. Die teleskopische Befestigung der Abdeckung ermöglicht den Ausgleich der Putzdicke und verlängert die Tiefe von 80 auf 130 mm.
- Caja de empotrar a pared en chapa galvanizada con tapa pintada en blanco, pies deslizantes para ajuste de altura y malla para yeso. La fijación telescópica de la cubierta permite la compensación del espesor del yeso, ampliando la profundidad de 80 a 130 mm.

Code	Height	Width	Depth	Price	Class	Packaging
200130	530-670 mm	500 mm	80-130 mm	197,70 €	NZ	1
200131	530-670 mm	700 mm	80-130 mm	229,76 €	NZ	1
200132	530-670 mm	850 mm	80-130 mm	249,36 €	NZ	1
200133	530-670 mm	1000 mm	80-130 mm	291,96 €	NZ	1

AC 820

- **Cassetta a muro per collettori con altezza e profondità fisse.**
- *Wall hanging cabinet for manifolds with fixed height and depth.*
- **Caisse murale suspendue pour collecteurs avec hauteur et profondeur fixes.**
- *Hängewandkasten mit fixer Höhe und Tiefe.*
- **Caja mural colgante para colectores de altura y profundidad fijas.**

Code	Height	Width	Depth	Price	Class	Packaging
540020	640 mm	450 mm	130 mm	289,73 €	NZ	1
540021	640 mm	530 mm	130 mm	298,25 €	NZ	1
540022	640 mm	830 mm	130 mm	383,48 €	NZ	1
540023	640 mm	1030 mm	130 mm	451,65 €	NZ	1

AC 850

- **Cassetta in plastica con fondo e kit di fissaggio per collettori complanari e componibili.**
- *Plastic cabinet with bottom and fastening kit for coplanar and modular manifolds.*
- **Cassette en plastique avec fond et kit de fixation pour collecteurs coplanaires et à éléments.**
- *Unterputz Verteilerschrank aus Kunststoff mit Boden und Fixierung-kit für komplanare und Einbau-Verteiler.*
- **Caja de plástico con fondo y kit de montaje para colectores coplanares y componibles.**

Code	Height	Width	Depth	Price	Class	Packaging
SAM-032	260 mm	320 mm	95 mm	33,01 €	NW	20
SAM-040	260 mm	400 mm	95 mm	36,49 €	NW	20
SAM-050	260 mm	500 mm	95 mm	40,53 €	NW	10
SAM-060	260 mm	600 mm	95 mm	46,32 €	NW	10

AC 851

- **Kit di fissaggio per collettori complanari e componibili in cassetta di plastica tipo AC 850.**
- *Kit for coplanar and modular manifolds fastening in plastic cabinet AC 850.*
- **Kit de fixation pour collecteurs coplanaires et à éléments dans la cassette en plastique AC 850.**
- *Fixierung-kit für komplanare und Einbau-Verteiler in Unterputz Verteilerschrank aus Kunststoff AC 850.*
- **Kit de montaje para colectores coplanares y componibles en caja de plástico tipo AC 850.**

Code	Manifolds type	Price	Class	Packaging
SAM-001	EASY•RADIANT / EASY•LOCK / BASIC series	14,77 €	NW	1

AC 852

- **Cassetta in plastica con fondo per collettori componibili e complanari (senza kit di fissaggio, da ordinare separatamente).**
- *Plastic cabinet with bottom for modular and coplanar manifolds (without fastening kit, to be ordered separately).*
- **Cassette en plastique avec fond pour collecteurs à éléments et coplanaires (sans kit de fixation, à commander séparément).**
- *Unterputz Verteilerschrank aus Kunststoff mit Boden für Einbau- und koplanare Verteiler (ohne Fixierung-kit, bitte bestellen getrennt).*
- **Caja de plástico con fondo para colectores componibles y coplanares (sin kit de montaje, para pedir separatamente).**

Code	Height	Width	Depth	Price	Class	Packaging
SAM-135	350 mm	350 mm	90 mm	42,92 €	NW	1
SAM-150	350 mm	500 mm	90 mm	54,34 €	NW	1
SAM-165	350 mm	650 mm	90 mm	71,83 €	NW	1
SAM-180	400 mm	800 mm	95 mm	97,87 €	NW	1

AC 853

- **Kit di fissaggio per collettori complanari e componibili in cassetta di plastica tipo AC 852.**
- *Kit for coplanar and modular manifolds fastening in plastic cabinet AC 852.*
- **Kit de fixation pour collecteurs coplanaires et à éléments dans la cassette en plastique AC 852.**
- *Fixierung-kit für komplanare und Einbau-Verteiler in Unterputz Verteilerschrank aus Kunststoff AC 852.*
- **Kit de montaje para colectores coplanares y componibles en caja de plástico de tipo AC 852.**

Code	Manifolds type	Price	Class	Packaging
SAM-011	CC 00	6,23 €	NW	1
SAM-010	EASY•RADIANT / EASY•LOCK / BASIC series	8,09 €	NW	1

TERMINALS FOR MANIFOLDS

AC 631



- Terminale orientabile per collettori.
- Adjustable terminal for manifolds.
- Terminal orientable pour collecteurs.
- Drehbarer Verteilerendstück.
- Terminal orientable para colectores.

Code	Size	Price	Class	Packaging
500257	1/2" F x 1" M x 1/2" F	10,69 €	NJ	20 / 80
500258	1/2" F x 1" M x 3/8" F	10,69 €	NJ	20 / 80

AC 677



- Terminale orientabile per collettori a 3 attacchi.
- Swiveling terminal for manifolds with 3 connections.
- Partie terminale orientable pour collecteurs à 3 embouts.
- 3 Anschlüssen drehbarer Verteilerendstück.
- Terminal orientable para colectores con 3 atques.

Code	Size	Price	Class	Packaging
570224	1" M - 3 x 1/2" F	14,13 €	NJ	20 / 160

AC 630



- Terminale orientabile per collettore con rubinetto di scarico incorporato in ottone o plastica.
- Adjustable terminal for manifold with brass or plastic incorporated drainage valve.
- Terminal orientable pour le collecteur avec un robinet d'évacuation incorporé en laiton ou en plastique.
- Drehbarer Verteilerendstück mit eingebautem Entleerungshahn aus Messing oder Kunststoff.
- Terminal orientable para colector con llave de vaciado incorporada de latón o plástico.

Code	Size	Price	Class	Packaging
500255	1/2" F x 1" M - BRASS	19,78 €	NJ	8 / 64
500256	1/2" F x 1" M - PLASTIC	14,50 €	NJ	10 / 80

AC 678



- Terminale orientabile per collettore con valvola di carico/scarico incorporata in ottone o plastica.
- Swiveling terminal for manifolds equipped with built-in brass or plastic filling/drainage valve.
- Partie terminale orientable pour collecteur avec robinet de remplissage/vidange incorporé en laiton ou en plastique.
- Drehbarer Verteilerendstück mit eingebautem Lade-/Entladeventil aus Messing oder Kunststoff.
- Terminal orientable para colector con válvula para la carga/descarga incorporada de latón o plástico.

Code	Size	Price	Class	Packaging
570225	1/2" F x 1" M x 1/2" F - BRASS	24,19 €	NJ	10 / 80
570225P	1/2" F x 1" M x 1/2" F - PLASTIC	19,56 €	NJ	10 / 80

AC 650



- Valvola di carico/scarico con rubinetto orientabile in ottone o plastica.
- Filling/drainage valve with brass or plastic rotating cock.
- Vanne de remplissage/vidange avec robinet orientable en laiton ou en plastique.
- Drehbarer Lade-/Entladeventil aus Messing oder Kunststoff.
- Válvula para la carga/descarga con llave orientable de latón o plástico.

Code	Size	Price	Class	Packaging
501016	1/2" M - BRASS	11,59 €	NJ	25 / 200
500125	1/2" M - PLASTIC	6,31 €	NJ	35 / 280

AC 657 N



- Terminale orientabile per collettore con rubinetto di scarico e valvola manuale di sfianto incorporati.
- Swiveling terminal for header with incorporated drainage valve and manual vent valve.
- Terminal orientable pour collecteur avec robinet d'évacuation et purgeur d'air manuel incorporés.
- Verstellbares Verteiler-Endstück mit eingebautem Entleerungshahn und manueller Entlüftungsventil.
- Terminal orientable para colector completo de llave de descarga y válvula purgadora manual.

Code	Size	Price	Class	Packaging
506246	3/4" M	21,26 €	NJ	20 / 80
506235	1" M	19,11 €	NJ	20 / 80

AIR VENT VALVES

AC 625



- Valvola manuale di sfiato.
- Manual air vent valve.
- Purgeur d'air manuel.
- Manuelles Entlüftungsventil.
- Válvula purgadora manual.

Code	Size	Price	Class	Packaging
500675	3/8"	2,575 €	NJ	100 / 800
500674	1/2"	2,041 €	NJ	100 / 800

AC 625 M



- Valvola manuale di sfiato.
- Manual air vent valve.
- Purgeur d'air manuel.
- Manuelles Entlüftungsventil.
- Válvula purgadora manual.

Code	Size	Price	Class	Packaging
500954M	1/4"	2,112 €	HA	100 / 400
500675M	3/8"	2,204 €	HA	100 / 400
500674M	1/2"	2,938 €	HA	100 / 400

AC 620



- Valvola di sfiato aria automatica.
- Automatic air valve.
- Purgeur d'air automatique.
- Automatisches Entlüftungsventil.
- Válvula purgadora automática.

Code	Size	Color	Price	Class	Packaging
501323	3/8"	■	11,29 €	NJ	15 / 120
501325	1/2"	■	11,02 €	NJ	15 / 120

AC 621



- Valvola di ritegno per valvola di sfiato automatica.
- Check valve for automatic air valve.
- Clapet de retenue pour purgeur d'air automatique.
- Rückschlagventil für automatisches Entlüftungsventil.
- Válvula de retención para válvula purgadora automática.

Code	Size	Color	Price	Class	Packaging
501327	1/2" M x 3/8" F	■	2,952 €	NJ	100 / 800
501329	1/2" M x 1/2" F	■	2,995 €	NJ	100 / 800

BRACKETS

AC 611



- Staffa doppia per collettori da barra e in acciaio inox.
- Double bracket for brass rod and stainless steel manifolds.
- Étrier double pour collecteurs de barre et en acier inox.
- Doppelter Wandalterung für Verteiler aus Messingstangen und Edelstahl.
- Soporte doble para colectores de barra de latón y acero inoxidable.

Code	OC distance	Depth	Manifolds type	Price	Class	Packaging
501359	250 mm	110 mm	3/4"	11,29 €	NJ	2 / 40
501218	250 mm	110 mm	1"	10,81 €	NJ	2 / 40
501360	250 mm	110 mm	1"1/4	10,81 €	NJ	2 / 30

AC 610



- Staffa doppia per collettori da barra e in acciaio inox.
- Double bracket for brass rod and stainless steel manifolds.
- Étrier double pour collecteurs de barre et en acier inox.
- Doppelter Wandalterung für Verteiler aus Messingstangen und Edelstahl.
- Soporte doble para colectores de barra de latón y acero inoxidable.

Code	OC distance	Depth	Manifolds type	Price	Class	Packaging
501019	200 mm	110 mm	3/4"	8,07 €	NJ	2 / 70
501098	200 mm	110 mm	1"	8,07 €	NJ	2 / 40
501020	200 mm	110 mm	1"1/4	8,07 €	NJ	2 / 60
501019P80	200 mm	80 mm	3/4"	8,07 €	NJ	2 / 70
501098P80	200 mm	80 mm	1"	8,07 €	NJ	2 / 40

AC 689



- Staffa doppia regolabile in plastica per collettori da barra e in acciaio inox.
- Double adjustable plastic bracket for brass rod and stainless steel manifolds.
- Étrier double réglable en plastique pour collecteurs de barre et en acier inox.
- Doppelter regelbarer Wandalterung aus Kunststoff für Verteiler aus Messingstangen und Edelstahl.
- Soporte doble ajustable de plástico para colectores de barra de latón y acero inoxidable.

Code	OC distance	Depth	Manifolds type	Price	Class	Packaging
501111	200-250 mm	80 mm	1"	14,09 €	NJ	2 / 40

AC 673



- Staffa doppia ribassata per collettori in plastica serie CP 001.
- Lowered double bracket for plastic manifolds CP 001 series.
- Étrier double abaissé pour collecteurs en plastique série CP 001.
- Abgesenkte Doppelt-Wandalterung für Kunststoffverteiler Serie CP 001.
- Soporte doble rebajado para colectores en plástico serie CP 001.

Code	OC distance	Depth	Manifolds type	Price	Class	Packaging
220080	200 mm	95 mm	CP 001 (1"1/4)	31,81 €	NV	1

AC 609

- Staffa singola per collettori da barra e in acciaio inox.
- Single bracket for brass rod and stainless steel manifolds.
- Étrier simple pour collecteurs de barre et en acier inox.
- Einzel Wandhalterung für Verteiler aus Messingstangen und Edelstahl.
- Soporte simple para colectores de barra de latón y acero inoxidable.

Code	Manifolds type	Price	Class	Packaging
500901	3/4"	4,181 €	NJ	2 / 140
500902	1"	4,181 €	NJ	80
500903	1"1/4	4,181 €	NJ	2 / 140

AC 629

- Staffa singola per collettori da barra e in acciaio inox.
- Single bracket for brass rod and stainless steel manifolds.
- Étrier simple pour collecteurs de barre et en acier inox.
- Einzel Wandhalterung für Verteiler aus Messingstangen und Edelstahl.
- Soporte simple para colectores de barra de latón y acero inoxidable.

Code	Manifolds type	Price	Class	Packaging
500935	3/4"	4,701 €	NJ	2 / 70
500936	1"	4,701 €	NJ	2 / 100
500641	1"1/4	4,701 €	NJ	2 / 150

AC 609 (1"1/2)

- Staffa singola per collettori da barra.
- Single bracket for brass rod manifolds.
- Étrier simple pour collecteurs de barre.
- Einzel Wandhalterung für Verteiler aus Messingstangen.
- Soporte simple para colectores de barra de latón.

Code	Manifolds type	Price	Class	Packaging
506195	1"1/2	22,87 €	NJ	2 / 70

AC 629 (1"1/2)

- Staffa singola per collettori da barra.
- Single bracket for brass rod manifolds.
- Étrier simple pour collecteurs de barre.
- Einzel Wandhalterung für Verteiler aus Messingstangen.
- Soporte simple para colectores de barra de latón.

Code	Manifolds type	Price	Class	Packaging
506196	1"1/2	34,47 €	NJ	2 / 50

BYPASS VALVES

AC 665



- Valvola di bypass differenziale.
- Bypass differential valve.
- Vanne de bypass différentiel.
- Differenziales Bypass-Ventil.
- Válvula de bypass de presión diferencial.

Code	Range	OC distance	Depth	Manifolds type	Price	Class	Packaging
500064	0,2-0,6 bar	200 mm	110 mm	1"	31,08 €	NJ	5 / 40
500064P80	0,2-0,6 bar	200 mm	80 mm	1"	31,08 €	NJ	5 / 40

AC 666



- Valvola di bypass differenziale con terminali per collettore.
- Differential bypass valve with terminals for manifold.
- Vanne de bypass différentiel avec terminaux pour collecteur.
- Differenziales Bypass-Ventil mit Verteileranschlüssen.
- Válvula de bypass de presión diferencial con terminales para colector.

Code	Range	OC distance	Depth	Manifolds type	Price	Class	Packaging
500126	0,2-0,6 bar	200 mm	110 mm	1"	53,87 €	NJ	4 / 32
500126P80	0,2-0,6 bar	200 mm	80 mm	1"	53,87 €	NJ	4 / 32

AC 667



- Valvola di bypass differenziale con bocchettoni.
- Differential bypass valve with nozzles.
- Vanne de bypass différentielle avec embouts.
- Differenziales Bypass-Ventil mit Stutzen.
- Válvula de bypass de presión diferencial con racores.

Code	Range	OC distance	Accessories	Depth	Price	Class	Packaging
500127P80	0,2-0,6 bar	200 mm		80 mm	66,53 €	NJ	2 / 16
500127	0,2-0,6 bar	200 mm		110 mm	66,53 €	NJ	2 / 16
500127GP80	0,2-0,6 bar	200 mm	1"1/4 swivel	80 mm	75,92 €	NJ	2 / 16
500127G	0,2-0,6 bar	200 mm	1"1/4 swivel	110 mm	75,92 €	NJ	2 / 16
501263P80	0,2-0,6 bar	200 mm	Thermometer	80 mm	78,00 €	NJ	1 / 3
501263	0,2-0,6 bar	200 mm	Thermometer	110 mm	78,00 €	NJ	2 / 16
501263GP80	0,2-0,6 bar	200 mm	Thermometer - 1"1/4 swivel	80 mm	87,41 €	NJ	2 / 16
501263G	0,2-0,6 bar	200 mm	Thermometer - 1"1/4 swivel	110 mm	87,41 €	NJ	2 / 16

AC 668

- **Valvola di bypass differenziale con bocchettoni ed accessori.**
- *Differential bypass valve with nozzles and accessories.*
- **Vanne de bypass différentielle avec embouts et accessoires.**
- *Differenziales Bypass-Ventil mit Stutzen und Zubehöre.*
- **Válvula de bypass de presión diferencial con racores y accesorios.**

Code	Range	OC distance	Accessories	Depth	Price	Class	Packaging
500128	0,2-0,6 bar	200 mm		110 mm	129,37 €	NJ	1 / 6
500128G	0,2-0,6 bar	200 mm	1"1/4 swivel	110 mm	138,75 €	NJ	1

AC 679

- **Valvola di bypass differenziale con terminali per collettore e accessori con scarico orientabile in ottone o plastica.**
- *Bypass differential valve with manifold terminals and accessories with brass or plastic adjustable drainage tap.*
- **Vanne de bypass différentielle avec terminaux pour collecteur et accessoires avec évacuation orientable en laiton ou en plastique.**
- *Differenziales Bypass-Ventil mit Verteileranschlüssen und Zubehöre mit Drehbarer Entleerungshahn aus Messing oder Kunststoff.*
- **Válvula de bypass de presión diferencial con terminales para colector y accesorios con descarga orientable de latón o plástico.**

Code	Range	OC distance	Accessories	Depth	Price	Class	Packaging
570226P80	0,2-0,6 bar	200 mm	Brass	80 mm	79,11 €	NJ	10 / 80
570226PP80	0,2-0,6 bar	200 mm	Plastic	80 mm	74,48 €	NJ	10 / 80
570226	0,2-0,6 bar	200 mm	Brass	110 mm	79,11 €	NJ	3 / 24
570226P	0,2-0,6 bar	200 mm	Plastic	110 mm	74,48 €	NJ	3 / 24

AC 681

- **Valvola di bypass differenziale con terminali per collettore, valvola manuale di sfiato e scarico orientabile in ottone o plastica.**
- *Bypass differential valve with manifold terminals, manual air vent valve and brass or plastic adjustable drainage tap.*
- **Vanne de bypass différentielle avec terminaux pour collecteur, purgeur d'air manuel et évacuation orientable en laiton ou en plastique.**
- *Differenziales Bypass-Ventil mit Verteileranschlüssen, manuelles Entlüftungsventil und Drehbarer Entleerungshahn aus Messing oder Kunststoff.*
- **Válvula de bypass de presión diferencial con terminales para colector, válvula purgadora manual y descarga orientable de latón o plástico.**

Code	Range	OC distance	Accessories	Depth	Price	Class	Packaging
570227P80	0,2-0,6 bar	200 mm	Brass	80 mm	69,18 €	NJ	10 / 80
570227PP80	0,2-0,6 bar	200 mm	Plastic	80 mm	64,55 €	NJ	10 / 80
570227	0,2-0,6 bar	200 mm	Brass	110 mm	69,18 €	NJ	10 / 80
570227P	0,2-0,6 bar	200 mm	Plastic	110 mm	64,55 €	NJ	10 / 80

FITTINGS AND PLUGS

Suitable fittings for manifolds (3/4" - 1" - 1"1/4) with EUROKONUS connection

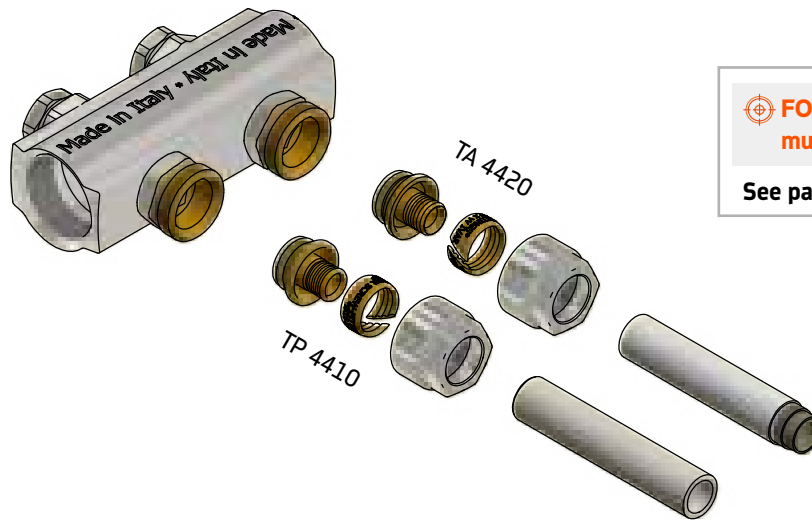

FOCUS: Fittings for multilayer and PEX pipe

See page 122.

TA 4420



- Raccordo EUROK per tubo multistrato e in polietilene.
- EUROK fitting for multilayer and polyethylene pipe.
- Raccord EUROK pour tube multicouches et en polyéthylène.
- EUROK-Verschraubung für Verbund- und für Polyäthylen-Rohr.
- Conexión EUROK para tubo multicapa y de polietileno.

Code	Size	Color	Price	Class	Packaging
506061	EUROK x 12/1,8	■	3,893 €	JA	40 / 320
500683	EUROK x 14/2	■	3,893 €	JA	40 / 320
500400	EUROK x 15/1,5	■	4,012 €	JA	40 / 320
500684	EUROK x 16/2	■	3,893 €	JA	40 / 320
500579	EUROK x 16/2,25	■	3,893 €	JA	40 / 320
506040	EUROK x 16,2/2,6	■	3,893 €	JA	40 / 320
500012	EUROK x 17/2	■	4,169 €	JA	40 / 320
500685	EUROK x 18/2	■	4,169 €	JA	40 / 320
500754	EUROK x 18/2,5	■	4,169 €	JA	40 / 320
500914	EUROK x 20/2	■	4,348 €	JA	40 / 320
500009	EUROK x 20/2,25	■	4,575 €	JA	40 / 320
501010	EUROK x 20/2,5	■	4,348 €	JA	40 / 320
506295	EUROK x 20/2,9	■	5,94 €	JA	40 / 320

TP 4410



- Raccordo EUROK per tubo in polietilene.
- EUROK fitting for polyethylene pipe.
- Raccord EUROK pour tube en polyéthylène.
- EUROK-Verschraubung für Polyäthylen-Rohr.
- Conexión EUROK para tubo de polietileno.

Code	Size	Color	Price	Class	Packaging
500590	EUROK x 12/1	■	3,673 €	JA	40 / 320
520041	EUROK x 12/2	■	3,673 €	JA	40 / 320
500679	EUROK x 14/2	■	3,593 €	JA	40 / 320
500148	EUROK x 15/1,7	■	3,893 €	JA	40 / 320
500769	EUROK x 15/2,5	■	3,737 €	JA	40 / 320
500591	EUROK x 16/1,5	■	3,51 €	JA	40 / 320
500680	EUROK x 16/2	■	3,51 €	JA	40 / 320
500681	EUROK x 16/2,2	■	3,51 €	JA	40 / 320
500682	EUROK x 17/2	■	3,737 €	JA	40 / 320
500145	EUROK x 18/1,8	■	3,737 €	JA	40 / 320
500650	EUROK x 18/2	■	4,169 €	JA	40 / 320
506020	EUROK x 18/2,5	■	3,737 €	JA	40 / 320
500651	EUROK x 20/2	■	4,169 €	JA	40 / 320
500649	EUROK x 20/2,8	■	4,025 €	JA	40 / 320
506200	EUROK x 20/3,4	■	4,025 €	JA	40 / 320
500753	EUROK x 21/2,5	■	4,528 €	JA	40 / 320

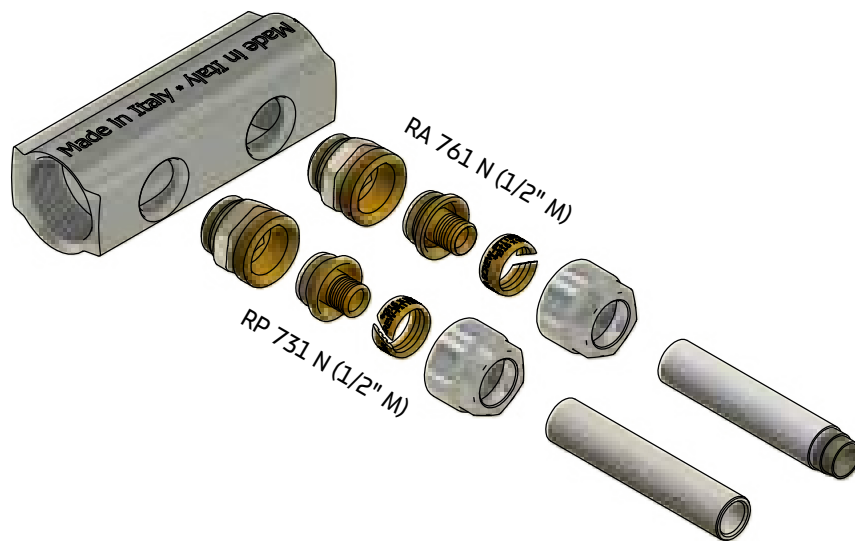
Suitable fittings for manifolds (3/4" - 1" - 1"1/4) with 1/2" F connection

RA 761 N

- Raccordo per tubo multistrato EUROK x 1/2" M.
- Fitting for multilayer pipe EUROK x 1/2" M.
- Raccord pour tube multicouches EUROK x 1/2" M.
- EUROK x 1/2" AG Verschraubung für Verbundrohr.
- Racor de compresión para tubo multicapa EUROK x 1/2" M.

Code	Size	Color	Price	Class	Packaging
570000N	1/2" M x 14/2	■	6,73 €	LA	50 / 200
570001N	1/2" M x 15/1,5	■	6,73 €	LA	50 / 200
570002N	1/2" M x 16 /2	■	6,73 €	LA	50 / 200
570003N	1/2" M x 16/2,25	■	6,73 €	LA	50 / 200
570004N	1/2" M x 17/2	■	6,89 €	LA	50 / 200
570005N	1/2" M x 18/2	■	6,89 €	LA	50 / 200
570006N	1/2" M x 18/2,5	■	6,89 €	LA	50 / 200
570007N	1/2" M x 20/2	■	7,11 €	LA	50 / 200
570008N	1/2" M x 20/2,25	■	7,11 €	LA	50 / 200
570009N	1/2" M x 20/2,5	■	7,11 €	LA	25 / 100

RP 731 N

- Raccordo per tubo polietilene EUROK x 1/2" M.
- Fitting for polyethylene pipe EUROK x 1/2" M.
- Raccord pour tube polyéthylène EUROK x 1/2" M.
- EUROK x 1/2" AG Verschraubung für Polyäthyl-Rohr.
- Racor de compresión para tubo de polietileno EUROK x 1/2" M.

Code	Size	Color	Price	Class	Packaging
570020N	1/2" M x 12/1	■	6,46 €	LA	50 / 200
570021N	1/2" M x 12/2	■	6,46 €	LA	50 / 200
570022N	1/2" M x 14/2	■	6,46 €	LA	50 / 200
570023N	1/2" M x 15/1,7	■	6,46 €	LA	50 / 200
570024N	1/2" M x 15/2,5	■	6,46 €	LA	50 / 200
570025N	1/2" M x 16/1,5	■	6,46 €	LA	50 / 200
570026N	1/2" M x 16/2	■	6,46 €	LA	50 / 200
570027N	1/2" M x 16/2,2	■	6,46 €	LA	50 / 200
570028N	1/2" M x 17/2	■	6,44 €	LA	50 / 200
570029N	1/2" M x 18/1,8	■	6,44 €	LA	50 / 200
570030N	1/2" M x 18/2	■	6,44 €	LA	50 / 200
570031N	1/2" M x 20/2	■	6,73 €	LA	50 / 200
570032N	1/2" M x 20/2,8	■	6,73 €	LA	50 / 200
570033N	1/2" M x 21/2,5	■	6,98 €	LA	50 / 200

Suitable fittings for manifolds (1"1/2) with 3/4"F connection

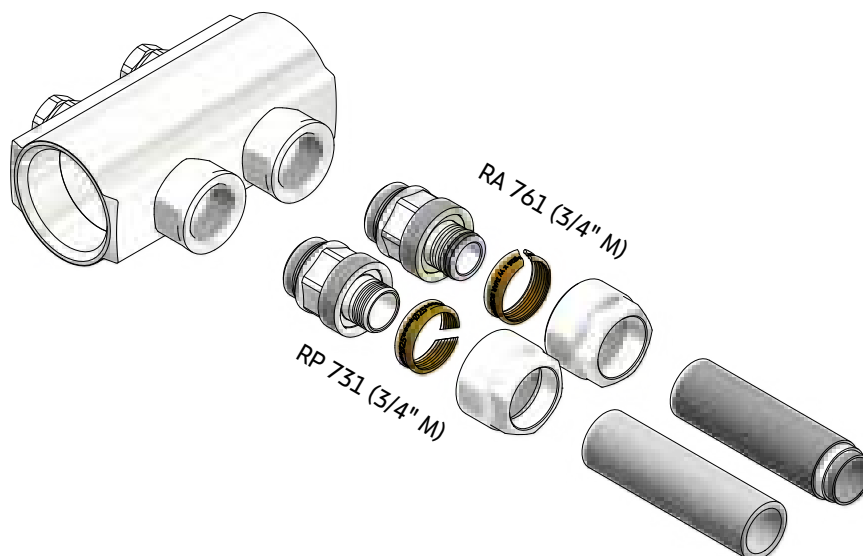

■ RA 761



- Raccordo a stringere diritto maschio per tubo multistrato.
- Compression straight male fitting for multilayer pipe.
- Raccord à serrage droit mâle pour tube multicouche.
- Durchgang AG Pressanschluss für Verbundrohr.
- Racor de compresión recto macho para tubo multicapa.

Code	Size	Color	Price	Class	Packaging
500043	3/4" M x 20/2	■	7,67 €	LA	25 / 100
501361	3/4" M x 25/2,5	■	11,68 €	LA	25 / 200
500122	3/4" M x 25/3	■	11,68 €	LA	25 / 100
501084	3/4" M x 26/3	■	11,68 €	LA	25 / 100
501497	3/4" M x 32/3	■	18,45 €	LA	15 / 120
500043N	3/4" M x 20/2	■	7,88 €	LA	25 / 200
501361N	3/4" M x 25/2,5	■	12,01 €	LA	25 / 200
500122N	3/4" M x 25/3	■	12,01 €	LA	25 / 100
501084N	3/4" M x 26/3	■	12,01 €	LA	25 / 100
501497N	3/4" M x 32/3	■	19,01 €	LA	15 / 120

■ RP 731



- Raccordo a stringere diritto maschio per tubo in polietilene.
- Compression straight male fitting for polyethylene pipe.
- Raccord à serrage droit mâle pour tube en polyéthylène.
- Durchgang AG Pressanschluss für Polyäthylenrohr.
- Racor de compresión recto macho para tubo de polietileno.

Code	Size	Color	Price	Class	Packaging
506209	3/4" M x 20/2	■	7,37 €	LA	25 / 200
501051	3/4" M x 20/2,8	■	7,37 €	LA	25 / 200
501054	3/4" M x 25/2,3	■	11,72 €	LA	25 / 100
550042	3/4" M x 25/2,5	■	11,72 €	LA	25 / 200
501052	3/4" M x 25/3,5	■	11,72 €	LA	20 / 160
501498	3/4" M x 32/4,4	■	17,80 €	LA	15 / 120
506209N	3/4" M x 20/2,3	■	7,59 €	LA	25 / 200
501051N	3/4" M x 20/2,8	■	7,59 €	LA	25 / 200
501054N	3/4" M x 25/2,3	■	12,07 €	LA	25 / 100
550042N	3/4" M x 25/2,5	■	12,07 €	LA	25 / 200
501052N	3/4" M x 25/3,5	■	12,07 €	LA	25 / 100
501498N	3/4" M x 32/4,4	■	18,33 €	LA	15 / 120

AC 647

- Raccordo sdoppiatore EUROK.
- Flow splitter fitting EUROK.
- Raccord dédoubleur EUROK.
- Verteiler-Y-Stück EUROK.
- Racor doble EUROK.

Code	Size	OC distance	Color	Price	Class	Packaging
506138	EUROK	36 mm	■	12,70 €	NJ	60

AC 603

- Niplo maschio - maschio.
- Male - male nipple.
- Nipple mâle - mâle.
- AG - AG Anschlußstück.
- Entrerrosca macho - macho.

Code	Size	Color	Price	Class	Packaging
550099	1/2" M O-ring x 1/2" M O-ring	■	2,78 €	NJ	100 / 400
550098	3/4" M O-ring x 3/4" M O-ring	■	3,786 €	NJ	50 / 200
501101	1" M O-ring x 1" M O-ring	■	5,22 €	NJ	50 / 200
500919	1"1/4 M O-ring x 1" M O-ring	■	10,93 €	NJ	25 / 100
500912	1"1/4 M O-ring x 1"1/4 M O-ring	■	7,11 €	NJ	25 / 100
550097	1/2" M O-ring x 1/2" M O-ring	■	2,825 €	NJ	100 / 400
550096	3/4" M O-ring x 3/4" M O-ring	■	3,853 €	NJ	50 / 200
500699	1" M O-ring x 1" M O-ring	■	5,36 €	NJ	50 / 200
500919N	1"1/4 M O-ring x 1" M O-ring	■	11,13 €	NJ	25 / 100
500913	1"1/4 M O-ring x 1"1/4 M O-ring	■	7,35 €	NJ	25 / 100

AC 606

- Niplo girevole maschio - maschio.
- Swivelling male - male nipple.
- Nipple pivotant mâle - mâle.
- AG - AG drehbarer Nippel.
- Entrerrosca giratoria macho - macho.

Code	Size	Color	Price	Class	Packaging
500386	3/4" M O-ring x 3/4" M O-ring	■	12,02 €	NJ	30 / 120
500357	3/4" M O-ring x 1" M O-ring	■	9,05 €	NJ	30 / 120
500063	1" M O-ring x 1" M O-ring	■	10,46 €	NJ	20 / 80
500387	1"1/4 M O-ring x 1"1/4 M O-ring	■	19,93 €	NJ	10 / 40
500386N	3/4" M O-ring x 3/4" M O-ring	■	12,44 €	NJ	30 / 120
500357N	3/4" M O-ring x 1" M O-ring	■	9,47 €	NJ	30 / 120
500070	1" M O-ring x 1" M O-ring	■	10,81 €	NJ	20 / 80
500387N	1"1/4 M O-ring x 1"1/4 M O-ring	■	20,94 €	NJ	10 / 40

FOCUS: splitter fitting

The splitter fitting is very useful to obtain two outlets from a single outlet of the manifold to connect two different circuits. For example, it is frequently used in plaster fibre ceiling and underfloor radiant systems, with low diameter pipes and low flow rates. In these cases there is flexible use of all manifold outlets, with added cost benefits. Lastly, the splitter fitting can also be used to obtain an extra outlet on the manifold when previously not envisaged, without the need to replace the manifold itself with another version fitted with an extra outlet (an operation often expensive and also not always possible given that it may require the replacement of the manifold housing).

AC 605

- Raccordo eccentrico.
- Cam connector.
- Raccord excentrique.
- Excenter Anschluß IG.
- Racor excéntrico.

Code	Size	Color	Price	Class	Packaging
502230N	1"	■	22,36 €	NJ	6 / 48

AC 4615 N

- Raccordo portatermometro per derivazioni.
- Thermometer fitting for junctions.
- Raccord porte-thermomètre pour dérivations.
- Anschlußstück mit Thermometer.
- Racor con termómetro para derivaciones.

Code	Size	Color	Price	Class	Packaging
500804	EUROK	■	18,20 €	NJ	10 / 80

AC 617

- Termometro con pozzetto.
- Thermometer with pocket.
- Thermomètre avec regard.
- Thermometer mit Tauchhülse.
- Termómetro con termopozo.

Code	Size	Price	Class	Packaging
500071	3/8"	11,99 €	NJ	20 / 160
500072	1/2"	13,72 €	NJ	20 / 160

■ AC 602



- Riduzione maschio - femmina.
- Male - female reducing fitting.
- Réduction mâle - femelle.
- AG - IG Reduziermuffe.
- Reducción macho - hembra.

Code	Size	Color	Price	Class	Packaging
550093	1/2" M x 3/8" F	Yellow	1,921 €	NJ	200 / 800
550094	3/4" M x 3/8" F	Yellow	2,931 €	NJ	50 / 200
550095	3/4" M x 1/2" F	Yellow	2,528 €	NJ	100 / 400
550091	1" M x 3/8" F	Yellow	3,583 €	NJ	50 / 400
501103	1" M x 1/2" F	Yellow	3,153 €	NJ	50 / 400
501102	1" M x 3/4" F	Yellow	3,153 €	NJ	50 / 400
500906	1"1/4 M x 1/2" F	Yellow	6,85 €	NJ	25 / 100
500908	1"1/4 M x 3/4" F	Yellow	6,38 €	NJ	35 / 140
500910	1"1/4 M x 1" F	Yellow	5,01 €	NJ	35 / 140
506018	1"1/2 M x 1" F	Yellow	8,48 €	NJ	20 / 160
500280	1/2" M x 3/8" F	Grey	1,944 €	NJ	200 / 800
501099	3/4" M x 3/8" F	Grey	3,074 €	NJ	50 / 200
550028	3/4" M x 1/2" F	Grey	2,575 €	NJ	100 / 400
550092	1" M x 3/8" F	Grey	3,797 €	NJ	50 / 400
500670	1" M x 1/2" F	Grey	3,221 €	NJ	50 / 200
501509	1" M x 3/4" F	Grey	3,221 €	NJ	50 / 400
500907	1"1/4 M x 1/2" F	Grey	7,07 €	NJ	25 / 200
500909	1"1/4 M x 3/4" F	Grey	6,61 €	NJ	35 / 140
500911	1"1/4 M x 1" F	Grey	5,07 €	NJ	35 / 140

■ AC 601



- Tappo femmina.
- Female plug.
- Bouchon femelle.
- IG Verschluss.
- Tapón hembra.

Code	Size	Color	Price	Class	Packaging
550016	1/2"	Yellow	2,159 €	NJ	50 / 400
500022	3/4"	Yellow	2,397 €	NJ	100 / 400
500625	1"	Yellow	4,141 €	NJ	35 / 280
550016N	1/2"	Grey	2,159 €	NJ	50 / 400
550090	3/4"	Grey	2,48 €	NJ	100 / 400
500625N	1"	Grey	4,284 €	NJ	35 / 280

■ AC 601 K



- Kit tappo femmina con adattatore per tenuta piatta.
- Female plug kit with adaptor for flat seal.
- Kit bouchon femelle avec adaptateur pour tenue plate.
- Verschluss Set mit Innengewinde und Flachdichtung Adapter.
- Kit tapón hembra con adaptador para junta plana.

Code	Size	Color	Price	Class	Packaging
506206	EUROK	Yellow	3,939 €	NJ	50 / 400
506206N	EUROK	Grey	4,07 €	NJ	50 / 400

■ AC 624



- Riduzione femmina - femmina.
- Female - female reducing fitting.
- Réduction femelle - femelle.
- Reduzierstück Innengewinde - Innengewinde
- Reducción hembra - hembra.

Code	Size	Color	Price	Class	Packaging
501619	3/4" F x 3/8" F	Yellow	3,187 €	NJ	100 / 400
501618	3/4" F x 1/2" F	Yellow	3,187 €	NJ	100 / 400
501620	1" F x 1/2" F	Yellow	4,01 €	NJ	50 / 400
501621	1" F x 3/4" F	Yellow	4,01 €	NJ	50 / 400
501619N	3/4" F x 3/8" F	Grey	3,221 €	NJ	100 / 400
501618N	3/4" F x 1/2" F	Grey	3,221 €	NJ	100 / 400
501620N	1" F x 1/2" F	Grey	4,141 €	NJ	50 / 400
501621N	1" F x 3/4" F	Grey	4,141 €	NJ	50 / 400

■ AC 627



- Bocchettone ridotto girevole a tenuta morbida.
- Reduced soft seal fitting.
- Embout à étanchéité souple réduite.
- Reduziert Selbstdichtendsutzen.
- Manguito de unión reducido con junta blanda.

Code	Size	Color	Price	Class	Packaging
550551	3/4" F x 1"1/4 F	Yellow	15,21 €	NJ	10 / 80
550552	1" F x 1"1/4 F	Yellow	14,40 €	NJ	10 / 80
550551N	3/4" F x 1"1/4 F	Grey	15,70 €	NJ	10 / 80
550552N	1" F x 1"1/4" F	Grey	14,92 €	NJ	10 / 80

■ AC 600



- Tappo maschio.
- Male plug.
- Bouchon mâle.
- AG Verschluss.
- Tapón macho.

Code	Size	Color	Price	Class	Packaging
590082	1/4" M	Yellow	2,528 €	NJ	150 / 600
550084	3/8" M	Yellow	1,469 €	NJ	250 / 1000
501108	1/2" M	Yellow	1,424 €	NJ	200 / 800
550009	3/4" M	Yellow	2,539 €	NJ	50 / 400
501104	1" M	Yellow	2,825 €	NJ	50 / 400
500904	1"1/4 M	Yellow	5,71 €	NJ	20 / 160
506017	1"1/2 M	Yellow	6,67 €	NJ	20 / 160
550085	3/8" M	Grey	1,537 €	NJ	250 / 1000
550086	1/2" M	Grey	1,448 €	NJ	200 / 800
550087	3/4" M	Grey	2,623 €	NJ	50 / 400
501501	1" M	Grey	2,907 €	NJ	50 / 400
500905	1"1/4 M	Grey	5,82 €	NJ	35 / 140

COMPLEMENTARY ITEMS



FOCUS: AQUASTOP

In mixed systems with radiators and underfloor heating and cooling, Aquastop mechanically prevents cold water from entering the circuit on which it is installed, without the use of servomotors or electronic controls.

The device contains a thermostat: when the water temperature is over 19 °C, i.e. during the winter heating phase, it maintains an open passage; when, on the other hand, the temperature is below 19 °C, i.e. during the summer cooling phase, the thermostat retracts and prevents cold water from reaching the utilities. There are zones of the radiant system which are particularly subject to the formation of surface condensation during the summer cooling phase, such as bathrooms or other areas without suitable air treatment (exchange/ventilation). Similarly, in summer, radiators and towel rails cannot be fed with cold water. In all these cases, Aquastop prevents the formation of condensation in a simple and economical manner.

Aquastop XL has the same operating principle as Aquastop, with the advantage of being able to handle larger flow rates, thanks to its 1" connection.

On circuits for radiators and designer heating units, it **PREVENTS COLD WATER FROM CIRCULATING INSIDE THE TERMINAL UNITS** which would otherwise drip condensation.

Available in the following versions:
G 3/4" F x EUROK,
G 1" F x G 1" M.

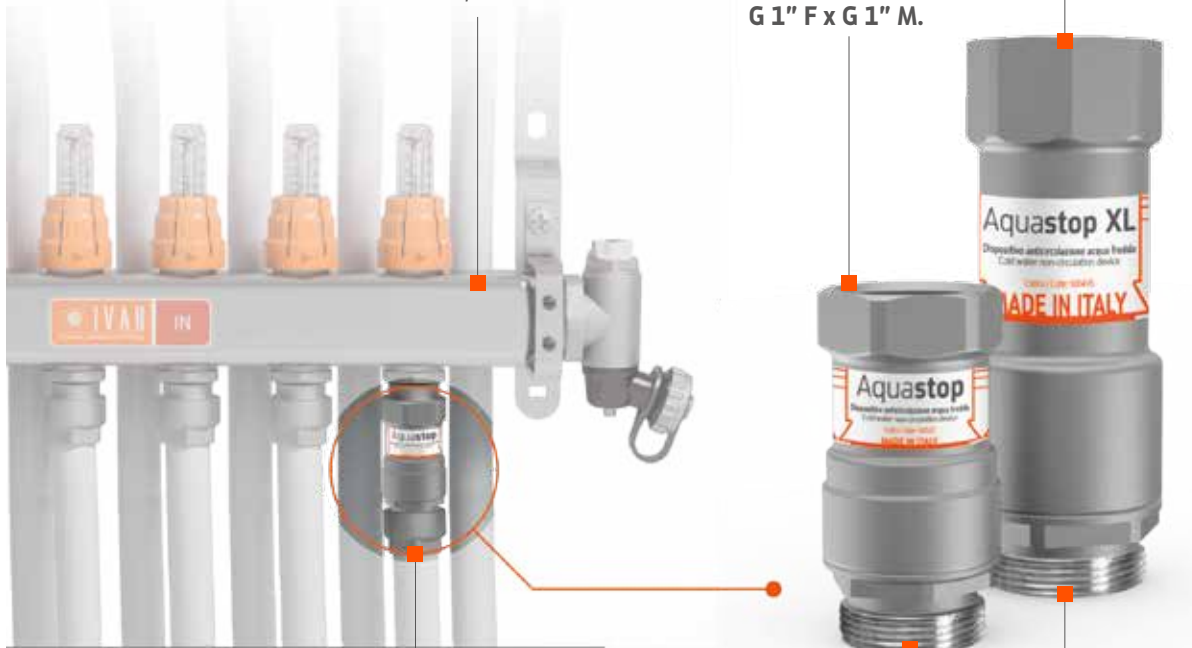

COMPACT:
minimised dimensions

COST-EFFECTIVE ALTERNATIVE
to the use of servomotors with
electronic regulation.

■ AQUASTOP



- Dispositivo anticircolazione dell'acqua fredda.
- Cold water non-circulation device.
- Dispositif d'anti-circulation d'eau froide.
- Ventil zur Verhinderung des Kaltwasserumlaufs.
- Dispositivo anticirculación del agua fría.

Code	Size	Range	Color	Price	Class	Packaging
500522	3/4" F x EUROK	≤19° C	■	53,92 €	NJ	10 / 80

■ AQUASTOP XL



- Dispositivo anticircolazione dell'acqua fredda.
- Cold water non-circulation device.
- Dispositif d'anti-circulation eau froide.
- Ventil zur Verhinderung des Kaltwasserumlaufs.
- Dispositivo anticirculación del agua fría.

Code	Size	Range	Color	Price	Class	Packaging
500495	G 1" F x G 1" M	≤19° C	■	133,80 €	NJ	10 / 40

■ AC 674



- Misuratore/regolatore di portata FLUXER con memoria di posizione.
- Flow meter/adjuster FLUXER with position memory.
- Débit-mètre/régulateur FLUXER avec mémoire de position.
- Durchflussmengenmesser FLUXER mit Positionsspeicherung.
- Medidor/regulador de caudal FLUXER con memoria de posición.

Code	Range	Color	Price	Class	Packaging
506204	0-5 l/min	■	12,44 €	NJ	100
506168	0-2,5 l/min	■	12,44 €	NJ	100

■ VTC 30



- Vitone di comando ed intercettazione per collettori da barra in ottone.
- Control and isolation screw for brass-rod manifolds.
- Insert de commande et d'interception pour collecteurs de barre en laiton.
- Bedienungs- und Steuereinsatz für Verteiler aus Messingstangen.
- Tornillo de mando y interceptación para colectores de barra de latón.

Code	Price	Class	Packaging
500920	8,80 €	NJ	50 / 200

■ AVT 03



- Ghiera per vitone per collettore.
- Threaded socket for insert for manifold.
- Bague pour insert du collecteur.
- Oberteil für Thermostateinsatz für Verteiler.
- Anillo para el tornillo para colectores.

Code	Price	Class	Packaging
553004	2,101 €	NJ	100 / 800

■ VDC 31



- Vitone di bilanciamento a doppia regolazione micrometrica per collettori da barra in ottone.
- Balancing insert with double micrometrical adjustment for brass-rod manifolds.
- Insert d'équilibrage à double réglage micrométrique pour collecteurs de barre en laiton.
- Ausgleicherteil mit doppelter Feineinstellung für Verteiler aus Messingstangen.
- Tornillo de balanceamento con doble ajuste micrométrico para colectores de barra de latón.

Code	Color	Price	Class	Packaging
550044N	■	7,20 €	NJ	50 / 200

■ AC 4648



- Sede per misuratore/regolatore di portata FLUXER (0-5 l/min).
- Fitting for flow meter/adjuster FLUXER (0-5 l/min).
- Raccord pour débit-mètre/régulateur FLUXER (0-5 l/min).
- Anschlußnippel für Durchflussmengenmesser FLUXER (0-5 l/min).
- Montaje para medidor/regulador de caudal FLUXER (0-5 l/min).

Code	Size	Manifolds type	Color	Price	Class	Packaging
501296N	1/2" M x EUROK	1"	■	4,058 €	NJ	50 / 200
501297N	1/2" M x EUROK	1"1/4	■	4,058 €	NJ	50 / 400

■ VTC 30 PL



- Vitone in plastica di comando ed intercettazione per collettori in acciaio inox.
- Control and isolation plastic screw for stainless steel manifolds.
- Insert de commande et d'interception en plastique pour collecteurs en acier inox.
- Bedienungs- und Steuereinsatz aus Kunststoff für Edelstahl-Verteiler.
- Tornillo de mando y interceptación de plástico para colectores de acero inoxidable.

Code	Price	Class	Packaging
500920PL	6,18 €	NJ	50 / 400

■ AC 4612



- Sede per vitone di comando ed intercettazione.
- Fitting for command and isolation insert.
- Raccord pour insert de commande et d'interception.
- Verbinder für Bedienungs- und Steuervorrichtung.
- Montaje para tornillo de mando y interceptación.

Code	Size	Manifolds type	Color	Price	Class	Packaging
501363N	1/2" M x EUROK	1"	■	2,48 €	NJ	50 / 400
501368N	1/2" M x EUROK	1"1/4	■	3,358 €	NJ	50 / 400

■ VDC 31 PL



- Vitone in plastica di bilanciamento a doppia regolazione micrometrica per collettori in acciaio inox.
- Plastic balancing insert with double micrometrical adjustment for stainless steel manifolds.
- Insert d'équilibrage à double réglage micrométrique en plastique pour collecteurs en acier inox.
- Ausgleicherteil mit doppelter Feineinstellung aus Kunststoff für Edelstahl-Verteiler.
- Tornillo de balanceamento con doble ajuste micrométrico de plástico para colectores de acero inoxidable.

Code	Color	Price	Class	Packaging
550044NPL	■	6,60 €	NJ	50 / 400

AGE 05

- Tappo con guarnizione per collettori con detentori a doppia regolazione micrometrica.
- Plug with gasket for manifolds with double-micrometric-adjustment lockshields.
- Bouchon avec joint pour collecteurs avec inserts à double réglage micrométrique.
- Verschluss mit Dichtung für Verteiler mit doppelfeinvorein Stellbaren Rücklaufverschraubungen.
- Tapón con junta para colectores con detentores de doble regulación micrométrica.

Code	Color	Price	Class	Packaging
500056	■	0,878 €	HA	200 / 1600

AGE 09

- Cappuccio di protezione per vitone termostatico.
- Protection cap for thermostatic insert.
- Capuchon de protection pour insert thermostatique.
- Schutzkappe für Thermostat-Reguliervorrichtung.
- Tapa de protección para tornillo termostático.

Code	Color	Price	Class	Packaging
501278	□	0,463 €	HA	50 / 400

AC 652

- Copertura isolante per collettori da barra in ottone, adatta per impianti di riscaldamento/raffrescamento radiante.
- Insulating cover for brass-rod manifolds, suitable for radiant heating/cooling systems.
- Couverture isolante pour collecteurs de barre en laiton, adaptée pour systèmes radiants de chauffage/refroidissement.
- Isolierabdeckung für Verteiler aus Messingstangen, geeignet für Fussbodenheizung- und Kühlung Systeme.
- Cubierta de aislamiento para colectores de barra de latón, adecuada para sistemas de calefacción y enfriamiento radiante.

Code	Ways	Manifolds type	Price	Class	Packaging
506253	12	1"	27,04 €	NJ	7
506254	12	1" 1/4	27,04 €	NJ	7
506444	12	1" 1/2	33,20 €	NJ	7

AC 693 F

- Kit composto da 2 fascette di fissaggio per copertura isolante AC 693.
- Kit composed by 2 fixing hose clamps for insulating cover AC 693.
- Kit composé de 2 pinces de fixation pour couverture isolante AC 693.
- Kit bestehend aus 2 Befestigungsklammern für Isolierabdeckung AC 693.
- Kit compuesto por 2 abrazaderas de fijación para cubierta de aislamiento AC 693.

Code	Price	Class	Packaging
500697	3,786 €	NJ	35

FLC 15

- Flussmetro.
- Flow meter.
- Fluxmètre.
- Durchflussmesser.
- Fluxímetro.

Code	Size	Range	Color	Price	Class	Packaging
500867	EUROK	1-4 l/min	■	13,62 €	NJ	20 / 80

TM 3053

- Testa manuale in plastica.
- Plastic manual head.
- Tête manuelle en plastique.
- Kunststoff manueller Hebel.
- Cabezal manual.

Code	Size	Color	Price	Class	Packaging
500046	M30 x 1,5	□	1,555 €	AD	25 / 200

AC 693

- Copertura isolante per collettori in acciaio inox, adatta per impianti di riscaldamento/raffrescamento radiante.
- Insulating cover for stainless steel manifolds, suitable for radiant heating/cooling systems.
- Couverture isolante pour collecteurs en acier inox, adaptée pour systèmes radiants de chauffage/refroidissement.
- Isolierabdeckung für Verteiler aus Edelstahl, geeignet für Fussbodenheizung- und Kühlung Systeme.
- Cubierta de aislamiento para colectores de acero inoxidable, adecuada para sistemas de calefacción y enfriamiento radiante.

Code	Ways	Manifolds type	Price	Class	Packaging
506270	12	1"	36,74 €	NJ	7

AC 690

- Termometro con catenella per collettori in acciaio inox e EASY-RADIANT.
- Thermometer with chain for stainless steel and EASY-RADIANT manifolds.
- Thermomètre avec chaîne pour collecteurs en acier inox et EASY-RADIANT.
- Thermometer mit Kette für Verteiler aus Edelstahl und EASY-RADIANT.
- Termómetro con cadena para colectores de acero inoxidable y EASY-RADIANT.

Code	Size	Price	Class	Packaging
510180	Ø40 mm	16,77 €	NJ	25 / 200

TE 3040 IV



- Testa elettrotermica normalmente chiusa (2 fili). Compatibile con tutti i vitoni termostattizzabili IVAR e i collettori con interasse ≥ 40 mm.
- Electrothermal head normally closed (2 wires). Suitable for all IVAR thermostatic inserts and manifolds with centre-to-centre distance ≥ 40 mm.
- Tête électrothermique normalement fermée (2 fils). Adaptée pour tous les inserts thermostatisables IVAR et aux collecteurs avec entraxe ≥ 40 mm.
- Elektrothermischer Stellantrieb stromlos-zu (2 Kabel). Geeignet für alle Thermostat-Regulievorrichtungen IVAR und für Verteiler mit Achsabstand ≥ 40 mm.
- Cabeza electrotrémica normalmente cerrada (de 2 hilos). Adecuada para todos los tornillos termostattizables IVAR y los colectores con distancia entre centros ≥ 40 mm.

Code	Size	Price	Class	Packaging
501508E	M30 x 1,5 ; ON / OFF (230 V AC)	29,64 €	AC	100

TE 3040



- Testa elettrotermica normalmente chiusa (2 fili). Compatibile con tutti i vitoni termostattizzabili IVAR e i collettori con interasse ≥ 50 mm (no EASY-RADIANT).
- Electrothermal head normally closed (2 wires). Suitable for all IVAR thermostatic inserts and manifolds with centre-to-centre distance ≥ 50 mm (no EASY-RADIANT).
- Tête électrothermique normalement fermée (2 fils). Adaptée pour tous les inserts thermostatisables IVAR et aux collecteurs avec entraxe ≥ 50 mm (non EASY-RADIANT).
- Elektrothermischer Stellantrieb stromlos-zu (2 Kabel). Geeignet für alle Thermostat-Regulievorrichtungen IVAR und für Verteiler mit Achsabstand ≥ 50 mm (keine EASY-RADIANT).
- Cabeza electrotrémica normalmente cerrada (de 2 hilos). Adecuada para todos los tornillos termostattizables IVAR y los colectores con distancia entre centros ≥ 50 mm (no EASY-RADIANT).

Code	Size	Price	Class	Packaging
501508	M30 x 1,5 ; ON / OFF (230 V AC)	36,60 €	AC	100
501524	M30 x 1,5 ; ON / OFF (24 V AC/DC)	36,60 €	AC	100

TE 3050 MC



- Testa elettrotermica normalmente chiusa con contatto di fine corsa (4 fili). Compatibile con tutti i vitoni termostattizzabili IVAR e i collettori con interasse ≥ 40 mm.
- Electrothermal head normally closed with limit switch contact (4 wires). Suitable for all IVAR thermostatic inserts and manifolds with centre-to-centre distance ≥ 40 mm.
- Tête électrothermique normalement fermée avec contact de fin de course (4 fils). Adaptée pour tous les inserts thermostatisables IVAR et aux collecteurs avec entraxe ≥ 40 mm.
- Elektrothermischer Stellantrieb stromlos-zu mit Endschalterkontakt (4 Kabel). Geeignet für alle Thermostat-Regulievorrichtungen IVAR und für Verteiler mit Achsabstand ≥ 40 mm.
- Cabeza electrotrémica normalmente cerrada con contacto de fin de carrera (de 4 hilos). Adecuada para todos los tornillos termostattizables IVAR y los colectores con distancia entre centros ≥ 40 mm.

Code	Size	Price	Class	Packaging
500808MC	M30 x 1,5 ; ON / OFF (230 V AC)	43,43 €	AC	100

TE 3050 M



- Testa elettrotermica normalmente chiusa con contatto di fine corsa (4 fili). Compatibile con tutti i vitoni termostattizzabili IVAR e i collettori con interasse ≥ 50 mm (no EASY-RADIANT).
- Electrothermal head normally closed with limit switch contact (4 wires). Suitable for all IVAR thermostatic inserts and manifolds with centre-to-centre distance ≥ 50 mm (no EASY-RADIANT).
- Tête électrothermique normalement fermée avec contact de fin de course (4 fils). Adaptée pour tous les inserts thermostatisables IVAR et aux collecteurs avec entraxe ≥ 50 mm (non EASY-RADIANT).
- Elektrothermischer Stellantrieb stromlos-zu mit Endschalterkontakt (4 Kabel). Geeignet für alle Thermostat-Regulievorrichtungen IVAR und für Verteiler mit Achsabstand ≥ 50 mm (keine EASY-RADIANT).
- Cabeza electrotrémica normalmente cerrada con contacto de fin de carrera (de 4 hilos). Adecuada para todos los tornillos termostattizables IVAR y los colectores con distancia entre centros ≥ 50 mm (no EASY-RADIANT).

Code	Size	Price	Class	Packaging
500808M	M30 x 1,5 ; ON / OFF (230 V AC)	43,43 €	AC	100
500028M	M30 x 1,5 ; ON / OFF (24 V AC/DC)	43,43 €	AC	100

BALL VALVES

POTABLE WATER COMPATIBILITY

AC 655 NST



- Coppia di valvole a sfera diritte maschio-femmina complete di bocchettone a tenuta morbida, manovra a farfalla.
- *Pair of male-female straight ball valves with soft-seal fitting, butterfly operation.*
- *Set de vannes à bille droites mâle-femelle avec goulotte à étanchéité souple, manoeuvre à papillon.*
- *Paar Durchgangs-Kugelventil AG-IG mit Selbstdichtensstutzen und Flügelgriff.*
- *Conjunto de válvulas de bola rectas macho-hembra completas de manguito de unión con junta blanda, vuelta a mariposa.*

Code	Size	Color	Price	Class	Packaging
506404	1/2"	■ / ■	29,27 €	NO	6 / 48
506405	3/4"	■ / ■	43,30 €	NO	5 / 20
506406	1"	■ / ■	58,75 €	NO	2 / 16
506407	1"1/4	■ / ■	116,88 €	NO	2 / 16
506408	1"1/2	■ / ■	178,11 €	NO	1 / 8

AC 655 N



- Coppia di valvole a sfera diritte maschio-femmina complete di bocchettone a tenuta morbida e termometro, manovra a farfalla.
- *Pair of male-female straight ball valves with soft-seal fitting and thermometer, butterfly operation.*
- *Set de vannes à bille droites mâle-femelle avec goulotte à étanchéité souple et thermomètre, manoeuvre à papillon.*
- *Paar Durchgangs-Kugelventil AG-IG mit Selbstdichtensstutzen, Thermometer und Flügelgriff.*
- *Conjunto de válvulas de bola rectas macho-hembra completas de manguito de unión con junta blanda y termómetro, vuelta a mariposa.*

Code	Size	Color	Price	Class	Packaging
520132	1"	■ / ■	92,00 €	NO	1 / 12
520133	1"1/4	■ / ■	167,67 €	NO	1 / 8

POTABLE WATER COMPATIBILITY

AC 682 NST



- Coppia di valvole a sfera a squadra maschio-femmina complete di bocchettone a tenuta morbida, manovra a farfalla.
- *Pair of angle ball valves complete with soft seal fitting, butterfly operation.*
- *Set de vannes à bille équerre avec goulotte à étanchéité souple, manoeuvre à papillon.*
- *Paar Eck-Kugelventile mit Selbstdichtensstutzen und Flügelgriff.*
- *Conjunto de válvulas de bola de escuadra completas de manguito de unión con junta blanda, vuelta a mariposa para maniobrar.*

Code	Size	Color	Price	Class	Packaging
508005ST	1" F x 1" M	■ / ■	94,13 €	NO	2 / 8
508006ST	1" F x 1"1/4 M	■ / ■	124,07 €	NO	2 / 8

AC 682 N



- Coppia di valvole a sfera a squadra maschio-femmina complete di bocchettone a tenuta morbida e termometro, manovra a farfalla.
- *Pair of angle ball valves complete with soft seal fitting and thermometer, butterfly operation.*
- *Set de vannes à bille équerre avec goulotte à étanchéité souple et thermomètre, manoeuvre à papillon.*
- *Paar Eck-Kugelventile mit Selbstdichtensstutzen, Thermometer und Flügelgriff.*
- *Conjunto de válvulas de bola de escuadra completas de manguito de unión con junta blanda y termómetro, vuelta a mariposa para maniobrar.*

Code	Size	Color	Price	Class	Packaging
508005	1" F x 1" M	■ / ■	108,37 €	NO	2 / 8
508006	1" F x 1"1/4 M	■ / ■	138,31 €	NO	2 / 8

AC 658 N



- Coppia di valvole a sfera diritte con attacco girevole maschio e termometro incorporato.
- *Pair of straight ball valves with male swivelling fitting and built-in thermometer.*
- *Set de vannes à bille droites avec embout pivotant mâle et thermomètre incorporé.*
- *Paar gerade Kugelventile mit AG drehbare Anschluß und eingebautem Thermometer.*
- *Conjunto de válvulas de bola rectas con ataque giratorio macho y termómetro incorporado.*

Code	Size	Color	Price	Class	Packaging
506236	1"	■ / ■	85,86 €	NO	15

AC 669 N





- Coppia di valvole a sfera diritte/squadra con attacco girevole maschio e termometro incorporato.
- *Pair of straight/square ball valves with swivelling male fitting and built-in thermometer.*
- *Set de vannes à bille droites/équerre avec embout pivotant mâle et thermomètre incorporé.*
- *Paar gerade/Eck Kugelventile mit AG drehbare Anschluß und eingebautem Thermometer.*
- *Conjunto de válvulas de bola rectas/de escuadra de con ataque giratorio macho y termómetro incorporado.*

Code	Size	Color	Price	Class	Packaging
506237	1"	■ / ■	104,90 €	NO	12



POTABLE WATER COMPATIBILITY 
AC 636 NB

- Valvola a sfera diritta femmina-femmina, manovra a farfalla (blu).
- Female-female straight ball valve, butterfly operation (blue).
- Vanne à bille droite femelle-femelle, manœuvre à papillon (bleu).
- Durchgangs-Kugelventil IG-IG mit Flügelgriff (blau).
- Válvula de bola recta hembra-hembra, vuelta a mariposa para maniobrar (azul).

Code	Size	Color	Price	Class	Packaging
501905NB	3/4"		15,75 €	NO	10 / 80
501418NB	1"		24,48 €	NO	8 / 64
506299NB	1"1/4		36,27 €	NO	8 / 64





AC 636 NR

- Valvola a sfera diritta femmina-femmina, manovra a farfalla (rossa).
- Female-female straight ball valve, butterfly operation (red).
- Vanne à bille droite femelle-femelle, manœuvre à papillon (rouge).
- Durchgangs-Kugelventil IG-IG mit Flügelgriff (rot).
- Válvula de bola recta hembra-hembra, vuelta a mariposa para maniobrar (roja).

Code	Size	Color	Price	Class	Packaging
501905NR	3/4"		15,75 €	NO	10 / 80
501418NR	1"		24,48 €	NO	8 / 64
506299NR	1"1/4		36,27 €	NO	8 / 64





AC 635 NB

- Valvola a sfera diritta maschio-femmina senza raccordo, manovra a farfalla (blu).
- Male-female straight ball valve without fitting, butterfly operation (blue).
- Vanne à bille droite mâle-femelle sans raccord, manœuvre à papillon (bleu).
- Durchgangs-Kugelventil AG-IG ohne Verschraubung, mit Flügelgriff (blau).
- Válvula de bola recta macho-hembra sin racor, vuelta a mariposa para maniobrar (azul).

Code	Size	Color	Price	Class	Packaging
501352NB	1/2" F x 3/4" M		11,51 €	NO	12 / 96
501353NB	3/4" F x 1" M		15,21 €	NO	10 / 80
501354NB	1" F x 1"1/4 M		21,64 €	NO	6 / 48
501455B	1"1/4 F x 1"1/2 M		38,74 €	NO	6 / 48





AC 635 NR

- Valvola a sfera diritta maschio-femmina senza raccordo, manovra a farfalla (rossa).
- Male-female straight ball valve without fitting, butterfly operation (red).
- Vanne à bille droite mâle-femelle sans raccord, manœuvre à papillon (rouge).
- Durchgangs-Kugelventil AG-IG ohne Verschraubung, mit Flügelgriff (rot).
- Válvula de bola recta macho-hembra sin racor, vuelta a mariposa para maniobrar (roja).

Code	Size	Color	Price	Class	Packaging
501352N	1/2" F x 3/4" M		11,51 €	NO	12 / 96
501353N	3/4" F x 1" M		15,21 €	NO	10 / 80
501354N	1" F x 1"1/4 M		21,64 €	NO	6 / 48
501455	1"1/4 F x 1"1/2 M		38,67 €	NO	6 / 48





AC 654 NB

- Valvola a sfera diritta maschio-femmina completa di bocchettone a tenuta morbida, manovra a farfalla (blu).
- Male-female straight ball valve complete with soft-seal fitting, butterfly operation (blue).
- Vanne à bille droite mâle-femelle avec goulotte à étanchéité souple, manoeuvre à papillon (bleu).
- Durchgangs-Kugelventil AG-IG mit Selbstdichtendsstutzen und Flügelgriff (blau).
- Válvula de bola recta macho-hembra completa de manguito de unión con junta blanda, vuelta a mariposa para maniobrar (azul).

Code	Size	Color	Price	Class	Packaging
506400B	1/2"		14,97 €	NO	12 / 96
506401B	3/4"		21,58 €	NO	8 / 64
506402B	1"		29,30 €	NO	6 / 48
506403B	1"1/4		58,43 €	NO	3 / 24

AC 654 NR

- Valvola a sfera diritta maschio-femmina completa di bocchettone a tenuta morbida, manovra a farfalla (rossa).
- Male-female straight ball valve complete with soft-seal fitting, butterfly operation (red).
- Vanne à bille droite mâle-femelle avec goulotte à étanchéité souple, manoeuvre à papillon (rouge).
- Durchgangs-Kugelventil AG-IG mit Selbstdichtendsstutzen und Flügelgriff (rot).
- Válvula de bola recta macho-hembra completa de manguito de unión con junta blanda, vuelta a mariposa para maniobrar (roja).

Code	Size	Color	Price	Class	Packaging
506400R	1/2"		14,97 €	NO	12 / 96
506401R	3/4"		21,58 €	NO	8 / 64
506402R	1"		29,30 €	NO	6 / 48
506403R	1"1/4		58,43 €	NO	3 / 24

POTABLE WATER COMPATIBILITY
AC 643 NB

- Valvola a sfera a squadra maschio-femmina senza raccordo, manovra a farfalla (blu).
- Male-female square ball valve without fitting, butterfly operation (blue).
- Vanne à bille équerre mâle-femelle sans raccord, manœuvre à papillon (bleu).
- Eck-Kugelventil AG-IG ohne Verschraubung, mit Flügelgriff (blau).
- Válvulas de bola de escuadra macho-hembra sin racor, vuelta a mariposa para maniobrar (azul).

Code	Size	Color	Price	Class	Packaging
508000NB	3/4" F x 1" M		26,44 €	NO	8 / 64
508001NB	1" F x 1"1/4 M		35,81 €	NO	5 / 40
508002NB	1" F x 1"1/2 M		39,67 €	NO	8 / 64

AC 643 NR

- Valvola a sfera a squadra maschio-femmina senza raccordo, manovra a farfalla (rossa).
- Male-female square ball valve without fitting, butterfly operation (red).
- Vanne à bille équerre mâle-femelle sans raccord, manœuvre à papillon (rouge).
- Eck-Kugelventil AG-IG ohne Verschraubung, mit Flügelgriff (rot).
- Válvulas de bola de escuadra macho-hembra sin racor, vuelta a mariposa para maniobrar (roja).

Code	Size	Color	Price	Class	Packaging
508000NR	3/4" F x 1" M		26,44 €	NO	8 / 64
508001NR	1" F x 1"1/4 M		35,81 €	NO	5 / 40
508002NR	1" F x 1"1/2 M		39,67 €	NO	8 / 64

AC 635 BCM

- Valvola a sfera diritta maschio-femmina completa di bocchettone semplice, manovra a leva (blu).
- Male-female straight ball valve complete with simple fitting, lever operation (blue).
- Vanne à bille droite mâle-femelle avec goulotte simple, manoeuvre à levier (bleue).
- Durchgangs-Kugelventil AG-IG mit Verschraubung und Hebelgriff (blau).
- Válvula de bola recta macho-hembra completa de manguito de unión simple, con palanca para maniobrar (azul).

Code	Size	Color	Price	Class	Packaging
506257B	1"1/2		89,06 €	NO	1 / 8

AC 635 RCM

- Valvola a sfera diritta maschio-femmina completa di bocchettone semplice, manovra a leva (rossa).
- Male-female straight ball valve complete with simple fitting, lever operation (red).
- Vanne à bille droite mâle-femelle avec goulotte simple, manoeuvre à levier (rouge).
- Durchgangs-Kugelventil AG-IG mit Verschraubung und Hebelgriff (rot).
- Válvula de bola recta macho-hembra completa de manguito de unión simple, con palanca para maniobrar (roja).

Code	Size	Color	Price	Class	Packaging
506257R	1"1/2		89,06 €	NO	1 / 8

AGE 01 N

- Bocchettone a tenuta morbida.
- Soft seal fitting.
- Goulotte à étanchéité souple.
- Stutzen mit O-Ring.
- Manguito de unión con junta blanda.

Code	Size	Color	Price	Class	Packaging
506074	5/8" F x 3/8" M O-ring		4,058 €	HA	75 / 600
500106	3/4" F x 3/8" M O-ring		3,501 €	HA	50 / 400
501279	3/4" F x 1/2" M O-ring (short version)		3,501 €	HA	50 / 400
500605N	3/4" F x 1/2" M O-ring		3,678 €	HA	50 / 200
501215N	1" F x 3/4" M O-ring		6,77 €	HA	35 / 140
506032N	1" F x 1" M O-ring		7,35 €	HA	20 / 160
506060N	1" F TP x 1" M O-ring		7,77 €	HA	20 / 160
501214N	1"1/4 F x 1" M O-ring		8,36 €	HA	20 / 80
501219	1"1/2 F x 1"1/4 M O-ring		18,69 €	HA	10 / 80

AC 637 N

- Bocchettone a tenuta morbida con termometro orientabile per valvola a sfera.
- Soft seal fitting with adjustable thermometer for ball valves.
- Embout à étanchéité souple avec thermomètre orientable pour vannes à bille.
- Selbstdichtendsstutzen mit drehbarem Thermometer für Kugelventile.
- Manguito de unión con junta blanda con termómetro orientable para válvulas de bola.

Code	Size	Price	Class	Packaging
501356N	1"1/4 F x 1" M	24,33 €	NJ	9 / 36
501357N	1"1/2 F x 1"1/4 M	43,61 €	NJ	8 / 64

AC 617 I

- Termometro per valvole a sfera.
- Thermometer for ball valves.
- Thermomètre pour vannes à bille.
- Thermometer für Kugelventile.
- Termómetro para válvulas de bola.

Code	Price	Class	Packaging
508010	7,12 €	NO	50 / 400

FOCUS: inlet port with swivel fitting

The soft seal inlet port enables the connection of a variety of accessories such as an automatic purge valve, an adjustable thermometer, a bypass or drain valve. If aligned connections are required, for example to maintain the correct height of the purge valve, the "G" version is specially recommended, complete with additional rotary lock nut.

AC 645



- Bocchettone a tenuta morbida a 3 attacchi per valvole a sfera.
- 3 connection soft seal fitting for ball valves.
- Embout à étanchéité souple à 3 attaches pour vannes à bille.
- Anschlussstück mit O-Ring und 3 Anschlüssen für Kugelventile.
- Manguito de unión con junta blanda con 3 conexiones para válvulas de bola.

Code	Size	Price	Class	Packaging
500073	1" F - 3 x 1/2" F	18,23 €	NJ	10 / 80

AC 645 G



- Bocchettone a tenuta morbida a 3 attacchi per valvole a sfera con dado girevole 1"1/4.
- 3 connection soft seal fitting for ball valves with 1"1/4 rotating nut.
- Embout à étanchéité souple à 3 attaches pour vannes à bille avec écrou rotatif 1"1/4.
- Anschlussstück mit O-Ring und 3 Anschlüssen für Kugelventile mit 1"1/4 drehbarer Mutter.
- Manguito de unión con junta blanda con 3 conexiones para válvulas de bola con tuerca giratoria de 1"1/4.

Code	Size	Accessories	Price	Class	Packaging
500073G	1"1/4 F - 3 x 1/2" F	1 1/4" rotating nut	21,48 €	NJ	10 / 80

AC 619



- Bocchettone ad angolo con o senza spurgo per valvole a sfera. G = con dado girevole 1"1/4.
- Square fitting with or without drain for ball valves. G = with 1"1/4 rotating nut.
- Embout à angle avec ou sans purgeur pour vannes à bille. G = avec écrou rotatif 1"1/4.
- Winkelanschluß mit oder ohne Reinigung für Kugelventile. G = mit 1"1/4 drehbarer Mutter.
- Manguito de unión angular con o sin purga para válvulas de bola. G = con tuerca giratoria 1"1/4.

Code	Size	Accessories	Price	Class	Packaging
500523	1"		13,77 €	NJ	10 / 80
500526	1" x 1/2"		13,77 €	NJ	10 / 80
500523G	1"1/4 F x 1"	1 1/4" rotating nut	18,37 €	NJ	10 / 80
500526G	1"1/4 F x 1" x 1/2"	1 1/4" rotating nut	18,37 €	NJ	10 / 80

AC 619 L



- Bocchettone ad L con o senza spurgo per valvole a sfera. G = con dado girevole 1"1/4.
- Square fitting with or without drain for ball valves. G = with 1"1/4 rotating nut.
- Embout à L avec ou sans purgeur pour vannes à bille. G = avec écrou rotatif 1"1/4.
- Winkelanschluß lang mit oder ohne Reinigung für Kugelventile. G = mit 1"1/4 drehbarer Mutter.
- Manguito de unión angular con o sin purga para válvulas de bola. G = con tuerca giratoria 1"1/4.

Code	Size	Accessories	Price	Class	Packaging
500528	1"		18,78 €	NJ	10 / 80
500529	1" x 1/2"		18,78 €	NJ	10 / 40
500528G	1"1/4 F x 1"	1 1/4" rotating nut	22,85 €	NJ	10 / 80
500529G	1"1/4 F x 1" x 1/2"	1 1/4" rotating nut	22,85 €	NJ	10 / 80

AC 6450



- Bocchettone a tenuta morbida per valvole a sfera con termometro orientabile, valvola di sfogo automatica e rubinetto di svuotamento orientabile. G = con dado girevole 1"1/4.
- Soft seal fitting for ball valves with adjustable thermometer, automatic vent valve and adjustable draining cock. G = with 1"1/4 rotating nut.
- Embout à étanchéité souple pour vannes à bille avec thermomètre orientable, soupape d'aération automatique et robinet de vidange orientable. G = avec écrou rotatif 1"1/4.
- Selbstdichtendsstutzen mit drehbarem Thermometer für Kugelventile, Schnellentlüfter und drehbarem Entleerungshahn. G = mit 1"1/4 drehbarer Mutter.
- Manguito de unión con junta blanda para válvulas de bola con termómetro orientable, válvulas de purga automática y llave de descarga orientable. G = con tuerca giratoria 1"1/4.

Code	Size	Accessories	Price	Class	Packaging
500124	1" F x 1" M		52,65 €	NJ	4 / 32
500124G	1"1/4 F x 1" M	1 1/4" rotating nut	57,36 €	NJ	4 / 32

SF 1325 F

- Valvola a sfera con manovra a farfalla e bocchettone a tenuta morbida.
- Butterfly operated straight ball valve with soft seal fitting.
- Vanne à bille droite avec manoeuvre à papillon et goulotte à étanchéité souple.
- Durchgangs-Kugelventil mit Knebel und Stutzen mit O-Ring.
- Válvula de bola recta con vuelta a mariposa para maniobrar y manguito de unión con junta blanda.

Code	Size	Price	Class	Packaging
500893	EUROK x 1/2" M O-ring	11,68 €	NJ	20 / 80

SF 1570

- Valvola a sfera diritta maschio-femmina, manovra a farfalla
- Male-female straight ball valve, butterfly operation
- Vanne à bille droite mâle-femelle, manoeuvre à papillon
- Durchgangs-Kugelventil AG-IG, mit Flügelgriff
- Válvula de bola recta macho-hembra, vuelta a mariposa para maniobrar

Code	Size	Price	Class	Packaging
500379	1/2" F x 1/2" M	8,60 €	NJ	20 / 160

SF 1335 F

- Valvola a sfera diritta con manovra a farfalla e dado girevole.
- Straight ball valve with butterfly turn and rotating nut.
- Vanne à bille droite avec manoeuvre à papillon et écrou rotatif.
- Durchgangs-Kugelventil mit Knebel und drehbarer Mutter.
- Válvula de bola recta con vuelta a mariposa para maniobrar y tuerca giratoria.

Code	Size	Price	Class	Packaging
501398	EUROK x 3/4" EUROK swivel	9,53 €	NJ	20 / 160

AC 654 G



- Valvola a sfera diritta femmina-femmina completa di dado girevole, manovra a farfalla.
- Female-female straight ball valve with swivelling nut, butterfly operation.
- Vanne à bille droite femelle-femelle avec écrou rotatif, manoeuvre à papillon.
- Durchgangs-Kugelventil IG-IG mit drehbarer Mutter und Flügelgriff.
- Válvula de bola recta hembra-hembra completa de tuerca giratoria, vuelta a mariposa.

Code	Size	Price	Class	Packaging
5201941	1" F swivel x Ø22 copper pipe	28,23 €	NO	8 / 32
5201951	1" F swivel x 3/4" F	21,36 €	NO	8 / 32
5201961	1" F swivel x 1" F	28,23 €	NO	8 / 32
5201971	1" F swivel x 1"1/4 F	35,12 €	NO	8 / 32

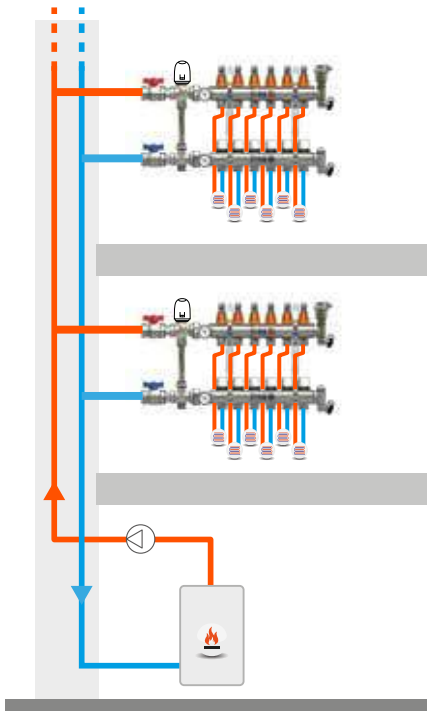

ZONE VALVES

The zone valves are shutoff and bypass devices that enable control of the flow to distribution terminals such as manifolds. These devices are used in so-called separate zone systems: an ambient thermostat manages opening of the zone valve and thus the flow of heating fluid to the utilities in the relative zone.



Example of zone valve + manifold operation

Versions are available with piston control via suitable electro-thermal actuators or ball controlled versions controlled by rotary servomotors.

VZ range valves with piston inserts are 3-way bypass valves (one inlet and two outlets): available in stand-alone versions (VZ30) or with bypass kit for third way balancing and provision for connection to manifolds with centre-to-centre distance 200 mm (VZ 00).

Correct operation requires the valve to be open on the straight section in the event of heat demand in the zone, while the flow is bypassed along the central way of the bypass when the zone is off.

VZ 00 versions are also equipped with a bypass tee fitting with integrated balancing device: this enables the creation on the third central way of the same pressure drop generated by the circuits downline of the zone valve, so that the system is always balanced even during operation bypass mode.

Alternatively, the VZS range includes the ball zone valves. This type is used to reduce pressure drops and is therefore ideal mainly in situations where high flow rates are required. They also feature relatively low manoeuvre times thanks to the AVZS actuators which trigger opening/closure of the valve in 25 s – 50 s – 90 s, depending on the selected model.

This range also includes the models VZS 05, i.e. a 2-way ball zone valve used in zone systems served by electronic high-performance variable-speed circulation pumps, and VZS 10 which is a bypass valve with inlet from the central way.

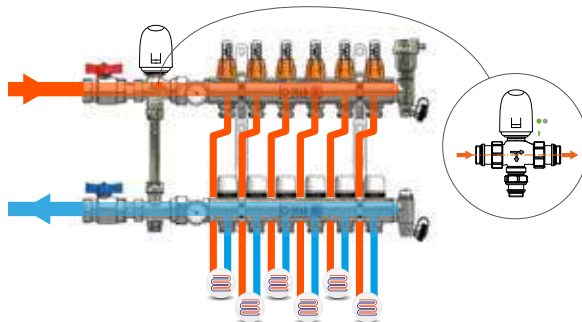

Zone valve + manifolds, flow with ON

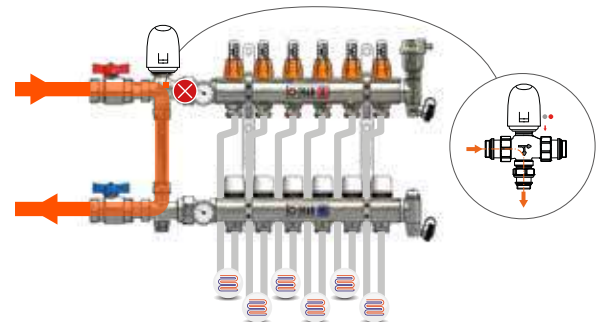

Zone valve + manifolds, flow with OFF

MANIFOLDS KIT WIDTH AND SUITABLE CABINET

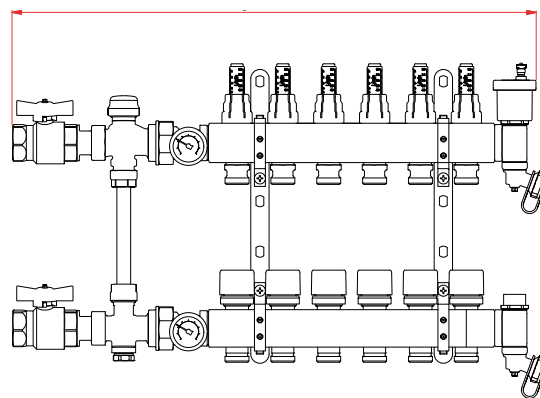

Manifold ways	2 Vie	3 Vie	4 Vie	5 Vie	6 Vie	7 Vie	8 Vie	9 Vie	10 Vie	11 Vie	12 Vie	13 Vie	
Brass 1" manifolds kit width	370 mm	420 mm	470 mm	520 mm	570 mm	620 mm	670 mm	720 mm	770 mm	820 mm	870 mm	920 mm	
Stainless steel 1" manifolds kit width	388 mm	438 mm	488 mm	538 mm	588 mm	638 mm	688 mm	738 mm	788 mm	838 mm	888 mm	938 mm	
Technopolymer 1" manifolds kit width	449 mm	499 mm	549 mm	599 mm	649 mm	699 mm	749 mm	799 mm	849 mm	899 mm	949 mm	999 mm	
 AC 840	Cabinet code	200686	200686	200186	200186	200786	200786	200286	200286	200886	200886	200386	200386
	Cabinet width	600 mm	600 mm	700 mm	700 mm	800 mm	800 mm	900 mm	900 mm	1.000 mm	1.000 mm	1.100 mm	1.100 mm

VZ 00

- Valvola di zona a pistone con bypass regolabile e memoria di posizione per collettori.
- Piston zone valve with adjustable bypass and position memory for manifolds.
- Vanne de zone à piston avec bypass réglable et mémoire de position pour collecteurs.
- Zonenventil mit Kolben mit einstellbarem Bypass und Einstellungsspeicher für Verteiler.
- Válvula de zona de pistón con bypass regulable y memoria de posición para colectores.

Code	Size	OC distance	Depth	Price	Class	Packaging
550700	3/4" O-ring	200 mm	110 mm	89,55 €	NY	1 / 10
550715P80	1" O-ring	200 mm	80 mm	92,10 €	NY	1
550715	1" O-ring	200 mm	110 mm	92,10 €	NY	1 / 10

VZ 30

- Valvola di zona deviatrice a pistone a 3 vie.
- 3-way diverter piston zone valve.
- Vanne de zone déviatrice à piston à 3 voies.
- 3-Wege-Zonenumschaltventil mit Kolben.
- Válvula de zona desviadora de pistón de 3 vías.

Code	Size	Price	Class	Packaging
550710	3/4" M O-ring x 1/2" M O-ring x 3/4" M O-ring	46,88 €	NY	1 / 32
550711	1" M O-ring x 1/2" M O-ring x 1" M O-ring	47,17 €	NY	1 / 32



• TE 3040 IV >> p. 141,220,361,477,488



• TE 3040 >> p. 220,360,397,477,488



• TE 3050 MC >>p. 141,220,361,477,488



• TE 3050 M >> p. 220,360,397,477,488

■ VZS 20



- Valvola di zona a sfera per collettori.
- Ball zone valve for manifolds.
- Vanne de zone à bille pour collecteurs.
- Zonenkugelventil für Verteiler.
- Válvula de zona de bola para colectores.

Code	Size	OC distance	Depth	Price	Class	Packaging
506230	3/4" O-ring	200 mm	110 mm	125,83 €	NX	1
506231P80	1" O-ring	200 mm	80 mm	169,26 €	NX	1 / 4
506231	1" O-ring	200 mm	110 mm	173,24 €	NX	1

■ VZS 21



- Valvola di zona a sfera per collettori.
- Ball zone valve for manifolds.
- Vanne de zone à bille pour collecteurs.
- Zonenkugelventil für Verteiler.
- Válvula de zona de bola para colectores.

Code	Size	OC distance	Depth	Price	Class	Packaging
506230L	3/4" O-ring	250 mm	110 mm	133,54 €	NX	1
506231L	1" O-ring	250 mm	110 mm	179,65 €	NX	1

■ VZS 10



- Valvola di zona a sfera deviatrice a 3 vie.
- 3-way diverter ball zone valve.
- Vanne de zone à bille déviatrice à 3 voies.
- 3-Wege-Zonenumschaltkugelventil.
- Válvula de zona de bola desviadora con 3 vías.

Code	Size	Price	Class	Packaging
506220	3/4" O-ring x 3/4" O-ring x 3/4" O-ring	84,76 €	NX	1
506221	1" O-ring x 1" O-ring x 1" O-ring	115,08 €	NX	1 / 4

■ VZS 00



- Valvola di zona a sfera a 2 vie.
- 2-way ball zone valve.
- Vanne de zone à bille à 2 voies.
- 2-Wege-Zonenkugelventil.
- Válvula de zona de bola con 2 vías.

Code	Size	Price	Class	Packaging
506210	3/4" M O-ring	48,66 €	NX	1 / 32
506211	1" M O-ring	61,99 €	NX	1
506212	1"1/4 M O-ring	85,47 €	NX	1

■ VZS 05



- Valvola di zona a sfera a 2 vie con doppio bocchettone.
- 2-way ball zone valve with double fitting.
- Vanne de zone à bille à 2 voies avec double embout.
- 2-Wege-Zonenkugelventil mit doppelt Selbstdichtendsstutzen.
- Válvula de zona de bola con 2 vías con doble manguito de unión.

Code	Size	Price	Class	Packaging
506222	3/4" M O-ring x 3/4" M O-ring	63,29 €	NX	1 / 32
506223	1" M O-ring x 1" M O-ring	82,26 €	NX	1 / 32
506224	1"1/4 M O-ring x 1"1/4 M O-ring	122,29 €	NX	1 / 8

AC 656

- Kit valvole di zona a sfera completo di servomotori AVZS 10 (230 V) per la commutazione del circuito primario estate/inverno (chiller/ caldaia).
- Ball zone valve kit complete with AVZS 10 motors (230 V) for the switching of the summer/winter primary circuit (chiller/boiler).
- Kit de vannes de zone à bille complet de servomoteurs AVZS 10 (230 V) pour la commutation du circuit primaire été/hiver (chiller/ chaudière).
- Zonenkugelventile Kit mit AVZS 10 Stellantriebe (230 V) zum Umschalten des Hauptkreises von Sommer- auf Winterbetrieb und umgekehrt (Chiller/Heizung).
- Conjunto válvulas de zona de bola completo de servomotores AVZS 10 (230 V) para la conmutación del circuito primario verano/invierno (enfriador/caldera).

Code	Size	Price	Class	Packaging
506410	1" O-ring x 1" O-ring x 1" O-ring	602,09 €	NX	1

AVZS 02

- Servomotore per valvole di zona a sfera a 2 vie.
- Servo motor for 2-way ball zone valves.
- Servomoteur pour vannes de zone à bille à 2 voies.
- Stellantriebe für 2-Wege-Zonenkugelventile.
- Servomotor para válvulas de zona de bola con 2 vías.

Code	Size	Price	Class	Packaging
506166	230 V - 90 sec.	141,82 €	NN	1 / 8

AVZS 00

- Servomotore per valvole di zona a sfera.
- Servo motor for ball zone valves.
- Servomoteur pour vannes de zone à bille.
- Stellantriebe für Zonenkugelventile.
- Servomotor para válvulas de zona de bola.

Code	Size	Price	Class	Packaging
506241	230 V AC - 50 sec.	178,16 €	NN	1

AVZS 10

- Servomotore per valvole di zona a sfera con dispositivo di sblocco.
- Servo motor for ball zone valves with release device.
- Servomoteur pour les vannes de zone à bille avec dispositif de déblocage.
- Stellantriebe für Zonenkugelventile mit Entriegelungsvorrichtung.
- Servomotor para válvulas de zona de bola con dispositivo de desbloqueo.

Code	Size	Price	Class	Packaging
506242	24 V AC - 50 sec.	190,26 €	NN	1
506243	230 V AC - 50 sec.	189,32 €	NN	2 / 8

AVZS 11

- Servomotore per valvole di zona a sfera con dispositivo di sblocco.
- Servo motor for ball zone valves with release device.
- Servomoteur pour les vannes de zone à bille avec dispositif de déblocage.
- Stellantriebe für Zonenkugelventile mit Entriegelungsvorrichtung.
- Servomotor para válvulas de zona de bola con dispositivo de desbloqueo.

Code	Size	Price	Class	Packaging
506242V	24 V AC - 25 sec.	192,45 €	NN	1
506243V	230 V AC - 25 sec.	190,08 €	NN	1 / 8

AVZS 01

- Servomotore per valvole di zona a sfera.
- Servo motor for ball zone valves.
- Servomoteur pour vannes de zone à bille.
- Stellantriebe für Zonenkugelventile.
- Servomotor para válvulas de zona de bola.

Code	Size	Price	Class	Packaging
506241V	230 V AC - 25 sec.	188,54 €	NN	1



RADIANT SYSTEMS

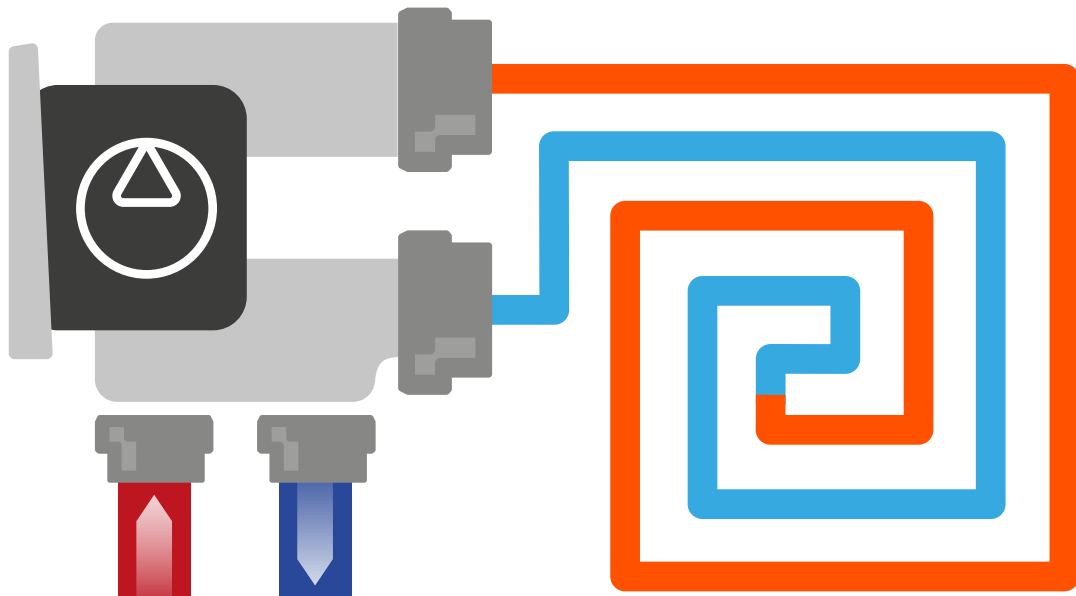

pim.ivar-group.com/short/IT-04

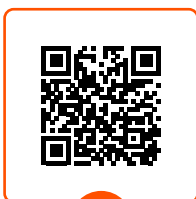

DOWNLOAD
Focus tecnici



pim.ivar-group.com/short/FR-04

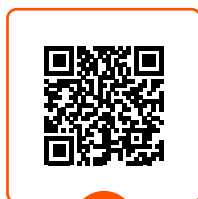

DOWNLOAD
Détails techniques



pim.ivar-group.com/short/DE-04

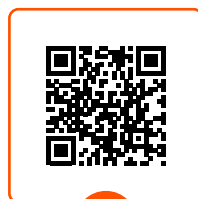







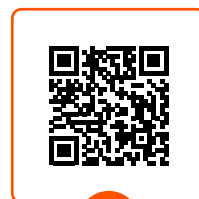



DOWNLOAD
Technische Details



pim.ivar-group.com/short/ES-04



DOWNLOAD
Profundizaciones técnicas

	<p>FLOORMIX - Sistema per riscaldamento radiante <i>FLOORMIX - System for radiant heating</i> FLOORMIX - Système pour chauffage radiant <i>FLOORMIX - System für Flachheizung</i> FLOORMIX - Sistema para calefacción radiante</p>	234
	<p>Valvole assiali a 2 vie per elevate portate <i>2-way axial valves for high flow capacity</i> Robinets axials à 2 voies pour débit élevé <i>2-Wege axiale Ventile für erhöhte Durchfluss</i> Válvulas axiales de 2 vías para caudales elevados</p>	237
	<p>COMBIMIX - Gruppo di miscelazione e rilancio per sistemi radianti <i>COMBIMIX - Mixing and pump unit for radiant systems</i> COMBIMIX - Groupe de mélange et relance pour systèmes radiants <i>COMBIMIX - Misch- und Versorgungsgruppe für Flachheizung-Systeme</i> COMBIMIX - Grupo de mezcla y relanzamiento para los sistemas radiantes</p>	238
	<p>TECHNOMIX - Gruppo di miscelazione e rilancio per sistemi radianti <i>TECHNOMIX - Mixing and pump unit for radiant systems</i> TECHNOMIX - Groupe de mélange et relance pour systèmes radiants <i>TECHNOMIX - Misch- und Versorgungsgruppe für Flachheizung-Systeme</i> TECHNOMIX - Grupo de mezcla y relanzamiento para los sistemas radiantes TECHNOMIX</p>	244
	<p>MULTIFLOOR - Gruppo di miscelazione e rilancio per sistemi radianti <i>MULTIFLOOR - Mixing and pump unit for radiant systems</i> MULTIFLOOR - Groupe de mélange et relance pour systèmes radiants <i>MULTIFLOOR - Misch- und Versorgungsgruppe für Flachheizung-Systeme</i> MULTIFLOOR - Grupo de mezcla y relanzamiento para los sistemas radiantes</p>	245
	<p>UNIMIX - Gruppo di miscelazione e rilancio per sistemi radianti <i>UNIMIX - Mixing and pump unit for radiant systems</i> UNIMIX - Groupe de mélange et relance pour systèmes radiants <i>UNIMIX - Misch- und Versorgungsgruppe für Flachheizung-Systeme</i> UNIMIX - Grupo de mezcla y relanzamiento para los sistemas radiantes</p>	246
	<p>UNIMIX•C - Gruppo di miscelazione e rilancio per sistemi radianti <i>UNIMIX•C - Mixing and pump unit for radiant systems</i> UNIMIX•C - Groupe de mélange et relance pour systèmes radiants <i>UNIMIX•C - Misch- und Versorgungsgruppe für Flachheizung-Systeme</i> UNIMIX•C - Grupo de mezcla y relanzamiento para los sistemas radiantes</p>	250
	<p>Accessori per gruppi di miscelazione e rilancio UNIMIX - UNIMIX•C <i>Accessories for mixing and pump units UNIMIX - UNIMIX•C</i> Accessories for mixing and pump units UNIMIX - UNIMIX•C <i>Accessories for mixing and pump units UNIMIX - UNIMIX•C</i> Accessories for mixing and pump units UNIMIX - UNIMIX•C</p>	252
	<p>UNIFLOOR - Unità di miscelazione e distribuzione per singolo circuito radiante <i>UNIFLOOR - Mixing and distribution unit for single radiant circuit</i> UNIFLOOR - Unité de mélange et distribution pour single circuit radiant <i>UNIFLOOR - Misch- und Verteilungs-Modul für einzel Flachheizung-Schaltung</i> UNIFLOOR - Unidad de mezcla y distribución para circuito radiante único</p>	254
	<p>Circolatori <i>Pumps</i> Pompes <i>Pumpen</i> Bombas</p>	255

	<p>IC•BOX - Sistema radiante compatto senza miscelazione <i>IC•BOX - Non-mixed compact radiant system</i> IC•BOX - Système radiant compact sans mélange <i>IC•BOX - Kompakte Fussbodenheizung-System ohne Mischeinheit</i> IC•BOX - Sistema radiante compatto sin mezcla</p>	256
	<p>Pannelli per sistemi a pavimento <i>Panels for radiant floor systems</i> Panneaux pour plancher chauffant <i>Platte für Fussbodenheizung</i> Paneles para piso radiante</p>	260
	<p>Sistemi radianti a soffitto/parete <i>Radiant ceiling/wall systems</i> Systèmes à plafond/parois chauffante <i>Decke-/Wand-Heizungssysteme</i> Sistemas de techo/pared radiante</p>	276
	<p>Accessori per sistemi a pavimento <i>Accessories for radiant floor systems</i> Accessoires pour plancher chauffant <i>Zubehör für Fussbodenheizung</i> Accesorios para piso radiante</p>	280
	<p>Accessori per sistemi radianti a soffitto/parete <i>Accessories for radiant ceiling/wall systems</i> Accessoires pour plafond/parois chauffante <i>Zubehör für Decke-/Wand-Heizung</i> Accesorios para techo/pared radiante</p>	283
	<p>Deumidificatori <i>Dehumidifiers</i> Deshumidificateurs <i>Luftentfeuchter</i> Deshumidificadores</p>	285

FLOORMIX

For radiant heating it is essential to control the flow temperature of the fluid in the circuit in an effective manner and to assure the design flow. FLOORMIX is a simple modular system that provides the components to carry out these important functions: a pair of fittings that make it possible to install a booster pump and service and safety components, and a series of accessories that make it possible to regulate delivery temperature. In particular, a two-way valve regulates with fixed point control (thermostatic head) or temperature control (servo motor, electronic controller and external probe) the hot water flow to mixing, which takes place directly in the return manifold. FLOORMIX is complemented by the IVAR manifold kits with pre-mounted inserts for balancing and controlling the individual zones. Power (*): 12 kW approx.

*Boiler temperature 60 °C; delivery temperature to radiant installation 40 °C with 7 °C thermal gradient; 8-way distribution manifolds

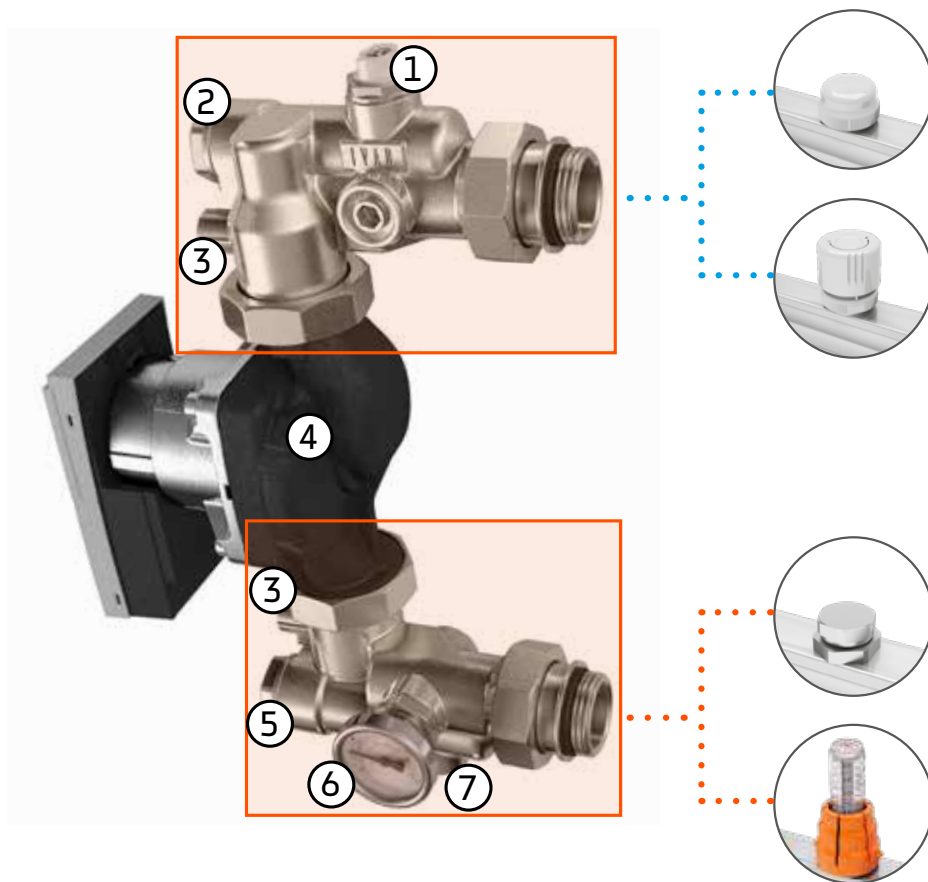

□ TWO MULTI-FUNCTION FITTINGS

1. Air-vent valve
2. Flow temperature sensor
3. Pump isolation valves
4. Booster pump
5. Safety thermostat pocket
6. Thermometer
7. Fill/drain valve connection

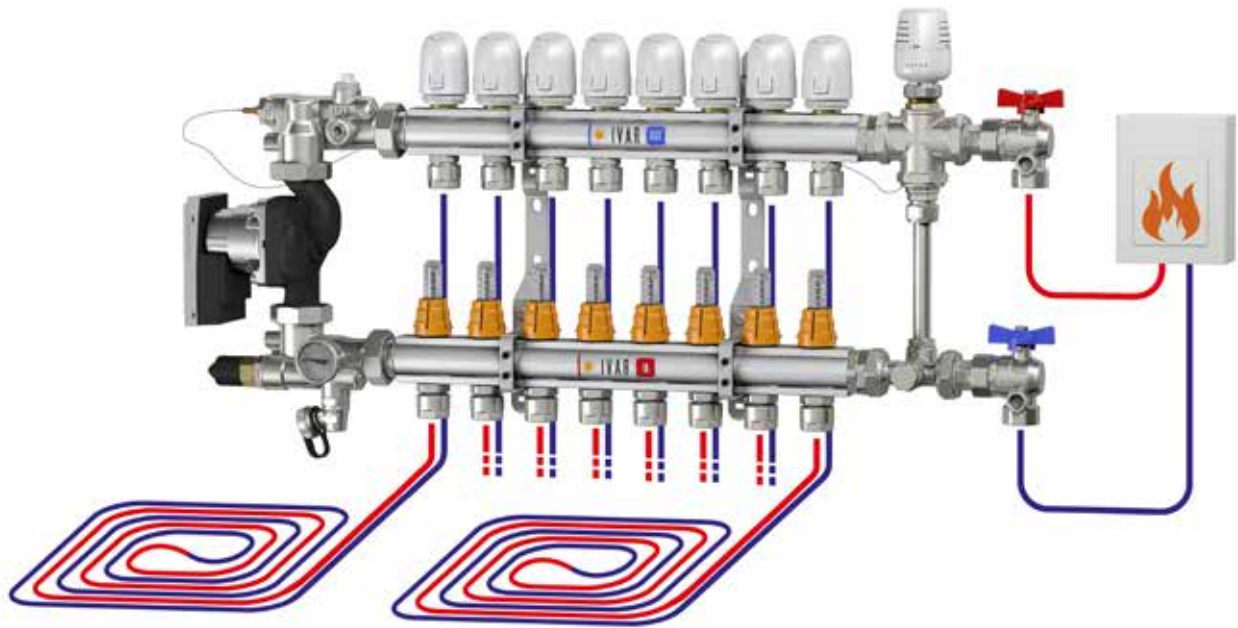

FOCUS: mixing kits



Fixed-point adjustment



Two-way valve with pre-mixing port



Two-way valve

OR



Weather-compensated adjustment



Two-way valve with pre-mixing port



Two-way valve

■ AC 702



- Gruppo collegamento pompa per sistema FLOORMIX.
- Pump connection unit for the FLOORMIX system.
- Groupe de raccordement de pompe pour système FLOORMIX.
- Pumpenanschlußgruppe für System FLOORMIX.
- Grupo de conexión bomba para sistema FLOORMIX.

Code	Price	Class	Packaging
506075	165,88 €	NL	1 / 8

■ AC 664/L



- Kit di premiscelazione a punto fisso per sistema FLOORMIX.
- Fixed setting premixing kit for the FLOORMIX system.
- Kit de prémélange à point fixe pour système FLOORMIX.
- Vormischung festwert Regelung Kit für System FLOORMIX.
- Kit de pré-mistura com ponto fixo para sistema FLOORMIX.

Code	Size	Price	Class	Packaging
500147	Pump 130 mm	187,23 €	NL	1 / 6
500147L	Pump 180 mm	188,55 €	NL	1

■ DD 321



- Detentore diritto con bocchettone a tenuta morbida.
- Straight lockshield with soft seal pipe union.
- Raccord droit avec tubulure de raccordement à joint souple étanche.
- Rucklaufventil Durchgangsform mit Selbstdichtendsutzen.
- Detentor recto con manguito de unión con junta blanda.

Code	Size	Price	Class	Packaging
500645RC	3/4" F x 1" M O-ring	15,66 €	DA	10 / 80

■ WILO4F



- Circolatore elettronico a velocità variabile (Conforme alla direttiva europea 2009/125/CE - ErP ,Energy related Products').
- Variable speed electronic circulator (In accordance with European Directive 2009/125/CE - ErP "Energy related Products").
- Circulateur chauffage électronique à vitesse variable (Conforme à la Directive Européenne 2009/125/CE - ErP "Energy related Products").
- Elektronische Umwälzpumpe mit variabler Geschwindigkeit (Entspricht der Europaischen Richtlinie 2009/125/CE - ErP "Energy related Produkts").
- Circulador electrónico de velocidad variable (Conforme a la directiva europea 2009/125/CE - ErP ,Energy related Products').

Code	Size	Head loss	Price	Class	Packaging
WILO4F	1"1/2 - 130 mm	6 m	312,00 €	HK	3
WILO4F-180	1"1/2 - 180 mm	6 m	336,07 €	HK	3

■ AC 662



- Valvola di bilanciamento per sistema FLOORMIX.
- Balancing valve for FLOORMIX system.
- Vanne d'équilibrage pour système FLOORMIX.
- Ausgleichventil für FLOORMIX-System.
- Válvula de equilibrio para sistema FLOORMIX.

Code	Size	Price	Class	Packaging
500527	1"	26,22 €	NL	2 / 64

■ AC 664 M/ML



- Kit di premiscelazione motorizzabile per sistema FLOORMIX.
- Motorized premixing kit for the FLOORMIX system.
- Kit de prémélange motorisable pour système FLOORMIX.
- Vormischung festwert Regelung Kit für Mischermotor für System FLOORMIX.
- Kit de premezclado motorizable para sistema FLOORMIX.

Code	Size	Price	Class	Packaging
500147M	Pump 130 mm	136,84 €	NL	1 / 6
500147ML	Pump 180 mm	138,10 €	NL	1

■ DS 322



- Detentore a squadra con bocchettone a tenuta morbida.
- Angle lockshield with soft seal pipe union.
- Raccord équerre avec tubulure de raccordement à joint souple étanche.
- Rucklaufventil Eckform mit Selbstdichtendsutzen.
- Detentor de escuadra con manguito de unión con junta blanda.

Code	Size	Price	Class	Packaging
500634RC	3/4" F x 1" M O-ring	15,58 €	DA	10 / 80

■ WILO3F



- Circolatore standard a 3 velocità.
- 3-speed standard circulator.
- Circulateur standard à 3 vitesses.
- Umwälzpumpe mit 3 Geschwindigkeitsstufen.
- Circulador estándar de 3 velocidades.

Code	Size	Head loss	Price	Class	Packaging
WILO3F	1"1/2 - 130 mm	6 m	216,14 €	HK	5
WILO3F-180	1"1/2 - 180 mm	6 m	230,63 €	HK	1

■ AC 633



- Distanziatore filettato per pompe.
- Threaded spacer for pumps.
- Ecarteur fileté pour pompes.
- Zwischenstück mit Gewinde für Pumpen.
- Distanciador roscado para bombas.

Code	Size	Price	Class	Packaging
500933	1"1/2 - 130 mm	29,19 €	HK	25
500934	1"1/2 - 180 mm	30,92 €	HK	20

2-WAY AXIAL VALVES

VDS 01



- Valvola termostattizzabile a squadra/diritta per elevate portate.
- Angle/straight thermostatic valve for high flow capacity
- Robinet thermostatisable équerre/droite pour débit élevé.
- Thermostatisierbares Ventil Eckform/Durchgangsform für erhöhte Durchfluss.
- Válvula termostattizable de escuadra/recta para caudales elevados.

Code	Size	Price	Class	Packaging
500388	3/4" F x 3/4" M O-ring	40,40 €	BA	5 / 40
500403	3/4" F x 1" M O-ring	42,00 €	BA	5 / 40

T 5011



- Testa termostatica con comando incorporato e sensore remoto a immersione.
- Thermostatic head with incorporated command and remote immersion sensor.
- Tête thermostatique avec commande incorporée et senseur à distance à immersion.
- Thermostat-Kopf mit eingebauter Steuerung und Eintauch-Fernfühler.
- Cabeza termostática con mando incorporado y sensor remoto por inmersión.

Code	Size	Range	Length	Price	Class	Packaging
501175	M30 x 1,5 - 1/2"	20-60 °C	2 m	53,29 €	AA	5 / 40

T 5012



- Testa termostatica con comando incorporato e sensore remoto a contatto.
- Thermostatic head with incorporated command and remote contact sensor
- Tête thermostatique avec commande incorporée et senseur à distance à contact.
- Thermostat-Kopf mit eingebauter Steuerung und Berührungs-Fernfühler.
- Cabeza termostática con mando incorporado y sensor remoto de contacto.

Code	Size	Range	Length	Price	Class	Packaging
501176	M30 x 1,5	20-60 °C	2 m	45,95 €	AA	5 / 40

AGE 13



- Pozzetto porta sonda per teste termostatiche T 5011 e T 5011 U.
- Thermometer well for T 5011 and T 5011 U thermostatic heads.
- Doigt de gant porte-sonde pour têtes thermostatiques T 5011 et T 5011 U.
- Tauchhulse Halterung für Thermostatköpfe T 5011 und T 5011 U.
- Termopozo para sonda para cabezas termostáticas T 5011 y T 5011 U.

Code	Actuator	Size	Price	Class	Packaging
500530	T 5011	1/2"	11,82 €	AE	25 / 200
500530U	T 5011 U	1/2"	12,62 €	AE	25 / 200

AGE 12



- Kit piastrina e molle per teste termostatiche T 5012.
- Plate and springs kit for T 5012 thermostatic heads.
- Kit plaquette et ressorts pour têtes thermostatiques T 5012.
- Platte- und Federsatz für Thermostatköpfe T 5012.
- Conjunto plaquetas y muelle para cabezas termostáticas T 5012.

Code	Actuator	Price	Class	Packaging
509200	T 5012	5,91 €	AE	25 / 200

VDS 02



- Valvola motorizzabile a squadra/diritta per elevate portate.
- Angle/straight motorized valve for high flow capacity.
- Robinet motorisable équerre/droite pour débit élevé.
- Motorisierbares Ventil Eckform/Durchgangsform für erhöhte Durchfluss.
- Válvula motorizable de escuadra/recta para caudales elevados.

Code	Size	Price	Class	Packaging
500388M	3/4" F x 3/4" M O-ring	46,01 €	BA	5 / 40
500403M	3/4" F x 1" M O-ring	46,01 €	BA	5 / 40

RV 01



- Servomotore assiale. Compatibile con tutti i vitoni termostatici IVAR.
- Axial motor. Suitable for all IVAR thermostatic inserts.
- Servomoteur axial. Adapté pour tous les inserts thermostatiques IVAR.
- Axial-Stellantrieb. Geeignet für alle Thermostat-Regulier Vorrichtungen IVAR.
- Servomotor axial. Adecuado para todos los tornillos termostáticos IVAR.

Code	Size	Price	Class	Packaging
501381	M30 x 1,5 - 3-point regulation (230 V AC)	141,88 €	PC	100
501383	M30 x 1,5 - Proportional 0-10 V (24 V AC/DC)	164,60 €	PC	100



- CLIMA-HUB - Regolatore elettronico per impianti di riscaldamento e raffrescamento >>p. 351
- CLIMA-HUB - Electronic controller for heating and cooling systems >>p. 351
- CLIMA-HUB - Régulateur électronique pour systèmes de chauffage et de refroidissement >>p. 351
- CLIMA-HUB - Elektronischer Regler für Heiz- und Kühlsysteme >>p. 351
- CLIMA-HUB - Regulador electrónico para sistemas de calefacción y refrigeración >>p. 351

TE 3061



- Testa elettrotermica normalmente chiusa (comando proporzionale 0-10 V). Compatibile con tutti i vitoni termostattizzabili IVAR.
- Electrothermal head normally closed (proportional control 0-10 V). Suitable for all IVAR thermostatic inserts.
- Tête électrothermique normalement fermée (commande proportionnel 0-10 V). Adaptée pour tous les inserts thermostatiques IVAR.
- Elektrothermischer Stellantrieb normalerweise geschlossen (proportional Steuerung 0-10 V). Geeignet für alle Thermostat-Regulier Vorrichtungen IVAR.
- Cabeza electrotrémica normalmente cerrada (control proporcional 0-10 V). Adecuada para todos los tornillos termostattizables IVAR.

Code	Size	Price	Class	Packaging
500887	M30 x 1,5 ; Proportional 0-10 V (24 V AC)	126,64 €	AC	100

COMBIMIX

COMBIMIX is a mixing and boosting unit for radiant systems. The delivery temperature is controlled by a 2-way valve, which regulates the inflow of hot water to the mixing station ("injection" system). The unit is available in a version with fixed point control and thermostat head or climate controlled with servomotor, to be integrated with electronic regulator with external probe.

Complete with valves for balancing, shutoff, air purge and draining/filling, COMBIMIX combines all essential functions in a compact and easily accessible unit. The unit can be combined with an IVAR kit of manifolds in brass or stainless steel with pre-assembled inserts for balancing and control of individual zones, and can be joined with kit of horizontal or vertical manifolds, fitted upline of mixing to supply high temperature heating elements.

Power (*): approx. 14 kW.

*Boiler temperature 60 °C; delivery temperature with radiant system 40 °C with temperature variation of 7 °C; 8-way distribution manifolds

MIXING UNIT

1. 2-way control valve with motor drive or controlled by thermostat head
2. Mixing balancing valve

BOOSTER UNIT

3. High-efficiency variable rpm pump; centre-to-centre distance 130 mm or 180 mm
4. Shutoff ball valve

ACCESSORIES

5. Filler/drain valves
6. Automatic air purge valves
7. Thermometers

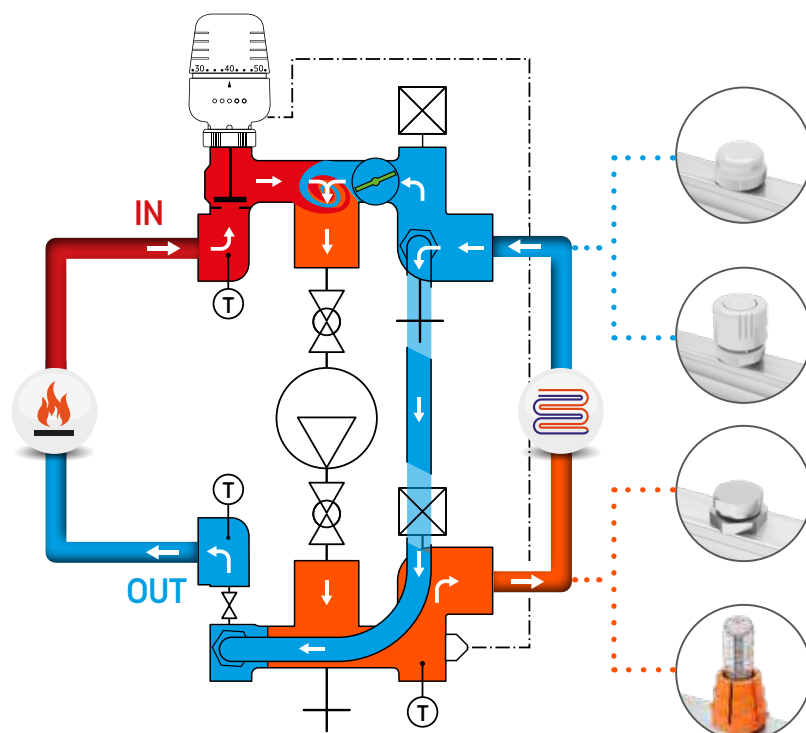
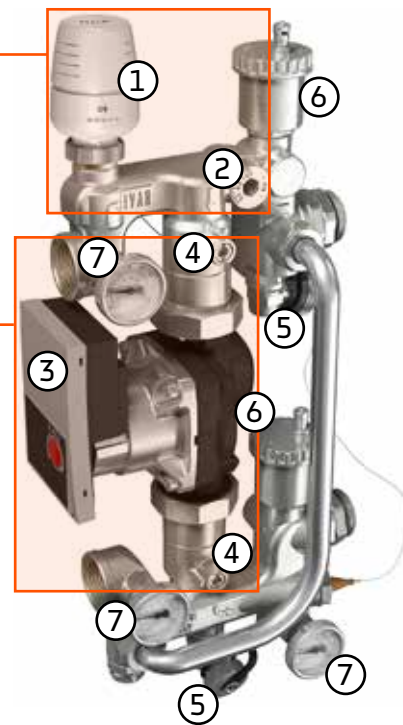

⊕ PLUS

- Complete compact system for radiant system control
- Fixed point or climate control
- Two-way mixing control valve
- Pump centre-to-centre distance 130 mm or 180 mm with shutoff valves

🎯 FOCUS: kit per alta temperatura

The COMBIMIX system offers two options to supply high temperature components directly using the boiler fluid:

1. **horizontal** version, with standard manifolds connected to the primary connectors on COMBIMIX using two AC 606 nipples
2. **vertical** version, using the special kit, including simple or shutoff version manifolds and all required accessories.

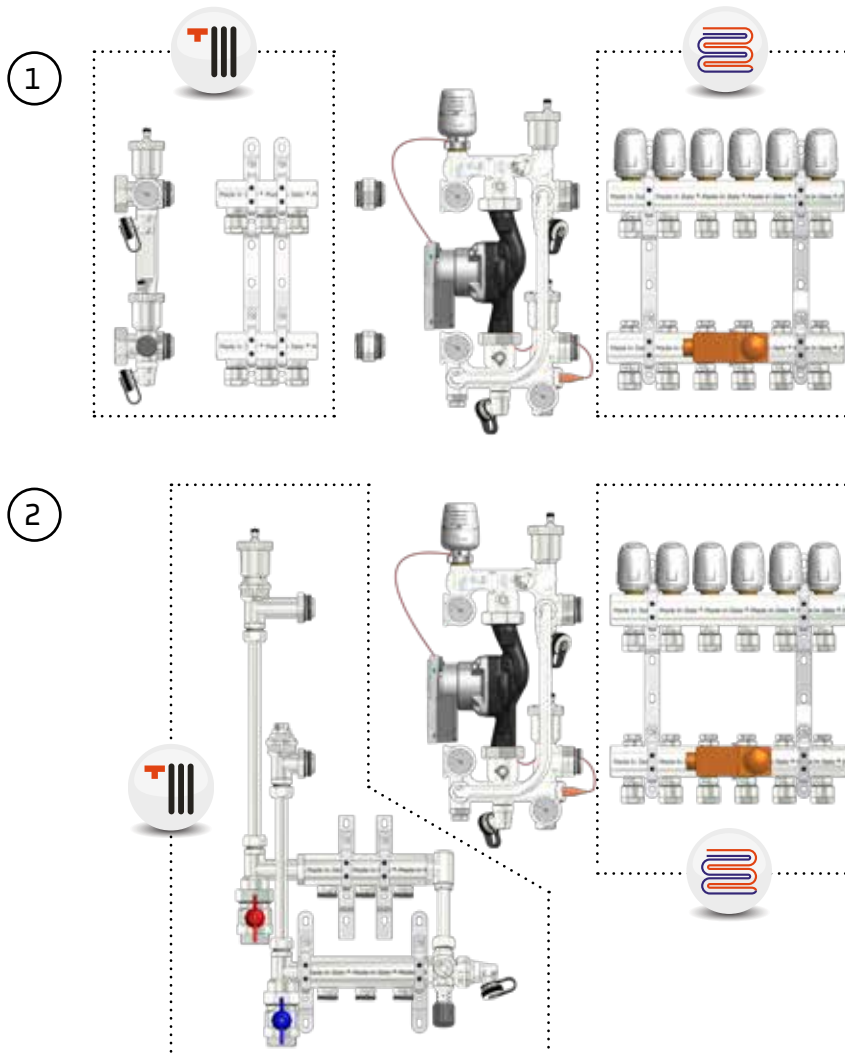

COMBI TNB



- Gruppo di regolazione COMBIMIX a punto fisso per sistemi radianti con/senza pompa elettronica a velocità variabile da 130/180 mm.
- Fixed setting COMBIMIX regulator unit for radiant systems with/without 130/180 mm variable speed electronic pump.
- Groupe de réglage COMBIMIX à point fixe pour systèmes à plancher chauffant avec/sans pompe électronique à vitesse variable de 130/180 mm.
- Fußbodenregulierungseinheit COMBIMIX mit festwert Regelung mit/ohne elektronischer Pumpe mit variabler Geschwindigkeit von 130/180 mm.
- Grupo de regulación COMBIMIX a punto fijo para sistemas de calefacción por suelo radiante con/sin bomba electrónica de velocidad variable de 130/180 mm.

Code	Actuator	Pump	Size	Price	Class	Packaging
500454NB	T 5011		130 mm	497,58 €	NL	1
500410NB	T 5011		180 mm	497,58 €	NL	1
500454PE	T 5011	WILO4F	130 mm	823,67 €	NL	1
500410PE	T 5011	WILO4F-180	180 mm	848,97 €	NL	1

COMBI T



- Gruppo di regolazione COMBIMIX a punto fisso per sistemi radianti con/senza pompa standard a 3 velocità da 130/180 mm.
- Fixed setting COMBIMIX regulator unit for radiant systems with/without 130/180 mm standard 3-speed pump.
- Groupe de réglage COMBIMIX à point fixe pour systèmes à plancher chauffant avec/sans pompe standard à 3 vitesses de 130/180 mm.
- Fußbodenregulierungseinheit COMBIMIX mit festwert Regelung mit/ohne Standardpumpe mit 3 Geschwindigkeiten von 130/180 mm.
- Grupo de regulación COMBIMIX a punto fijo para sistemas de calefacción por suelo radiante con/sin bomba estándar de 3 velocidades de 130/180 mm.

Code	Actuator	Bypass	Pump	Size	Price	Class	Packaging
500454	T 5011	✓		130 mm	528,50 €	NL	1
500410	T 5011	✓		180 mm	528,50 €	NL	1
500454P	T 5011	✓	WILO3F	130 mm	708,41 €	NL	1

T 5011



- Testa termostatica con comando incorporato e sensore remoto a immersione.
- Thermostatic head with incorporated command and remote immersion sensor.
- Tête thermostatique avec commande incorporée et senseur à distance à immersion.
- Thermostat-Kopf mit eingebauter Steuerung und Eintauch-Fernfühler.
- Cabeza termostática con mando incorporado y sensor remoto por inmersión.

Code	Size	Range	Length	Price	Class	Packaging
501175	M30 x 1,5 - 1/2"	20-60 °C	2 m	53,29 €	AA	5 / 40

COMBI MNB

- Gruppo di regolazione COMBIMIX motorizzabile per sistemi radianti con/senza pompa elettronica a velocità variabile da 130/180 mm.
- COMBIMIX motorized regulation unit for radiant systems with/without 130/180 mm variable speed electronic pump.
- Groupe de réglage COMBIMIX motorisable pour systèmes à plancher chauffant avec/sans pompe électronique à vitesse variable de 130/180 mm.
- Fußbodenregulierungseinheit COMBIMIX mit Regelung durch Stellantriebe mit/ohne elektronischer Pumpe mit variabler Geschwindigkeit von 130/180 mm.
- Grupo de regulación COMBIMIX motorizable para sistemas de calefacción por suelo radiante con/sin bomba electrónica de velocidad variable de 130/180 mm.

Code	Pump	Size	Price	Class	Packaging
501728NB		130 mm	443,23 €	NL	1
501729NB		180 mm	443,23 €	NL	1
501728PE	WILO4F	130 mm	769,33 €	NL	1
501729PE	WILO4F-180	180 mm	794,63 €	NL	1

COMBI M

- Gruppo di regolazione COMBIMIX motorizzabile per sistemi radianti con/senza pompa standard a 3 velocità da 130/180 mm.
- COMBIMIX motorized regulation unit for radiant systems with/without 130/180 mm standard 3-speed pump.
- Groupe de réglage COMBIMIX motorisable pour systèmes à plancher chauffant avec/sans pompe standard à 3 vitesses de 130/180 mm.
- Fußbodenregulierungseinheit COMBIMIX mit Regelung durch Stellantriebe mit/ohne Standardpumpe mit 3 Geschwindigkeiten von 130/180 mm.
- Grupo de regulación COMBIMIX motorizable para sistemas de calefacción por suelo radiante con/sin bomba estándar de 3 velocidades de 130/180 mm.

Code	Bypass	Pump	Size	Price	Class	Packaging
501728	✓		130 mm	474,16 €	NL	1
501729	✓		180 mm	474,16 €	NL	1
501728P	✓	WILO3F	130 mm	654,07 €	NL	1
501729P	✓	WILO3F-180	180 mm	683,58 €	NL	1

RV 01

- Servomotore assiale. Compatibile con tutti i vitoni termostatici IVAR.
- Axial motor. Suitable for all IVAR thermostatic inserts.
- Servomoteur axial. Adapté pour tous les inserts thermostatiques IVAR.
- Axial-Stellantrieb. Geeignet für alle Thermostat-Regulier Vorrichtungen IVAR.
- Servomotor axial. Adecuado para todos los tornillos termostáticos IVAR.

Code	Size	Price	Class	Packaging
501381	M30 x 1,5 - 3-point regulation (230 V AC)	141,88 €	PC	100
501383	M30 x 1,5 - Proportional 0-10 V (24 V AC/DC)	164,60 €	PC	100

TE 3061

- Testa elettrotermica normalmente chiusa (comando proporzionale 0-10 V). Compatibile con tutti i vitoni termostattizzabili IVAR.
- Electrothermal head normally closed (proportional control 0-10 V). Suitable for all IVAR thermostatic inserts.
- Tête électrothermique normalement fermée (commande proportionnel 0-10 V). Adaptée pour tous les inserts thermostatisables IVAR.
- Elektrothermischer Stellantrieb normalerweise geschlossen (proportional Steuerung 0-10 V). Geeignet für alle Thermostat-Regulier Vorrichtungen IVAR.
- Cabeza electrotrémica normalmente cerrada (control proporcional 0-10 V). Adecuada para todos los tornillos termostattizables IVAR.

Code	Size	Price	Class	Packaging
500887	M30 x 1,5 ; Proportional 0-10 V (24 V AC)	126,64 €	AC	100

ACM 01

- Copertura isolante per COMBIMIX.
- Insulating cover for COMBIMIX.
- Couverture isolante pour COMBIMIX.
- Isolierung Box für COMBIMIX.
- Cobertura aislante para COMBIMIX.

Code	Price	Class	Packaging
506255	60,90 €	NL	4

■ CEP/02 I - CEP/03 I



- Kit alta temperatura per COMBIMIX con collettori intercettabili.
- High temperature kit for the COMBIMIX system with manifolds with isolation valves.
- Kit haute température pour COMBIMIX avec collecteurs interceptables.
- Einbausatz Hochtemperatur für COMBIMIX mit absperbare Heizkreise Verteiler.
- Kit alta temperatura para COMBIMIX con colectores interceptables.

Code	Ways	Size	Price	Class	Packaging
502105	2	1" x EUROK	363,80 €	NL	1
502106	3	1" x EUROK	406,22 €	NL	1

■ CEP/02 - CEP/03



- Kit alta temperatura per COMBIMIX con collettori semplici.
- High temperature kit for the COMBIMIX system with plain manifolds.
- Kit haute température pour COMBIMIX avec collecteurs simples.
- Einbausatz Hochtemperatur für COMBIMIX mit Heizkreise Verteiler.
- Kit alta temperatura para COMBIMIX con colectores simples.

Code	Ways	Size	Price	Class	Packaging
502103	2	1" x EUROK	335,79 €	NL	1
502100	3	1" x EUROK	360,40 €	NL	1

■ WILO4F



ErP

- Circolatore elettronico a velocità variabile (Conforme alla direttiva europea 2009/125/CE - ErP ,Energy related Products').
- Variable speed electronic circulator (In accordance with European Directive 2009/125/CE - ErP "Energy related Products").
- Circulateur chauffage électronique à vitesse variable (Conforme à la Directive Européenne 2009/125/CE - ErP "Energy related Products").
- Elektronische Umwälzpumpe mit variabler Geschwindigkeit (Entspricht der Europäischen Richtlinie 2009/125/CE - ErP "Energy related Produkts").
- Circulador electrónico de velocidad variable (Conforme a la directiva europea 2009/125/CE - ErP ,Energy related Products').

Code	Size	Head loss	Price	Class	Packaging
WILO4F	1"1/2 - 130 mm	6 m	312,00 €	HK	3
WILO4F-180	1"1/2 - 180 mm	6 m	336,07 €	HK	3

■ WILO3F



ErP

- Circolatore standard a 3 velocità.
- 3-speed standard circulator.
- Circulateur standard à 3 vitesses.
- Umwälzpumpe mit 3 Geschwindigkeitsstufen.
- Circulador estándar de 3 velocidades.

Code	Size	Head loss	Price	Class	Packaging
WILO3F	1"1/2 - 130 mm	6 m	216,14 €	HK	5
WILO3F-180	1"1/2 - 180 mm	6 m	230,63 €	HK	1

■ AC 633



- Distanziatore filettato per pompe.
- Threaded spacer for pumps.
- Ecarteur fileté pour pompes.
- Zwischenstück mit Gewinde für Pumpen.
- Distanciador roscado para bombas.

Code	Size	Price	Class	Packaging
500933	1"1/2 - 130 mm	29,19 €	HK	25
500934	1"1/2 - 180 mm	30,92 €	HK	20

INSTALLATION LAYOUT

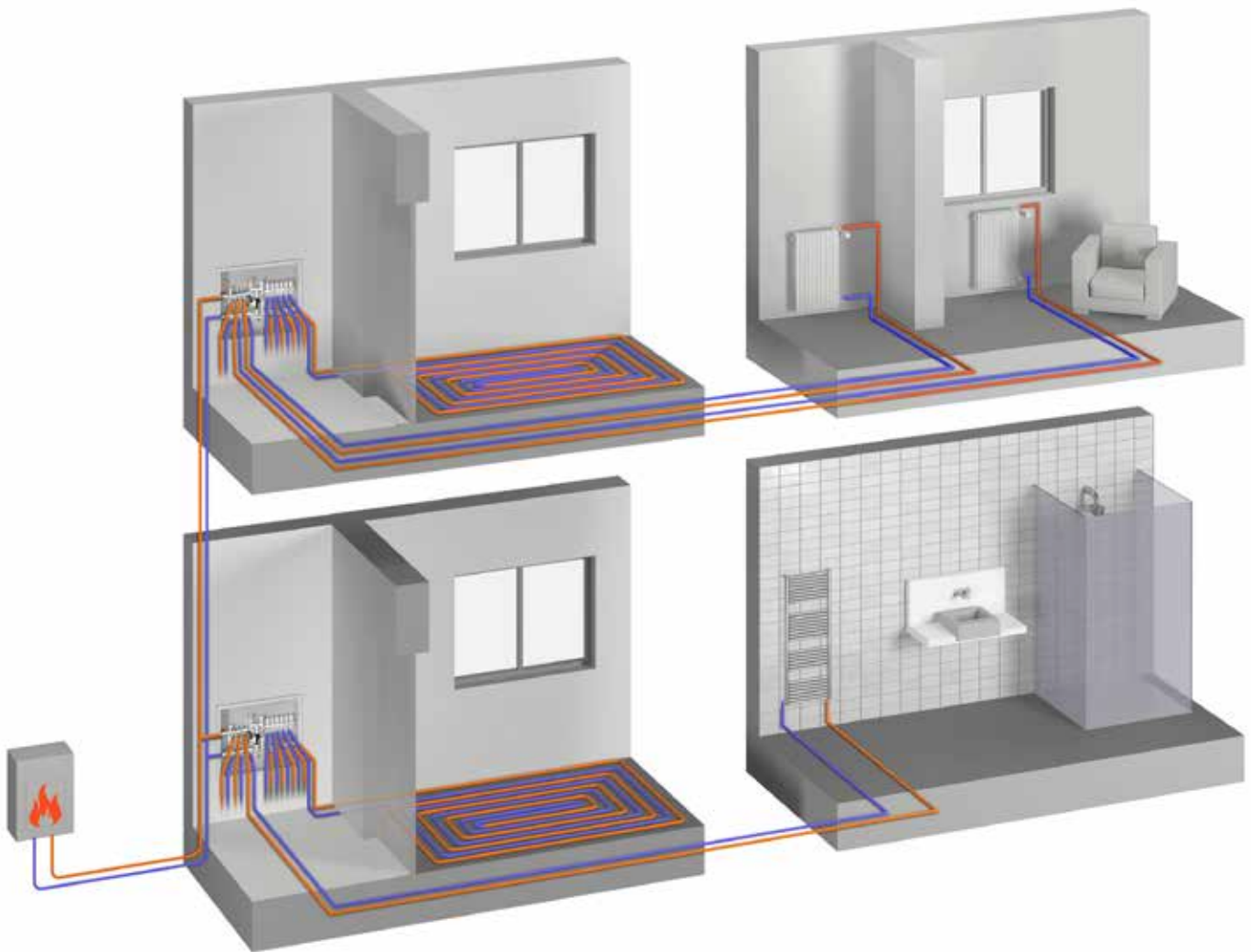

TECHNOMIX

TECHNOMIX is a mixing pump unit for radiant systems. Flow temperature is controlled with a two-way valve, adjusting the quantity of heating/cooling fluid to mixing ("injection" system). The unit is available in version with fixed-point adjustment by thermostatic head, or version suitable to weather-compensated adjustment by servomotor and controller with outdoor sensor. In the latter version, TECHNOMIX can be used also in cooling applications.

Equipped with balancing, shut-off, air-vent and fill/drain valves, TECHNOMIX combines all the necessary functions in a small, easily accessible space. The unit is reversible with inlet from the right or the left, can be completed with IVAR manifolds featuring balancing and control valves on each radiant distribution circuit, and with horizontal- or vertical-structure manifold kits to supply high-temperature heating bodies upstream of the mixing zone.

PLUS

- Temperature control carried out by a two-way valve («injection» system) to obtain maximum compactness.
- Available with fixed point or weather compensated regulation.
- Reversible system: connection to primary from right or left.

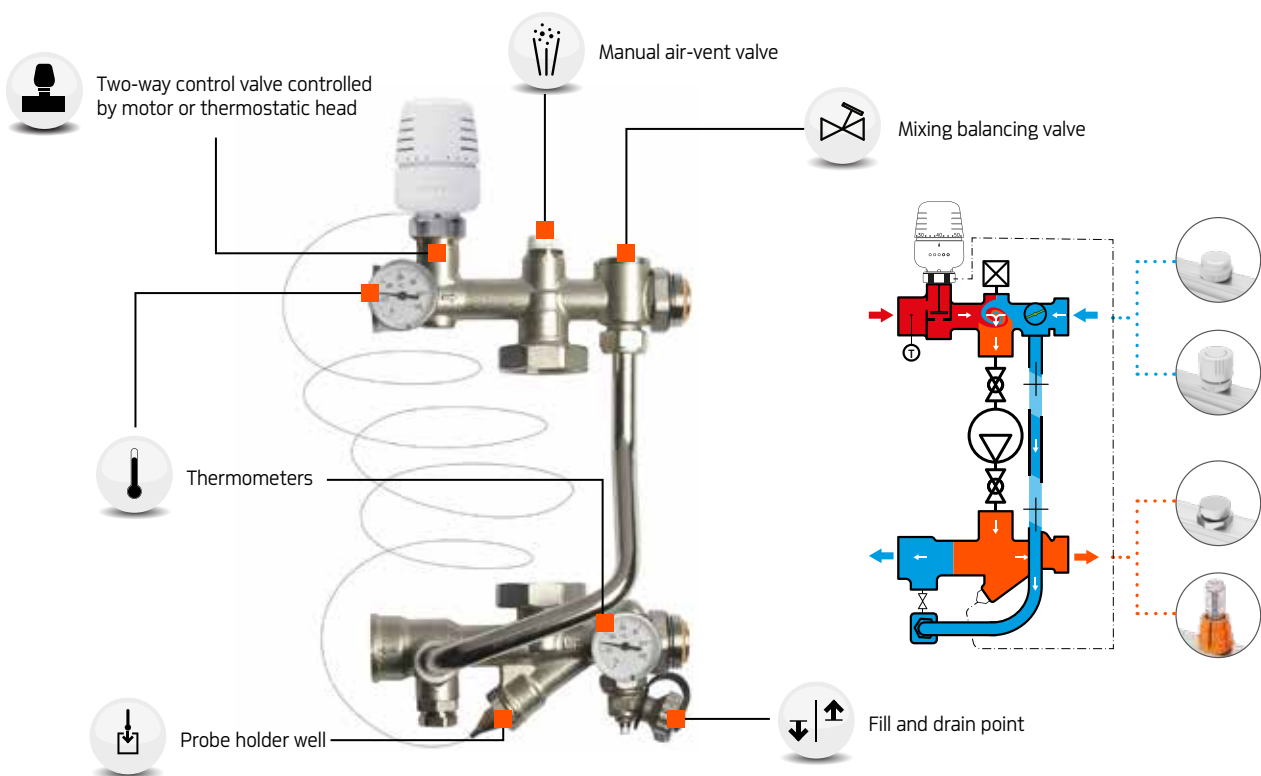

TECHNO TNB



- Gruppo di regolazione TECHNOMIX a punto fisso per sistemi radianti.
- Fixed setting TECHNOMIX regulator unit for radiant systems.
- Groupe de réglage TECHNOMIX à point fixe pour systèmes à plancher chauffant.
- Fußbodenregulierungseinheit TECHNOMIX mit festwert Regelung.
- Grupo de regulación TECHNOMIX a punto fijo para sistemas de calefacción por suelo radiante.

Code	Actuator	Size	Price	Class	Packaging
508100	T 5011	130 mm	422,36 €	NL	1

MULTIFLOOR

MULTIFLOOR is a mixing and boosting unit for radiant underfloor systems. An adjustable thermostatic mixer keeps the delivery temperature stable at the required value, which can be set by means of a simple knob. Complete with supply temperature gauge, safety thermostat, shutoff valve on inlet, air purge/filler valves, MULTIFLOOR offers a ready-to-use solution with compact dimensions and easily accessible, completely reversible for left/right installations. The unit can be integrated with IVAR manifold kits with pre-assembled inserts for balancing and control of individual radiant circuits, and can be completed with horizontal or vertical manifold kits to supply high temperature heating units upline of mixing.

⊕ PLUS

- Integrated thermostatic insert for optimal fixed station control (28-53 °C)
- Designed to control medium size residential systems
- Balancing valve and control integrated on primary circuit

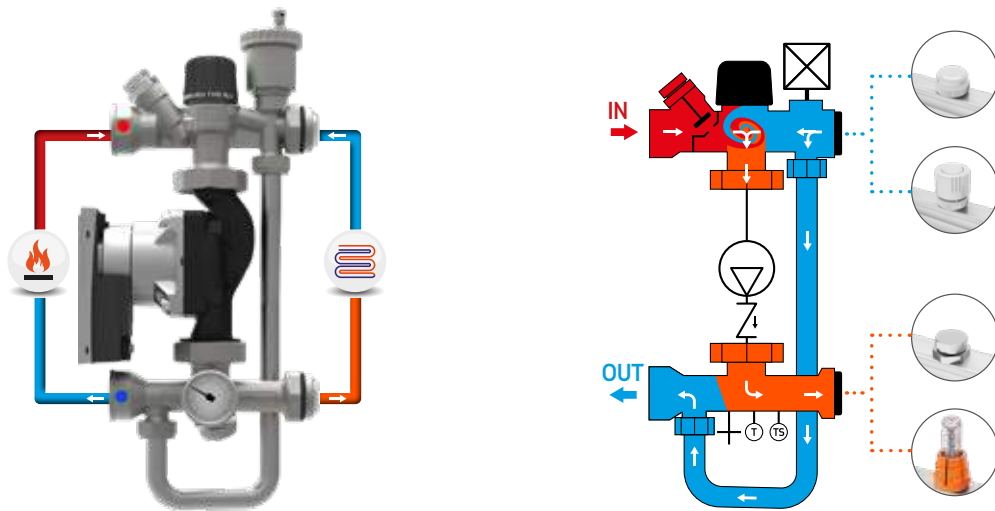

MF 01



- Gruppo di miscelazione e rilancio con/senza pompa da 130 mm per sistemi radianti MULTIFLOOR.
- Mixing and pump kit with/without 130 mm pump for radiant systems MULTIFLOOR.
- Groupe de mélange et relance avec/sans pompe de 130 mm pour systèmes radiants MULTIFLOOR.
- Misch- und Versorgungsgruppe mit/ohne Pumpe von 130 mm.für Flachheizung-Systeme MULTIFLOOR.
- Grupo de mezcla y relanzamiento con/sin bomba de 130 mm para los sistemas radiantes MULTIFLOOR.

Code	Pump	Range	Erp	Price	Class	Packaging
500414		28-53 °C	-	392,47 €	NL	1
500414P	WILO3F	28-53 °C	-	572,38 €	NL	1
500414PE	WILO4F	28-53 °C	✓	718,56 €	NL	1

AMF 01



- Copertura isolante per MULTIFLOOR.
- Insulating cover for MULTIFLOOR.
- Couverture isolante pour MULTIFLOOR.
- Isolierung Box für MULTIFLOOR.
- Cobertura aislante para MULTIFLOOR.

Code	Price	Class	Packaging
506271	70,27 €	NL	5

UNIMIX is a regulation unit designed to deliver water from a high temperature generator to the most suitable temperature for distribution in radiant circuits. All essential functions are achieved by just two components: mixing, boosting, drain/filling, air purge, shutoff, temperature monitoring and safety shutdown. Mixing is performed in a 3-way valve controllable from a fixed point or using climate compensation.

Management of the radiant system is completed with distribution manifolds and relative accessories. It is also possible to divert a direct branch upline of the mixer thanks to a special set of manifolds, which can be selected either as simple versions or with shutoff valves.

All UNIMIX components are available with pre-formed insulation casing, which makes the system suitable for applications in heating or cooling.

Power (*): approx. 15 kW.

*Boiler temperature 60 °C; flow temperature with radiant system 40 °C with temperature variation of 7 °C; 8-way distribution manifolds

⊕ PLUS

- Compact system for radiant heating and cooling
- Fixed point or climate control
- Three-way mixing control valve
- Manifold kit with dedicated straight branches

SUPPLY BLOCK WITH ACCESSORIES

BOOSTER PUMP

3-WAY MIXING VALVE

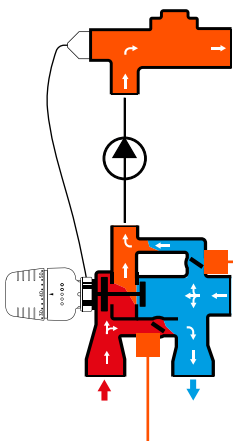

Primary bypass:

- recirculation on generator
- balancing

Secondary bypass:

- improved mixing control
- increased flow rate to circuit

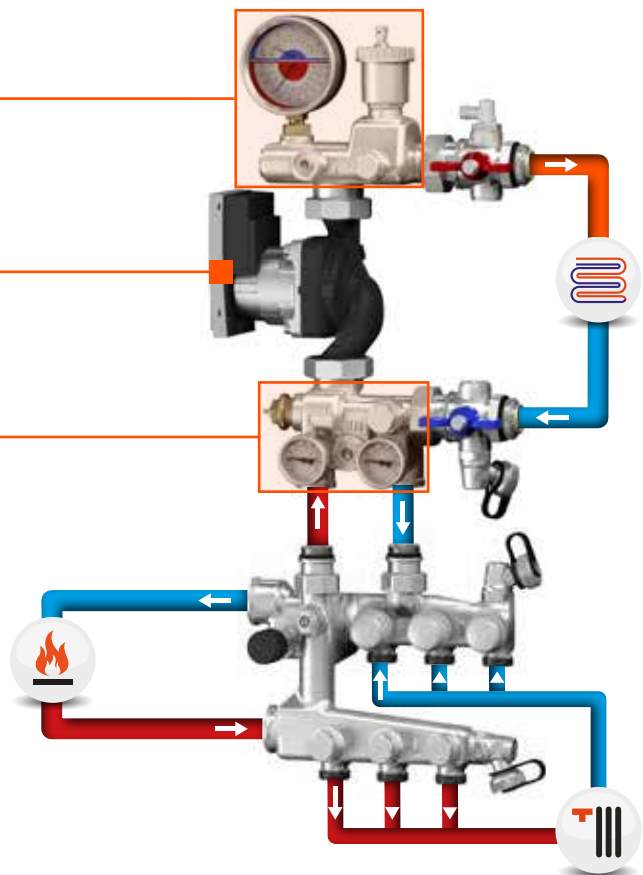

UM 01

- Gruppo di regolazione UNIMIX con/senza pompa.
- UNIMIX regulation unit with/without pump.
- Groupe de réglage UNIMIX avec/sans pompe.
- Fußbodenregulierungseinheit UNIMIX mit/ohne Pumpe.
- Grupo de regulación UNIMIX con/sin bomba.



Code	Pump	Erp	Price	Class	Packaging
500438		-	442,45 €	NL	1
500438P130	WILO3F	-	622,36 €	NL	1
500438PE130	WILO4F	✓	768,54 €	NL	1

UM 01 D/S

- Gruppo di regolazione UNIMIX con/senza pompa, con valvole a sfera diritte (D) o a squadra (S).
- UNIMIX regulation unit with/without pump, with straight (D) or angle (S) ball valves.
- Groupe de réglage UNIMIX avec/sans pompe, avec vanes à bille droites (D) ou équerre (S).
- Fußbodenregulierungseinheit UNIMIX mit/ohne Pumpe, mit Kugelventilen Durchgangsform (D) oder Eckform (S).
- Grupo de regulación UNIMIX con/sin bomba, con válvulas de bola rectas (D) o de escuadra (S).



Code	Included Accessories	Pump	Erp	Price	Class	Packaging
500438D	Straight ball valves		-	487,01 €	NL	1
500438DP130	Straight ball valves	WILO3F	-	666,91 €	NL	1
500438DPE130	Straight ball valves	WILO4F	✓	813,08 €	NL	1
500438S	Angle ball valves		-	562,24 €	NL	1
500438SP130	Angle ball valves	WILO3F	-	742,16 €	NL	1
500438SPE130	Angle ball valves	WILO4F	✓	888,34 €	NL	1



• T 5011 U >>p. 252,315,396



• RV 01 >>p. 237,241,252,315,362,396

MA 20

- Termomanometro con attacco posteriore.
- Temperature-pressure gauge with rear coupling.
- Thermomanomètre avec embout postérieure.
- Thermomanometer mit rückwärtigem Anschluss.
- Termomanómetro con conexión posterior.

Code	Size	Range	Price	Class	Packaging
509141	1/2" M	0-120 °C - 0-6 bar	36,11 €	NL	40

MA 20 R

- Termomanometro con attacco radiale.
- Temperature-pressure gauge with radial coupling.
- Thermomanomètre avec embout radiale.
- Thermomanometer mit radial Anschluss.
- Termomanómetro con conexión radial.

Code	Size	Range	Price	Class	Packaging
509141R	1/2" M	0-120 °C - 0-6 bar	36,11 €	NL	30

AUM 03

- Copertura isolante per UNIMIX.
- Insulating cover for UNIMIX.
- Couverture isolante pour UNIMIX.
- Isolierabdeckung für UNIMIX.
- Cobertura aislante para UNIMIX.

Code	Price	Class	Packaging
506256	60,90 €	NL	3

For special configurations of UNIMIX with pre-assembled manifold kit in the cabinet, please contact

LINEA ARANCIO
TECHNICAL SUPPORT
linea.arancio@ivar.it

Type	HEATING	
Actuator / controller	Fixed point adjustment	Weather-compensated adjustment
System	KM01T	KM02M

Variable speed electronic circulator WILO4F
 (In accordance with European Directive 2009/125/CE ErP Energy related Products).

3-speed standard circulator WILO3F.

Manifolds 1"

Manifolds 1"1/4.

(Depth 110 mm)

Systems can be ordered with/without cabinet.

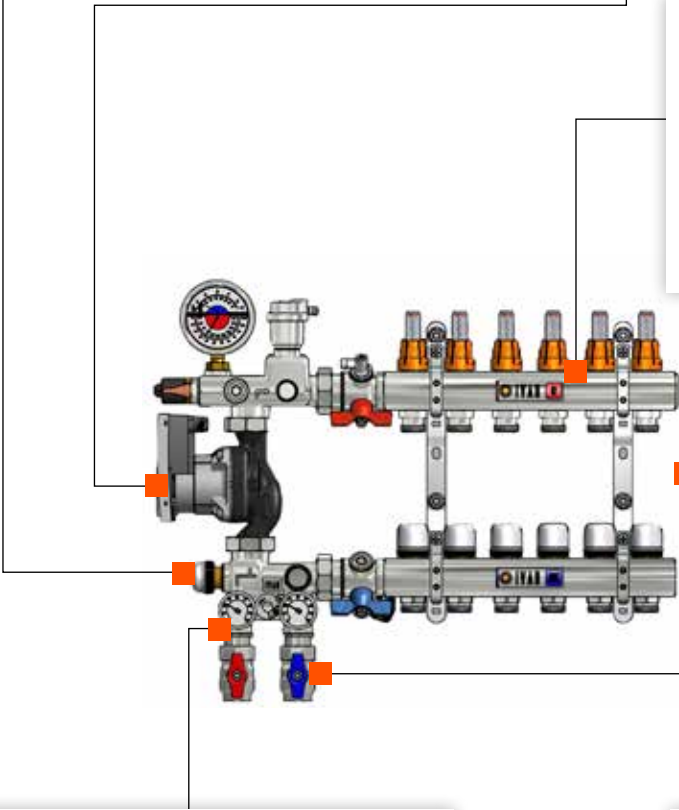

High temperature kit with plain manifolds.

(OPTIONAL).

High temperature kit with manifolds with isolation valves.

(OPTIONAL).

Angle ball valves (connections on the left for only low T. systems; connections at the bottom for systems with high T. kit)

Straight ball valves (connections at the bottom for only low T. systems; connections on the left for systems with high T. kit)

For special configurations of UNIMIX with pre-assembled manifold kit in the cabinet, please contact

LINEA ARANCIO
TECHNICAL SUPPORT
linea.arancio@ivar.it

Type	HEATING / COOLING	
Actuator / controller	<p>Weather-compensated adjustment (electronic devices already wired)</p>	<p>Weather-compensated adjustment (electronic devices not included)</p>
System	KM03M	KM04M

ErP

Variable speed electronic circulator WIL04F
(In accordance with European Directive 2009/125/CE ErP Energy related Products).

Manifolds 1" Manifolds 1"1/4.
(Depth 110 mm)

Systems can be ordered with/without cabinet, except KM03M system which comes with wired control devices

High temperature kit with plain manifolds and AQUASTOP.
(OPTIONAL).

High temperature kit with manifolds with isolation valves.
(OPTIONAL).

AQUASTOP
Cold water non-circulation device

Angle ball valves (connections on the left for only low T. systems; connections at the bottom for systems with high T. kit)

Straight ball valves (connections at the bottom for only low T. systems; connections on the left for systems with high T. kit)

UNIMIX•C

UNIMIX•C is a mixing system that, thanks to attentive simplification, has been developed to become a compact version of UNIMIX without losing its functional and performance features.

All UNIMIX C components are available with pre-formed insulation casing, which makes the system suitable for heating or cooling applications.

Power (*): approx. 15 kW.

*Boiler temperature 60 °C; delivery temperature with radiant system 40 °C with temperature variation of 7 °C; 8-way distribution manifolds

⊕ PLUS

- Compact system for radiant heating and cooling
- Fixed point or climate control
- 3-way mixing control valve
- Manifold kit with dedicated straight branches

SUPPLY BLOCK WITH ACCESSORIES

BOOSTER PUMP

3-WAY MIXING VALVE

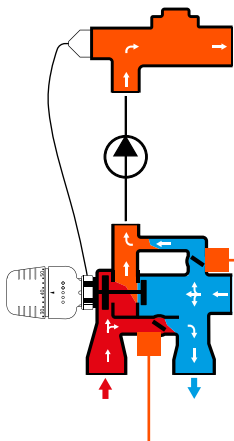

Primary bypass:

- circulation on generator
- balancing

Secondary bypass:

- improved mixing control
- increased flow rate to circuit

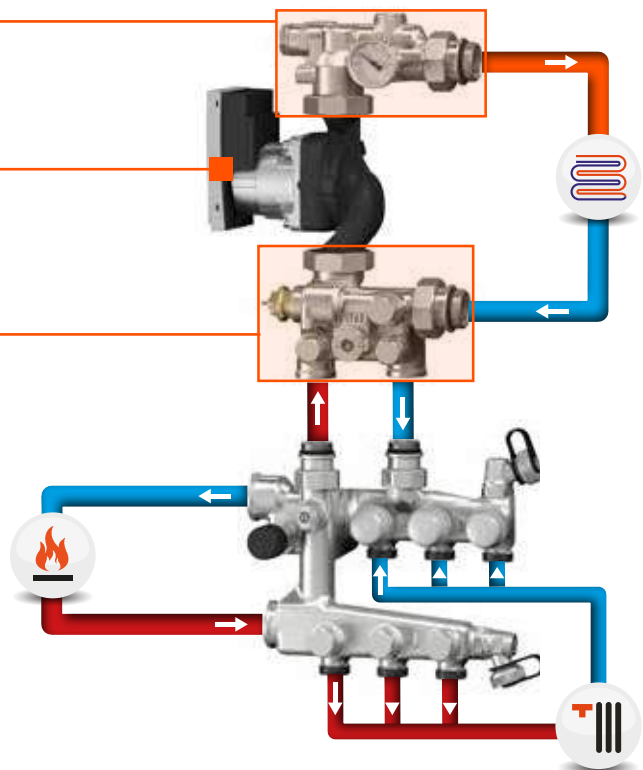

UMC 01

- Gruppo di regolazione UNIMIX-C con/senza pompa.
- UNIMIX-C regulation unit with/without pump.
- Groupe de réglage UNIMIX-C avec/sans pompe.
- Fußbodenregulierungseinheit UNIMIX-C mit/ohne Pumpe.
- Grupo de regulación UNIMIX-C con/sin bomba.



Code	Pump	Erp	Price	Class	Packaging
500897WP		-	302,18 €	NL	1
500897	WILO3F	-	482,10 €	NL	1
500897E	WILO4F	✓	628,28 €	NL	1

UMC 01 D/S

- Gruppo di regolazione UNIMIX-C con/senza pompa, con valvole a sfera diritte (D) o a squadra (S).
- UNIMIX-C regulation unit with/without pump, with straight (D) or angle (S) ball valves.
- Groupe de réglage UNIMIX-C avec/sans pompe, avec vannes à bille droites (D) ou équerre (S).
- Fußbodenregulierungseinheit UNIMIX-C mit/ohne Pumpe, mit Kugelventilen Durchgangsform (D) oder Eckform (S).
- Grupo de regulación UNIMIX-C con/sin bomba, con válvulas de bola rectas (D) o de escuadra (S).



Code	Included Accessories	Pump	Erp	Price	Class	Packaging
500897DWP	Straight ball valves		-	346,75 €	NL	1
500897D	Straight ball valves	WILO3F	-	526,66 €	NL	1
500897DE	Straight ball valves	WILO4F	✓	672,82 €	NL	1
500897SWP	Angle ball valves		-	421,99 €	NL	1
500897S	Angle ball valves	WILO3F	-	601,89 €	NL	1
500897SE	Angle ball valves	WILO4F	✓	748,07 €	NL	1



• T 5011 U >>p. 252,315,396



• RV 01 >>p. 237,241,252,315,362,396

ACCESSORIES FOR UNIMIX - UNIMIX•C

■ T 5011 U



- Testa termostatica con comando incorporato e sensore remoto ad immersione.
- *Thermostatic head with incorporated control and immersion remote sensor.*
- Tête thermostatique avec commande incorporée et capteur à distance à immersion.
- *Thermostat-Kopf mit eingebauter Steuerung und Eintauch-Fernfühler.*
- Cabeza termostática con mando incorporado y sensor remoto de inmersión.

Code	Size	Range	Length	Price	Class	Packaging
501175U	M30 x 1,5 - 1/2"	30-55 °C	1 m	54,57 €	AA	5 / 40

■ RV 01



- Servomotore assiale. Compatibile con tutti i vitoni termostatici IVAR.
- *Axial motor. Suitable for all IVAR thermostatic inserts.*
- Servomoteur axial. Adapté pour tous les inserts thermostatiques IVAR.
- *Axial-Stellantrieb. Geeignet für alle Thermostat-Regulier Vorrichtungen IVAR.*
- Servomotor axial. Adecuado para todos los tornillos termostáticos IVAR.

Code	Size	Price	Class	Packaging
501381	M30 x 1,5 - 3-point regulation (230 V AC)	141,88 €	PC	100
501383	M30 x 1,5 - Proportional 0-10 V (24 V AC/DC)	164,60 €	PC	100



- CLIMA-HUB - Regolatore elettronico per impianti di riscaldamento e raffreddamento >>p. 351
- CLIMA-HUB - Electronic controller for heating and cooling systems >>p. 351
- CLIMA-HUB - Régulateur électronique pour systèmes de chauffage et de refroidissement >>p. 351
- CLIMA-HUB - Elektronischer Regler für Heiz- und Kühlsysteme >>p. 351
- CLIMA-HUB - Regulador electrónico para sistemas de calefacción y refrigeración >>p. 351

■ CBL 01



- Scatola di cablaggio con scheda elettrica per regolazione a punto fisso.
- *Wiring box with electric card for fixed point adjustment.*
- Boîtier de câblage avec carte électrique pour régulation à point fixe.
- *Anschlusskasten mit Platine zur festen Temperaturregelung.*
- Caja de cableado con tarjeta eléctrica para ajuste a punto fijo.

Code	Size	Price	Class	Packaging
501828I	230 V AC	93,45 €	VA	4 / 32

■ AC 613 FU



- Termostato di sicurezza a taratura fissa precablato.
- *Fixed setting safety thermostat pre-wired.*
- Thermostat de sécurité à graduation fixe pré câblé.
- *Vorverklemmt Sicherheitsthermostat mit festverter Einstellung.*
- Termostato de seguridad con ajuste fijo precableado.

Code	Max operating temp.	Price	Class	Packaging
580014U	60 °C	77,45 €	VA	1 / 8

■ AC 613 CU



- Termostato di sicurezza a contatto precablato.
- *Safety thermostat with pre-wired contact.*
- Thermostat de sécurité à contact, pré-câblé.
- *Vorverklemmt Anlege-Sicherheitsthermostat.*
- Termostato de seguridad de contacto precableado.

Code	Price	Class	Packaging
580000U	71,12 €	VA	1 / 8

■ AC 613 SU



- Termostato di sicurezza con sonda ad immersione precablato.
- *Pre-wired security thermostat with immersion probe.*
- Thermostat de sécurité avec sonde à immersion, pré-câblé.
- *Vorverklemmt Sicherheitsthermostat mit Tauchhülse.*
- Termostato de seguridad con sonda de inmersión precableado.

Code	Price	Class	Packaging
580001U	93,30 €	VA	1 / 8

AUM 01

- **Kit alta temperatura per UNIMIX / UNIMIX-C con collettori semplici.**
- *High temperature kit for UNIMIX / UNIMIX-C with plain manifolds.*
- **Kit haute température pour UNIMIX / UNIMIX-C avec collecteurs simples.**
- *Hochtemperatur-Bausatz für UNIMIX / UNIMIX-C mit Heizkreise Verteiler.*
- **Kit alta temperatura para UNIMIX / UNIMIX-C con colectores simples.**

Code	Ways	Size	Price	Class	Packaging
500456	3	EUROK	189,63 €	NL	1

AUM 11 D/S

- **Kit alta temperatura per UNIMIX / UNIMIX-C con collettori semplici e valvole a sfera diritte (D) o a squadra (S).**
- *High temperature kit for UNIMIX / UNIMIX-C with plain manifolds and straight (D) or angle (S) ball valves.*
- **Kit haute température UNIMIX / UNIMIX-C avec collecteurs simples et vannes à bille droites (D) ou équerre (S).**
- *Hochtemperatur-Bausatz für UNIMIX / UNIMIX-C mit Heizkreise Verteiler und Kugelventilen Durchgangsform (D) oder Eckform (S).*
- **Kit alta temperatura para UNIMIX / UNIMIX-C con colectores simples y válvulas de bola rectas (D) o de escuadra (S).**

Code	Included Accessories	Ways	Size	Price	Class	Packaging
500456D	Straight ball valves	3	EUROK	291,71 €	NL	1
500456S	Angle ball valves	3	EUROK	303,39 €	NL	1

AUM 02

- **Kit alta temperatura per UNIMIX / UNIMIX-C con collettori intercettabili.**
- *High temperature kit for UNIMIX / UNIMIX-C with manifolds with isolation valves.*
- **Kit haute température pour UNIMIX / UNIMIX-C avec collecteurs avec des vannes d'interception.**
- *Hochtemperatur-Bausatz für UNIMIX / UNIMIX-C mit Verteiler mit Absperbarenventilen.*
- **Kit alta temperatura para UNIMIX / UNIMIX-C con colectores con válvulas de cierre.**

Code	Ways	Size	Price	Class	Packaging
500586	3	EUROK	359,54 €	NL	1

AUM 12 D/S

- **Kit alta temperatura per UNIMIX / UNIMIX-C con collettori intercettabili con valvole a sfera diritte (D) o a squadra (S).**
- *High temperature kit for UNIMIX / UNIMIX-C with manifolds with isolation valves and straight (D) or angle (S) ball valves.*
- **Kit haute température pour UNIMIX / UNIMIX-C avec collecteurs avec des vannes d'interception et vannes à bille droites (D) ou équerre (S).**
- *Hochtemperatur-Bausatz für UNIMIX / UNIMIX-C mit Verteiler mit Absperbarenventilen und Kugelventilen Durchgangsform (D) oder Eckform (S).*
- **Kit alta temperatura para UNIMIX / UNIMIX-C con colectores con válvulas de cierre y válvulas de bola rectas (D) o a de escuadra (S).**

Code	Included Accessories	Ways	Size	Price	Class	Packaging
500586D	Straight ball valves	3	EUROK	461,65 €	NL	1
500586S	Angle ball valves	3	EUROK	473,33 €	NL	1

UNIFLOOR

The UNIFLOOR unit is a compact system for mixing and distribution to small radiant underfloor systems. The thermostatic mixer keeps the supply temperature at the set value rapidly and precisely. The high-efficiency electronic pump sends the mixed fluid to the components, supplying the necessary head. A normally open thermostat guarantees pump operation only when the boiler fluid is at a sufficiently high temperature, and prevents cold fluid from being delivered to the radiant system. Two shutoff valves on the inlets facilitate initial connection and maintenance operations. UNIFLOOR is supplied installed on a metal frame with vibration damping brackets, pre-wired to the junction box, and is used to serve a single radiant circuit.

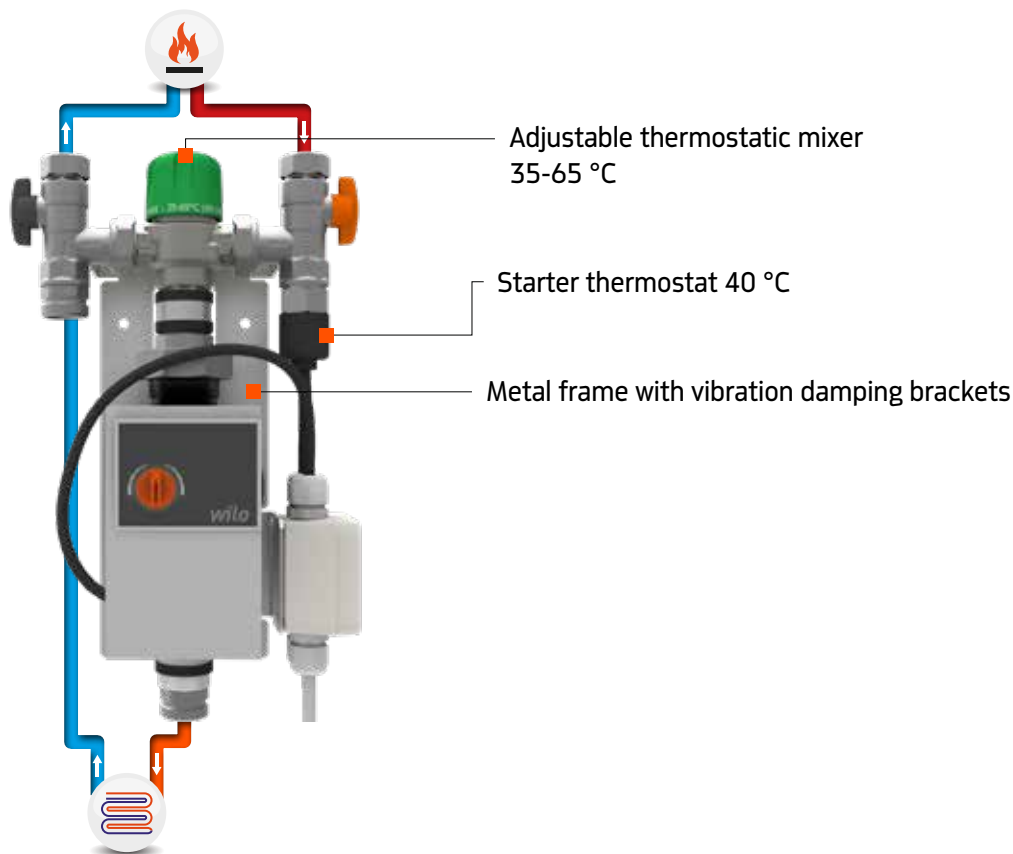

UF 01



ErP

- Unità di miscelazione e distribuzione con/senza pompa elettronica a velocità variabile da 130 mm per singolo circuito radiante UNIFLOOR.
- Mixing and distribution unit with/without 130 mm variable speed electronic pump for single radiant circuit UNIFLOOR.
- Unité de mélange et distribution avec/sans pompe électronique à vitesse variable de 130 mm pour single circuit radiant UNIFLOOR.
- Misch- und Verteilungs-Modul UNIFLOOR mit/ohne elektronischer Pumpe mit variabler Geschwindigkeit von 130 mm für einzel Flachheizung-Schaltung.
- Unidad de mezcla y distribución UNIFLOOR con/sin bomba electrónica de velocidad variable de 130 mm para circuito radiante único.

Code	Pump	Range	Price	Class	Packaging
506717WP		35-65 °C	396,03 €	NL	1
506717W	WILO4F	35-65 °C	722,10 €	NL	1

AC 4615 N



- Raccordo portatermometro per derivazioni.
- Thermometer fitting for junctions.
- Raccord porte-thermomètre pour dérivations.
- Anschlussstück mit Thermometer.
- Racor con termómetro para derivaciones.

Code	Size	Color	Price	Class	Packaging
500804	EUROK	■	18,20 €	NJ	10 / 80

■ WILO4F



ErP

- **Circolatore elettronico a velocità variabile (Conforme alla direttiva europea 2009/125/CE - ErP ,Energy related Products').**
- *Variable speed electronic circulator (In accordance with European Directive 2009/125/CE - ErP "Energy related Products").*
- **Circulateur chauffage électronique à vitesse variable (Conforme à la Directive Européenne 2009/125/CE - ErP "Energy related Products").**
- *Elektronische Umwälzpumpe mit variabler Geschwindigkeit (Entspricht der Europäischen Richtlinie 2009/125/CE - ErP "Energy related Produkts").*
- **Circulador electrónico de velocidad variable (Conforme a la directiva europea 2009/125/CE - ErP ,Energy related Products').**

Code	Size	Head loss	Price	Class	Packaging
WILO4F-110	1" - 110 mm	6 m	341,98 €	HK	1 / 4
WILO4F	1"1/2 - 130 mm	6 m	312,00 €	HK	3
WILO4F-180	1"1/2 - 180 mm	6 m	336,07 €	HK	3

■ WILO3F



ErP

- **Circolatore standard a 3 velocità.**
- *3-speed standard circulator.*
- **Circulateur standard à 3 vitesses.**
- *Umwälzpumpe mit 3 Geschwindigkeitsstufen.*
- **Circulador estándar de 3 velocidades.**

Code	Size	Head loss	Price	Class	Packaging
WILO3F	1"1/2 - 130 mm	6 m	216,14 €	HK	5
WILO3F-180	1"1/2 - 180 mm	6 m	230,63 €	HK	1

■ AC 633



- **Distanziatore filettato per pompe.**
- *Threaded spacer for pumps.*
- **Ecarteur fileté pour pompes.**
- *Zwischenstück mit Gewinde für Pumpen.*
- **Distanciadór roscado para bombas.**

Code	Size	Price	Class	Packaging
500933	1"1/2 - 130 mm	29,19 €	HK	25
500934	1"1/2 - 180 mm	30,92 €	HK	20

■ AC 626



- **Bocchettone a tenuta morbida per collegamento circolatore.**
- *Soft seal pipe union for pump connection.*
- **Tubulure de raccordement à joint souple étanche pour raccordement à la pompe.**
- *Pumpen Anschlußverschraubung.*
- **Manguito de unión con junta blanda para la conexión de la bomba.**

Code	Size	Price	Class	Packaging
520022	1"1/2 F x 1" M	13,45 €	NJ	8 / 64

IC-BOX is a practical and economical system for adding a radiant heating circuit to a high-temperature system.

A typical use case is in a bathroom remodel. Many people are particularly fond of the feeling provided by underfloor heating, particularly in a location where they are generally barefoot. Normally, incorporating a radiant underfloor heating circuit in a high-temperature system would require a mixing system (to lower the temperature of the water circulating under the floor) and a circulation pump. In addition to these expenses, there is also the running cost of the electricity for the circulation pump. With IC-BOX, on the other hand, neither mixing nor pumping is required. The temperature of the water circulating in the radiant circuit is managed by an RTL device, while the ambient temperature control can be performed by a thermostatic head or an electrothermic head.

What does RTL mean? It stands for "Return Temperature Limiter", and it is a device containing a thermostatic element and a regulation knob. Adjusting the knob limits the return temperature to a certain value (note that the device is installed at the end of the coil, before the water returns to the existing high-temperature distribution). As the water gradually approaches the set-point set with the knob, the thermostatic element in the RTL device expands, with two results:

1. Limiting the flow rate in the coil
2. Encouraging heat exchange between the coil and the screed around the underfloor heating system, increasing the temperature difference between the flow and return in the coil.

When comparing the operating conditions of a "traditional" radiant system (on the left) and a radiant circuit with RTL (on the right), we must remember that the power transferred into the environment is proportional to the flow rate in the circuit Q and the temperature difference between T_{in} and T_{out} , i.e.:

$$P \propto Q \times (T_{in} - T_{out})$$

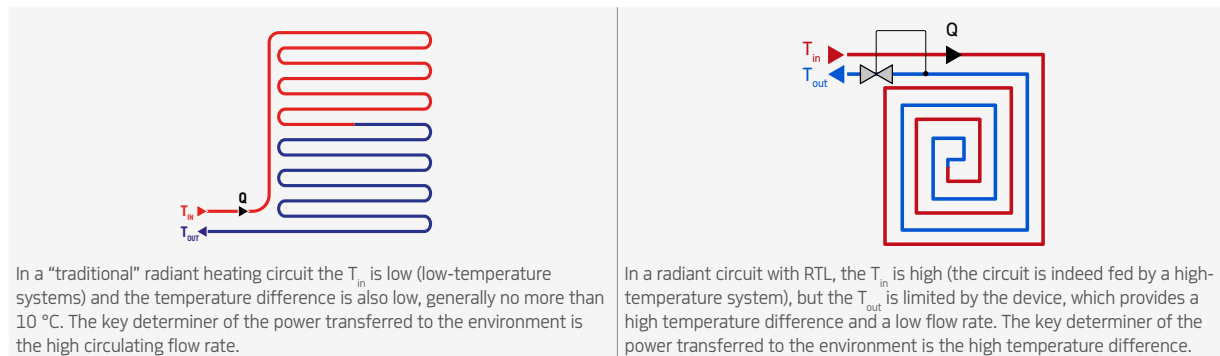

In practice, the power transferred to the environment can be the same in the two operating conditions: in the "traditional" case typically with a high flow rate and low ΔT , and with the RTL system at low flow rate and high ΔT . Given that a high temperature difference is achieved with an RTL device, the radiant circuits on which it is installed must be in a spiral layout in order to guarantee an even temperature across the floor.

Now the operation of the RTL device has been clarified, the temperature regulation portion remains: when the desired ambient temperature T_{amb} has been achieved in the room, how can the supply of heat be interrupted? A device such as a thermostatic head or a thermoelectric head controlled by a thermostat can be used, to be installed in series with the RTL circuit:

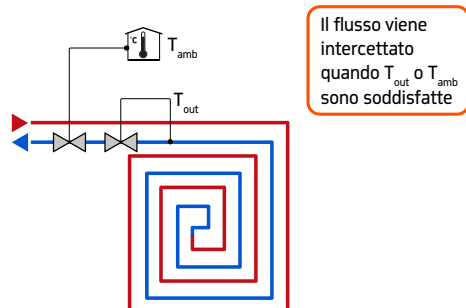

In general, IC-BOX can also be used for wall or ceiling radiant systems: the operating principle remains the same. In order to offer maximum installation flexibility, IC-BOX is offered in five different configurations, depending on whether or not the RTL and ambient temperature control (TA) devices is required. Clearly, the versions without RTL are to be used only in systems where the boiler supply temperature has already been adapted to the radiant circuit.

When choosing and installing IC-BOX, take care to observe applicable standards (such as European standard EN 1264), any local design and installation requisites, and the specifications from manufacturers of the installed floor coverings. All IC-BOX versions incorporate a manual air bleed valve.

IC-BOX VERSION	WITH RTL	WITH TA
1	YES	YES (thermostatic valve for head with remote sensor or electrothermic head connected to ambient thermostat)
2	YES	YES (thermostatic valve for head with incorporated sensor and control)
3	YES	NO
4	NO (dual micro-adjustable lockshield only)	YES (thermostatic valve for head with incorporated sensor and control)
5	NO (dual micro-adjustable lockshield only)	YES (thermostatic valve for head with remote sensor or electrothermic head connected to ambient thermostat)

IC-BOX 1



- **Dispositivo di controllo della temperatura di ritorno regolabile 15-45 °C. Completo di:**
 - valvola termostattizzabile per testa con sensore remoto o testina elettrotermica collegata a termostato ambiente;
 - valvola manuale di sfianto aria;
 - vassetta ad incasso.
- *Adjustable return temperature controller 15-45 °C. Complete with:*
 - valve suitable to thermostatic control by head with remote sensor or to control by electrothermal head connected to room thermostat;
 - manual air vent valve;
 - recessed cabinet.
- **Dispositif de contrôle de la température de retour réglable de 15 à 45 °C. Complet de:**
 - vanne thermostatizable pour tête avec capteur à distance ou tête électrothermique reliée à un thermostat ambiant;
 - purgeur manuel d'air;
 - caisse à encastrement.
- *Steuergerät der einstellbaren Rücklauftemperatur 15-45 °C. Komplett mit:*
 - Thermostatventil für Kopf mit Fernsensor oder elektrothermischer Kopf, der mit dem Raumthermostat verbunden ist;
 - Entlüftungsventil manuell;
 - Einbaugeschäuse.
- **Dispositivo de control de la temperatura de retorno regulable 15-45 °C. Completo con:**
 - válvula termo-estabilizadora para cabeza con sensor remoto o cabeza electro-térmica conectado al termostato ambiente;
 - válvula purgadora manual;
 - caja empotrada.

Code	Version	Range	Color	Price	Class	Packaging
506602	RTL - TA	15-45 °C	□	139,34 €	BH	1 / 16
506602CR	RTL - TA	15-45 °C	■	156,65 €	BH	1 / 16

IC-BOX 2



- **Dispositivo di controllo della temperatura di ritorno regolabile 15-45 °C. Completo di:**
 - valvola termostattizzabile per testa con comando e sensore incorporati;
 - valvola manuale di sfianto aria;
 - cassetta ad incasso.
- *Adjustable return temperature controller 15-45 °C. Complete with:*
 - valve suitable to thermostatic control by head with incorporated sensor;
 - manual air vent valve;
 - recessed cabinet.
- **Dispositif de contrôle de la température de retour réglable de 15 à 45°C. Complet de:**
 - vanne thermostatizable pour tête avec commande et capteur incorporés;
 - purgeur manuel d'air;
 - caisse à encastrement.
- *Steuergerät der einstellbaren Rücklauftemperatur 15-45 °C. Komplett mit:*
 - Thermostatventil für eingebauten Steuerkopf und Sensor;
 - Entlüftungsventil manuell;
 - Einbaugeschäuse.
- **Dispositivo de control de la temperatura de retorno regulable 15-45 °C. Completo con:**
 - válvula termo-estabilizadora para cabeza con mando y sensor incorporados;
 - válvula purgadora manual;
 - caja empotrada.

Code	Version	Range	Color	Price	Class	Packaging
506603	RTL - TA	15-45 °C	□	139,34 €	BH	1 / 16
506603CR	RTL - TA	15-45 °C	■	156,65 €	BH	1 / 16

■ IC-BOX 3



- **Dispositivo di controllo della temperatura di ritorno regolabile 15-45 °C. Completo di:**
 - valvola manuale di sfiato aria
 - cassetta ad incasso.
- *Adjustable return temperature controller 15-45 °C. Complete with:*
 - manual air vent valve;
 - recessed cabinet.
- **Dispositif de contrôle de la température de retour réglable de 15 à 45°C. Complet de:**
 - purgeur manuel d'air;
 - caisse à encastrement.
- *Steuergerät der einstellbaren Rücklauftemperatur 15-45 °C. Komplett mit:*
 - Entlüftungsventil manuell;
 - Einbaugeschäuse.
- **Dispositivo de control de la temperatura de retorno regulable 15-45 °C. Completo con:**
 - válvula purgadora manual
 - caja empotrada.

Code	Version	Range	Color	Price	Class	Packaging
506604	RTL	15-45 °C	□	132,09 €	BH	1 / 16
506604CR	RTL	15-45 °C	■	149,39 €	BH	1 / 16

■ IC-BOX 4



- **Dispositivo di regolazione della temperatura ambiente. Completo di:**
 - detentore a doppia regolazione micrometrica;
 - valvola manuale di sfiato aria;
 - cassetta ad incasso.
- *Room temperature adjustment device. Complete with:*
 - double micrometric adjustment lockshield
 - manual air vent valve
 - recessed cabinet.
- **Dispositif pour le réglage de la température ambiante. Complet de:**
 - détenteur à double réglage micrométrique;
 - purgeur manuel d'air;
 - caisse à encastrement.
- *Vorrichtung zur Regelung der Zimmertemperatur. Komplett mit:*
 - Rücklaufverschraubung mit doppelter Feineinstellung;
 - Entlüftungsventil manuell;
 - Einbaugeschäuse.
- **Dispositivo para la regulación de la temperatura ambiente. Completo con:**
 - detentor de regulación doble micrométrica;
 - válvula purgadora manual;
 - caja empotrada.

Code	Version	Color	Price	Class	Packaging
506606	TA	□	100,88 €	BH	1 / 16
506606CR	TA	■	118,32 €	BH	1 / 16

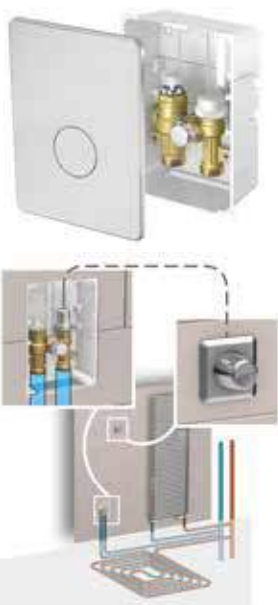
IC-BOX 5

- **Dispositivo di regolazione della temperatura ambiente. Completo di:**
 - **detentore a doppia regolazione micrometrica;**
 - **valvola manuale di sfiato aria;**
 - **cassetta ad incasso.**
- **Room temperature adjustment device. Complete with:**
 - **double micrometric adjustment lockshield;**
 - **manual air vent valve;**
 - **recessed cabinet.**
- **Dispositif pour le réglage de la température ambiante. Complet de:**
 - **détendeur à double réglage micrométrique;**
 - **purgeur manuel d'air;**
 - **caisse à encastrer.**
- **Vorrichtung zur Regelung der Zimmertemperatur. Komplett mit:**
 - **Rücklaufverschraubung mit doppelter Feineinstellung;**
 - **Entlüftungsventil manuell;**
 - **Einbaugeschäube.**
- **Dispositivo para la regulación de la temperatura ambiente. Completo con:**
 - **detentor de regulación doble micrométrica;**
 - **válvula purgadora manual;**
 - **caja empotrada.**

Code	Version	Color	Price	Class	Packaging
506607	TA	□	100,88 €	BH	1 / 16
506607CR	TA	■	118,32 €	BH	1 / 16

T 5000

- **Testa termostatica con comando e sensore a espansione di liquido incorporati. Isteresi 0,5 K.**
- **Thermostatic head with incorporated command and liquid expansion sensor. Hysteresis 0.5 K.**
- **Tête thermostatique avec commande et senseur à expansion de liquide incorporés. Hystérésis 0,5 K.**
- **Thermostat-Kopf mit eingebauten Steuerung und Flüssigkeitsausdehnung Fühler. Hysterese 0,5 K.**
- **Cabeza termostática con mando y sensor de expansión de líquido incorporados. Histéresis 0,5 K.**



Code	Size	D	W	Z	Color	Price	Class	Packaging
501172	M30 x 1,5	0.25 K	0.75 K	30 min	□	18,10 €	AA	10 / 80

T 5000 CHROME

- **Testa termostatica con comando e sensore a espansione di liquido incorporati.**
- **Thermostatic head with incorporated command and liquid expansion sensor.**
- **Tête thermostatique avec commande et senseur à expansion de liquide incorporés.**
- **Thermostat-Kopf mit eingebauten Steuerung und Flüssigkeitsausdehnung Fühler.**
- **Cabeza termostática con mando y sensor de expansión de líquido incorporados.**

Code	Size	Z	Range	Color	Price	Class	Packaging
501172C	M30 x 1,5	< 40 min	6,5-28 °C	■	42,57 €	AA	10 / 80

T 5030

- **Testa termostatica con sensore remoto e comando ad incasso.**
- **Thermostatic head with remote sensor and concealed command.**
- **Tête thermostatique avec senseur à distance commande d'encaissement.**
- **Thermostat-Kopf mit Fernfühler und UP-Steuerung.**
- **Cabeza termostática con sensor remoto y mando empotrable.**

Code	Size	Z	Range	Length	Price	Class	Packaging
501179	M30 x 1,5	< 40 min	6,5-28 °C	2 m	65,25 €	AA	2 / 16
501180	M30 x 1,5	< 40 min	6,5-28 °C	5 m	73,78 €	AA	2 / 16

- **D = Influenza della pressione differenziale. W = Effetto della temperatura dell'acqua. Z = Tempo di risposta.**
- **D = Differential pressure influence. W = Water temperature effect. Z = Response time.**
- **D = Influence de la pression différentielle. W = Influence de la température de l'eau. Z = Temps de réponse.**
- **D = Einfluß des Differenzialdrucks. W = Wassertemperatureinfluss. Z = Schließzeit.**
- **D = Influencia de la presión diferencial. W = Efecto de la temperatura del agua. Z = Tiempo de respuesta.**

FLOOR SYSTEMS

MINIMUM THERMAL RESISTANCE OF THE INSULATION LAYER

In order to limit the dispersion of heat to the environment below through the floor, the standard EN 1264-4:2021 requires a minimum thermal resistance value R_d for the insulation layers (panel) on the basis of the thermal conditions below the heated environment.

NEW CONSTRUCTION

These requirements are mandatory and must always be complied with for new construction

RENOVATION

In the event of renovation/refurbishment, these should be considered indicative: in order to achieve the specified minimum thermal resistance values through the floor, the designer may consider the thermal resistance of the entire slab/subfloor (not just the panel). Where applicable, it is possible to add further insulation on top in order to come as close as possible to the code requirements.

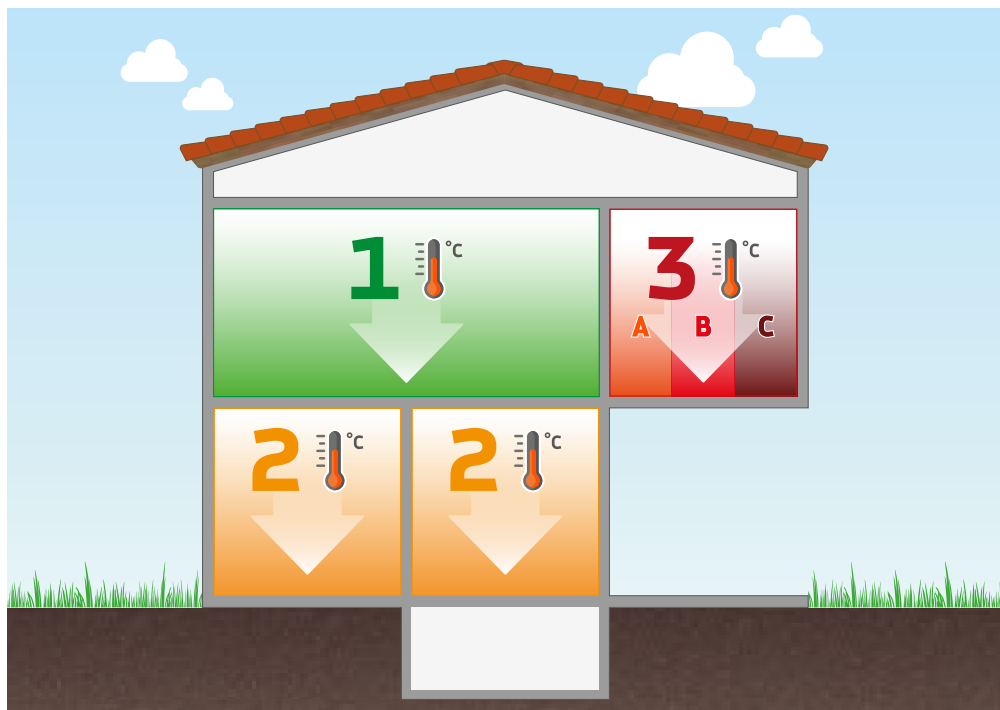

	1	2	3		
Application case	Underlying room heated	Underlying room not heated, non-continuously heated or directly on the ground.	Underlying outdoor temperature		
			3A	3B	3C
			Design outdoor T. $T_d \geq 0 \text{ }^\circ\text{C}$	Design outdoor T. $0 \text{ }^\circ\text{C} > T_d \geq -5 \text{ }^\circ\text{C}$	Design outdoor T. $-5 \text{ }^\circ\text{C} > T_d \geq -15 \text{ }^\circ\text{C}$
Min. thermal resistance of the insulation layer $R_d \text{ (m}^2 \text{ k/W)}$	0,75	1,25	1,25	1,50	2,00

MINIMUM HEIGHT OF FLOOR SYSTEMS

Self-leveling screed



Traditional screed

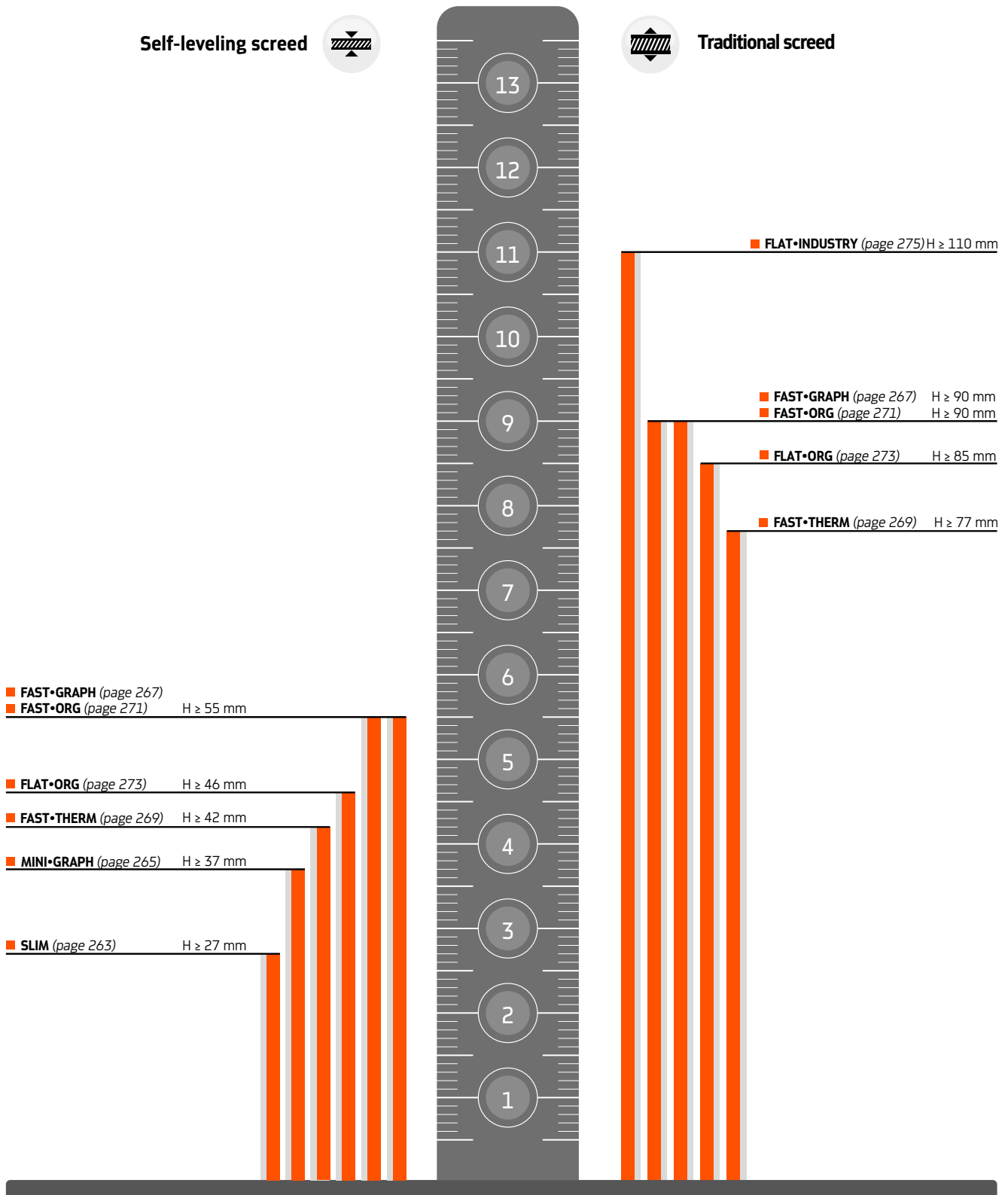

Self-leveling screed drying times and thermal cycle for first start-up of the system according to the manufacturer's technical data sheet

9 - 14 days

Screed drying and thermal cycle times for first start-up of the system according to UNI EN 1264-4: 2021

28 days

Typical application	Restoration
Multiple laying steps	5 cm
Pipes that can be installed	Ø16/2 - Ø17/2 mm

UNI EN 1264:2021 certified system

It can also be installed on existing flooring

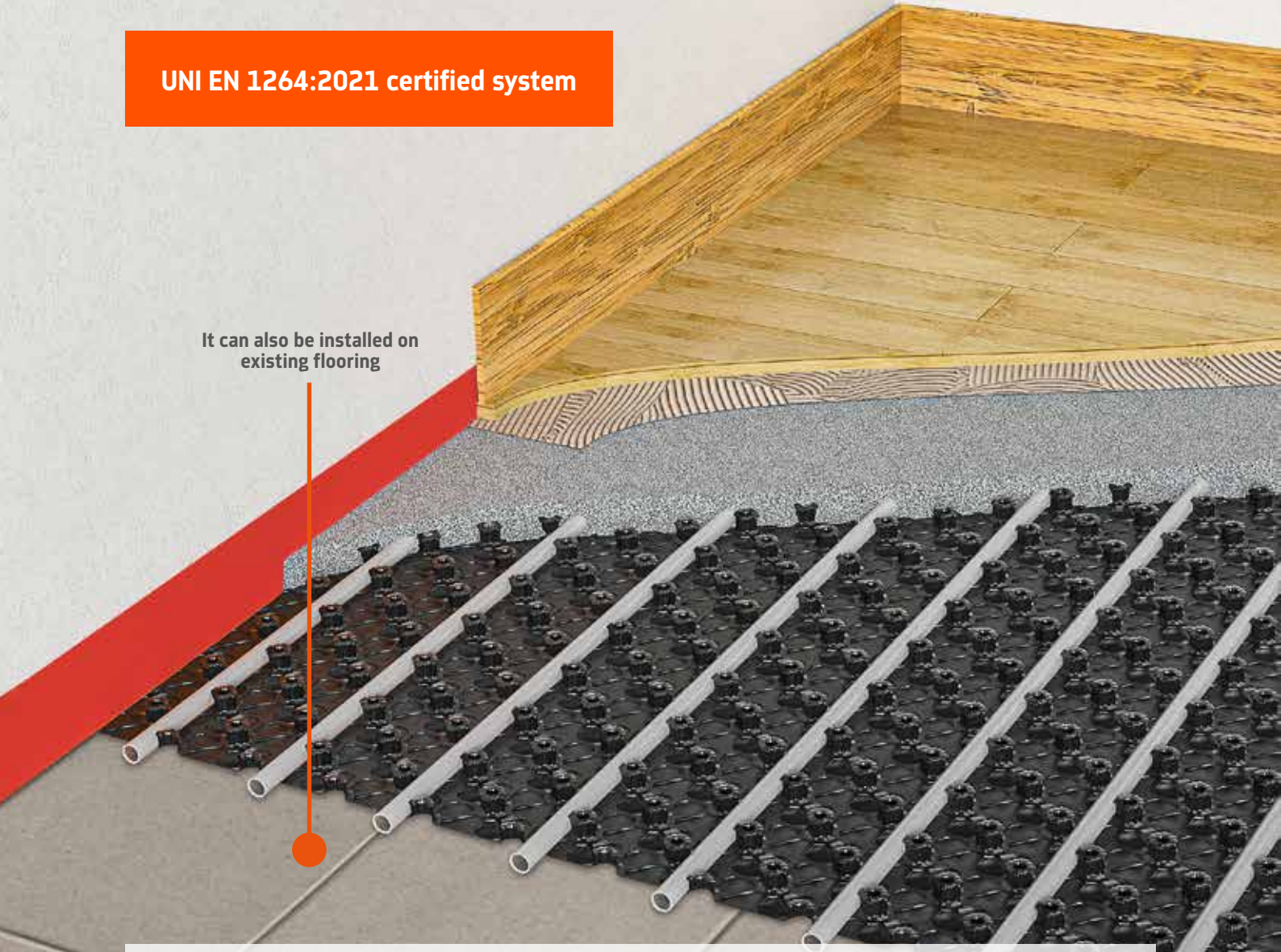

1. Perimeter edging
2. Piping
3. Thermoformed film with adhesive tape
4. Radiant screed

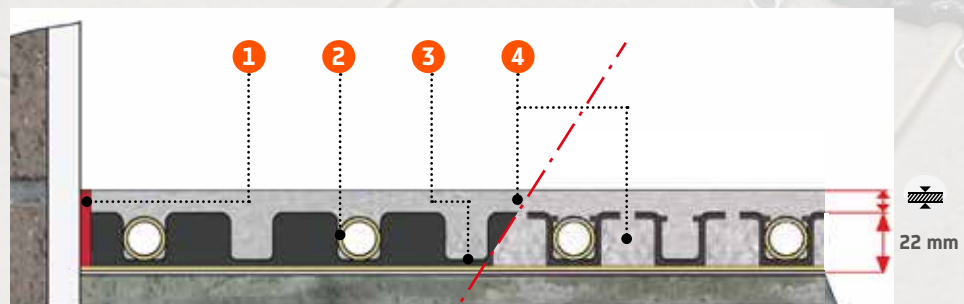

FOCUS: Minimum installation space >> p. 261

SLIM

- **Pellicola termoformata (senza strato isolante) con biadesivo.**
- **Dimensioni utili: 120 x 80 cm**
- **Film plastico: 1 mm**
- **Thermoformed film (without insulating layer) with double-sided tape.**
- **Useful dimensions: 120 x 80 cm**
- **Plastic film: 1 mm**
- **Film thermoformée (sans couche isolante) avec ruban adhésif double face.**
- **Dimensions utiles: 120 x 80 cm**
- **Film plastique: 1 mm**
- **Folie (ohne Isolierschicht), mit doppelseitigem Klebeband.**
- **Nützliche Abmessungen: 120 x 80 cm**
- **Kunststofffolie: 1 mm**
- **Película (sin capa aislante), con cinta adhesiva de doble cara.**
- **Dimensiones útiles: 120 x 80 cm**
- **Película de plástico: 1 mm**

Code	Total thickness	Pcs per package	Price	Class	Packaging
SLIM22	22 mm	11 pcs	43,40 €/m ²	HU	10,56 m ²



- Tubazioni >> p. 87
- Pipes >> p. 87
- Tuyaux >> p. 87
- Rohre >> p. 87
- Tuberías >> p. 87



- Reggicurva >> p. 280
- Holding bend >> p. 280
- Courbe de support >> p. 280
- Stützkurve >> p. 280
- Curva de soporte >> p. 280



- Guaina isolante >> p. 280,283
- Insulating sheath >> p. 280,283
- Gaine isolante >> p. 280,283
- Isoliermantel >> p. 280,283
- Vaina aislante >> p. 280,283



- Fascia perimetrale >>p. 280
- Perimeter edging >>p. 280
- Bande périmétrique >>p. 280
- Umfangsband >>p. 280
- Banda perimetral >>p. 280

SUGGESTED SCREED

Self-leveling
NE 499
h ≥ 10 mm
NE 425
h ≥ 20 mm
Self-leveling screed height to be considered above the ashlar
Self-leveling screed drying times and thermal cycle for first start-up of the system according to the manufacturer's technical data sheet
9-14 days

Typical application	Restoration
Multiple laying steps	5 cm
Pipes that can be installed	Ø16/2 - Ø17/2 mm

UNI EN 1264:2021 certified system



1. Perimeter edging
2. Humidity barrier
3. Insulation panel
4. Piping
5. Radiant screed

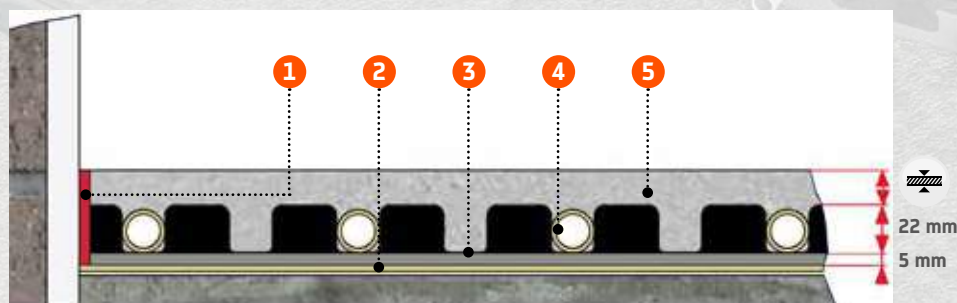

FOCUS: Minimum installation space >> p. 261

MINIGRAPH

On request the material can be supplied in compliance with CAM requirements

- **Pannello termoformato in polistirene espanso con grafite.**
 - Dimensioni utili: 140 x 80 cm
 - Film plastico: 600 µm
 - Classe materiale (UNI EN 13163): EPS 400
 - Conducibilità termica (EN 12667): λd 0,030 W/m K
 - Resistenza a compressione al 10% di deformazione (UNI EN 826): 400 kPa
- **Thermoformed panel in expanded polystyrene with graphite.**
 - Useful dimensions: 140 x 80 cm
 - Plastic film: 600 µm
 - Material class (UNI EN 13163): EPS 400
 - Thermal conductivity (EN 12667): λd 0,030 W/m K
 - Compressive strength at 10% deformation (UNI EN 826): 400 kPa
- **Panneau thermoformé en polystyrène expansé avec graphite.**
 - Dimensions utiles: 140 x 80 cm
 - Film plastique: 600 µm
 - Classe de matériau (UNI EN 13163): EPS 400
 - Conductivité thermique (EN 12667): λd 0,030 W/m K
 - Résistance à la compression à 10% de déformation (UNI EN 826): 400 kPa
- **Thermoformplatte aus expandiertem Polystyrol mit Graphit.**
 - Nützliche Abmessungen: 140 x 80 cm
 - Kunststoffolie: 600 µm
 - Materialklasse (UNI EN 13163): EPS 400
 - Wärmeleitfähigkeit (EN 12667): λd 0,030 W/m K
 - Druckfestigkeit bei 10% der Verformung (UNI EN 826): 400 kPa
- **Panel termoformado de poliestireno expandido con grafito.**
 - Dimensiones útiles: 140 x 80 cm
 - Película de plástico: 600 µm
 - Clase de material (UNI EN 13163): EPS 400
 - Conductividad térmica (EN 12667): λd 0,030 W/m K
 - Resistencia a la compresión al 10% de deformación (UNI EN 826): 400 kPa

Code	Insulation thickness	Total thickness	Thermal resistance	Pcs per package	Price	Class	Packaging
MINIGRAPH5	5 mm	27 mm	0,17 m² K/W	14 pcs	30,24 €/m²	HU	15,68 m²



- Tubazioni >> p. 87
- Pipes >> p. 87
- Tuyaux >> p. 87
- Rohre >> p. 87
- Tuberías >> p. 87



- Reggicurva >> p. 280
- Holding bend >> p. 280
- Courbe de support >> p. 280
- Stützkurve >> p. 280
- Curva de soporte >> p. 280



- Guaina isolante >> p. 280,283
- Insulating sheath >> p. 280,283
- Gaine isolante >> p. 280,283
- Isoliermantel >> p. 280,283
- Vaina aislante >> p. 280,283



- Fascia perimetrale >> p. 280
- Perimeter edging >> p. 280
- Bande périphérique >> p. 280
- Umfangsband >> p. 280
- Banda perimetral >> p. 280



- Barriera umidità >> p. 281
- Humidity barrier >> p. 281
- Barrière humidité >> p. 281
- Feuchtigkeitsbarriere >> p. 281
- Barrera contra la humedad >> p. 281



- Graffette >> p. 281
- Clips >> p. 281
- Clips >> p. 281
- Clips >> p. 281
- Pinzas >> p. 281

SUGGESTED SCREED

Self-leveling
NE 499
h ≥ 10 mm
NE 425
h ≥ 20 mm
Self-leveling screed height to be considered above the ashlar
Self-leveling screed drying times and thermal cycle for first start-up of the system according to the manufacturer's technical data sheet
9-14 days

Typical application	Residential
Multiple laying steps	5 cm
Pipes that can be installed	Ø16/2 - Ø17/2 mm

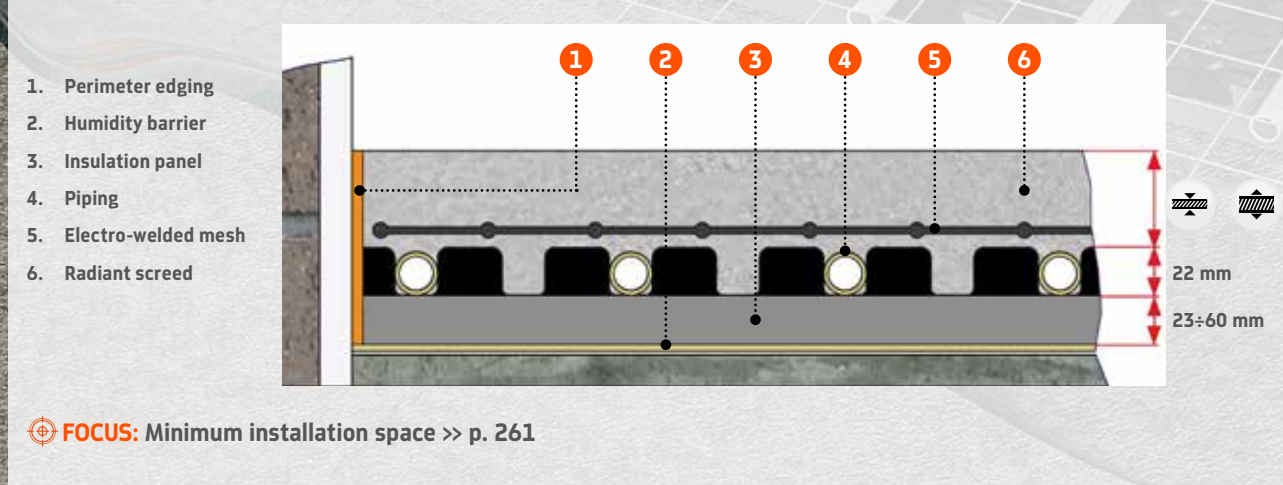

GRAPH

On request the material can be supplied in compliance with CAM requirements

- **Pannello termoformato in polistirene espanso con grafite.**
 - Dimensioni utili: 140 x 80 cm
 - Film plastico: 600 µm
 - Classe materiale (UNI EN 13163): EPS 150
 - Conducibilità termica (EN 12667): λd 0,030 W/m K
 - Resistenza a compressione al 10% di deformazione (UNI EN 826): 150 kPa
- **Thermoformed panel in expanded polystyrene with graphite.**
 - Useful dimensions: 140 x 80 cm
 - Plastic film: 600 µm
 - Material class (UNI EN 13163): EPS 150
 - Thermal conductivity (EN 12667): λd 0,030 W/m K
 - Compressive strength at 10% deformation (UNI EN 826): 150 kPa
- **Panneau thermoformé en polystyrène expansé avec graphite.**
 - Dimensions utiles: 140 x 80 cm
 - Film plastique: 600 µm
 - Classe de matériau (UNI EN 13163): EPS 150
 - Conductivité thermique (EN 12667): λd 0,030 W/m K
 - Résistance à la compression à 10% de déformation (UNI EN 826): 150 kPa
- **Thermoformplatte aus expandiertem Polystyrol mit Graphit.**
 - Nützliche Abmessungen: 140 x 80 cm
 - Kunststofffolie: 600 µm
 - Materialklasse (UNI EN 13163): EPS 150
 - Wärmeleitfähigkeit (EN 12667): λd 0,030 W/m K
 - Druckfestigkeit bei 10% der Verformung (UNI EN 826): 150 kPa
- **Panel termoformado de poliestireno expandido con grafito.**
 - Dimensiones útiles: 140 x 80 cm
 - Película de plástico: 600 µm
 - Clase de material (UNI EN 13163): EPS 150
 - Conductividad térmica (EN 12667): λd 0,030 W/m K
 - Resistencia a la compresión al 10% de deformación (UNI EN 826): 150 kPa

Code	Insulation thickness	Total thickness	Thermal resistance	Pcs per package	Price	Class	Packaging
GRAPH23	23 mm	45 mm	0,77 m² K/W	14 pcs	36,00 €/m²	HU	15,68 m²
GRAPH38	38 mm	60 mm	1,27 m² K/W	10 pcs	44,10 €/m²	HU	11,20 m²
GRAPH45	45 mm	67 mm	1,50 m² K/W	8 pcs	49,00 €/m²	HU	8,96 m²
GRAPH60	60 mm	82 mm	2,00 m² K/W	7 pcs	57,50 €/m²	HU	7,84 m²



- Tubazioni >> p. 87
- Pipes >> p. 87
- Tuyaux >> p. 87
- Rohre >> p. 87
- Tuberías >> p. 87



- Reggicurva >> p. 280
- Holding bend >> p. 280
- Courbe de support >> p. 280
- Stützkurve >> p. 280
- Curva de soporte >> p. 280



- Guaina isolante >> p. 280,283
- Insulating sheath >> p. 280,283
- Gaine isolante >> p. 280,283
- Isoliermantel >> p. 280,283
- Vaina aislante >> p. 280,283



- Fascia perimetrale >> p. 280
- Perimeter edging >> p. 280
- Bande périmétrique >> p. 280
- Umfangsband >> p. 280
- Banda perimetral >> p. 280



- Graffette >> p. 281
- Clips >> p. 281
- Clips >> p. 281
- Clips >> p. 281
- Pinzas >> p. 281



- Graffette >> p. 281
- Clips >> p. 281
- Clips >> p. 281
- Clips >> p. 281
- Pinzas >> p. 281

SUGGESTED SCREED

Self-leveling

NE 499
h ≥ 10 mm

NE 425
h ≥ 20 mm

Self-leveling screed height to be considered above the ashlar

Self-leveling screed drying times and thermal cycle for first start-up of the system according to the manufacturer's technical data sheet

9-14 days

Traditional

- Giunto di dilatazione >> p. 280
- Expansion joint
- Joint de dilatation
- Dehnfuge
- Junta de dilatación



- Rete elettrosaldata piana >> p. 281
- Electro-welded flat net
- Grille électrosoudée plane
- Flaches Schweißgitter
- Red electrosoldada piana



- Fibre di rinforzo >> p. 282
- Reinforcement fibres
- Fibres de renfort
- Verstärkungsfasern
- Fibras de refuerzo



- Additivo per massetti >> p. 282
- Additive for screeds
- Additif pour chapes
- Zusatzstoff für Versiegelungsschicht
- Aditivo para contra-pisos

Suggested height ≥ 45 mm over ashlar

Screed drying and thermal cycle times for first start-up of the system according to UNI EN 1264-4: 2021

28 days

Typical application	Residential
Multiple laying steps	5 cm
Pipes that can be installed	Ø16/2 - Ø17/2 mm



1. Perimeter edging
2. Humidity barrier
3. Insulation panel
4. Piping
5. Electro-welded mesh
6. Radiant screed

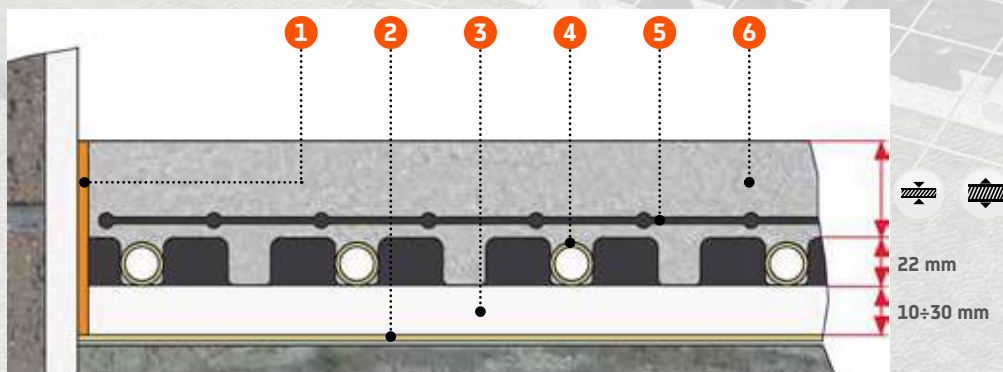

FOCUS: Minimum installation space >> p. 261

THERM

On request the material can be supplied in compliance with CAM requirements

- **Pannello termoformato in polistirene espanso.**
 - Dimensioni utili: 140 x 80 cm
 - Film plastico: 600 µm
 - Classe materiale (UNI EN 13163): EPS 200 (10 mm); EPS 150 (20-30 mm)
 - Conducibilità termica (EN 12667): λd 0,033 W/m K (10 mm); λd 0,034 W/m K (20-30 mm)
 - Resistenza a compressione al 10% di deformazione (UNI EN 826): 200 kPa (10 mm); 150 kPa (20-30 mm)
- **Thermoformed panel in expanded polystyrene.**
 - Useful dimensions: 140 x 80 cm
 - Plastic film: 600 µm
 - Material class (UNI EN 13163): EPS 200 (10 mm); EPS 150 (20-30 mm)
 - Thermal conductivity (EN 12667): λd 0,033 W/m K (10 mm); λd 0,034 W/m K (20-30 mm)
 - Compressive strength at 10% deformation (UNI EN 826): 200 kPa (10 mm); 150 kPa (20-30 mm)
- **Panneau thermoformé en polystyrène expansé.**
 - Dimensions utiles: 140 x 80 cm
 - Film plastique: 600 µm
 - Classe de matériau (UNI EN 13163): EPS 200 (10 mm); EPS 150 (20-30 mm)
 - Conductivité thermique (EN 12667): λd 0,033 W/m K (10 mm); λd 0,034 W/m K (20-30 mm)
 - Résistance à la compression à 10% de déformation (UNI EN 826): 200 kPa (10 mm); 150 kPa (20-30 mm)
- **Thermoformplatte aus expandiertem Polystyrol.**
 - Nützliche Abmessungen: 140 x 80 cm
 - Kunststofffolie: 600 µm
 - Materialklasse (UNI EN 13163): EPS 200 (10 mm); EPS 150 (20-30 mm)
 - Wärmeleitfähigkeit (EN 12667): λd 0,033 W/m K (10 mm); λd 0,034 W/m K (20-30 mm)
 - Druckfestigkeit bei 10% der Verformung (UNI EN 826): 200 kPa (10 mm); 150 kPa (20-30 mm)
- **Panel termoformado de poliestireno expandido.**
 - Dimensiones útiles: 140 x 80 cm
 - Película de plástico: 600 µm
 - Clase de material (UNI EN 13163): EPS 200 (10 mm); EPS 150 (20-30 mm)
 - Conductividad térmica (EN 12667): λd 0,033 W/m K (10 mm); λd 0,034 W/m K (20-30 mm)
 - Resistencia a la compresión al 10% de deformación (UNI EN 826): 200 kPa (10 mm); 150 kPa (20-30 mm)

Code	Insulation thickness	Total thickness	Thermal resistance	Pcs per package	Price	Class	Packaging
THERM10	10 mm	32 mm	0,30 m ² K/W	22 pcs	22,70 €/m ²	HU	24,64 m ²
THERM20	20 mm	42 mm	0,59 m ² K/W	16 pcs	25,50 €/m ²	HU	17,92 m ²
THERM30	30 mm	52 mm	0,88 m ² K/W	12 pcs	29,00 €/m ²	HU	13,44 m ²



- Tubazioni >> p. 87
- Pipes >> p. 87
- Tuyaux >> p. 87
- Rohre >> p. 87
- Tuberías >> p. 87



- Reggicurva >> p. 280
- Holding bend >> p. 280
- Courbe de support >> p. 280
- Stützkurve >> p. 280
- Curva de soporte >> p. 280



- Guaina isolante >> p. 280,283
- Insulating sheath >> p. 280,283
- Gaine isolante >> p. 280,283
- Isoliermantel >> p. 280,283
- Vaina aislante >> p. 280,283



- Fascia perimetrale >> p. 280
- Perimeter edging >> p. 280
- Bande périmétrique >> p. 280
- Umfangsband >> p. 280
- Banda perimetral >> p. 280



- Graffette >> p. 281
- Clips >> p. 281
- Clips >> p. 281
- Clips >> p. 281
- Pinzas >> p. 281



- Graffette >> p. 281
- Clips >> p. 281
- Clips >> p. 281
- Clips >> p. 281
- Pinzas >> p. 281

SUGGESTED SCREED

Self-leveling

NE 499
h ≥ 10 mm

NE 425
h ≥ 20 mm

Self-leveling screed height to be considered above the ashlar

Self-leveling screed drying times and thermal cycle for first start-up of the system according to the manufacturer's technical data sheet

9-14 days

Traditional

- Giunto di dilatazione >> p. 280
- Expansion joint
- Joint de dilatation
- Dehnfuge
- Junta de dilatación



- Rete elettrosaldata piana >> p. 281
- Electro-welded flat net
- Grille électrosoudée plane
- Flaches Schweißgitter
- Red electrosoldada plana



- Fibre di rinforzo >> p. 282
- Reinforcement fibres
- Fibres de renfort
- Verstärkungsfasern
- Fibras de refuerzo



- Additivo per massetti >> p. 282
- Additive for screeds
- Additif pour chapes
- Zusatzstoff für Versiegelungsschicht
- Aditivo para contra-pisos

Suggested height ≥ 45 mm over ashlar

Screed drying and thermal cycle times for first start-up of the system according to UNI EN 1264-4: 2021

28 days

Typical application	Residential
Multiple laying steps	5 cm
Pipes that can be installed	Ø16/2 - Ø17/2 mm

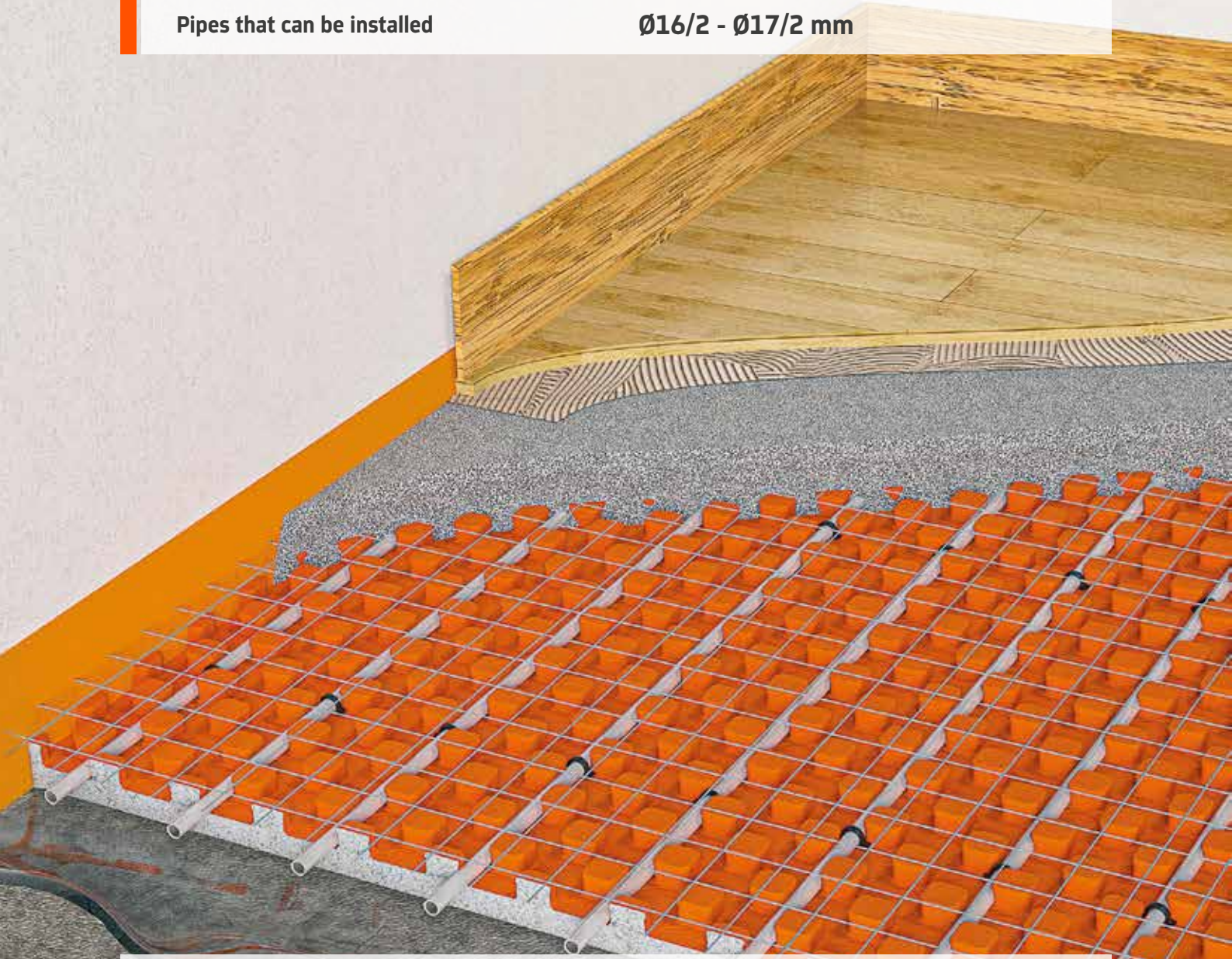

1. Perimeter edging
2. Humidity barrier
3. Insulation panel
4. Piping
5. Electro-welded mesh
6. Radiant screed

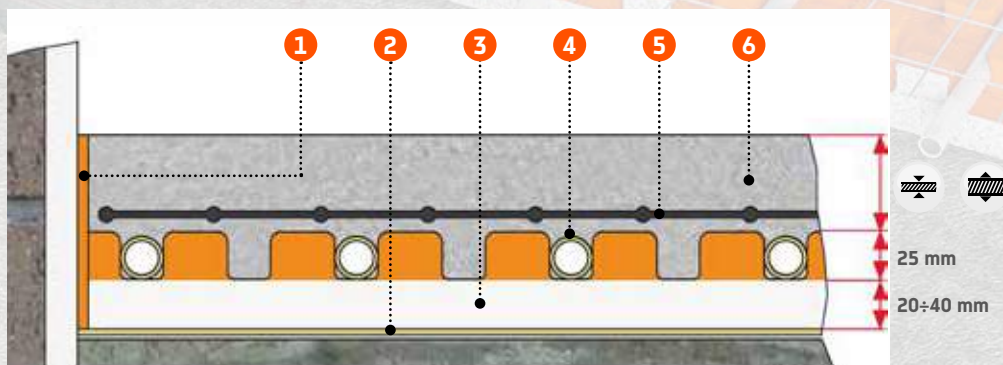

FOCUS: Minimum installation space >> p. 261

FAST-ORG

- **Pannello bugnato in polistirene espanso.**
 - Dimensioni utili: 140 x 80 cm
 - Film plastico: 170 µm
 - Classe materiale (UNI EN 13163): EPS 200
 - Conducibilità termica (EN 12667): λd 0,033 W/m K
 - Resistenza a compressione al 10% di deformazione (UNI EN 826): 200 kPa
- **Ashlar panel in expanded polystyrene.**
 - Useful dimensions: 140 x 80 cm
 - Plastic film: 170 µm
 - Material class (UNI EN 13163): EPS 200
 - Thermal conductivity (EN 12667): λd 0,033 W/m K
 - Compressive strength at 10% deformation (UNI EN 826): 200 kPa
- **Panneau bossage en polystyrène expansé.**
 - Dimensions utiles: 140 x 80 cm
 - Film plastique: 170 µm
 - Classe de matériau (UNI EN 13163): EPS 200
 - Conductivité thermique (EN 12667): λd 0,033 W/m K
 - Résistance à la compression à 10% de déformation (UNI EN 826): 200 kPa
- **Noppenplatte aus expandiertem Polystyrol.**
 - Nützliche Abmessungen: 140 x 80 cm
 - Kunststofffolie: 170 µm
 - Materialklasse (UNI EN 13163): EPS 200
 - Wärmeleitfähigkeit (EN 12667): λd 0,033 W/m K
 - Druckfestigkeit bei 10% der Verformung (UNI EN 826): 200 kPa
- **Panel almohadillado de poliestireno expandido.**
 - Dimensiones útiles: 140 x 80 cm
 - Película de plástico: 170 µm
 - Clase de material (UNI EN 13163): EPS 200
 - Conductividad térmica (EN 12667): λd 0,033 W/m K
 - Resistencia a la compresión al 10% de deformación (UNI EN 826): 200 kPa

Code	Insulation thickness	Total thickness	Thermal resistance	Pcs per package	Price	Class	Packaging
FAST20-ORG	20 mm	45 mm	0,61 m² K/W	16 pcs	22,40 €/m²	HU	17,92 m²
FAST30-ORG	30 mm	55 mm	0,91 m² K/W	12 pcs	26,90 €/m²	HU	13,44 m²
FAST40-ORG	40 mm	65 mm	1,21 m² K/W	10 pcs	33,20 €/m²	HU	11,20 m²



- Tubazioni >> p. 87
- Pipes >> p. 87
- Tuyaux >> p. 87
- Rohre >> p. 87
- Tuberías >> p. 87



- Reggicurve >> p. 280
- Holding bend >> p. 280
- Courbe de support >> p. 280
- Stützkurve >> p. 280
- Curva de soporte >> p. 280



- Guaina isolante >> p. 280,283
- Insulating sheath >> p. 280,283
- Gaine isolante >> p. 280,283
- Isoliermantel >> p. 280,283
- Vaina aislante >> p. 280,283



- Fascia perimetrale >> p. 280
- Perimeter edging >> p. 280
- Bande périmétrique >> p. 280
- Umfangsband >> p. 280
- Banda perimetral >> p. 280



- Barriera umidità >> p. 281
- Humidity barrier >> p. 281
- Barrière humidité >> p. 281
- Feuchtigkeitsbarriere >> p. 281
- Barrera contra la humedad >> p. 281



- Graffette >> p. 281
- Clips >> p. 281
- Clips >> p. 281
- Clips >> p. 281
- Pinzas >> p. 281

SUGGESTED SCREED

Self-leveling
NE 499
h ≥ 10 mm
NE 425
h ≥ 20 mm
Self-leveling screed height to be considered above the ashlar
Self-leveling screed drying times and thermal cycle for first start-up of the system according to the manufacturer's technical data sheet
9-14 days

Traditional

- Giunto di dilatazione >> p. 280
- Expansion joint
- Joint de dilatation
- Dehnfuge
- Junta de dilatación



- Rete elettrosaldata piana >> p. 281
- Electro-welded flat net
- Grille électrosoudée plane
- Flaches Schweißgitter
- Red electrosoldada plana



- Fibre di rinforzo >> p. 282
- Reinforcement fibres
- Fibres de renfort
- Verstärkungsfasern
- Fibras de refuerzo



- Additivo per massetti >> p. 282
- Additive for screeds
- Additif pour chapes
- Zusatzstoff für Versiegelungsschicht
- Aditivo para contra-pisos

Suggested height ≥ 45 mm over ashlar
Screed drying and thermal cycle times for first start-up of the system according to UNI EN 1264-4: 2021
28 days

Typical application	Tertiary
Multiple laying steps	5 cm
Pipes that can be installed	Ø16/2 - Ø17/2 - Ø20/2 - Ø25/2,3 mm



1. Perimeter edging
2. Humidity barrier
3. Insulation panel
- 4a. Piping + clip
- 4b. Piping + clip on the net
5. Electro-welded mesh
6. Radiant screed

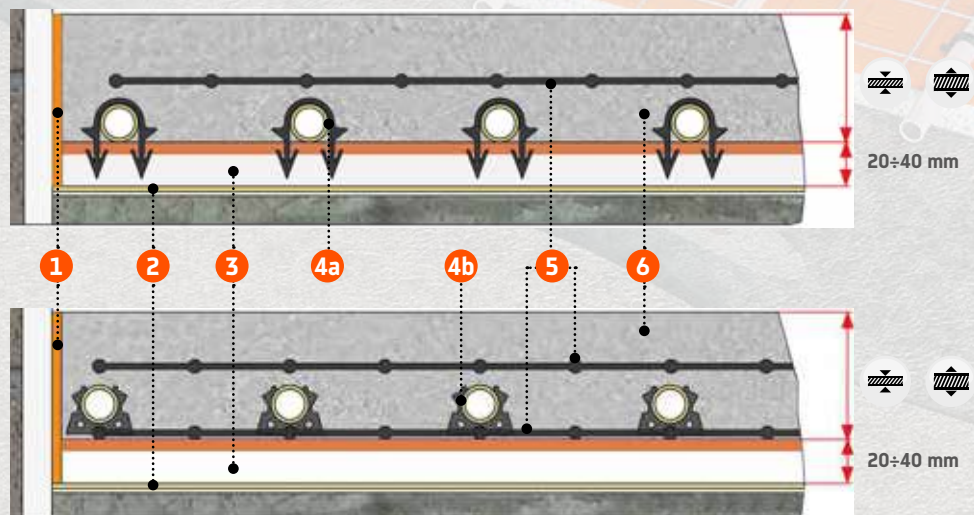

FOCUS: Minimum installation space >> p. 261

FLAT-ORG

- **Pannello piano in polistirene espanso.**
 - Dimensioni utili: 140 x 80 cm (20-40 mm); 100 x 50 cm (50 mm)
 - Film plastico: 170 µm
 - Classe materiale (UNI EN 13163): EPS 200
 - Conducibilità termica (EN 12667): λd 0,033 W/m K
 - Resistenza a compressione al 10% di deformazione (UNI EN 826): 200 kPa
- **Flat panel in expanded polystyrene.**
 - Useful dimensions: 140 x 80 cm (20-40 mm); 100 x 50 cm (50 mm)
 - Plastic film: 170 µm
 - Material class (UNI EN 13163): EPS 200
 - Thermal conductivity (EN 12667): λd 0,033 W/m K
 - Compressive strength at 10% deformation (UNI EN 826): 200 kPa
- **Panneau plat en polystyrène expansé.**
 - Dimensions utiles: 140 x 80 cm (20-40 mm); 100 x 50 cm (50 mm)
 - Film plastique: 170 µm
 - Classe de matériau (UNI EN 13163): EPS 200
 - Conductivité thermique (EN 12667): λd 0,033 W/m K
 - Résistance à la compression à 10% de déformation (UNI EN 826): 200 kPa
- **Flachplatte aus expandiertem Polystyrol.**
 - Nützliche Abmessungen: 140 x 80 cm (20-40 mm); 100 x 50 cm (50 mm)
 - Kunststoffolie: 170 µm
 - Materialklasse (UNI EN 13163): EPS 200
 - Wärmeleitfähigkeit (EN 12667): λd 0,033 W/m K
 - Druckfestigkeit bei 10% der Verformung (UNI EN 826): 200 kPa
- **Panel plano de poliestireno expandido.**
 - Dimensiones útiles: 140 x 80 cm (20-40 mm); 100 x 50 cm (50 mm)
 - Película de plástico: 170 µm
 - Clase de material (UNI EN 13163): EPS 200
 - Conductividad térmica (EN 12667): λd 0,033 W/m K
 - Resistencia a la compresión al 10% de deformación (UNI EN 826): 200 kPa

Code	Insulation thickness	Total thickness	Thermal resistance	Pcs per package	Price	Class	Packaging
FLAT20-ORG	20 mm	20 mm	0,61 m ² K/W	26 pcs	24,10 €/m ²	HU	29,12 m ²
FLAT30-ORG	30 mm	30 mm	0,91 m ² K/W	17 pcs	28,30 €/m ²	HU	19,04 m ²
FLAT40-ORG	40 mm	40 mm	1,21 m ² K/W	13 pcs	36,70 €/m ²	HU	14,56 m ²



- Tubazioni >> p. 87
- Pipes >> p. 87
- Tuyaux >> p. 87
- Rohre >> p. 87
- Tuberías >> p. 87



- Reggicurve >> p. 280
- Holding bend >> p. 280
- Courbe de support >> p. 280
- Stützkurve >> p. 280
- Curva de soporte >> p. 280



- Guaina isolante >> p. 280,283
- Insulating sheath >> p. 280,283
- Gaine isolante >> p. 280,283
- Isoliermantel >> p. 280,283
- Vaina aislante >> p. 280,283



- Graffette >> p. 281
- Clips >> p. 281
- Clips >> p. 281
- Clips >> p. 281
- Pinzas >> p. 281



- Fascia perimetrale >> p. 280
- Perimeter edging >> p. 280
- Bande périmétrique >> p. 280
- Umfangsband >> p. 280
- Banda perimetral >> p. 280



- Barriera umidità >> p. 281
- Humidity barrier >> p. 281
- Barrière humidité >> p. 281
- Feuchtigkeitbarriere >> p. 281
- Barrera contra la humedad >> p. 281



- Graffette >> p. 281
- Clips >> p. 281
- Clips >> p. 281
- Clips >> p. 281
- Pinzas >> p. 281



- Binari >> p. 282
- Rails >> p. 282
- Binaires >> p. 282
- Schiene >> p. 282
- Binarios >> p. 282

SUGGESTED SCREED

Self-leveling
NE 499
h ≥ 10 mm

NE 425
h ≥ 20 mm

Self-leveling screed height to be considered above the pipe
Self-leveling screed drying times and thermal cycle for first start-up of the system according to the manufacturer's technical data sheet
9-14 days

Traditional

- Giunto di dilatazione >> p. 280
- Expansion joint
- Joint de dilatation
- Dehnfuge
- Junta de dilatación



- Rete elettrosaldata piana >> p. 281
- Electro-welded flat net
- Grille électrosoudée plane
- Flaches Schweißgitter
- Red electrosoldada plana



- Fibre di rinforzo >> p. 282
- Reinforcement fibres
- Fibres de renfort
- Verstärkungsfasern
- Fibras de refuerzo



- Additivo per massetti >> p. 282
- Additive for screeds
- Additif pour chapes
- Zusatzstoff für Versiegelungsschicht
- Aditivo para contra-pisos

Suggested height ≥ 65 mm over panel
Screed drying and thermal cycle times for first start-up of the system according to UNI EN 1264-4: 2021
28 days

Typical application	Industrial
Multiple laying steps	Free
Pipes that can be installed	Ø16/2 - Ø17/2 - Ø20/2 - Ø25/2,3 mm

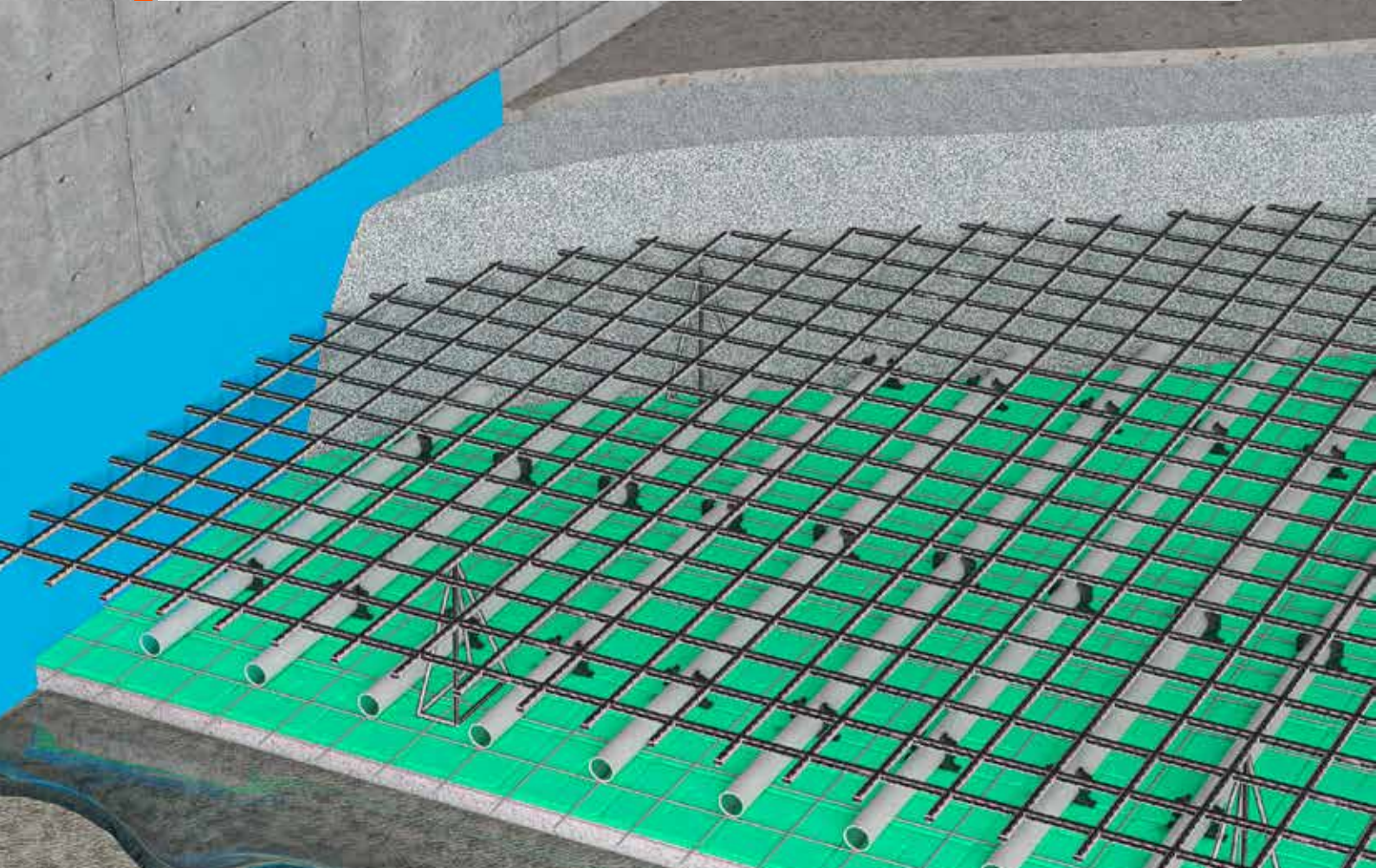

1. Perimeter edging
2. Humidity barrier
3. Insulation panel
- 4a. Piping + rail
- 4b. Piping + clip on the net
5. Electro-welded mesh
6. Screed for industrial systems

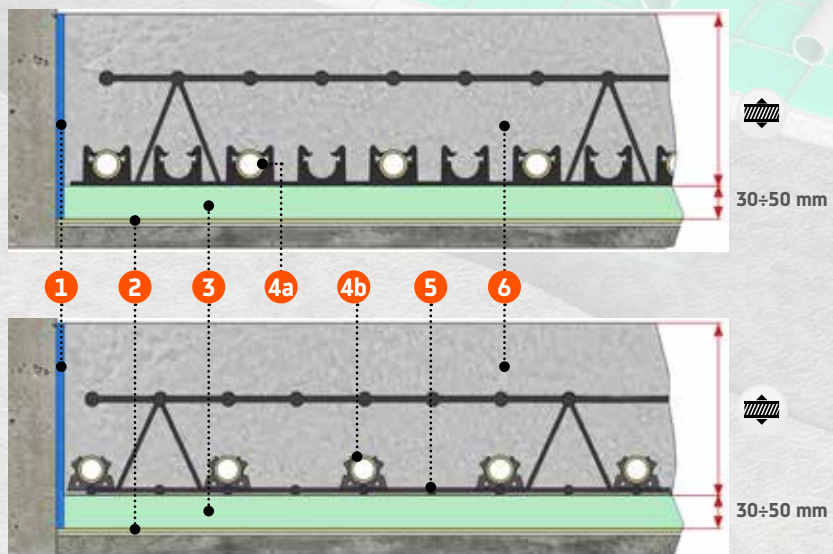

FOCUS: Minimum installation space >> p. 261

INDUSTRY

- **Pannello piano in polistirene espanso estruso con battentaura.**
 - Dimensioni utili: **125 x 60 cm**
 - Classe materiale: **XP5500**
 - **Conducibilità termica (EN 12667): λ_d 0,033 W/m K**
 - **Resistenza a compressione al 10% di deformazione (UNI EN 826): 500 kPa**
- **Flat panel in extruded expanded polystyrene with rabbet.**
 - Useful dimensions: **125 x 60 cm**
 - Material class: **XP5500**
 - Thermal conductivity (EN 12667): λ_d 0,033 W/m K
 - Compressive strength at 10% deformation (UNI EN 826): **500 kPa**
- **Panneau plat en polystyrène expansé extrudé.**
 - Dimensions utiles: **125 x 60 cm**
 - Classe de matériau: **XP5500**
 - Conductivité thermique (EN 12667): λ_d 0,033 W/m K
 - Résistance à la compression à 10% de déformation (UNI EN 826): **500 kPa**
- **Flachplatte aus extrudiertem expandiertem Polystyrol.**
 - Nützliche Abmessungen: **125 x 60 cm**
 - Materialklasse: **XP5500**
 - Wärmeleitfähigkeit (EN 12667): λ_d 0,033 W/m K
 - Druckfestigkeit bei 10% der Verformung (UNI EN 826): **500 kPa**
- **Panel plano de poliestireno expandido extruido.**
 - Dimensiones útiles: **125 x 60 cm**
 - Clase de material: **XP5500**
 - Conductividad térmica (EN 12667): λ_d 0,033 W/m K
 - Resistencia a la compresión al 10% de deformación (UNI EN 826): **500 kPa**

Code	Insulation thickness	Total thickness	Thermal resistance	Pcs per package	Price	Class	Packaging
INDUSTRY30	30 mm	30 mm	0,91 m ² K/W	14 pcs	31,50 €/m ²	HU	10,50 m ²
INDUSTRY40	40 mm	40 mm	1,21 m ² K/W	10 pcs	42,00 €/m ²	HU	7,50 m ²
INDUSTRY50	50 mm	50 mm	1,52 m ² K/W	8 pcs	51,25 €/m ²	HU	6 m ²



- Tubazioni >> p. 87
- Pipes >> p. 87
- Tuyaux >> p. 87
- Rohre >> p. 87
- Tuberías >> p. 87



- Reggicurva >> p. 280
- Holding bend >> p. 280
- Courbe de support >> p. 280
- Stützkurve >> p. 280
- Curva de soporte >> p. 280



- Guaina isolante >> p. 280,283
- Insulating sheath >> p. 280,283
- Gaine isolante >> p. 280,283
- Isoliermantel >> p. 280,283
- Vaina aislante >> p. 280,283



- Fascia perimetrale >> p. 280
- Perimeter edging >> p. 280
- Bande périmétrique >> p. 280
- Umfangsband >> p. 280
- Banda perimetral >> p. 280



- Barriera umidità >> p. 281
- Humidity barrier >> p. 281
- Barrière humidité >> p. 281
- Feuchtigkeitsbarriere >> p. 281
- Barrera contra la humedad >> p. 281



- Rete elettrosaldata piana >> p. 281
- Electro welded flat net >> p. 281
- Grille électrosoudée plane >> p. 281
- Flaches Schweißgitter >> p. 281
- Red electrosoldada plana >> p. 281



- Graffette >> p. 281
- Clips >> p. 281
- Clips >> p. 281
- Clips >> p. 281
- Pinzas >> p. 281



- Fissatubo >> p. 281
- Pipe fastener >> p. 281
- Arrêt-tuyau >> p. 281
- Rohrhalterung >> p. 281
- Sujeta-tubo >> p. 281



- Binari >> p. 282
- Rails >> p. 282
- Binaires >> p. 282
- Schiene >> p. 282
- Binaríos >> p. 282

SCREED NOT SUPPLIED BY IVAR

CEILING-WALL SYSTEMS

Typical application

Residential/Industrial

Supply pipes that can be installed

Ø20/2 mm

Reduced water absorption for application in humid rooms (type H1*)

Increased density (type D*) and reduced steam permeability (type E*)

High surface hardness and mechanical resistance (type I*)

Ionizing: it can absorb up to 70% of the formaldehyde in the air

*According to standard UNI EN 520:2009

1. Insulation panel
2. Piping
3. Plasterboard

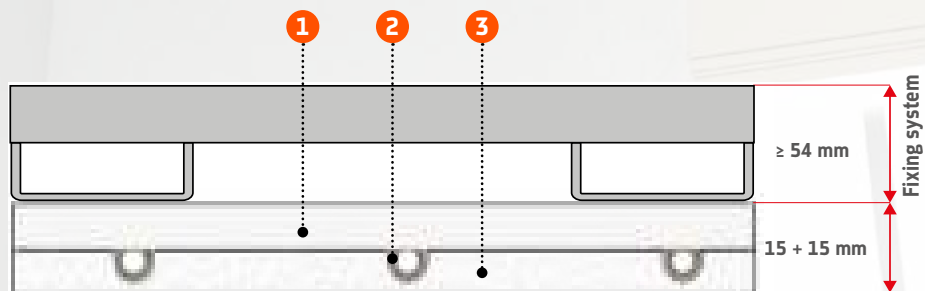

FIXING SYSTEM NOT SUPPLIED BY IVAR.

TOP-CLIMA A

- **Pannello attivo in cartongesso additivato con fibre di legno dolce e fibre di vetro prefabbricato con tubo PE-RT e strato isolante in polistirene espanso.**
 - Classe materiale (UNI EN 13163): EPS 150
 - Conduttività termica (EN 12667): λ_d 0,033 W/m K (isolante); λ_d 0,25 W/m K (lastra)
 - Diametro tubazione di collegamento: 10/1,3
 - Passo tubazione interna (spirale): 5 cm
- **Active plasterboard panel with additives of soft wood fibers and glass fibers prefabricated with PE-RT pipe and expanded polystyrene insulation layer.**
 - Material class (UNI EN 13163): EPS 150
 - Thermal conductivity (EN 12667): λ_d 0,033 W/m K (insulation); λ_d 0,25 W/m K (slab)
 - Connection pipe diameter: 10/1,3
 - Internal pipe step (spiral): 5 cm
- **Panneau actif en plaques de plâtre additionné de fibres de bois tendre et de fibres de verre préfabriqué avec tube PE-RT et couche isolante en polystyrène expansé.**
 - Classe de matériau (UNI EN 13163): EPS 150
 - Conductivité thermique (EN 12667): λ_d 0,033 W/m K (isolante); λ_d 0,25 W/m K (feuille)
 - Diamètre du tuyau de raccordement: 10/1,3 mm
 - Empattement du tuyau interne (spirale): 5 cm
- **Aktive Platte aus Gipskartonplatten mit Zusätzen von Holzweichfasern und Glasfasern vorgefertigt mit PE-RT-Rohr und Dämmschicht aus expandiertem Polystyrol.**
 - Materialklasse (UNI EN 13163): EPS 150
 - Wärmeleitfähigkeit (EN 12667): λ_d 0,033 W/m K (Isolierschicht); λ_d 0,25 W/m K (Platte)
 - Anschlussrohrdurchmesser: 10 / 1,3
 - Innerer Serpentinradstand (Spirale): 5 cm
- **Panel activo en cartón yeso con aditivos de fibras de madera blanda y fibras de vidrio prefabricadas con tubo PE-RT y capa aislante en poliestireno expandido.**
 - Clase de material (UNI EN 13163): EPS 150
 - Conductividad térmica (EN 12667): λ_d 0,033 W/m K (aislante); λ_d 0,25 W/m K (placa)
 - Diámetro de la tubería de conexión: 10/1,3
 - Distancia entre ejes serpentina interior (espiral): 5 cm

Code	Panel type	Insulation thickness	Total thickness	Useful dimensions	Thermal resistance	Price	Class	Packaging
TOP-A1006	Active single circuit	15 mm	30 mm	100 x 60 cm	0,45 m ² K/W	143,00 €/m ²	HU	0,60 m ²
TOP-A1012	Active single circuit	15 mm	30 mm	100 x 120 cm	0,45 m ² K/W	143,00 €/m ²	HU	1,20 m ²
TOP-A2006	Active single circuit	15 mm	30 mm	200 x 60 cm	0,45 m ² K/W	143,00 €/m ²	HU	1,20 m ²
TOP-A2012	Active double circuit	15 mm	30 mm	200 x 120 cm	0,45 m ² K/W	143,00 €/m ²	HU	2,40 m ²

TOP-CLIMA P

- **Pannello passivo in cartongesso additivato con fibre di legno dolce e fibre di vetro prefabbricato con strato isolante in polistirene espanso.**
 - Classe materiale (UNI EN 13163): EPS 150
 - Conduttività termica (EN 12667): λ_d 0,033 W/m K (isolante); λ_d 0,25 W/m K (lastra)
- **Passive plasterboard panel with added soft wood fibers and glass fibers prefabricated with PE-RT pipe and expanded polystyrene insulation layer.**
 - Material class (UNI EN 13163): EPS 150
 - Thermal conductivity (EN 12667): λ_d 0,033 W/m K (insulation); λ_d 0,25 W/m K (slab)
- **Panneau de plaques de plâtre passif avec ajout de fibres de bois tendre et de fibres de verre préfabriqué avec un tuyau PE-RT et une couche isolante en polystyrène expansé.**
 - Classe de matériau (UNI EN 13163): EPS 150
 - Conductivité thermique (EN 12667): λ_d 0,033 W/m K (isolante); λ_d 0,25 W/m K (feuille)
- **Passive Gipskartonplatte mit zugesetzten Holzweichfasern und Glasfasern vorgefertigt mit PE-RT-Rohr und expandierter Polystyrol-Dämmschicht.**
 - Materialklasse (UNI EN 13163): EPS 150
 - Wärmeleitfähigkeit (EN 12667): λ_d 0,033 W/m K (Isolierschicht); λ_d 0,25 W/m K (Platte)
- **Panel de cartón-yeso pasivo con agregado de fibras de madera blanda y fibras de vidrio prefabricadas con tubería PE-RT y capa aislante de poliestireno expandido.**
 - Clase de material (UNI EN 13163): EPS 150
 - Conductividad térmica (EN 12667): λ_d 0,033 W/m K (aislante); λ_d 0,25 W/m K (placa)

Code	Panel type	Insulation thickness	Total thickness	Useful dimensions	Thermal resistance	Price	Class	Packaging
TOP-P2012	Passive	15 mm	30 mm	200 x 120 cm	0,45 m ² K/W	143,00 €/m ²	HU	2,40 m ²



- Tubazioni >> p. 283
- Pipes >> p. 283
- Tuyaux >> p. 283
- Rohre >> p. 283
- Tuberías >> p. 283



- Fascia perimetrale >> p. 283
- Perimeter edging >> p. 283
- Bande périmétrique >> p. 283
- Umfangsband >> p. 283
- Banda perimetral >> p. 283



- Guaina isolante >> p. 280,283
- Insulating sheath >> p. 280,283
- Gaine isolante >> p. 280,283
- Isoliermantel >> p. 280,283
- Vaina aislante >> p. 280,283



- Raccordi >> p. 284
- Fittings >> p. 284
- Raccords >> p. 284
- Kupplungen >> p. 284
- Racores >> p. 284



- Isolante per raccordi >> p. 284
- Insulation for fittings >> p. 284
- Isolation pour les raccords >> p. 284
- Isolierung für Kupplungen >> p. 284
- Aislante para racores >> p. 284

- Per il fissaggio delle lastre utilizzare viti autofilettanti fosfatate nera RE-VERSO™ per lastre in cartongesso ad alta densità ϕ 3,9 x 45/55 mm (non fornito da IVAR)
- For panels fixing, use RE-VERSO™ black phosphated self-tapping screws for high density plasterboard sheets ϕ 3,9 x 45/55 mm (not supplied by IVAR)
- Pour fixer les plaques, utilisez les vis autotaraudeuses RE-VERSO™ phosphatées noires pour plaques de plâtre haute densité ϕ 3,9 x 45/55 mm (non fournies par IVAR)
- Verwenden Sie zur Befestigung der Platten RE-VERSO™ schwarz phosphatierte Blechschrauben für hochdichte Gipskartonplatten ϕ 3,9 x 45/55 mm (nicht von IVAR geliefert)
- Para fijar las láminas, utilice RE-VERSO™ tornillos autorroscantes fosfatados negros para láminas de cartón yeso de alta densidad ϕ 3,9 x 45/55 mm (no suministrado por IVAR)

Typical application

Tertiary

Supply pipes that can be installed

Ø20/2 mm

Panels available with smooth (L) or micro-drilled (F) surface, in RAL 9016 white

1. Insulation panel
2. Piping
3. Plasterboard
4. Metal covering panel

FIXING SYSTEM NOT SUPPLIED BY IVAR.

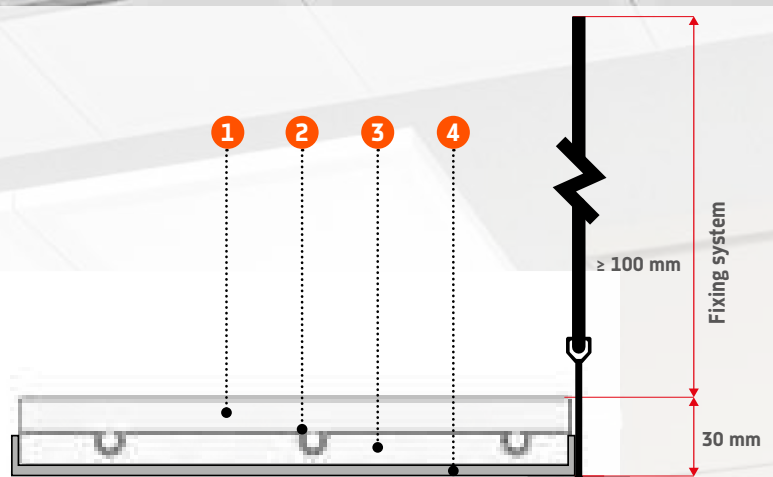

METAL-CLIMA A

- **Quadrotto metallico attivo di finitura per controsoffitti ispezionabili con pannello in cartongesso additivato con fibre di legno dolce e fibre di vetro prefabbricato con tubo PE-RT e isolante in polietilene espanso. Installazione su struttura a vista, nascosta o seminascosta. Finitura: Bianco RAL 9016.**
 - Classe materiale (UNI EN 13163): EPS 150
 - Conducibilità termica (EN 12667): λ_d 0,033 W/m K (isolante); λ_d 0,25 W/m K (lastra)
 - Diametro tubazione di collegamento: 10/1,3
 - Passo tubazione interna (spirale): 5 cm
- *Active metallic finishing square panel for inspectable false ceilings with plasterboard panel with additives of soft wood fibers and glass fibers prefabricated with PE-RT pipe and expanded polyethylene insulation. Installation on visible, hidden or semi-hidden structure. Finish: white RAL 9016.*
 - Material class (UNI EN 13163): EPS 150
 - Thermal conductivity (EN 12667): λ_d 0.033 W/m K (insulator); λ_d 0.25 W/m K (sheet)
 - Connection pipe diameter: 10/1.3
 - Internal piping pitch (spiral): 5 cm
- **Panneau de finition métallique actif pour faux-plafonds inspectables avec panneau en plaques de plâtre avec additifs en fibres de bois tendre et fibres de verre préfabriqués avec tube PE-RT et isolation en polyéthylène expansé. Installation sur structure visible, cachée ou semi-cachée. Finition : Blanc RAL 9016.**
 - Classe de matériau (UNI EN 13163) : EPS 150
 - Conductivité thermique (EN 12667) : λ_d 0,033 W/m K (isolant) ; λ_d 0,25 W/m K (feuille)
 - Diamètre du tuyau de raccordement : 10/1,3
 - Pas de tuyauterie interne (spirale) : 5 cm
- *Aktive metallische Abschlussplatte für inspizierfähige Zwischendecken mit Gipskartonplatte mit Zusätzen von Weichholzfasern und Glasfasern, vorgefertigt mit PE-RT-Rohr und expandierter Polyethylenisolierung. Installation auf sichtbarer, verdeckter oder halbverdeckter Struktur. Ausführung: Weiß RAL 9016.*
 - Materialklasse (UNI EN 13163): EPS 150
 - Wärmeleitfähigkeit (EN 12667): λ_d 0,033 W/m K (Isolator); λ_d 0,25 W/m K (Blatt)
 - Anschlussrohrdurchmesser: 10/1,3
 - Interner Rohrleitungsabstand (Spirale): 5 cm
- **Panel de acabado metálico activo para falsos techos inspeccionables con panel de yeso con aditivos de fibras de madera blanda y fibras de vidrio prefabricadas con tubo PE-RT y aislamiento de polietileno expandido. Instalación sobre estructura visible, oculta o semiculta. Acabado: Blanco RAL 9016.**
 - Clase de material (UNI EN 13163): EPS 150
 - Conductividad térmica (EN 12667): λ_d 0.033 W/m K (aislante); λ_d 0,25 W/m K (hoja)
 - Diámetro del tubo de conexión: 10/1,3
 - Paso de tubería interna (espiral): 5 cm

Code	Panel type	Insulation thickness	Total thickness	Useful dimensions	Thermal resistance	Finishing	Price	Class	Packaging
METAL-AL	Active	15 mm	30 mm	60 x 60 cm	0,45 m ² K/W	Smooth	266,80 €/m ²	HU	0,36 m ²
METAL-AF	Active	15 mm	30 mm	60 x 60 cm	0,45 m ² K/W	Drilled	276,10 €/m ²	HU	0,36 m ²

METAL-CLIMA P

- **Quadrotto metallico passivo di finitura per controsoffitti ispezionabili con pannello in cartongesso additivato con fibre di legno dolce e fibre di vetro prefabbricato con isolante in polietilene espanso. Installazione su struttura a vista, nascosta o seminascosta. Finitura: bianco RAL 9016.**
 - Classe materiale (UNI EN 13163): EPS 150
 - Conducibilità termica (EN 12667): λ_d 0,033 W/m K (isolante); λ_d 0,25 W/m K (lastra)
- *Passive metal finishing square panel for inspectable false ceilings with plasterboard panel with additives of soft wood fibers and prefabricated glass fibers with expanded polyethylene insulation. Installation on visible, hidden or semi-hidden structure. Finish: white RAL 9016.*
 - Material class (UNI EN 13163): EPS 150
 - Thermal conductivity (EN 12667): λ_d 0.033 W/m K (insulator); λ_d 0.25 W/m K (sheet)
- **Panneau de finition métallique passive pour faux-plafonds inspectables avec panneau en plaques de plâtre additionné de fibres de bois tendre et de fibres de verre préfabriquées avec isolation en polyéthylène expansé. Installation sur structure visible, cachée ou semi-cachée. Finition : blanc RAL 9016.**
 - Classe de matériau (UNI EN 13163) : EPS 150
 - Conductivité thermique (EN 12667) : λ_d 0,033 W/m K (isolant) ; λ_d 0,25 W/m K (feuille)
- *Passive Metallabschlussplatte für inspizierfähige Zwischendecken mit Gipskartonplatte mit Zusätzen von Weichholzfasern und vorgefertigten Glasfasern mit expandierter Polyethylenisolierung. Installation auf sichtbarer, verdeckter oder halbverdeckter Struktur. Ausführung: weiß RAL 9016.*
 - Materialklasse (UNI EN 13163): EPS 150
 - Wärmeleitfähigkeit (EN 12667): λ_d 0,033 W/m K (Isolator); λ_d 0,25 W/m K (Blatt)
- **Panel de acabado metálico pasivo para falsos techos inspeccionables con panel de yeso con aditivos de fibras de madera blanda y fibras de vidrio prefabricadas con aislamiento de polietileno expandido. Instalación sobre estructura visible, oculta o semiculta. Acabado: blanco RAL 9016.**
 - Clase de material (UNI EN 13163): EPS 150
 - Conductividad térmica (EN 12667): λ_d 0.033 W/m K (aislante); λ_d 0,25 W/m K (hoja)

Code	Panel type	Insulation thickness	Total thickness	Useful dimensions	Thermal resistance	Finishing	Price	Class	Packaging
METAL-PL	Passive	15 mm	30 mm	60 x 60 cm	0,45 m ² K/W	Smooth	266,80 €/m ²	HU	0,36 m ²
METAL-PF	Passive	15 mm	30 mm	60 x 60 cm	0,45 m ² K/W	Drilled	276,10 €/m ²	HU	0,36 m ²



- Tubazioni >> p. 283
- Pipes >> p. 283
- Tuyaux >> p. 283
- Rohre >> p. 283
- Tuberías >> p. 283



- Fascia perimetrale >> p. 283
- Perimeter edging >> p. 283
- Bande périmétrique >> p. 283
- Umfangsband >> p. 283
- Banda perimetral >> p. 283



- Guaina isolante >> p. 280,283
- Insulating sheath >> p. 280,283
- Gaine isolante >> p. 280,283
- Isoliermantel >> p. 280,283
- Vaina aislante >> p. 280,283



- Raccordi >> p. 284
- Fittings >> p. 284
- Raccords >> p. 284
- Kupplungen >> p. 284
- Racores >> p. 284



- Isolante per raccordi >> p. 284
- Insulation for fittings >> p. 284
- Isolation pour les raccords >> p. 284
- Isolierung für Kupplungen >> p. 284
- Aislante para racores >> p. 284

ACCESSORIES FOR FLOOR SYSTEMS

REGCU



- Reggicurva di sostegno per protezione tubazioni.
- Holding bend for pipe protection.
- Courbe de support pour la protection des tuyaux.
- Stützkurve für den Rohrschutz.
- Curva de soporte para protección de tubería.

Code	Pipe	Price	Class	Packaging
REGCU-17	Ø16 - Ø17 mm	2,543 €	HP	50
REGCU-20	Ø20 mm	3,287 €	HP	50
REGCU-25	Ø25 mm	3,892 €	HP	50

FAS-SLIM



- Fascia perimetrale con adesivo parziale e bandella adesiva.
- Perimeter edging with partial adhesive and adhesive strip.
- Bande périmétrique avec adhésif partiel et bande adhésive.
- Umfangsband mit Teilkleber und Klebestreifen.
- Banda perimetral con adhesivo parcial y tira adhesiva.

Code	Size	Color	Price	Class	Packaging
FAS-080L	80 x 6 mm	■	3,887 €/m	HP	25 m

FAS-INDUSTRY



- Fascia perimetrale con adesivo parziale.
- Perimeter edging with partial adhesive.
- Bande périmétrique avec adhésif partiel.
- Umfangsband mit Teilkleber.
- Banda perimetral con adhesivo parcial.

Code	Size	Color	Price	Class	Packaging
FAS-300	300 x 10 mm	■	4,328 €/m	HP	50 m

SOUND



- Isolante acustico per sistemi a pavimento con massetto tradizionale, $\Delta L_w = 30,3$ dB (UNI EN ISO 10140-3:2021).
- Sound absorbing panel for floor systems with traditional screed, $\Delta L_w = 30.3$ dB (UNI EN ISO 10140-3: 2021).
- Panneau absorbant acoustique pour les systèmes à plancher avec chape traditionnelle, $\Delta L_w = 30,3$ dB (UNI EN ISO 10140-3 : 2021).
- Geräuschdämmende Platte für Bodensysteme mit herkömmlichem Estrich, $\Delta L_w = 30,3$ dB (UNI EN ISO 10140-3: 2021).
- Panel fonoabsorbente para sistemas de suelo con solera tradicional, $\Delta L_w = 30,3$ dB (UNI EN ISO 10140-3: 2021).

Code	Size	Insulation thickness	Price	Class	Packaging
SOUND-09	1,3 x 50 m	9 mm	14,41 €/m ²	HP	65 m ²

ISOL



- Guaina isolante per tubazioni.
- Insulating sheath for pipes.
- Gaine isolante pour tuyaux.
- Isoliermantel für Rohre.
- Vaina aislante para tubos.

Code	Insulation thickness	Pipe	Price	Class	Packaging
ISOL-17	6 mm	Ø16 - Ø17 mm	1,627 €/m	HP	2 m
ISOL-20	6 mm	Ø20 mm	1,74 €/m	HP	2 m
ISOL-25	6 mm	Ø25 mm	2,034 €/m	HP	2 m

FAS



- Fascia perimetrale con adesivo parziale e bandella.
- Perimeter edging with partial adhesive and strip.
- Bande périmétrique avec adhésif partiel et bande.
- Umfangsband mit Teilkleber und Streifen.
- Banda perimetral con adhesivo parcial y tira.

Code	Size	Color	Price	Class	Packaging
FAS-150	150 x 8 mm	■	2,271 €/m	HP	50 m

GIU



- Giunto di dilatazione.
- Expansion joint.
- Joint de dilatation.
- Dehnfuge.
- Junta de dilatación.

Code	Size	Price	Class	Packaging
GIU-90	90 x 2000 mm	11,23 €/m	HP	2 m

ISOL-SOUND



- Nastro adesivo termoacustico per pannello SOUND.
- Thermo-acoustic adhesive tape for SOUND panel.
- Ruban adhésif thermo-acoustique pour panneau SOUND.
- Thermoakustisches Klebeband für SOUND Panel.
- Cinta adhesiva termoacústica para panel SOUND.

Code	Insulation thickness	Width	Price	Class	Packaging
ISOL-SOUND	3 mm	100 mm	2,124 €/m	HP	25 m

RP 5700



- Raccordo diritto per tubo in polietilene per riparazione circuito, compatibile con pinza TH.
- Straight fitting for polyethylene pipe for circuit repair, suitable for TH jaw.
- Raccord droit pour tube en polyéthylène pour la réparation des circuits, adaptée pour pince TH.
- Kupplung für Polyäthylen-Rohr zur Schaltungsreparatur, geeignet für Zange TH.
- Racor recto para tubo de polietileno para la reparación del circuito, adecuado para pinza TH.

Code	Size	Price	Class	Packaging
510201	17/2 x 17/2	7,45 €	IA	40 / 320

BU

- Barriera umidità, spessore 200 µm.
- Humidity barrier, thickness 200 µm.
- Barrière humidité, épaisseur 200 µm.
- Feuchtigkeitsbarriere, Dicke 200 µm.
- Barrera contra la humedad, espesor 200 µm.

Code	Size	Price	Class	Packaging
BU-100	2 x 50 m	2,552 €/m ²	HP	100 m ²

CLIP03

- Cavallotto fissarete.
- Stand for net.
- Crampillon de fixation grillage.
- Gitterklemme.
- Perno en u para fijación de red.

Code	OC distance	Price	Class	Packaging
CLIP03	75 mm	0,273 €	HP	100

HD09

- Attrezzo per fissaggio tubo automatico con graffette CLIP20AUT.
- Clip gun for automatic pipe fixing with CLIP20AUT.
- Outil pour le fixage du tuyau automatique avec les agrafes CLIP20AUT.
- Automatisches Rohrbefestigungswerkzeug für Klammern CLIP20AUT.
- Herramienta para fijación tubo automática con grapas CLIP20AUT.

Code	Price	Class	Packaging
HD09	461,77 €	HP	1

CLIP-FLAT 17

- Clip fermatubo manuale per rete.
- Manual pipe clamping clip for net.
- Clip arret-tuyau manuel pour grille.
- Manueller Rohrhalterungsclip für Gitter.
- Pinza sujeta tubo manual para red.

Code	Pipe	Net	Price	Class	Packaging
CLIP17F3	Ø16 - Ø17 mm	Ø2 - Ø3 mm	0,356 €	HP	100

CLIP-FLAT 25

- Clip fermatubo manuale per rete.
- Manual pipe clamping clip.
- Clip arret-tuyau manuel.
- Manueller Rohrhalterungsclip.
- Pinza sujeta tubo manual.

Code	Pipe	Net	Price	Class	Packaging
CLIP25F6	Ø25 mm	Ø3 - Ø6 mm	0,38 €	HP	100

NET-FLAT

- Rete elettrosaldata piana.
- Electro welded flat net.
- Grille électrosoudée plane.
- Flaches Schweißgitter.
- Red electrosoldada plana.

Code	Size	Price	Class	Packaging
RE-100F3	100 x 100 mm - Ø3 mm	10,09 €/m ²	HP	30 m ²
RE-50F2	50 x 50 mm - Ø2 mm	5,82 €/m ²	HP	40 m ²

CLIP-MAN

- Graffetta per fissaggio tubo manuale.
- Clip for manual pipe fixing.
- Agrafe pour fixage tuyau manuel.
- Rohrklammer manuell.
- Grapa de fijación tubo manual.

Code	Pipe	Price	Class	Packaging
CLIP20	≤ Ø20 mm	0,166 €	HP	100

CLIP-AUT

- Graffetta per fissaggio tubo automatico.
- Clip for automatic pipe fixing.
- Agrafe pour fixage tuyau automatique.
- Rohrklammer Automatik.
- Grapa de fijación tubo automática.

Code	Pipe	Price	Class	Packaging
CLIP20AUT	≤ Ø20 mm	0,214 €	HP	100

CLIP-FLAT 20

- Clip fermatubo manuale per rete.
- Manual pipe clamping clip for net.
- Clip arret-tuyau manuel pour grille.
- Manueller Rohrhalterungsclip für Gitter.
- Pinza sujeta tubo manual para red.

Code	Pipe	Net	Price	Class	Packaging
CLIP20F3	Ø20 mm	Ø2 - Ø3 mm	0,356 €	HP	100

CLIP-NET

- Fissatubo manuale per rete.
- Manual pipe fastener for net.
- Arret-tuyau manuel pour grille.
- Manueller Rohrhalterung für Gitter.
- Sujeta-tubo manual para red.

Code	Pipe	Net	Price	Class	Packaging
CLIP2025F8	Ø20 - Ø25 mm	Ø3 - Ø8 mm	0,463 €	HP	100

BIN



- Binario con biadesivo per ancoraggio tubi. Interasse minimo di posa tubazioni: 50 mm.
- Rail with double-sided tape for pipes anchoring. Minimum distance for pipe placement 50 mm.
- Binaires avec ruban adhésif double face pour ancrage des tuyaux. Entraxe minimum de pose tuyauterie: 50 mm.
- Schiene mit doppelseitigem Klebeband für Rohrverankerung. Minimum Achsabstand für Verlegung von Rohrleitungen: 50 mm.
- Binario con cinta adhesiva de doble cara para el anclaje de las tuberías. Intereje mínimo para colocar las tuberías: 50 mm.

Code	Pipe	Length	Price	Class	Packaging
BIN-17B	Ø16 - Ø17 mm	2 m	3,921 €/m	HP	2 / 32 m

BIN-INDUSTRY



- Binario con biadesivo per ancoraggio tubi. Interasse minimo di posa tubazioni: 50 mm.
- Rail with double-sided tape for pipes anchoring. Minimum distance for pipe placement 50 mm.
- Binaires avec ruban adhésif double face pour ancrage des tuyaux. Entraxe minimum de pose tuyauterie: 50 mm.
- Schiene mit doppelseitigem Klebeband für Rohrverankerung. Minimum Achsabstand für Verlegung von Rohrleitungen: 50 mm.
- Binario con cinta adhesiva de doble cara para el anclaje de las tuberías. Intereje mínimo para colocar las tuberías: 50 mm.

Code	Pipe	Length	Price	Class	Packaging
BIN-20B50	Ø20 mm	2 m	4,701 €/m	HP	2 / 32 m
BIN-25B50	Ø25 mm	2 m	6,79 €/m	HP	2 / 32 m

FIB



- Fibre di rinforzo per massetti in calcestruzzo.
- Reinforcement fibres for concrete screeds.
- Fibres de renfort pour chapes en béton.
- Verstärkungsfasern für Beton-Versiegelungsschicht.
- Fibras de refuerzo para soleras de hormigón.

Code	Dosage	Price	Class	Packaging
FIB-12	0,6 - 1,8 kg/m³	17,52 €	HP	1

ADD-M



- Additivo per massetti in calcestruzzo.
- Additive for concrete screeds.
- Additif pour chapes en béton.
- Zusatzstoff für Beton-Versiegelungsschicht.
- Aditivo para contra-pisos de hormigón.

Code	Dosage	Price	Class	Packaging
ADD-10M	1 l / 100 kg concrete	4,746 €/l	HP	10 l

IV 100 LT



- Additivo inibitore antiincrostante per impianti a bassa temperatura.
- Anti-scaling inhibitor additive for low temperature systems.
- Additif inhibiteur anti-incrustant pour les systèmes à basse température.
- Anti-Kesselstein-Hemmender Zusatzstoff für Niedertemperatursysteme.
- Aditivo antiincrustante inhibidor para sistemas de baja temperatura.

Code	Size	Price	Class	Packaging
IV100LT	1 l	47,50 €/l	TI	1 l
IV100LT-10	10 kg	40,00 €/Kg	TI	10 Kg

IV 400



- Additivo risanante.
- Sanitizing additive.
- Additif désembouant.
- Schlammferner.
- Aditivo restaurativo.

Code	Size	Price	Class	Packaging
IV400	1 l	52,40 €/l	TI	1 l
IV400-10	10 kg	44,60 €/Kg	TI	10 Kg

ACCESSORIES FOR CEILING-WALL SYSTEMS

■ IVAR-PE-Xa B



- Tubo PE-Xa con barriera EVOH a 3 strati completo di coibentazione termica.
- PE-Xa pipe with 3-layer EVOH barrier complete with thermal insulation.
- Tuyau PE-Xa avec barrière EVOH à 3 couches avec isolation thermique.
- 3-lagiges PE-Xa-3-Rohr komplett mit EVOH-Bariere und Wärmedämmung.
- Tubo PE-Xa con barrera EVOH de 3 capas con aislamiento térmico.

Code	Size	Insulation thickness	Color	Price	Class	Packaging
I-PEXA20RCB25	Ø20/2	10 mm	■	4,99 €/m	HN	25 m

■ IVAR-PE-Xa R



- Tubo PE-Xa con barriera EVOH a 3 strati completo di coibentazione termica.
- PE-Xb/Al/PE-Xb multilayer pipe in coils complete with thermal insulation.
- Tuyau PE-Xa avec barrière EVOH à 3 couches avec isolation thermique.
- 3-lagiges PE-Xa-3-Rohr komplett mit EVOH-Bariere und Wärmedämmung.
- Tubo PE-Xa con barrera EVOH de 3 capas con aislamiento térmico.

Code	Size	Insulation thickness	Color	Price	Class	Packaging
I-PEXA20RCR25	Ø20/2	10 mm	■	4,99 €/m	HN	25 m

■ ATR01-07



- Utensile manuale per svasamento tubazione (senza espansore).
- Manual pipe flaring tool (without expanding jaw).
- Outil manuel pour l'évasement du tuyau (sans expasseur).
- Manuelles Werkzeug für Rohrkanten entgraten (ohne Expander).
- Herramienta manual para el abocardado del tubo (sin expansor).

Code	Size	Price	Class	Packaging
ATR01-PPSU	Manual	571,78 €	IX	1
ATR07-PPSU	Battery Powered	4.112,65 €	IX	1

■ ATR02/03



- Espansore per tubo multistrato/polietilene.
- Expanding jaw for multilayer/polyethylene pipe.
- Expanseur pour tuyau multicouche et en polyéthylène.
- Expander für Verbundrohr und Polyethylenrohr.
- Expansor para tubo multicapa y tubo de polietileno.

Code	Size	Price	Class	Packaging
ATR02-PPSU	10/1,3	205,83 €	IX	1
ATR03-PPSU	20/2	205,83 €	IX	1

■ ATR04



- Utensile di serraggio (senza pinza meccanica).
- Pressure sleeve tool (without pressure jaw).
- Outil de serrage (sans pince mécanique).
- Spannwerkzeug (ohne mechanische Zange).
- Herramienta de apriete (sin pinza mecánica).

Code	Price	Class	Packaging
ATR04-PPSU	377,37 €	IX	1

■ ATR05/06



- Coppia di pinze meccaniche per tubo multistrato/polietilene.
- Pair of pressure jaws for multilayer/polyethylene pipe.
- Paire de pinces mécaniques pour tuyau multicouche et en polyéthylène.
- Paar mechanische Zangen für Verbundrohr und Polyethylenrohr.
- Par de pinzas mecánicas para tubo multicapa y tubo de polietileno.

Code	Size	Price	Class	Packaging
ATR05-PPSU	10/1,3	205,83 €	IX	1
ATR06-PPSU	20/2	162,99 €	IX	1

■ FAS-SR



- Fascia perimetrale con adesivo parziale per sistemi a soffitto.
- Perimeter edging with partial adhesive for ceiling systems.
- Bande périmétrique avec adhésif partiel pour les systèmes à plafond.
- Umfangsband mit Teilkleber für Deckensysteme.
- Banda perimetral con adhesivo parcial para sistemas de techo.

Code	Size	Color	Price	Class	Packaging
FAS-150SR	150 x 3,3 mm	□	2,441 €/m	HP	50 m

■ ISOL



- Guaina isolante per tubazioni.
- Insulating sheath for pipes.
- Gaine isolante pour tuyaux.
- Isoliermantel für Rohre.
- Vaina aislante para tubos.

Code	Insulation thickness	Pipe	Price	Class	Packaging
ISOL-10	6 mm	Ø10 mm	1,266 €/m	HP	2 m
ISOL-17	6 mm	Ø16 - Ø17 mm	1,627 €/m	HP	2 m
ISOL-20	6 mm	Ø20 mm	1,74 €/m	HP	2 m
ISOL-25	6 mm	Ø25 mm	2,034 €/m	HP	2 m

■ PPSU1



- Raccordo diritto ad innesto rapido per tubo multistrato.
- Quick coupling straight connector for multilayer pipe.
- Raccord droit à enclenchement rapide pour tuyau multicouche.
- Gerader Anschluss mit Schnellkupplung für Verbundrohr.
- Racor recto de conexión rápida para tubo multicapa.

Code	Size	Price	Class	Packaging
PPSU1RV	20/2 x 20/2	6,37 €	IX	10

■ PPSU3



- Raccordo a T ad innesto rapido per tubo multistrato.
- Quick coupling T-connector for multilayer pipe.
- Raccord en T à enclenchement rapide pour tuyau multicouche.
- T-Anschluss mit Schnellkupplung für Verbundrohr.
- Racor en T con conexión rápida para tubo multicapa.

Code	Size	Price	Class	Packaging
PPSU3RV	20/2 x 20/2 x 20/2	9,44 €	IX	10

■ PPSU5



- Raccordo a croce ridotto ad innesto rapido per tubo multistrato 20/2 e tubo in polietilene 10/1,3.
- Reduced quick coupling cross-connector for 20/2 multilayer pipe and 10/1,3 polyethylene pipe.
- Raccord à croix réduit à enclenchement rapide pour tuyau multicouche 20/2 et tuyau en polyéthylène 10/1,3.
- Reduzierter Kreuz-Anschluss mit Schnellkupplung für Verbundrohr 20/2 und Polyethylenrohr 10/1,3.
- Racor en cruz reducido con conexión rápida para tubo multicapa 20/2 y tubo de polietileno 10/1,3.

Code	Size	Price	Class	Packaging
PPSU5RV	20/2 x 10/1,3 x 20/2 x 10/1,3	12,97 €	IX	10

■ PPSU7



- Anello di tenuta per tubo multistrato.
- Sealing ring for multilayer pipe.
- Bague d'étanchéité pour tuyau multicouche.
- Dichtungsring für Verbundrohr.
- Anillo de sellado para tubo multicapa.

Code	Size	Price	Class	Packaging
PPSU7RV	20/2	2,017 €	IX	50

■ PPSU9



- Raccordo ad angolo ad innesto rapido per tubo multistrato.
- Quick coupling angle-connector for multilayer pipe.
- Raccord à angle à enclenchement rapide pour tuyau multicouche.
- Winkel mit Schnellkupplung für Verbundrohr.
- Racor codo con conexión rápida para tubo multicapa.

Code	Size	Price	Class	Packaging
PPSU9RV	20/2 x 20/2	7,06 €	IX	10

■ PPSU2



- Raccordo diritto ad innesto rapido per tubo polietilene.
- Quick coupling straight connector for polyethylene pipe.
- Raccord droit à enclenchement rapide pour tuyau en polyéthylène.
- Gerader Anschluss mit Schnellkupplung für Polyethylenrohr.
- Racor recto de conexión rápida para tubo de polietileno.

Code	Size	Price	Class	Packaging
PPSU2RV	10/1,3 x 10/1,3	1,97 €	IX	10

■ PPSU4



- Raccordo a T ridotto ad innesto rapido per tubo multistrato 20/2 e tubo in polietilene 10/1,3.
- Reduced quick coupling T-connector for 20/2 multilayer pipe and 10/1,3 polyethylene pipe.
- Raccord en T réduit à enclenchement rapide pour tuyau multicouche 20/2 et tuyau en polyéthylène 10/1,3.
- Reduzierter T-Anschluss mit Schnellkupplung für Verbundrohr 20/2 und Polyethylenrohr 10/1,3.
- Racor en T reducido con conexión rápida para tubo multicapa 20/2 y tubo de polietileno 10/1,3.

Code	Size	Price	Class	Packaging
PPSU4RV	20/2 x 10/1,3 x 20/2	7,06 €	IX	10

■ PPSU6



- Raccordo ad angolo ridotto ad innesto rapido per tubo multistrato 20/2 e tubo in polietilene 10/1,3.
- Reduced quick coupling angle-connector for 20/2 multilayer pipe and 10/1,3 polyethylene pipe.
- Raccord à angle réduit à enclenchement rapide pour tuyau multicouche 20/2 et tuyau en polyéthylène 10/1,3.
- Reduzierter Winkel mit Schnellkupplung für Verbundrohr 20/2 und Polyethylenrohr 10/1,3.
- Racor codo reducido con conexión rápida para tubo multicapa 20/2 y tubo de polietileno 10/1,3.

Code	Size	Price	Class	Packaging
PPSU6RV	20/2 x 10/1,3	6,37 €	IX	10

■ PPSU8



- Anello di tenuta per tubo polietilene.
- Sealing ring for polyethylene pipe.
- Bague d'étanchéité pour tuyau en polyéthylène.
- Dichtungsring für Polyethylenrohr.
- Anillo de sellado para tubo de polietileno.

Code	Size	Price	Class	Packaging
PPSU8RV	10/1,3	1,104 €	IX	50

■ ISOL-PPSU



- Isolante per raccordi.
- Insulation for fittings.
- Isolation pour les raccords.
- Isolierung für Kupplungen.
- Aislante para racores.

Code	Insulation thickness	Length	Price	Class	Packaging
ISOL-RACC	3 mm	10 m	1,48 €/m	HP	10 m

DEHUMIDIFIERS

■ DEU-S



- Deumidificatore da incasso a controsoffitto.
- Recessed ceiling dehumidifier.
- Déshumidificateur à encastrement pour faux plafond.
- Luftentfeuchter für Deckeneinbau.
- Deshumidificador empotrado para falso techo.

Code	Air flow rate	Price	Class	Packaging
D300	300 m³/h	2.401,25 €	ZD	1
D550	550 m³/h	4.124,50 €	ZD	1
D1000	1100 m³/h	7.627,50 €	ZD	1

■ DEUCL-S



- Deu-climatizzatore da incasso a controsoffitto con batteria integrativa.
- Recessed ceiling dehumidifier/air conditioner with additional battery.
- Déshumidificateur/climatiseur à encastrement pour faux plafond avec batterie supplémentaire.
- Luftentfeuchter/Klimaanlage mit Zusatzwärmetauscher für Deckeneinbau.
- Deshumidificador/aire acondicionado empotrado para falso techo con batería adicional.

Code	Air flow rate	Price	Class	Packaging
DCL300	300 m³/h	3.209,20 €	ZD	1
DCL550	550 m³/h	6.045,50 €	ZD	1
DCL1000	1100 m³/h	10.057,00 €	ZD	1

■ SIL



- Deumidificatore da incasso a controsoffitto senza compressore.
- Recessed ceiling dehumidifier without compressor.
- Déshumidificateur à encastrement sans compresseur pour faux plafond.
- Luftentfeuchter ohne Kompressor für Deckeneinbau.
- Deshumidificador empotrado sin compresor para falso techo.

Code	Air flow rate	Price	Class	Packaging
SIL300	300 m³/h	3.107,50 €	ZD	1

■ SIL-CL



- Deu-climatizzatore da incasso a controsoffitto senza compressore.
- Recessed ceiling dehumidifier/air conditioner without compressor.
- Déshumidificateur/climatiseur à encastrement sans compresseur pour faux plafond.
- Luftentfeuchter/Klimaanlage ohne Kompressor für Deckeneinbau.
- Deshumidificador/aire acondicionado empotrado sin compresor para falso techo.

Code	Air flow rate	Price	Class	Packaging
SIL300CL	300 m³/h	3.808,10 €	ZD	1

■ RDC



- Deumidificatore da incasso a controsoffitto con recuperatore di calore ad alta efficienza.
- Recessed ceiling dehumidifier with high efficiency heat recovery.
- Déshumidificateur à encastrement pour faux plafond avec récupération de chaleur à haut rendement.
- Luftentfeuchter für Deckeneinbau mit Wärmerückgewinnung mit hoher Effizienz.
- Deshumidificador para empotrar en falso techo con recuperador de calor y alta eficiencia.

Code	Total air flow rate	Fresh air flow rate	Price	Class	Packaging
RDC300-150	300 m³/h	150 m³/h	10.057,00 €	ZD	1
RDC380-220	380 m³/h	220 m³/h	13.458,30 €	ZD	1

■ PLEN-D160



- Plenum di mandata per deumidificatori a controsoffitto.
- Plenum chamber for ceiling mounted dehumidifiers.
- Plénum de refoulement pour déshumidificateurs pour faux plafond.
- Ausblasplenum für Luftentfeuchter für Deckeneinbau.
- Plenum de impulsión para deshumidificadores en falso techo.

Code	Ways	Size	Price	Class	Packaging
PLEN3-D160	3	Ø160 mm	276,85 €	ZD	1
PLEN5-D160	5	Ø160 mm	305,10 €	ZD	1

■ DEU-P



- Deumidificatore da incasso a parete.
- Recessed wall dehumidifier.
- Déshumidificateur à encastrement mural.
- In die Wand eingebauter Luftentfeuchter.
- Deshumidificador para empotrar en pared.

Code	Air flow rate	Price	Class	Packaging
D200P	200 m³/h	2.180,90 €	ZD	1
D300P	300 m³/h	2.486,00 €	ZD	1

■ DEUCL-P



- Deu-climatizzatore da incasso a parete con batteria integrativa.
- Recessed wall dehumidifier/air conditioner with additional battery.
- Déshumidificateur/climatiseur à encastrement mural avec batterie supplémentaire.
- In die Wand eingebauter Luftentfeuchter/Klimaanlage mit Zusatzwärmetauscher.
- Deshumidificador/aire acondicionado para empotrar en pared con batería adicional.

Code	Air flow rate	Price	Class	Packaging
DCL300P	300 m³/h	3.412,60 €	ZD	1

■ CASS 00 P



- Controcassa per deumidificatore da incasso a parete.
- Casing for recessed wall dehumidifier.
- Caisson pour déshumidificateur à encastrement mural.
- Gehäuse für in die Wand eingebauter Luftentfeuchter.
- Caja para deshumidificador para empotrar en pared.

Code	Module	Price	Class	Packaging
CASS200P	D200P	327,70 €	ZD	1
CASS300P	D300P - DCL300P	363,86 €	ZD	1

■ GRF 00 P



- Griglia frontale per deumidificatore da incasso a parete.
- Front grill for recessed wall dehumidifier.
- Grille frontale pour déshumidificateur à encastrement mural.
- Frontgitter für in die Wand eingebauter Luftentfeuchter.
- Rejilla frontal para deshumidificador para empotrar en pared.

Code	Module	Suitable Cabinet	Price	Class	Packaging
GRF200P	D200P	CASS200P	395,50 €	ZD	1
GRF300P	D300P - DCL300P	CASS300P	519,80 €	ZD	1

■ MOB 00 P



- Mobile esterno a parete per deumidificatore.
- External wall furniture for dehumidifier.
- Meuble extérieur mural pour déshumidificateur.
- Außenwandschrank für Luftentfeuchter.
- Mueble externo de pared para deshumidificador.

Code	Module	Price	Class	Packaging
MOB300P	D300P - DCL300P	1.638,50 €	ZD	1

THERMAL POWER STATION

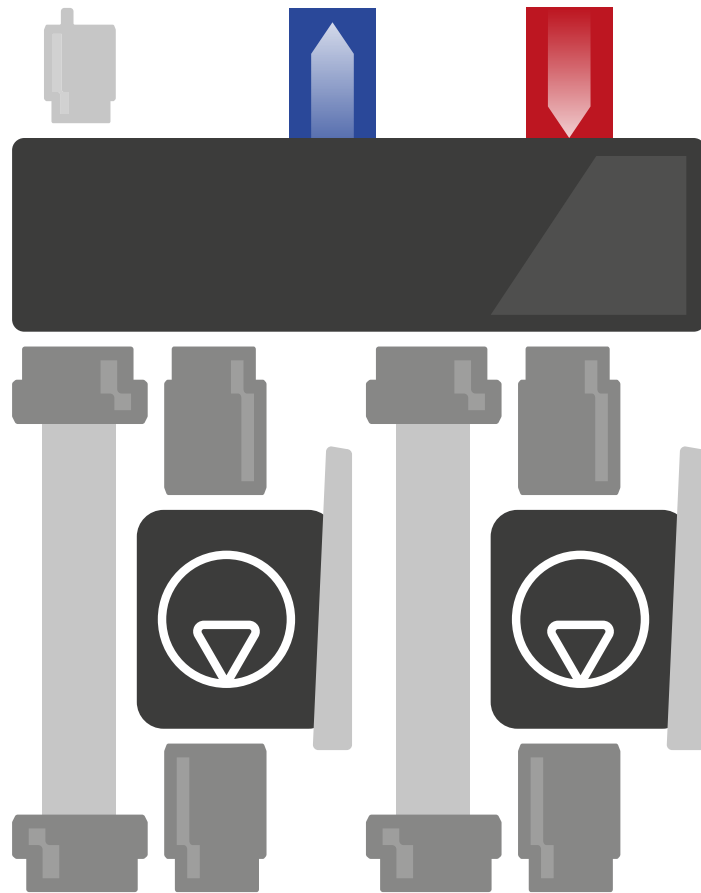

pim.ivar-group.com/short/IT-05

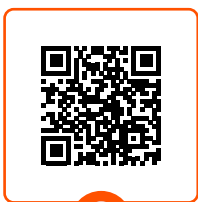

DOWNLOAD



pim.ivar-group.com/short/FR-05



DOWNLOAD



pim.ivar-group.com/short/DE-05

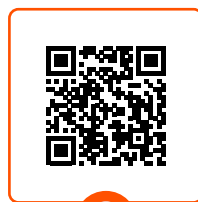

DOWNLOAD





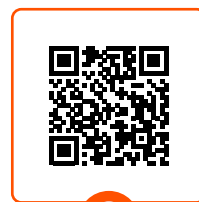







pim.ivar-group.com/short/ES-05



DOWNLOAD



	<p>DIRTSTOP® - Defangatore magnetico con filtro <i>DIRTSTOP® - Magnetic dirt separator with strainer</i> DIRTSTOP® - Pot à boue magnétique avec filtre <i>DIRTSTOP® - Magnetischer Schlammabscheider mit Filter</i> DIRTSTOP® - Desfangador magnético con filtro</p>	290
	<p>DIRTSTOP® XL - Defangatore magnetico a triplice azione filtrante <i>DIRTSTOP® XL - Magnetic dirt separator with triple filtering action</i> DIRTSTOP® XL - Pot à boue magnétique à triple action de filtrage <i>DIRTSTOP® XL - Magnetischer Schlammabscheider mit dreifach wirkender Filtration</i> DIRTSTOP® XL - Desfangador magnético con filtración de triple acción</p>	294
	<p>POLIFEMO® - Dosatore di polifosfati e silicati <i>POLIFEMO® - Polyphosphates and silicates doser</i> POLIFEMO® - Distributeur de polyphosphates et de silicates <i>POLIFEMO® - Polyphosphaten- und Silikatenspender</i> POLIFEMO® - Dispensador de polifosfatos y silicatos</p>	296
	<p>BRIX - Neutralizzatore di condensa acida <i>BRIX - Acid condensate neutralizer</i> BRIX - Neutralisant de condensat acide <i>BRIX - Säurekondensat-Neutralisator</i> BRIX - Neutralizador de condensados ácidos</p>	300
	<p>MULTIMIX - Sistema compatto di distribuzione sottocaldaia <i>MULTIMIX - Compact boiler distribution system</i> MULTIMIX - Système compact de distribution sous-chaudière <i>MULTIMIX - Kompakt-Verteilersystem Kesselunterbau</i> MULTIMIX - Sistema compacto de distribución bajo caldera</p>	302
	<p>MULTIMIX•C - Sistema compatto di distribuzione sottocaldaia <i>MULTIMIX•C - Compact boiler distribution system</i> MULTIMIX•C - Système compact de distribution sous-chaudière <i>MULTIMIX•C - Kompakt-Verteilersystem Kesselunterbau</i> MULTIMIX•C - Sistema compacto de distribución bajo caldera</p>	310
	<p>Accessori per sistemi compatti di distribuzione sottocaldaia MULTIMIX - MULTIMIX•C <i>Accessories for compact boiler distribution systems MULTIMIX - MULTIMIX•C</i> Accessories for compact boiler distribution systems MULTIMIX - MULTIMIX•C <i>Accessories for compact boiler distribution systems MULTIMIX - MULTIMIX•C</i> Accessories for compact boiler distribution systems MULTIMIX - MULTIMIX•C</p>	315
	<p>VARIMIX - Sistema modulare per centrali termiche <i>VARIMIX - Modular system for thermal power stations</i> VARIMIX - Système modulaire pour centrales thermiques <i>VARIMIX - Modulares System für Heizungsanlagen</i> VARIMIX - Sistema modular para centrales térmicas</p>	318
	<p>Accumulatori <i>Storage tanks</i> Réservoirs d'accumulation <i>Speicher</i> Acumuladores</p>	325
	<p>Valvole miscelatrici assiali termostattizzabili per elevate portate <i>Thermostatic axial mixing valves for high flow capacity</i> Vannes mélangeuses axiales thermostatisables pour débit élevé <i>Axiale Thermostat-Mischventile für erhöhte Durchfluss</i> Válvulas mezcladoras axiales termostaticables para caudales elevados</p>	332



Valvole miscelatrici assiali termostattizzabili
Thermostatic axial mixing valves
Vannes mélangeuses axiales thermostatisables
Axiale Thermostat-Mischventile
Válvulas mezcladoras axiales termostaticables

333



Valvole miscelatrici a settore
Rotor mixing valves
Vannes mélangeuses à rotor
Rotor-Mischventile
Válvulas mezcladoras de rotor

334



Valvole di sicurezza
Safety valves
Clapets de sécurité
Sicherheitsventile
Válvulas de seguridad

337



Gruppi di alimentazione automatici
Automatic filling groups
Groupes d'alimentation automatiques
Hauswasserstationen
Grupos de alimentación automáticos

338



Valvole di bypass differenziale
Bypass differential valves
Vannes de by-pass différentielles
Differenziale Bypass-Ventile
Válvulas de bypass diferenciales

339



DIRTSTOP®

DirtSTOP®, is a magnetic dirt separator with double-action strainer, which thanks to its patented swivelling insert, guarantees maximum efficiency in all four installation positions.

The metal parts of the heating system are subject to corrosion effects, which release ferrous impurities into the water. Other impurities may also be present, for example due to limescale. These impurities tend to accumulate in the system parts with reduced transit sections, causing obstructions, noise or other malfunctions.

DirtSTOP® keeps the heating system in the best possible condition, while periodic cleaning of the strainer is simple and quick, without the need to drain the system.

Materials:

Body: technopolymer IXEF®
Connection kit: brass CW617N
Strainer mesh: stainless steel AISI 304
Sealing elements: peroxide EPDM

Technical specifications:

Temperature: 0 - 90 °C
Pmax: 3 bar
Neodymium magnet (B = 1.2 T = 12,000 G)
Kv for insert in position A:
6.2 straight configuration;
5.6 angle configuration.
Kv for insert in position B:
5.7 straight configuration;
5.5 angle configuration
Max. flow rate: 1.46 m³/h.
Compatible with water or glycol solution (max. 50%).
Connections: 3/4" M x 3/4" F
Filter mesh: 800 µm

⊕ PLUS



- 1 ULTRA COMPACT:**
for easy installation
even in confined spaces.
- 2 Four different INSTALLATION POSITIONS**
(see fig. 1).
- 3 BODY IN IXEF TECHNOPOLYMER®:**
extraordinary mechanical properties,
comparable to brass.
Corrosion-resistant.
- 4 SWIVELLING INSERT (Patent Pending):**
maximum efficiency in any installation
position.
- 5 Internal STRAINER with 800 µm mesh.**
- 6 LARGE SETTLING CHAMBER, WITH 360° SWIVEL FITTING:** conveys waste to the drain valve.
- 7 SHUTOFF DRAIN VALVE:**
enables easy and quick cleaning
also with the system running (see fig. 2).
- 8 POWERFUL MAGNET WITH VERTICAL POLARISATION** to generate a much more uniform magnetic field, thus optimising capture of all impurities.



Fig. 1

A Swivel insert in POSITION A (factory position)

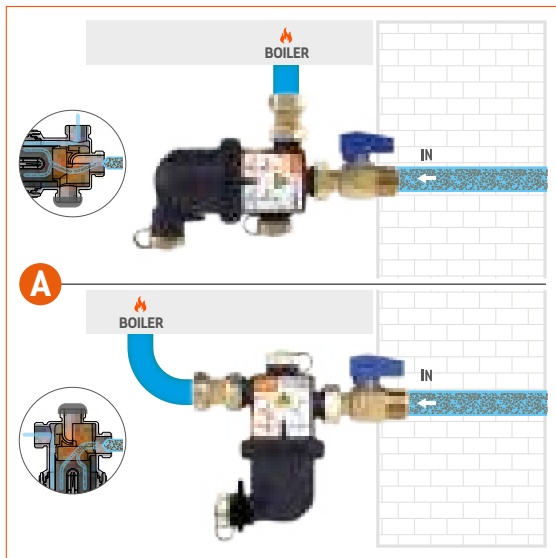

Swivel insert in POSITION B (rotated 180°)

B

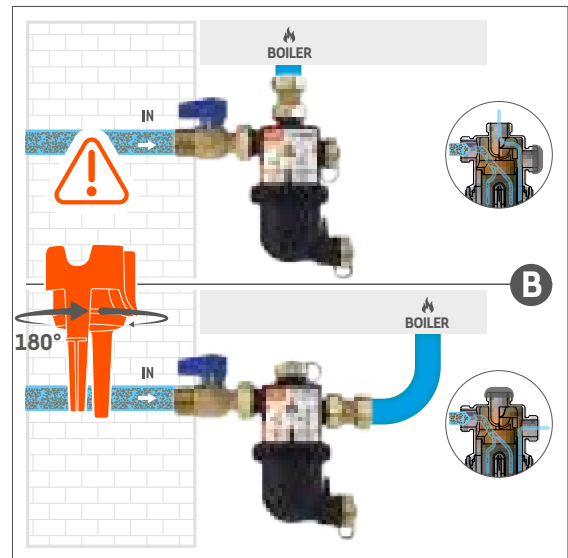
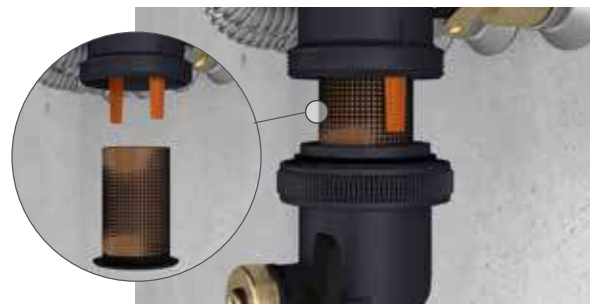

Fig. 2

ROUTINE CLEANING to remove waste and sludge that accumulates at the bottom of the settling chamber, via the integrated drain valve.



SPECIAL CLEANING via the strainer mesh and lower casing, to be carried out at least once a year.



DIRTSTOP®



- Defangatore magnetico orientabile compatto con filtro interno completo di valvola di intercettazione a sfera dritta, raccordo girevole e raccordo portagomma.
- Compact swiveling magnetic dirt separator with strainer complete with straight isolation ball valve, swiveling fitting and tap connector.
- Pot à boue magnétique orientable compact avec filtre interne complet de vanne d'interception à bille droite, raccord pivotant et nez de robinet.
- Kompakter drehbarer magnetischer Schlammabscheider mit internem Filter komplett mit Durchgangs-Absperrkugelventil, drehbarer Verbinder und Hahnverbinder.
- Desfangador magnético compacto orientable con filtro interno completo de válvula de cierre de bola recta, conector giratorio y conector de grifo.

Code	Size	Color	Price	Class	Packaging
520049	3/4" F x 3/4" M	■	125,30 €	TI	1 / 12
520049W	3/4" F x 3/4" M	□	125,30 €	TI	1 / 12

DSK 01



- Defangatore magnetico orientabile compatto con filtro interno completo di valvola di intercettazione a sfera dritta, raccordo girevole, raccordo portagomma, additivi IV 400 e IV 100 HT/LT (confezioni da 1 l).
- Compact swiveling magnetic dirt separator with strainer complete with straight isolation ball valve, swiveling fitting, tap connector, IV 400 and IV 100 HT/LT additives (1 l packs).
- Pot à boue magnétique orientable compact avec filtre interne complet de vanne d'interception à bille droite, raccord pivotant, nez de robinet, additifs IV 400 et IV 100 HT/LT (paquets de 1 l).
- Kompakter drehbarer magnetischer Schlammabscheider mit internem Filter komplett mit Durchgangs-Absperrkugelventil, drehbarer Verbinder, Hahnverbinder, IV 400 und IV 100 HT/LT Zusatzstoffe (Ein-Liter-Packungen).
- Desfangador magnético compacto orientable con filtro interno completo de válvula de cierre de bola recta, conector giratorio, conector de grifo, aditivos IV 400 y IV 100 HT/LT (paquetes de 1 l).

Code	Size	IV 400	IV 100 HT	IV 100 LT	Color	Price	Class	Packaging
520050HT	3/4" F x 3/4" M	✓	✓	-	■	220,35 €	TI	5
520050LT	3/4" F x 3/4" M	✓	-	✓	■	225,20 €	TI	5
520050WHT	3/4" F x 3/4" M	✓	✓	-	□	220,35 €	TI	5
520050WLT	3/4" F x 3/4" M	✓	-	✓	□	225,20 €	TI	5

ACV 01



- Accessorio per l'installazione di DIRTSTOP® su caldaie con attacchi orizzontali (compatibile con caldaie Vaillant EcoTEC pro, EcoTEC plus, EcoTEC exclusive).
- Accessory for DIRTSTOP® installation on boilers with horizontal connections (compatible with Vaillant boilers EcoTEC pro, EcoTEC plus, EcoTEC exclusive).
- Accessoire pour l'installation de DIRTSTOP® sur chaudières avec connexions horizontales (compatible avec les chaudières Vaillant EcoTEC pro, EcoTEC plus, EcoTEC exclusive).
- Zubehör zur Installation von DirtSTOP® an Kesseln mit horizontale Verbindungen (kompatibel mit Vaillant-Kessel EcoTEC pro, EcoTEC plus, EcoTEC exclusive).
- Accesorio para instalar DirtSTOP® en calderas con conexiones horizontales (compatible con calderas Vaillant EcoTEC pro, EcoTEC plus, EcoTEC exclusive).

Code	Size	Price	Class	Packaging
520126	3/4" Ø18/1 x 45 mm	14,74 €	JC	10

AC 627



- Bocchettone ridotto girevole a tenuta morbida.
- Reduced soft seal fitting.
- Embout à étanchéité souple réduite.
- Reduziert Selbstdichtendstützen.
- Manguito de unión reducido con junta blanda.

Code	Size	Color	Price	Class	Packaging
550551	3/4" F x 1"1/4 F	■	15,21 €	NJ	10 / 80
550551N	3/4" F x 1"1/4 F	■	15,70 €	NJ	10 / 80

IV 100 HT

- **Additivo inibitore antiincrostante per impianti ad alta temperatura.**
- *Anti-scaling inhibitor additive for high temperature systems.*
- **Additif inhibiteur anti-incrustant pour les systèmes à haute température.**
- *Anti-Kesselstein-Hemmender Zusatzstoff für Hochtemperatursysteme.*
- **Additivo antiincrustante inibidor para sistemas de alta temperatura.**

Code	Size	Price	Class	Packaging
IV100HT	1 l	42,80 €/l	TI	1 l
IV100HT-10	10 kg	35,00 €/Kg	TI	10 Kg

IV 100 LT

- **Additivo inibitore antiincrostante per impianti a bassa temperatura.**
- *Anti-scaling inhibitor additive for low temperature systems.*
- **Additif inhibiteur anti-incrustant pour les systèmes à basse température.**
- *Anti-Kesselstein-Hemmender Zusatzstoff für Niedertemperatursysteme.*
- **Additivo antiincrustante inibidor para sistemas de baja temperatura.**

Code	Size	Price	Class	Packaging
IV100LT	1 l	47,50 €/l	TI	1 l
IV100LT-10	10 kg	40,00 €/Kg	TI	10 Kg

IV 400

- **Additivo risanante.**
- *Sanitizing additive.*
- **Additif désembouant.**
- *Schlammferner.*
- **Additivo restaurativo.**

Code	Size	Price	Class	Packaging
IV400	1 l	52,40 €/l	TI	1 l
IV400-10	10 kg	44,60 €/Kg	TI	10 Kg



DIRTSTOP® XL

DirtSTOP® XL is the new high-performance magnetic dirt separator from IVAR, with **triple strainer action**:

1. swirling motion to help waste settling
2. powerful magnet (14000 gauss)
3. strainer cartridge to separate the smaller particles.

The special patented inner insert guides the flow into a vortex, to facilitate separation of the waste by cyclonic action, before magnetic and mechanical straining.

The compact dimensions and swivel fitting make this product ideal for installation in any system configuration. The device is fitted with a manual air bleed valve and drain valve, with large collection chamber to reduce the frequency of bleeding.

Materials:

Body, cyclonic insert, locking ring nut, Tee fitting: PA66 + FV 30%
 Strainer cartridge: AISI 304 stainless steel
 Sealing elements: peroxide EPDM

Technical specifications:

Neodymium magnet (14,000 G)
 Temperature: 0 - 90 °C
 Kv: 6.7
 Max. flow rate: 2.13 m³/h*
 Pmax: 3 bar
 Compatible with water or glycol solution (max. 50%).
 Connections: Ø22 copper pipe; 3/4" F; 1" F; 1"1/4 F
 Initial cleaning strainer mesh: 500 µm
 Standard strainer mesh: 800 µm

*check compatibility of flow rate with other system components

PROVISION for AIR BLEEDING using the dedicated bleed valve.

WIDE RANGE OF CONNECTIONS AVAILABLE.

MAGNETIC AND MECHANICAL FILTRATION of system impurities.

TRIPLE ACTION

- 1** The patented insert creates a **VORTEX** in the moving water. Separate settling chamber to encourage settling of waste.
 - Swirling movement (vortex)
- 2** **HIGH-POWER MAGNET** (14,000 Gauss) provides improved retention of metallic impurities.
 - Powerful magnet
- 3** **STEEL FILTER MESH: 500 µm** first-pass filter, **800 µm** maintenance filter.
 - Filter cartridge

8 possible pipework installation POSITIONS, horizontal, vertical and oblique.

DOSING of FLUIDS to clean the system using additives.

Ideal for residential **HEAT PUMPS.**

DIRTSTOP® XL

- Defangatore magnetico orientabile a triplice azione filtrante completo di valvole di intercettazione a sfera dritte e chiave per montaggio/smontaggio.
- Swiveling magnetic dirt separator with triple filtering action complete with straight isolation ball valves and key for installation/removal.
- Pot à boue magnétique orientable à triple action de filtrage complet de vannes d'interception à bille droites et clé pour montage/démontage.
- Drehbarer magnetischer Schlammabscheider mit dreifach wirkender Filtration komplett mit Durchgangs-Absperrkugelventile und Schlüssel für Montage und Demontage.
- Desfangador magnético orientable con filtración de triple acción completo de válvulas de cierre de bola rectas y llave para montaje/desmontaje.

Code	Size	Color	Price	Class	Packaging
520124	Ø22 x Ø22 Copper pipe	■	234,30 €	TI	1 / 5
520135	3/4" F x 3/4" F	■	222,00 €	TI	1 / 5
520136	1" F x 1" F	■	234,50 €	TI	1 / 5
520139	1"1/4 F x 1"1/4 F	■	246,80 €	TI	1 / 5

DIRTSTOP® XL P

- Defangatore magnetico orientabile a triplice azione filtrante completo di chiave per montaggio/smontaggio.
- Swiveling magnetic dirt separator with triple filtering action complete with key for installation/removal.
- Pot à boue magnétique orientable à triple action de filtrage complet de clé pour montage/démontage.
- Drehbarer magnetischer Schlammabscheider mit dreifach wirkender Filtration komplett mit Schlüssel für Montage und Demontage.
- Desfangador magnético orientable con filtración de triple acción completo de llave para montaje/desmontaje.

Code	Size	Color	Price	Class	Packaging
520153	1" M x 1" M	■	207,60 €	TI	1 / 5

AC 655 G

- Coppia di valvole a sfera diritte femmina-femmina complete di dado girevole, manovra a farfalla.
- Pair of female-female straight ball valves with swivelling nut, butterfly operation.
- Set de vannes à bille droites femelle-femelle avec écrou rotatif, manoeuvre à papillon.
- Paar Durchgangs-Kugelventil IG-IG mit drehbarer Mutter und Flügelgriff.
- Conjunto de válvulas de bola rectas hembra-hembra completas de manguito de tuerca giratoria, vuelta a mariposa.

Code	Size	Price	Class	Packaging
520194	1" F swivel x Ø22 copper pipe	52,10 €	TI	1 / 24
520195	1" F swivel x 3/4" F	39,30 €	TI	1 / 24
520196	1" F swivel x 1" F	52,10 €	TI	1 / 24
520197	1" F swivel x 1"1/4 F	64,60 €	TI	1 / 24

DIRTSTOP® XL B

- Defangatore magnetico orientabile a triplice azione filtrante completo di raccordo a T in ottone e chiave per montaggio/smontaggio.
- Swiveling magnetic dirt separator with triple filtering action complete with brass Tee fitting and key for installation/removal.
- Pot à boue magnétique orientable à triple action de filtrage complet de raccord à T en laiton et clé pour montage/démontage.
- Drehbarer magnetischer Schlammabscheider mit dreifach wirkender Filtration komplett mit T-Stück aus Messing und Schlüssel für Montage und Demontage.
- Desfangador magnético orientable con filtración de triple acción completo de racor en Te de latón y llave para montaje/desmontaje.

Code	Size	Color	Price	Class	Packaging
520154	1" F x 1" F	■	208,90 €	TI	1 / 5



• IV 400 >> p. 282,293



• IV 100 HT >> p. 293



• IV 100 LT >> p. 282,293

POLIFEMO®

Proportional polyphosphate doser has to be installed on the pipes which supply water to the boiler (and other appliances such as washing machines and dishwashers) to reduce the presence of limestone. The polyphosphates released by the doser create a protection film in the pipes, useful to avoid the corrosion caused by limestone.

Polifemo is now even more practical and functional. The new and more compact design, combined with a new dosing system, ensures easy maintenance and a much higher available flow rate.

3 in 1

PROTECTS from LIMESTONE
PROTECTS from CORROSION
FILTERS the impurities



INTEGRATED FILTER

Integrated filter with 500 µm filtering mesh in compliance with **UNI 8065 standard**.



PROPORTIONAL DOSAGE

Venturi effect

RELEASE OF POLYPHOSPHATES AND SILICATES guaranteed in all installation positions

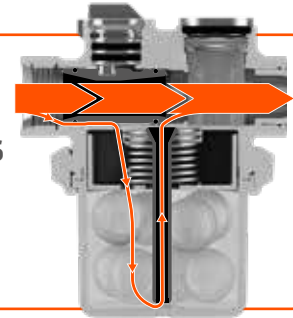

BYPASS

POLIFEMO allows to recharge the balls when the system is working, thanks to the **PATENTED BYPASS SYSTEM**.

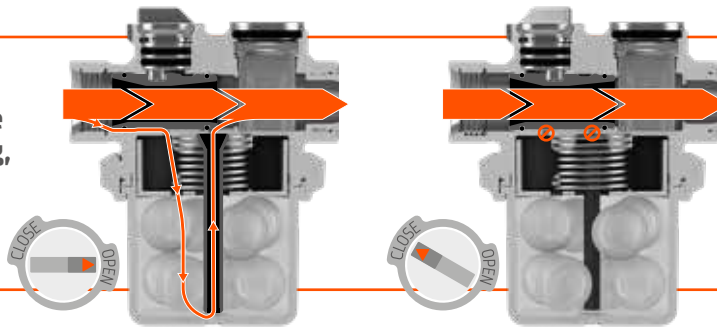

⊕ PLUS

- **LIMESCALE ACTION:** phosphate dosage prevents precipitation of calcium and magnesium carbonates
- **PROTECTIVE ACTION AGAINST CORROSION** thanks to silicate dosage
- **FILTERING ACTION** by 500 µm mesh, compliant with UNI 8065 standard
- **Level indicator** with transparent glass for easy inspection  **FOCUS 1**
- **ROBUSTNESS AND RELIABILITY:** brass cap that ensures maximum resistance to water hammer
- **HORIZONTAL OR VERTICAL INSTALLATION** with accurate display of the charge level in all positions.
- **HIGH FLOW RATE** and **LOW PRESSURE LOSS** thanks to the new dosing principle with Venturi effect and to the two versions (1/2" and 1")
- **EASY REFILL** thanks to the air vent, which makes disassembly of the ring nut more simple.
- **SUPER COMPACT**, it fits into any system.
- **NEW VERSION WITH EXTRALARGE GLASS** with more spheres, in order to recharge Polifemo only once a year.

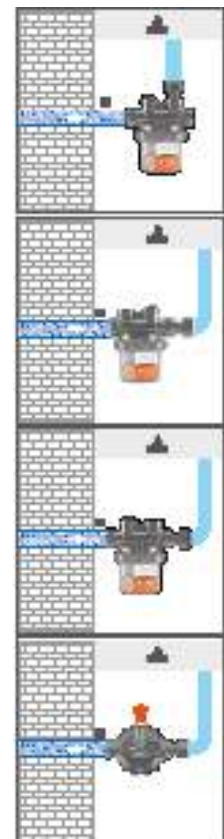

FOCUS 01

MIND THE POLIFEMO'S EYE.
Refill with new spheres
when it becomes **BLACK**.

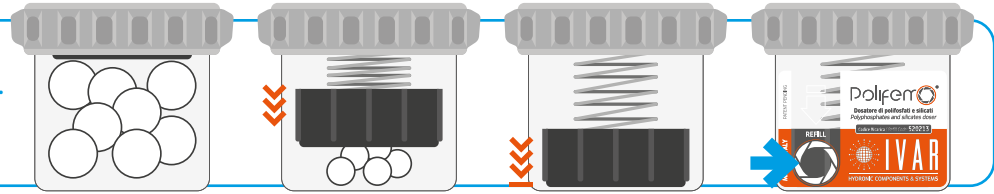
POLIFEMO®

- **Dosatore proporzionale di polifosfati e silicati in sfere completo di filtro, sistema di bypass integrato e kit di connessione.**
- *Proportional doser of polyphosphate and silicates in balls complete with strainer, integrated bypass system and connection kit.*
- **Distributeur proportionnel de polyphosphates et de silicates en sphères avec filtre, système de bypass intégré et kit de connexion.**
- *Proportional-Spender für Polyphosphate und Silikate in Kugeln komplett mit Filter, integriertem Bypass-System und Anschluss-Kit.*
- **Dispensador proporcional para polifosfatos y silicatos en esferas con filtro, sistema de bypass integrado y kit de conexión.**

Code	Size	Price	Class	Packaging
520210	1/2" - 8 balls	131,00 €	TI	1 / 12

POLIFEMO® EXTRA

- **Dosatore proporzionale di polifosfati e silicati in sfere completo di filtro, sistema di bypass integrato e kit di connessione.**
- *Proportional doser of polyphosphate and silicates in balls complete with strainer, integrated bypass system and connection kit.*
- **Distributeur proportionnel de polyphosphates et de silicates en sphères avec filtre, système de bypass intégré et kit de connexion.**
- *Proportional-Spender für Polyphosphate und Silikate in Kugeln komplett mit Filter, integriertem Bypass-System und Anschluss-Kit.*
- **Dispensador proporcional para polifosfatos y silicatos en esferas con filtro, sistema de bypass integrado y kit de conexión.**

Code	Size	Price	Class	Packaging
520211	1/2" - 16 balls	153,50 €	TI	1 / 12

POLIFEMO® 1"

- **Dosatore proporzionale di polifosfati e silicati in sfere completo di filtro, sistema di bypass integrato e kit di connessione.**
- *Proportional doser of polyphosphate and silicates in balls complete with strainer, integrated bypass system and connection kit.*
- **Distributeur proportionnel de polyphosphates et de silicates en sphères avec filtre, système de bypass intégré et kit de connexion.**
- *Proportional-Spender für Polyphosphate und Silikate in Kugeln komplett mit Filter, integriertem Bypass-System und Anschluss-Kit.*
- **Dispensador proporcional para polifosfatos y silicatos en esferas con filtro, sistema de bypass integrado y kit de conexión.**

Code	Size	Price	Class	Packaging
520212	1" - 16 balls	220,00 €	TI	1 / 12

APF 03

- **Polifosfati e silicati in sfere per ricarica dosatori serie POLIFEMO® con filtro di ricambio.**
- *Polyphosphate and silicates in balls for refilling POLIFEMO® series dosers with spare strainer.*
- **Polyphosphates et silicates en sphères pour le remplissage des distributeurs de la série POLIFEMO® avec filtre de rechange.**
- *Polyphosphate und Silikate in Kugelform zum Nachfüllen von Spendern der Serie POLIFEMO® mit Ersatzfilter.*
- **Polifosfatos y silicatos en esferas para recarga de dispensadores de la serie POLIFEMO® con filtro de repuesto.**

Code	Size	Model	Price	Class	Packaging
520213	8 balls	POLIFEMO® - POLIFEMO® EXTRA (x 2)	17,50 €	TI	8 / 32
520218	16 balls	POLIFEMO® 1"	29,00 €	TI	8 / 32

■ POLIFEMO® PLUS



- Dosatore di polifosfati e silicati con bypass, completo di kit di connessione e chiave per montaggio/smontaggio cartuccia.
- Polyphosphate and silicates doser with bypass, complete with connection kit and wrench for cartridge installation/removal.
- Distributeur de polyphosphates et de silicates avec bypass, complet avec kit de connexion et clé pour montage/démontage de la cartouche.
- Polyphosphaten- und Silikatenspender mit Bypass, komplett mit Anschluß-Set und Schlüssel für Montage und Demontage des Einsatz.
- Dispensador de polifosfatos y silicatos con bypass, kit de conexión y llave para montaje/desmontaje del cartucho.

Code	Size	Price	Class	Packaging
520151	DN 15	132,30 €	TI	8

■ APF 01

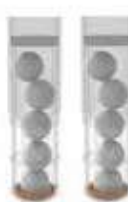

- Coppia di cartucce di ricambio complete di filtro e polifosfati. Compatibile solo con POLIFEMO® PLUS (codice 520151).
- Pair of spare cartridges complete with strainer and polyphosphate. Compatible only with POLIFEMO® PLUS (code 520151).
- Paire de cartouches de rechange avec filtre et polyphosphate. Compatible uniquement avec POLIFEMO® PLUS (code 520151).
- Ersatzzeinsatzpaar komplett mit Filter und Polyphosphat. Kompatibel nur mit POLIFEMO® PLUS (Code 520151).
- Par de cartuchos de repuesto con filtro, completos de polifosfato. Compatible solo con POLIFEMO® PLUS (código 520151).

Code	Price	Class	Packaging
520152	36,20 €	TI	8 / 32

■ APF 02



- Chiave di ricambio per montaggio/smontaggio cartuccia. Compatibile solo con POLIFEMO® PLUS (codice 520151).
- Spare wrench for cartridge installation/removal. Compatible only with POLIFEMO® PLUS (code 520151).
- Clé de rechange pour montage/démontage de la cartouche. Compatible uniquement avec POLIFEMO® PLUS (code 520151).
- Ersatzschlüssel für Montage und Demontage des Einsatz. Kompatibel nur mit POLIFEMO® PLUS (Code 520151).
- Llave de repuesto para montaje/desmontaje del cartucho. Compatible solo con POLIFEMO® PLUS (código 520151).

Code	Size	Price	Class	Packaging
CH0002	2"	6,50 €	TI	1





BRIX is an acid condensate neutralizer to be installed downstream of the condensate drain of condensing boilers. In fact, condensing boilers can recover heat by condensing the combustion gases before they are expelled. The resulting condensate, however, has a very low (acid) pH because of the carbon dioxide produced during combustion thus is very corrosive and potentially dangerous for the domestic sewage network. Thanks to the presence of BRIX, the acid condensate from the boiler passes through the calcium carbonate (CaCO_3) charge which neutralizes it. The condensate pH rises ($\text{pH} > 6$), thus allowing to discharge the fluid safely.

Materials:

Transparent capsule: Nylon 12
 Threaded body: PA 66
 Gasket: peroxide EPDM
 Neutralizing charge container: stainless steel AISI 304
 Neutralizing agent: Calcium carbonate (CaCO_3)

Technical specifications:

Operating temperature: $5 \div 50$ °C
 Compatible fluids: Water / Acid condensate
 Connections: 3/4" x $\varnothing 16$ / $\varnothing 20$, straight/elbow, switchable

Components:

- A. Body with threaded connections.
- B. Transparent capsule.
- C. Neutralizing charge container.
- D. Straight hose connection.
- E. Elbow hose connection.
- F. Gasket.
- G. Clamp.
- H. Screw anchor.
- I. Neutralizing agent calcium carbonate (CaCO_3).

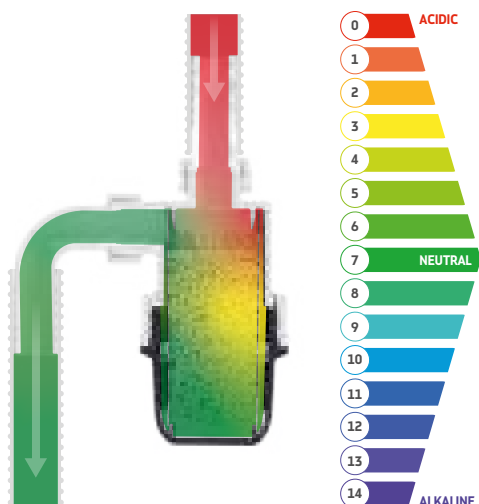
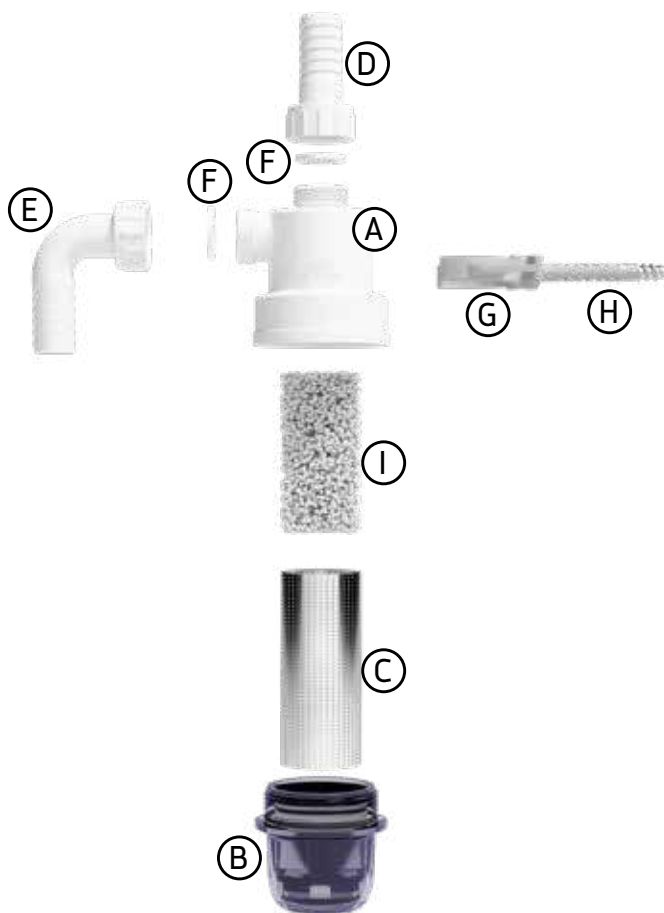

⊕ PLUS

- **Neutralizing action to prevent corrosion from acid condensation.**
- **Quick and easy maintenance thanks to the stainless-steel neutralizer charge container which facilitates the refilling and replacement of the neutralizing charge.**
- **Reversible connections to easily adapt to different installation positions.**
- **Extremely compact to easily find a place under the boiler.**
- **Transparent body to always keep the neutralizing charge level under control.**

BRIX

- **Neutralizzatore di condensa acida completo di kit di connessione e due confezioni di carbonato di calcio (una confezione omaggio).**
- **Acid condensate neutralizer complete with connection kit and two packs of calcium carbonate (one pack free).**
- **Neutralisant de condensat acide complet avec kit de connexion et deux paquets de carbonate de calcium (un paquet gratuit).**
- **Säurekondensat-Neutralisator komplett mit Anschluß-Set und zwei Packungen Calciumcarbonat (eine freie Packung).**
- **Neutralizador de condensados ácidos con kit de conexión y dos paquetes de carbonato de calcio (un paquete gratis).**

Code	Size	Price	Class	Packaging
520200	3/4" x Ø16	87,20 €	TI	6
520201	3/4" x Ø20	87,20 €	TI	6

ABX 01

- **Kit composto da 6 confezioni di carbonato di calcio per neutralizzatore di condensa acida .**
- **Kit with 6 packs of calcium carbonate for acid condensate neutralizer.**
- **Kit avec 6 packs de carbonate de calcium pour neutralisant de condensat acide.**
- **Kit mit 6 Packungen von Calciumcarbonat für Säurekondensat-Neutralisator.**
- **Kit con 6 paquetes de carbonato de calcio para neutralizador de condensados ácidos.**

Code	Size	Price	Class	Packaging
520203	6 x 130 g	25,20 €	TI	1

MULTIMIX

The MULTIMIX system is a substation for mixing and boosting, which enables the transfer of fluids at different temperatures to each thermal zone via a distribution kit, made independent by the pressure equaliser incorporated in the main manifold. The extraordinarily compact size facilitates installation below the boiler and in confined spaces.

MULTIMIX is made up of the manifold/separator and direct kits, or versions with mixer, which can be configured and combined to meet specific requirements. Pre-assembled configurations are also available with insulation casing in polypropylene (metal recessed cabinet is supplied separately).

MULTIMIX can also be supplied via side connections, and enables the connection of two or more manifolds to one another. Unlike MULTIMIX-C, this system enables the temporary or permanent disablement of the hydraulic separation function, useful in cases such as connection to an inertial storage unit.

Max. primary flow rate: 3000 l/h

Max. flow rate per kit: 1700 l/h

⊕ PLUS

- Compact, modular and expandable
- Integrated hydraulic separator in main manifold
- Possibility of supply from top to bottom, right/left
- Pre-assembled configurations available
- Suitable for heating and cooling

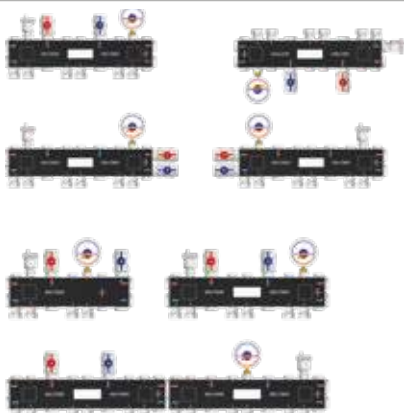

MANIFOLD/SEPARATOR

- Three functions:
 - Flow manifold
 - Return manifold
 - Hydraulic separator (with shutoff provision)
- Connections to primary from right, left, top or bottom
- Connections for multiple heat generators simultaneously
- Two or three zones, expandable with additional module via side connection



DISTRIBUTION AND MIXING KIT

- Three-way piston mixing valve and secondary bypass
- Option of fixed point or climate control
- Pump with shutoff provision and simplified installation thanks to telescopic connection
- Safety thermostat, thermometers, non-return valve



DIRECT DISTRIBUTION KIT

- Pump with shutoff provision and simplified installation thanks to telescopic connection
- Thermometers, non-return valve

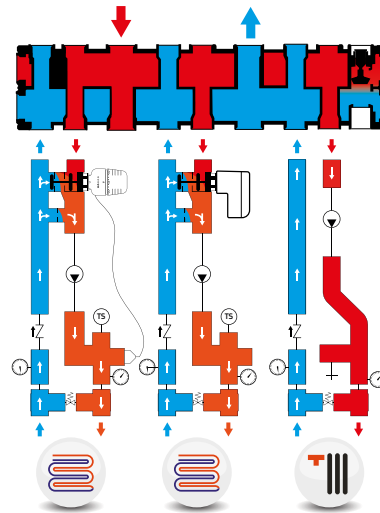

FOCUS: hydraulic separation

- The manifold incorporates the hydraulic separation, an essential function in systems with multiple pumps that can operate simultaneously.
- The hydraulic separator can also be shut off while the system is running by means of an externally controlled shutter.
- The separator creates a hydraulic short circuit, which makes all circulation pumps installed on the secondary and primary circuits completely independent from one another.

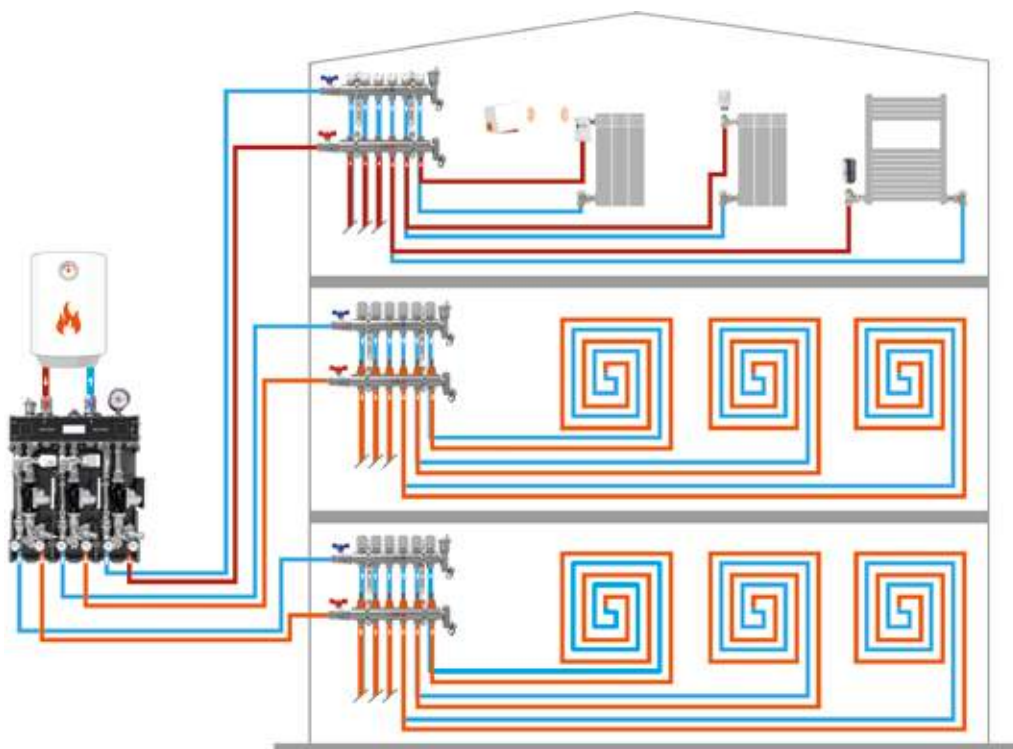
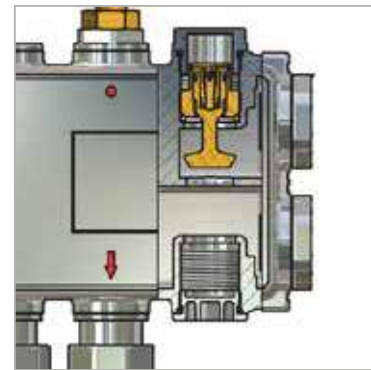

MUL 2HE



ErP

- Modulo di distribuzione MULTIMIX per impianti termici a zone. Versione con collettore/separatore a 2 zone di distribuzione, entrambe di distribuzione diretta in alta temperatura. Unità di distribuzione complete di pompa elettronica a velocità variabile.
- MULTIMIX distribution module for zone thermal plants. Version with 2 distribution zones manifold/separator, both with direct distribution in high temperature. Distribution units complete of variable speed electronic pump.
- Module de distribution MULTIMIX pour installations thermiques à zones. Version avec collecteur/séparateur à 2 zones de distribution, toutes les deux avec distribution directe en haute température. Unités de distribution équipées de pompe électronique à vitesse variable.
- Verteilermodul MULTIMIX für Zonen-Heizungsanlagen. Ausführung mit Verteiler/Abscheider mit 2 Verteilungszonen, beide mit direkter Heißwasserverteilung. Verteileraggregate mit elektronischer Pumpe mit variabler Geschwindigkeit.
- Módulo de distribución MULTIMIX para centrales térmicas de zonas. Versión con colector/separador de 2 zonas de distribución, ambos con distribución directa en alta temperatura. Unidades de distribución completas de bomba electrónica de velocidad variable.

Code	Insulation	Pump	Size	Price	Class	Packaging
506290PEI	✓	WIL04F	2 High T. modules	2.219,26 €	NI	1



• 200089 >> p. 204,316,396,503

MUL 3HE



ErP

- Modulo di distribuzione MULTIMIX per impianti termici a zone. Versione con collettore/separatore a 3 zone di distribuzione, tutte di distribuzione diretta in alta temperatura con distribuzione diretta. Unità di distribuzione complete di pompa elettronica a velocità variabile.
- MULTIMIX distribution module for zone thermal plants. Version with 3 distribution zones manifold/separator, all with direct distribution in high temperature. Distribution units complete of variable speed electronic pump.
- Module de distribution MULTIMIX pour installations thermiques à zones. Version avec collecteur/séparateur à 3 zones de distribution, toutes avec distribution directe en haute température. Unités de distribution équipées de pompe électronique à vitesse variable.
- Verteilermodul MULTIMIX für Zonen-Heizungsanlagen. Ausführung mit Verteiler/Abscheider mit 3 Verteilungszonen, alle mit direkter Heißwasserverteilung. Verteileraggregate mit elektronischer Pumpe mit variabler Geschwindigkeit.
- Módulo de distribución MULTIMIX para centrales térmicas de zonas. Versión con colector/separador de 3 zonas de distribución, todas con distribución directa en alta temperatura. Unidades de distribución completas de bomba electrónica de velocidad variable.

Code	Insulation	Pump	Size	Price	Class	Packaging
506291PEI	✓	WIL04F	3 High T. modules	3.023,19 €	NI	1



• 200090 >> p. 204,316,396,503

MUL 2LE



ErP

- Modulo di distribuzione MULTIMIX per impianti termici a zone. Versione con collettore/separatore a 2 zone di distribuzione, entrambe di bassa temperatura con unità di miscelazione. Unità di distribuzione complete di pompa elettronica a velocità variabile.
- MULTIMIX distribution module for zone thermal plants. Version with 2 distribution zones manifold/separator, both low temperature with mixing unit. Distribution units complete of variable speed electronic pump.
- Module de distribution MULTIMIX pour installations thermiques à zones. Version avec collecteur/séparateur à 2 zones de distribution, toutes les deux de basse température avec unité de mélange. Unités de distribution équipées de pompe électronique à vitesse variable.
- Verteilermodul MULTIMIX für Zonen-Heizungsanlagen. Ausführung mit Verteiler/Abscheider mit 2 Verteilungszonen, beide für Kaltwasser mit Mischeinheit. Verteileraggregate mit elektronischer Pumpe mit variabler Geschwindigkeit.
- Módulo de distribución MULTIMIX para centrales térmicas de zonas. Versión con colector/separador de 2 zonas de distribución, ambos de baja temperatura con unidad de mezcla. Unidades de distribución completas de bomba electrónica de velocidad variable.

Code	Insulation	Pump	Size	Price	Class	Packaging
506288PEI	✓	WIL04F	2 Low T. modules	2.481,45 €	NI	1



• T 5011 U >> p. 252,315,396



• RV 01 >> p. 237,241,252,315,362,396



• 200089 >> p. 204,316,396,503

MUL 3LE



ErP

- Modulo di distribuzione MULTIMIX per impianti termici a zone. Versione con collettore/separatore a 3 zone di distribuzione, tutte di bassa temperatura con unità di miscelazione. Unità di distribuzione complete di pompa elettronica a velocità variabile.
- MULTIMIX distribution module for zone thermal plants. Version with 3 distribution zones manifold/separator, all low temperature with mixing unit. Distribution units complete of variable speed electronic pump.
- Module de distribution MULTIMIX pour installations thermiques à zones. Version avec collecteur/séparateur à 3 zones de distribution, toutes de basse température avec unité de mélange. Unités de distribution équipées de pompe électronique à vitesse variable.
- Verteilermodul MULTIMIX für Zonen-Heizungsanlagen. Ausführung mit Verteiler/Abscheider mit 3 Verteilungszonen, alle für Kaltwasser mit Mischeinheit. Verteileraggregate mit elektronischer Pumpe mit variabler Geschwindigkeit.
- Módulo de distribución MULTIMIX para centrales térmicas de zonas. Versión con colector/separador de 3 zonas de distribución, todas de baja temperatura con unidad de mezcla. Unidades de distribución completas de bomba electrónica de velocidad variable.

Code	Insulation	Pump	Size	Price	Class	Packaging
506289PEI	✓	WIL04F	3 Low T. modules	3.416,48 €	NI	1



• T 5011 U >> p. 252,315,396



• RV 01 >> p. 237,241,252,315,362,396



• 200090 >> p. 204,316,396,503

MUL 1HE/1LE

ErP

- Modulo di distribuzione MULTIMIX per impianti termici a zone. Versione con collettore/separatore a 2 zone di distribuzione, una di distribuzione diretta in alta temperatura, una di bassa temperatura con unità di miscelazione. Unità di distribuzione complete di pompa elettronica a velocità variabile.
- MULTIMIX distribution module for zone thermal plants. Version with 2 distribution zones manifold/separator, one of direct distribution in high temperature, one of low temperature with mixing unit. Distribution units complete of variable speed electronic pump.
- Module de distribution MULTIMIX pour installations thermiques à zones. Version avec collecteur/séparateur à 2 zones de distribution, une de distribution directe en haute température, une de basse température avec unité de mélange. Unités de distribution équipées de pompe électronique à vitesse variable.
- Verteilermodul MULTIMIX für Zonen-Heizungsanlagen. Ausführung mit Verteiler/Abscheider mit 2 Verteilungszonen, eine fmit direkter Heißwasserverteilung, eine für Kaltwasser mit Mischeinheit. Verteileraggregate mit elektronischer Pumpe mit variabler Geschwindigkeit.
- Módulo de distribución MULTIMIX para centrales térmicas de zonas. Versión con colector/separador de 2 zonas de distribución, una con distribución directa en alta temperatura, una de baja temperatura con unidad de mezcla. Unidades de distribución completas de bomba electrónica de velocidad variable.

Code	Insulation	Pump	Size	Price	Class	Packaging
506285PEI	✓	WIL04F	1 High T.module + 1 Low T. module	2.350,37 €	NI	1



• T 5011 U >> p. 252,315,396



• RV 01 >> p. 237,241,252,315,362,396



• 200089 >>p. 204,316,396,503

MUL 2HE/1LE

ErP

- Modulo di distribuzione MULTIMIX per impianti termici a zone. Versione con collettore/separatore a 3 zone di distribuzione, due di distribuzione diretta in alta temperatura, una di bassa temperatura con unità di miscelazione. Unità di distribuzione complete di pompa elettronica a velocità variabile.
- MULTIMIX distribution module for zone thermal plants. Version with 3 zones distribution manifold/separator, two of direct distribution in high temperature, one of low temperature with mixing unit. Distribution units complete of variable speed electronic pump.
- Module de distribution MULTIMIX pour installations thermiques à zones. Version avec collecteur/séparateur à 3 zones de distribution, deux avec distribution directe en haute température, une de basse température avec unité de mélange. Unités de distribution équipées d'une pompe électronique à vitesse variable.
- Verteilermodul MULTIMIX für Zonen-Heizungsanlagen. Ausführung mit Verteiler/Abscheider mit 3 Verteilungszonen, zwei mit direkter Heißwasserverteilung, eine für Kaltwasser mit Mischeinheit. Verteileraggregate mit elektronischer Pumpe mit variabler Geschwindigkeit.
- Módulo de distribución MULTIMIX para centrales térmicas de zonas. Versión con colector/separador de 3 zonas de distribución, dos con distribución directa en alta temperatura, una de baja temperatura con unidad de mezcla. Unidades de distribución completas de bomba electrónica de velocidad variable.

Code	Insulation	Pump	Size	Price	Class	Packaging
506287PEI	✓	WIL04F	2 High T. modules + 1 Low T. module	3.154,29 €	NI	1



• T 5011 U >> p. 252,315,396



• RV 01 >> p. 237,241,252,315,362,396



• 200090 >>p. 204,316,396,503

MUL 1HE/2LE

ErP

- Modulo di distribuzione MULTIMIX per impianti termici a zone. Versione con collettore/separatore a 3 zone di distribuzione, una di distribuzione diretta in alta temperatura, due di bassa temperatura con unità di miscelazione. Unità di distribuzione complete di pompa elettronica a velocità variabile.
- MULTIMIX distribution module for zone thermal plants. Version with 3 zones distribution manifold/separator, one of direct distribution in high temperature, two of low temperature with mixing unit. Distribution units complete of variable speed electronic pump.
- Module de distribution MULTIMIX pour installations thermiques à zones. Version avec collecteur/séparateur à 3 zones de distribution, une avec distribution directe en haute température, deux de basse température avec unité de mélange. Unités de distribution équipées de pompe électronique à vitesse variable.
- Verteilermodul MULTIMIX für Zonen-Heizungsanlagen. Ausführung mit Verteiler/Abscheider mit 3 Verteilungszonen, eine mit direkter Heißwasserverteilung, zwei für Kaltwasser mit Mischeinheit. Verteileraggregate mit elektronischer Pumpe mit variabler Geschwindigkeit.
- Módulo de distribución MULTIMIX para centrales térmicas de zonas. Versión con colector/separador de 3 zonas de distribución, una con distribución directa en alta temperatura, dos de baja temperatura con unidad de mezcla. Unidades de distribución completas de bomba electrónica de velocidad variable.

Code	Insulation	Pump	Size	Price	Class	Packaging
506286PEI	✓	WIL04F	1 High T. module + 2 Low T. modules	3.285,38 €	NI	1



• T 5011 U >> p. 252,315,396



• RV 01 >> p. 237,241,252,315,362,396



• 200090 >>p. 204,316,396,503

WIL04F

ErP

- Circolatore elettronico a velocità variabile (Conforme alla direttiva europea 2009/125/CE - ErP "Energy related Products").
- Variable speed electronic circulator (In accordance with European Directive 2009/125/CE - ErP "Energy related Products").
- Circulateur chauffage électronique à vitesse variable (Conforme à la Directive Européenne 2009/125/CE - ErP "Energy related Products").
- Elektronische Umwälzpumpe mit variabler Geschwindigkeit (Entspricht der Europäischen Richtlinie 2009/125/CE - ErP "Energy related Products").
- Circulador electrónico de velocidad variable (Conforme a la directiva europea 2009/125/CE - ErP "Energy related Products").

Code	Size	Head loss	Price	Class	Packaging
WIL04F	1"1/2 - 130 mm	6 m	312,00 €	HK	3

MUL 2H



- Modulo di distribuzione MULTIMIX per impianti termici a zone. Versione con collettore/separatore a 2 zone di distribuzione, entrambe di distribuzione diretta in alta temperatura. Unità di distribuzione complete di pompa standard a 3 velocità.
- MULTIMIX distribution module for zone thermal plants. Version with 2 distribution zones manifold/separator, both with direct distribution in high temperature. Distribution units complete of standard 3-speed pump.
- Module de distribution MULTIMIX pour installations thermiques à zones. Version avec collecteur/séparateur à 2 zones de distribution, toutes les deux avec distribution directe en haute température. Unités de distribution équipées de pompe standard à 3 vitesses.
- Verteilermodul MULTIMIX für Zonen-Heizungsanlagen. Ausführung mit Verteiler/Abscheider mit 2 Verteilungszonen, beide mit direkter Heißwasserverteilung. Verteileraggregate mit Standardpumpe mit 3 Geschwindigkeiten.
- Módulo de distribución MULTIMIX para centrales térmicas de zonas. Versión con colector/separador de 2 zonas de distribución, ambos con distribución directa en alta temperatura. Unidades de distribución completas de bomba estándar de 3 velocidades.

Code	Insulation	Pump	Size	Price	Class	Packaging
506290PI	✓	WIL03F	2 High T. modules	2.039,14 €	NI	1



• 200089 >> p. 204,316,396,503

MUL 3H



- Modulo di distribuzione MULTIMIX per impianti termici a zone. Versione con collettore/separatore a 3 zone di distribuzione, tutte di distribuzione diretta in alta temperatura. Unità di distribuzione complete di pompa standard a 3 velocità.
- MULTIMIX distribution module for zone thermal plants. Version with 3 distribution zones manifold/separator, all with direct distribution in high temperature. Distribution units complete of standard 3-speed pump.
- Module de distribution MULTIMIX pour installations thermiques à zones. Version avec collecteur/séparateur à 3 zones de distribution, toutes avec distribution directe en haute température. Unités de distribution équipées de pompe standard à 3 vitesses.
- Verteilermodul MULTIMIX für Zonen-Heizungsanlagen. Ausführung mit Verteiler/Abscheider mit 3 Verteilungszonen, alle mit direkter Heißwasserverteilung. Verteileraggregate mit Standardpumpe mit 3 Geschwindigkeiten.
- Módulo de distribución MULTIMIX para centrales térmicas de zonas. Versión con colector/separador de 3 zonas de distribución, todas con distribución directa en alta temperatura. Unidades de distribución completas de bomba estándar de 3 velocidades.

Code	Insulation	Pump	Size	Price	Class	Packaging
506291PI	✓	WIL03F	3 High T. modules	2.753,01 €	NI	1



• 200090 >> p. 204,316,396,503

MUL 2L



- Modulo di distribuzione MULTIMIX per impianti termici a zone. Versione con collettore/separatore a 2 zone di distribuzione, entrambe di bassa temperatura con unità di miscelazione. Unità di distribuzione complete di pompa standard a 3 velocità.
- MULTIMIX distribution module for zone thermal plants. Version with 2 distribution zones manifold/separator, both low temperature with mixing unit. Distribution units complete of standard 3-speed pump.
- Module de distribution MULTIMIX pour installations thermiques à zones. Version avec collecteur/séparateur à 2 zones de distribution, toutes les deux de basse température avec unité de mélange. Unités de distribution équipées de pompe standard à 3 vitesses.
- Verteilermodul MULTIMIX für Zonen-Heizungsanlagen. Ausführung mit Verteiler/Abscheider mit 2 Verteilungszonen, beide für Kaltwasser mit Mischeinheit. Verteileraggregate mit Standardpumpe mit 3 Geschwindigkeiten.
- Módulo de distribución MULTIMIX para centrales térmicas de zonas. Versión con colector/separador de 2 zonas de distribución, ambos de baja temperatura con unidad de mezcla. Unidades de distribución completas de bomba estándar de 3 velocidades.

Code	Insulation	Pump	Size	Price	Class	Packaging
506288PI	✓	WIL03F	2 Low T. modules	2.285,12 €	NI	1



• T 5011 U >> p. 252,315,396



• RV 01 >> p. 237,241,252,315,362,396



• 200089 >> p. 204,316,396,503

MUL 3L



- Modulo di distribuzione MULTIMIX per impianti termici a zone. Versione con collettore/separatore a 3 zone di distribuzione, tutte di bassa temperatura con unità di miscelazione. Unità di distribuzione complete di pompa standard a 3 velocità.
- MULTIMIX distribution module for zone thermal plants. Version with 3 distribution zones manifold/separator, all low temperature with mixing unit. Distribution units complete of standard 3-speed pump.
- Module de distribution MULTIMIX pour installations thermiques à zones. Version avec collecteur/séparateur à 3 zones de distribution, toutes de basse température avec unité de mélange. Unités de distribution équipées de pompe standard à 3 vitesses.
- Verteilermodul MULTIMIX für Zonen-Heizungsanlagen. Ausführung mit Verteiler/Abscheider mit 3 Verteilungszonen, alle für Kaltwasser mit Mischeinheit. Verteileraggregate mit Standardpumpe mit 3 Geschwindigkeiten.
- Módulo de distribución MULTIMIX para centrales térmicas de zonas. Versión con colector/separador de 3 zonas de distribución, todas de baja temperatura con unidad de mezcla. Unidades de distribución completas de bomba estándar de 3 velocidades.

Code	Insulation	Pump	Size	Price	Class	Packaging
506289PI	✓	WIL03F	3 Low T. modules	3.121,96 €	NI	1



• T 5011 U >> p. 252,315,396



• RV 01 >> p. 237,241,252,315,362,396

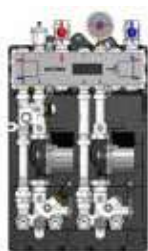

• 200090 >> p. 204,316,396,503

MUL 1H/1L

- Modulo di distribuzione MULTIMIX per impianti termici a zone. Versione con collettore/separatore a 2 zone di distribuzione, una di distribuzione diretta in alta temperatura, una di bassa temperatura con unità di miscelazione. Unità di distribuzione complete di pompa standard a 3 velocità.
- MULTIMIX distribution module for zone thermal plants. Version with 2 distribution zones manifold/separator, one of direct distribution in high temperature, one of low temperature with mixing unit. Distribution units complete of standard 3-speed pump.
- Module de distribution MULTIMIX pour installations thermiques à zones. Version avec collecteur/séparateur à 2 zones de distribution, une de distribution directe en haute température, une de basse température avec unité de mélange. Unités de distribution équipées de pompe standard à 3 vitesses.
- Verteilermodul MULTIMIX für Zonen-Heizungsanlagen. Ausführung mit Verteiler/Abscheider mit 2 Verteilungszonen, eine mit direkter Heißwasserverteilung, eine für Kaltwasser mit Mischeinheit. Verteileraggregate mit Standardpumpe mit 3 Geschwindigkeiten.
- Módulo de distribución MULTIMIX para centrales térmicas de zonas. Versión con colector/separador de 2 zonas de distribución, una con distribución directa en alta temperatura, una de baja temperatura con unidad de mezcla. Unidades de distribución completas de bomba estándar de 3 velocidades.

Code	Insulation	Pump	Size	Price	Class	Packaging
506285PI	✓	WIL03F	1 High T. module + 1 Low T. module	2.162,12 €	NI	1



• T 5011 U >> p. 252,315,396



• RV 01 >> p. 237,241,252,315,362,396



• 200089 >>p. 204,316,396,503

MUL 2H/1L

- Modulo di distribuzione MULTIMIX per impianti termici a zone. Versione con collettore/separatore a 3 zone di distribuzione, due di distribuzione diretta in alta temperatura, una di bassa temperatura con unità di miscelazione. Unità di distribuzione complete di pompa standard a 3 velocità.
- MULTIMIX distribution module for zone thermal plants. Version with 3 zones distribution manifold/separator, two of direct distribution in high temperature, one of low temperature with mixing unit. Distribution units complete of standard 3-speed pump.
- Module de distribution MULTIMIX pour installations thermiques à zones. Version avec collecteur/séparateur à 3 zones de distribution, deux avec distribution directe en haute température, une de basse température avec unité de mélange. Unités de distribution équipées d'une pompe standard à 3 vitesses.
- Verteilermodul MULTIMIX für Zonen-Heizungsanlagen. Ausführung mit Verteiler/Abscheider mit 3 Verteilungszonen, zwei mit direkter Heißwasserverteilung, eine für Kaltwasser mit Mischeinheit. Verteileraggregate mit Standardpumpe mit 3 Geschwindigkeiten.
- Módulo de distribución MULTIMIX para centrales térmicas de zonas. Versión con colector/separador de 3 zonas de distribución, dos con distribución directa en alta temperatura, una de baja temperatura con unidad de mezcla. Unidades de distribución completas de bomba estándar de 3 velocidades.

Code	Insulation	Pump	Size	Price	Class	Packaging
506287PI	✓	WIL03F	2 High T. modules + 1 Low T. module	2.876,00 €	NI	1



• T 5011 U >> p. 252,315,396



• RV 01 >> p. 237,241,252,315,362,396

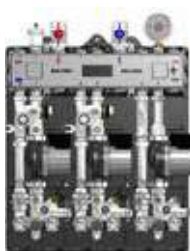

• 200090 >>p. 204,316,396,503

MUL 1H/2L

- Modulo di distribuzione MULTIMIX per impianti termici a zone. Versione con collettore/separatore a 3 zone di distribuzione, una di distribuzione diretta in alta temperatura, due di bassa temperatura con unità di miscelazione. Unità di distribuzione complete di pompa standard a 3 velocità.
- MULTIMIX distribution module for zone thermal plants. Version with 3 zones distribution manifold/separator, one of direct distribution in high temperature, two of low temperature with mixing unit. Distribution units complete of standard 3-speed pump.
- Module de distribution MULTIMIX pour installations thermiques à zones. Version avec collecteur/séparateur à 3 zones de distribution, une avec distribution directe en haute température, deux de basse température avec unité de mélange. Unités de distribution équipées de pompe standard à 3 vitesses.
- Verteilermodul MULTIMIX für Zonen-Heizungsanlagen. Ausführung mit Verteiler/Abscheider mit 3 Verteilungszonen, eine mit direkter Heißwasserverteilung, zwei für Kaltwasser mit Mischeinheit. Verteileraggregate mit Standardpumpe mit 3 Geschwindigkeiten.
- Módulo de distribución MULTIMIX para centrales térmicas de zonas. Versión con colector/separador de 3 zonas de distribución, una con distribución directa en alta temperatura, dos de baja temperatura con unidad de mezcla. Unidades de distribución completas de bomba estándar de 3 velocidades.

Code	Insulation	Pump	Size	Price	Class	Packaging
506286PI	✓	WIL03F	1 High T. module + 2 Low T. modules	2.998,99 €	NI	1



• T 5011 U >> p. 252,315,396



• RV 01 >> p. 237,241,252,315,362,396



• 200090 >>p. 204,316,396,503

WIL03F

- Circolatore standard a 3 velocità.
- 3-speed standard circulator.
- Circulateur standard à 3 vitesses.
- Umwälzpumpe mit 3 Geschwindigkeitsstufen.
- Circulador estándar de 3 velocidades.

Code	Size	Head loss	Price	Class	Packaging
WIL03F	1"1/2 - 130 mm	6 m	216,14 €	HK	5

MUL 0032 AC



- Collettore principale di distribuzione a 2 vie con separatore idraulico intercettabile (a impianto funzionante) per sistema MULTIMIX, completo di valvole a sfera, termomanometro e sfiato aria automatico.
- 2-way main distribution manifold with interceptable (even when the system is functioning) hydraulic separator for MULTIMIX system, complete with ball valves, temperature/pressure gauge and automatic air vent.
- Collecteur principal de distribution à 2 voies avec séparateur hydraulique interceptable (lorsque l'installation fonctionne) pour système MULTIMIX, constitué de vannes à bille, thermomanomètre et purgeur d'air automatique.
- 2-Wege Hauptmodulverteiler mit hydraulischen Weichen (in Betrieb stehender Anlage) für das MULTIMIX System, mit Kugelventilen, Thermomanometer und automatischem Schnellentlüfter.
- Colector principal de distribución a 2 vías con separador hidráulico intercettable (con el sistema en funcionamiento) para el sistema de MULTIMIX, con válvulas de bola, termomanómetro y purga automática.

Code	Included Accessories	Ways	Size	Price	Class	Packaging
506282	AC 655 NST + MA 20 + AC 620	2	G 1" F x G 3/4" F	719,92 €	NI	1

MUL 0032



- Collettore principale di distribuzione a 2 vie con separatore idraulico intercettabile per sistema MULTIMIX completo di nipples 1" M.
- 2-way main distribution manifold with interceptable hydraulic separator for MULTIMIX system, 1" M nipples included.
- Collecteur principal de distribution à 2 voies avec séparateur hydraulique interceptable pour système MULTIMIX complet d'embouts 1" M.
- 2-Wege Hauptmodulverteiler mit hydraulischen Weichen für das MULTIMIX System, mit AnschluBnippeln 1" AG.
- Colector principal de distribución a 2 vías con separador hidráulico intercettable para sistema MULTIMIX, completo de nipples 1" M.

Code	Included Accessories	Ways	Size	Price	Class	Packaging
506284	AC 606 N	2	G 1" F x G 3/4" F	631,66 €	NI	1

MUL 0033 AC



- Collettore principale di distribuzione a 3 vie con separatore idraulico intercettabile (a impianto funzionante) per sistema MULTIMIX, completo di valvole a sfera, termomanometro e sfiato aria automatico.
- 3-way main distribution manifold with interceptable (even when the system is functioning) hydraulic separator for MULTIMIX system, complete with ball valves, temperature/pressure gauge and automatic air vent.
- Collecteur principal de distribution à 3 voies avec séparateur hydraulique interceptable (lorsque l'installation fonctionne) pour système MULTIMIX, constitué de vannes à bille, thermomanomètre et purgeur d'air automatique.
- 3-Wege Hauptmodulverteiler mit hydraulischen Weichen (in Betrieb stehender Anlage) für das MULTIMIX System, mit Kugelventilen, Thermomanometer und automatischem Schnellentlüfter.
- Colector principal de distribución a 3 vías con separador hidráulico intercettable (con el sistema en funcionamiento) para el sistema de MULTIMIX, con válvulas de bola, termomanómetro y purga automática.

Code	Included Accessories	Ways	Size	Price	Class	Packaging
506283	AC 655 NST + MA 20 + AC 620	3	G 1" F x G 3/4" F	833,91 €	NI	1

MUL 0033



- Collettore principale di distribuzione a 3 vie con separatore idraulico intercettabile per sistema MULTIMIX completo di nipples 1" M.
- 3-way main distribution manifold with interceptable hydraulic separator for MULTIMIX system, 1" M nipples included.
- Collecteur principal de distribution à 3 voies avec séparateur hydraulique interceptable pour système MULTIMIX complet d'embouts 1" M.
- 3-Wege Hauptmodulverteiler mit hydraulischen Weichen für das MULTIMIX System, mit AnschluBnippeln 1" AG.
- Colector principal de distribución a 3 vías con separador hidráulico intercettable para sistema MULTIMIX, completo de nipples 1" M.

Code	Included Accessories	Ways	Size	Price	Class	Packaging
506285	AC 606 N	3	G 1" F x G 3/4" F	745,64 €	NI	1

AC 655 NST



- Coppia di valvole a sfera diritte maschio-femmina complete di bocchettone a tenuta morbida, manovra a farfalla.
- Pair of male-female straight ball valves with soft-seal fitting, butterfly operation.
- Set de vannes à bille droites mâle-femelle avec goulotte à étanchéité souple, manoeuvre à papillon.
- Paar Durchgangs-Kugelventil AG-IG mit Selbstdichtendstutzen und Flügelgriff.
- Conjunto de válvulas de bola rectas macho-hembra completas de manguito de unión con junta blanda, vuelta a mariposa.

Code	Size	Color	Price	Class	Packaging
506406	1"	Blue / Red	58,75 €	NO	2 / 16

AC 620



- Valvola di sfiato aria automatica.
- Automatic air valve.
- Purgeur d'air automatique.
- Automatisches Entlüftungsventil.
- Válvula purgadora automática.

Code	Size	Color	Price	Class	Packaging
501323	3/8"	Grey	11,29 €	NJ	15 / 120
501325	1/2"	Grey	11,02 €	NJ	15 / 120

MUL 10 E

ErP

- Kit di mandata diretta in alta temperatura con/senza pompa elettronica a velocità variabile per sistema MULTIMIX.
- High temperature direct flow kit with/without variable speed electronic pump for MULTIMIX system.
- Kit d'envoi direct en haute température avec/sans pompe électronique à vitesse variable pour le système MULTIMIX.
- Direktversorgungs-Heißwassersatz mit/ohne elektronischer Pumpe mit variabler Geschwindigkeit für das MULTIMIX System.
- Kit de envío directo de alta temperatura con/sin bomba electrónica de velocidad variable para sistema MULTIMIX.

Code	Pump	Size	Insulation	Price	Class	Packaging
506280NB		G 3/4" M	-	335,84 €	NI	1
506280PE	WILO4F	G 3/4" M	-	655,68 €	NI	1
506280PEI	WILO4F	G 3/4" M	✓	714,73 €	NI	1

MUL 20 E

ErP

- Kit di miscelazione in bassa temperatura con/senza pompa elettronica a velocità variabile per sistema MULTIMIX.
- Low temperature mixing kit with/without variable speed electronic pump for MULTIMIX system.
- Kit de mélange en basse température complet de pompe électronique à vitesse variable pour système MULTIMIX.
- Fußbodenheizungs-Mischersatz mit/ohne elektronischer Pumpe mit variabler Geschwindigkeit für das MULTIMIX System.
- Kit de mezcla de baja temperatura con/sin bomba electrónica de velocidad variable para sistema MULTIMIX.

Code	Pump	Size	Insulation	Price	Class	Packaging
506281NB		G 3/4" M	-	458,84 €	NI	1
506281PE	WILO4F	G 3/4" M	-	729,19 €	NI	1
506281PEI	WILO4F	G 3/4" M	✓	883,80 €	NI	1



• T 5011 U >> p. 252,315,396



• RV 01 >> p. 237,241,252,315,362,396

MUL 11

ErP

- Kit di mandata diretta in alta temperatura con/senza pompa standard a 3 velocità completo di bypass per sistema MULTIMIX.
- High temperature direct flow kit with/without standard 3-speed pump complete with bypass for MULTIMIX system.
- Kit d'envoi direct en haute température avec/sans pompe standard à 3 vitesses complet de bypass pour le système MULTIMIX.
- Direktversorgungs-Heißwassersatz mit/ohne Standardpumpe mit 3 Geschwindigkeiten mit Bypass für das MULTIMIX System.
- Kit de envío directo de alta temperatura con/sin bomba estándar de 3 velocidades con bypass para sistema MULTIMIX.

Code	Bypass	Pump	Size	Price	Class	Packaging
506280	✓		G 3/4" M	343,95 €	NI	1
506280P	✓	WILO3F	G 3/4" M	565,59 €	NI	1

MUL 20

ErP

- Kit di miscelazione in bassa temperatura con/senza pompa standard a 3 velocità completo di bypass per sistema MULTIMIX.
- Low temperature mixing kit with/without standard 3-speed pump complete with bypass for MULTIMIX system.
- Kit de mélange en basse température avec/sans pompe standard à 3 vitesses complet de bypass pour système MULTIMIX.
- Fußbodenheizungs-Mischersatz mit/ohne Standardpumpe mit 3 Geschwindigkeiten mit Bypass für das MULTIMIX System.
- Kit de mezcla de baja temperatura con/sin bomba estándar de 3 velocidades con bypass para sistema MULTIMIX.

Code	Bypass	Pump	Size	Insulation	Price	Class	Packaging
506281	✓		G 3/4" M	-	466,94 €	NI	1
506281P	✓	WILO3F	G 3/4" M	-	688,59 €	NI	1
506281PI	✓	WILO3F	G 3/4" M	✓	761,74 €	NI	1



• T 5011 U >> p. 252,315,396



• RV 01 >> p. 237,241,252,315,362,396

AC 606

- Nipplo girevole maschio - maschio.
- Swivelling male - male nipple.
- Nipple pivotant mâle - mâle.
- AG - AG drehbarer Nippel.
- Enterosca giratoria macho - macho.

Code	Size	Color	Price	Class	Packaging
500070	1" M O-ring x 1" M O-ring	■	10,81 €	NJ	20 / 80

MA 20 R

- Termomanometro con attacco radiale.
- Temperature-pressure gauge with radial coupling.
- Thermomanomètre avec embout radiale.
- Thermomanometer mit radial Anschluss.
- Termomanómetro con conexión radial.

Code	Size	Range	Price	Class	Packaging
509141R	1/2" M	0-120 °C - 0-6 bar	36,11 €	NL	30

MULTIMIX•C

The MULTIMIX C system enables the transfer of fluids at different temperatures to each thermal zone via a distribution and boosting kit, made independent by the pressure equaliser incorporated in the main manifold. The extraordinary compact size facilitates installation below the boiler and in confined spaces.

MULTIMIX C is made up of the manifold/separator and direct kits, or versions with mixer, which can be configured and combined to meet specific requirements. Pre-assembled configurations are also available with insulation casing in polypropylene (metal recessed cabinet is supplied separately).

Max. primary flow rate: 3000 l/h

Max. flow rate per kit: 1700 l/h

PLUS

- **Compact and flexible (2 or 3 zones)**
- **Integrated hydraulic separator in main manifold**
- **Pre-assembled configurations available**
- **Suitable for heating and cooling**

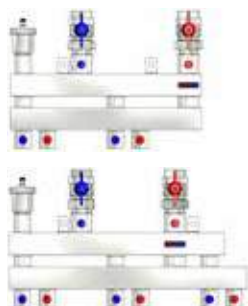

MANIFOLD/SEPARATOR

- *3 functions:*
 - Delivery manifold
 - Return manifold
 - Hydraulic separator (with shutoff provision before installation)
- Two or three zones



DISTRIBUTION AND MIXING KIT

- 3-way piston mixing valve and secondary bypass
- Option of fixed point or climate control
- Safety thermostat, thermometers, non-return valve
- Pump with shutoff provision and simplified installation thanks to telescopic connection



DIRECT DISTRIBUTION KIT

- Thermometers, non-return valve
- Pump with shutoff provision and simplified installation thanks to telescopic connection

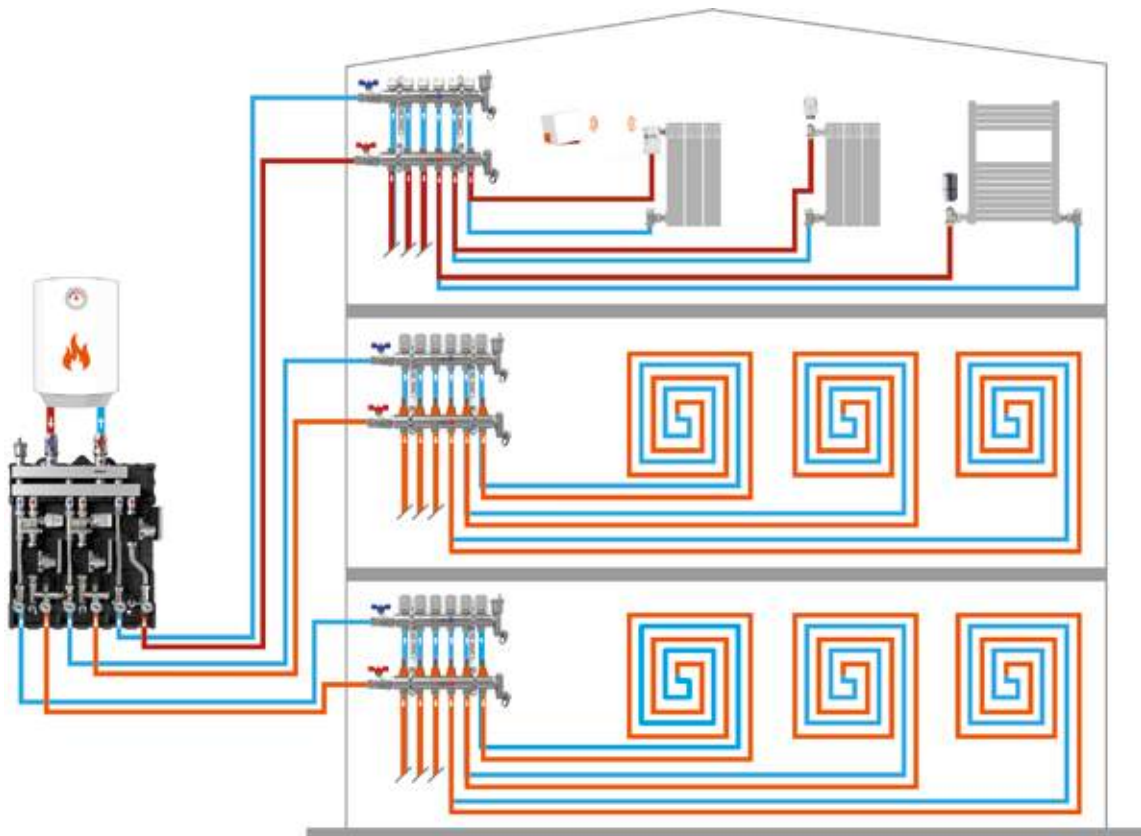
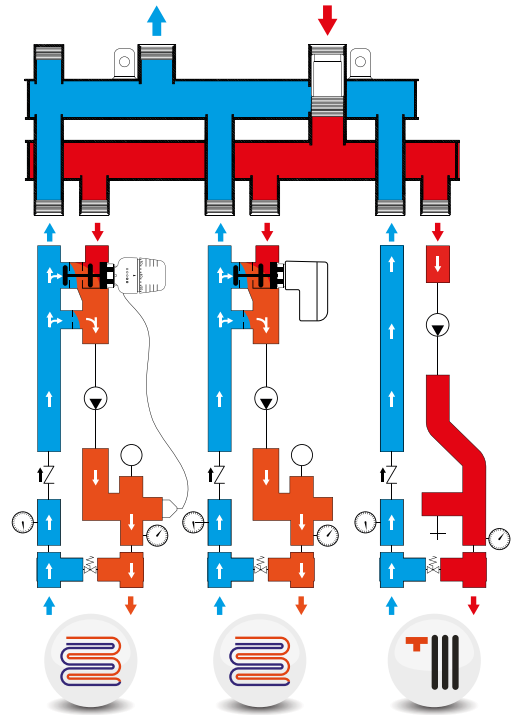

MUL-C 2HE



ErP

- Modulo di distribuzione MULTIMIX-C per impianti termici a zone. Versione con collettore/separatore a 2 zone di distribuzione, entrambe di distribuzione diretta in alta temperatura. Unità di distribuzione complete di pompa elettronica a velocità variabile.
- MULTIMIX-C distribution module for zone thermal plants. Version with 2 distribution zones manifold/separator, both with direct distribution in high temperature. Distribution units complete of variable speed electronic pump.
- Module de distribution MULTIMIX-C pour installations thermiques à zones. Version avec collecteur/séparateur à 2 zones de distribution, toutes les deux avec distribution directe en haute température. Unités de distribution équipées de pompe électronique à vitesse variable.
- Verteilermodul MULTIMIX-C für Zonen-Heizungsanlagen. Ausführung mit Verteiler/Abscheider mit 2 Verteilungszonen, beide mit direkter Heißwasserverteilung. Verteileraggregate mit elektronischer Pumpe mit variabler Geschwindigkeit
- Módulo de distribución MULTIMIX-C para centrales térmicas de zonas. Versión con colector/separador de 2 zonas de distribución, ambos con distribución directa en alta temperatura. Unidades de distribución completas de bomba electrónica de velocidad variable.

Code	Insulation	Pump	Size	Price	Class	Packaging
508139PEI	✓	WILO4F-110	2 High T. modules	1.514,70 €	NI	1



• 200089 >>p. 204,316,396,503

MUL-C 3HE



ErP

- Modulo di distribuzione MULTIMIX-C per impianti termici a zone. Versione con collettore/separatore a 3 zone di distribuzione, tutte di distribuzione diretta in alta temperatura con distribuzione diretta. Unità di distribuzione complete di pompa elettronica a velocità variabile.
- MULTIMIX-C distribution module for zone thermal plants. Version with 3 distribution zones manifold/separator, all with direct distribution in high temperature. Distribution units complete of variable speed electronic pump.
- Module de distribution MULTIMIX-C pour installations thermiques à zones. Version avec collecteur/séparateur à 3 zones de distribution, toutes avec distribution directe en haute température. Unités de distribution équipées de pompe électronique à vitesse variable.
- Verteilermodul MULTIMIX-C für Zonen-Heizungsanlagen. Ausführung mit Verteiler/Abscheider mit 3 Verteilungszonen, alle mit direkter Heißwasserverteilung. Verteileraggregate mit elektronischer Pumpe mit variabler Geschwindigkeit.
- Módulo de distribución MULTIMIX-C para centrales térmicas de zonas. Versión con colector/separador de 3 zonas de distribución, todas con distribución directa en alta temperatura. Unidades de distribución completas de bomba electrónica de velocidad variable.

Code	Insulation	Pump	Size	Price	Class	Packaging
508140PEI	✓	WILO4F-110	3 High T. modules	2.064,77 €	NI	1



• 200090 >>p. 204,316,396,503

MUL-C 2LE



ErP

- Modulo di distribuzione MULTIMIX-C per impianti termici a zone. Versione con collettore/separatore a 2 zone di distribuzione, entrambe di bassa temperatura con unità di miscelazione. Unità di distribuzione complete di pompa elettronica a velocità variabile.
- MULTIMIX-C distribution module for zone thermal plants. Version with 2 distribution zones manifold/separator, both low temperature with mixing unit. Distribution units complete of variable speed electronic pump.
- Module de distribution MULTIMIX-C pour installations thermiques à zones. Version avec collecteur/séparateur à 2 zones de distribution, toutes les deux de basse température avec unité de mélange. Unités de distribution équipées de pompe électronique à vitesse variable.
- Verteilermodul MULTIMIX-C für Zonen-Heizungsanlagen. Ausführung mit Verteiler/Abscheider mit 2 Verteilungszonen, beide für Kaltwasser mit Mischeinheit. Verteileraggregate mit elektronischer Pumpe mit variabler Geschwindigkeit.
- Módulo de distribución MULTIMIX-C para centrales térmicas de zonas. Versión con colector/separador de 2 zonas de distribución, ambos de baja temperatura con unidad de mezcla. Unidades de distribución completas de bomba electrónica de velocidad variable.

Code	Insulation	Pump	Size	Price	Class	Packaging
508137PEI	✓	WILO4F-110	2 Low T. modules	1.906,97 €	NI	1



• T 5011 U >> p. 252,315,396



• RV 01 >> p. 237,241,252,315,362,396



• 200089 >>p. 204,316,396,503

MUL-C 3LE



ErP

- Modulo di distribuzione MULTIMIX-C per impianti termici a zone. Versione con collettore/separatore a 3 zone di distribuzione, tutte di bassa temperatura con unità di miscelazione. Unità di distribuzione complete di pompa elettronica a velocità variabile.
- MULTIMIX-C distribution module for zone thermal plants. Version with 3 distribution zones manifold/separator, all low temperature with mixing unit. Distribution units complete of variable speed electronic pump.
- Module de distribution MULTIMIX-C pour installations thermiques à zones. Version avec collecteur/séparateur à 3 zones de distribution, toutes de basse température avec unité de mélange. Unités de distribution équipées de pompe électronique à vitesse variable.
- Verteilermodul MULTIMIX-C für Zonen-Heizungsanlagen. Ausführung mit Verteiler/Abscheider mit 3 Verteilungszonen, alle für Kaltwasser mit Mischeinheit. Verteileraggregate mit elektronischer Pumpe mit variabler Geschwindigkeit.
- Módulo de distribución MULTIMIX-C para centrales térmicas de zonas. Versión con colector/separador de 3 zonas de distribución, todas de baja temperatura con unidad de mezcla. Unidades de distribución completas de bomba electrónica de velocidad variable.

Code	Insulation	Pump	Size	Price	Class	Packaging
508138PEI	✓	WILO4F-110	3 Low T. modules	2.653,15 €	NI	1



• T 5011 U >> p. 252,315,396



• RV 01 >> p. 237,241,252,315,362,396



• 200090 >>p. 204,316,396,503

MUL-C 1HE/1LE

ErP

- Modulo di distribuzione MULTIMIX-C per impianti termici a zone. Versione con collettore/separatore a 2 zone di distribuzione, una di distribuzione diretta in alta temperatura, una di bassa temperatura con unità di miscelazione. Unità di distribuzione complete di pompa elettronica a velocità variabile.
- MULTIMIX-C distribution module for zone thermal plants. Version with 2 distribution zones manifold/separator, one of direct distribution in high temperature, one of low temperature with mixing unit. Distribution units complete of variable speed electronic pump.
- Module de distribution MULTIMIX-C pour installations thermiques à zones. Version avec collecteur/séparateur à 2 zones de distribution, une de distribution directe en haute température, une de basse température avec unité de mélange. Unités de distribution équipées de pompe électronique à vitesse variable.
- Verteilermodul MULTIMIX-C für Zonen-Heizungsanlagen. Ausführung mit Verteiler/Abscheider mit 2 Verteilungszonen, eine frmidirekter Heißwasserverteilung, eine für Kaltwasser mit Mischeinheit. Verteileraggregate mit elektronischer Pumpe mit variabler Geschwindigkeit.
- Módulo de distribución MULTIMIX-C para centrales térmicas de zonas. Versión con colector/separador de 2 zonas de distribución, una con distribución directa en alta temperatura, una de baja temperatura con unidad de mezcla. Unidades de distribución completas de bomba electrónica de velocidad variable.

Code	Insulation	Pump	Size	Price	Class	Packaging
508134PEI	✓	WILO4F-110	1 High T. module + 1 Low T. module	1.710,84 €	NI	1



• T 5011 U >> p. 252,315,396



• RV 01 >> p. 237,241,252,315,362,396



• 200089 >>p. 204,316,396,503

MUL-C 2HE/1LE

ErP

- Modulo di distribuzione MULTIMIX-C per impianti termici a zone. Versione con collettore/separatore a 3 zone di distribuzione, due di distribuzione diretta in alta temperatura, una di bassa temperatura con unità di miscelazione. Unità di distribuzione complete di pompa elettronica a velocità variabile.
- MULTIMIX-C distribution module for zone thermal plants. Version with 3 zones distribution manifold/separator, two of direct distribution in high temperature, one of low temperature with mixing unit. Distribution units complete of variable speed electronic pump.
- Module de distribution MULTIMIX-C pour installations thermiques à zones. Version avec collecteur/séparateur à 3 zones de distribution, deux avec distribution directe en haute température, une de basse température avec unité de mélange. Unités de distribution équipées d'une pompe électronique à vitesse variable.
- Verteilermodul MULTIMIX-C für Zonen-Heizungsanlagen. Ausführung mit Verteiler/Abscheider mit 3 Verteilungszonen, zwei mitdirekter Heißwasserverteilung, eine für Kaltwasser mit Mischeinheit. Verteileraggregate mit elektronischer Pumpe mit variabler Geschwindigkeit.
- Módulo de distribución MULTIMIX-C para centrales térmicas de zonas. Versión con colector/separador de 3 zonas de distribución, dos con distribución directa en alta temperatura, una de baja temperatura con unidad de mezcla. Unidades de distribución completas de bomba electrónica de velocidad variable.

Code	Insulation	Pump	Size	Price	Class	Packaging
508136PEI	✓	WILO4F-110	2 High T. modules + 1 Low T. module	2.260,90 €	NI	1



• T 5011 U >> p. 252,315,396



• RV 01 >> p. 237,241,252,315,362,396



• 200090 >>p. 204,316,396,503

MUL-C 1HE/2LE

ErP

- Modulo di distribuzione MULTIMIX-C per impianti termici a zone. Versione con collettore/separatore a 3 zone di distribuzione, una di distribuzione diretta in alta temperatura, due di bassa temperatura con unità di miscelazione. Unità di distribuzione complete di pompa elettronica a velocità variabile.
- MULTIMIX-C distribution module for zone thermal plants. Version with 3 zones distribution manifold/separator, one of direct distribution in high temperature, two of low temperature with mixing unit. Distribution units complete of variable speed electronic pump.
- Module de distribution MULTIMIX-C pour installations thermiques à zones. Version avec collecteur/séparateur à 3 zones de distribution, une avec distribution directe en haute température, deux de basse température avec unité de mélange. Unités de distribution équipées de pompe électronique à vitesse variable.
- Verteilermodul MULTIMIX-C für Zonen-Heizungsanlagen. Ausführung mit Verteiler/Abscheider mit 3 Verteilungszonen, eine mitdirekter Heißwasserverteilung, zwei für Kaltwasser mit Mischeinheit. Verteileraggregate mit elektronischer Pumpe mit variabler Geschwindigkeit.
- Módulo de distribución MULTIMIX-C para centrales térmicas de zonas. Versión con colector/separador de 3 zonas de distribución, una con distribución directa en alta temperatura, dos de baja temperatura con unidad de mezcla. Unidades de distribución completas de bomba electrónica de velocidad variable.

Code	Insulation	Pump	Size	Price	Class	Packaging
508135PEI	✓	WILO4F-110	1 High T. module + 2 Low T. modules	2.457,02 €	NI	1



• T 5011 U >> p. 252,315,396



• RV 01 >> p. 237,241,252,315,362,396



• 200090 >>p. 204,316,396,503

WILO4F

ErP

- Circolatore elettronico a velocità variabile (Conforme alla direttiva europea 2009/125/CE - ErP „Energy related Products“).
- Variable speed electronic circulator (In accordance with European Directive 2009/125/CE - ErP “Energy related Products“).
- Circulateur chauffage électronique à vitesse variable (Conforme à la Directive Européenne 2009/125/CE - ErP “Energy related Products“).
- Elektronische Umwälzpumpe mit variabler Geschwindigkeit (Entspricht der Europäischen Richtlinie 2009/125/CE - ErP “Energy related Produkts“).
- Circulador electrónico de velocidad variable (Conforme a la directiva europea 2009/125/CE - ErP „Energy related Products“).

Code	Size	Head loss	Price	Class	Packaging
WILO4F-110	1" - 110 mm	6 m	341,98 €	HK	1 / 4

MUL-C 0032 AC

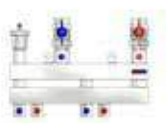

- Collettore principale di distribuzione a 2 vie con separatore idraulico intercettabile per sistema MULTIMIX-C, completo di valvole a sfera e sfiato aria automatico.
- 2-way main distribution manifold with interceptable hydraulic separator for MULTIMIX-C system, complete with ball valves and automatic air vent.
- Collecteur principal de distribution à 2 voies avec séparateur hydraulique interceptable pour système MULTIMIX-C, constitué de vannes à bille et purgeur d'air automatique.
- 2-Wege Hauptmodulverteiler mit hydraulischen Weichen für das MULTIMIX-C System, mit Kugelventilen und automatischem Schnellentlüfter.
- Colector principal de distribución a 2 vías con separador hidráulico para el sistema de MULTIMIX-C, con válvulas de bola y purga automática.

Code	Included Accessories	Ways	Size	Price	Class	Packaging
508153	AC 655 NST + AC 620	2	G 1" F x G 3/4" F	401,73 €	NI	1

MUL-C 0033 AC

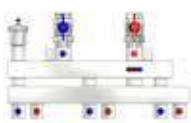

- Collettore principale di distribuzione a 3 vie con separatore idraulico intercettabile per sistema MULTIMIX-C, completo di valvole a sfera e sfiato aria automatico.
- 3-way main distribution manifold with interceptable hydraulic separator for MULTIMIX-C system, complete with ball valves and automatic air vent.
- Collecteur principal de distribution à 3 voies avec séparateur hydraulique interceptable pour système MULTIMIX-C, constitué de vannes à bille et purgeur d'air automatique.
- 3-Wege Hauptmodulverteiler mit hydraulischen Weichen für das MULTIMIX-C System, mit Kugelventilen und automatischem Schnellentlüfter.
- Colector principal de distribución a 3 vías con separador hidráulico para el sistema de MULTIMIX-C, con válvulas de bola y purga automática.

Code	Included Accessories	Ways	Size	Price	Class	Packaging
508154	AC 655 NST + AC 620	3	G 1" F x G 3/4" F	455,01 €	NI	1

MUL-C 10 E



ErP

- Kit di mandata diretta in alta temperatura con/senza pompa elettronica a velocità variabile per sistema MULTIMIX-C.
- High temperature direct flow kit with/without variable speed electronic pump for MULTIMIX-C system.
- Kit d'envoi direct en haute température avec/sans pompe électronique à vitesse variable pour le système MULTIMIX-C.
- Direktversorgungs-Heißwassersatz mit/ohne elektronischer Pumpe mit variabler Geschwindigkeit für das MULTIMIX-C System.
- Kit de envío directo de alta temperatura con/sin bomba electrónica de velocidad variable para sistema MULTIMIX-C.

Code	Pump	Size	Insulation	Price	Class	Packaging
508155		G 3/4" M	-	142,66 €	NI	1
508155I		G 3/4" M	✓	215,83 €	NI	1
508155PE	WILO4F-110	G 3/4" M	-	493,35 €	NI	1
508155PEI	WILO4F-110	G 3/4" M	✓	566,51 €	NI	1

MUL-C 20 E



ErP

- Kit di miscelazione in bassa temperatura con/senza pompa elettronica a velocità variabile per sistema MULTIMIX-C.
- Low temperature mixing kit with/without variable speed electronic pump for MULTIMIX-C system.
- Kit de mélange en basse température complet de pompe électronique à vitesse variable pour système MULTIMIX-C.
- Fußbodenheizungs-Mischersatz mit/ohne elektronischer Pumpe mit variabler Geschwindigkeit für das MULTIMIX-C System.
- Kit de mezcla de baja temperatura con/sin bomba electrónica de velocidad variable para sistema MULTIMIX-C.

Code	Pump	Size	Insulation	Price	Class	Packaging
508156		G 3/4" M	-	338,80 €	NI	1
508156I		G 3/4" M	✓	411,95 €	NI	1
508156PE	WILO4F-110	G 3/4" M	-	689,48 €	NI	1
508156PEI	WILO4F-110	G 3/4" M	✓	762,65 €	NI	1



• T 5011 U >> p. 252,315,396



• RV 01 >> p. 237,241,252,315,362,396

ACM 667



- Valvola di bypass per MULTIMIX-C.
- Bypass valve for MULTIMIX-C.
- Vanne de bypass pour MULTIMIX-C.
- Bypass-Ventil für MULTIMIX-C.
- Válvula de bypass para MULTIMIX-C.

Code	Size	Range	Price	Class	Packaging
508141	3/4"	0,2-0,6 bar	93,21 €	NI	1

ACCESSORIES FOR MULTIMIX - MULTIMIX•C

T 5011 U



- Testa termostatica con comando incorporato e sensore remoto ad immersione.
- Thermostatic head with incorporated control and immersion remote sensor.
- Tête thermostatique avec commande incorporée et capteur à distance à immersion.
- Thermostat-Kopf mit eingebauter Steuerung und Eintauch-Fernfühler.
- Cabeza termostático con mando incorporado y sensor remoto de inmersión.

Code	Size	Range	Length	Price	Class	Packaging
501175U	M30 x 1,5 - 1/2"	30-55 °C	1 m	54,57 €	AA	5 / 40

RV 01



- Servomotore assiale. Compatibile con tutti i vitoni termostatici IVAR.
- Axial motor. Suitable for all IVAR thermostatic inserts.
- Servomoteur axial. Adapté pour tous les inserts thermostatiques IVAR.
- Axial-Stellantrieb. Geeignet für alle Thermostat-Regulievorrichtungen IVAR.
- Servomotor axial. Adecuado para todos los tornillos termostáticos IVAR.

Code	Size	Price	Class	Packaging
501381	M30 x 1,5 - 3-point regulation (230 V AC)	141,88 €	PC	100
501383	M30 x 1,5 - Proportional 0-10 V (24 V AC/DC)	164,60 €	PC	100



- CLIMA-HUB - Regolatore elettronico per impianti di riscaldamento e raffrescamento >>p. 351
- CLIMA-HUB - Electronic controller for heating and cooling systems >>p. 351
- CLIMA-HUB - Régulateur électronique pour systèmes de chauffage et de refroidissement >>p. 351
- CLIMA-HUB - Elektronischer Regler für Heiz- und Kühlsysteme >>p. 351
- CLIMA-HUB - Regulador electrónico para sistemas de calefacción y refrigeración >>p. 351

RA 761



- Raccordo a stringere diritto maschio per tubo multistrato.
- Compression straight male fitting for multilayer pipe.
- Raccord à serrage droit mâle pour tube multicouche.
- Durchgang AG Pressanschluss für Verbundrohr.
- Racor de compresión recto macho para tubo multicapa.

Code	Size	Color	Price	Class	Packaging
500043N	3/4" M x 20/2	■	7,88 €	LA	25 / 200
501361N	3/4" M x 25/2,5	■	12,01 €	LA	25 / 200
500122N	3/4" M x 25/3	■	12,01 €	LA	25 / 100
501084N	3/4" M x 26/3	■	12,01 €	LA	25 / 100
501497N	3/4" M x 32/3	■	19,01 €	LA	15 / 120

RP 731



- Raccordo a stringere diritto maschio per tubo in polietilene.
- Compression straight male fitting for polyethylene pipe.
- Raccord à serrage droit mâle pour tube en polyéthylène.
- Durchgang AG Pressanschluss für Polyäthylenrohr.
- Racor de compresión recto macho para tubo de polietileno.

Code	Size	Color	Price	Class	Packaging
506209N	3/4" M x 20/2,3	■	7,59 €	LA	25 / 200
501051N	3/4" M x 20/2,8	■	7,59 €	LA	25 / 200
501054N	3/4" M x 25/2,3	■	12,07 €	LA	25 / 100
550042N	3/4" M x 25/2,5	■	12,07 €	LA	25 / 200
501052N	3/4" M x 25/3,5	■	12,07 €	LA	25 / 100
501498N	3/4" M x 32/4,4	■	18,33 €	LA	15 / 120

AC 672



- Chiave per montaggio/smontaggio della pompa.
- Wrench for pump installation/removal.
- Clé pour montage/démontage de la pompe.
- Schlüssel für Montage und Demontage der Pumpe.
- Llave para montaje/desmontaje de la bomba.

Code	Size	Price	Class	Packaging
200147	52 mm	57,35 €	NI	1

AC 830



- Cassetta murale ad incasso per collettori e moduli MC / IVAR-SAT / MULTIMIX / MULTIMIX-C con altezza e profondità variabili.
- Wall fitted cabinet for manifolds and MC / IVAR-SAT / MULTIMIX / MULTIMIX-C modules with variable height and depth.
- Cassette murale encastrable pour collecteurs et modules MC / IVAR-SAT / MULTIMIX / MULTIMIX-C avec hauteur et profondeur variables.
- Einbauwandkasten für Verteiler und Module MC / IVAR-SAT / MULTIMIX / MULTIMIX-C mit variabler Höhe und Tiefe.
- Caja mural de empotrar para colectores y modulos MC / IVAR-SAT / MULTIMIX / MULTIMIX-C de altura y profundidad variables.

Code	Height	Width	Depth	Module	Price	Class	Packaging
200089	860-960 mm	500 mm	110-160 mm	2-way Multimix/Multimix-C	309,94 €	NZ	1
200090	860-960 mm	700 mm	110-160 mm	MC 1/11/12/13/14 - MC4 series (1") - IVAR-SAT H/L/LE - 3-way Multimix/Multimix-C	342,76 €	NZ	1
200190	860-960 mm	900 mm	110-160 mm	MC2 series - IVAR-SAT HL/HLE	452,88 €	NZ	1

DIMENSIONS OF MULTIMIX 2-WAY AND 3-WAY MODULES WITH INSULATION INSTALLED IN THE CABINET

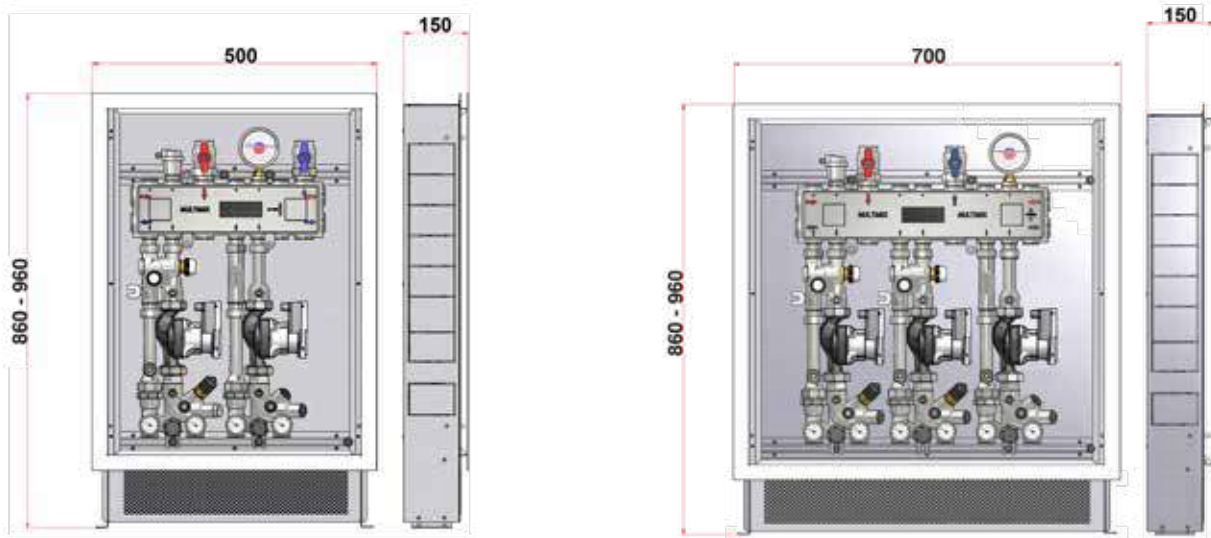

DIMENSIONS OF MULTIMIX 2-WAY AND 3-WAY MODULES WITH INSULATION AND CLIMA-HUB REGULATOR INSTALLED IN THE CABINET

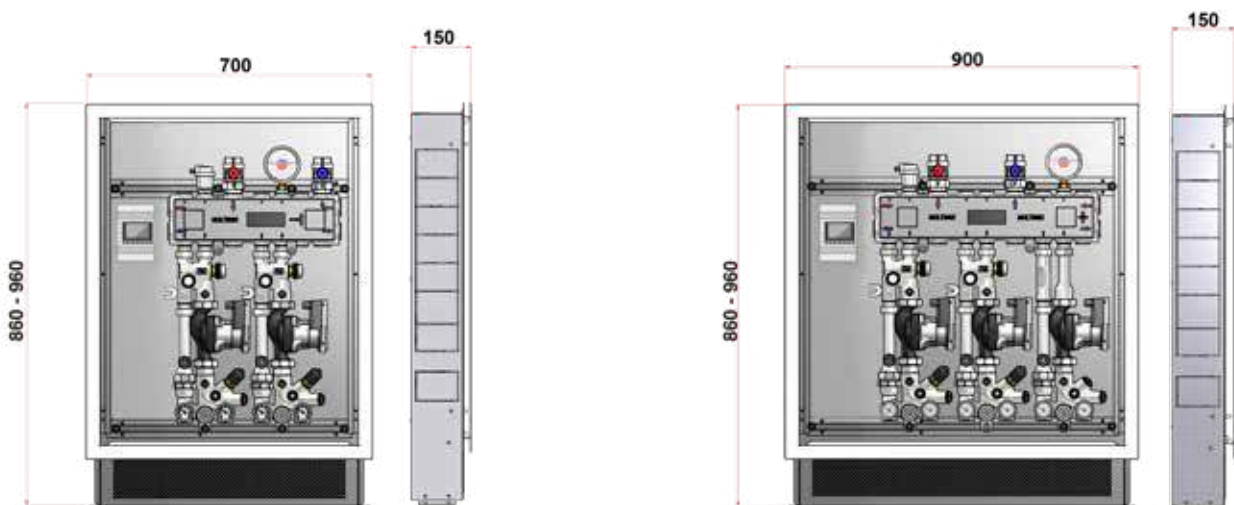

AMUL 01



- Coibentazione per sistema MULTIMIX / MULTIMIX-C.
- Insulation for MULTIMIX / MULTIMIX-C system.
- Isolation pour système MULTIMIX / MULTIMIX-C.
- Isolierung für das MULTIMIX / MULTIMIX-C System.
- Aislamiento para el sistema MULTIMIX / MULTIMIX-C.

Code	Size	Height	Width	Depth	Price	Class	Packaging
506360	1 module	460 mm	280 mm	145 mm	70,01 €	NI	1
506361	2 modules	610 mm	390 mm	145 mm	82,94 €	NI	1
506362	3 modules	575 mm	550 mm	145 mm	102,71 €	NI	1

DIMENSIONS OF MULTIMIX 2-WAY AND 3-WAY MODULES WITH INSULATION ONLY

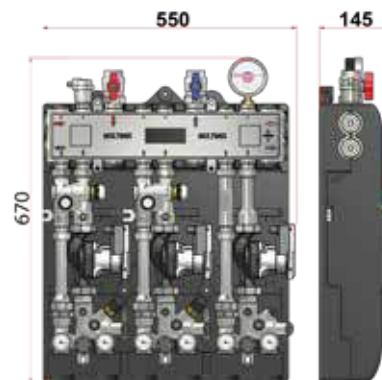
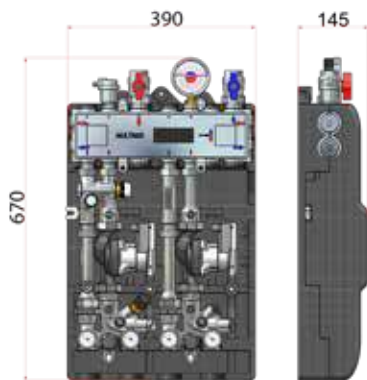

VARIMIX allows a revised design of central heating systems, with a new concept of space and functionality. Thanks to system modularity, it is now possible to construct a dedicated distribution system for a single central heating system, guaranteeing a neat and streamlined design to facilitate the work of the installer.

VARIMIX is essentially made up of the following basic kits to be assembled and configured according to various system demands:

- hydraulic separator (pressure balancer)
- modular manifold
- direct distribution kit
- mixing and distribution kit

Each kit features its own insulation casing in polypropylene designed to reduce heat dispersion.

Given its size and flexibility, VARIMIX is ideal above all for application inside central heating plants in large houses or blocks of flats with at most 5 or 6 different units (depending on the flow rate requirements).

Max. primary flow rate: 4500 l/h

Max. flow rate per kit: 3000 l/h

Example of 3-module VARIMIX distribution in heating/cooling mode.

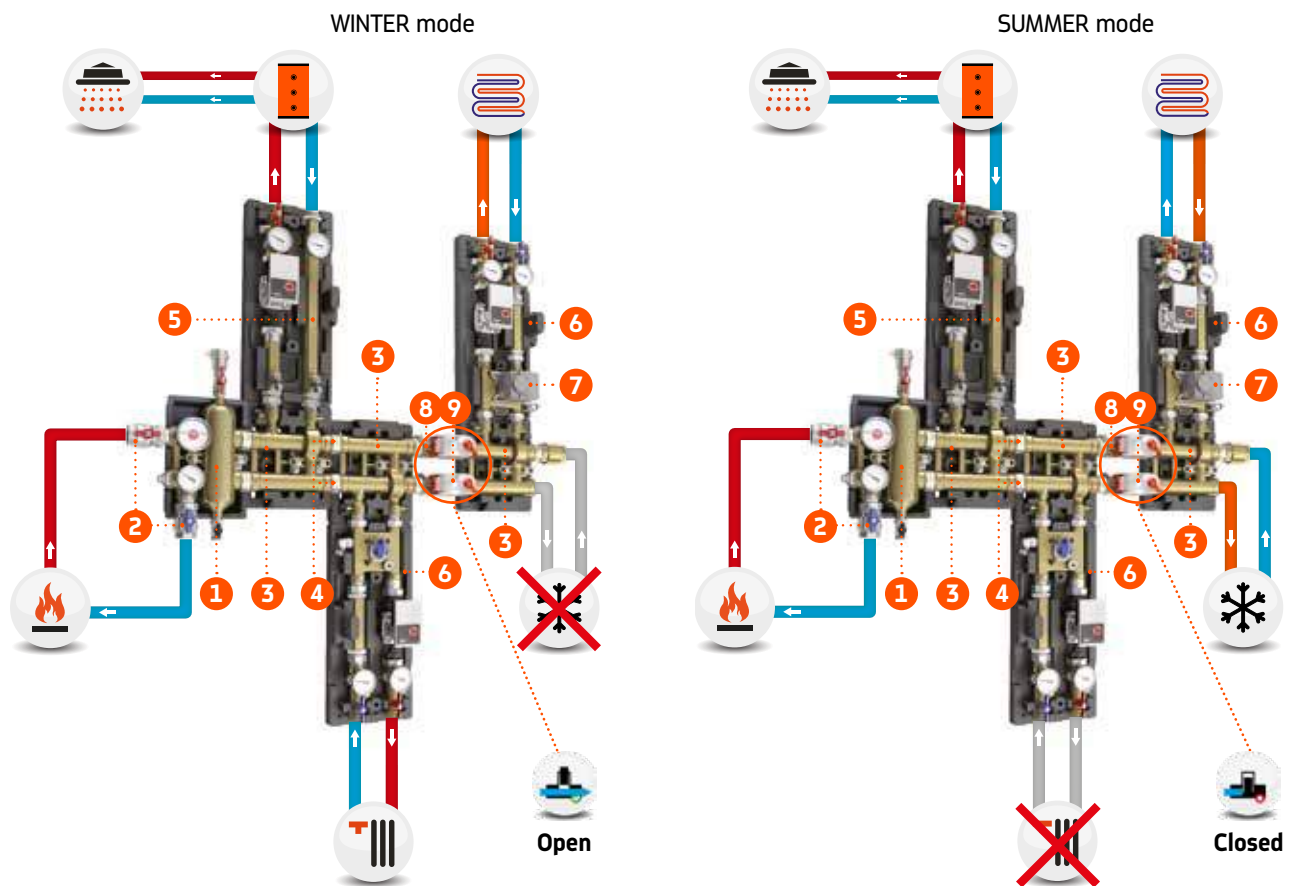

List of components in this VARIMIX application

Number	Code	Item	Quantity
1	550600	VAR 00	1
2	506407	AC 655 NST	1
3	550630	VAR 30	3
4	500387	AC 606	4
5	550610PE	VAR 10	1
6	550621PE	VAR 21	2
7	501648	CTC 20	1
8	506276	AVAR 02	1
9	506243V	AVZS 11	2

HYDRAULIC SEPARATOR

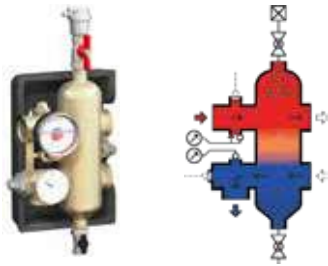

- This enables the hydraulic separation of various circulation pumps installed, keeping the various distribution modules independent.
- Completely reversible: can be supplied from right or left as required.
- Automatic purge valve to remove air bubbles
- Filler/drain valve on base to remove waste and impurities.

MODULAR MANIFOLD

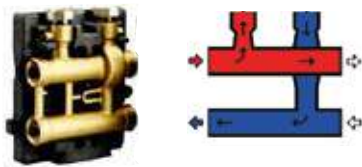

- Enables creation of the main distribution backbone.
- Connection between individual manifolds via rotary nipples.
- Distribution from bottom to top or vice versa, also with option of creating combined configurations.
- Integrated shutoff valves to enable disconnection of distribution module for easier maintenance.

DIRECT DISTRIBUTION KIT

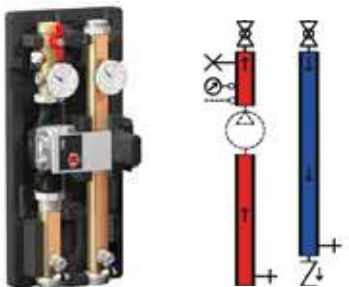

- High-temperature booster module without mixing.
- Used to supply components such as radiators or towel rails or to heat domestic hot water stored in storage tanks.

DISTRIBUTION AND MIXING KIT

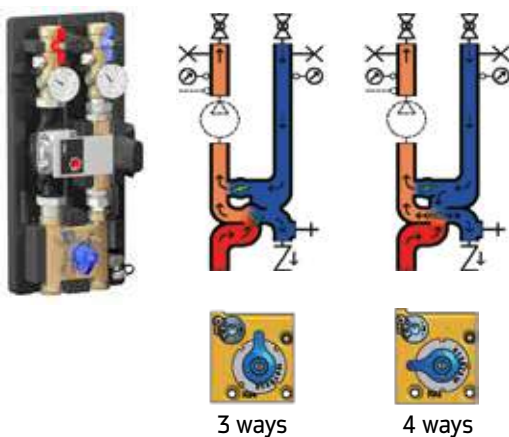

- Distribution module complete with 3 or 4-way sector mixer valves.
- The solution with 4-way mixer valves also enables mixing on return to the boiler, thereby avoiding corrosion phenomena due to acid condensation in older generators.
- Used for distribution to low temperature utilities such as radiant panels for underfloor heating.
- "LT" versions specially designed for applications with low temperature heat sources (e.g. heat pumps)
- Motorised mixer valves for precision control of supply temperature.
- Available in different versions according to the flow factor Kv.

VAR 20 - 21 - 22 - 23



- Kit di miscelazione in bassa temperatura con valvola miscelatrice a 3 o 4 vie per sistema VARIMIX.
- Low temperature mixing kit equipped with 3- or 4-way mixing valve for VARIMIX system.
- Kit de mélange en basse température complet de vanne mélangeuse à 3 ou 4 voies pour système VARIMIX.
- Fußbodenheizungs-Mischersatz mit 3- oder 4-Wege Mischventil für System VARIMIX.
- Kit de mezcla de baja temperatura completo de válvula mezcladora de 3 o 4 vías por sistema VARIMIX.

Code	Bypass	Pump	Ways	Kv	Size	Erp	Price	Class	Packaging
550620	✓		3	4	1"1/4 M	-	551,87 €	NI	1
550621	✓		4	4	1"1/4 M	-	551,87 €	NI	1
550622	✓		4	2	1"1/4 M	-	551,87 €	NI	1
550626	✓		3	8	1"1/4 M	-	551,87 €	NI	1
550620P	✓	WILO3F-180	3	4	1"1/4 M	-	762,70 €	NI	1
550621P	✓	WILO3F-180	4	4	1"1/4 M	-	762,70 €	NI	1
550622P	✓	WILO3F-180	4	2	1"1/4 M	-	762,70 €	NI	1
550626P	✓	WILO3F-180	3	8	1"1/4 M	-	762,70 €	NI	1
550620NB	-		3	4	1"1/4 M	-	540,89 €	NI	1
550621NB	-		4	4	1"1/4 M	-	540,89 €	NI	1
550622NB	-		4	2	1"1/4 M	-	540,89 €	NI	1
550626NB	-		3	8	1"1/4 M	-	540,89 €	NI	1
550620PE	-	WILO4F-180	3	4	1"1/4 M	✓	981,97 €	NI	1
550621PE	-	WILO4F-180	4	4	1"1/4 M	✓	981,97 €	NI	1
550622PE	-	WILO4F-180	4	2	1"1/4 M	✓	981,97 €	NI	1
550626PE	-	WILO4F-180	3	8	1"1/4 M	✓	981,97 €	NI	1

VAR 20 - 21 - 22 - 23 LT



- Kit di miscelazione in bassa temperatura con valvola miscelatrice a 3 o 4 vie per sistema VARIMIX per applicazioni con fonte di calore in bassa temperatura (ad esempio, pompe di calore).
- Low temperature mixing kit equipped with 3- or 4-way mixing valve for VARIMIX system for applications with low temperature heat sources (for example, heat pumps).
- Kit de mélange en basse température complet de vanne mélangeuse à 3 ou 4 voies pour système VARIMIX pour les applications avec source de chaleur à basse température (par exemple les pompes à chaleur).
- Fußbodenheizungs-Mischersatz mit 3- oder 4-Wege Mischventil für System VARIMIX für Niedertemperatur-Wärmequellenanwendungen (z. B. Wärmepumpen).
- Kit de mezcla de baja temperatura completo de válvula mezcladora de 3 o 4 vías por sistema VARIMIX para aplicaciones de fuentes de calor a baja temperatura (p. ej., bombas de calor).

Code	Bypass	Pump	Ways	Kv	Size	Erp	Price	Class	Packaging
550620LT	✓		3	4	1"1/4 M	-	551,87 €	NI	1
550621LT	✓		4	4	1"1/4 M	-	551,87 €	NI	1
550622LT	✓		4	2	1"1/4 M	-	551,87 €	NI	1
550626LT	✓		3	8	1"1/4 M	-	551,87 €	NI	1
550620PLT	✓	WILO3F-180	3	4	1"1/4 M	-	762,70 €	NI	1
550621PLT	✓	WILO3F-180	4	4	1"1/4 M	-	762,70 €	NI	1
550622PLT	✓	WILO3F-180	4	2	1"1/4 M	-	762,70 €	NI	1
550626PLT	✓	WILO3F-180	3	8	1"1/4 M	-	762,70 €	NI	1
550620NBLT	-		3	4	1"1/4 M	-	540,89 €	NI	1
550621NBLT	-		4	4	1"1/4 M	-	540,89 €	NI	1
550622NBLT	-		4	2	1"1/4 M	-	540,89 €	NI	1
550626NBLT	-		3	8	1"1/4 M	-	540,89 €	NI	1
550620PELT	-	WILO4F-180	3	4	1"1/4 M	✓	981,97 €	NI	1
550621PELT	-	WILO4F-180	4	4	1"1/4 M	✓	981,97 €	NI	1
550622PELT	-	WILO4F-180	4	2	1"1/4 M	✓	981,97 €	NI	1
550626PELT	-	WILO4F-180	3	8	1"1/4 M	✓	981,97 €	NI	1

VAR 10

- Kit di mandata diretta in alta temperatura per sistema VARIMIX.
- High temperature direct flow kit for VARIMIX system.
- Kit d'envoi direct en haute température pour système VARIMIX.
- Direktversorgungs-Heißwassersatz für System VARIMIX.
- Kit de envío directo de alta temperatura para el sistema VARIMIX.

Code	Pump	Size	Erp	Price	Class	Packaging
550610		1"1/4 M	-	360,49 €	NI	1
550610P	WILO3F-180	1"1/4 M	-	571,33 €	NI	1
550610PE	WILO4F-180	1"1/4 M	✓	790,59 €	NI	1

VAR 11

- Kit di mandata diretta in alta temperatura con bypass per sistema VARIMIX.
- High temperature direct flow kit with bypass for VARIMIX system.
- Kit d'envoi direct en haute température avec bypass pour système VARIMIX.
- Direktversorgungs-Heißwassersatz mit Bypass für System VARIMIX.
- Kit de envío directo de alta temperatura con bypass para el sistema VARIMIX.

Code	Bypass	Pump	Size	Price	Class	Packaging
550611	✓		1"1/4 M	444,19 €	NI	1
550611P	✓	WILO3F-180	1"1/4 M	655,02 €	NI	1

M 106

- Servomotore per valvole miscelatrici a settore.
- Motor for rotor mixing valves.
- Servomoteur pour vannes mélangeuses à rotor.
- Stellantrieb für Rotor-Mischventile.
- Servomotor para válvulas mezcladoras de rotor.

Code	Size	Price	Class	Packaging
501394	3-point regulation (230 V AC)	167,29 €	PC	1 / 8
501395	Proportional 0-10 V (24 V AC)	337,66 €	PC	8
501396	3-point regulation (24 V AC)	200,34 €	PC	10



- CLIMA-HUB - Regolatore elettronico per impianti di riscaldamento e raffrescamento >>p. 351
- CLIMA-HUB - Electronic controller for heating and cooling systems >>p. 351
- CLIMA-HUB - Régulateur électronique pour systèmes de chauffage et de refroidissement >>p. 351
- CLIMA-HUB - Elektronischer Regler für Heiz- und Kühlsysteme >>p. 351
- CLIMA-HUB - Regulador electrónico para sistemas de calefacción y refrigeración >>p. 351

AVAR 06

- Kit di contabilizzazione del calore per VAR 10 - VAR 11 - VAR 20/21/22/23.
- Heat metering kit for VAR 10 - VAR 11 - VAR 20/21/22/23.
- Kit de comptabilisation de la chaleur pour VAR 10 - VAR 11 - VAR 20/21/22/23.
- Wärmemessung-Kit für VAR 10 - VAR 11 - VAR 20/21/22/23.
- Kit de contabilización del calor para VAR 10 - VAR 11 - VAR 20/21/22/23.

Code	Size	Price	Class	Packaging
KSB0171	G 1"1/4	237,30 €	UA	4



>>p. 504

CTC 20

- Attuatore rotativo con regolatore e sonda incorporati per il controllo a punto fisso delle valvole miscelatrici.
- Revolving actuator with incorporated regulator and probes for fixed point control of mixing valves.
- Actionneur rotatif avec régulateur et sondes incorporés pour le contrôle à point fixe des vannes mélangeuses.
- Drehbar Stellantrieb mit eingebauter Regler und Fühler für festwert Bedingung der Mischventile.
- Actuador rotativo con regulador y sondas incorporados para el control a punto fijo de las válvulas mezcladoras.

Code	Size	Price	Class	Packaging
501648	230 V AC	477,76 €	PC	1

CC 25

- Attuatore rotativo con regolatore e sonda incorporati per controllo climatico delle valvole miscelatrici.
- Revolving actuator with incorporated regulator and probes for climatic control of mixing valves.
- Actionneur rotatif avec régulateur et sondes incorporés pour le contrôle climatique des vannes mélangeuses.
- Drehbar Stellantrieb mit eingebauten Regler und Fühler für klimatisch Bedingung der Mischventile.
- Actuador rotativo con regulador y sondas incorporados para el control climático de las válvulas mezcladoras.

Code	Size	Price	Class	Packaging
501647	230 V AC	949,28 €	PC	1

■ VAR 00



- Separatore idraulico/equilibratore di pressione con termomanometro e valvola di sfogo aria automatica per sistema VARIMIX.
- Hydraulic separator/pressure equalizer with temperature/pressure gauge and automatic air vent valve for VARIMIX system.
- Séparateur hydraulique/équilibrer de pression avec thermomanomètre et purgeur d'air automatique pour système VARIMIX.
- Hydraulische Weiche/Druckausgleicher mit Thermomanometer und automatisch Entlüftungsventil für System VARIMIX.
- Separador hidráulico/equilibrador de presión con medidor de temperatura/presión y válvula automática de purga de aire para el sistema VARIMIX.

Code	Size	Price	Class	Packaging
550600	G 1"1/4 - Q Max 4.500 l/h	376,65 €	NI	1

■ VAR 30



- Collettore modulare di distribuzione per sistema VARIMIX.
- Modular distribution manifold for VARIMIX system.
- Collecteur modulaire de distribution pour système VARIMIX.
- Modul-Verteiler für System VARIMIX.
- Colector modular de distribución para el sistema VARIMIX.

Code	Size	Price	Class	Packaging
550630	G 1"1/4 M - Q Max 4.500 l/h	272,47 €	NI	1

■ AVAR 03



- Coibentazione per VAR 00.
- Insulation for VAR 00.
- Isolement pour VAR 00.
- Isolierung für VAR 00.
- Aislamiento para VAR 00

Code	Price	Class	Packaging
550601	60,90 €	NI	3

■ AVAR 05



- Coibentazione per VAR 10 - VAR 11 - VAR 20/21/22/23.
- Insulation for VAR 10 - VAR 20/21/22/23.
- Isolement pour VAR 10 - VAR 11 - VAR 20/21/22/23.
- Isolierung für VAR 10 - VAR 11 - VAR 20/21/22/23.
- Aislamiento para VAR 10 - VAR 11 - VAR 20/21/22/23.

Code	Price	Class	Packaging
550603	35,57 €	NI	1

■ AC 600



- Tappo maschio.
- Male plug.
- Bouchon mâle.
- AG Verschluss.
- Tapón macho.

Code	Size	Color	Price	Class	Packaging
500904	1"1/4 M	Yellow	5,71 €	NJ	20 / 160
500905	1"1/4 M	Grey	5,82 €	NJ	35 / 140

■ WILO4F



- Circolatore elettronico a velocità variabile (Conforme alla direttiva europea 2009/125/CE - ErP ,Energy related Products').
- Variable speed electronic circulator (In accordance with European Directive 2009/125/CE - ErP "Energy related Products").
- Circulateur chauffage électronique à vitesse variable (Conforme à la Directive Européenne 2009/125/CE - ErP "Energy related Products").
- Elektronische Umwälzpumpe mit variabler Geschwindigkeit (Entspricht der Europaischen Richtlinie 2009/125/CE - ErP "Energy related Produkts").
- Circulador electrónico de velocidad variable (Conforme a la directiva europea 2009/125/CE - ErP ,Energy related Products').

Code	Size	Head loss	Price	Class	Packaging
WILO4F-180	1"1/2 - 180 mm	6 m	336,07 €	HK	3

■ WILO3F



- Circolatore standard a 3 velocità.
- 3-speed standard circulator.
- Circulateur standard à 3 vitesses.
- Umwälzpumpe mit 3 Geschwindigkeitsstufen.
- Circulador estándar de 3 velocidades.

Code	Size	Head loss	Price	Class	Packaging
WILO3F-180	1"1/2 - 180 mm	6 m	230,63 €	HK	1

■ AVAR 04



- Coibentazione per VAR 30.
- Insulation for VAR 30.
- Isolement pour VAR 30.
- Isolierung für VAR 30.
- Aislamiento para VAR 30.

Code	Price	Class	Packaging
550602	27,63 €	NI	1

■ AC 632



- Raccordo sdoppiatore.
- Splitter fitting.
- Raccord dédoubleur.
- Verdoppler-Anschluß.
- Racor doble.

Code	Size	Color	Price	Class	Packaging
550580	1" 1/4 F x 1" M	Yellow / Grey	27,50 €	NI	6 / 48

■ AC 606



- Nipplo girevole maschio - maschio.
- Swivelling male - male nipple.
- Nipple pivotant mâle - mâle.
- AG - AG drehbarer Nippel.
- Enterrerosca giratoria macho - macho.

Code	Size	Color	Price	Class	Packaging
500387	1"1/4 M O-ring x 1"1/4 M O-ring	Yellow	19,93 €	NJ	10 / 40
500387N	1"1/4 M O-ring x 1"1/4 M O-ring	Grey	20,94 €	NJ	10 / 40

AVAR 00

- Kit di connessione per vaso d'espansione per sistema VARIMIX.
- Connection kit for expansion tank for VARIMIX system.
- Kit de connexion pour vase d'expansion pour système VARIMIX.
- Anschluß-Set für Ausdehnungsgefäß für System VARIMIX.
- Kit de conexión para depósito de expansión para sistema VARIMIX.

Code	Price	Class	Packaging
550530	59,01 €	NI	10

AVAR 02

- Kit di zona con valvole on/off motorizzabili e valvola di non ritorno per sistema VARIMIX.
- Zone kit with on/off motorized valves and non-return valve for VARIMIX system.
- Kit de zone avec vannes on/off motorisées et clapet anti-retour pour système VARIMIX.
- Zonen-Bausatz mit ON/OFF motorisierten Ventile und Rückschlagventil für VARIMIX System.
- Kit de zona con válvulas on/off motorizadas y válvula de no retorno para sistema VARIMIX.

Code	Size	Price	Class	Packaging
506276	G 1" 1/4	297,42 €	NI	1

AVZS 00

- Servomotore per valvole di zona a sfera.
- Servo motor for ball zone valves.
- Servomoteur pour vannes de zone à bille.
- Stellantriebe für Zonenkugelventile.
- Servomotor para válvulas de zona de bola.

Code	Size	Price	Class	Packaging
506241	230 V AC - 50 sec.	178,16 €	NN	1

AVZS 10

- Servomotore per valvole di zona a sfera con dispositivo di sblocco.
- Servo motor for ball zone valves with release device.
- Servomoteur pour les vannes de zone à bille avec dispositif de déblocage.
- Stellantriebe für Zonenkugelventile mit Entriegelungsvorrichtung.
- Servomotor para válvulas de zona de bola con dispositivo de desbloqueo.

Code	Size	Price	Class	Packaging
506242	24 V AC - 50 sec.	190,26 €	NN	1
506243	230 V AC - 50 sec.	189,32 €	NN	2 / 8

AVAR 01

- Vaso d'espansione per sistema VARIMIX.
- Expansion tank for VARIMIX system.
- Vase d'expansion pour système VARIMIX.
- Ausdehnungsgefäß für System VARIMIX.
- Depósito de expansión para sistema VARIMIX.

Code	Size	Price	Class	Packaging
180006	18 l	254,82 €	ZC	1

AC 655 NST

- Coppia di valvole a sfera diritte maschio-femmina complete di bocchettone a tenuta morbida, manovra a farfalla.
- Pair of male-female straight ball valves with soft-seal fitting, butterfly operation.
- Set de vannes à bille droites mâle-femelle avec goulotte à étanchéité souple, manoeuvre à papillon.
- Paar Durchgangs-Kugelventil AG-IG mit Selbstdichtensstutzen und Flügelgriff.
- Conjunto de válvulas de bola rectas macho-hembra completas de manguito de unión con junta blanda, vuelta a mariposa.

Code	Size	Color	Price	Class	Packaging
506407	1"1/4	■ / ■	116,88 €	NO	2 / 16

AVZS 01



- Servomotore per valvole di zona a sfera.
- Servo motor for ball zone valves.
- Servomoteur pour vannes de zone à bille.
- Stellantriebe für Zonenkugelventile.
- Servomotor para válvulas de zona de bola.

Code	Size	Price	Class	Packaging
506241V	230 V AC - 25 sec.	188,54 €	NN	1

AVZS 11

- Servomotore per valvole di zona a sfera con dispositivo di sblocco.
- Servo motor for ball zone valves with release device.
- Servomoteur pour les vannes de zone à bille avec dispositif de déblocage.
- Stellantriebe für Zonenkugelventile mit Entriegelungsvorrichtung.
- Servomotor para válvulas de zona de bola con dispositivo de desbloqueo.

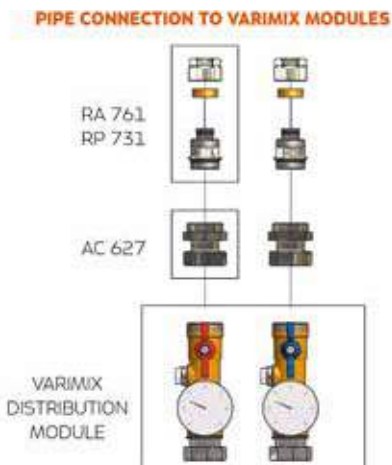
Code	Size	Price	Class	Packaging
506242V	24 V AC - 25 sec.	192,45 €	NN	1
506243V	230 V AC - 25 sec.	190,08 €	NN	1 / 8



AC 627



- Bocchettone ridotto girevole a tenuta morbida.
- Reduced soft seal fitting.
- Embout à étanchéité souple réduite.
- Reduziert Selbstdichtensstutzen.
- Manguito de unión reducido con junta blanda.

Code	Size	Color	Price	Class	Packaging
550551	3/4" F x 1"1/4 F	Yellow	15,21 €	NJ	10 / 80
550552	1" F x 1"1/4 F	Yellow	14,40 €	NJ	10 / 80
550551N	3/4" F x 1"1/4 F	Grey	15,70 €	NJ	10 / 80
550552N	1" F x 1"1/4 F	Grey	14,92 €	NJ	10 / 80

RF 800



- Manicotto femmina - femmina.
- Female-female sleeve.
- Embout femelle - femelle.
- IG x IG Muffe.
- Manguito hembra - hembra.

Code	Size	Color	Price	Class	Packaging
506611	1"1/4 F x 1"1/4 F	Yellow	8,58 €	KA	20 / 80
506611N	1"1/4 F x 1"1/4 F	Grey	9,45 €	KA	20 / 80

RA 761



- Raccordo a stringere diritto maschio per tubo multistrato.
- Compression straight male fitting for multilayer pipe.
- Raccord à serrage droit mâle pour tube multicouche.
- Durchgang AG Pressanschluss für Verbundrohr.
- Racor de compresión recto macho para tubo multicapa.

Code	Size	Color	Price	Class	Packaging
500043	3/4" M x 20/2	Yellow	7,67 €	LA	25 / 100
501361	3/4" M x 25/2,5	Yellow	11,68 €	LA	25 / 200
500122	3/4" M x 25/3	Yellow	11,68 €	LA	25 / 100
501084	3/4" M x 26/3	Yellow	11,68 €	LA	25 / 100
501497	3/4" M x 32/3	Yellow	18,45 €	LA	15 / 120
506489	1" M x 25/2,5	Yellow	12,11 €	LA	15 / 120
506490	1" M x 25/3	Yellow	12,11 €	LA	15 / 120
506057	1" M x 26/3	Yellow	12,11 €	LA	15 / 120
500203	1" M x 32/3	Yellow	15,92 €	LA	10 / 80
500043N	3/4" M x 20/2	Grey	7,88 €	LA	25 / 200
501361N	3/4" M x 25/2,5	Grey	12,01 €	LA	25 / 200
500122N	3/4" M x 25/3	Grey	12,01 €	LA	25 / 100
501084N	3/4" M x 26/3	Grey	12,01 €	LA	25 / 100
501497N	3/4" M x 32/3	Grey	19,01 €	LA	15 / 120
506489N	1" M x 25/2,5	Grey	12,45 €	LA	15 / 120
506490N	1" M x 25/3	Grey	12,45 €	LA	15 / 120
506057N	1" M x 26/3	Grey	12,45 €	LA	15 / 120
500203N	1" M x 32/3	Grey	16,39 €	LA	10 / 80

RP 731



- Raccordo a stringere diritto maschio per tubo in polietilene.
- Compression straight male fitting for polyethylene pipe.
- Raccord à serrage droit mâle pour tube en polyéthylène.
- Durchgang AG Pressanschluss für Polyäthylenrohr.
- Racor de compresión recto macho para tubo de polietileno.

Code	Size	Color	Price	Class	Packaging
506209	3/4" M x 20/2	Yellow	7,37 €	LA	25 / 200
501051	3/4" M x 20/2,8	Yellow	7,37 €	LA	25 / 200
501054	3/4" M x 25/2,3	Yellow	11,72 €	LA	25 / 100
550042	3/4" M x 25/2,5	Yellow	11,72 €	LA	25 / 200
501052	3/4" M x 25/3,5	Yellow	11,72 €	LA	20 / 160
501498	3/4" M x 32/4,4	Yellow	17,80 €	LA	15 / 120
506492	1" M x 25/2,3	Yellow	11,65 €	LA	20 / 160
506493	1" M x 25/2,5	Yellow	11,65 €	LA	20 / 160
991310	1" M x 25/3,5	Yellow	12,17 €	LA	20 / 160
506209N	3/4" M x 20/2,3	Grey	7,59 €	LA	25 / 200
501051N	3/4" M x 20/2,8	Grey	7,59 €	LA	25 / 200
501054N	3/4" M x 25/2,3	Grey	12,07 €	LA	25 / 100
550042N	3/4" M x 25/2,5	Grey	12,07 €	LA	25 / 200
501052N	3/4" M x 25/3,5	Grey	12,07 €	LA	25 / 100
501498N	3/4" M x 32/4,4	Grey	18,33 €	LA	15 / 120
506492N	1" M x 25/2,3	Grey	11,99 €	LA	20 / 160
506493N	1" M x 25/2,5	Grey	11,99 €	LA	20 / 160
991310N	1" M x 25/3,5	Grey	12,54 €	LA	20 / 160

STORAGE TANKS

The storage tank is the thermal inertia of the installation, and can store domestic hot water or "primary" heating water. Domestic hot water is heated and stored in boilers, which support efficient demand management from single users or the condominium's installation. They may be in stainless steel or carbon steel with internally treated surface and with corrosion-proof protection.

Buffer tanks, on the other hand, store heating water, are less delicate than DHW boilers and are suitable for storing energy from a variety of sources and make it available to the heating system and for the production of instant on-demand domestic hot water.

There are also systems that store technical water, but also a more or less plentiful quantity of domestic water: this is the case of "tank-in-tank" systems and systems with large-sized, built-in DHW coil, for „semi-instant" production of DHW.

IVAR offers traditional technical water storage cylinders, with semi-instantaneous coils, thermal vents and solutions for the improvement of temperature stratification; the ran also includes "tank-in-tank" systems and boilers for domestic hot water, also with larger coil for coupling with heat pump.



Adatto per acqua tecnica per riscaldamento.
Suitable for heating water.
Adapté pour de l'eau de chauffage.
Geeignet für Heizwasser.
Adecuado para agua técnica para calefacción.



Integrabile con pompa di calore (serpentino maggiorato).
Integrable with heat pump (larger coil).
Intégré avec la pompe à chaleur (serpentin avec une plus grande surface).
Integrierbar mit Wärmepumpe (Rohrschlange mit vergrößerter Oberfläche).
Integrable con la bomba de calor (serpentin con una mayor superficie).



Adatto per acqua sanitaria.
Suitable for domestic water.
Adapté pour de l'eau sanitaire.
Geeignet für Trinkwasser.
Adecuado para agua sanitaria.



Adatto per acqua tecnica per riscaldamento e refrigerata.
Suitable for heating and cooling water.
Adapté pour de l'eau de chauffage et réfrigérée.
Geeignet für Heizwasser und Kühlwasser.
Adecuado para agua técnica para calefacción y refrigerada.



Integrabile con sistema solare termico.
Integrable with solar thermal system.
Intégré avec système solaire thermique.
Integrierbar mit solarthermischem System.
Integrable con el sistema de energía solar térmica.



WWM



- **Accumulatore con superficie interna trattata per acqua sanitaria, uno scambiatore di calore a serpentino con superficie maggiorata (adatto per la connessione della pompa di calore) e coibentazione in poliuretano.**
- *Storage tank equipped with treated inner surface for domestic water, one coil heat exchanger with larger surface (suitable for heat pump connection) and polyurethane insulation.*
- **Réservoir d'accumulation avec la surface intérieure traitée pour de l'eau sanitaire, un échangeur de chaleur à serpentin avec une plus grande surface (approprié pour le raccordement de la pompe à chaleur) et l'isolation en polyuréthane.**
- *Speicher für Brauchwasser intern behandelt, mit einem Rohrschlange-Wärmetauscher mit vergrößerter Oberfläche (für die Verbindung der Wärmepumpe) und Isolierung aus Polyurethan.*
- **Acumulador con la superficie interior tratada para agua sanitaria, intercambiador de calor de serpentin con una mayor superficie (adecuado para la conexión de la bomba de calor) y aislamiento de poliuretano.**

Code	Size	Efficiency class	Insulation type	Insulation thickness	Price	Class	Packaging
1Y5920D	200 l	C	Injected hard polyurethane	50 mm	On request	Z5	1
1Y5930D	300 l	C	Injected hard polyurethane	50 mm	On request	Z5	1
1Y5940D	400 l	D	Injected hard polyurethane	50 mm	On request	Z5	1
1Y5950D	500 l	D	Injected hard polyurethane	50 mm	On request	Z5	1
1Y59805	800 l		Soft polyurethane	100 mm	On request	Z5	1
1Y59A05	1000 l		Soft polyurethane	100 mm	On request	Z5	1

EPM



- **Accumulatore con superficie interna trattata per acqua sanitaria, 2 scambiatori di calore a serpentino (scambiatore di calore superiore con superficie maggiorata, adatto per la connessione della pompa di calore) e coibentazione in poliuretano.**
- *Storage tank equipped with treated inner surface for domestic water, 2 coil heat exchangers (upper heat exchanger with larger surface, suitable for heat pump connection) and polyurethane insulation.*
- **Réservoir d'accumulation avec la surface intérieure traitée pour de l'eau sanitaire, 2 échangeurs de chaleur à serpentin (échangeur de chaleur supérieur avec une plus grande surface, approprié pour le raccordement de la pompe à chaleur) et l'isolation en polyuréthane.**
- *Speicher für Brauchwasser intern behandelt, mit 2 Rohrschlange-Wärmetauschern vorgerüstet (Wärmetauscher oben mit vergrößerter Oberfläche für die Verbindung der Wärmepumpe) und Isolierung aus Polyurethan.*
- **Acumulador con la superficie interior tratada para agua sanitaria, 2 intercambiadores de calor de serpentin (intercambiador de calor superior con una mayor superficie, adecuado para la conexión de la bomba de calor) y aislamiento de poliuretano.**

Code	Size	Efficiency class	Insulation type	Insulation thickness	Price	Class	Packaging
1Y7830D	300 l	C	Polyester	50 mm	On request	Z5	1
1Y7850D	500 l	D	Polyester	50 mm	On request	Z5	1

VS1

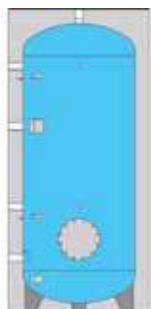

- Accumatore con superficie interna trattata per acqua sanitaria, predisposizione per l'inserimento di uno scambiatore di calore a serpentino estraibile e coibentazione in poliuretano.
- Storage tank equipped with treated inner surface for domestic water, housing for the installation of one removable coil heat exchanger and polyurethane insulation.
- Réservoir d'accumulation avec la surface intérieure traitée pour de l'eau sanitaire, une fente pour l'insertion d'un échangeur de chaleur à serpentin amovible et l'isolation en polyuréthane.
- Speicher für Brauchwasser intern behandelt, für das Einfügen von einem herausziehbarem Rohrschlange-Wärmetauscher vorgerüstet, mit Isolierung aus Polyurethan.
- Acumulador con la superficie interior tratada para agua sanitaria, predisposición para la introducción de un intercambiador de calor de serpentin extraíble y aislamiento de poliuretano.

Code	Size	Efficiency class	Insulation type	Insulation thickness	Price	Class	Packaging
1K09309	300 l	C	Polyester	100 mm	On request	Z5	1
1K09509	500 l	D	Polyester	100 mm	On request	Z5	1
1K09805	800 l		Soft polyurethane	100 mm	On request	Z5	1
1K09A05	1000 l		Soft polyurethane	100 mm	On request	Z5	1
1J09A55	1500 l		Soft polyurethane	100 mm	On request	Z5	1
1J09B05	2000 l		Soft polyurethane	100 mm	On request	Z5	1
1J09C05	3000 l		Soft polyurethane	100 mm	On request	Z5	1
1J09D05	4000 l		Soft polyurethane	100 mm	On request	Z5	1
1J09E05	5000 l		Soft polyurethane	100 mm	On request	Z5	1

VS3

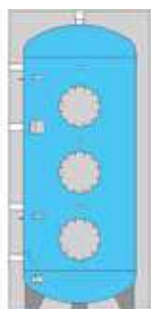

- Accumatore con superficie interna trattata per acqua sanitaria, predisposizione per l'inserimento di 3 scambiatori di calore a serpentino estraibili e coibentazione in poliuretano.
- Storage tank equipped with treated inner surface for domestic water, housings for the installation of 3 removable coil heat exchangers and polyurethane insulation.
- Réservoir d'accumulation avec la surface intérieure traitée pour de l'eau sanitaire, les fentes pour l'insertion de 3 échangeurs de chaleur à serpentin amovibles et l'isolation en polyuréthane.
- Speicher für Brauchwasser intern behandelt, für das Einfügen von 3 herausziehbaren Rohrschlange-Wärmetauschern vorgerüstet, mit Isolierung aus Polyurethan.
- Acumulador con la superficie interior tratada para agua sanitaria, predisposición para la introducción de 3 intercambiadores de calor de serpentin extraíbles y aislamiento de poliuretano.

Code	Size	Insulation type	Insulation thickness	Price	Class	Packaging
1K11805	800 l	Soft polyurethane	100 mm	On request	Z5	1
1K11A05	1000 l	Soft polyurethane	100 mm	On request	Z5	1
1J11A55	1500 l	Soft polyurethane	100 mm	On request	Z5	1
1J11B05	2000 l	Soft polyurethane	100 mm	On request	Z5	1
1J11B55	2500 l	Soft polyurethane	100 mm	On request	Z5	1
1J11C05	3000 l	Soft polyurethane	100 mm	On request	Z5	1
1J11D05	4000 l	Soft polyurethane	100 mm	On request	Z5	1
1J11E05	5000 l	Soft polyurethane	100 mm	On request	Z5	1

IVAR.SR



- Scambiatore di calore a serpentino estraibile in rame alettato stagnato per accumulatori VS.
- Removable finned tin-coated copper coil heat exchanger for VS storage tanks.
- Échangeur de chaleur à serpentin amovible en cuivre étamé avec ailettes pour réservoirs d'accumulation VS.
- Herausziehbar Rohrschlange-Wärmetauscher aus geripptem verzinnem Kupfer für Speicher VS.
- Intercambiador de calor de serpentin extraíble de cobre estañado con aletas para acumuladores VS.

Code	Size	Price	Class	Packaging
4000607	1,21 m ² - 0,7 l	On request	Z5	1
4000608	1,80 m ² - 1,4 l	On request	Z5	1
4000609	2,63 m ² - 2,0 l	On request	Z5	1
4000610	3,20 m ² - 2,5 l	On request	Z5	1
4000611	4,54 m ² - 3,5 l	On request	Z5	1
4000612	6,34 m ² - 5,0 l	On request	Z5	1

AS 4000



- Anodo sacrificale al magnesio o elettronico.
- Magnesium-type or electronic sacrificial anode.
- Anode superficielle au magnésium ou électronique.
- Opferanode mit Magnesium oder Elektronisch.
- Ánodo de sacrificio de magnesio o electrónico.

Code	Size	Price	Class	Packaging
4000200	Electronic - 1/2" - 450 mm	On request	Z5	1
4000201	Electronic - 1/2" - 550 mm	On request	Z5	1
4000202	Mg - 1 1/4" - 400 mm	On request	Z5	1
4000205	Mg - 1 1/4" - 700 mm	On request	Z5	1

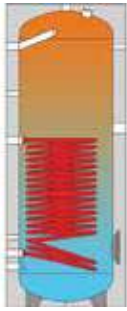
SP

- **Accumulatore con superficie interna trattata per acqua sanitaria, uno scambiatore di calore a serpentino e coibentazione in poliuretano.**
- *Storage tank equipped with treated inner surface for domestic water, one coil heat exchanger and polyurethane insulation.*
- **Réservoir d'accumulation avec la surface intérieure traitée pour de l'eau sanitaire, un échangeur de chaleur à serpentin et l'isolation en polyuréthane.**
- *Speicher für Brauchwasser intern behandelt, mit einem Rohrschlange-Wärmetauscher und Isolierung aus Polyurethan.*
- **Acumulador con la superficie interior tratada para agua sanitaria, intercambiador de calor de serpentin y aislamiento de poliuretano.**

Code	Size	Efficiency class	Insulation type	Insulation thickness	Price	Class	Packaging
1K0115D	150 l	B	Injected hard polyurethane	50 mm	On request	Z5	1
1K0120D	200 l	C	Injected hard polyurethane	50 mm	On request	Z5	1
1K0130D	300 l	C	Injected hard polyurethane	50 mm	On request	Z5	1
1K0140D	400 l	D	Injected hard polyurethane	50 mm	On request	Z5	1
1K0150D	500 l	D	Injected hard polyurethane	50 mm	On request	Z5	1
1K0160D	600 l		Injected hard polyurethane	50 mm	On request	Z5	1
1K0180Z	800 l		Soft polyurethane	100 mm	On request	Z5	1
1K01A0Z	1000 l		Soft polyurethane	100 mm	On request	Z5	1

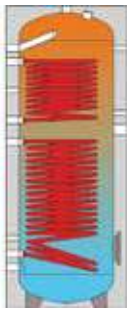
SPS

- **Accumulatore con superficie interna trattata per acqua sanitaria, 2 scambiatori di calore a serpentino e coibentazione in poliuretano.**
- *Storage tank equipped with treated inner surface for domestic water, 2 coil heat exchangers and polyurethane insulation.*
- **Réservoir d'accumulation avec la surface intérieure traitée pour de l'eau sanitaire, 2 échangeurs de chaleur à serpentin et l'isolation en polyuréthane.**
- *Speicher für Brauchwasser intern behandelt, mit 2 Rohrschlange-Wärmetauschern vorgerüstet und Isolierung aus Polyurethan.*
- **Acumulador con la superficie interior tratada para agua sanitaria, 2 intercambiadores de calor de serpentin y aislamiento de poliuretano.**

Code	Size	Efficiency class	Insulation type	Insulation thickness	Price	Class	Packaging
1K0220D	200 l	C	Injected hard polyurethane	50 mm	On request	Z5	1
1K0230D	300 l	C	Injected hard polyurethane	50 mm	On request	Z5	1
1K0240D	400 l	D	Injected hard polyurethane	50 mm	On request	Z5	1
1K0250D	500 l	D	Injected hard polyurethane	50 mm	On request	Z5	1
1K0260D	600 l		Injected hard polyurethane	50 mm	On request	Z5	1
1K0280Z	800 l		Soft polyurethane	100 mm	On request	Z5	1
1K02A0Z	1000 l		Soft polyurethane	100 mm	On request	Z5	1

VSBZDR

- **Valvola a sfera (blu) a tenuta piatta in lega antidezincificazione. Per applicazioni sanitarie.**
- *Flat-seal anticorrosion-brass ball valve (blue). Suitable to domestic water applications.*
- **Vanne à bille (bleue) à étanchéité plate en alliage résistant à la dézincification. Pour des applications sanitaires.**
- *Kugelventil (blau) mit Flachdichtung aus entzinkungsresistenter Legierung. Für Sanitäranwendungen.*
- **Válvula de bola (azul) con junta plana de aleación resistente a la desgalvanización. Para aplicaciones sanitarias.**

Code	Size	Color	Price	Class	Packaging
190099BDZR	3/4" M x 3/4" M		17,96 €	Z6	1

VSRDZR

- **Valvola a sfera (rossa) a tenuta piatta in lega antidezincificazione. Per applicazioni sanitarie.**
- *Flat-seal anticorrosion-brass ball valve (red). Suitable to domestic water applications.*
- **Vanne à bille (rouge) à étanchéité plate en alliage résistant à la dézincification. Pour des applications sanitaires.**
- *Kugelventil (rot) mit Flachdichtung aus entzinkungsresistenter Legierung. Für Sanitäranwendungen.*
- **Válvula de bola (roja) con junta plana de aleación resistente a la desgalvanización. Para aplicaciones sanitarias.**

Code	Size	Color	Price	Class	Packaging
190099RDZR	3/4" M x 3/4" M		17,96 €	Z6	1

PS

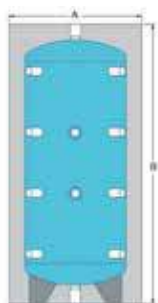

- Accumulatore per acqua tecnica per riscaldamento con coibentazione in poliuretano, senza scambiatori di calore a serpentino.
- Heating water storage tank equipped with polyurethane insulation, with no coil heat exchangers.
- Réservoir d'accumulation pour de l'eau de chauffage avec isolation en polyuréthane, sans échangeurs de chaleur à serpentin.
- Speicher für Heizwasser mit Isolierung aus Polyurethan, ohne Rohrschlange-Wärmetauscher.
- Acumulador para agua técnica para calefacción con aislamiento de poliuretano, sin intercambiadores de calor de serpentin.

Code	Size	Efficiency class	Insulation type	Insulation thickness	Price	Class	Packaging
1V12305	300 l	C	Polyester	100 mm	On request	Z5	1
1V12505	500 l	C	Polyester	100 mm	On request	Z5	1
1V12805	800 l		Soft polyurethane	100 mm	On request	Z5	1
1V12A05	1000 l		Soft polyurethane	100 mm	On request	Z5	1
1V12A35	1250 l		Soft polyurethane	100 mm	On request	Z5	1
1V12A55	1500 l		Soft polyurethane	100 mm	On request	Z5	1
1V12B05	2000 l		Soft polyurethane	100 mm	On request	Z5	1
1V12C05	3000 l		Soft polyurethane	100 mm	On request	Z5	1
1V12D05	4000 l		Soft polyurethane	100 mm	On request	Z5	1
1V12E05	5000 l		Soft polyurethane	100 mm	On request	Z5	1

PSS

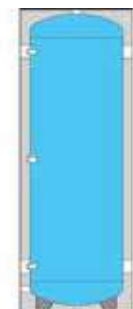

- Accumulatore per acqua tecnica per riscaldamento e refrigerata con coibentazione anticondensa in poliuretano, senza scambiatori di calore a serpentino.
- Heating and cooling water storage tank equipped with anti-condensing polyurethane insulation, with no coil heat exchangers.
- Réservoir d'accumulation pour de l'eau de chauffage et réfrigérée avec isolation spéciale contre la condensation en polyuréthane, sans échangeurs de chaleur à serpentin.
- Speicher für Heizwasser und Kühlwasser mit Antikondensationsisolierung aus Polyurethan, ohne Rohrschlange-Wärmetauscher.
- Acumulador para agua técnica para calefacción y refrigerada con aislamiento de poliuretano, sin intercambiadores de calor de serpentin.

Code	Size	Efficiency class	Insulation type	Insulation thickness	Price	Class	Packaging
1V1905D	50 l	B	Injected hard polyurethane	50 mm	On request	Z5	1
1V1910D	100 l	B	Injected hard polyurethane	50 mm	On request	Z5	1
1V1920D	200 l	C	Injected hard polyurethane	50 mm	On request	Z5	1
1V1930D	300 l	C	Injected hard polyurethane	50 mm	On request	Z5	1
1V1950D	500 l	D	Injected hard polyurethane	50 mm	On request	Z5	1
1V19801	800 l		PEXL	30 mm	On request	Z5	1
1V19A01	1000 l		PEXL	30 mm	On request	Z5	1

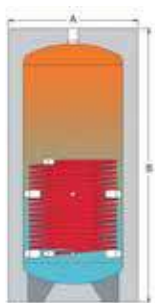
PSR

- **Accumulatore per acqua tecnica con uno scambiatore di calore a serpentino e coibentazione in poliuretano.**
- *Heating water storage tank equipped with one coil heat exchanger and polyurethane insulation.*
- **Réservoir d'accumulation pour de l'eau de chauffage avec un échangeur de chaleur à serpentin et l'isolation en polyuréthane.**
- *Speicher für Heizwasser mit einem Rohrschlange-Wärmetauscher und Isolierung aus Polyurethan.*
- **Acumulador para agua técnica con un intercambiador de calor de serpentin y aislamiento de poliuretano.**

Code	Size	Efficiency class	Insulation type	Insulation thickness	Price	Class	Packaging
1V13305	300 l	C	Polyester	100 mm	On request	Z5	1
1V13505	500 l	C	Polyester	100 mm	On request	Z5	1
1V13805	800 l		Soft polyurethane	100 mm	On request	Z5	1
1V13A05	1000 l		Soft polyurethane	100 mm	On request	Z5	1
1V13A35	1250 l		Soft polyurethane	100 mm	On request	Z5	1
1V13A55	1500 l		Soft polyurethane	100 mm	On request	Z5	1
1V13B05	2000 l		Soft polyurethane	100 mm	On request	Z5	1
1V13C05	3000 l		Soft polyurethane	100 mm	On request	Z5	1
1V13D05	4000 l		Soft polyurethane	100 mm	On request	Z5	1
1V13E05	5000 l		Soft polyurethane	100 mm	On request	Z5	1

PSRR

- **Accumulatore per acqua tecnica con 2 scambiatori di calore a serpentino e coibentazione in poliuretano.**
- *Heating water storage tank equipped with 2 coil heat exchangers and polyurethane insulation.*
- **Réservoir d'accumulation pour de l'eau de chauffage avec 2 échangeurs de chaleur à serpentin et l'isolation en polyuréthane.**
- *Speicher für Heizwasser mit 2 Rohrschlange-Wärmetauschern und Isolierung aus Polyurethan.*
- **Acumulador para agua técnica con 2 intercambiadores de calor de serpentin y aislamiento de poliuretano.**

Code	Size	Efficiency class	Insulation type	Insulation thickness	Price	Class	Packaging
1V54505	500 l	C	Polyester	100 mm	On request	Z5	1
1V54805	800 l		Soft polyurethane	100 mm	On request	Z5	1
1V54A05	1000 l		Soft polyurethane	100 mm	On request	Z5	1
1V54A35	1250 l		Soft polyurethane	100 mm	On request	Z5	1
1V54A55	1500 l		Soft polyurethane	100 mm	On request	Z5	1

BSF

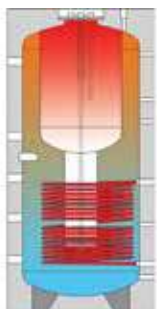

- Accumulatore "Tank-in-tank" per acqua tecnica con uno scambiatore di calore a serpentino, serbatoio speciale per la produzione di acqua calda sanitaria e coibentazione in poliuretano.
- "Tank-in-tank" heating water storage tank equipped with one coil heat exchanger, special tank for domestic hot water preparation and polyurethane insulation.
- Réservoir d'accumulation «Tank in tank» pour de l'eau de chauffage avec un échangeur de chaleur à serpentin, un réservoir spécial pour la production d'eau chaude sanitaire et l'isolation en polyuréthane.
- Speicher für Heizwasser „Tank-in-tank“ mit einem Rohrschlange-Wärmetauscher, einem speziellen Tank für Trinkwarmwasseraufbereitung und Isolierung aus Polyurethan.
- Acumulador para agua técnica "Tank-in-tank" con un intercambiador de calor de serpentin, un tanque especial para la producción de agua caliente sanitaria y aislamiento de poliuretano.

Code	Size	Insulation type	Insulation thickness	Price	Class	Packaging
1K04605	600 l	Soft polyurethane	100 mm	On request	Z5	1
1K04755	750 l	Soft polyurethane	100 mm	On request	Z5	1
1K04A05	1000 l	Soft polyurethane	100 mm	On request	Z5	1
1K04A55	1500 l	Soft polyurethane	100 mm	On request	Z5	1
1K04B05	2000 l	Soft polyurethane	100 mm	On request	Z5	1

BSF2S

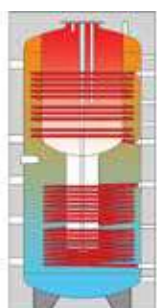

- Accumulatore "Tank-in-tank" per acqua tecnica con 2 scambiatori di calore a serpentino, serbatoio speciale per la produzione di acqua calda sanitaria e coibentazione in poliuretano.
- "Tank-in-tank" heating water storage tank equipped with 2 coil heat exchangers, special tank for domestic hot water preparation and polyurethane insulation.
- Réservoir d'accumulation «Tank in tank» pour de l'eau de chauffage avec 2 échangeurs de chaleur à serpentin, un réservoir spécial pour la production d'eau chaude sanitaire et l'isolation en polyuréthane.
- Speicher für Heizwasser „Tank-in-tank“ mit 2 Rohrschlange-Wärmetauschern, einem speziellen Tank für Trinkwarmwasseraufbereitung und Isolierung aus Polyurethan.
- Acumulador para agua técnica "Tank-in-tank" con 2 intercambiadores de calor de serpentin, un tanque especial para la producción de agua caliente sanitaria y aislamiento de poliuretano.

Code	Size	Insulation type	Insulation thickness	Price	Class	Packaging
1K53605	600 l	Soft polyurethane	100 mm	On request	Z5	1
1K53755	750 l	Soft polyurethane	100 mm	On request	Z5	1
1K53A05	1000 l	Soft polyurethane	100 mm	On request	Z5	1
1K53A55	1500 l	Soft polyurethane	100 mm	On request	Z5	1
1K53B05	2000 l	Soft polyurethane	100 mm	On request	Z5	1

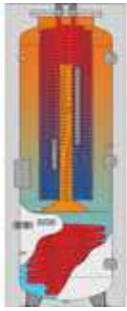
TT

- **Accumulatori a stratificazione termica per acqua tecnica da riscaldamento con scambiatore di calore a serpentino, camino termico, scambiatore di calore per la produzione semi-istantanea di acqua calda sanitaria, attacchi per la connessione del gruppo di circolazione solare e coibentazione in poliuretano.**
- *Thermal stratification storage tank for heating water equipped with coil heat exchanger, thermal chimney, heat exchanger for domestic hot water semi-instantaneous preparation, joints for solar circulation group connection and polyurethane insulation.*
- **Réservoir d'accumulation à stratification thermique pour de l'eau de chauffage avec un échangeur de chaleur à serpentin, cheminée thermique, échangeur de chaleur pour la production semi-instantanée d'eau chaude sanitaire, embouts pour la connexion du groupe de circulation solaire et isolation en polyuréthane.**
- *Speicher für Heizwasser mit thermischer Schichtung, einem Rohrschlange-Wärmetauscher, Thermokamin, Wärmetauscher für halb- augenblicklich Trinkwarmwasseraufbereitung, Anschlüsse für die Verbindung von Solarzirkulationseinheit und Isolierung aus Polyurethan.*
- **Acumulador de estratificación térmica para agua técnica de calefacción con un intercambiador de calor de serpentin, chimenea térmica, intercambiador de calor para la producción semi-instantánea de agua caliente sanitaria, predisposición para la conexión del grupo de circulación solar y aislamiento de poliuretano.**

Code	Size	Efficiency class	Insulation type	Insulation thickness	Price	Class	Packaging
1V5730DSTT3	300 l	C	Injected hard polyurethane	50 mm	On request	Z5	1
1V5750DSTT4	500 l	D	Injected hard polyurethane	50 mm	On request	Z5	1

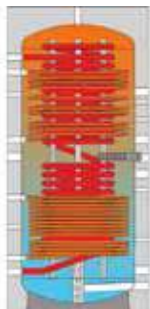
TSP

- **Accumulatore per acqua tecnica con 2 scambiatori di calore a serpentino, scambiatore di calore integrato per la produzione semi-istantanea di acqua calda sanitaria e coibentazione in poliuretano.**
- *Heating water storage tank equipped with 2 coil heat exchangers, integrated heat exchanger for domestic hot water semi- instantaneous preparation and polyurethane insulation.*
- **Réservoir d'accumulation pour de l'eau de chauffage avec 2 échangeurs de chaleur à serpentin, échangeur de chaleur intégré pour la production semi-instantanée d'eau chaude sanitaire et l'isolation en polyuréthane.**
- *Speicher für Heizwasser mit 2 Rohrschlange-Wärmetauschern, integriertem Wärmetauscher für halb- augenblicklich Trinkwarmwasseraufbereitung und Isolierung aus Polyurethan.*
- **Acumulador para agua técnica con 2 intercambiadores de calor de serpentin, intercambiador de calor para la producción semi- instantánea de agua caliente sanitaria y aislamiento de poliuretano.**

Code	Size	Insulation type	Insulation thickness	Price	Class	Packaging
1VD5585	580 l	Soft polyurethane	100 mm	On request	Z5	1
1VD5805	800 l	Soft polyurethane	100 mm	On request	Z5	1
1VD5A05	1000 l	Soft polyurethane	100 mm	On request	Z5	1
1VD5A35	1250 l	Soft polyurethane	100 mm	On request	Z5	1
1VD5A55	1500 l	Soft polyurethane	100 mm	On request	Z5	1
1VD5B05	2000 l	Soft polyurethane	100 mm	On request	Z5	1

VEARS

- **Vaso di espansione per acqua tecnica/accumulo sanitario.**
- *Expansion tank for technical/domestic water storage tank.*
- **Vase d'expansion pour de l'eau technique/ réservoir d'accumulation sanitaire.**
- *Expansionsgefäß für technisches Wasser/Speicher für Trinkwasser.*
- **Vaso de expansión para agua técnica/acumulación sanitaria.**

Code	Size	Height	Price	Class	Packaging
VEARS5	5 l - Ø155 mm - G 3/4"	300 mm	49,49 €	ZC	1
VEARS8	8 l - Ø195 mm - G 3/4"	325 mm	56,95 €	ZC	1
VEARS15	15 l - Ø260 mm - G 3/4"	360 mm	67,12 €	ZC	1
VEARS20	20 l - Ø260 mm - G 3/4"	420 mm	70,96 €	ZC	1
VEARS24	24 l - Ø295 mm - G 3/4"	420 mm	76,39 €	ZC	1
VEARS33	33 l - Ø365 mm - G 3/4"	415 mm	102,83 €	ZC	1
VEARS50	50 l - Ø370 mm - G 3/4" - 1"	625 mm	161,59 €	ZC	1
VEARS60	60 l - Ø415 mm - G 3/4" - 1"	580 mm	185,09 €	ZC	1
VEARS80	80 l - Ø460 mm - G 1"	645 mm	217,64 €	ZC	1
VEARS100	100 l - Ø460 mm - G 1"	765 mm	268,94 €	ZC	1
VEARS150	150 l - Ø500 mm - G 1"	800 mm	430,76 €	ZC	1
VEARS200	200 l - Ø600 mm - G 1"	912 mm	596,41 €	ZC	1
VEARS300	300 l - Ø650 mm - G 1"	1.110 mm	832,13 €	ZC	1

RE SOL

- **Resistenza elettrica per integrazione in acciaio inox. Attacco 1"1/2.**
- *Stainless-steel backing electrical resistance. 1"1/2 connection.*
- **Résistance électrique pour l'intégration en acier inox. Raccord 1»1/2.**
- *Elektrischer Widerstand für Integration aus Edelstahl mit 1"1/2 Anschluss.*
- **Resistencia eléctrica para integración de acero inoxidable. Conexión 1"1/2.**

Code	Size	Price	Class	Packaging
REM1	1,5 kW - 230 V - Single-phase	On request	Z5	1
REM3	3 kW - 230 V - Single-phase	On request	Z5	1
RET3	3 kW - 400 V - 3-phase	On request	Z5	1
RET4	4,5 kW - 400 V - 3-phase	On request	Z5	1
RET6	6 kW - 400 V - 3-phase	On request	Z5	1
RET7	7,5 kW - 400 V - 3-phase	On request	Z5	1
RET9	9 kW - 400 V - 3-phase	On request	Z5	1

MIXING VALVES FOR HIGH FLOW CAPACITY

The 3-way axial mixing valve (DN 32) is designed to mix hot and cold water in systems with high flow rates. In fact, its carefully designed internal geometry makes it possible to achieve extremely high flow rates, with a nearly 13 Kv value. This characteristic makes this type of valve suitable for various applications, including:

- the adjustment of the temperature in the primary branch of an instant domestic water heater connected to a solar battery (fig. 1);
- the reduction of the temperature of the fluid returning to the boiler (fig. 2).

Equipped with a thermostatic head screw, it is designed for both fixed point adjustment by means of a thermostatic actuator and climate control by means of an axial servomotor.

The same valve can be used in diverter mode. In this case, the fluid enters through port AB and flows either towards B (fig. 3) or towards A (fig. 4). One possible use is installation of the valve upline of a storage tank and on the basis of the fluid temperature, the water is diverted into the upper or lower part of the same to encourage stratification of the water on the basis of the temperature.

Actuation is performed by an on/off electrothermic head.

Operation in mixing mode

Fig. 1

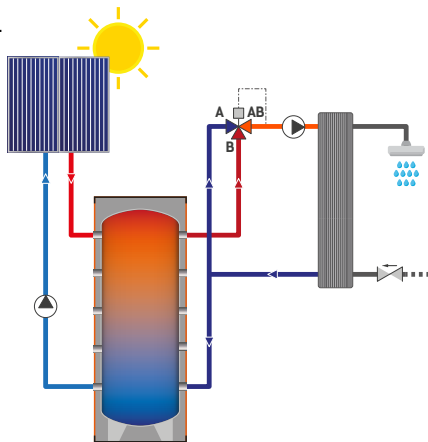
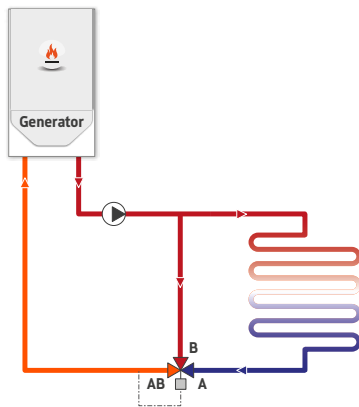

Fig. 2



Operation in diverter mode

Fig. 3

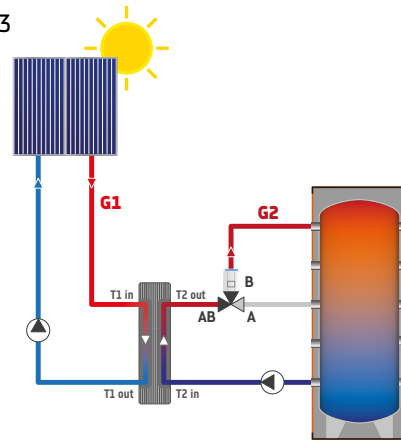
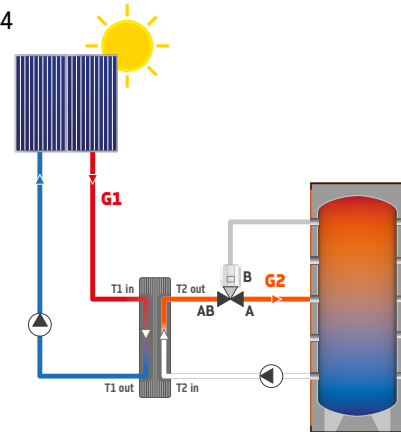

Fig. 4



MR 22



- Valvola miscelatrice assiale termostattizzabile per elevate portate con attacco femmina.
- Thermostatic axial mixing valve for high flow capacity with female connection.
- Vanne mélangeuse axiale thermostatisable pour débit élevé avec embout femelle.
- Axial Thermostat-Mischventil für erhöhte Durchfluss mit IG Anschluß.
- Válvula mezcladora axiale termostatzable para caudales elevados con conexión hembra.

Code	Size	Price	Class	Packaging
501578	DN 32	214,61 €	PA	1 / 12



• T 5011 >> p. 237,240



• T 5012 >> p. 237

MR 32



- Valvola miscelatrice assiale termostattizzabile per elevate portate con bocchettoni a tenuta morbida.
- Thermostatic axial mixing valve for high flow capacity with soft seal fittings.
- Vanne mélangeuse axiale thermostatisable pour débit élevé avec goulottes à étanchéité souple.
- Axial Thermostat-Mischventil für erhöhte Durchfluss mit Stutzen mit O-Ring.
- Válvula mezcladora axiale termostatzable para caudales elevados con manguito de unión con junta blanda

Code	Size	Price	Class	Packaging
501579	DN 32	297,48 €	PA	1 / 8



• RV 01 >> p. 237,241,252,315,362,396



• TE 3061 >> p. 237,241,361

THERMOSTATIC MIXING VALVES

The valves in this section are piston mixers controlled by an external thermostatic actuator, equipped with a remote probe (T 5011 / T 5012,) or motorized for modulating regulation by means of RV 01 motors or TE 3061 electrothermal actuator. The only difference between MR 02 and MR 03 is the position of the ways (+; -; MIX) making easier their use in several situations. MR 01, instead, is specially constructed for specific use in mixing systems for radiant systems. In these cases, its function is not precisely that of a mixer but substantially that of a 2-way thermostatic valve with open bypass on return from the radiant circuit. The flow inlet in this bypass is adjusted by means of AC 662 (see FLOORMIX).

MR 01



- Valvola miscelatrice termostattizzabile a miscelazione laterale e terza via in bypass.
- Thermostatic mixing valves with lateral mixer and bypass in the 3rd way
- Vanne mélangeuse thermostatisable à mélange latéral et troisième voie en bypass
- Regelbares Thermostat-Mischventil mit seitlicher Mischung und drittem Bypass-Weg
- Válvula mezcladora termostattizable con mezclado lateral y tercera vía en bypass.

Code	Kv	Size	Price	Class	Packaging
501420	3.30	1" F x 1" F x 1" F	68,04 €	PA	2 / 32



MR 02



- Valvola miscelatrice termostattizzabile con miscelazione sulla terza via.
- Thermostatic mixing valves with mixer in the 3rd way
- Vanne mélangeuse thermostatisable avec mélange sur la troisième voie
- Thermostat-Mischventil mit Mischung im dritten Weg
- Válvula mezcladora termostattizable con mezclado en la tercera vía.

Code	Kv	Size	Price	Class	Packaging
501421	3	1" F x 1" F x 1" F	68,04 €	PA	2 / 32

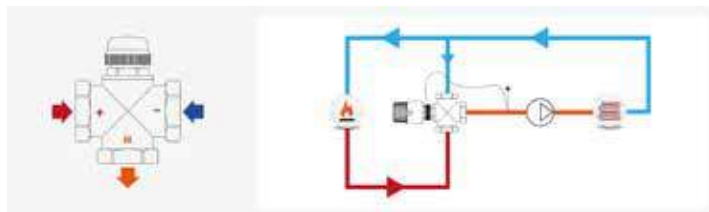

MR 03



- Valvola miscelatrice termostattizzabile con miscelazione laterale.
- Thermostatic mixing valves with lateral mixer
- Vanne mélangeuse thermostatisable avec mélange latéral
- Thermostat-Mischventil mit seitlicher Mischung
- Válvula mezcladora termostattizable con mezclado lateral.

Code	Kv	Size	Price	Class	Packaging
501422	2.70	1" F x 1" F x 1" F	68,04 €	PA	2 / 32

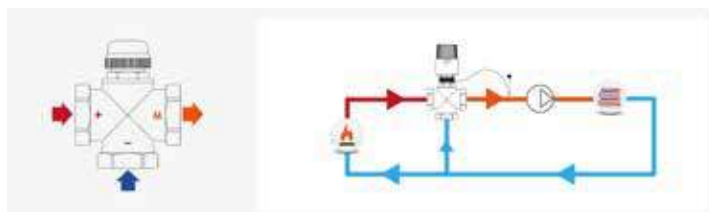

ROTOR MIXING VALVES

SECTOR MIXER VALVES

The sector mixing valves are used in heating/cooling systems in classic mixing and distribution applications. Control of these valves is along a 90° rotation stroke, and can be performed manually or automatically by applying a suitable servomotor.

3-way valves

The 3-way valve (Figures 1 a-b-c) features a shutter, which on opening of an inlet activates closing of the other, and vice versa. Both ways are thus dynamically controlled.

With respect to the mixing by means of a 2-way valve, the 3-way valve offers the option of automatic closure of one or the other way, adapting to the characteristics of the generator and the system load.

4-way valves

The 4-way valves (Figures 2 a-b-c) enable not only mixing of the flow distributed to utilities, but also the return to the boiler. This enables a higher temperature on return to the boiler, extending the useful lifetime of certain types of boiler: on older conventional generators, indeed, a low return temperature can cause damage; water vapour condensate, due to a cool return, is also accompanied by a series of chemical products that make the condensate acidic, which is corrosive to materials used to make traditional boilers.

On the contrary, in the case of modern condensing boilers, the need for a cool return to exploit the water vapour condensate in the flue and thus improve performance of the generator would make the use of 3-way valves ideal (Figure 3a).

With 4-way valves, two pumps need to be installed to obtain mixing on the return line (Figure 3b).

Materials

Valve body: CW617N (for sizes up to 1 1/4" BSP); CB753S (for 1 1/2" and 2" BSP)

Rotor and other components in brass: CW617N

Parts in rubber: peroxide EPDM

Technical specifications

Max. fluid temperature inside valve: 120 °C

Maximum operating pressure: 10 bar

Min. actuation torque: 1 N·m

Leakage percentage: 0.5 % of Kvs

⊕ PLUS

- Minimal risk of sticking between rotor and body in the event of extended inactivity
- Much lower weight and reduced dimensions in proportion to strength compared to traditional valves in cast iron
- Seal on rotor piston ensured by 2 large section O-rings
- External O-ring easily replaced when necessary
- Plate with graduated scale, easily removable and rotated to adapt travel to selected configuration of inputs/outputs
- Different Kv values for the same size, to enable more targeted use according to system requirements

FOCUS: Three- and four-way mixing

3-way valves

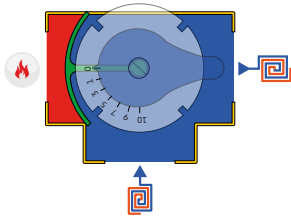

Figure 1 (a)

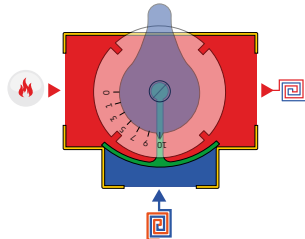

Figure 1 (b)

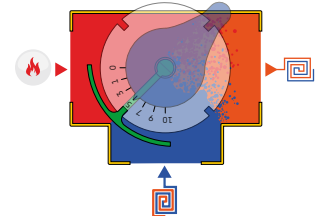

Figure 1 (c)

4-way valves

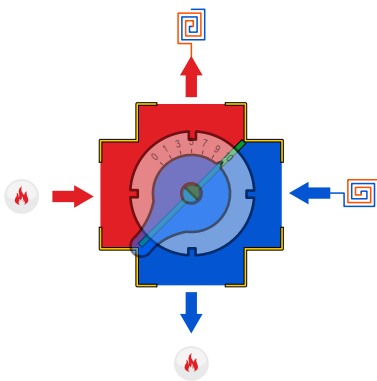

Figure 2 (a)

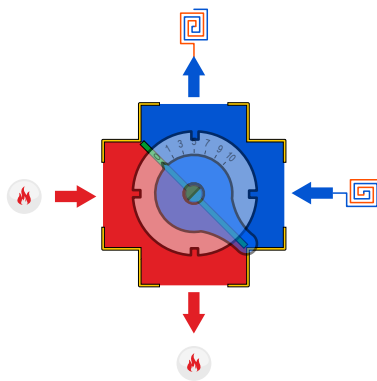

Figure 2 (b)

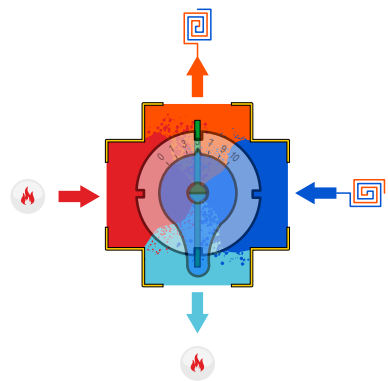

Figure 2 (c)

Diagram of 4-way mixing valve completely open (a), completely closed (b) and in intermediate position (c)

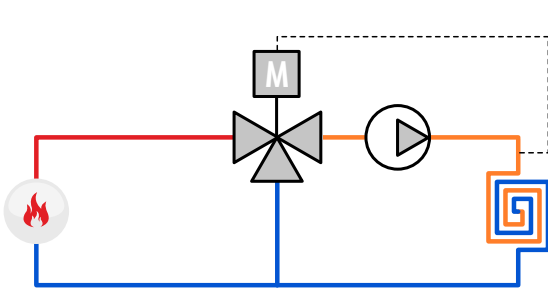

Figure 3 (a)

Circuit with 3-way valve: one pump is sufficient.

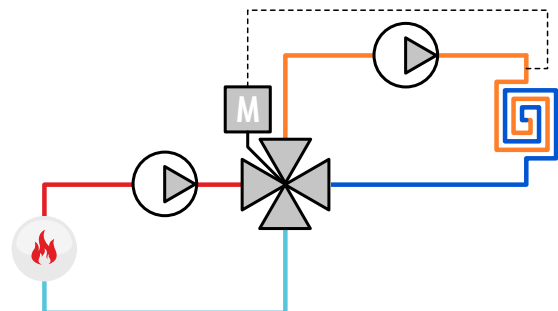

Figure 3 (b)

Circuit with 4-way valve: 2 pumps are required.

MIX 3W



- Valvola miscelatrice a settore a 3 vie.
- 3-way rotor mixing valve.
- Vanne mélangeuse à rotor à 3 voies.
- 3-Wege Rotor-Mischventil.
- Válvula mezcladora de rotor de 3 vías.

Code	Kv	Size	Price	Class	Packaging
501547	4	3/4"	62,14 €	PA	1 / 16
501548	6	3/4"	62,14 €	PA	1 / 16
501549	8	3/4"	62,14 €	PA	1 / 16
501550	8	1"	55,10 €	PA	1 / 16
501551	12	1"	55,10 €	PA	1 / 16
501552	12	1"1/4	61,02 €	PA	1 / 16
501553	18	1"1/4	61,02 €	PA	1 / 16
501564	28	1"1/2	176,83 €	PA	1 / 6
501565	44	2"	176,83 €	PA	1 / 6

MIX 4W



- Valvola miscelatrice a settore a 4 vie.
- 4-way rotor mixing valve.
- Vanne mélangeuse à rotor à 4 voies.
- 4-Wege Rotor-Mischventil.
- Válvula mezcladora de rotor de 4 vías.

Code	Kv	Size	Price	Class	Packaging
501554	4	3/4"	66,33 €	PA	1 / 16
501555	6	3/4"	66,33 €	PA	1 / 16
501556	8	3/4"	66,33 €	PA	1 / 16
501557	8	1"	59,21 €	PA	1 / 16
501558	12	1"	59,21 €	PA	1 / 16
501559	12	1"1/4	64,65 €	PA	1 / 16
501560	18	1"1/4	64,65 €	PA	1 / 16
501562	28	1"1/2	191,99 €	PA	1 / 6
501563	44	2"	191,99 €	PA	1 / 6

AMIX 01



- Manopola blu con vite per valvole miscelatrici a settore.
- Blu hand knob with screw for rotor mixing valves.
- Poignée bleue avec vis pour vannes mélangeuses à rotor.
- Blauer Drehknopf mit Schraube für Rotor-Mischventile.
- Mando azul con tornillo para válvulas mezcladoras de rotor.

Code	Price	Class	Packaging
501570	2,029 €	PC	1

M 106



- Servomotore per valvole miscelatrici a settore.
- Motor for rotor mixing valves.
- Servomoteur pour vannes mélangeuses à rotor.
- Stellantrieb für Rotor-Mischventile.
- Servomotor para válvulas mezcladoras de rotor.

Code	Size	Price	Class	Packaging
501394	3-point regulation (230 V AC)	167,29 €	PC	1 / 8
501395	Proportional 0-10 V (24 V AC)	337,66 €	PC	8
501396	3-point regulation (24 V AC)	200,34 €	PC	10

- CLIMA•HUB - Regolatore elettronico per impianti di riscaldamento e raffreddamento >>p. 351
- CLIMA•HUB - Electronic controller for heating and cooling systems >>p. 351
- CLIMA•HUB - Régulateur électronique pour systèmes de chauffage et de refroidissement >>p. 351
- CLIMA•HUB - Elektronischer Regler für Heiz- und Kühlsysteme >>p. 351
- CLIMA•HUB - Regulador electrónico para sistemas de calefacción y refrigeración >>p. 351

CTC 20



- Attuatore rotativo con regolatore e sonda incorporati per il controllo a punto fisso delle valvole miscelatrici.
- Revolving actuator with incorporated regulator and probes for fixed point control of mixing valves.
- Actionneur rotatif avec régulateur et sondes incorporés pour le contrôle à point fixe des vannes mélangeuses.
- Drehbar Stellantrieb mit eingebauter Regler und Fühler für festwert Bedingung der Mischventile.
- Actuador rotativo con regulador y sondas incorporados para el control a punto fijo de las válvulas mezcladoras.

Code	Size	Price	Class	Packaging
501648	230 V AC	477,76 €	PC	1

CC 25



- Attuatore rotativo con regolatore e sonda incorporati per controllo climatico delle valvole miscelatrici.
- Revolving actuator with incorporated regulator and probes for climatic control of mixing valves.
- Actionneur rotatif avec régulateur et sondes incorporés pour le contrôle climatique des vannes mélangeuses.
- Drehbar Stellantrieb mit eingebauten Regler und Fühler für klimatisch Bedingung der Mischventile.
- Actuador rotativo con regulador y sondas incorporados para el control climático de las válvulas mezcladoras.

Code	Size	Price	Class	Packaging
501647	230 V AC	949,28 €	PC	1

SAFETY VALVES

SAFETY VALVES FOR HEATING APPLICATIONS

Safety valves are overpressure control devices which, when they reach the calibration value, drain fluid to prevent dangerous operating conditions. Suited for use in heating systems (calibration 3 bar), IVAR valves are available with different connection threads and with or without pressure gauge connection.

■ VSC 00 H



- Valvola di sicurezza femmina-femmina.
- Female-female safety valve.
- Clapet de sécurité femelle-femelle.
- Sicherheitsventil IG-IG.
- Válvula de seguridad hembra-hembra.

Code	Size	Max inlet pressure	Color	Price	Class	Packaging
5702303	1/2" F x 1/2" F	3 bar	■	12,83 €	TG	10 / 80
5702313	3/4" F x 3/4" F	3 bar	■	15,07 €	TG	15 / 120

■ VSC 10 H



- Valvola di sicurezza maschio-femmina.
- Male-female safety valve.
- Clapet de sécurité mâle-femelle.
- Sicherheitsventil AG-IG.
- Válvula de seguridad macho-hembra.

Code	Size	Max inlet pressure	Color	Price	Class	Packaging
5702323	1/2" F x 1/2" M	3 bar	■	13,04 €	TG	20 / 160
5702333	3/4" F x 3/4" M	3 bar	■	15,11 €	TG	15 / 120

■ VSC 01 H



- Valvola di sicurezza femmina-femmina con attacco per manometro.
- Female-female safety valve with connection for pressure gauge.
- Clapet de sécurité femelle-femelle avec embout pour manomètre.
- Sicherheitsventil IG-IG mit Anschluß für Manometer.
- Válvula de seguridad hembra-hembra con conexión para manómetro.

Code	Size	Max inlet pressure	Color	Price	Class	Packaging
5702443	1/2" F x 1/2" F	3 bar	■	14,36 €	TG	20 / 160
5702453	3/4" F x 3/4" F	3 bar	■	16,18 €	TG	15 / 120

■ VSC 11 H



- Valvola di sicurezza maschio-femmina con attacco per manometro.
- Male-female safety valve with connection for pressure gauge.
- Clapet de sécurité mâle-femelle avec embout pour manomètre.
- Sicherheitsventil AG-IG mit Anschluß für Manometer.
- Válvula de seguridad macho-hembra con conexión para manómetro.

Code	Size	Max inlet pressure	Color	Price	Class	Packaging
5702463	1/2" M x 1/2" F	3 bar	■	14,60 €	TG	20 / 160
5702473	3/4" M x 3/4" F	3 bar	■	16,08 €	TG	15 / 120

■ VSC 05 H



- Valvola di sicurezza femmina-femmina con manometro.
- Female-female safety valve with pressure gauge.
- Clapet de sécurité femelle-femelle avec manomètre.
- Sicherheitsventil IG-IG mit Manometer.
- Válvula de seguridad hembra-hembra con manómetro.

Code	Size	Max inlet pressure	Color	Price	Class	Packaging
5702343	1/2" F x 1/2" F	3 bar	■	25,24 €	TG	1
5702353	3/4" F x 3/4" F	3 bar	■	27,06 €	TG	1

■ VSC 15 H



- Valvola di sicurezza maschio-femmina con manometro.
- Male-female safety valve with pressure gauge.
- Clapet de sécurité mâle-femelle avec manomètre.
- Sicherheitsventil AG-IG mit Manometer.
- Válvula de seguridad macho-hembra con manómetro.

Code	Size	Max inlet pressure	Color	Price	Class	Packaging
5702363	1/2" M x 1/2" F	3 bar	■	25,48 €	TG	1
5702373	3/4" M x 3/4" F	3 bar	■	26,97 €	TG	1

■ MA 10



- Manometro con attacco posteriore.
- Pressure gauge with rear connection.
- Manomètre avec embout postérieur.
- Manometer mit rückwärtigem Anschluss.
- Manómetro con conexión posterior.

Code	Size	Range	Price	Class	Packaging
509160	1/4" M	0-10 bar	10,89 €	TA	3 / 48

■ CPS 10



- Collettore portastrumenti.
- Wall mounting manifold.
- Collecteur porte-accessoires.
- Gefäßanschlussgruppe.
- Colector porta-instrumentos.

Code	Price	Class	Packaging
506068	74,02 €	VA	1

■ CPS 20



- Collettore portastrumenti con valvola di sicurezza, manometro, valvola di sfiato automatica e valvola a sfera con rubinetto di scarico per intercettazione vasi di espansione.
- Assembled wall mounting manifold equipped with safety valve, pressure gauge, automatic air valve and ball valve with drainage valve for expansion tank isolation.
- Collecteur porte-accessoires avec clapet de sécurité, manomètre, purgeur d'air automatique et vanne a bille avec robinet de vidange pour l'interception des vases d'expansion.
- Gefäßanschlussgruppe mit Sicherheitsventil, Manometer, automatischer Entlüftungsventil und Kappenventil.
- Colector porta-instrumentos con válvula de seguridad, manómetro, válvula de purga automática y válvula de bola con válvula de descarga para la interceptación de los vasos de expansión.

Code	Price	Class	Packaging
506069	209,62 €	VA	1

AUTOMATIC FILLING GROUPS

Pressure drops may occur on heating systems, normally following an automatic air purge when fitted with air purge valves or after manually bleeding radiators. To ensure optimal system operation, it is obviously necessary to restore normal operating pressure values by recharging the circuit with water. Automatic filler units are useful in all these situations, releasing the user from the need to manually restore system pressure.

The IVAR automatic filler unit comprises:

- a pressure reducer with compensated seat;
- pressure gauge;
- shutoff valve;
- filter;
- non-return valve.

Once the required system pressure is reached, the filler unit automatically closes. The shutoff valve enables closure of the water supply, which is cleaned by means of the filter, and the non-return valve prevents heating circuit water from returning to the drinking water piping. IVAR filler units must be installed according to the direction of flow indicated on the device.

Materials

Body, diaphragm and other internal parts: CW617N brass

O-ring: NBR

Flat seals: asbestos-free seal materials

Plastic parts: PA66

Technical specifications

Maximum operating temperature: 80 °C

Max. inlet pressure: 16 bar

Outlet pressure adjustment range: 0.5-4 bar

Factory settings: 1.5 bar

GA 00



- Gruppo di alimentazione automatico tarabile con manometro completo di rubinetto di intercettazione, filtro e valvola di non ritorno; funzionamento a pistone.
- Automatic filling group with pressure gauge complete with isolation, filter and non-return check valve; piston operation.
- Groupe d'alimentation automatique avec manomètre doté de robinet d'interception, filtre et vanne de non retour; fonctionnement à piston.
- Hauswasserstation mit Manometer, komplett mit Absperrventil, Filter und Rückschlagventil; Kolbenbetrieb.
- Grupo de alimentación automático con manómetro completo de grifo de interceptación, filtro y válvula de retención; operación de pistón.

Code	Size	Range	Max inlet pressure	Preset	Max operating temp.	Price	Class	Packaging
509000	1/2" M x 1/2" F	0,5 - 4 bar	16 bar	1.50 bar	80 °C	61,71 €	TG	1 / 4

BYPASS VALVES

■ AC 623 N



- Valvola di bypass differenziale diritta/squadra per elevate portate.
- Bypass differential valve straight/angled for high flow capacity.
- Vanne de by-pass différentielle droite/équerre pour débit élevé.
- Differenziales Bypass-Ventil Durchgangsform/Eckform für erhöhte Durchfluss.
- Válvula de bypass diferencial recta/de escuadra para capacidades elevadas.

Code	Size	Range	Price	Class	Packaging
500389N	3/4" F x 3/4" M	0,2-0,6 bar	49,65 €	TG	5 / 40
5003891N	3/4" F x 1" M	0,2-0,6 bar	51,16 €	TG	5 / 40





REGULATION AND CONTROL

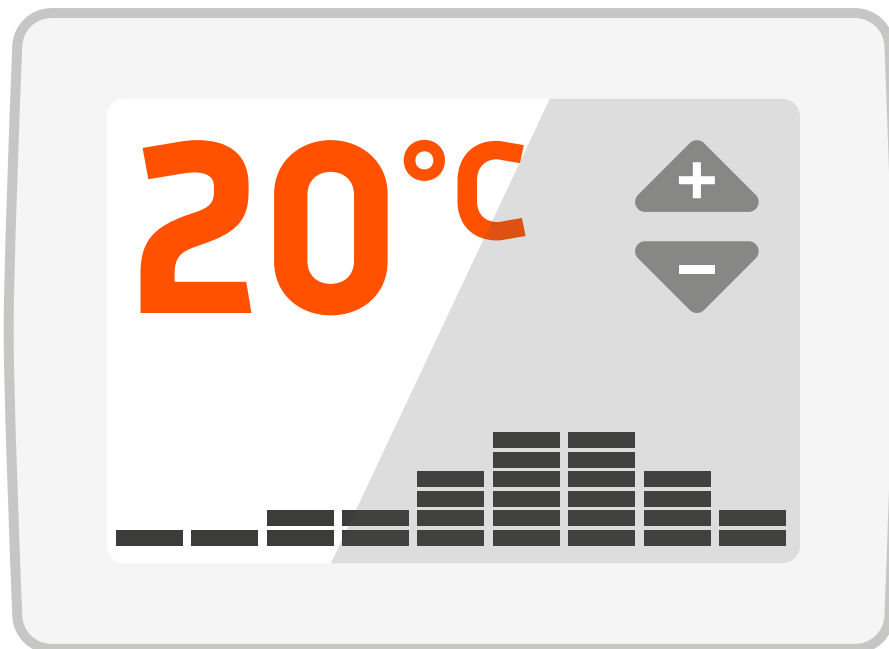

pim.ivar-group.com/short/IT-06

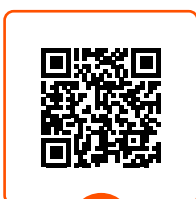

DOWNLOAD
Focus tecnici



pim.ivar-group.com/short/FR-06

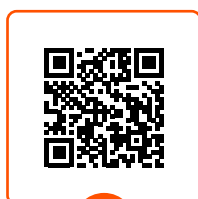

DOWNLOAD
Détails techniques



pim.ivar-group.com/short/DE-06

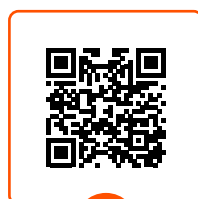

DOWNLOAD
Technische Details



pim.ivar-group.com/short/ES-06

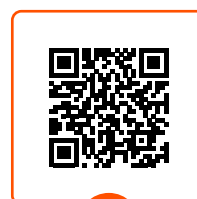

DOWNLOAD
Profundizaciones técnicas

	CUBODOMO® - Sistema di termoregolazione WiFi per dispositivi smart <i>CUBODOMO® - WiFi temperature regulation system for smart devices</i> CUBODOMO® - Système de thermorégulation WiFi pour dispositifs smart <i>CUBODOMO® - WiFi Wärmeregulierung System für Smartvorrichtungen</i> CUBODOMO® - Sistema de termorregulación WiFi para dispositivos smart	344
	CLIMA•HUB - Regolatore elettronico per impianti di riscaldamento e raffrescamento <i>CLIMA•HUB - Electronic controller for heating and cooling systems</i> CLIMA•HUB - Régulateur électronique pour systèmes de chauffage et de refroidissement <i>CLIMA•HUB - Elektronischer Regler für Heiz- und Kühlsysteme</i> CLIMA•HUB - Regulador electrónico para sistemas de calefacción y refrigeración	350
	EQUICALOR•LINK - Sistema di termoregolazione e contabilizzazione wireless <i>EQUICALOR•LINK - Wireless temperature regulation and metering system</i> EQUICALOR•LINK - Système de thermorégulation et comptabilisation wireless <i>EQUICALOR•LINK - Wireless Wärmeregulierung- und Kostenabrechnung-System</i> EQUICALOR•LINK - Sistema de termorregulación y contabilización wireless	356
	Termostati <i>Thermostats</i> Thermostats <i>Thermostate</i> Termostatos	358
	Teste elettrotermiche <i>Electrothermal heads</i> Têtes électrothermiques <i>Elektrothermische Stellantriebe</i> Cabezas electrotérmicas	360
	Servomotori <i>Motors</i> Servomoteurs <i>Stellantriebe</i> Servomotores	362
	Accessori di cablaggio <i>Wiring accessories</i> Accessoires de câblage <i>Verdrahtungszubehör</i> Accesorios de cableado	363
	Termostati di sicurezza <i>Safety thermostats</i> Thermostats de sécurité <i>Sicherheitsthermostate</i> Termostatos de seguridad	364



CUBODOMO®

Cubodomo is a flexible and modular system able to adjust temperature remotely in all house zones, turning smartphones and tablets into a multizone timed thermostat. The system is made up of the following elements:

- Starter pack (cube + probe with relay)
- sensors with relay (with actuator function)
- sensors without relay
- actuators
- wiring center

The Starter pack, consisting of a cube and a relay sensor, is the basic configuration and replaces the classic timed thermostat. The sensor with relay measures room temperature, while the cube manages the heating system via the smart settings of MyCubodomo App. To create a more efficient system and a more comfortable environment, it is possible to integrate the starter pack with the other devices of the system.

Example of CUBODOMO system application



List of CUBODOMO components

N.	Code	Item	Quantity
1	506063	CUB 01	1
2	506066	ACB 10	1
3	506029	ACB 00	2
4	506062	AS 1010 C	1



Manages time zones
24 hours a day, 7 days-a-week.
quickly and easily.



Independent comfort and eco
setpoints for each zone



Remote control for perfect home
comfort.

STARTER PACK: Cube

- Power supply included
- Radio transmission frequency 868 Mhz
- Wi-Fi connection



This is the "system intelligence" and contains all settings entered by the user.



Communicates with smartphones and tablets with the built-in Wi-Fi module.



Interacts with all elements of the wireless system.

STARTER PACK: Master sensor with relay

- Temperature sensor
- Radio transmission frequency 868 Mhz
- Batteries included
- Also suitable for the management of RADIANT SYSTEMS
- Relay to turn on boiler or for zone valve management



The sensor supplied in the Starter Pack controls boiler ignition or opening of zone valves, thanks to its internal relay.



Precise measurement of effective room temperature; replaces old home thermostat



Wireless communication with the cube.

CUB 01

AA INCLUDED

- Starter pack per sistema CUBODOMO®, composto da cubo e sonda di temperatura wireless con contatto caldaia e placca ACB 05.
- Starter pack for CUBODOMO® system, consisting of cube and wireless temperature sensor with boiler contact and ACB 05 cover plate.
- Starter pack pour système CUBODOMO®, composé du cube et capteur de température sans fil avec contact chaudière et plaque ACB 05.
- Starter Pack für System CUBODOMO® besteht aus Kubus und Wireless-Temperaturfühler mit Heizkesselkontakt und Abdeckplatte ACB 05.
- Starter pack para sistema CUBODOMO®, compuesto de cubo y sensor de temperatura wireless con contacto caldera y placa ACB 05.

Code	Size	Price	Class	Packaging
506063	5 V AC - 2 x AA 1,5 V battery	678,00 €	VE	1

RELAY SENSOR (with ACTUATOR function)



- Temperature sensor
- Radio transmission frequency 868 Mhz
- Batteries included
- Also suitable for MULTI-ZONE RADIANT SYSTEMS
- Relay to turn on boiler or for zone valve management



All the timed-thermostats can be replaced with additional relay actuators, to control the temperature of each zone, even with radiant systems.



They measure the actual room temperature accurately.



Wireless communication with the cube.

ACB 07



AA INCLUDED

- Sonda di temperatura wireless aggiuntiva con contatto relé.
- Additional wireless temperature sensor with relay contact.
- Capteur de température sans fil supplémentaire avec contact relais.
- Zusätzlicher Wireless-Temperaturfühler mit Relaiskontakt.
- Sensor de temperatura wireless adicional con contacto relé.

Code	Size	Price	Class	Packaging
506073	2 x AA 1,5 V battery	226,00 €	VE	1

ACB 05



- Placca di copertura per montaggio termostato o sonda di temperatura su scatola elettrica 503 E.
- Cover plate for thermostat or temperature sensor installation on 503 E electrical box.
- Plaque de couverture pour le montage du thermostat ou capteur de température sur la boîte électrique 503 E.
- Abdeckplatte für die Befestigung des Thermostats oder Ersatztemperaturfühlers am Schaltkasten 503 E.
- Placa de cobertura para el montaje del termostato o sensor de temperatura sobre la caja eléctrica 503 E.

Code	Size	Price	Class	Packaging
506070	503 E	33,90 €	VE	100

SENSORS WITHOUT RELAY



Temperature sensor



Radio transmission frequency 868 Mhz



Batteries included



NO Relay



Additional sensors (without on-board relay) can be installed in each room for more efficient measurement of room temperatures.



They measure the actual room temperature accurately, unlike systems that measure the temperature close to the radiator.



Wireless communication with the cube.

ACB 00



- Sonda di temperatura wireless aggiuntiva.
- Additional wireless temperature sensor.
- Capteur de température sans fil supplémentaire.
- Zusätzlicher Wireless-Temperaturfühler.
- Sensor de temperatura wireless adicional.

AA INCLUDED

Code	Size	Price	Class	Packaging
506029	2 x AA 1,5 V battery	169,50 €	VE	1



ACTUATORS



- Can be installed on all valves with thermostat option with M30x1.5 fitting
- Radio transmission frequency 868 Mhz
- Batteries included
- Optimised proximity temperature sensor and prompt control of set point.



These enable perfect temperature control of each radiator fitted with a thermostatic valve.



They ensure the option of controlling the temperature in each room.



The cube can manage up to 28 devices between actuators and sensors



AS 1010 C



AA INCLUDED

- Servomotore assiale per valvola termostattizzabile, compatibile con sistema CUBODOMO.
- Axial motor for thermostatic valve, suitable for CUBODOMO system.
- Servomoteur axial pour robinet thermostatisable, adapté pour le système CUBODOMO.
- Axial-Stellantrieb für Thermostatventil, geeignet für System CUBODOMO.
- Servomotor axial para válvula termostaticable, adecuado para el sistema CUBODOMO.

Code	Size	Price	Class	Packaging
506062	M30 x 1,5 - 3 x AA 1,5 V battery	110,74 €	VE	1

AGE 17



- Adattatore teste termostatiche / valvole DANFOSS.
- Thermostatic heads / DANFOSS valves adapter.
- Adaptateur têtes thermostatiques / robinets DANFOSS.
- Adapter für Thermostatköpfe / Ventile DANFOSS.
- Adaptador cabezas termostáticas / válvulas DANFOSS.

Code	Price	Class	Packaging
560001	16,95 €	VE	40 / 320

WIRING CENTER



- Diagnostics, heads, pump relay and boiler relay ON/OFF
- Radio transmission frequency 868 Mhz
- 230V power supply for control of the two-wire electrothermal heads
- Ideal for **MULTI-ZONE RADIANT SYSTEMS**
- Two relays with contacts for zone valve or circulator and boiler request control



Manages the opening or closing of the circuits of a radiant system thanks to the use of 2-wire 230 V electrothermic heads.



By communicating with the cube and with the assistance of temperature probes, it is able to regulate the temperature in every single room.



Transforms a single zone radiant system into a multi-zone system (up to 8 zones per board).

ACB 10



- **Wiring center per regolazione di impianti radianti (max 8 zone).**
- **Wiring center for radiant systems adjustment (max 8 zones).**
- **Wiring center pour le réglage des systèmes radiants (max 8 zones).**
- **Wiring center für die Einstellung von Fußbodenheizungssysteme (max 8 Zonen).**
- **Wiring center para el ajuste de los sistemas radiantes (máximo 8 zonas).**

Code	Size	Price	Class	Packaging
506066	230 V AC	678,00 €	VE	1



CLIMA•HUB

CLIMA•HUB is an electronic controller for the management of heating/cooling plants. The system is based on a freely-programmable controller equipped with digital and analog inputs/outputs, bus ports, to which different applications are uploaded depending on the specific system requirements. Thanks to this flexible approach, IVAR can provide intelligence to the individual plants and offer advanced solutions for comfort and energy saving.

CLIMA•HUB is available in 3 variants with different application softwares. For special needs it is possible to contact IVAR's Linea Arancio and evaluate possible customized solutions.

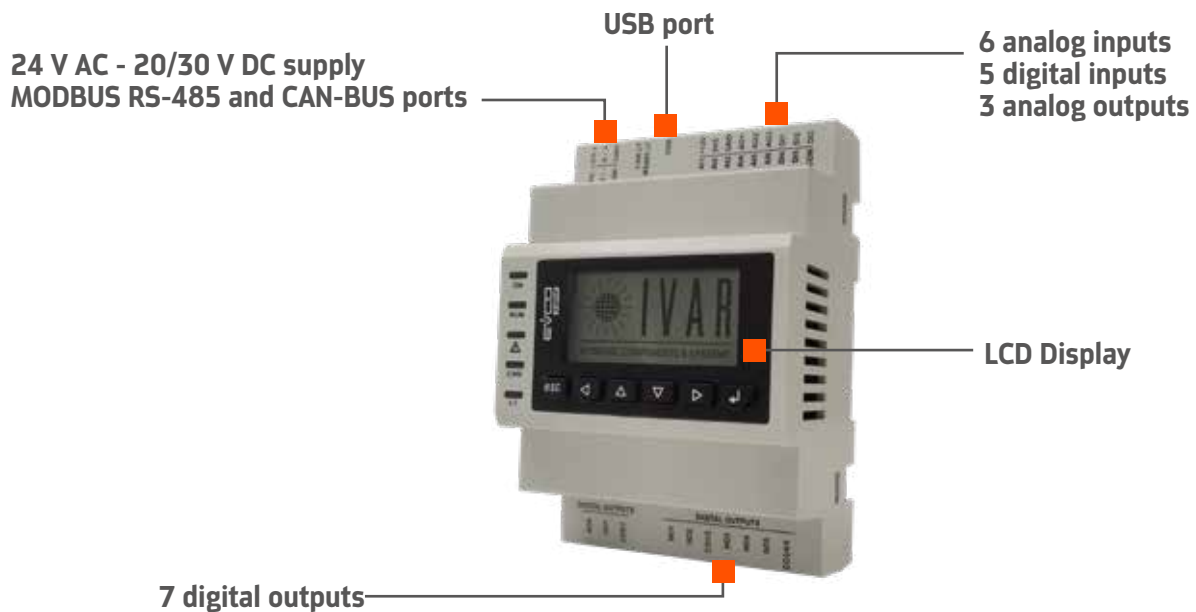

CLIMA-HUB 04 electronic controller for heating/cooling allows the management of.

- 2 mixed circuits for the distribution to radiant system with weather compensation (for the second mixed circuit, order the ACH 41 chronothermohumidistat);
- 1 direct circuit for the distribution in high temperature or the supply to dehumidification circuits.

The controller interacts with temperature and humidity probes connected via CAN-BUS. Each probe has two relays through which it is possible to manage both the zone electro-thermal actuator on the manifold and any dedicated dehumidifier.

An optional color touchscreen viewer is available for monitoring the system from a single home terminal.

By inserting the CHUB-EXP expansion module it is possible to provide a further call signal to the dehumidifiers whenever these are also able to work in cooling assist mode.

In summer it is, indeed, possible to activate a booster mode whenever the temperature setpoint is not reached within a certain time period which can be set by the user.

+ PLUS

- **Management of up to 14 temperature/humidity zones**
- **Module for integration of cooling with dehumidification**
- **Possibility to assign a temperature or humidity function to each zone relay with specific comfort time bands**
- **Accessory for management via colour touchscreen interface**
- **Control of two different terminal devices with a zone timer thermostat/humidistat**
- **Anti-frost and anti-lock function**
- **Possibility to carry out tests and forcing**

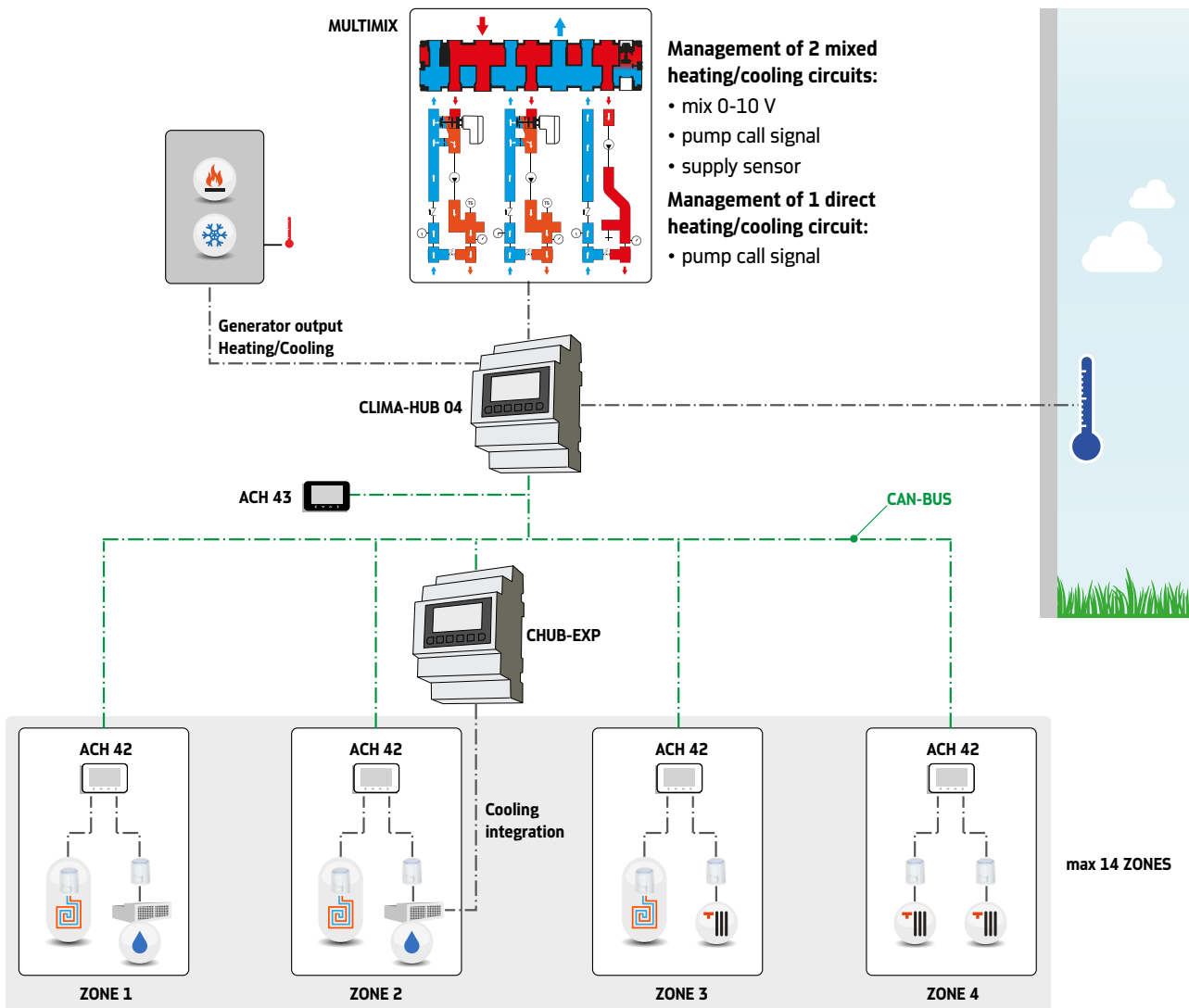

Simplified scheme. Check manuals for correct electrical connections.

1. Heating /cooling zone with dehumidification
2. Heating /cooling zone with dehumidification and integration call signal
3. Heating/cooling (radiant) zone without dehumidification + integration of heating only with radiators
4. Heating only zone with radiators or heating/cooling zone with fan-coils.

N.B.: each call signal of the ACH 42 timer thermostat/humidistat can be associated with one of the booster circuits

CLIMA-HUB 04



- **Regolatore elettronico (riscaldamento/raffrescamento) completo di cronotermoumidostato ambiente, sonda esterna e una sonda di mandata.**
- **Electronic regulator (heating/cooling) complete with room chronothermo-humidistat, external probe and a delivery probe.**
- **Régulateur électronique (chauffage/refroidissement) avec chrono-thermo-humidostat d'ambiance, sonde externe et une sonde de refluxement.**
- **Elektronischer Regler (Heizen/Kühlen) komplett mit Raum-Chrono-Thermo-Feuchtigkeitsregler, Außen- und Vorlauffühler.**
- **Regulador electrónico (calefacción/refrigeración) con crono-termo-higrostatto ambiente, sonda externa y sonda de impulso.**

Code	Size	Module	Price	Class	Packaging
CHUB04	24 V AC - 20/30 V DC	4 DIN modules	1.237,97 €	VA	1

CHUB-EXP



- **Modulo di espansione per CHUB04.**
- **Expansion module for CHUB04.**
- **Module d'extension pour CHUB04.**
- **Erweiterungsmodul für CHUB04.**
- **Módulo de expansión para CHUB04.**

Code	Price	Class	Packaging
CHUB-EXP	903,44 €	VA	1

ACH 42 is a chronothermohumidistat to be used in combination with the CHUB04 electronic regulator. It is equipped with temperature and humidity probes, two relay outputs and a CAN-BUS port.

The device measures zone temperature and humidity and sends the values to the controller via CAN-BUS protocol. Based on the values received, the regulator provides the chronothermohumidistat with the appropriate consents to activate or not the relay outputs.

In general, it is possible to operate the zone actuator in the event of a temperature request (relay 1) and start the dehumidifier (relay 2) if the zone conditions are close to the dew-point. However, it is possible to use the second relay also to control a second temperature terminal, for example a design radiator to which you want to provide activation times different from those of the radiant system.

Operation of radiant circuit and zone dehumidifier or alternatively radiant circuit and zone radiator

Example of operation with radiant circuits and dehumidifiers

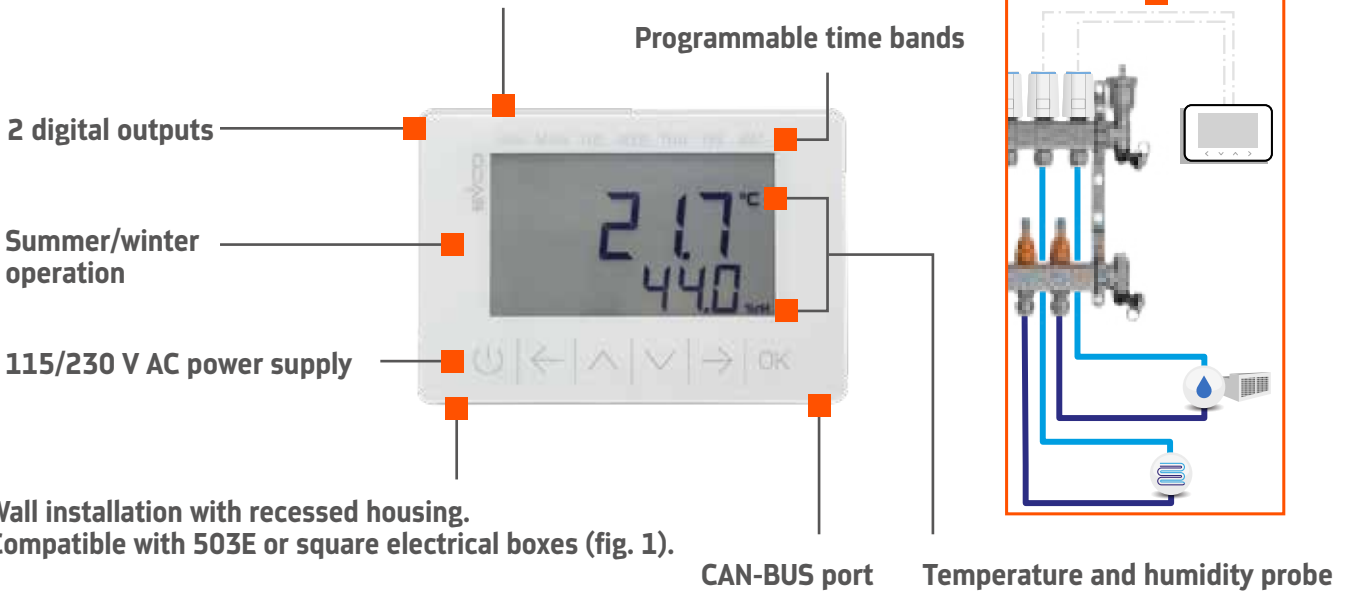

Wall installation with recessed housing. Compatible with 503E or square electrical boxes (fig. 1).



Fig. 1

ACH 41



- Cronotermohumidistato ambiente completo di sonda di mandata per circuito miscelato aggiuntivo.
- Room chronothermohumidistat complete with delivery probe for additional mixing circuit.
- Chrono-thermo-humidostat d'ambiance avec une sonde de refoulement pour circuit de mélange supplémentaire.
- Raum-Chrono-Thermo-Feuchtigkeitsregler komplett mit Vorlauffühler für zusätzlichen Mischkreislauf.
- Crono-termo-higrostatato ambiente con sonda de impulso para circuito de mezcla adicional.

Code	Size	Price	Class	Packaging
OKC2TH	115/230 V AC	463,02 €	VA	1

ACH 42



- Cronotermohumidistato ambiente per zona aggiuntiva.
- Room chronothermohumidistat for additional zone.
- Chrono-thermo-humidostat d'ambiance pour zone supplémentaire.
- Chrono-Thermo-Feuchtigkeitsregler für zusätzliche Zone.
- Crono-termo-higrostatato ambiente para zona adicional.

Code	Size	Price	Class	Packaging
OSDTH01	115/230 V AC	463,30 €	VA	1

ACH 43 is a color touch-screen viewer. The device is optional and shows the menu of the electronic controller. In this way, the user can easily manage and monitor the entire system from a control panel installed in the room.

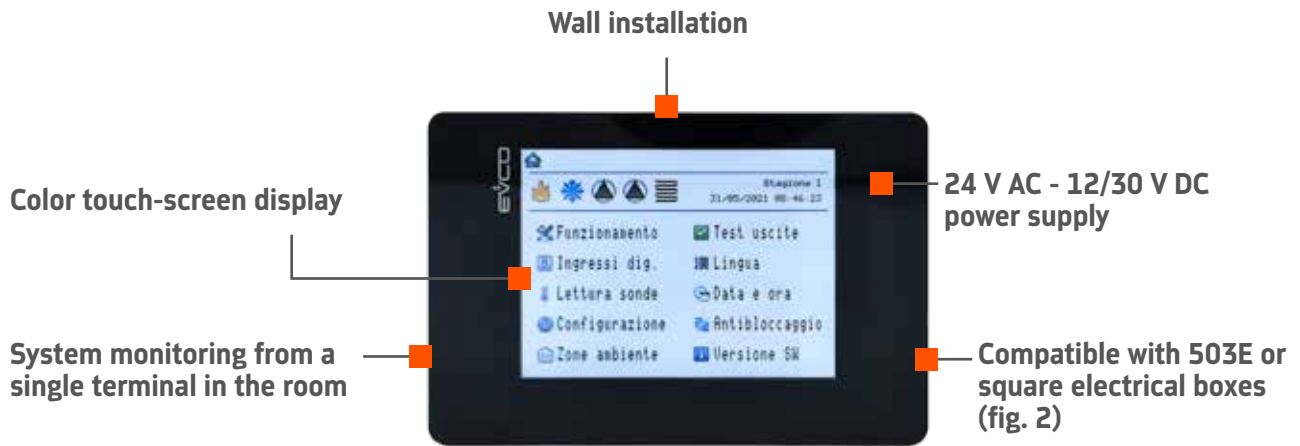

Fig. 2

ACH 43



- Pannello di controllo a parete per CHUB04.
- Wall-mounted control panel for CHUB04.
- Panneau de commande mural pour CHUB04.
- Wand-Panel für CHUB04 Kontrolle.
- Panel de control de pared para CHUB04.

Code	Size	Price	Class	Packaging
OEPJ00	24 V AC - 12/30 V DC	898,35 €	VA	1



CLIMA-HUB 01 electronic controller for heating/cooling allows the management of.

- 1 mixed circuit controlled by temperature/humidity probe
- 1 direct circuit controlled by On / Off room thermostats
- 1 dehumidification circuit.

The mixing valves are controlled by a **0-10 V proportional** voltage signal according to a setpoint which can be fixed or variable, based on a set climatic compensation. It is possible to connect a pump output for each circuit and provide the connection of a safety thermostat and a zone valve for the mixed circuit.

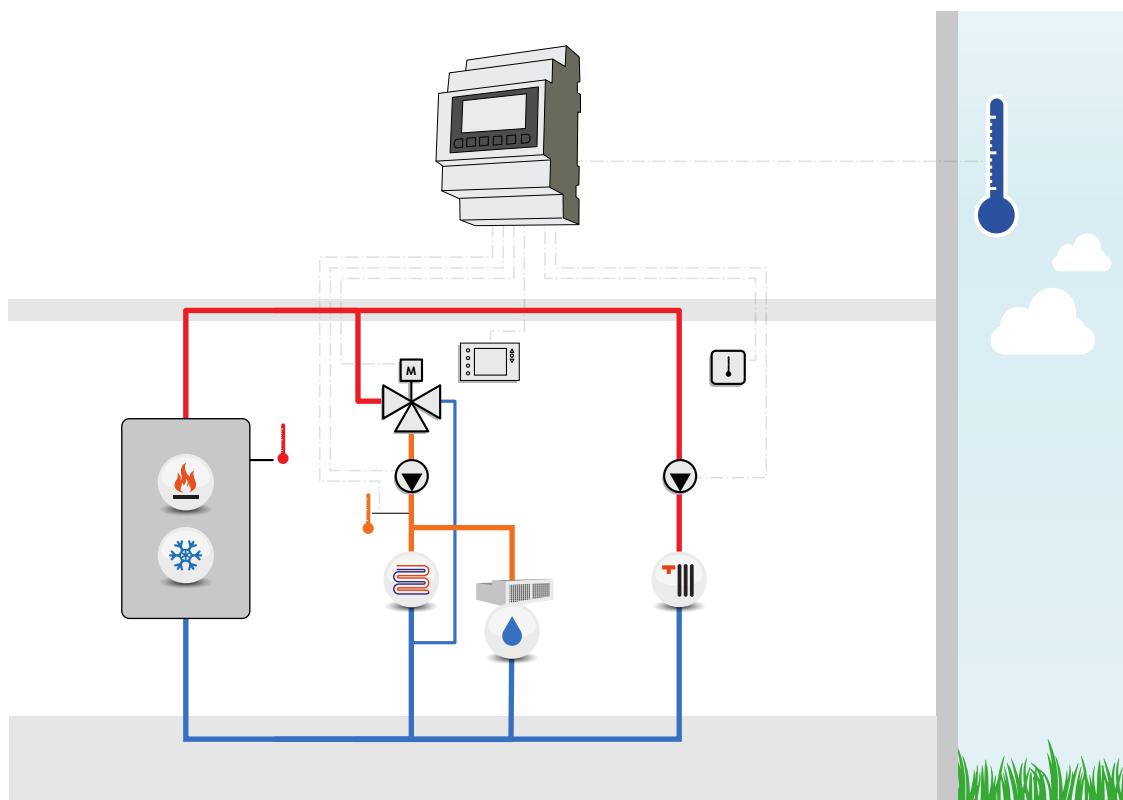

Simplified scheme. Check manuals for correct electrical connections.

CLIMA-HUB 01



- **Regolatore elettronico (riscaldamento/raffrescamento) completo di sonda esterna e una sonda di mandata.**
- **Electronic regulator (heating/cooling) complete with external probe and delivery probe.**
- **Régulateur électronique (chauffage/refroidissement) avec sonde externe et sonde de reflux.**
- **Elektronischer Regler (Heizen/Kühlen) komplett mit Außen- und Vorlauffühler.**
- **Regulador electrónico (calefacción/refrigeración) con sonda externa y sonda de impulso.**

Code	Size	Module	Price	Class	Packaging
CHUB01	24 V AC - 20/30 V DC	4 DIN modules	967,12 €	VA	1

CLIMA-HUB 02 electronic controller for heating only allows the management of.

- 2 mixed circuits controlled by On / Off room thermostats
- 1 direct circuit controlled by On / Off room thermostats.

The mixing valves are controlled by a **0-10 V proportional** voltage signal according to a setpoint which can be fixed or variable, based on a set climatic compensation. It is possible to connect a pump output for each circuit and provide the connection of a safety thermostat and a zone valve for the 2 mixed circuits.

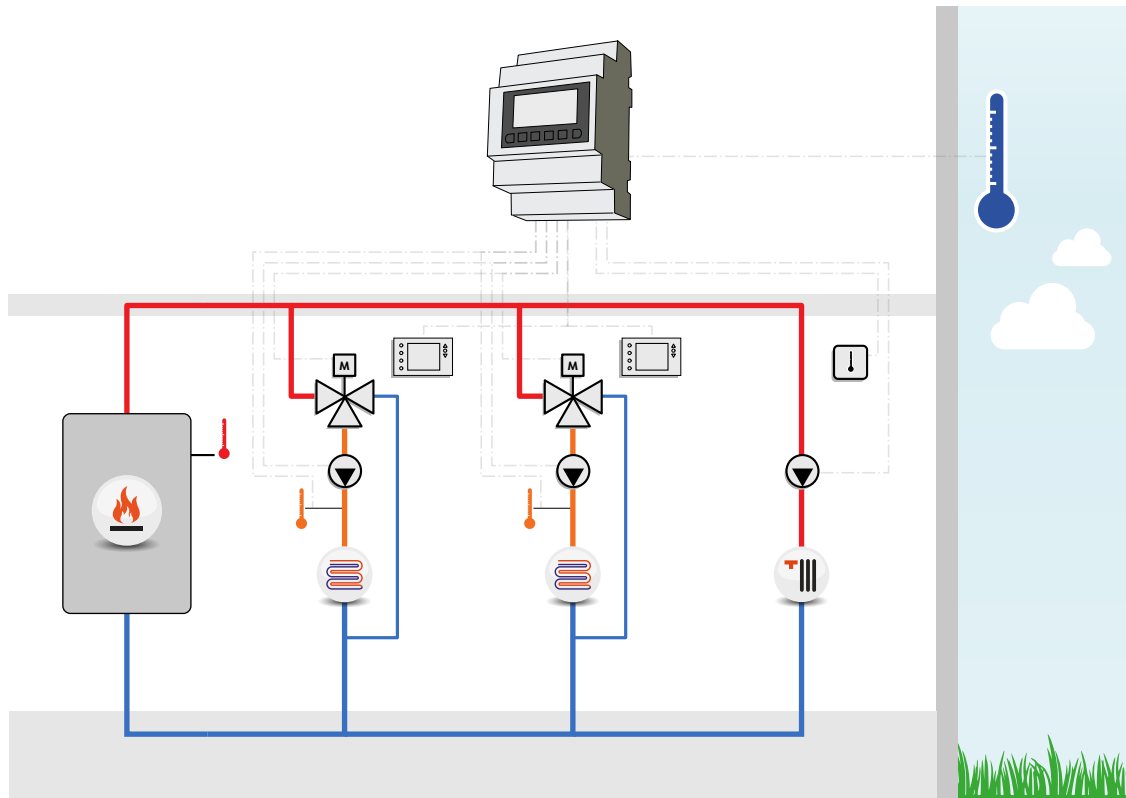

Simplified scheme. Check manuals for correct electrical connections.

CLIMA-HUB 02



- **Regolatore elettronico (solo riscaldamento) completo di sonda esterna e due sonde di mandata.**
- **Electronic regulator (heating only) complete with external probe and two delivery probes.**
- **Régulateur électronique (seulement chauffage) avec sonde externe et deux sondes de refoulement.**
- **Elektronischer Regler (nur Heizung) komplett mit Außen- und zwei Vorlauffühler.**
- **Regulador electrónico (solo calefacción) con sonda externa y dos sondas de impulso.**

Code	Size	Module	Price	Class	Packaging
CHUB02	24 V AC - 20/30 V DC	4 DIN modules	967,12 €	VA	1

EQUICALOR•LINK

EQUICALOR-LINK is a system that allows users to independently control the temperature of individual rooms, perform indirect heat metering (per Italian standard UNI 9019) and the distribution of costs based on actual consumption, offering administrators and heat managers the tools necessary to gather and process data.

The system is based on the interaction between the home networks and the data centralisation backbone.

- **Home network** (temperature control and heat metering), comprising:
 - actuators mounted directly on thermostatic valves;
 - timer-thermostat that communicates with the actuators by radio;
 - any wireless probes and/or thermostats installed in the individual zones for better room temperature readings and comfort optimisation.
- **Centralisation network:** a backbone of devices (bridges) that receive data from the periphery (home network) and allow it to be stored on the gateway, covering up to 100 user components. By accessing the gateway, the collected data can be downloaded.

EQUICALOR-LINK, also an ideal solution for managing the heating in public buildings such as schools, nursery schools, municipal administrations etc. The system allows a network of devices to be built up, which can be easily controlled remotely or from a local control station that communicates with the gateway.

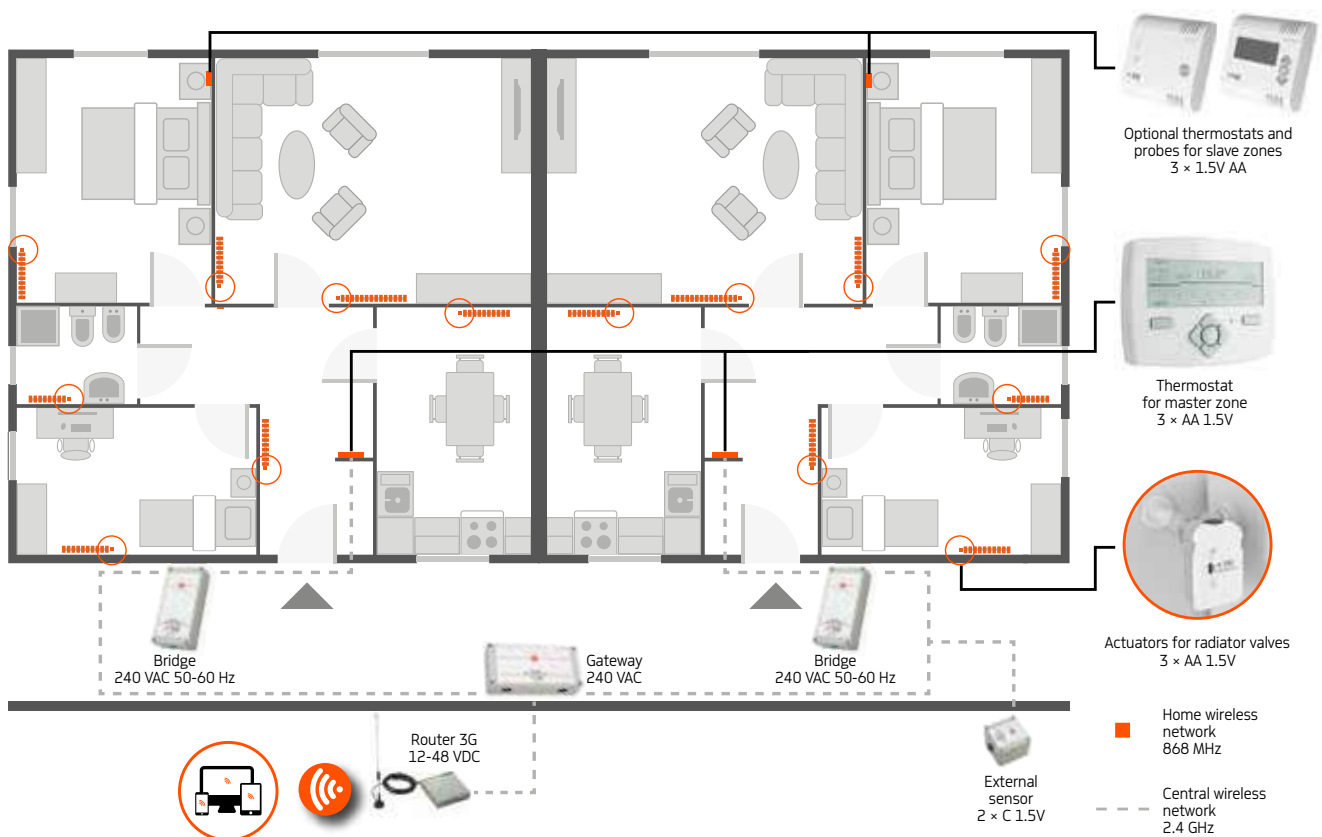

PLUS

- **Multi-zone system: customised comfort in every area**
- **Wireless communication among devices**
- **Remote control via software and web manager**
- **Advanced energy-saving management functions**
- **Intuitive multilingual menu with guided configuration**
- **Ideal for climate control in public buildings**

Home network



DC 1020 / DC 1030

Master thermostat

- Temperature settings
- Consumption display
- Max 8 zones (32 actuators)
- Electronic tamper-proofing
- Available with/without boiler contact



AS 1010

Actuators

- Automatic control
- Consumption meter
- Temperature sensor for proximity compensation to radiator
- Mechanical tamper-proofing



AE 1010

AE 1020

Room thermostats

- Temperature measurement, control and display in slave zones
- Also available in a blind version



DE 1010

Bridge

Home network / centralisation network interface



DE 1020

External sensor

Outdoor temperature and humidity readings



DE 1000

Gateway

- Consumption data archiving
- Access from/to the outside



DE 1030

3G Router

Remote connections



For the user: the WEB manager

Web manager is a tool that allows the user to remotely switch the system on and off and to temporarily schedule time and temperature. All of this is accessible from a web page on any PC, smartphone or tablet.



For specialised personnel: Software Service

Software Service is an application dedicated exclusively to specialised technicians, heating managers and administrators, which provides for the creation of a wireless backbone for diagnostics and remote access to the gateway for data download and programming.

For quotations, system configuration and more information, please contact

LINEA ARANCIO
TECHNICAL SUPPORT
linea.arancio@ivar.it

THERMOSTATS

IVAR offers a complete range of digital thermostats and timed thermostats for regulation of individual environments, characterised especially for their intuitiveness in use.

JUSTO is a timed thermostat that provides hourly scheduling for every day of the week in 30 minute slots. The device offers both on/off and PWM operation. In PWM mode, it is able to reduce activation times by also taking thermal inertia into account, thus obtaining a more stable ambient temperature which is less susceptible to oscillations and offers greater comfort and energy savings. JUSTO LITE, on the other hand, is an on/off thermostat for heating/cooling.

■ JUSTO



- Cronotermostato digitale ON/OFF o PWM (riscaldamento/raffrescamento).
- Digital timed thermostat ON/OFF or PWM (heating/cooling).
- Chronothermostat digital ON/OFF ou PWM (chauffage/refroidissement).
- Digitaler Chrono-Thermostat ON/OFF oder PWM (Heizung/Kühlung).
- Cronotermostato digital ON/OFF o PWM (calefacción/enfriamiento).

Code	Size	Price	Class	Packaging
580021	Battery	127,69 €	VA	1

■ JUSTO LITE



- Termostato digitale ON/OFF (riscaldamento/raffrescamento).
- Digital thermostat ON/OFF (heating/cooling).
- Thermostat digital ON/OFF (chauffage/refroidissement).
- Digitales Thermostat ON/OFF (Heizung/Kühlung).
- Termostato digital ON/OFF (calefacción/enfriamiento).

Code	Size	Price	Class	Packaging
580010	Battery	88,14 €	VA	1

■ JUSTO W



- Cronotermostato digitale wireless ON/OFF o PWM (riscaldamento/raffrescamento).
- Wireless digital timed thermostat ON/OFF or PWM (heating/cooling).
- Chronothermostat digital sans fil ON/OFF ou PWM (chauffage/refroidissement).
- Wireless digitales Chrono-Thermostat ON/OFF oder PWM (Heizung/Kühlung).
- Cronotermostato digital wireless ON/OFF o PWM (calefacción/enfriamiento).

Code	Size	Price	Class	Packaging
580024	Battery	226,00 €	VA	1

■ JUSTO LITE W



- Termostato digitale wireless ON/OFF (riscaldamento/raffrescamento).
- Wireless digital thermostat ON/OFF (heating/cooling).
- Thermostat digital sans fil ON/OFF (chauffage/refroidissement).
- Wireless digitales Thermostat ON/OFF (Heizung/Kühlung).
- Termostato digital wireless ON/OFF (calefacción/enfriamiento).

Code	Size	Price	Class	Packaging
580022	Battery	194,36 €	VA	1

■ RW 711 J



- Ricevitore wireless per JUSTO W.
- Wireless receiver for JUSTO W.
- Récepteur sans fil pour JUSTO W.
- Wireless-Empfänger für JUSTO W.
- Receptor wireless para JUSTO W.

Code	Price	Class	Packaging
580025	118,65 €	VA	1

■ RW 701 JL



- Ricevitore wireless per JUSTO LITE W.
- Wireless receiver for JUSTO LITE W.
- Récepteur sans fil pour JUSTO LITE W.
- Wireless-Empfänger für JUSTO LITE W.
- Receptor wireless para JUSTO LITE W.

Code	Price	Class	Packaging
580023	140,12 €	VA	1

■ ACB 05



- Placca di copertura per montaggio termostato o sonda di temperatura su scatola elettrica 503 E.
- Cover plate for thermostat or temperature sensor installation on 503 E electrical box.
- Plaque de couverture pour le montage du thermostat ou capteur de température sur la boîte électrique 503 E.
- Abdeckplatte für die Befestigung des Thermostats oder Ersatztemperaturfühlers am Schaltkasten 503 E.
- Placa de cobertura para el montaje del termostato o sensor de temperatura sobre la caja eléctrica 503 E.

Code	Size	Price	Class	Packaging
506070	503 E	33,90 €	VE	100

The line of AC 701 thermostats is available in the variant for heating only (or cooling only) applications with the simple battery power supply and incremental buttons for changing the temperature setting. They are also available in versions with the same thermostat complete with ON/OFF button (AC 701A) or the 230 VAC powered version which also works in hot/cold mode (AC 701B).

IVAR also proposes two timed thermostats AC 710 (for heating only) and AC 711 (for hot/cold) with backlit display and possibility of programming on/off time slots during the day/week. AC 711 also has three outlets to change the speed of a fancoil.

AC 711

- **Cronotermostato digitale (riscaldamento/raffrescamento) con switch estate/inverno.**
- *Digital timed thermostat (heating/cooling) with summer/winter switch.*
- **Chronothermostat digital (chauffage/refroidissement) avec switch été/hiver.**
- *Digitale Chrono-Thermostat (Heizung/Kühlung) mit Sommer/Winter Schaltung.*
- **Cronotermostato digitale (calefacción/enfriamiento) con switch Verano/Invierno.**

Code	Size	Price	Class	Packaging
580015	230 V AC	127,27 €	VA	1

AC 701 B

- **Termostato (riscaldamento/raffrescamento).**
- *Thermostat (heating/cooling).*
- **Termostato (chauffage/refroidissement).**
- *Thermostat (Heizung/Kühlung).*
- **Termostato (calefacción/enfriamiento).**

Code	Size	Price	Class	Packaging
580017	230 V AC	56,18 €	VA	1

AC 710 T

- **Cronotermostato digitale giornaliero/settimanale (solo riscaldamento) con schermo touch.**
- *Daily/weekly digital timed thermostat (heating only) with touch screen.*
- **Chronothermostat digital journalier/hebdomadaire (seulement chauffage) avec écran tactile.**
- *Täglicher/wöchentliche Digital-Chronothermostat (nur Heizung) mit Touchscreen.*
- **Cronotermostato digitale diario/semanal (solo calefacción) con pantalla táctil.**

Code	Size	Price	Class	Packaging
580018	Battery	124,89 €	VA	1

AC 701 A

- **Termostato (solo riscaldamento) con selettore ON/OFF.**
- *Thermostat (heating only) with ON/OFF switch.*
- **Termostato (chauffage uniquement) avec sélecteur ON/OFF.**
- *Thermostat (nur Heizung) mit Ein-/Aus-Schalter.*
- **Termostato (solo calefacción) con selector ON/OFF.**

Code	Size	Price	Class	Packaging
580016	Battery	69,05 €	VA	1

AC 710

- **Cronotermostato digitale giornaliero/settimanale (solo riscaldamento).**
- *Daily/weekly digital timed thermostat (heating only).*
- **Chronothermostat digital journalier/hebdomadaire (seulement chauffage).**
- *Täglicher/wöchentliche Digital-Chronothermostat (nur Heizung).*
- **Cronotermostato digitale diario/semanal (solo calefacción).**

Code	Size	Price	Class	Packaging
580012	Battery	108,71 €	VA	1

AC 701

- **Termostato digitale (solo riscaldamento).**
- *Digital thermostat (heating only).*
- **Termostato digitale (seulement chauffage).**
- *Digitale Thermostat (nur Heizung).*
- **Termostato digitale (solo calefacción).**

Code	Size	Price	Class	Packaging
580011	Battery	69,05 €	VA	1

CRTH

- **Cronotermostato con sensore di umidità.**
- *Timed thermostat with humidity sensor.*
- **Chronothermostat avec capteur d'humidité.**
- *Chronothermostat mit Feuchtigkeitssensor.*
- **Cronotermostato con sensor de humedad.**

Code	Price	Class	Packaging
CRTH	396,07 €	ZD	1

ELECTROTHERMAL HEADS

The TE 3040, TE 3050 M and TE 3061 heads are equipped with "first open" function, i.e. the brand new actuator is in the normally open state when delivered. This allows the system to be flushed and filled with the heads already installed, even before the electrical wiring. Then, during commissioning, application of the operating voltage (for more than 6 minutes) automatically triggers the "first open" function making the actuator ready for operation. This function is not available for the NO (TE 4040 A) versions. All electrothermal heads are equipped with double insulation.

TE 3050 M



- Testa elettrotermica normalmente chiusa con contatto di fine corsa (4 fili). Compatibile con tutti i vitoni termostattizzabili IVAR e i collettori con interasse ≥ 50 mm (no EASY-RADIANT).
- Electrothermal head normally closed with limit switch contact (4 wires). Suitable for all IVAR thermostatic inserts and manifolds with centre-to-centre distance ≥ 50 mm (no EASY-RADIANT).
- Tête électrothermique normalement fermée avec contact de fin de course (4 fils). Adaptée pour tous les inserts thermostatisables IVAR et aux collecteurs avec entraxe ≥ 50 mm (non EASY-RADIANT).
- Elektrothermischer Stellantrieb stromlos-zu mit Endschalterkontakt (4 Kabel). Geeignet für alle Thermostat-Regulievorrichtungen IVAR und für Verteiler mit Achsabstand ≥ 50 mm (keine EASY-RADIANT).
- Cabeza electrotérmica normalmente cerrada con contacto de fin de carrera (de 4 hilos). Adecuada para todos los tornillos termostatisables IVAR y los colectores con distancia entre centros ≥ 50 mm (no EASY-RADIANT).

Code	Size	Price	Class	Packaging
500808M	M30 x 1,5 ; ON / OFF (230 V AC)	43,43 €	AC	100
500028M	M30 x 1,5 ; ON / OFF (24 V AC/DC)	43,43 €	AC	100

TE 3040



- Testa elettrotermica normalmente chiusa (2 fili). Compatibile con tutti i vitoni termostattizzabili IVAR e i collettori con interasse ≥ 50 mm (no EASY-RADIANT).
- Electrothermal head normally closed (2 wires). Suitable for all IVAR thermostatic inserts and manifolds with centre-to-centre distance ≥ 50 mm (no EASY-RADIANT).
- Tête électrothermique normalement fermée (2 fils). Adaptée pour tous les inserts thermostatisables IVAR et aux collecteurs avec entraxe ≥ 50 mm (non EASY-RADIANT).
- Elektrothermischer Stellantrieb stromlos-zu (2 Kabel). Geeignet für alle Thermostat-Regulievorrichtungen IVAR und für Verteiler mit Achsabstand ≥ 50 mm (keine EASY-RADIANT).
- Cabeza electrotérmica normalmente cerrada (de 2 hilos). Adecuada para todos los tornillos termostatisables IVAR y los colectores con distancia entre centros ≥ 50 mm (no EASY-RADIANT).

Code	Size	Price	Class	Packaging
501508	M30 x 1,5 ; ON / OFF (230 V AC)	36,60 €	AC	100
501524	M30 x 1,5 ; ON / OFF (24 V AC/DC)	36,60 €	AC	100

TE 4040 A



- Testa elettrotermica normalmente aperta (2 fili). Compatibile con tutti i vitoni termostattizzabili IVAR e i collettori con interasse ≥ 50 mm (no EASY-RADIANT).
- Electrothermal head normally open (2 wires). Suitable for all IVAR thermostatic inserts and manifolds with centre-to-centre distance ≥ 50 mm (no EASY-RADIANT).
- Tête électrothermique normalement ouverte (2 fils). Adaptée pour tous les inserts thermostatisables IVAR et aux collecteurs avec entraxe ≥ 50 mm (non EASY-RADIANT).
- Elektrothermischer Stellantrieb stromlos-auf (2 Kabel). Geeignet für alle Thermostat-Regulievorrichtungen IVAR und für Verteiler mit Achsabstand ≥ 50 mm (keine EASY-RADIANT).
- Cabeza electrotérmica normalmente abierta (de 2 hilos). Adecuada para todos los tornillos termostatisables IVAR y los colectores con distancia entre centros ≥ 50 mm (no EASY-RADIANT).

Code	Size	Price	Class	Packaging
501508A	M30 x 1,5 ; ON / OFF (230 V AC)	36,60 €	AC	100
501524A	M30 x 1,5 ; ON / OFF (24 V AC/DC)	36,60 €	AC	100

TE 3050 MC

- **Testa elettrotermica normalmente chiusa con contatto di fine corsa (4 fili). Compatibile con tutti i vitoni termostattizzabili IVAR e i collettori con interasse ≥ 40 mm.**
- *Electrothermal head normally closed with limit switch contact (4 wires). Suitable for all IVAR thermostatic inserts and manifolds with centre-to-centre distance ≥ 40 mm.*
- **Tête électrothermique normalement fermée avec contact de fin de course (4 fils). Adaptée pour tous les inserts thermostatisables IVAR et aux collecteurs avec entraxe ≥ 40 mm.**
- *Elektrothermischer Stellantrieb stromlos-zu mit Endschalterkontakt (4 Kabel). Geeignet für alle Thermostat-Regulievorrichtungen IVAR und für Verteiler mit Achsabstand ≥ 40 mm.*
- **Cabeza electrotérmica normalmente cerrada con contacto de fin de carrera (de 4 hilos). Adecuada para todos los tornillos termostatzables IVAR y los colectores con distancia entre centros ≥ 40 mm.**

Code	Size	Price	Class	Packaging
500808MC	M30 x 1,5 ; ON / OFF (230 V AC)	43,43 €	AC	100

TE 3040 IV

- **Testa elettrotermica normalmente chiusa (2 fili). Compatibile con tutti i vitoni termostattizzabili IVAR e i collettori con interasse ≥ 40 mm.**
- *Electrothermal head normally closed (2 wires). Suitable for all IVAR thermostatic inserts and manifolds with centre-to-centre distance ≥ 40 mm.*
- **Tête électrothermique normalement fermée (2 fils). Adaptée pour tous les inserts thermostatisables IVAR et aux collecteurs avec entraxe ≥ 40 mm.**
- *Elektrothermischer Stellantrieb stromlos-zu (2 Kabel). Geeignet für alle Thermostat-Regulievorrichtungen IVAR und für Verteiler mit Achsabstand ≥ 40 mm.*
- **Cabeza electrotérmica normalmente cerrada (de 2 hilos). Adecuada para todos los tornillos termostatzables IVAR y los colectores con distancia entre centros ≥ 40 mm.**

Code	Size	Price	Class	Packaging
501508E	M30 x 1,5 ; ON / OFF (230 V AC)	29,64 €	AC	100

TE 3061

- **Testa elettrotermica normalmente chiusa (comando proporzionale 0-10 V). Compatibile con tutti i vitoni termostattizzabili IVAR.**
- *Electrothermal head normally closed (proportional control 0-10 V). Suitable for all IVAR thermostatic inserts.*
- **Tête électrothermique normalement fermée (commande proportionnel 0-10 V). Adaptée pour tous les inserts thermostatisables IVAR.**
- *Elektrothermischer Stellantrieb normalerweise geschlossen (proportional Steuerung 0-10 V). Geeignet für alle Thermostat-Regulievorrichtungen IVAR.*
- **Cabeza electrotérmica normalmente cerrada (control proporcional 0-10 V). Adecuada para todos los tornillos termostatzables IVAR.**

Code	Size	Price	Class	Packaging
500887	M30 x 1,5 ; Proportional 0-10 V (24 V AC)	126,64 €	AC	100

VA 80

- **Ghiera per teste elettrotermiche.**
- *Ring nut for electrothermal heads.*
- **Bague fileté pour têtes électrothermiques.**
- *Ring für Elektrothermischer Stellantriebe.*
- **Anillo para cabezas electrotérmicas.**

Code	Size	Price	Class	Packaging
501533	M30 x 1,5	3,441 €	AC	50 / 400

The delivery temperature of the hydronic system is one of the essential parameters that needs to be controlled to keep the environment comfortable. With sector mixer valves, this control is usually entrusted to the combination of a servomotor mounted on the valve and an external regulator. The CC25 and CTC20 servomotors integrate the regulation logic and the devices necessary to manage the mixed circuit without needing additional components.

CTC20 makes fixed point regulation possible (in heating and cooling) and has an outlet for the secondary circulation pump.

CC25 is an actual climatic regulator for heating/cooling complete with external probe, secondary pump outlet and touch-screen display for programming. It can also connect several servomotors via bus which share external temperature information during regulation.

Both devices can be applied to traditional sector valves (3-way or 4-way) and to the mixing units of the VARIMIX system.

CTC 20



- **Attuatore rotativo con regolatore e sonde incorporati per il controllo a punto fisso delle valvole miscelatrici.**
- *Revolving actuator with incorporated regulator and probes for fixed point control of mixing valves.*
- **Actionneur rotatif avec régulateur et sondes incorporés pour le contrôle à point fixe des vannes mélangeuses.**
- *Drehbar Stellantrieb mit eingebauter Regler und Fühler für festwert Bedingung der Mischventile.*
- **Actuador rotativo con regulador y sondas incorporados para el control a punto fijo de las válvulas mezcladoras.**

Code	Size	Price	Class	Packaging
501648	230 V AC	477,76 €	PC	1

CC 25



- **Attuatore rotativo con regolatore e sonde incorporati per controllo climatico delle valvole miscelatrici.**
- *Revolving actuator with incorporated regulator and probes for climatic control of mixing valves.*
- **Actionneur rotatif avec régulateur et sondes incorporés pour le contrôle climatique des vannes mélangeuses.**
- *Drehbar Stellantrieb mit eingebauten Regler und Fühler für klimatisch Bedingung der Mischventile.*
- **Actuador rotativo con regulador y sondas incorporados para el control climático de las válvulas mezcladoras.**

Code	Size	Price	Class	Packaging
501647	230 V AC	949,28 €	PC	1

M 106



- **Servomotore per valvole miscelatrici a settore.**
- *Motor for rotor mixing valves.*
- **Servomoteur pour vannes mélangeuses à rotor.**
- *Stellantrieb für Rotor-Mischventile.*
- **Servomotor para válvulas mezcladoras de rotor.**

Code	Size	Price	Class	Packaging
501394	3-point regulation (230 V AC)	167,29 €	PC	1 / 8
501395	Proportional 0-10 V (24 V AC)	337,66 €	PC	8
501396	3-point regulation (24 V AC)	200,34 €	PC	10

RV 01



- **Servomotore assiale. Compatibile con tutti i vitoni termostatici IVAR.**
- *Axial motor. Suitable for all IVAR thermostatic inserts.*
- **Servomoteur axial. Adapté pour tous les inserts thermostatiques IVAR.**
- *Axial-Stellantrieb. Geeignet für alle Thermostat-Regulervorrichtungen IVAR.*
- **Servomotor axial. Adecuado para todos los tornillos termostáticos IVAR.**

Code	Size	Price	Class	Packaging
501381	M30 x 1,5 - 3-point regulation (230 V AC)	141,88 €	PC	100
501383	M30 x 1,5 - Proportional 0-10 V (24 V AC/DC)	164,60 €	PC	100

WIRING ACCESSORIES

The offer of the environment regulation devices is completed with two further accessories which make it extremely easy to wire standard systems with one or more thermostats: CBL 01 and ALC 01. The first is a simple relay board which can be connected to a consent for the heating demand and activates the secondary pump (for floor system with mixing and booster unit), activates the boiler and connects the safety thermostat to interrupt the secondary pump in case of overtemperature.

ALC 01 is a connection unit which can be powered at 230 V AC or 24 V AC and makes it possible to connect up to 8 thermostats for the independent management of 8 zones. It has just as many outlets to switch the electrothermal heads applied to the distribution manifolds on/off. ALC 01 can also activate the secondary pump or the boiler if there is a heating demand in at least one zone.

■ CBL 01



- **Scatola di cablaggio con scheda elettrica per regolazione a punto fisso.**
- *Wiring box with electric card for fixed point adjustment.*
- **Boîtier de câblage avec carte électrique pour régulation à point fixe.**
- *Anschlusskasten mit Platine zur festen Temperaturregelung.*
- **Caja de cableado con tarjeta eléctrica para ajuste a punto fijo.**

Code	Size	Price	Class	Packaging
501828I	230 V AC	93,45 €	VA	4 / 32

■ ALC 01



- **Wiring center per controlli di zona (max 8 zone).**
- *Wiring center for zone control (max 8 zones).*
- **Wiring center pour contrôle de zone (max 8 zones).**
- *Wiring center für Zonenkontrolle (max. 8 Zonen).*
- **Wiring center para control de zona (máximo 8 zonas).**

Code	Size	Price	Class	Packaging
ALC01	230 V AC / 24 V AC	191,54 €	VA	1



SAFETY THERMOSTATS

■ AC 614



- Termostato di sicurezza regolabile a contatto.
- Adjustable contact safety thermostat.
- Thermostat de sécurité réglable à contact.
- Einstellbarer berührendes Sicherheitsthermostat.
- Termostato de seguridad regulable a contacto.

Code	Price	Class	Packaging
580002	26,52 €	VA	10

■ AC 616



- Termostato di sicurezza regolabile con sonda ad immersione.
- Adjustable safety thermostat with immersion probe.
- Thermostat de sécurité réglable avec sonde à immersion.
- Einstellbarer Tauchhülse-Sicherheitsthermostat.
- Termostato de seguridad regulable con sonda de inmersión.

Code	Price	Class	Packaging
580003	49,16 €	VA	6

■ AC 616 I



- Termostato di sicurezza regolabile con sonda a distanza.
- Adjustable safety thermostat with distance thermometer.
- Thermostat de sécurité réglable avec sonde à distance.
- Einstellbarer Sicherheitsthermostat mit Fernfühler.
- Termostato de seguridad regulable con sonda a distancia.

Code	Price	Class	Packaging
580007	50,29 €	VA	8

■ AC 634



- Termostato di sicurezza a taratura fissa.
- Safety thermostat with fixed setting.
- Thermostat de sécurité à graduation fixe.
- Sicherheitsthermostat mit Fixkalibrierung.
- Termostato de seguridad con calibración fija.

Code	Size	Max operating temp.	Price	Class	Packaging
580020	1/2" M	40 °C	36,63 €	VA	8 / 64
580009	1/2" M	60 °C	35,22 €	VA	8 / 64

■ AC 608



- Kit di collegamento elettrico per la connessione in serie di termostato di sicurezza e pompa.
- Electrical connection kit for connection in series of safety thermostat and pump.
- Kit de connexion électrique pour la connexion en série d'un thermostat de sécurité et de la pompe.
- Elektrischer Anschluss-Bausatz für die Verbindung in Reihe der Sicherheitsthermostat und der Pumpe.
- Kit de conexión eléctrica para la conexión en serie de termostato de seguridad y de la bomba.

Code	Price	Class	Packaging
501370	37,01 €	VA	14

■ AC 613 C



- Termostato di sicurezza regolabile precablato a contatto.
- Pre-wired adjustable contact safety thermostat.
- Thermostat de sécurité réglable pré-câblé à contact.
- Einstellbarer berührendes Sicherheitsthermostat, vorverdrahtet.
- Termostato de seguridad regulable precableado a contacto.

Code	Price	Class	Packaging
580000	69,35 €	VA	1 / 8

■ AC 613 S



- Termostato di sicurezza precablato con sonda ad immersione.
- Pre-wired safety thermostat with immersion probe.
- Thermostat de sécurité pré-câblé avec sonde à immersion.
- Einstellbarer Tauchhülse-Sicherheitsthermostat, vorverdrahtet.
- Termostato de seguridad regulable precableado con sonda de inmersión.

Code	Price	Class	Packaging
580001	91,81 €	VA	1 / 8

■ AC 613 SI



- Termostato di sicurezza regolabile precablato con sonda a distanza.
- Pre-wired adjustable safety thermostat with distance thermometer.
- Thermostat de sécurité réglable pré-câblé avec sonde à distance.
- Einstellbarer Sicherheitsthermostat mit Fernfühler, vorverdrahtet.
- Termostato de seguridad regulable precableado con sonda a distancia.

Code	Price	Class	Packaging
580008	92,98 €	VA	1 / 8

■ AC 613 F



- Termostato di sicurezza a taratura fissa precablato.
- Pre-wired safety thermostat with fixed setting.
- Thermostat de sécurité à graduation fixe pré-câblé.
- Vorverkabeltes Sicherheitsthermostat mit feststehender Einstellung.
- Termostato de seguridad con calibración fija precableado.

Code	Size	Max operating temp.	Price	Class	Packaging
580014	1/2" M	60 °C	72,81 €	VA	1 / 8

HYDRAULIC BALANCING

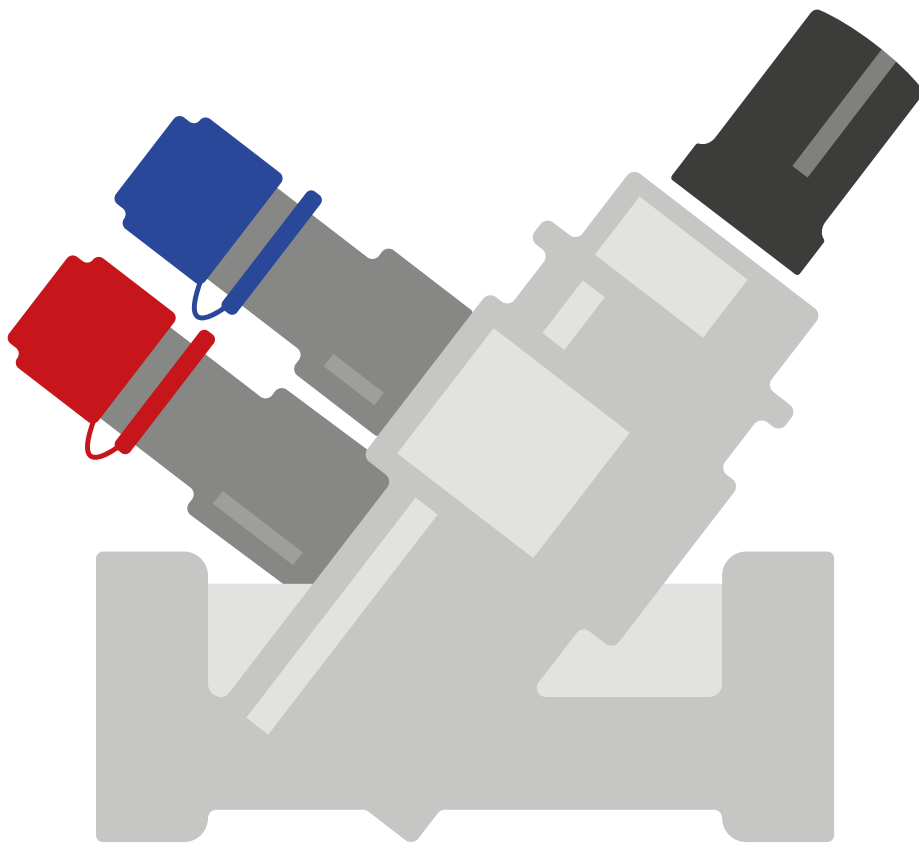

pim.ivar-group.com/short/IT-07

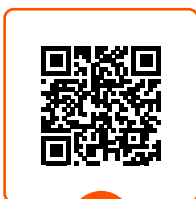

DOWNLOAD
Focus tecnici



pim.ivar-group.com/short/FR-07

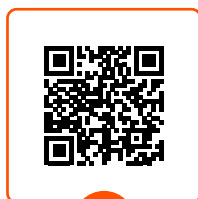

DOWNLOAD
Détails techniques



pim.ivar-group.com/short/DE-07

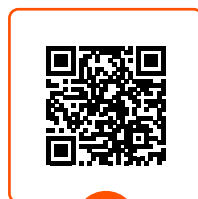

DOWNLOAD
Technische Details



pim.ivar-group.com/short/ES-07



DOWNLOAD
Profundizaciones técnicas



**Valvole di bilanciamento statico***Static balancing valves***Vannes d'équilibrage statique***Statisches Ausgleichsventile***Válvulas de equilibrio estático****368****Valvole di bilanciamento dinamico PICV***PICV dynamic balancing valves***Vannes d'équilibrage dynamique PICV***Dynamische Abgleichventile PICV***Válvulas de equilibrio dinámico PICV****370****EQUIFLUID - Valvole di bilanciamento per la regolazione della pressione differenziale***EQUIFLUID - Balancing valves for differential pressure adjustment***EQUIFLUID - Vannes d'équilibrage pour le réglage de la pression différentielle***EQUIFLUID - Ausgleichsventile für die Regelung des Differenzdrucks***EQUIFLUID - Válvulas de equilibrio para la regulación de la presión diferencial****378**



STATIC BALANCING VALVES

These balancing valves allow suitable pressure drops to occur to ensure that each branch of the circuit has the required design flow rate.

These are equipped with suitable pressure ports, which, when placed at the ends of a calibrated hole, allow the differential pressure, Δp , directly attributable to the flow through the valve, to be determined using a special kit (AVB 20).

Depending on the position of the hole in the valve, a distinction can be made between valves with a fixed orifice VB 00, where the pressure ports are read across a calibrated passage (Venturi), and valves with a variable orifice VB 10, where the pressure ports are across the shutter.

The VB 00 (fixed orifice), with a fixed Kv value, allows the flow rate to be read immediately based on the measured Δp . Therefore, these are particularly suitable for performing line operations (measurement, adjustment) accurately. On the other hand, the VB10 requires a measurement of Δp and a Kv graph for each adjustment position, which is less immediate, but which provides a good measurement of Δp even with very low flow rates.

VB 00



- Valvola di bilanciamento statico ad orifizio fisso.
* Il valore KVs indica il KV del Venturi e non quello dell'intera tavola.
- Static balancing valve with a fixed bore.
* The KVs value indicates the KV of the Venturi and not that of the entire panel.
- Vanne d'équilibrage statique à orifice fixe.
* La valeur KVs indique le KV du Venturi et pas celui de toute la planche.
- Festwert Strangregulierventil mit fester Öffnung.
* Der KVs Wert bezieht sich auf den KV der Venturi-Rohre, nicht der gesamten Platte.
- Válvula de equilibrio estático de orificio fijo.
* El valor KVs indica el KV del Venturi y no toda la tabla.

Code	Size	Price	Class	Packaging
509067	1/2" F x 1/2" F - 2,80 KVs*	120,33 €	TE	1 / 8
509068	3/4" F x 3/4" F - 5,33 KVs*	119,76 €	TE	1 / 8
509069	1" F x 1" F - 9,72 KVs*	145,36 €	TE	1 / 8
509070	1"1/4 F x 1"1/4 F - 20,25 KVs*	174,79 €	TE	1 / 8
509071	1"1/2 F x 1"1/2 F - 30,23 KVs*	196,39 €	TE	1 / 8
509072	2" F x 2" F - 55,07 KVs*	294,48 €	TE	1 / 8

VB 10



- Valvola di bilanciamento statico ad orifizio variabile.
- Static balancing valve with a variable bore.
- Vanne d'équilibrage statique à orifice variable.
- Statisches Ausgleichsventil mit variabler Öffnung.
- Válvulas de equilibrio estático de orificio variable.

Code	Size	Price	Class	Packaging
509135	1/2" F x 1/2" F - 2,67 KV max	104,05 €	TE	2 / 8
509136	3/4" F x 3/4" F - 4,10 KV max	119,01 €	TE	2 / 8
509137	1" F x 1" F - 6,40 KV max	131,43 €	TE	1 / 4
509138	1"1/4 F x 1"1/4 F - 12,00 KV max	158,03 €	TE	1 / 4
509139	1"1/2 F x 1"1/2 F - 19,50 KV max	196,20 €	TE	1 / 4
509140	2" F x 2" F - 29,80 KV max	275,87 €	TE	1 / 4

VB 20



- Valvole di bilanciamento in ghisa.
- Cast iron balancing valves.
- Vannes d'équilibrage en fonte.
- Abgleichventile aus Grauguss.
- Válvulas de equilibrado de fundición.

Code	Size	Price	Class	Packaging
509170	DN 50	377,23 €	TH	1
509171	DN 65	613,73 €	TH	1
509172	DN 80	813,37 €	TH	1
509173	DN 100	1.130,57 €	TH	1
509174	DN 125	1.584,54 €	TH	1
509175	DN 150	2.379,53 €	TH	1
509176	DN 200	4.651,94 €	TH	1
509177	DN 250	8.128,70 €	TH	1
509178	DN 300	11.697,15 €	TH	1

AVB 20



- Kit di misurazione elettronica di portata e pressione differenziale.
- Electronic capacity and differential pressure measurement kit.
- Kit de mesurage électronique de débit et pression différentielle.
- Bausatz zur elektronischen Messung von Volumenstrom und Differenzdruck.
- Kit de medición electrónica de caudal y presión diferencial.

Code	Included Accessories	Price	Class	Packaging
509089		2.300,12 €	TE	1
509133	Database included (to be used with an App)	5.735,32 €	TE	1

AVB 00

- Presa piezometrica con scarico.
- Piezometric socket with discharge.
- Prise piézométrique avec décharge.
- Piezometrischer Messventil mit Abfluss.
- Toma piezométrica con descarga.

Code	Size	Price	Class	Packaging
509087	1/4" M	33,58 €	TE	1

TM 00

- Tronchetto in acciaio inox assemblabile tra flange per la lettura indiretta della portata.
- Stainless steel riser fitted between flanges for indirect readout of capacity.
- Cylindre en acier inox assemblable entre les brides pour la lecture indirecte du débit.
- Zwischen Flanschen einsetzbares Rohrstück aus Edelstahl zum indirekten Abmessung des Volumenstroms.
- Tronco de acero inox ensamblable entre bridas para la lectura indirecta de la capacidad.

Code	Kv	Size	Price	Class	Packaging
509078	88.20	2"1/2	515,57 €	TE	1
509079	123	3"	578,79 €	TE	1
509080	215.60	4"	657,05 €	TE	1

AVB 10

- Presa piezometrica.
- Piezometric socket.
- Prise piézométrique.
- Piezometrischer Messventil.
- Toma piezométrica.

Code	Size	Color	Price	Class	Packaging
509088B	1/4" M	■	6,78 €	TE	100
509088R	1/4" M	■	6,78 €	TE	100

TM 10

- Tronchetto per la lettura indiretta della portata.
- Riser for indirect readout of capacity.
- Cylindre pour la lecture indirecte du débit.
- Rohrstück zum indirekten Abmessung des Volumenstroms.
- Tronco para la lectura indirecta de la capacidad.

Code	Kv	Size	Color	Price	Class	Packaging
509081	2.80	1/2" M x 1/2" F	■ / ■	43,17 €	TE	1
509082	5.33	3/4" M x 3/4" F	■ / ■	46,59 €	TE	1
509083	9.72	1" M x 1" F	■ / ■	57,17 €	TE	1
509084	20.25	1"1/4 M x 1"1/4 F	■ / ■	70,65 €	TE	1
509085	30.23	1"1/2 M x 1"1/2 F	■ / ■	83,67 €	TE	1
509086	55.07	2" M x 2" F	■ / ■	106,16 €	TE	1



PICV (Pressure Independent Control Valves) are dynamic balancing valves, which, thanks to a diaphragm device with a contrast spring, are able to maintain a constant flow rate within a certain range of differential pressure.

These devices consist of a valve body that can be combined with an insert depending on the type of operation and the required working conditions (flow rate, differential pressure). There are four types of inserts:

- PICC 01/11, available in different models for valves from DN 15 to DN 32. This insert makes it possible to pre-calibrate the flow rate with up to 8 available levels/positions, while providing for its stabilisation, even in case of pressure variations.
- PICC 02/12/22, available in different models for valves from DN 15 to DN 50, which transforms the PICV valve into a flow stabiliser. Using a special key a position/range can be selected from among the 41 available on each insert. The advantage compared to PICC 01/11 is that the calibration position can be changed directly from the outside and while the system is running.
- PICC 03/13, available in different models for valves from DN 15 to DN 32. This insert has similar features to the previous one, namely it stabilises the flow rate and the choice of 41 different flow positions, but it also can be fitted with an on/off or 0-10 V axial actuator. This way it is possible to provide for the cut off of the valve, but also and above all, the modulation of the flow rate regardless of the differential pressure. Actually, the valve limits the maximum flow rate, modulating it independently of the pressure at the ends of the insert.
- PICC 20, available in over 100 different models for DN 65 and DN 80 sizes. These inserts guarantee a single flow rate value within a pre-set range of differential pressure.

PLUS

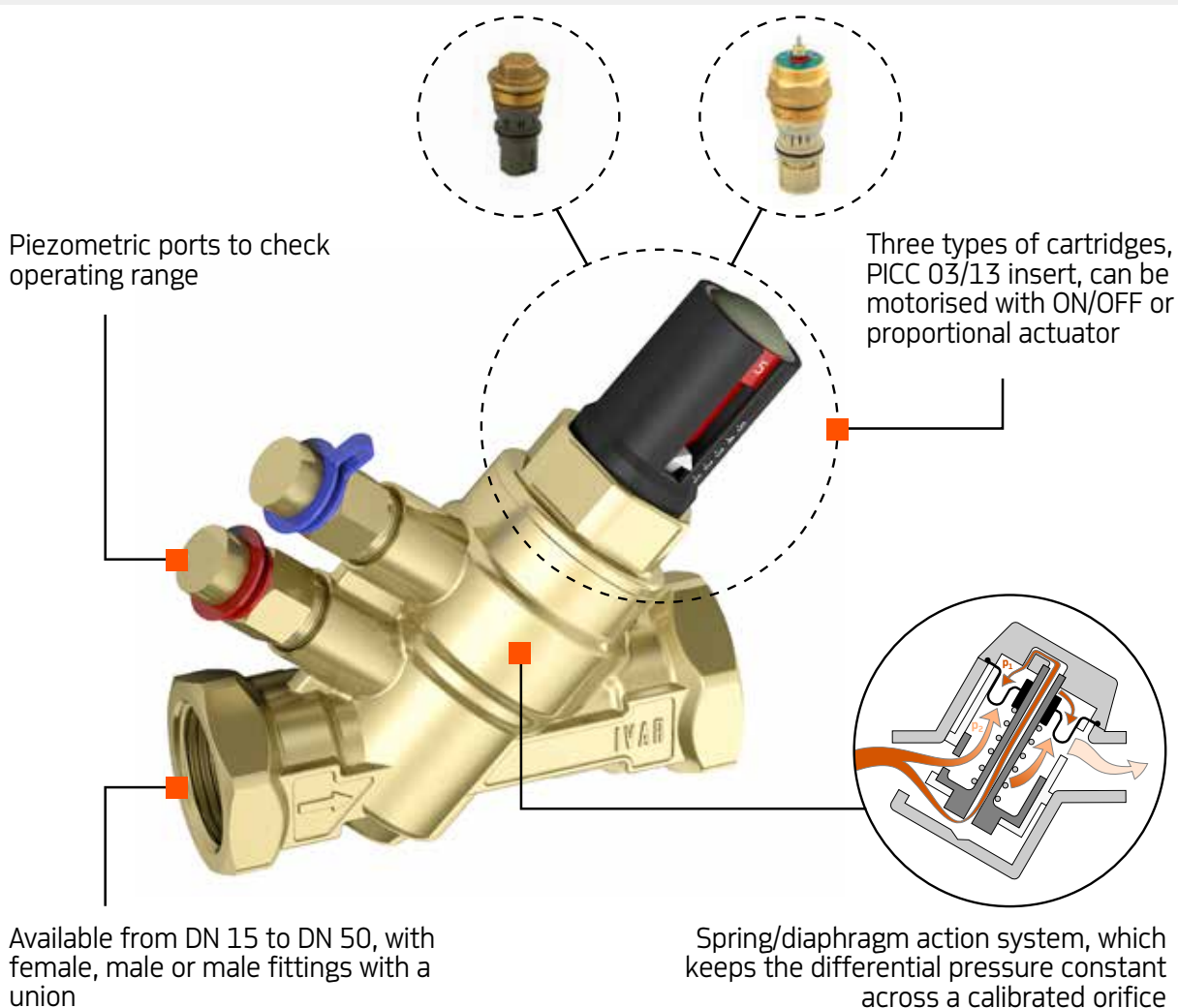

The most suitable regulating cartridge can be chosen for each valve:

PICC 01

PICC 11

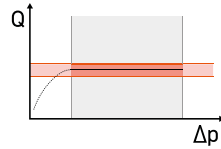

Automatically stabilises the flow rate at the value set

Δp : 20-130/40-400/15-130/22-300/30-410 kPa

PICC 02

PICC 12

PICC 22

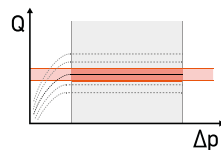

Automatically stabilises the flow rate at the value set, adjustable even when the system is running

Δp : 17-210/17-200/30-400/35-400/17-400/20-400 kPa

PICC 03

PICC 13

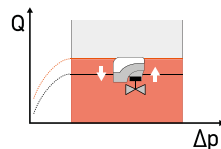

Stabilises the flow rate at the value determined by an external control. Even in modulation, its authority is always 100%.

Δp : 16-200/30-400/16-400 kPa

PICC 20

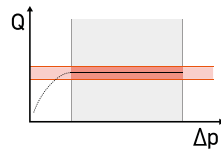

Available in sizes DN 65/80, it automatically stabilises the flow rate at the value set

Δp : 10-135/28-135/22-210/55-210/40-390/90-880 kPa

Static balancing

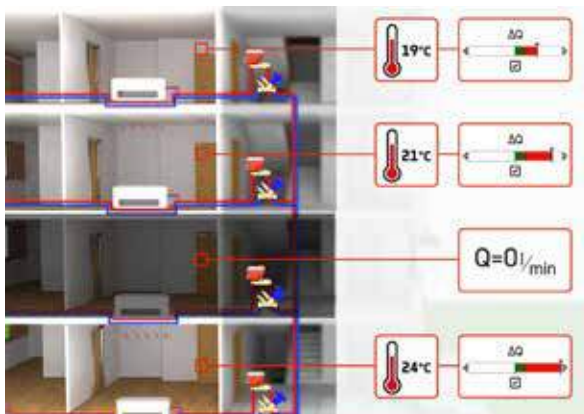

Turning the individual components on and off in the different branches of the system causes hydraulic imbalances in the lines, which can lead to inconvenient situations (excessive or insufficient temperatures) and a waste of energy.

Dynamic balancing

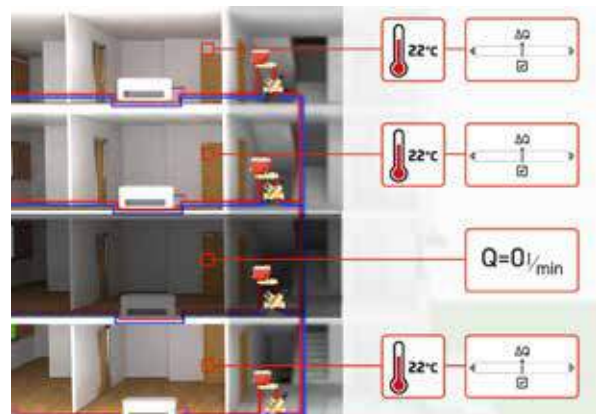

Even with these variations, PICV valves react by avoiding hydraulic imbalances in the circuits and keeping a constant flow rate at the terminals served.

PICV 00



- **Corpo valvola di bilanciamento dinamico, completo di tappo e predisposizione per prese piezometriche. Connessioni femmina – femmina**
- *Dynamic balancing valve body, complete with plug and arrangement for piezometric inlets. Female - female connections.*
- **Corps de vanne d'équilibrage dynamique, avec bouchon et prédisposition pour prises piézométriques. Connexions femelle - femelle**
- *Körper dynamisches Abgleichventil, komplett mit Kappe und Vorrüstung für Piezometeranschlüsse. IG - IG anschlüsse*
- **Cuerpo de válvula de equilibrado dinámico provisto de tapón y preparado para tomas piezométricas. Conexiones hembra - hembra**

Code	Size	Color	Price	Class	Packaging
590065	1/2" F x 1/2" F	■	41,22 €	TE	5 / 40
590066	3/4" F x 3/4" F	■	41,22 €	TE	5 / 40
590141	1" F x 1" F	■	47,98 €	TE	4 / 16

PICV 100



- **Corpo valvola di bilanciamento dinamico, completo di tappo e predisposizione per prese piezometriche. Connessioni femmina – femmina**
- *Dynamic balancing valve body, complete with plug and arrangement for piezometric inlets. Female - female connections.*
- **Corps de vanne d'équilibrage dynamique, avec bouchon et prédisposition pour prises piézométriques. Connexions femelle - femelle**
- *Körper dynamisches Abgleichventil, komplett mit Kappe und Vorrüstung für Piezometeranschlüsse. IG - IG anschlüsse*
- **Cuerpo de válvula de equilibrado dinámico provisto de tapón y preparado para tomas piezométricas. Conexiones hembra - hembra**

Code	Size	Color	Price	Class	Packaging
590067	1" F x 1" F	■	138,53 €	TE	2 / 8
590068	1"1/4 F x 1"1/4 F	■	138,53 €	TE	2 / 16

PICV 05



- **Corpo valvola di bilanciamento dinamico, completo di tappo e predisposizione per prese piezometriche. Connessioni maschio – maschio**
- *Dynamic balancing valve body, complete with plug and arrangement for piezometric inlets. Male - male connections.*
- **Corps de vanne d'équilibrage dynamique, avec bouchon et prédisposition pour prises piézométriques. Connexions mâle - mâle**
- *Körper dynamisches Abgleichventil, komplett mit Kappe und Vorrüstung für Piezometeranschlüsse. AG - AG anschlüsse*
- **Cuerpo de válvula de equilibrado dinámico provisto de tapón y preparado para tomas piezométricas. Conexiones macho - macho**

Code	Size	Color	Price	Class	Packaging
590099	EUROK x EUROK	■	42,16 €	TE	5 / 40
590069	3/4" M x 3/4" M	■	42,16 €	TE	5 / 40
590144	1" M x 1" M	■	49,32 €	TE	2 / 8
590145	1"1/4 M x 1"1/4 M	■	49,32 €	TE	2 / 8

PICV 105



- **Corpo valvola di bilanciamento dinamico, completo di tappo e predisposizione per prese piezometriche. Connessioni maschio – maschio**
- *Dynamic balancing valve body, complete with plug and arrangement for piezometric inlets. Male - male connections.*
- **Corps de vanne d'équilibrage dynamique, avec bouchon et prédisposition pour prises piézométriques. Connexions mâle - mâle**
- *Körper dynamisches Abgleichventil, komplett mit Kappe und Vorrüstung für Piezometeranschlüsse. AG - AG anschlüsse*
- **Cuerpo de válvula de equilibrado dinámico provisto de tapón y preparado para tomas piezométricas. Conexiones macho - macho**

Code	Size	Color	Price	Class	Packaging
590070	1" M x 1" M	■	136,37 €	TE	2 / 8
590071	1"1/4 M x 1"1/4 M	■	136,37 €	TE	2 / 8
590072	1"1/2 M x 1"1/2 M	■	137,18 €	TE	2 / 8

PICV 10



- **Corpo valvola di bilanciamento dinamico, completo di tappo e predisposizione per prese piezometriche. Connessioni maschio – maschio con bocchettone.**
- *Dynamic balancing valve body, complete with plug and arrangement for piezometric inlets. Male - male with fitting connections.*
- **Corps de vanne d'équilibrage dynamique, avec bouchon et prédisposition pour prises piézométriques. Connexions mâle - mâle avec raccord.**
- *Körper dynamisches Abgleichventil, komplett mit Kappe und Vorrüstung für Piezometeranschlüsse. AG - AG Anschlüsse mit Stutzen.*
- **Cuerpo de válvula de equilibrado dinámico provisto de tapón y preparado para tomas piezométricas. Conexiones macho - macho con manguito.**

Code	Size	Color	Price	Class	Packaging
590073	1/2" M x 1/2" M	■	53,52 €	TE	5 / 40
590148	3/4" M x 3/4" M	■	64,21 €	TE	2 / 16
590149	1" M x 1" M	■	68,25 €	TE	2 / 16

PICV 110



- **Corpo valvola di bilanciamento dinamico, completo di tappo e predisposizione per prese piezometriche. Connessioni maschio – maschio con bocchettone**
- *Dynamic balancing valve body, complete with plug and arrangement for piezometric inlets. Male - male with fitting connections.*
- **Corps de vanne d'équilibrage dynamique, avec bouchon et prédisposition pour prises piézométriques. Connexions mâle - mâle avec raccord.**
- *Körper dynamisches Abgleichventil, komplett mit Kappe und Vorrüstung für Piezometeranschlüsse. AG - AG Anschlüsse mit Stutzen.*
- **Cuerpo de válvula de equilibrado dinámico provisto de tapón y preparado para tomas piezométricas. Conexiones macho - macho con manguito.**

Code	Size	Color	Price	Class	Packaging
590074	3/4" M x 3/4" M	■	151,23 €	TE	2 / 16
590075	1" M x 1" M	■	157,05 €	TE	2 / 16
590076	1"1/4 M x 1"1/4 M	■	170,96 €	TE	2 / 16

PICC 01

- Cartuccia per la stabilizzazione della portata. Fino ad 8 valori di portata importabili. Compatibile con PICV 00/05/10.
- Cartridge for stabilising the flow rate. Up to 8 flow rate values. Suitable for PICV 00/05/10.
- Cartouche pour la stabilisation du débit. Jusqu'à 8 valeurs de débit configurables. Adaptée pour PICV 00/05/10.
- Einsatz für Stabilisierung des Durchflusses. Bis zu 8 mögliche Durchflusswerte. Geeignet für PICV 00/05/10.
- Cartucho para estabilizar el caudal. Hasta 8 valores de caudal disponibles. Adecuada para PICV 00/05/10.

Code	Size	Color	Price	Class	Packaging
590100	20-130 kPa; 29-155 l/h	■	49,80 €	TE	1
590101	20-130 kPa; 207-430 l/h	■	49,80 €	TE	1
590102	20-130 kPa; 223-526 l/h	■	49,80 €	TE	1
590103	20-130 kPa; 162-695 l/h	■	49,80 €	TE	1
590104	20-130 kPa; 352-984 l/h	■	49,80 €	TE	1
590105	40-400 kPa; 42-250 l/h	■	49,80 €	TE	1
590106	40-400 kPa; 281-653 l/h	■	49,80 €	TE	1
590107	40-400 kPa; 203-792 l/h	■	49,80 €	TE	1
590108	40-400 kPa; 215-998 l/h	■	49,80 €	TE	1
590109	40-400 kPa; 493-1470 l/h	■	49,80 €	TE	1

PICC 03

• TE 3003 >> p. 376



• RV 03 >> p. 376

- Cartuccia per la limitazione e modulazione della portata indipendente dalla pressione. 41 valori di portata importabili. Compatibile con PICV 00/05/10.
- Cartridge for limiting and modulating the flow rate independently of the pressure. 41 settable flow rate values. Suitable for PICV 00/05/10.
- Cartouche pour la limitation et la modulation du débit indépendamment de la pression. 41 valeurs de débit configurables. Adaptée pour PICV 00/05/10.
- Einsatz für Begrenzung und Modulation des Durchflusses unabhängig von Druck. 41 mögliche Durchflusswerte. Geeignet für PICV 00/05/10.
- Cartucho para limitar y modular el caudal independientemente de la presión. 41 valores de caudal disponibles. Adecuada para PICV 00/05/10.

Code	Size	Color	Price	Class	Packaging
590123	16-200 kPa; 37-575 l/h	■	91,30 €	TE	1
590124	30-400 kPa; 64-1110 l/h	■	91,30 €	TE	1
590127	35-800 kPa; 620-2650 l/h	■	98,23 €	TE	1

PICC 12

- Cartuccia per la stabilizzazione della portata. 41 valori di portata impostabili dall'esterno e ad impianto funzionante. Compatibile con PICV 100/105/110.
- Cartridge for stabilising the flow rate. 41 flow rate values settable from the outside and when system is in function. Suitable for PICV 100/105/110.
- Cartouche pour la stabilisation du débit. 41 valeurs de débit configurables de l'extérieur et avec le système en marche. Adaptée pour PICV 100/105/110.
- Einsatz für Stabilisierung des Durchflusses. 41 Durchflusswerte einstellbaren von der Außenseite und mit dem Systemlauf. Geeignet für PICV 100/105/110.
- Cartucho para estabilizar el caudal. 41 valores de caudal ajustables desde el exterior y con el sistema en funcionamiento. Adecuada para PICV 100/105/110.

Code	Size	Color	Price	Class	Packaging
590122	17-400 kPa; 535-5830 l/h	■	137,74 €	TE	1

PICC 02

- Cartuccia per la stabilizzazione della portata. 41 valori di portata impostabili dall'esterno e ad impianto funzionante. Compatibile con PICV 00/05/10.
- Cartridge for stabilising the flow rate. 41 flow rate values settable from the outside and when system is in function. Suitable for PICV 00/05/10.
- Cartouche pour la stabilisation du débit. 41 valeurs de débit configurables de l'extérieur et avec le système en marche. Adaptée pour PICV 00/05/10.
- Einsatz für Stabilisierung des Durchflusses. 41 Durchflusswerte einstellbaren von der Außenseite und mit dem Systemlauf. Geeignet für PICV 00/05/10.
- Cartucho para estabilizar el caudal. 41 valores de caudal ajustables desde el exterior y con el sistema en funcionamiento. Adecuada para PICV 00/05/10.

Code	Size	Color	Price	Class	Packaging
590116	17-210 kPa; 100-412 l/h	■	62,73 €	TE	1
590117	17-210 kPa; 157-609 l/h	■	62,73 €	TE	1
590118	17-200 kPa; 276-825 l/h	■	62,73 €	TE	1
590119	30-400 kPa; 406-1270 l/h	■	62,73 €	TE	1
590120	35-400 kPa; 138-615 l/h	■	62,73 €	TE	1
590121	35-400 kPa; 238-896 l/h	■	62,73 €	TE	1

PICC 11

- Cartuccia per la stabilizzazione della portata. Fino ad 8 valori di portata impostabili. Compatibile con PICV 100/105/110.
- Cartridge for stabilising the flow rate. Up to 8 flow rate values. Suitable for PICV 100/105/110.
- Cartouche pour la stabilisation du débit. Jusqu'à 8 valeurs de débit configurables. Adaptée pour PICV 100/105/110.
- Einsatz für Stabilisierung des Durchflusses. Bis zu 8 mögliche Durchflusswerte. Geeignet für PICV 100/105/110.
- Cartucho para estabilizar el caudal. Hasta 8 valores de caudal disponibles. Adecuada para PICV 100/105/110.

Code	Size	Color	Price	Class	Packaging
590110	15-130 kPa; 612-2380 l/h	□	90,40 €	TE	1
590111	15-130 kPa; 936-3060 l/h	■	90,40 €	TE	1
590112	22-300 kPa; 828-3020 l/h	□	90,40 €	TE	1
590113	22-300 kPa; 1370-4360 l/h	■	90,40 €	TE	1
590114	30-410 kPa; 972-3560 l/h	□	90,40 €	TE	5
590115	30-410 kPa; 1580-5150 l/h	■	90,40 €	TE	1

PICC 13

• RV 03 >> p. 376

- Cartuccia per la limitazione e modulazione della portata indipendente dalla pressione. 41 valori di portata importabili. Compatibile con PICV 100/105/110.
- Cartridge for limiting and modulating the flow rate independently of the pressure. 41 settable flow rate values. Suitable for PICV 100/105/110.
- Cartouche pour la limitation et la modulation du débit indépendamment de la pression. 41 valeurs de débit configurables. Adaptée pour PICV 100/105/110.
- Einsatz für Begrenzung und Modulation des Durchflusses unabhängig von Druck. 41 mögliche Durchflusswerte. Geeignet für PICV 100/105/110.
- Cartucho para limitar y modular el caudal independientemente de la presión. 41 valores de caudal disponibles. Adecuada para PICV 100/105/110.

Code	Size	Color	Price	Class	Packaging
590125	16-400 kPa; 865-4630 l/h	■	224,40 €	TE	1

PICV 200



- **Corpo valvola di bilanciamento dinamico, completo di tappo e predisposizione per prese piezometriche. Connessioni femmina - femmina**
- *Dynamic balancing valve body, complete with plug and arrangement for piezometric inlets. Female - female connections.*
- **Corps de vanne d'équilibrage dynamique, avec bouchon et prédisposition pour prises piézométriques. Connexions femelle - femelle**
- *Körper dynamisches Abgleichventil, komplett mit Kappe und Vorrüstung für Piezometeranschlüsse. IG - IG anschlüsse*
- **Cuerpo de válvula de equilibrado dinámico provisto de tapón y preparado para tomas piezométricas. Conexiones hembra - hembra**

Code	Size	Color	Price	Class	Packaging
590142	1"1/2 F x 1"1/2 F	Yellow	224,34 €	TE	2
590143	2" F x 2" F	Yellow	251,37 €	TE	2

PICV 210



- **Corpo valvola di bilanciamento dinamico, completo di tappo e predisposizione per prese piezometriche. Connessioni maschio - maschio con bocchettone**
- *Dynamic balancing valve body, complete with plug and arrangement for piezometric inlets. Male - male with fitting connections.*
- **Corps de vanne d'équilibrage dynamique, avec bouchon et prédisposition pour prises piézométriques. Raccords mâle - mâle avec raccord**
- *Körper dynamisches Abgleichventil, komplett mit Kappe und Vorrüstung für Piezometeranschlüsse. AG - AG Anschlüsse mit Stutzen.*
- **Cuerpo de válvula de equilibrado dinámico provisto de tapón y preparado para tomas piezométricas. Conexiones macho - macho con manguito**

Code	Size	Color	Price	Class	Packaging
590150	1"1/2 M x 1"1/2 M	Yellow	264,88 €	TE	27
590151	2" M x 2" M	Yellow	291,91 €	TE	27

PICV 205



- **Corpo valvola di bilanciamento dinamico, completo di tappo e predisposizione per prese piezometriche. Connessioni maschio - maschio**
- *Dynamic balancing valve body, complete with plug and arrangement for piezometric inlets. Male - male connections.*
- **Corps de vanne d'équilibrage dynamique, avec bouchon et prédisposition pour prises piézométriques. Connexions mâle - mâle**
- *Körper dynamisches Abgleichventil, komplett mit Kappe und Vorrüstung für Piezometeranschlüsse. AG - AG anschlüsse*
- **Cuerpo de válvula de equilibrado dinámico provisto de tapón y preparado para tomas piezométricas. Conexiones macho - macho**

Code	Size	Color	Price	Class	Packaging
590146	2" M x 2" M	Yellow	209,49 €	TE	2
590147	2"1/2 M x 2"1/2 M	Yellow	236,52 €	TE	2

PICC 22



- **Cartuccia per la stabilizzazione della portata. 41 valori di portata impostabili dall'esterno e ad impianto funzionante. Compatibile con PICV 200/205/210.**
- *Cartridge for stabilising the flow rate. 41 flow rate values settable from the outside and when system is in function. Suitable for PICV 200/205/210.*
- **Cartouche pour la stabilisation du débit. 41 valeurs de débit configurables de l'extérieur et avec le système en marche. Adaptée pour PICV 200/205/210.**
- *Einsatz für Stabilisierung des Durchflusses. 41 Durchflusswerte einstellbaren von der Außenseite und mit dem Systemlauf. Geeignet für PICV 200/205/210.*
- **Cartucho para estabilizar el caudal. 41 valores de caudal ajustables desde el exterior y con el sistema en funcionamiento. Adecuada para PICV 200/205/210.**

Code	Size	Color	Price	Class	Packaging
590126	20-400 kPa; 3178-16128 l/h	Black	220,51 €	TE	1

PICV 300

- **Corpo valvola di bilanciamento dinamico, completo di prese piezometriche e predisposizione per inserto. Connessioni femmina - femmina.**
- **Dynamic balancing valve body, complete with piezometric inlets and arrangement for insert. Female - female connections.**
- **Corps de vanne d'équilibrage dynamique, avec prises piézométriques et prédisposition pour insert. Connexions femelle - femelle.**
- **Körper dynamisches Abgleichventil, komplett mit Piezometeranschlüsse und Vorrüstung für Einsatz. IG - IG anschlüsse.**
- **Cuerpo de válvula de equilibrado dinámico provisto de tomas piezométricas y preparado para inserto. Conexiones hembra - hembra.**

Code	Size	Color	Price	Class	Packaging
590200	DN 65 - 2"1/2 F x 2"1/2 F		607,85 €	TH	1
590201	DN 80 - 3" F x 3" F		666,04 €	TH	1

PICC 20

- **Inserto per PICV 300.**
- **Insert for PICV 300.**
- **Insert pour PICV 300.**
- **Einsatz für PICV 300.**
- **Inserto para PICV 300.**

PICC 20

- **Inserto per PICV 300.**
- **Insert for PICV 300.**
- **Insert pour PICV 300.**
- **Einsatz für PICV 300.**
- **Inserto para PICV 300.**

PICC 20

- **Inserto per PICV 300.**
- **Insert for PICV 300.**
- **Insert pour PICV 300.**
- **Einsatz für PICV 300.**
- **Inserto para PICV 300.**

Code	Size	Price	Class
590202	10-135 kPa; 3,18 m3/h	516,03 €	TH
590203	10-135 kPa; 3,63 m3/h	516,03 €	TH
590204	10-135 kPa; 4,09 m3/h	516,03 €	TH
590205	10-135 kPa; 4,54 m3/h	516,03 €	TH
590206	10-135 kPa; 5,00 m3/h	516,03 €	TH
590207	10-135 kPa; 5,45 m3/h	516,03 €	TH
590208	10-135 kPa; 5,91 m3/h	516,03 €	TH
590209	10-135 kPa; 6,36 m3/h	516,03 €	TH
590210	10-135 kPa; 6,81 m3/h	516,03 €	TH
590211	10-135 kPa; 7,27 m3/h	516,03 €	TH
590212	10-135 kPa; 7,72 m3/h	516,03 €	TH
590213	10-135 kPa; 8,18 m3/h	516,03 €	TH
590214	10-135 kPa; 8,63 m3/h	516,03 €	TH
590215	10-135 kPa; 9,08 m3/h	516,03 €	TH
590216	10-135 kPa; 9,54 m3/h	516,03 €	TH
590217	10-135 kPa; 9,99 m3/h	516,03 €	TH
590218	10-135 kPa; 10,40 m3/h	516,03 €	TH
590219	10-135 kPa; 10,90 m3/h	516,03 €	TH
590220	10-135 kPa; 11,40 m3/h	516,03 €	TH
590221	10-135 kPa; 11,80 m3/h	516,03 €	TH
590222	10-135 kPa; 12,30 m3/h	516,03 €	TH
590223	10-135 kPa; 12,70 m3/h	516,03 €	TH
590224	10-135 kPa; 13,20 m3/h	516,03 €	TH
590225	10-135 kPa; 13,60 m3/h	516,03 €	TH
590226	28-135 kPa; 20,40 m3/h	516,03 €	TH
590227	28-135 kPa; 25,00 m3/h	516,03 €	TH
590228	28-135 kPa; 29,50 m3/h	516,03 €	TH
590229	22-210 kPa; 3,97 m3/h	516,03 €	TH
590230	22-210 kPa; 4,54 m3/h	516,03 €	TH
590231	22-210 kPa; 5,11 m3/h	516,03 €	TH
590232	22-210 kPa; 5,68 m3/h	516,03 €	TH
590233	22-210 kPa; 6,25 m3/h	516,03 €	TH
590234	22-210 kPa; 6,81 m3/h	516,03 €	TH
590235	22-210 kPa; 7,38 m3/h	516,03 €	TH

Code	Size	Price	Class
590236	22-210 kPa; 7,95 m3/h	516,03 €	TH
590237	22-210 kPa; 8,52 m3/h	516,03 €	TH
590238	22-210 kPa; 9,08 m3/h	516,03 €	TH
590239	22-210 kPa; 9,65 m3/h	516,03 €	TH
590240	22-210 kPa; 10,20 m3/h	516,03 €	TH
590241	22-210 kPa; 10,80 m3/h	516,03 €	TH
590242	22-210 kPa; 11,40 m3/h	516,03 €	TH
590243	22-210 kPa; 11,90 m3/h	516,03 €	TH
590244	22-210 kPa; 12,50 m3/h	516,03 €	TH
590245	22-210 kPa; 13,10 m3/h	516,03 €	TH
590246	22-210 kPa; 13,60 m3/h	516,03 €	TH
590247	22-210 kPa; 14,20 m3/h	516,03 €	TH
590248	22-210 kPa; 14,80 m3/h	516,03 €	TH
590249	22-210 kPa; 15,30 m3/h	516,03 €	TH
590250	22-210 kPa; 15,90 m3/h	516,03 €	TH
590251	22-210 kPa; 16,50 m3/h	516,03 €	TH
590252	22-210 kPa; 17,00 m3/h	516,03 €	TH
590253	55-210 kPa; 25,00 m3/h	516,03 €	TH
590254	55-210 kPa; 30,71 m3/h	516,03 €	TH
590255	55-210 kPa; 36,30 m3/h	516,03 €	TH
590256	40-390 kPa; 5,30 m3/h	516,03 €	TH
590257	40-390 kPa; 6,06 m3/h	516,03 €	TH
590258	40-390 kPa; 6,81 m3/h	516,03 €	TH
590259	40-390 kPa; 7,57 m3/h	516,03 €	TH
590260	40-390 kPa; 8,33 m3/h	516,03 €	TH
590261	40-390 kPa; 9,08 m3/h	516,03 €	TH
590262	40-390 kPa; 9,84 m3/h	516,03 €	TH
590263	40-390 kPa; 10,60 m3/h	516,03 €	TH
590264	40-390 kPa; 11,40 m3/h	516,03 €	TH
590265	40-390 kPa; 12,10 m3/h	516,03 €	TH
590266	40-390 kPa; 12,90 m3/h	516,03 €	TH
590267	40-390 kPa; 13,60 m3/h	516,03 €	TH
590268	40-390 kPa; 14,40 m3/h	516,03 €	TH
590269	40-390 kPa; 15,10 m3/h	516,03 €	TH

Code	Size	Price	Class
590270	40-390 kPa; 15,90 m3/h	516,03 €	TH
590271	40-390 kPa; 16,70 m3/h	516,03 €	TH
590272	40-390 kPa; 17,40 m3/h	516,03 €	TH
590273	40-390 kPa; 18,20 m3/h	516,03 €	TH
590274	40-390 kPa; 18,90 m3/h	516,03 €	TH
590275	40-390 kPa; 19,70 m3/h	516,03 €	TH
590276	40-390 kPa; 20,40 m3/h	516,03 €	TH
590277	40-390 kPa; 21,20 m3/h	516,03 €	TH
590278	40-390 kPa; 22,00 m3/h	516,03 €	TH
590279	40-390 kPa; 22,70 m3/h	516,03 €	TH
590280	90-880 kPa; 7,95 m3/h	516,03 €	TH
590281	90-880 kPa; 9,08 m3/h	516,03 €	TH
590282	90-880 kPa; 10,20 m3/h	516,03 €	TH
590283	90-880 kPa; 11,40 m3/h	516,03 €	TH
590284	90-880 kPa; 12,50 m3/h	516,03 €	TH
590285	90-880 kPa; 13,60 m3/h	516,03 €	TH
590286	90-880 kPa; 14,80 m3/h	516,03 €	TH
590287	90-880 kPa; 15,90 m3/h	516,03 €	TH
590288	90-880 kPa; 17,00 m3/h	516,03 €	TH
590289	90-880 kPa; 18,20 m3/h	516,03 €	TH
590290	90-880 kPa; 19,30 m3/h	516,03 €	TH
590291	90-880 kPa; 20,40 m3/h	516,03 €	TH
590292	90-880 kPa; 21,60 m3/h	516,03 €	TH
590293	90-880 kPa; 22,70 m3/h	516,03 €	TH
590294	90-880 kPa; 23,80 m3/h	516,03 €	TH
590295	90-880 kPa; 25,00 m3/h	516,03 €	TH
590296	90-880 kPa; 26,10 m3/h	516,03 €	TH
590297	90-880 kPa; 27,30 m3/h	516,03 €	TH
590298	90-880 kPa; 28,40 m3/h	516,03 €	TH
590299	90-880 kPa; 29,50 m3/h	516,03 €	TH
590300	90-880 kPa; 30,71 m3/h	516,03 €	TH
590301	90-880 kPa; 31,80 m3/h	516,03 €	TH
590302	90-880 kPa; 32,90 m3/h	516,03 €	TH
590303	90-880 kPa; 34,10 m3/h	516,03 €	TH

■ TE 3003



- Attuatore elettrotermico per cartuccia PICC 03 (ON / OFF o comando proporzionale).
- Electrothermal actuator for PICC 03 cartridge (ON / OFF or proportional control).
- Actionneur électrothermique pour cartouche PICC 03 (ON / OFF ou commande proportionnel).
- Elektrothermischer Stellantriebe für Einsatz PICC 03 (ON / OFF oder proportional Steuerung).
- Actuador electrotérmico para cartucho PICC 03 (ON / OFF o control proporcional).

Code	Size	Price	Class	Packaging
501388	M30 x 1,5 ; ON / OFF (230 V AC)	52,77 €	PC	64
501389	M30 x 1,5 ; ON / OFF (24 V AC)	58,58 €	PC	70
501387	M30 x 1,5 ; Proportional 0-10 V (24 V AC)	125,85 €	PC	1

■ RV 03



- Servomotore assiale per cartuccia PICC 03 / PICC 13 (ON / OFF o comando proporzionale).
- Axial motor for PICC 03 / PICC 13 cartridge (ON / OFF or proportional control).
- Servomoteur axial pour cartouche PICC 03 / PICC 13 (ON / OFF ou commande proportionnel).
- Axial-Stellantrieb für Einsatz PICC 03 / PICC 13 (ON / OFF oder proportional Steuerung).
- Servomotor axial para cartucho PICC 03 / PICC 13 (ON / OFF o control proporcional).

Code	Size	Price	Class	Packaging
501385	M30 x 1,5 ; 2-point/3-point regulation (230 V AC)	208,16 €	PC	1
501386	M30 x 1,5 ; 2-point/3-point regulation (24 V AC)	208,16 €	PC	1
501384	M30 x 1,5 ; Proportional 0-10 V (24 V AC)	216,67 €	PC	1

■ AVB 10



- Presa piezometrica.
- Piezometric socket.
- Prise piézométrique.
- Piezometrischer Messventil.
- Toma piezométrica.

Code	Size	Color	Price	Class	Packaging
509088B	1/4" M	■	6,78 €	TE	100
509088R	1/4" M	■	6,78 €	TE	100

PICV XL

PICV XL are valves that are independent from the pressures used for large size systems and pipelines.

These valves are produced in cast iron and are available in the sizes from DN 65 to DN 150.

As with all PICV, they maintain a constant flow rate with a set differential pressure range (30-400 kPa).

Thanks to a control damper, the flow rate can be adjusted statically to partial loads (via the relative handwheel) or dynamically (via the actuator). The flow rate is linear, and the valve is fitted with special piezometric points to enable checks/measurements of the effective flow rate when required.

PICV XL

- **Valvola di bilanciamento dinamico per elevate portate.**
- *Dynamic balancing valve for high flow capacity.*
- **Vanne d'équilibrage dynamique pour débit élevé.**
- *Dynamisches Abgleichventil für erhöhte Durchfluss.*
- **Válvula de equilibrado dinámico para caudales elevados.**

Code	Size	Range	Price	Class	Packaging
550126	DN 65	30–400 kPa; 4,4–26 m ³ /h	2.378,97 €	TH	1
550127	DN 80	30–400 kPa; 4,7–36 m ³ /h	2.572,42 €	TH	1
550128	DN 100	30–400 kPa; 11,4–82,5 m ³ /h	2.983,00 €	TH	1
550129	DN 125	30–400 kPa; 13,1–125 m ³ /h	4.522,63 €	TH	1
550130	DN 150	30–400 kPa; 19–160 m ³ /h	6.938,65 €	TH	1

BRA 24A

- **Servomotore proporzionale per valvole PICV-XL.**
- *Proportional motor for PICV-XL valves.*
- **Servomoteur proportionnel pour vannes PICV-XL.**
- *Proportional Stellantrieb für PICV-XL Ventile.*
- **Servomotor proporcional para válvulas PICV-XL.**

Code	Size	Price	Class	Packaging
509145	10 N·m (DN 65-80)	696,37 €	TH	1
509146	20 N·m (DN 100-150)	770,23 €	TH	1

BRA 065

- **Volantino manuale per valvole PICV-XL.**
- *Manual steering wheel for PICV-XL valves.*
- **Volant manuel pour vannes PICV-XL.**
- *Manuelles Lenkrad für PICV-XL Ventile.*
- **Volante manual para válvulas PICV-XL.**

Code	Size	Price	Class	Packaging
509147	DN 65-150	242,13 €	TH	1



EQUIFLUID

The differential pressure regulator is a dynamic balancing valve, which keeps the pressure difference at the ends of the circuit constant at the set value because it is able to react to pressure variations generated in the system, thanks to the combined action of a diaphragm and a spring. This regulation is perfect for keeping variable flow systems, such as thermostatic valves, satellite utilities or multi-zone controlled manifold systems, balanced at all times.

The partner valve is the ideal complement to the differential pressure regulator, because it allows balancing of the circulating flow rate, the transmission of the delivery pressure to the regulator, the measurement of the pressure differences in play and the cut off of the branch with position memory.

PLUS

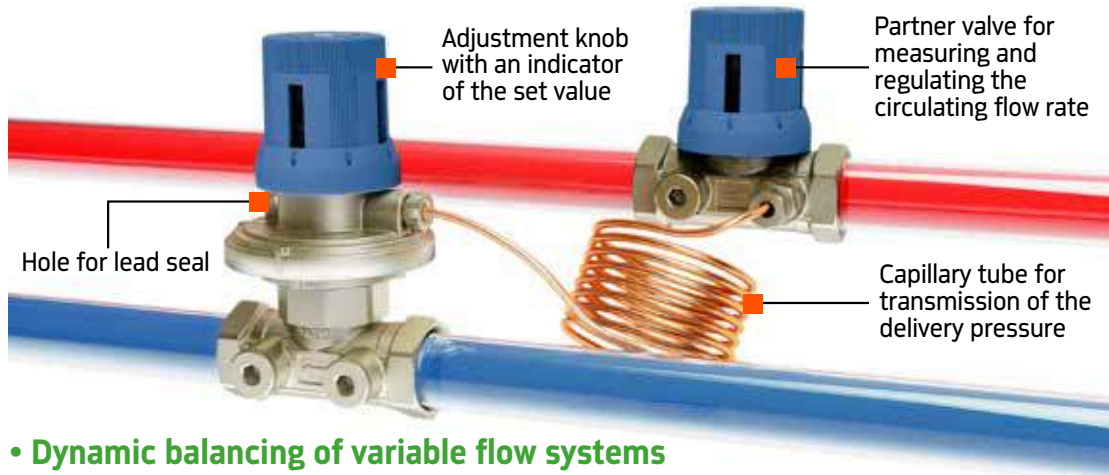

- Dynamic balancing of variable flow systems
- Optimisation of the operation of centralised systems
- Improvement of control valve operating conditions in the balanced circuit
- Reduction of noise phenomena

EQF 01



- **Regolatore di pressione differenziale EQUIFLUID con/senza coibentazione termica e capillare.**
- *Differential pressure control valve EQUIFLUID with/without thermal insulation and capillary pipe.*
- **Régulateur de pression différentielle EQUIFLUID avec/sans isolation thermique et capillaire.**
- *Differenzdruckregler EQUIFLUID mit/ohne Wärmedämmung und Kapillarrohr.*
- **Regulador de presión diferencial EQUIFLUID con/sin aislamiento térmico y capilar.**

Code	Size	Range	Insulation	Price	Class	Packaging
550113SI	DN 15 (F)	50 - 300 mbar	-	195,82 €	TE	1 / 8
550114SI	DN 15 (F)	250 - 600 mbar	-	195,82 €	TE	1 / 8
550115SI	DN 20 (F)	50 - 300 mbar	-	216,51 €	TE	1 / 8
550116SI	DN 20 (F)	250 - 600 mbar	-	216,51 €	TE	1 / 8
550100SI	DN 20 (M)	50 - 300 mbar	-	208,68 €	TE	1 / 8
550101SI	DN 20 (M)	250 - 600 mbar	-	208,68 €	TE	1 / 8
550117SI	DN 25 (F)	50 - 300 mbar	-	262,27 €	TE	1 / 8
550118SI	DN 25 (F)	250 - 600 mbar	-	262,27 €	TE	1 / 8
550113	DN 15 (F)	50 - 300 mbar	✓	205,95 €	TE	1 / 8
550114	DN 15 (F)	250 - 600 mbar	✓	205,95 €	TE	1 / 8
550115	DN 20 (F)	50 - 300 mbar	✓	226,64 €	TE	1 / 8
550116	DN 20 (F)	250 - 600 mbar	✓	226,64 €	TE	1 / 8
550100	DN 20 (M)	50 - 300 mbar	✓	218,82 €	TE	1 / 8
550101	DN 20 (M)	250 - 600 mbar	✓	218,82 €	TE	1 / 8
550117	DN 25 (F)	50 - 300 mbar	✓	272,42 €	TE	1 / 8
550118	DN 25 (F)	250 - 600 mbar	✓	272,42 €	TE	1 / 8

EQF 02

- Valvola "partner" per regolatore di pressione differenziale EQUIFLUID con/senza coibentazione termica.
- "Partner" valve for differential pressure control valve EQUIFLUID with/without thermal insulation.
- Vanne «partner» pour le régulateur de pression différentielle EQUIFLUID avec/sans isolation thermique.
- Partner-Ventil für Differenzdruckregler EQUIFLUID mit/ohne Wärmedämmung.
- Válvula "partner" para regulador de presión diferencial EQUIFLUID con/sin aislamiento térmico.

Code	Size	Insulation	Price	Class	Packaging
550110SI	DN 15 (F)	-	81,46 €	TE	1 / 8
550111SI	DN 20 (F)	-	81,46 €	TE	1 / 8
550109SI	DN 20 (M)	-	73,25 €	TE	1 / 8
550112SI	DN 25 (F)	-	85,32 €	TE	1 / 8
550110	DN 15 (F)	✓	89,04 €	TE	1 / 8
550111	DN 20 (F)	✓	89,04 €	TE	1 / 8
550109	DN 20 (M)	✓	80,49 €	TE	1 / 8
550112	DN 25 (F)	✓	92,56 €	TE	1 / 8

EQF 03

- Valvola "partner" serie BASIC per regolatore di pressione differenziale EQUIFLUID con/senza coibentazione termica.
- "Partner" valve BASIC series for differential pressure control valve EQUIFLUID with/without thermal insulation.
- Vanne «partner» série BASIC pour le régulateur de pression différentielle EQUIFLUID avec/sans isolation thermique.
- Partner-Ventil BASIC-Serie für Differenzdruckregler EQUIFLUID mit/ohne Wärmedämmung.
- Válvula "partner" serie BASIC para regulador de presión diferencial EQUIFLUID con/sin aislamiento térmico.

Code	Size	Insulation	Price	Class	Packaging
550104SI	DN 15 (F)	-	57,72 €	TE	1 / 6
550105SI	DN 20 (F)	-	60,03 €	TE	1 / 8
550103SI	DN 20 (M)	-	58,70 €	TE	1 / 8
550106SI	DN 25 (F)	-	68,94 €	TE	1 / 8
550104	DN 15 (F)	✓	63,85 €	TE	1 / 8
550105	DN 20 (F)	✓	66,49 €	TE	1 / 8
550103	DN 20 (M)	✓	65,18 €	TE	1 / 8
550106	DN 25 (F)	✓	75,19 €	TE	1 / 8

AEQF 01

- Capillare di ricambio per regolatore di pressione differenziale EQUIFLUID.
- Spare capillary pipe for differential pressure control valve EQUIFLUID.
- Capillaire de recharge pour le régulateur de pression différentielle EQUIFLUID.
- Ersatzkapillarrohr für Differenzdruckregler EQUIFLUID.
- Tubo capilar de recambio para regulador de presión diferencial EQUIFLUID.

Code	Size	Price	Class	Packaging
550119	D.3x0,5	36,07 €	TE	1 / 32

AEQF 11

- Coibentazione termica per regolatore di pressione differenziale EQUIFLUID.
- Thermal insulation for differential pressure control valve EQUIFLUID.
- Isolation thermique pour le régulateur de pression différentielle EQUIFLUID.
- Wärmedämmung für Differenzdruckregler EQUIFLUID.
- Aislamiento térmico para regulador de presión diferencial EQUIFLUID.

Code	Size	Price	Class	Packaging
550150	1/2"	9,71 €	TE	1
550149	3/4"	9,71 €	TE	1
550151	1"	9,71 €	TE	1

■ DPCV XL



- **Regolatore di pressione differenziale per elevate portate.**
- *Differential pressure control valve for high flow capacity.*
- **Régulateur de pression différentielle pour débit élevé.**
- *Differenzdruckregler für erhöhte Durchfluss.*
- **Regulador de presión diferencial para caudales elevados.**

Code	Size	Range	Isolation / Metering	Price	Class	Packaging
550131	DN 65	200-1000 mbar	-	2.160,90 €	TH	1
550132	DN 80	200-1000 mbar	-	2.367,14 €	TH	1
550133	DN 100	200-1000 mbar	-	2.634,02 €	TH	1
550134	DN 125	200-1000 mbar	-	3.906,77 €	TH	1
550135	DN 150	200-1000 mbar	-	6.164,91 €	TH	1
550136	DN 65	800-1600 mbar	-	2.220,37 €	TH	1
550137	DN 80	800-1600 mbar	-	2.469,78 €	TH	1
550138	DN 100	800-1600 mbar	-	2.736,66 €	TH	1
550139	DN 65	200-1000 mbar	✓	2.319,49 €	TH	1
550140	DN 80	200-1000 mbar	✓	2.531,38 €	TH	1
550141	DN 100	200-1000 mbar	✓	2.798,25 €	TH	1
550142	DN 125	200-1000 mbar	✓	4.214,70 €	TH	1
550143	DN 150	200-1000 mbar	✓	6.472,83 €	TH	1
550144	DN 65	800-1600 mbar	✓	2.378,97 €	TH	1
550145	DN 80	800-1600 mbar	✓	2.634,02 €	TH	1
550146	DN 100	800-1600 mbar	✓	2.900,95 €	TH	1

■ KEKO 01



- **Gruppo di connessione a ramo di alta pressione, completo di presa piezometrica.**
- *High pressure branch connection unit, complete with piezometric socket.*
- **Unité de raccordement au branchement de haute pression, complète avec poignée piézométrique.**
- *Hochdruck-Anschlussstück, komplett mit piezometrischem Griff.*
- **Unidad de conexión de derivación de alta presión, con empuñadura piezométrica.**

Code	Size	Length	Price	Class	Packaging
509134	1/4" M	2 m	55,90 €	TH	1

■ KEKO 03



- **Gruppo di connessione a ramo di alta pressione.**
- *High pressure branch connection unit.*
- **Unité de raccordement au branchement de haute pression.**
- *Hochdruck-Anschlussstück.*
- **Unidad de conexión de derivación de alta presión.**

Code	Size	Length	Price	Class	Packaging
509142	1/4" M	2 m	28,63 €	TH	1

SATELLITE MODULES

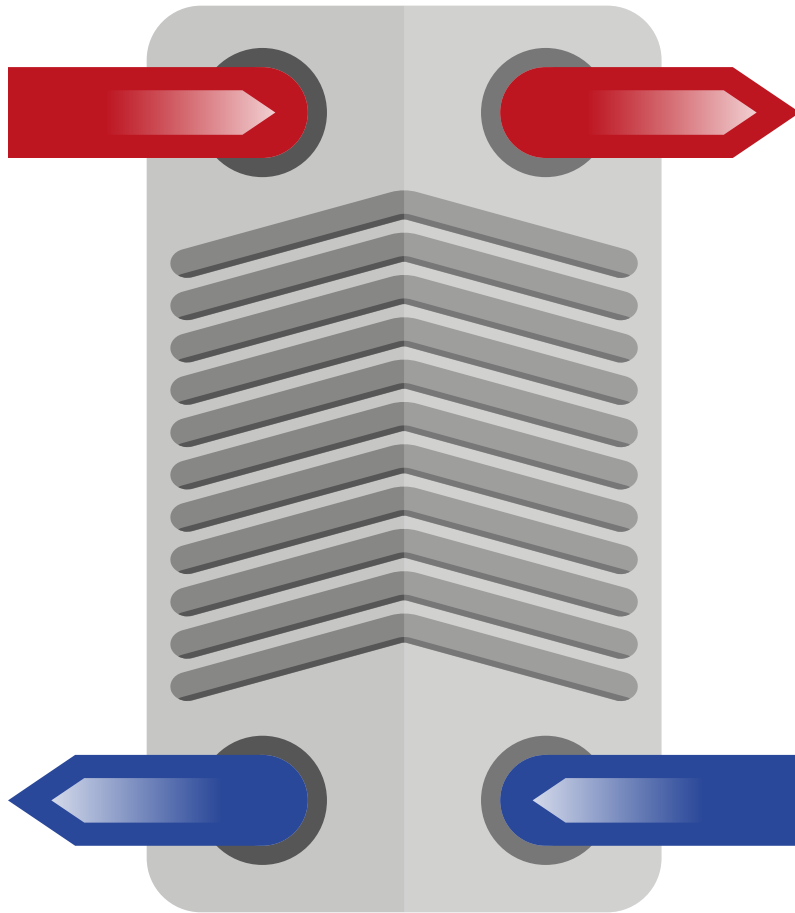

pim.ivar-group.com/short/IT-08

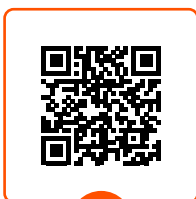

DOWNLOAD
Focus tecnici



pim.ivar-group.com/short/FR-08

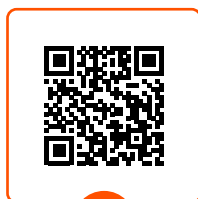

DOWNLOAD
Détails techniques



pim.ivar-group.com/short/DE-08

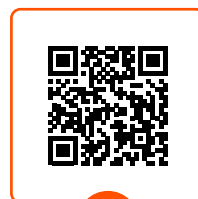

DOWNLOAD
Technische Details



pim.ivar-group.com/short/ES-08



DOWNLOAD
Profundizaciones técnicas



IVAR•ESAT DUAL - Satellite di utenza a doppio scambiatore con controllo elettronico **384**
IVAR•ESAT DUAL - Heating interface unit with separated heat exchangers and electronic controller
IVAR•ESAT DUAL - Satellite d'application à double échangeur de chaleur avec contrôle électronique
IVAR•ESAT DUAL - Satellitenmodul mit getrennten Wärmetauscher und elektronischer Steuerung
IVAR•ESAT DUAL - Modulo satélite con intercambiadores de calor separados y control electrónico



IVAR•SAT - Satelliti di utenza con contabilizzazione **388**
IVAR•SAT - Satellite modules with metering devices
IVAR•SAT - Satellites d'application avec comptabilisation
IVAR•SAT - Satellitenmodule mit Kostenabrechnung
IVAR•SAT - Modulos satélite con contabilización



E•SAT - M•SAT - Satelliti di utenza compatti **398**
E•SAT - M•SAT - Compact satellite modules
E•SAT - M•SAT - Satellites d'application compacts
E•SAT - M•SAT - Kompakte Satellitenmodule
E•SAT - M•SAT - Modulos satélite compactos



SAP - SAP•C - Produttori istantanei di acqua calda sanitaria **400**
SAP - SAP•C - Fresh water stations
SAP - SAP•C - Producteurs instantanés d'eau chaude sanitaire
SAP - SAP•C - Frischwasserstationen
SAP - SAP•C - Productores instantáneos de agua caliente sanitaria



IVAR•ESAT DUAL

IVAR•ESAT DUAL is a heating interface unit with separate heat exchangers for heating and water to offer three functions: instant DHW production, heating control and metering of water and heat consumption. The dual heat exchanger design enables all three circuits to be kept separate (primary, domestic, and heating). In this way, any intervention on secondary circuits can be performed without acting on the primary circuit, shared by multiple utilities and users. Its strength lies in electronic control of the temperature of hot water delivery and delivery to the heating system, and therefore only the primary flow effectively necessary to meet demands is handled, consequently optimising pump energy consumption and the primary temperature variations. IVAR•ESAT DUAL is supplied pre-assembled on the frame, insulated by a polypropylene casing and with a provision for insertion of meters as required; it can be completed with a sheet steel cover, differential pressure regulator for the heating or primary circuit, and shut-off valve.

IVAR•ESAT DUAL

DHW data: production of 18 l/min DHW* (input at 10°C - output of DHW 55°C) - Power: approx. 55 kW

Heating data: Max. power: 23.6 kW (Delivery/return on secondary circuit: 60/40°C)*

(*) The specified values refer to $D_p = 500$ mbar on the primary circuit and delivery temperature on the primary circuit of 70°C

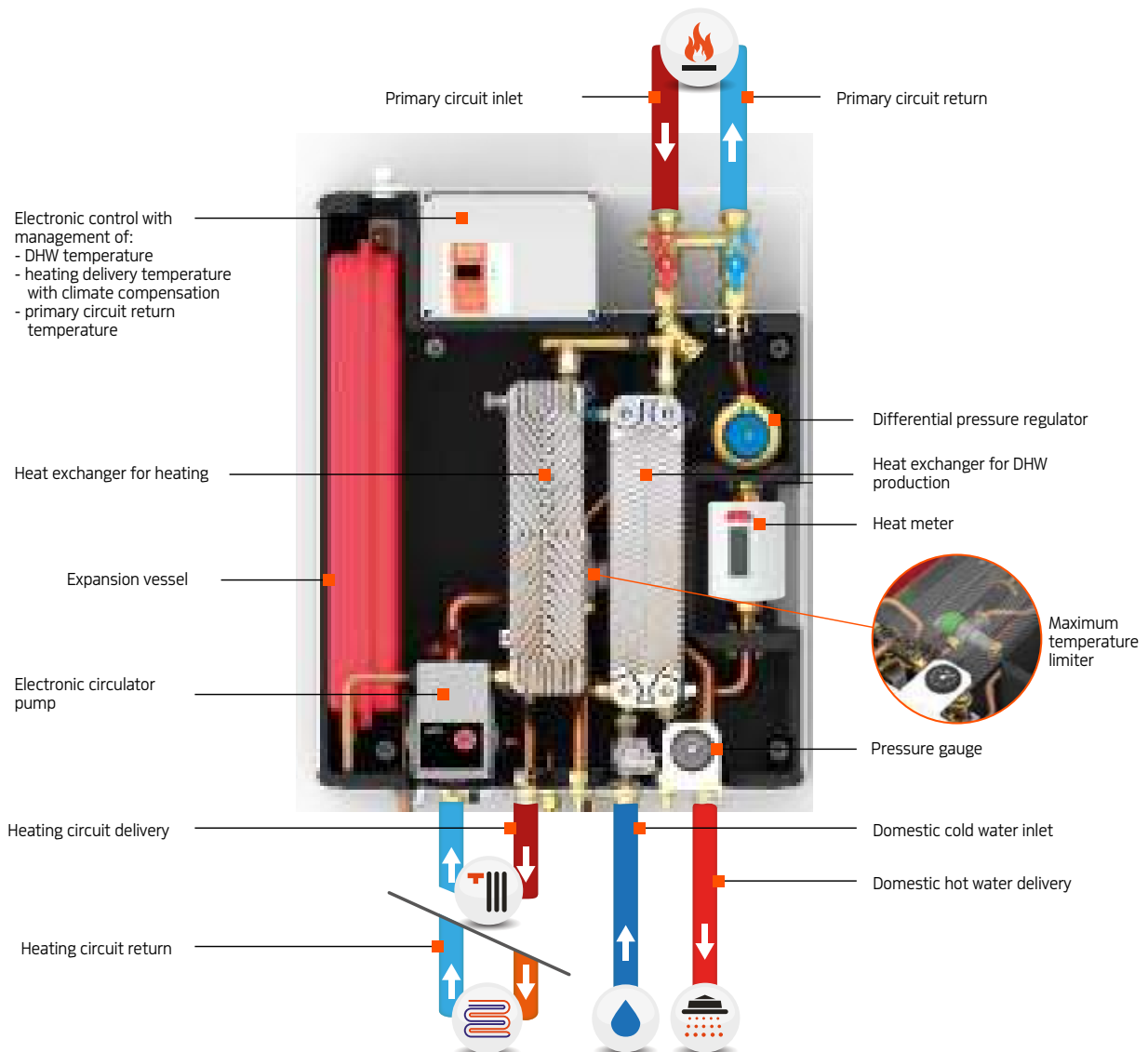

⊕ PLUS

- Energy saving thanks to electronic temperature control of the boiler return.
- Power of the heat exchanger in DHW production up to 55 kW.
- Electronic DHW temperature control.
- Heat exchanger power for heating up to 24 kW.
- Electronic control with external compensation for the heating delivery temperature.
- **Electronic intervention** for: circuit temperature monitoring, water hammer delay, plumbing flow rate check by flowmeter, anti-lock function, fouled exchangers warning, PWM circulator control in heating mode, intelligent automatic loading.

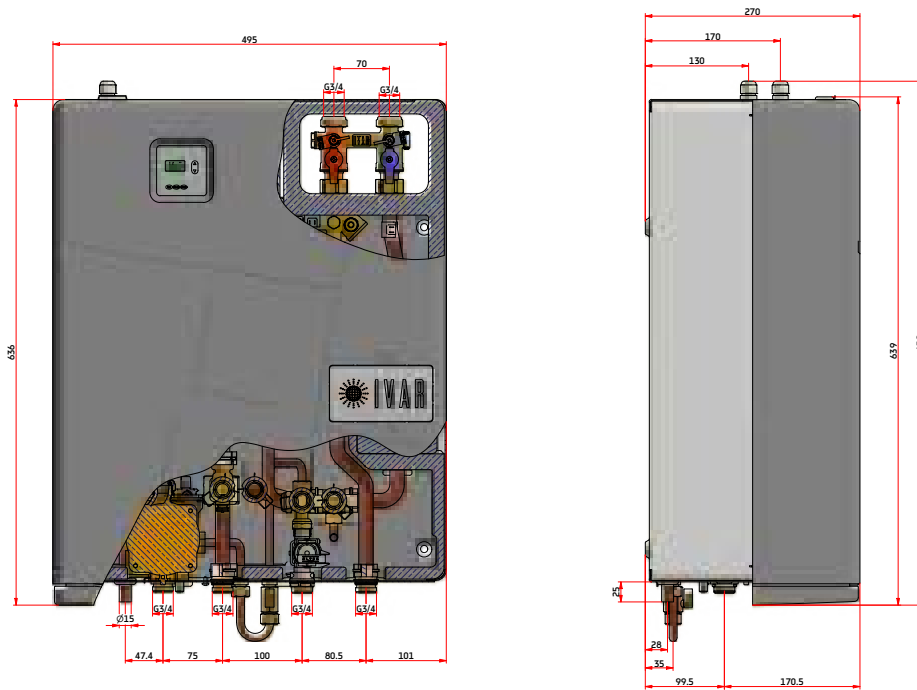

IVAR E-SAT MONO

Indirect heat interface unit for domestic water preparation and heating/cooling applications with single heat exchanger. Several configurations available.

**AVAILABLE
ON REQUEST**



IVAR E-SAT TANK

Heat interface unit for domestic hot water preparation with delocalized storage tank and heating applications with heat exchanger.

**AVAILABLE
ON REQUEST**



HC IVAR E-SAT DUAL

4-pipe indirect heat interface unit for domestic water preparation and heating/cooling applications

**AVAILABLE
ON REQUEST**

■ IVAR-ESAT DUAL



• >>p. 504

- **Satellite di utenza a doppio scambiatore per riscaldamento e produzione di acqua calda sanitaria con pompa elettronica a velocità variabile, coibentazione e controllo elettronico. Disponibile con regolatore di pressione differenziale EQF 01 (per il circuito primario o di riscaldamento), copertura in lamiera e valvola di riempimento automatico opzionali.**
Unità contabilizzazione del calore: Qn 1,5 m³/h (contatore non incluso).
- *Heating interface unit with separated heat exchangers for heating and domestic hot water preparation, variable speed electronic pump, insulation and electronic controller. Available with optional differential pressure control valve EQF 01 (for primary or heating circuit), metal sheet cover and automatic filling valve. Heat metering unit: Qn 1,5 m³/h (meter not included).*
- **Satellite d'application à double échangeur de chaleur pour le chauffage et la production d'eau chaude sanitaire avec pompe électronique à vitesse variable, isolation et contrôle électronique. Disponible avec le régulateur de pression différentielle EQF 01 (pour le circuit primaire ou de chauffage), le couvercle en tôle et vanne de remplissage automatique optionnels.**
Unité de comptabilisation de la chaleur: Qn 1,5 m³/h (compteur non inclus).
- *Satellitenmodul mit getrennten Wärmetauscher für Heizung und Frischwasserzubereitung, elektronischer Pumpe mit variabler Geschwindigkeit, Dämmschalen und elektronischer Steuerung. Erhältlich mit optionalen Differenzdruckregler EQF 01 (für Primär- oder Heizkreis), Blechabdeckung und automatisches Füllventil. Wärmemesseinheit: Qn 1,5 m³/h (Zähler nicht enthalten).*
- **Modulo satélite con intercambiadores de calor separados para calefacción y producción de agua caliente sanitaria con bomba electrónica de velocidad variable, aislamiento y control electrónico. Disponible con regulador de presión diferencial EQF 01 (para circuito primario o de calefacción), cubierta de lámina y válvula de llenado automático opcionales.**
Unidad de contabilización de calor: Qn 1,5 m³/h (contador no incluido).

Code	ΔP adjustment	Filling	Metal sheet cover	Price	Class	Packaging
500325		Manual	-	3.535,75 €	UE	1
500325C		Manual	✓	3.650,62 €	UE	1
500362	50 - 300 mbar (Primary circuit)	Manual	-	3.785,10 €	UE	1
500362C	50 - 300 mbar (Primary circuit)	Manual	✓	3.899,98 €	UE	1
500363	50 - 300 mbar (Heating circuit only)	Manual	-	3.805,38 €	UE	1
500363C	50 - 300 mbar (Heating circuit only)	Manual	✓	3.920,24 €	UE	1
500325A		Automatic	-	3.641,44 €	UE	1
500325AC		Automatic	✓	3.756,30 €	UE	1
500362A	50 - 300 mbar (Primary circuit)	Automatic	-	3.890,78 €	UE	1
500362AC	50 - 300 mbar (Primary circuit)	Automatic	✓	4.005,67 €	UE	1
500363A	50 - 300 mbar (Heating circuit only)	Automatic	-	3.911,07 €	UE	1
500363AC	50 - 300 mbar (Heating circuit only)	Automatic	✓	4.025,94 €	UE	1

■ AC 688



- **Kit di valvole di intercettazione a sfera dritte per IVAR•ESAT DUAL.**
- *Straight isolation ball valves kit for IVAR•ESAT DUAL.*
- **Kit de vannes d'interception à bille droites pour IVAR•ESAT DUAL.**
- *Durchgangs-Absperrkugelventile-Set für IVAR•ESAT DUAL.*
- **Kit válvulas de cierre de bola rectas para IVAR•ESAT DUAL.**

Code	Size	Price	Class	Packaging
508013	3/4" M x 3/4" F swivel	210,63 €	UE	1

■ AC 688 S

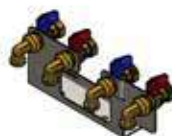

- **Kit di valvole di intercettazione a sfera con raccordo a squadra per IVAR•ESAT DUAL.**
- *Isolation ball valves kit with angle fitting for IVAR•ESAT DUAL.*
- **Kit de vannes d'interception à bille avec raccord équerre pour IVAR•ESAT DUAL.**
- *Absperrkugelventile-Set mit Winkel-Verbinder für IVAR•ESAT DUAL.*
- **Kit válvulas de cierre de bola con racor codo para IVAR•ESAT DUAL.**

Code	Size	Price	Class	Packaging
508012	3/4" M x 3/4" F swivel	241,84 €	UE	1

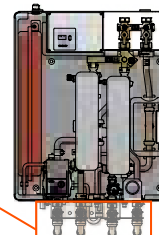
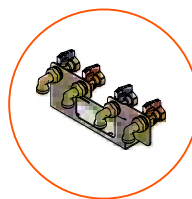
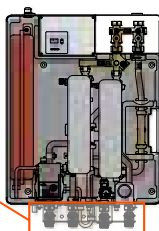
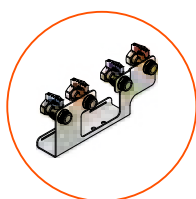

EQF 01 H

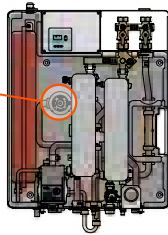
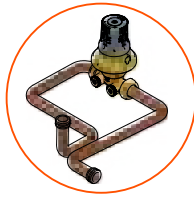

- **Regolatore di pressione differenziale EQUIFLUID completo di kit di connessione per circuito solo di riscaldamento per IVAR•ESAT DUAL.**
- *Differential pressure control valve EQUIFLUID complete with connection kit for IVAR•ESAT DUAL heating circuit only.*
- **Régulateur de pression différentielle EQUIFLUID avec kit de connexion pour le circuit de chauffage seulement pour IVAR•ESAT DUAL.**
- *Differenzdruckregler EQUIFLUID mit Anschluß-Set für nur Heizkreis für IVAR•ESAT DUAL.*
- **Regulador de presión diferencial EQUIFLUID con kit de conexión para circuito de solo calefacción para IVAR•ESAT DUAL.**

Code	Size	Range	Price	Class	Packaging
550147	DN 20 (M)	50 - 300 mbar	269,62 €	UE	1

EQF 01 P

- **Regolatore di pressione differenziale EQUIFLUID completo di kit di connessione per circuito primario IVAR•ESAT DUAL.**
- *Differential pressure control valve EQUIFLUID complete with connection kit for IVAR•ESAT DUAL primary circuit.*
- **Régulateur de pression différentielle EQUIFLUID avec kit de connexion pour le circuit primaire pour IVAR•ESAT DUAL.**
- *Differenzdruckregler EQUIFLUID mit Anschluß-Set für Primärkreis für IVAR•ESAT DUAL.*
- **Regulador de presión diferencial EQUIFLUID con kit de conexión para circuito primario para IVAR•ESAT DUAL.**

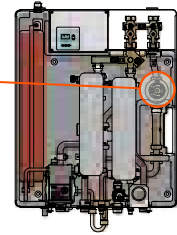
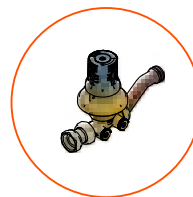
Code	Size	Range	Price	Class	Packaging
550148	DN 20 (M)	50 - 300 mbar	249,35 €	UE	1



IvarSAT is the solution for direct metering of heat and domestic hot water in central heating systems without centralised production of domestic hot water (DHW): in fact, thanks to IvarSAT the production of DHW takes place instantly and is given priority at the level of the individual housing unit. IvarSAT is available in three families: the "H" family with direct delivery, suitable for high temperature heating systems; the "LE" family equipped with mixing valve and booster pump, suitable for radiant systems, and the "HLE" family, which integrates two separate deliveries, one direct without booster and one mixed with booster. Domestic hot water temperature is controlled by a thermostatic anti-scald mixer (max 50 °C). For the "1" models there is the provision for a disconnect upstream of the mixer without limitation of the delivery temperature. IvarSAT is also available with a built-in circulation pump ("R" models). The unit also includes a heat meter, a domestic cold-water meter and heating management devices such as thermostats and electrothermal heads. To meet the needs of construction sites, IvarSAT can also be supplied as an installation template with functional components provided separately.

IVAR-SAT H

Heating power (*): approx. 10 kW

Domestic hot water output (**): approx. 32 kW - production of approx. 12 l/min of domestic hot water at 48°C with mains input at 10°C

(*) temperature difference = 10°C and pressure differential at the ends of the module = 200 mbar

(**) pressure differential at module ends = 150 mbar and boiler temperature = 60°C

IVAR-SAT LE

Heating power (*): approx. 7 kW

Domestic hot water output (**): approx. 32 kW - production of approx. 12 l/min of domestic hot water at 48°C with mains input at 10°C

(*) temperature difference = 8°C and WIL04 circulator

(**) boiler temperature = 60°C

IVAR-SAT HLE

Heating power (*): approx. 7 kW (low temperature part)

Heating power (*): approx. 5 kW (high temperature part)

Domestic hot water output (**): approx. 32 kW - production of approx. 12 l/min of domestic hot water at 48°C with mains input at 10°C

(*) temperature difference = 8°C and WIL04 circulator

(*) temperature difference = 10°C and pressure differential at the ends of the module = 200 mbar

(**) boiler temperature = 60°C

APPLICATION EXAMPLE

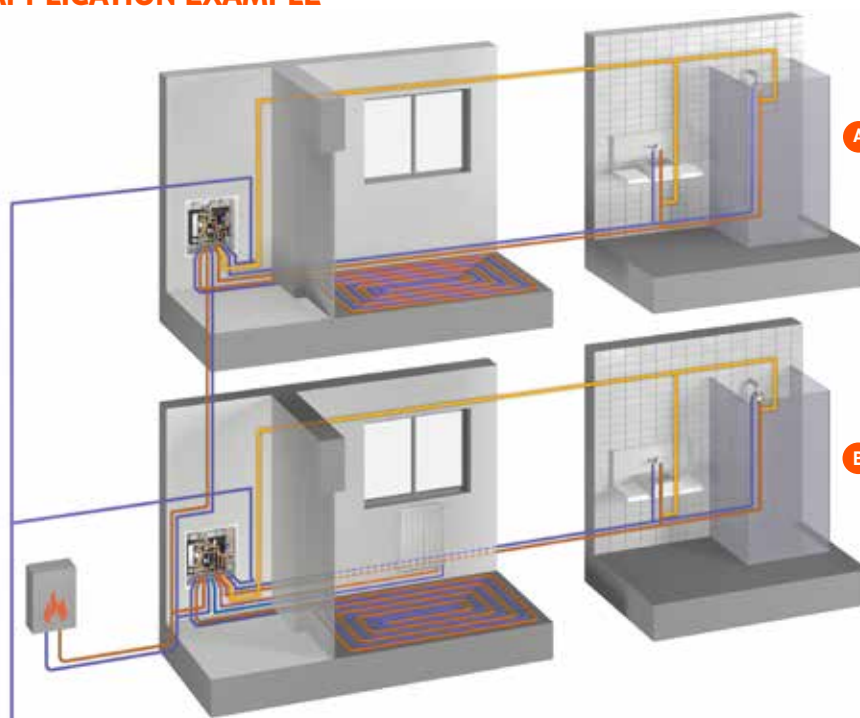

IVAR•SAT LRE (unit A) with domestic cold water inlet, domestic cold water outlet, recirculation inlet, domestic hot water outlet, boiler return, boiler delivery, low temperature heating delivery, low temperature heating return.

IVAR•SAT HLRE (unit B) with domestic cold water inlet, domestic cold water outlet, recirculation inlet, domestic hot water outlet, high temperature heating delivery, high temperature heating return, boiler return, boiler delivery, low temperature heating delivery, low temperature heating return.

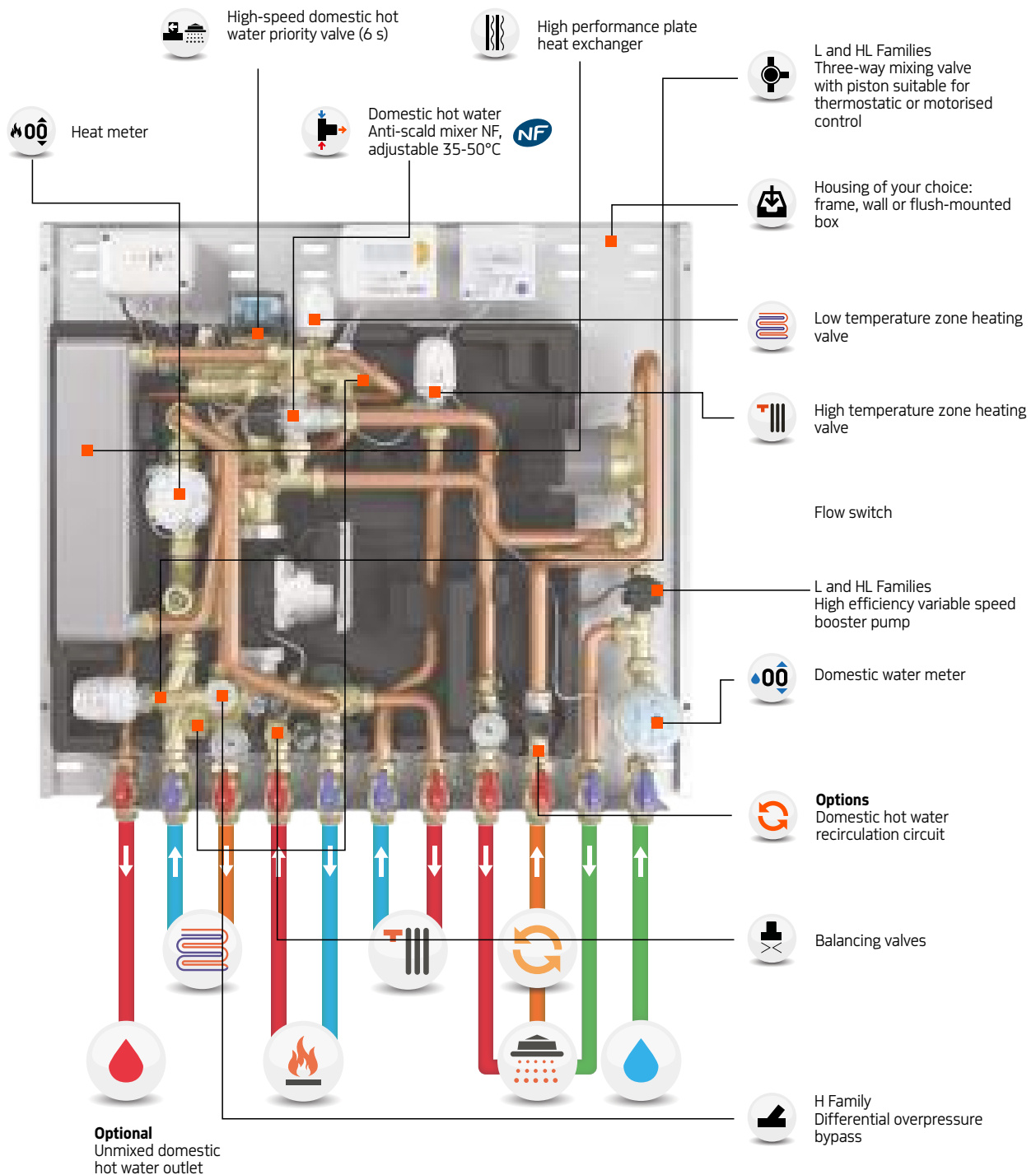

PLUS

- Available in the following versions: high temperature (IVARSAT H), low temperature (IVARSAT L/LE), combined (IVARSAT HL/HLE)
- Can be equipped with domestic hot water recirculation fittings
- Flush- or wall-mounted installation
- Electronic management of domestic hot water priority
- Ideal DHW delivery temperature control via thermostatic mixer

■ IVARSAT-HLE



- **Satellite di utenza per riscaldamento misto alta/bassa temperatura e produzione di acqua calda sanitaria miscelata con pompa elettronica a velocità variabile.**
- *Satellite module for hybrid high-/low-temperature heating and domestic hot water preparation with variable speed electronic pump.*
- **Satellite d'application pour le chauffage mixte haute/basse température et production d'eau chaude sanitaire avec pompe électronique à vitesse variable.**
- *Satellitenmodul für gemischtes Heizen mit hoher/niedriger Temperatur und Trinkwarmwasservorbereitung mit elektronischer Pumpe mit variabler Geschwindigkeit.*
- **Modulo satélite usuario para calefacción mixta de alta/baja temperatura y producción de agua caliente sanitaria con bomba electrónica de velocidad variable.**

Code	Heat unit	Domestic water units	Additional units	Price	Class	Packaging
506699HLE	HIGH T. + LOW T. (Qn 1,5 m³/h)	COLD (Qn 1,5 m³/h) + MIX		2.775,98 €	UE	1
506699HLE1	HIGH T. + LOW T. (Qn 1,5 m³/h)	COLD (Qn 1,5 m³/h) + MIX	HOT	2.826,88 €	UE	1
506699HLRE	HIGH T. + LOW T. (Qn 1,5 m³/h)	COLD (Qn 1,5 m³/h) + MIX	RECIRCULATION	3.330,45 €	UE	1
506699HLRE1	HIGH T. + LOW T. (Qn 1,5 m³/h)	COLD (Qn 1,5 m³/h) + MIX	HOT+RECIRCULATION	3.381,33 €	UE	1



• AC 830 / AC 830 P >> p. 396



• >> p. 504



• >>p. 506

■ IVARSAT-HL



- **Satellite di utenza per riscaldamento misto alta/bassa temperatura e produzione di acqua calda sanitaria miscelata con pompa standard a 3 velocità.**
- *Satellite module for hybrid high-/low-temperature heating and domestic hot water preparation with 3-speed standard pump.*
- **Satellite d'application pour le chauffage mixte haute/basse température et production d'eau chaude sanitaire avec pompe standard à 3 vitesses.**
- *Satellitenmodul für gemischtes Heizen mit hoher/niedriger Temperatur und Trinkwarmwasservorbereitung mit Standardpumpe mit 3 Geschwindigkeiten.*
- **Modulo satélite usuario para calefacción mixta de alta/baja temperatura y producción de agua caliente sanitaria con bomba estándar de 3 velocidades.**

Code	Heat unit	Domestic water units	Additional units	Price	Class	Packaging
506699HL	HIGH T. + LOW T. (Qn 1,5 m³/h)	COLD (Qn 1,5 m³/h) + MIX		2.536,56 €	UE	1
506699HL1	HIGH T. + LOW T. (Qn 1,5 m³/h)	COLD (Qn 1,5 m³/h) + MIX	HOT	2.587,44 €	UE	1
506699HLR	HIGH T. + LOW T. (Qn 1,5 m³/h)	COLD (Qn 1,5 m³/h) + MIX	RECIRCULATION	3.091,01 €	UE	1
506699HLR1	HIGH T. + LOW T. (Qn 1,5 m³/h)	COLD (Qn 1,5 m³/h) + MIX	HOT+RECIRCULATION	3.141,87 €	UE	1



• AC 830 / AC 830 P >> p. 396



• >> p. 504



• >>p. 506

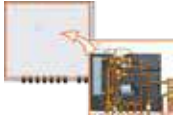

For the supply of modules in separate components (template + functional blocks) please refer to the following tables.

■ IVARSAT-HL/HLE Template



- Dima per satellite di utenza per riscaldamento misto alta/bassa temperatura e produzione di acqua calda sanitaria.
- Template for satellite module for hybrid high-/low-temperature heating and domestic hot water preparation.
- Gabarit pour satellite d'application pour le chauffage mixte haute/basse température et production d'eau chaude sanitaire.
- Schablone für Satellitenmodul für gemischtes Heizen mit hoher/niedriger Temperatur und Trinkwarmwasservorbereitung.
- Plantilla para modulo satélite usuario para calefacción mixta de alta/baja temperatura y producción de agua caliente sanitaria.

Code	Additional units	Price	Class	Packaging
506698HL		371,84 €	UE	1
506698HL1	HOT	375,68 €	UE	1
506698HLR	RECIRCULATION	375,68 €	UE	1
506698HLR1	HOT+RECIRCULATION	400,40 €	UE	1

■ IVARSAT-HLE Complementary module



ErP

- Modulo complementare per satellite di utenza per riscaldamento misto alta/bassa temperatura e produzione di acqua calda sanitaria con pompa elettronica a velocità variabile.
- Complementary module for satellite module for hybrid high-/low-temperature heating and domestic hot water preparation with variable speed electronic pump.
- Module complémentaire pour satellite d'application pour le chauffage mixte haute/basse température et production d'eau chaude sanitaire avec pompe électronique à vitesse variable.
- Ergänzungsmodul für Satellitenmodul für gemischtes Heizen mit hoher/niedriger Temperatur und Trinkwarmwasservorbereitung mit elektronischer Pumpe mit variabler Geschwindigkeit.
- Módulo complementario para modulo satélite usuario para calefacción mixta de alta/baja temperatura y producción de agua caliente sanitaria con bomba electrónica de velocidad variable.

Code	Pump	Additional units	Price	Class	Packaging
506697HLE	WILO4F		2.326,91 €	UE	1
506697HLE1	WILO4F	HOT	2.359,88 €	UE	1
506697HLRE	WILO4F	RECIRCULATION	2.863,45 €	UE	1
506697HLRE1	WILO4F	HOT+RECIRCULATION	2.896,43 €	UE	1

■ IVARSAT-HL Complementary module



ErP

- Modulo complementare per satellite di utenza per riscaldamento misto alta/bassa temperatura e produzione di acqua calda sanitaria con pompa standard a 3 velocità.
- Complementary module for satellite module for hybrid high-/low-temperature heating and domestic hot water preparation with 3-speed standard pump.
- Module complémentaire pour satellite d'application pour le chauffage mixte haute/basse température et production d'eau chaude sanitaire avec pompe standard à 3 vitesses.
- Ergänzungsmodul für Satellitenmodul für gemischtes Heizen mit hoher/niedriger Temperatur und Trinkwarmwasservorbereitung mit Standardpumpe mit 3 Geschwindigkeiten.
- Módulo complementario para Modulo satélite usuario para calefacción mixta de alta/baja temperatura y producción de agua caliente sanitaria con bomba estándar de 3 velocidades.

Code	Pump	Additional units	Price	Class	Packaging
506697HL	WILO3F		2.087,48 €	UE	1
506697HL1	WILO3F	HOT	2.120,45 €	UE	1
506697HLR	WILO3F	RECIRCULATION	2.491,64 €	UE	1
506697HLR1	WILO3F	HOT+RECIRCULATION	2.524,62 €	UE	1



IVARSAT-LE



- **Satellite di utenza per riscaldamento a bassa temperatura e produzione di acqua calda sanitaria miscelata con pompa elettronica a velocità variabile.**
- *Satellite module for low-temperature heating and domestic hot water preparation with variable speed electronic pump.*
- **Satellite d'application pour le chauffage à basse température et production d'eau chaude sanitaire avec pompe électronique à vitesse variable.**
- *Satellitenmodul für Heizen mit niedriger Temperatur und Trinkwarmwasservorbereitung mit elektronischer Pumpe mit variabler Geschwindigkeit.*
- **Modulo satélite para calefacción de baja temperatura y producción de agua caliente sanitaria con bomba electrónica de velocidad variable.**

Code	Heat unit	Domestic water units	Additional units	Price	Class	Packaging
506699LE	LOW T. (Qn 1,5 m³/h)	COLD (Qn 1,5 m³/h) + MIX		2.620,47 €	UE	1
506699LE1	LOW T. (Qn 1,5 m³/h)	COLD (Qn 1,5 m³/h) + MIX	HOT	2.671,34 €	UE	1
506699LRE	LOW T. (Qn 1,5 m³/h)	COLD (Qn 1,5 m³/h) + MIX	RECIRCULATION	3.174,90 €	UE	1
506699LRE1	LOW T. (Qn 1,5 m³/h)	COLD (Qn 1,5 m³/h) + MIX	HOT+RECIRCULATION	3.225,80 €	UE	1



• AC 830 / AC 830 P >> p. 396



• >> p. 504



• >>p. 506

IVARSAT-L



- **Satellite di utenza per riscaldamento a bassa temperatura e produzione di acqua calda sanitaria miscelata con pompa standard a 3 velocità.**
- *Satellite module for low-temperature heating and domestic hot water preparation with 3-speed standard pump.*
- **Satellite d'application pour le chauffage à basse température et production d'eau chaude sanitaire avec pompe standard à 3 vitesses.**
- *Satellitenmodul für Heizen mit niedriger Temperatur und Trinkwarmwasservorbereitung mit Standardpumpe mit 3 Geschwindigkeiten.*
- **Modulo satélite para calefacción de baja temperatura y producción de agua caliente sanitaria con bomba estándar de 3 velocidades.**

Code	Heat unit	Domestic water units	Additional units	Price	Class	Packaging
506699L	LOW T. (Qn 1,5 m³/h)	COLD (Qn 1,5 m³/h) + MIX		2.381,03 €	UE	1
506699L1	LOW T. (Qn 1,5 m³/h)	COLD (Qn 1,5 m³/h) + MIX	HOT	2.431,91 €	UE	1
506699LR	LOW T. (Qn 1,5 m³/h)	COLD (Qn 1,5 m³/h) + MIX	RECIRCULATION	2.935,48 €	UE	1
506699LR1	LOW T. (Qn 1,5 m³/h)	COLD (Qn 1,5 m³/h) + MIX	HOT+RECIRCULATION	2.986,38 €	UE	1



• AC 830 / AC 830 P >> p. 396



• >> p. 504



• >>p. 506

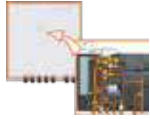

For the supply of modules in separate components (template + functional blocks) please refer to the following tables.

■ IVARSAT-L/LE Template



- Dima per satellite di utenza per riscaldamento a bassa temperatura e produzione di acqua calda sanitaria.
- Template for satellite module for low-temperature heating and domestic hot water preparation.
- Gabarit pour satellite d'application pour le chauffage à basse température et production d'eau chaude sanitaire.
- Schablone für Satellitenmodul für Heizen mit niedriger Temperatur und Trinkwarmwasservorbereitung.
- Plantilla para modulo satélite para calefacción de baja temperatura y producción de agua caliente sanitaria.

Code	Additional units	Price	Class	Packaging
506698L		324,63 €	UE	1
506698L1	HOT	338,92 €	UE	1
506698LR	RECIRCULATION	338,92 €	UE	1
506698LR1	HOT+RECIRCULATION	353,20 €	UE	1

■ IVARSAT-LE Complementary module



ErP

- Modulo complementare per satellite di utenza per riscaldamento a bassa temperatura e produzione di acqua calda sanitaria con pompa elettronica a velocità variabile.
- Complementary module for satellite module for low-temperature heating and domestic hot water preparation with variable speed electronic pump.
- Module complémentaire pour satellite d'application pour le chauffage à basse température et production d'eau chaude sanitaire avec pompe électronique à vitesse variable.
- Ergänzungsmodul für Satellitenmodul für Heizen mit niedriger Temperatur und Trinkwarmwasservorbereitung mit elektronischer Pumpe mit variabler Geschwindigkeit.
- Módulo complementario para modulo satélite para calefacción de baja temperatura y producción de agua caliente sanitaria con bomba electrónica de velocidad variable.

Code	Pump	Additional units	Price	Class	Packaging
506697LE	WILO4F		2.216,38 €	UE	1
506697LE1	WILO4F	HOT	2.249,36 €	UE	1
506697LRE	WILO4F	RECIRCULATION	2.752,94 €	UE	1
506697LRE1	WILO4F	HOT+RECIRCULATION	2.785,90 €	UE	1

■ IVARSAT-L Complementary module



ErP

- Modulo complementare per satellite di utenza per riscaldamento a bassa temperatura e produzione di acqua calda sanitaria con pompa standard a 3 velocità.
- Complementary module for satellite module for low-temperature heating and domestic hot water preparation with 3-speed standard pump.
- Module complémentaire pour satellite d'application pour le chauffage à basse température et production d'eau chaude sanitaire avec pompe standard à 3 vitesses.
- Ergänzungsmodul für Satellitenmodul für Heizen mit niedriger Temperatur und Trinkwarmwasservorbereitung mit Standardpumpe mit 3 Geschwindigkeiten.
- Módulo complementario para modulo satélite para calefacción de baja temperatura y producción de agua caliente sanitaria con bomba estándar de 3 velocidades.

Code	Pump	Additional units	Price	Class	Packaging
506697L	WILO3F		1.976,95 €	UE	1
506697L1	WILO3F	HOT	2.009,92 €	UE	1
506697LR	WILO3F	RECIRCULATION	2.513,50 €	UE	1
506697LR1	WILO3F	HOT+RECIRCULATION	2.546,48 €	UE	1



IVARSAT-H



- **Satellite di utenza per riscaldamento ad alta temperatura e produzione di acqua calda sanitaria miscelata.**
- *Satellite module for high-temperature heating and domestic hot water preparation.*
- **Satellite d'application pour le chauffage à haute température et production d'eau chaude sanitaire.**
- *Satellitenmodul für Heizen mit hoher Temperatur und Trinkwarmwasservorbereitung.*
- **Modulo satélite para calefacción a alta temperatura y producción de agua caliente sanitaria.**

Code	Heat unit	Domestic water units	Additional units	Price	Class	Packaging
506699H	HIGH T. (Qn 1,5 m³/h)	COLD (Qn 1,5 m³/h) + MIX		1.850,39 €	UE	1
506699H1	HIGH T. (Qn 1,5 m³/h)	COLD (Qn 1,5 m³/h) + MIX	HOT	1.917,33 €	UE	1
506699HR	HIGH T. (Qn 1,5 m³/h)	COLD (Qn 1,5 m³/h) + MIX	RECIRCULATION	2.434,12 €	UE	1
506699HR1	HIGH T. (Qn 1,5 m³/h)	COLD (Qn 1,5 m³/h) + MIX	HOT+RECIRCULATION	2.471,77 €	UE	1



• AC 830 / AC 830 P >> p. 396



• >> p. 504



• >>p. 506



For the supply of modules in separate components (template + functional blocks) please refer to the following tables.

IVARSAT-H Template



- **Dima per satellite di utenza per riscaldamento ad alta temperatura e produzione di acqua calda sanitaria.**
- *Template for satellite module for high-temperature heating and domestic hot water preparation.*
- **Gabarit pour satellite d'application pour le chauffage à haute température et production d'eau chaude sanitaire.**
- *Schablone für Satellitenmodul für Heizen mit hoher Temperatur und Trinkwarmwasservorbereitung.*
- **Plantilla para modulo satélite para calefacción a alta temperatura y producción de agua caliente sanitaria.**

Code	Additional units	Price	Class	Packaging
506698H		300,70 €	UE	2
506698H1	HOT	322,62 €	UE	1
506698HR	RECIRCULATION	308,92 €	UE	1
506698HR1	HOT+RECIRCULATION	323,20 €	UE	1

IVARSAT-H Complementary module



- **Modulo complementare per satellite di utenza per riscaldamento ad alta temperatura e produzione di acqua calda sanitaria.**
- *Complementary module for satellite module for high-temperature heating and domestic hot water preparation.*
- **Module complémentaire pour satellite d'application pour le chauffage à haute température et production d'eau chaude sanitaire.**
- *Ergänzungsmodul für Satellitenmodul für Heizen mit hoher Temperatur und Trinkwarmwasservorbereitung.*
- **Módulo complementario para modulo satélite para calefacción a alta temperatura y producción de agua caliente sanitaria.**

Code	Additional units	Price	Class	Packaging
506697H		1.477,22 €	UE	1
506697H1	HOT	1.526,27 €	UE	1
506697HR	RECIRCULATION	2.043,06 €	UE	1
506697HR1	HOT+RECIRCULATION	2.062,83 €	UE	1

■ KIT R IVARSAT

- **Kit di ricircolo per IVAR-SAT.**
- *Recirculation kit for IVAR-SAT.*
- **Kit de recirculation pour IVAR-SAT.**
- *Rückführung-Bausatz für IVAR-SAT.*
- **Kit de recirculación para IVAR-SAT.**

Code	Price	Class	Packaging
506409	586,46 €	UE	1

■ TEST KIT H/B IVARSAT

- **Kit collaudo circuito di riscaldamento e caldaia per satelliti IvarSAT, completo di valvola di sfiato automatica e portagomma per il carico/scarico dell'impianto.**
- *Heating and boiler circuits test kit for IvarSAT satellites, complete of automatic air vent valve and connecting nozzle for system loading/unloading.*
- **Kit de contrôle du circuit de chauffage et chaudière pour les satellites IvarSAT, complété d'un purgeur d'air automatique et d'un porte-caoutchouc pour le remplissage/évacuation de l'installation.**
- *Bausatz Endprüfung Heiz- Kesselkreislauf für Satellitenmodul IvarSAT, komplett mit automatischem Auslassventil und Gummihalter zum Laden/Entladen der Anlage.*
- **Conjunto de prueba del circuito de calefacción y de la caldera para los módulos satélites IvarSAT, equipado con válvula de purga automática y portagoma para la carga/descarga de la instalación.**

Code	Price	Class	Packaging
520046	250,04 €	UE	1

■ TEST KIT DW IVARSAT

- **Kit collaudo circuito sanitario per satelliti IvarSAT, completo di valvola di sfiato automatica e portagomma per il carico/scarico dell'impianto.**
- *Domestic water circuit test kit for IvarSAT satellites, complete of automatic air vent valve and connecting nozzle for system loading/unloading.*
- **Kit de contrôle du circuit sanitaire pour les satellites IvarSAT, complété d'un purgeur d'air automatique et d'un porte-caoutchouc pour le remplissage/évacuation de l'installation.**
- *Bausatz Endprüfung Sanitärkreislauf für Satellitenmodul IvarSAT, komplett mit automatischem Auslassventil und Gummihalter zum Laden/Entladen der Anlage.*
- **Conjunto de prueba del circuito de agua sanitaria para los módulos satélites IvarSAT, equipado con válvula de purga automática y porta-goma para la carga/descarga de la instalación.**

Code	Price	Class	Packaging
520047	290,58 €	UE	1



■ AC 830



- Cassetta murale ad incasso per collettori e moduli MC / IVAR-SAT / MULTIMIX / MULTIMIX-C con altezza e profondità variabili.
- Wall fitted cabinet for manifolds and MC / IVAR-SAT / MULTIMIX / MULTIMIX-C modules with variable height and depth.
- Casette murale encastrable pour collecteurs et modules MC / IVAR-SAT / MULTIMIX / MULTIMIX-C avec hauteur et profondeur variables.
- Einbauwandkasten für Verteiler und Module MC / IVAR-SAT / MULTIMIX / MULTIMIX-C mit variabler Höhe und Tiefe.
- Caja mural de empotrar para colectores y modulos MC / IVAR-SAT / MULTIMIX / MULTIMIX-C de altura y profundidad variables.

Code	Height	Width	Depth	Module	Price	Class	Packaging
200090	860-960 mm	700 mm	110-160 mm	MC 1/11/12/13/14 - MC4 series (1") - IVAR-SAT H/L/LE - 3-way Multimix/Multimix-C	342,76 €	NZ	1
200190	860-960 mm	900 mm	110-160 mm	MC2 series - IVAR-SAT HL/HLE	452,88 €	NZ	1

■ AC 830 P



- Cassetta murale pensile per satelliti di utenza IvarSAT.
- Wall hanging cabinet for IvarSAT utility satellites.
- Caisse murale suspendue pour les satellites d'application IvarSAT.
- Hängewandkasten für Satellitenmodule IvarSAT.
- Caja mural colgante para los modulos satélites IvarSAT.

Code	Height	Width	Depth	Module	Price	Class	Packaging
200094	722 mm	600 mm	150 mm	IVAR-SAT H	307,79 €	UE	1
200194	785 mm	640 mm	150 mm	IVAR-SAT L/LE	355,44 €	UE	1
200294	785 mm	750 mm	150 mm	IVAR-SAT HL/HLE	363,31 €	UE	1

■ T 5011 U



- Testa termostatica con comando incorporato e sensore remoto ad immersione.
- Thermostatic head with incorporated control and immersion remote sensor.
- Tête thermostatique avec commande incorporée et capteur à distance à immersion.
- Thermostat-Kopf mit eingebauter Steuerung und Eintauch-Fernfühler.
- Cabeza termostático con mando incorporado y sensor remoto de inmersión.



Code	Size	Range	Length	Price	Class	Packaging
501175U	M30 x 1,5 - 1/2"	30-55 °C	1 m	54,57 €	AA	5 / 40

■ RV 01



- Servomotore assiale. Compatibile con tutti i vitoni termostatici IVAR.
- Axial motor. Suitable for all IVAR thermostatic inserts.
- Servomoteur axial. Adapté pour tous les inserts thermostatiques IVAR.
- Axial-Stellantrieb. Geeignet für alle Thermostat-Regulievorrichtungen IVAR.
- Servomotor axial. Adecuado para todos los tornillos termostáticos IVAR.



Code	Size	Price	Class	Packaging
501381	M30 x 1,5 - 3-point regulation (230 V AC)	141,88 €	PC	100
501383	M30 x 1,5 - Proportional 0-10 V (24 V AC/DC)	164,60 €	PC	100



- CLIMA•HUB - Regolatore elettronico per impianti di riscaldamento e raffrescamento >>p. 351
- CLIMA•HUB - Electronic controller for heating and cooling systems >>p. 351
- CLIMA•HUB - Régulateur électronique pour systèmes de chauffage et de refroidissement >>p. 351
- CLIMA•HUB - Elektronischer Regler für Heiz- und Kühlsysteme >>p. 351
- CLIMA•HUB - Regulador electrónico para sistemas de calefacción y refrigeración >>p. 351

TE 3040

- **Testa elettrotermica normalmente chiusa (2 fili). Compatibile con tutti i vitoni termostattizzabili IVAR e i collettori con interasse ≥ 50 mm (no EASY-RADIANT).**
- *Electrothermal head normally closed (2 wires). Suitable for all IVAR thermostatic inserts and manifolds with centre-to-centre distance ≥ 50 mm (no EASY-RADIANT).*
- **Tête électrothermique normalement fermée (2 fils). Adaptée pour tous les inserts thermostatisables IVAR et aux collecteurs avec entraxe ≥ 50 mm (non EASY-RADIANT).**
- *Elektrothermischer Stellantriebe stromlos-zu (2 Kabel). Geeignet für alle Thermostat-Regulievorrichtungen IVAR und für Verteiler mit Achsabstand ≥ 50 mm (keine EASY-RADIANT).*
- **Cabeza electotérmica normalmente cerrada (de 2 hilos). Adecuada para todos los tornillos termostattizables IVAR y los colectores con distancia entre centros ≥ 50 mm (no EASY-RADIANT).**

Code	Size	Price	Class	Packaging
501508	M30 x 1,5 ; ON / OFF (230 V AC)	36,60 €	AC	100
501524	M30 x 1,5 ; ON / OFF (24 V AC/DC)	36,60 €	AC	100

TE 3050 M

- **Testa elettrotermica normalmente chiusa con contatto di fine corsa (4 fili). Compatibile con tutti i vitoni termostattizzabili IVAR e i collettori con interasse ≥ 50 mm (no EASY-RADIANT).**
- *Electrothermal head normally closed with limit switch contact (4 wires). Suitable for all IVAR thermostatic inserts and manifolds with centre-to-centre distance ≥ 50 mm (no EASY-RADIANT).*
- **Tête électrothermique normalement fermée avec contact de fin de course (4 fils). Adaptée pour tous les inserts thermostatisables IVAR et aux collecteurs avec entraxe ≥ 50 mm (non EASY-RADIANT).**
- *Elektrothermischer Stellantriebe stromlos-zu mit Endschalterkontakt (4 Kabel). Geeignet für alle Thermostat-Regulievorrichtungen IVAR und für Verteiler mit Achsabstand ≥ 50 mm (keine EASY-RADIANT).*
- **Cabeza electotérmica normalmente cerrada con contacto de fin de carrera (de 4 hilos). Adecuada para todos los tornillos termostattizables IVAR y los colectores con distancia entre centros ≥ 50 mm (no EASY-RADIANT).**

Code	Size	Price	Class	Packaging
500808M	M30 x 1,5 ; ON / OFF (230 V AC)	43,43 €	AC	100
500028M	M30 x 1,5 ; ON / OFF (24 V AC/DC)	43,43 €	AC	100

CBL 02

- **Scheda multifunzione per moduli satellite IvarSAT.**
- *Multifunctional board for IvarSAT satellite modules.*
- **Fiche multifonctions pour les modules satellite IvarSAT.**
- *Multifunktionskarte für Satellitenmodule IvarSAT.*
- **Tarjeta multifunción para módulos satélite IvarSAT.**

Code	Size	Price	Class	Packaging
520119	230 V AC	86,08 €	VA	4 / 32



E•SAT - M•SAT

The E-SAT and M-SAT modules are highly streamlined and simply built user heating interface units able to ensure the production of domestic hot water, upon request, while providing heating to individual residential units. The two systems have no domestic hot water or heat-metering devices, which can be installed together with the module by the installer as required. Their main feature is compactness and despite their small size E-SAT and M-SAT units are able to provide all the domestic hot water (DHW) for an individual residential user component. E-SAT and M-SAT differ in their domestic hot water priority devices: E-SAT is equipped with a flow switch and motorised priority valve, while the M-SAT is a purely mechanical system with an ultra-fast thermostatic priority sensor.

M-SAT

Heating power (*): approx. 12 kW

Domestic hot water output (**): approx. 29 kW - production of approx. 11 l/min of domestic hot water at 48°C with mains input at 10°C

(*) temperature difference = 10°C and pressure differential at the ends of the module = 200 mbar

(**) pressure differential at module ends = 200 mbar and boiler temperature = 60°C

M-SAT



- Satellite di utenza per riscaldamento ad alta temperatura e produzione di acqua calda sanitaria (con valvola di precedenza sanitario con sensore termostatico).
- Satellite module for high-temperature heating and domestic hot water preparation (thermostatic priority valve)
- Satellite d'application pour le chauffage à haute température et production d'eau chaude sanitaire (valve de priorité, à contrôle thermostatique)
- Satellitenmodul für Heizen mit hoher Temperatur und Trinkwarmwasservorbereitung (Thermostat-Prioritätsventil)
- Modulo satélite para calefacción a alta temperatura y producción de agua caliente sanitaria (válvula de prioridad con control termostático)

Code	Size	Price	Class	Packaging
506369	3/4" M	841,92 €	UE	1

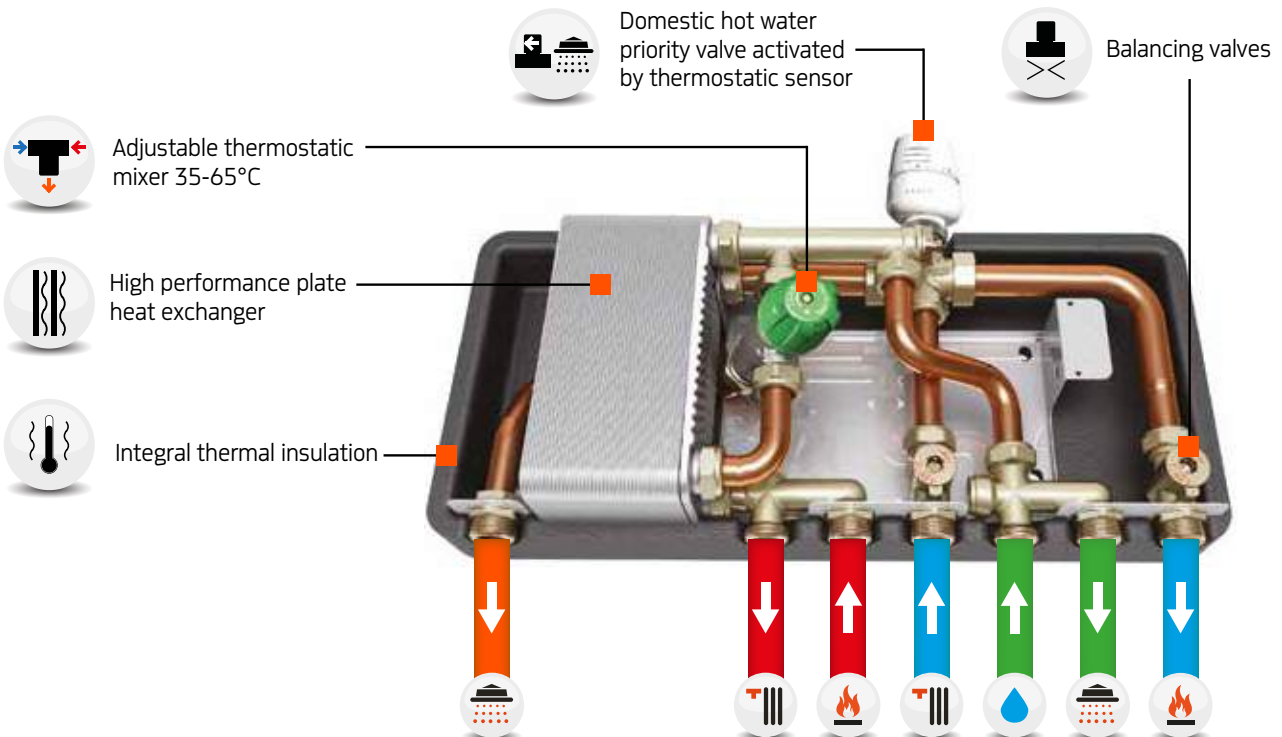

E-SAT

Heating power (*): approx. 16 kW

Domestic hot water output (**): approx. 33 kW - production of approx. 12 l/min of domestic hot water at 48°C with mains input at 10°C

(*) temperature difference = 10°C and pressure differential at the ends of the module = 200 mbar

(**) pressure differential at module ends = 200 mbar and boiler temperature = 60°C

E-SAT

- **Satellite di utenza per riscaldamento ad alta temperatura e produzione di acqua calda sanitaria (con valvola di precedenza sanitario motorizzata).**
- *Satellite module for high-temperature heating and domestic hot water preparation (motorized priority valve)*
- **Satellite d'application pour le chauffage à haute température et production d'eau chaude sanitaire (vanne de priorité motorisée)**
- *Satellitenmodul für Heizen mit hoher Temperatur und Trinkwarmwasservorbereitung (motorisierte Prioritätsventil)*
- **Modulo satélite para calefacción a alta temperatura y producción de agua caliente sanitaria (válvula de prioridad motorizada)**

Code	Size	Price	Class	Packaging
506703	3/4" M	841,92 €	UE	1

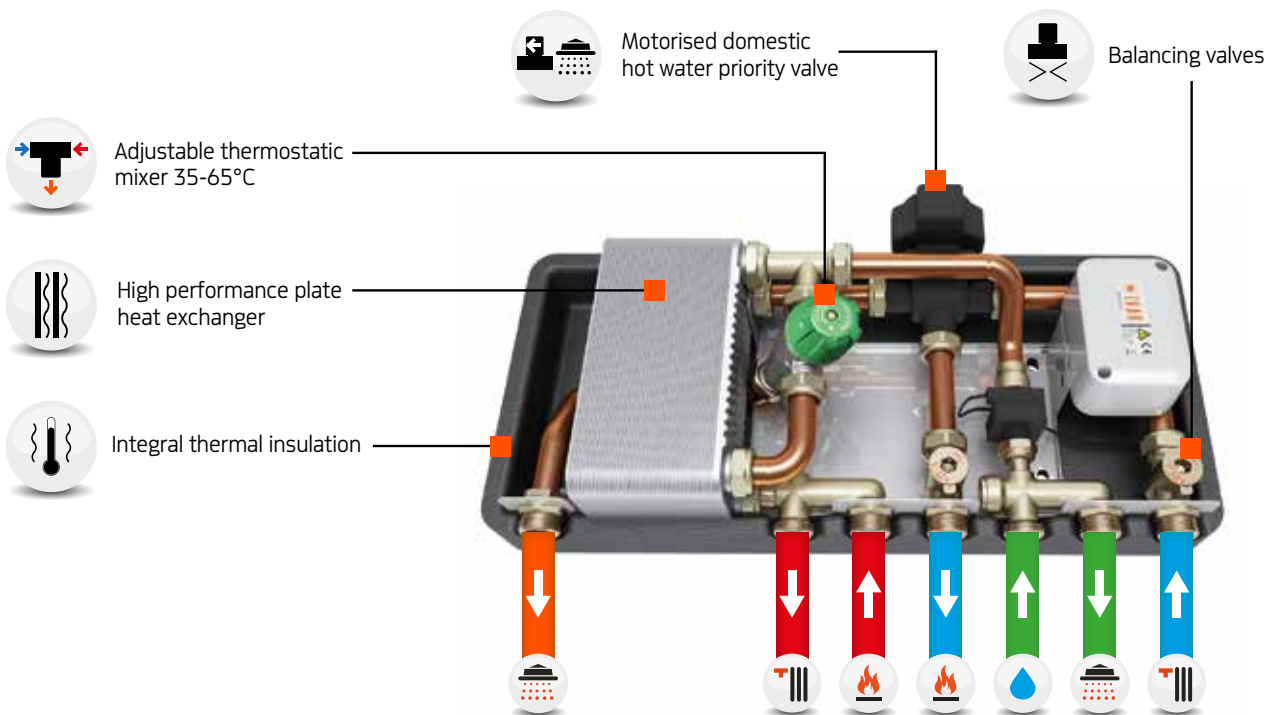

SAP - SAP•C

The instantaneous heating of domestic hot water (DHW) is a refined alternative to heating in a storage tank that minimises the risk of proliferation of bacteria such as legionella and allows simple and total management of the water heater function. SAP and SAP-C are DHW instantaneous heating modules suitable for multi-family and apartment building utilities. SAP / SAP-C are connected to an inertial storage tank containing primary water heated by one or more generators. This water is sent to a high efficiency heat exchanger, which instantly transfers the heat to the domestic hot water on the secondary. The primary circulator is modulated by an electronic control unit according to the temperature read by the flow/temperature sensor, installed on the DHW outlet, compared to the set point set by the user. SAP and SAP-C are available in different sizes, in variants with or without a recirculation circuit, also with mixing valves and thermostatic heads on the primary side to limit the exchanger inlet temperature. The product code refers to the maximum flow rate of domestic hot water in litres per minute that can be heated from 10°C to 45°C at a boiler temperature of 60°C.

Attention. The application of the KIT MIX SAP C to a SAP-C module without mixing valve will convert it into a module with a smaller mixer. For example, applying the SAP C MIX KIT to a SAP-C-30E converts it into a SAP-C-25ME.

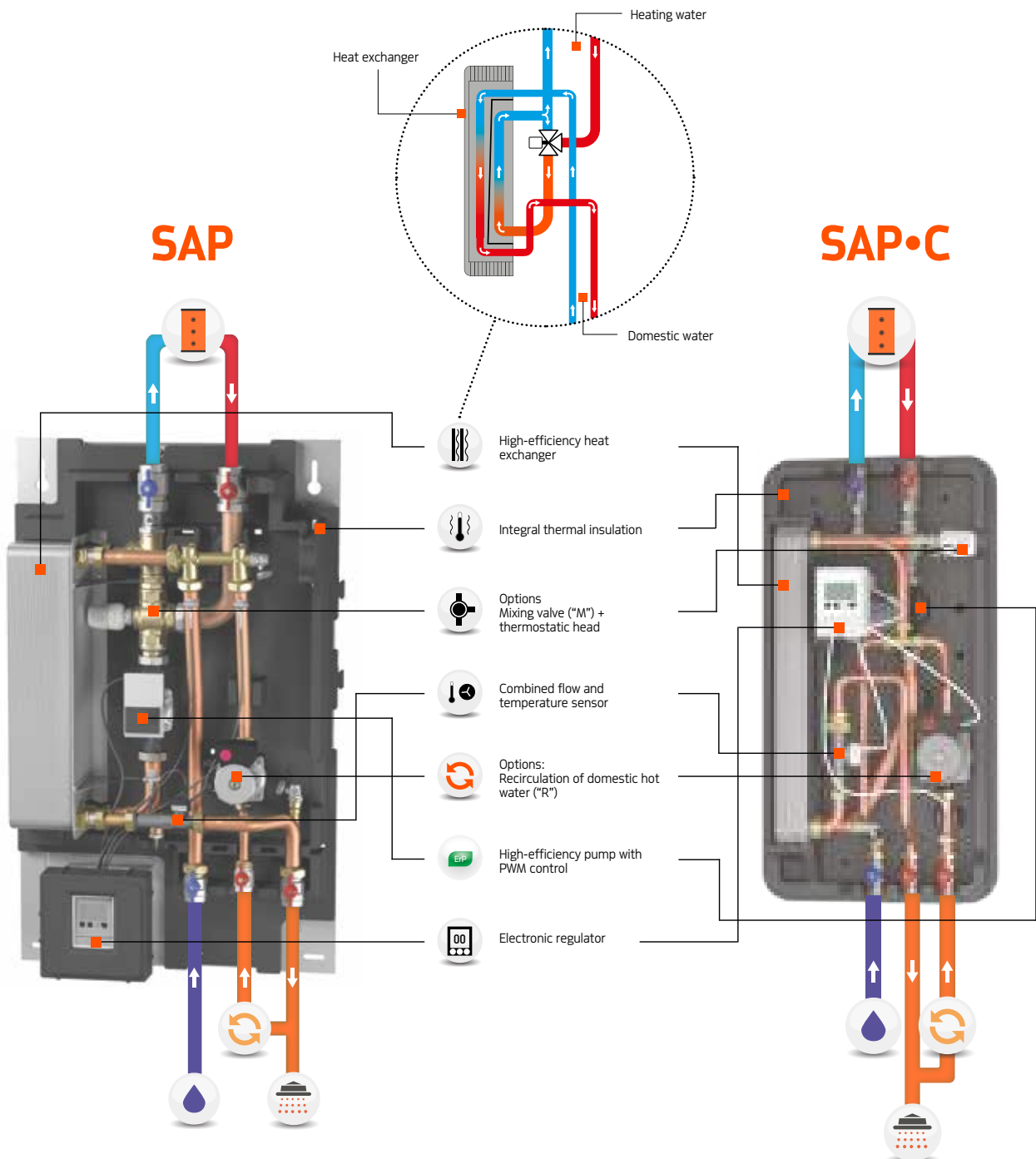

Can be connected in series

For systems with very high or highly variable requirements, it is possible to connect several units in parallel and operate them in series. The master management system (control unit, VFS meter and domestic hot water solenoid valves) leaves each heater the task of adjusting its operating parameters and carries out the rotation of the starts, so that the first element of the cascade is not excessively stressed.

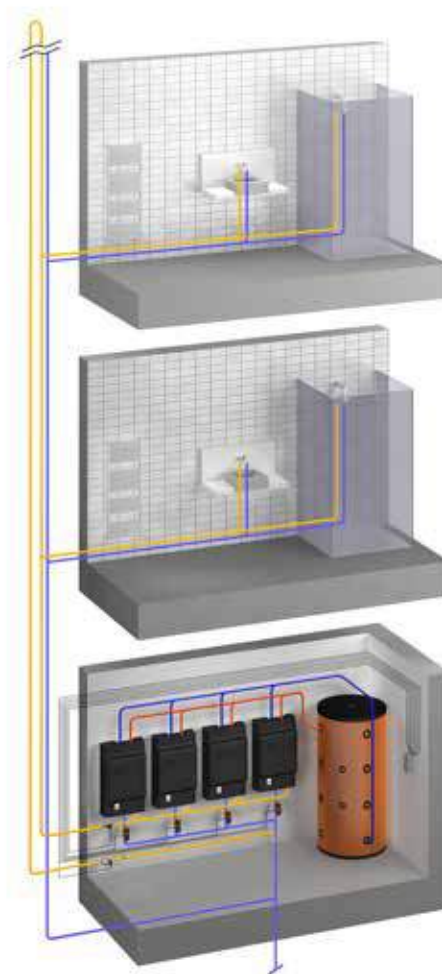
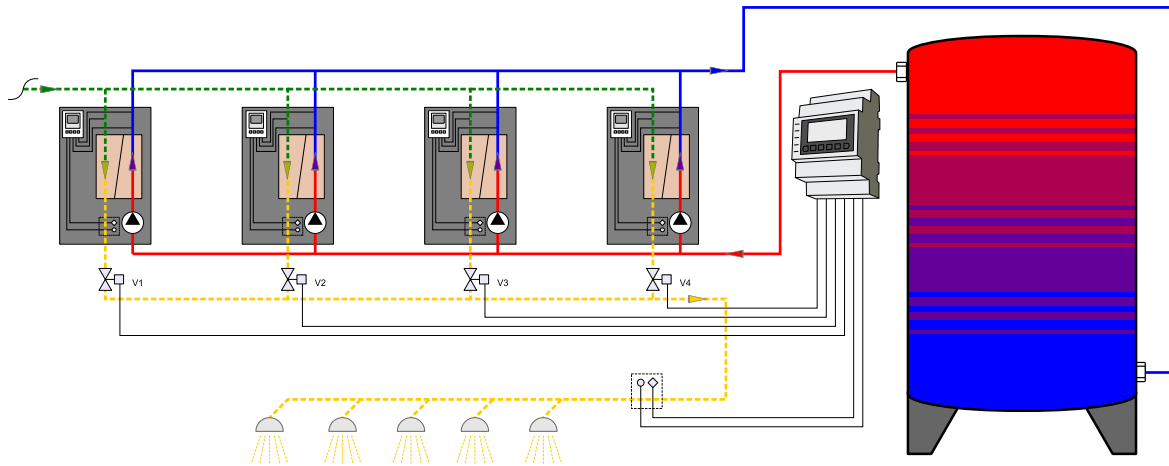

SAP



- **Produttore istantaneo di acqua calda sanitaria.**
- *Fresh water station.*
- **Producteur instantané d'eau chaude sanitaire.**
- *Frischwasserstation.*
- **Productor instantáneo de agua caliente sanitaria.**

1.020 × 640 × 275 mm



Code	Domestic water units	Pump type	Erp	Included components	Price	Class	Packaging
SAP-30M	HOT 30 l/min	3-speed	-	Mixing valve	3.268,47 €	Z8	1
SAP-30MR	HOT 30 l/min	3-speed	-	Mixing valve - Recirculation	3.585,64 €	Z8	1
SAP-35	HOT 35 l/min	3-speed	-		3.024,33 €	Z8	1
SAP-35R	HOT 35 l/min	3-speed	-	Recirculation	3.341,50 €	Z8	1
SAP-40M	HOT 40 l/min	3-speed	-	Mixing valve	3.375,89 €	Z8	1
SAP-40MR	HOT 40 l/min	3-speed	-	Mixing valve - Recirculation	3.693,04 €	Z8	1
SAP-45	HOT 45 l/min	3-speed	-		3.051,31 €	Z8	1
SAP-45R	HOT 45 l/min	3-speed	-	Recirculation	3.368,47 €	Z8	1
SAP-50M	HOT 50 l/min	3-speed	-	Mixing valve	3.596,01 €	Z8	1
SAP-50MR	HOT 50 l/min	3-speed	-	Mixing valve - Recirculation	3.913,17 €	Z8	1
SAP-60	HOT 60 l/min	3-speed	-		3.367,07 €	Z8	1
SAP-60R	HOT 60 l/min	3-speed	-	Recirculation	3.684,24 €	Z8	1
SAP-70M	HOT 70 l/min	3-speed	-	Mixing valve	3.832,07 €	Z8	1
SAP-70MR	HOT 70 l/min	3-speed	-	Mixing valve - Recirculation	4.175,20 €	Z8	1
SAP-80	HOT 80 l/min	3-speed	-		3.603,13 €	Z8	1
SAP-80R	HOT 80 l/min	3-speed	-	Recirculation	3.946,27 €	Z8	1
SAP-90M	HOT 90 l/min	3-speed	-	Mixing valve	4.241,67 €	Z8	1
SAP-90MR	HOT 90 l/min	3-speed	-	Mixing valve - Recirculation	4.584,81 €	Z8	1
SAP-100	HOT 100 l/min	3-speed	-		4.012,73 €	Z8	1
SAP-100R	HOT 100 l/min	3-speed	-	Recirculation	4.355,87 €	Z8	1
SAP-30ME	HOT 30 l/min	Variable speed (PWM)	✓	Mixing valve	3.388,43 €	Z8	1
SAP-30MRE	HOT 30 l/min	Variable speed (PWM)	✓	Mixing valve - Recirculation	3.705,60 €	Z8	1
SAP-35E	HOT 35 l/min	Variable speed (PWM)	✓		3.144,29 €	Z8	1
SAP-35RE	HOT 35 l/min	Variable speed (PWM)	✓	Recirculation	3.461,46 €	Z8	1
SAP-40ME	HOT 40 l/min	Variable speed (PWM)	✓	Mixing valve	3.495,86 €	Z8	1
SAP-40MRE	HOT 40 l/min	Variable speed (PWM)	✓	Mixing valve - Recirculation	3.813,00 €	Z8	1
SAP-45E	HOT 45 l/min	Variable speed (PWM)	✓		3.171,28 €	Z8	1
SAP-45RE	HOT 45 l/min	Variable speed (PWM)	✓	Recirculation	3.488,45 €	Z8	1
SAP-50ME	HOT 50 l/min	Variable speed (PWM)	✓	Mixing valve	3.715,97 €	Z8	1
SAP-50MRE	HOT 50 l/min	Variable speed (PWM)	✓	Mixing valve - Recirculation	4.033,14 €	Z8	1
SAP-60E	HOT 60 l/min	Variable speed (PWM)	✓		3.487,03 €	Z8	1
SAP-60RE	HOT 60 l/min	Variable speed (PWM)	✓	Recirculation	3.804,20 €	Z8	1
SAP-70ME	HOT 70 l/min	Variable speed (PWM)	✓	Mixing valve	4.359,49 €	Z8	1
SAP-70MRE	HOT 70 l/min	Variable speed (PWM)	✓	Mixing valve - Recirculation	4.702,62 €	Z8	1
SAP-80E	HOT 80 l/min	Variable speed (PWM)	✓		4.130,57 €	Z8	1
SAP-80RE	HOT 80 l/min	Variable speed (PWM)	✓	Recirculation	4.473,70 €	Z8	1
SAP-90ME	HOT 90 l/min	Variable speed (PWM)	✓	Mixing valve	4.880,46 €	Z8	1
SAP-90MRE	HOT 90 l/min	Variable speed (PWM)	✓	Mixing valve - Recirculation	5.223,58 €	Z8	1
SAP-100E	HOT 100 l/min	Variable speed (PWM)	✓		4.652,56 €	Z8	1
SAP-100RE	HOT 100 l/min	Variable speed (PWM)	✓	Recirculation	4.995,70 €	Z8	1

SAP-C

ErP



770 × 410 × 220 mm

- **Produttore istantaneo di acqua calda sanitaria compatto.**
- *Compact fresh water station.*
- **Producteur instantané d'eau chaude sanitaire compact.**
- *Kompakt-Frischwasserstation.*
- **Productor instantáneo de agua caliente sanitaria compacto.**

Code	Domestic water units	Pump type	Included components	Price	Class	Packaging
SAP-C-25ME	HOT 25 l/min	Variable speed (PWM)	Mixing valve	2.664,22 €	Z8	1
SAP-C-25MRE	HOT 25 l/min	Variable speed (PWM)	Mixing valve - Recirculation	2.981,40 €	Z8	1
SAP-C-30E	HOT 30 l/min	Variable speed (PWM)		2.575,63 €	Z8	1
SAP-C-30RE	HOT 30 l/min	Variable speed (PWM)	Recirculation	2.892,78 €	Z8	1
SAP-C-35ME	HOT 35 l/min	Variable speed (PWM)	Mixing valve	2.771,65 €	Z8	1
SAP-C-35MRE	HOT 35 l/min	Variable speed (PWM)	Mixing valve - Recirculation	3.088,82 €	Z8	1
SAP-C-40E	HOT 40 l/min	Variable speed (PWM)		2.683,04 €	Z8	1
SAP-C-40RE	HOT 40 l/min	Variable speed (PWM)	Recirculation	3.000,20 €	Z8	1

KIT R SAP

- **Kit di ricircolo per SAP.**
- *Recirculation kit for SAP.*
- **Kit de recirculation pour SAP.**
- *Rückführung-Bausatz für SAP.*
- **Kit de recirculación para SAP.**

Code	Module	Included components	Price	Class	Packaging
502305	SAP-##MR(E) / SAP-##R(E) ≤ 60 l/min	2-speed pump for sanitary applications	317,17 €	Z8	1
502304	SAP-##MR(E) / SAP-##R(E) > 60 l/min	2-speed pump for sanitary applications	343,14 €	Z8	1

KIT R SAP-C

- **Kit di ricircolo per SAP-C.**
- *Recirculation kit for SAP-C.*
- **Kit de recirculation pour SAP-C.**
- *Rückführung-Bausatz für SAP-C.*
- **Kit de recirculación para SAP-C.**

Code	Module	Included components	Price	Class	Packaging
501626	SAP-C-##MRE / SAP-C-##RE	2-speed pump for sanitary applications	309,36 €	Z8	5

KIT MIX SAP-C

- **Valvola miscelatrice termostatica per produttore istantaneo di acqua calda sanitaria compatto.**
- *Thermostatic mixing valve for compact fresh water station.*
- **Vanne mélangeuse thermostatique pour producteur instantané d'eau chaude sanitaire compact.**
- *Thermostat-Mischventil für Kompakt-Frischwasserstation.*
- **Válvula mezcladora termostática para productor instantáneo de agua caliente sanitaria compacto.**

Code	Size	Range	Length	Price	Class	Packaging
501625	1" - M30 x 1,5	20-60 °C	2 m	128,12 €	Z8	8 / 64

■ VS SAP 01



- Valvola a sfera a 2 vie ad apertura rapida per applicazioni sanitarie.
- Quick-opening 2-way ball valve suitable to domestic water applications.
- Vanne à bille à 2 voies avec ouverture rapide pour des applications sanitaires.
- 2-Wege Kugelventil mit Schnellöffnung für Sanitärwendungen.
- Válvula de bola de 2 vías de apertura rápida para aplicaciones sanitarias.

Code	Ways	Size	Price	Class	Packaging
IKR415D	2	G 1" (DN 15) - KvS 12	496,62 €	Z8	1

■ VS SAP 02



- Motore per valvola a sfera a 2 vie ad apertura rapida per applicazioni sanitarie.
- Motor for quick-opening 2-way ball valve suitable to domestic water applications.
- Moteur pour vanne à bille à 2 voies avec ouverture rapide pour des applications sanitaires.
- Stellantrieb für 2-Wege Kugelventil mit Schnellöffnung für Sanitärwendungen.
- Motor para válvula de bola de 2 vías de apertura rápida para aplicaciones sanitarias.

Code	Size	Price	Class	Packaging
IKLRQ24A	24 V AC	788,91 €	Z8	1

■ IFWC3



- Regolatore elettronico di ricambio per SAP con pompa standard a 3 velocità.
- Spare controller for SAP modules with 3-speed standard pump.
- Unité de contrôle de rechange pour modules SAP avec pompe standard à 3 vitesses.
- Ersatzregler für SAP-Module mit Standardpumpe mit 3 Geschwindigkeiten.
- Regulador de reposición para módulos SAP con bomba estándar de 3 velocidades.

Code	Module	Price	Class	Packaging
43000	SAP-xx	430,79 €	Z6	1

■ PT 1000



- Sonda di temperatura con cavo in silicone.
- Temperature probe with silicone cable.
- Sonde de température avec câble en silicone.
- Temperatursonde mit Kabel aus Silikon.
- Sonda de temperatura con cable de silicona.

Code	Type	Max operating temp.	Price	Class	Packaging
81215	Contact	180 °C	29,62 €	Z8	1

■ IKK01



- Centralina elettronica per la gestione di produttori istantanei di acqua calda sanitaria in cascata.
- Electronic control unit for the management of fresh water stations in cascade control.
- Unité de contrôle électronique pour gérer des producteurs instantanés d'eau chaude sanitaire en cascade.
- Elektronische Steuereinheit für die Steuerung der Frischwasserstationen in Kaskade.
- Unidad de control electrónico para la gestión de los productores instantáneos de agua caliente sanitaria en cascada.

Code	Size	Price	Class	Packaging
IKK01	Max 4 modules	1.022,34 €	Z8	1

■ IKK02



- Centralina elettronica per la gestione di produttori istantanei di acqua calda sanitaria in cascata, circuito di ricircolo e funzione antilegionella.
- Electronic control unit for the management of fresh water stations in cascade control, sanitary recirculation circuit and Antilegionella function.
- Unité de contrôle électronique pour gérer des producteurs instantanés d'eau chaude sanitaire en cascade, circuit de recirculation sanitaire et fonction anti-Légionelle.
- Elektronische Steuereinheit für die Steuerung der Frischwasserstationen in Kaskade, Brauchwasserrückführungskreislauf und Antilegionellen-Funktion.
- Unidad de control electrónico para la gestión de los productores instantáneos de agua caliente sanitaria en cascada, circuito de recirculación de agua doméstica y función antilegionella.

Code	Size	Price	Class	Packaging
IKK02	Max 4 modules	1.054,69 €	Z8	1

■ VFS



- Tronchetto di misura per la gestione di produttori istantanei di acqua calda sanitaria in cascata.
- Measuring block for the management of fresh water stations in cascade control.
- Élément de mesure pour gérer des producteurs instantanés d'eau chaude sanitaire en cascade.
- Meßstutzen für die Steuerung der Frischwasserstationen in Kaskade.
- Elemento de medición para la gestión de los productores instantáneos de agua caliente sanitaria en cascada.

Code	Size	Range	Price	Class	Packaging
78040	3/4" M x 1" F	2-40 l/min	358,59 €	Z6	1
78100	1" M x 1" F	5-100 l/min	306,18 €	Z6	1
78400	1"1/2 M x 1"1/2 F	20-400 l/min	649,95 €	Z8	1

SANITARY SYSTEMS



pim.ivar-group.com/short/IT-09

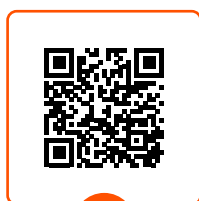

DOWNLOAD
Focus tecnici



pim.ivar-group.com/short/FR-09

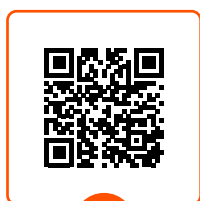

DOWNLOAD
Détails techniques



pim.ivar-group.com/short/DE-09

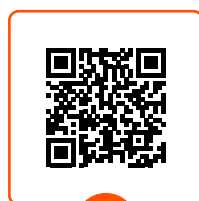

DOWNLOAD
Technische Details



pim.ivar-group.com/short/ES-09

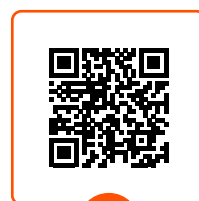

DOWNLOAD
Profundizaciones técnicas



	<p>Collettori sanitari IS•BOX <i>Sanitary manifolds IS•BOX</i> Collecteurs sanitaires IS•BOX <i>Sanitär-Verteiler IS•BOX</i> Colectores sanitarios IS•BOX</p>	408
	<p>Collettori componibili EASY•LOCK <i>Modular manifolds EASY•LOCK</i> Collecteurs à éléments EASY•LOCK <i>Einbauverteiler EASY•LOCK</i> Colectores componibles EASY•LOCK</p>	414
	<p>Collettori componibili serie BASIC <i>Modular manifolds BASIC series</i> Collecteurs à éléments de la série BASIC <i>Einbauverteiler BASIC-Serie</i> Colectores componibles de la serie BASIC</p>	423
	<p>Accessori e raccordi per collettori sanitari <i>Accessories and fittings for sanitary manifolds</i> Accessoires et raccords pour collecteurs sanitaires <i>Zubehör und Verbinder für Sanitärverteiler</i> Accesorios y racores para colectores sanitarios</p>	426
	<p>RTV - valvola termostatica per il controllo della temperatura dei rami di ricircolo sanitario <i>RTV - thermostatic valve for temperature control of sanitary recirculation circuits</i> RTV - robinet thermostatique pour le contrôle de la température des circuits de recirculation sanitaire <i>RTV - Thermostatventil für die Temperaturregelung der Brauchwasserrückführungskreisläufe</i> RTV - válvula termostática para el control de la temperatura de los circuitos de recirculación de agua doméstica</p>	430
	<p>LEGIO•BOX - Sistema per il controllo della temperatura e disinfezione termica <i>LEGIO•BOX - Temperature control and thermal disinfection system</i> LEGIO•BOX - Système pour le contrôle de la température et la désinfection thermique <i>LEGIO•BOX - System zur Temperaturkontrolle und thermischen Desinfektion</i> LEGIO•BOX - Sistema para el control de la temperatura y desinfección térmica</p>	432
	<p>Miscelatori termostatici <i>Thermostatic blenders</i> Limiteurs de température <i>Thermostat-Mischer</i> Mezcladores termostáticos</p>	434
	<p>Gruppi di sicurezza <i>Safety units</i> Groupes de sécurité <i>Sicherheitsaggregate</i> Grupos de seguridad</p>	438
	<p>SAFEMIX - Gruppi di sicurezza con miscelatore termostatico integrato <i>SAFEMIX - Safety units with integrated thermostatic blender</i> SAFEMIX - Groupes de sécurité avec limiteur de température intégré <i>SAFEMIX - Sicherheitsaggregate mit ergänzt Thermostat-Mischer</i> SAFEMIX - Grupos de seguridad con mezclador termostático integrado</p>	440
	<p>Valvole di sicurezza <i>Safety valves</i> Clapets de sécurité <i>Sicherheitsventile</i> Válvulas de seguridad</p>	442



Valvole di ritegno
Check valves
Clapets de retenue
Rückhalteventile
Válvulas de retención

443



Filtri
Strainers
Filtres
Filter
Filtros

444



Riduttori di pressione
Pressure reducing valves
Réducteurs de pression
Druckminderer
Reductores de presión

446

INSTALLATION LAYOUTS

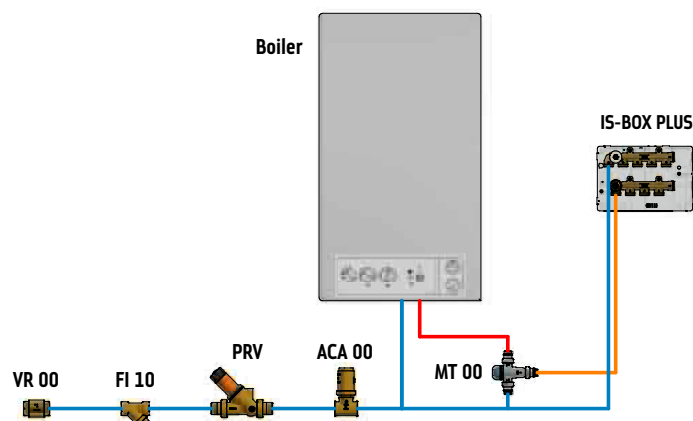
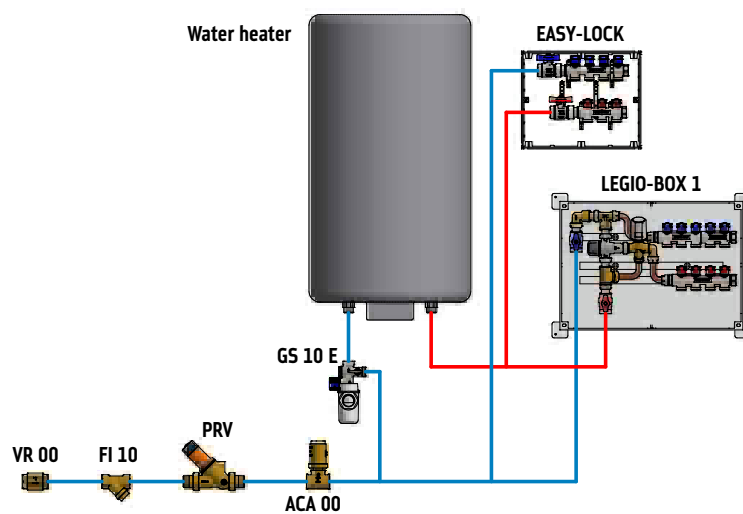

IS•BOX is a box with a pair of DHW manifolds with 3+1 and 4+1 pre-fitted outlets, designed for recess wall-mounting including in bathrooms with tiled walls. The compact dimensions also enable installation in masonry or gypsum board walls with a minimum thickness of 60 mm. The manifolds are drinking water compatible and have inlets with shutoff provision by means of screw-seal valves and replaceable hardware. Available in two colours (white and chrome finish); also in completely accessible versions.

The IS•BOX range has been expanded with two new products: IS•BOX Plus and IS•BOX MPlus, which combine the advantages of a standard IS•BOX with the flexibility of the modular DHW manifolds EASY•LOCK, enabling the personalisation of both manifold models and number of outlets required. The MPlus version is equipped with an adjustable thermostatic mixer with anti-scald function, to prevent delivery to water terminals at excessively high temperatures.

Materials

Brass parts: CW617N

Sealing elements: peroxide EPDM

Technical specifications

Max. fluid temperature inside manifold: 100 °C

Maximum operating pressure: 10 bar

⊕ PLUS (IS•BOX)

- Compact solution ideal for thin walls (installation thickness of only 60 mm)
- Available with white or chrome finish
- Completely pre-assembled

IS•BOX

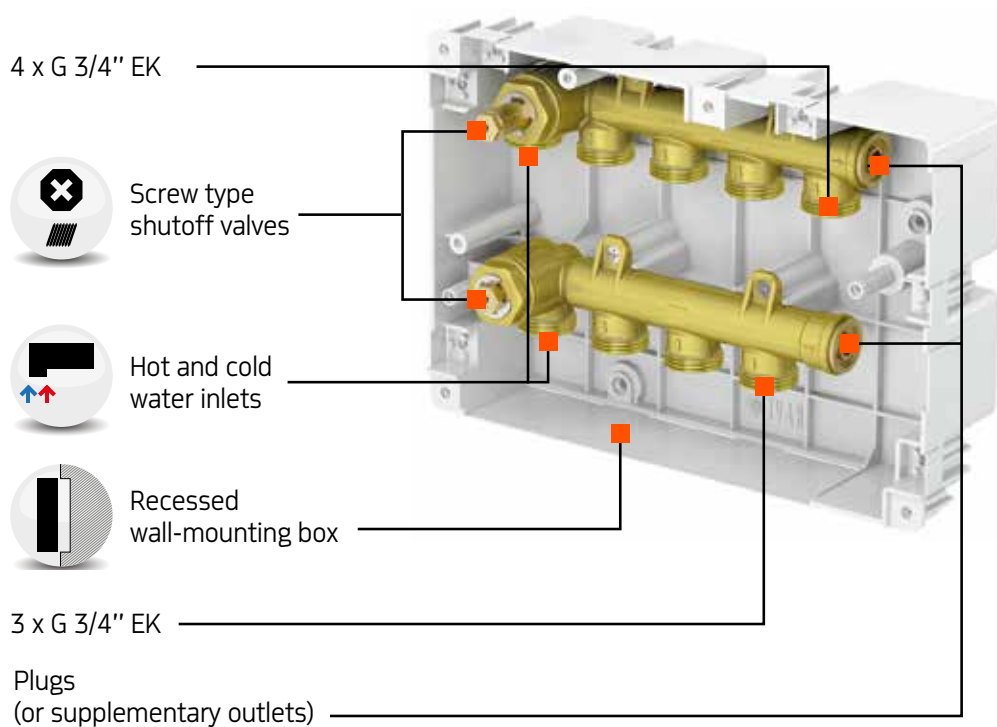

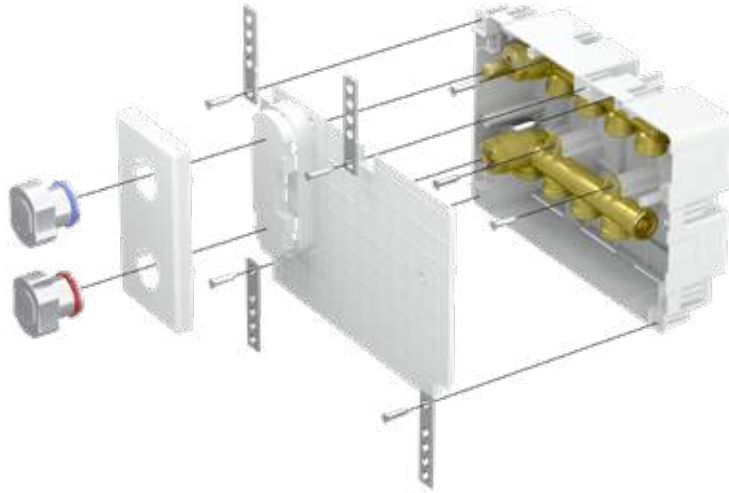

BASIC VERSION

INSPECTABLE

WITH SHUTOFF OPTION
WITHOUT REMOVING BACKPLATE

WITH SHUTOFF OPTION
WITHOUT REMOVING BACKPLATE
 INSPECTABLE



■ IS-BOX 1



182 × 267 × 60 mm

- IS-BOX base.
- IS-BOX basic.
- IS-BOX de base.
- IS-BOX Basis.
- IS-BOX base.

Code	Hot / Cold ways	Size	Color	Price	Class	Packaging
506592	3 HOT / 4 COLD	EUROK	□	170,42 €	OC	1 / 4
506592CR	3 HOT / 4 COLD	EUROK	■	177,86 €	OC	1 / 4

■ IS-BOX 2



182 × 267 × 60 mm

- IS-BOX ispezionabile.
- Inspectable IS-BOX.
- IS-BOX inspectionnable.
- IS-BOX zu inspizieren.
- IS-BOX inspeccionable.

Code	KIT 2 IS-BOX	Hot / Cold ways	Size	Color	Price	Class	Packaging
506593	✓	3 HOT / 4 COLD	EUROK	□	179,88 €	OC	1 / 4
506593CR	✓	3 HOT / 4 COLD	EUROK	■	221,91 €	OC	1 / 4

■ IS-BOX 3



182 × 267 × 60 mm

- IS-BOX con manopole di intercettazione cromate.
- IS-BOX with isolation chrome knobs.
- IS-BOX avec poignées d'interception chromées.
- IS-BOX zu inspizieren.
- IS-BOX con mandos de corte cromados.

Code	KIT 1 IS-BOX	Hot / Cold ways	Size	Color	Price	Class	Packaging
506594	✓	3 HOT / 4 COLD	EUROK	□	214,35 €	OC	1 / 4
506594CR	✓	3 HOT / 4 COLD	EUROK	■	223,68 €	OC	1 / 4

■ IS-BOX 4



182 × 267 × 60 mm

- IS-BOX ispezionabile con manopole di intercettazione cromate.
- Inspectable IS-BOX with isolation chrome knobs.
- IS-BOX inspectionnable avec poignées d'interception chromées.
- IS-BOX zu inspizieren mit verchromten Überwachungsknöpfen.
- IS-BOX inspeccionable con mandos de corte cromados.

Code	KIT 1 IS-BOX	KIT 2 IS-BOX	Hot / Cold ways	Size	Color	Price	Class	Packaging
506595	✓	✓	3 HOT / 4 COLD	EUROK	□	223,80 €	OC	1 / 4
506595CR	✓	✓	3 HOT / 4 COLD	EUROK	■	267,72 €	OC	1 / 4



- Raccordo per tubo in rame >> p. 61,66,126,429
- Fitting for copper pipe >> p. 61,66,126,429
- Raccord pour tube en cuivre >> p. 61,66,126,429
- Verschraubung für Kupferrohr >> p. 61,66,126,429
- Conexión para tubo de cobre >> p. 61,66,126,429



- Raccordo per tubo multistrato >> p. 66,123,212,428
- Fitting for multilayer pipe >> p. 66,123,212,428
- Raccord pour tube multicouche >> p. 66,123,212,428
- Verschraubung für Verbundrohr >> p. 66,123,212,428
- Conexión para tubo multicapa >> p. 66,123,212,428



- Raccordo per tubo in polietilene >> p. 66,124,212,428
- Fitting for polyethylene pipe >> p. 66,124,212,428
- Raccord pour tube en polyéthylène >> p. 66,124,212,428
- Verschraubung für PEX-Rohr >> p. 66,124,212,428
- Conexión para tubo de polietileno >> p. 66,124,212,428

KIT 1 IS BOX

- Kit manopole di intercettazione cromate per IS BOX base.
- Isolation chrome knobs kit for IS BOX basic.
- Kit de poignées d'interception chromées pour IS BOX de base.
- Bausatz verchromter Überwachungsknöpfe für IS BOX Basis.
- Conjunto de mandos de corte cromados para IS BOX base.

Code	Color	Price	Class	Packaging
506650	□	51,56 €	OC	1 / 8
506650CR	■	60,68 €	OC	1 / 8

KIT 2 IS BOX

- Kit ispezionabile per IS BOX base.
- Inspectable kit for IS BOX basic.
- Kit inspectionnable pour IS BOX de base.
- Inspektions-Bausatz für IS BOX Basis.
- Conjunto inspeccionable para IS BOX base.

Code	Color	Price	Class	Packaging
506651	□	9,47 €	OC	1
506651CR	■	44,07 €	OC	1

KIT 3 IS BOX

- Placca per IS BOX con manopole di intercettazione.
- Plate for IS BOX with isolation knobs.
- Plaque pour IS BOX avec poignées d'interception.
- Platte für IS BOX zu inspizieren.
- Placa para IS BOX con mandos de corte.

Code	Color	Price	Class	Packaging
506652	□	2,907 €	OC	1
506652CR	■	11,96 €	OC	1

KIT 4 IS BOX

- Placca per IS BOX base.
- Plate for IS BOX basic.
- Plaque pour IS BOX de base.
- Platte für IS BOX Basis.
- Placa para IS BOX base.

Code	Color	Price	Class	Packaging
506084	□	2,729 €	OC	1
506084CR	■	11,76 €	OC	1

AR 22

- Prolunga per rubinetto da incasso.
- Extension for built in valve.
- Rallonge pour robinet à encastrement.
- Verlängerung für Einbauhahn.
- Extención para grifo empotrable.

Code	Size	Price	Class	Packaging
550199	DN 15	4,36 €	IG	50 / 400



IS-BOX Plus

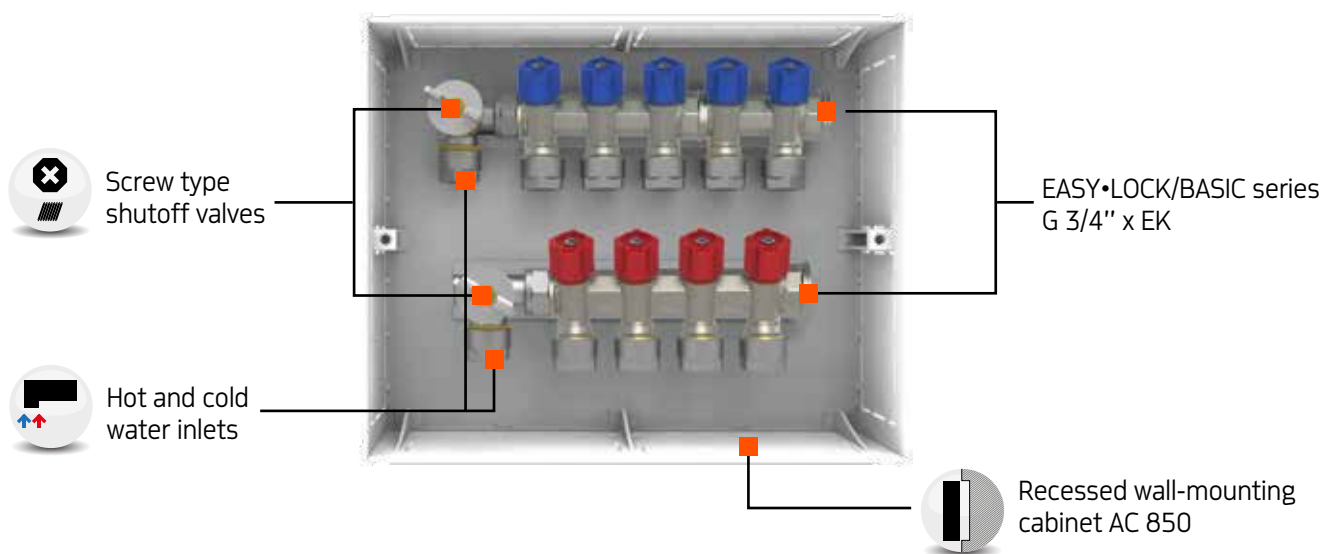

IS-BOX PLUS



- **Kit con valvole di intercettazione a vite per sistema IS-BOX Plus e dadi girevoli da 3/4" F per montaggio collettori serie EASY-LOCK / BASIC.**
- *Kit including isolation screw valves for IS-BOX Plus system and 3/4" F swivelling nuts for the connection of EASY-LOCK / BASIC series manifolds.*
- **Kit avec vannes d'interception à vis pour système IS-BOX Plus et écrous pivotants 3/4" F pour la connections des collecteurs de la série EASY-LOCK / BASIC.**
- *Bausatz mit Schraube-Absperrventilen für System IS-BOX Plus und drehbarer Mutter 3/4" IG für den Anschluss von Verteilern der Serie EASY-LOCK / BASIC.*
- **Kit con válvulas de cierre con tornillo para el sistema IS-BOX Plus y arandela 3/4" F para el montaje de los colectores de la serie EASY-LOCK / BASIC.**

Code	Size	Suitable Cabinet	Price	Class	Packaging
506684	3/4" EUROK x 3/4" F TP	AC 850	71,34 €	OC	1

- **AC 850 (cassetta abbinabile fino a 5 vie AFS + 4 vie ACS: codice SAM-032) >>p. 205,426**
- *AC 850 (suitable cabinet up to 5 Cold + 4 Hot ways: code SAM-032) >>p. 205,426*
- **AC 850 (cassette combinable jusqu'à 5 voies AFS + 4 voies ECS: code SAM-032) >>p. 205,426**
- *AC 850 (kombiniert Verteilerschrank bis zu 5 Kaltwasser-Wege + 4 Warmwasser-Wege: Artikelnummer SAM-032) >>p. 205,426*
- **AC 850 (caja combinable hasta 5 vías AFS + 4 vías ACS: código SAM-032) >>p. 205,426**

- **Per i collettori componibili della serie EASY-LOCK / BASIC da abbinare, vedere le sezioni seguenti.**
- *For the modular manifolds EASY-LOCK / BASIC series to be matched, see the following sections.*
- **Pour les collecteurs de la série EASY-LOCK / BASIC à combiner, voir les sections suivantes.**
- *Für die Einbauverteiler der Serie EASY-LOCK / BASIC zu kombinieren, beachten Sie die folgenden Abschnitte.*
- **Para los colectores de la serie EASY-LOCK / BASIC para combinar, consulte las siguientes secciones.**

IS•BOX MPlus

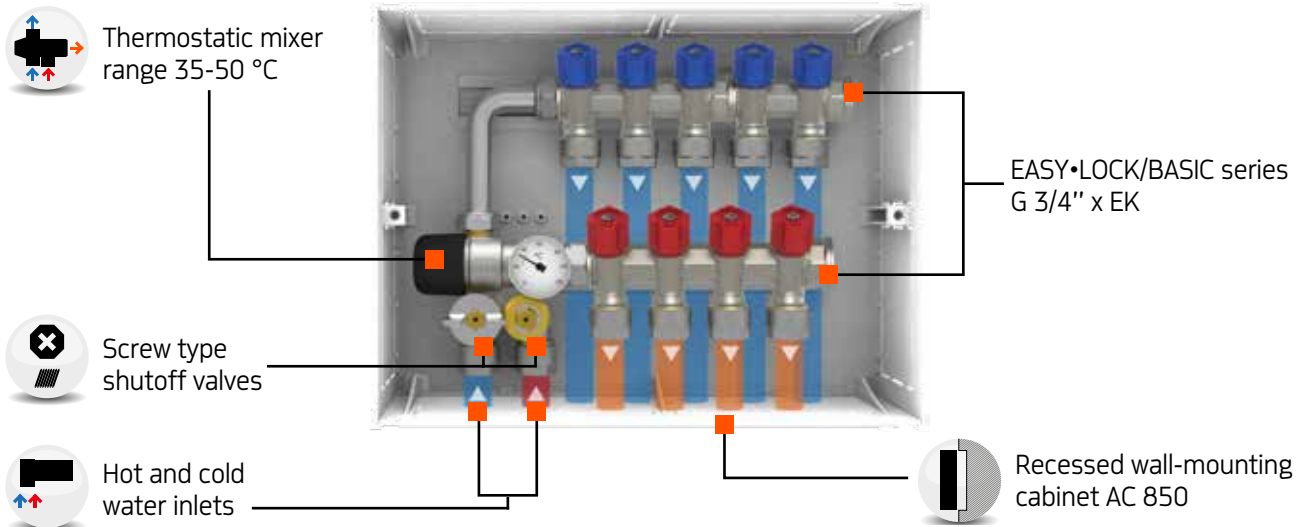

IS-BOX MPLUS



- **Kit con valvole di intercettazione a vite e miscelatore termostatico integrato per sistema IS-BOX MPlus con dadi girevoli da 3/4" F per montaggio collettori serie EASY-LOCK / BASIC.**
- **Kit with isolation screw valves and built-in thermostatic blender for IS-BOX MPlus system with 3/4" F swiveling nuts for the connection of EASY-LOCK / BASIC series manifolds.**
- **Kit avec vannes d'interception à vis et limiteur de température intégré pour système IS-BOX MPlus avec écrous pivotants 3/4" F pour la connections des collecteurs de la série EASY-LOCK / BASIC.**
- **Bausatz mit Schraube-Absperrventilen und ergänzt Thermostat-Mischer für System IS-BOX MPlus mit drehbarer Mutter 3/4" IG für den Anschluss von Verteilern der Serie EASY-LOCK / BASIC.**
- **Kit con válvulas de cierre con tornillo y mezclador termostático integrado para el sistema IS-BOX MPlus con arandela 3/4" F para el montaje de los colectores de la serie EASY-LOCK / BASIC.**

Code	Size	Range	Suitable Cabinet	Price	Class	Packaging
506664	3/4" EUROK x 3/4" F TP	35-50 °C	AC 850	226,35 €	OC	1



- AC 850 (cassetta abbinabile fino a 5 vie AFS + 4 vie ACS: codice SAM-032) >>p. 205,426
- AC 850 (suitable cabinet up to 5 Cold + 4 Hot ways: code SAM-032) >>p. 205,426
- AC 850 (cassetta combinabile jusqu'à 5 voies AFS + 4 voies ECS: code SAM-032) >>p. 205,426
- AC 850 (kombiniert Verteilerschrank bis zu 5 Kaltwasser-Wege + 4 Warmwasser-Wege: Artikelnummer SAM-032) >>p. 205,426
- AC 850 (caja combinable hasta 5 vías AFS + 4 vías ACS: código SAM-032) >>p. 205,426

- Per i collettori componibili della serie EASY•LOCK / BASIC da abbinare, vedere le sezioni seguenti.
- For the modular manifolds EASY•LOCK / BASIC series to be matched, see the following sections.
- Pour les collecteurs de la série EASY•LOCK / BASIC à combiner, voir les sections suivantes.
- Für die Einbauteiler der Serie EASY•LOCK / BASIC zu kombinieren, beachten Sie die folgenden Abschnitte.
- Para los colectores de la serie EASY•LOCK / BASIC para combinar, consulte las siguientes secciones.

EASY•LOCK

The manifolds in the EASY•LOCK range feature the option for practical and simple interconnection with one another. Thanks to the offset design of the threads, EASY•LOCK manifolds remain aligned and the action of an O-ring ensures perfect sealing efficiency. This means that it is prohibited to use sealing systems such as hemp or PTFE, or to use additional sealants.

When shut-off valves or caps are fitted to the EASY•LOCK manifolds, the best solution is always to use IVAR components with the same sealing technology – soft seal with o-ring.

If it is necessary to make a connection to a threaded component without soft seal technology, the use of hemp is still prohibited; it is recommended instead to use PTFE tape or a thread sealing cord (e.g. Loctite® 55), of which the appropriate quantity should be used, applying a **maximum tightening torque of between 15 and 20 Nm** with a tool.

The manifolds are nickel plated on the exterior only, and therefore remain yellow on the inside, ensuring conformity for conveying drinking water.

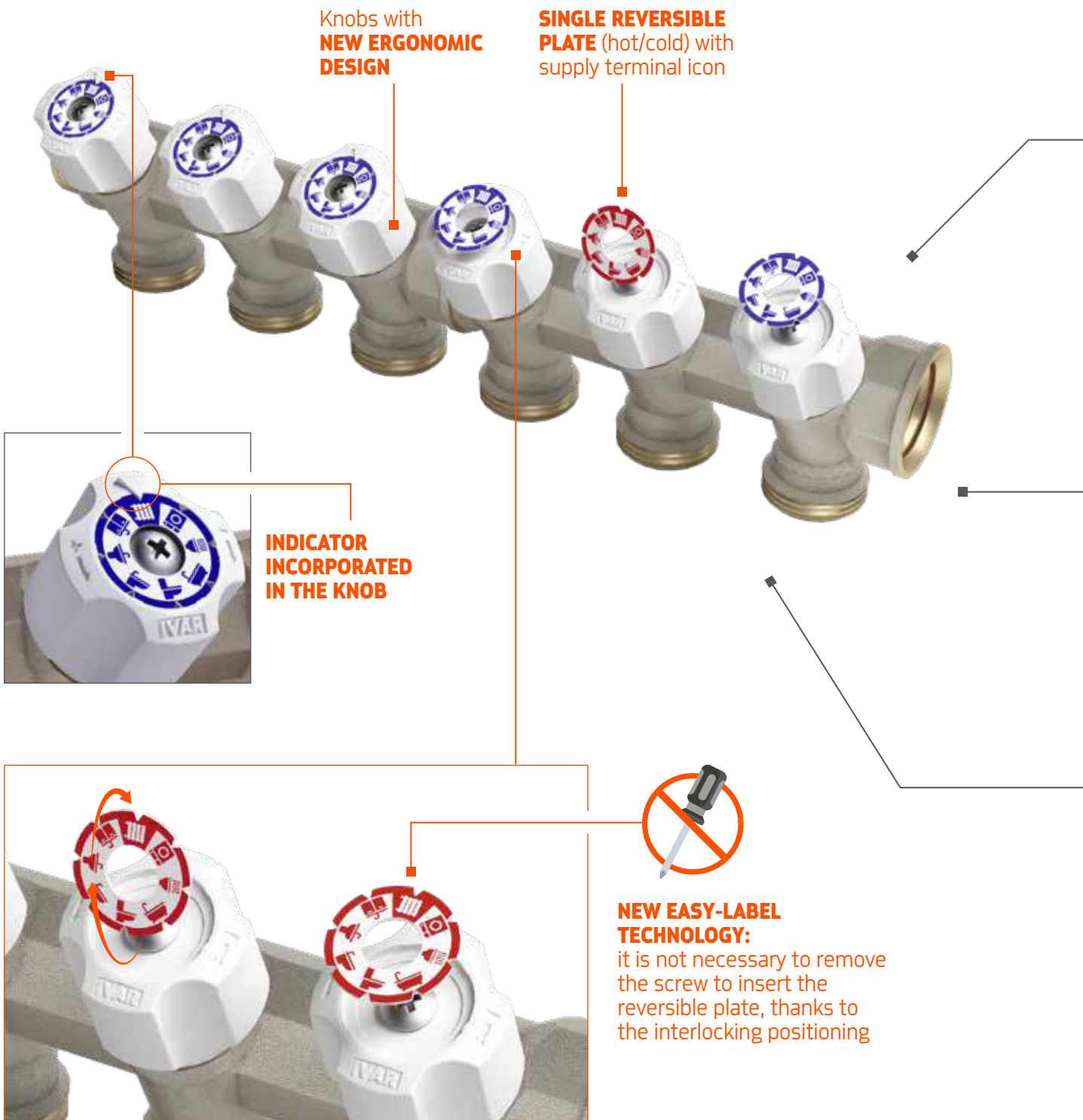

Materials

Brass parts: CW617N nickel-plated on exterior only
 Sealing elements: peroxide EPDM

Technical specifications

Max. fluid temperature inside manifold: 100 °C
 Maximum operating pressure: 10 bar
 Outlet interaxis: 40 mm



AUTOMATIC ALIGNMENT BY HAND
THANKS TO OFFSET THREADS.
 NO tightening tool is required.

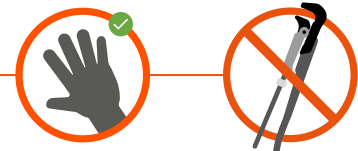

O-RING FOR SOFT SEAL:
 no additional sealant such as hemp or Teflon required.

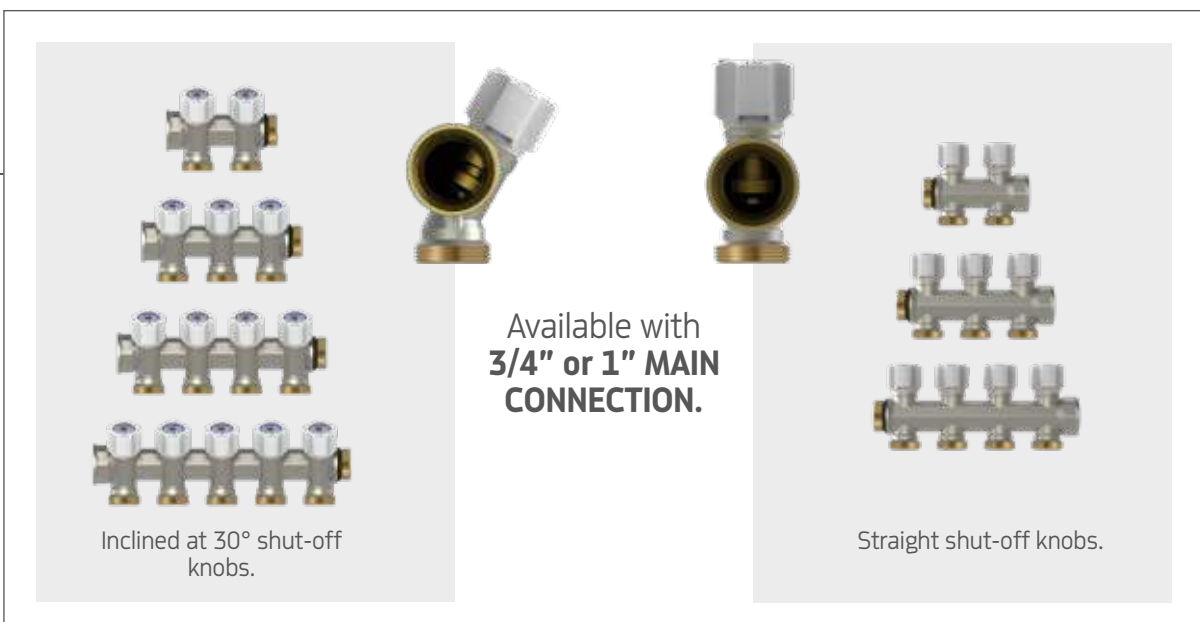
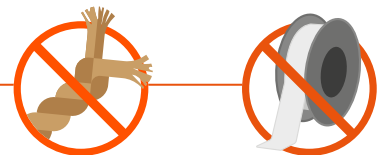

Available with
3/4" or 1" MAIN CONNECTION.

Inclined at 30° shut-off knobs.

Straight shut-off knobs.

EASY•LOCK manifolds with EUROK connections and suitable fittings

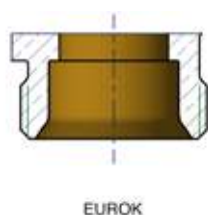

- A) MPL 5705 >> p. 109
- B) MP 5705 >> p. 95
- C) TR 4430 >> p. 126
- D) TP 4410 >> p. 124
- E) TA 4420 >> p. 123

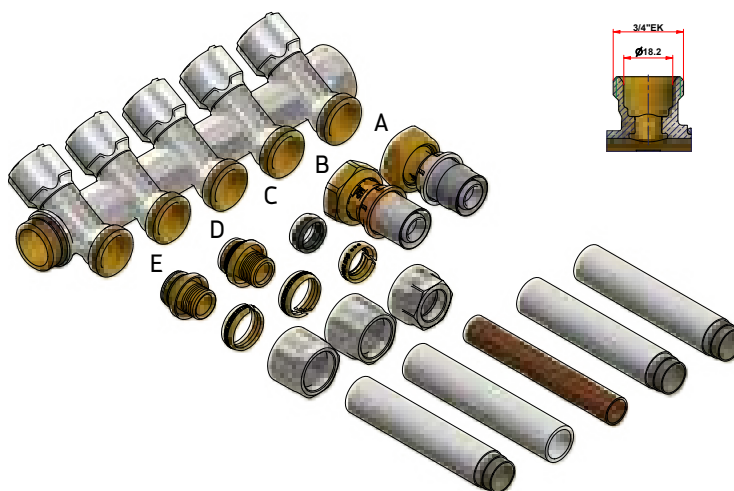

CI 390 N

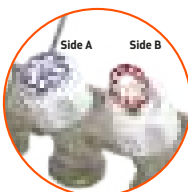

- Collettore componibile serie EASY LOCK (interasse 40 mm) con valvole di intercettazione a manovra manuale, piastrina reversibile (calda/fredda) con indicazione del terminale di erogazione e attacchi inclinati a 30°.
- Modular manifold EASY LOCK series (centre-to-centre distance 40 mm) with manually operated isolation valves, reversible plate (hot/cold) showing the element connected to the corresponding outtake and 30° inclined connections.
- Collecteur à éléments série EASY LOCK (empattement 40 mm) avec des vannes d'interception à manoeuvre manuelle, plaque réversible (chaud / froid) avec indication du terminal de distribution et embouts inclinés à 30°.
- Einbauverteiler Serie EASY LOCK (Radstand 40 mm) mit Absperbareventile mit manueller Hebel, reversible Platte (warm / kalt) mit Angabe des Ausgabe-Terminal und bei 30° geneigt Anschlüssen.
- Colector componible serie EASY LOCK (distancia entre ejes 40 mm) con válvulas de cierre con cabeza manual, placa reversible (fría / caliente) con indicación de la terminal de dispensación y conexiones inclinadas en 30°

Code	Ways	Size	OC distance	Color	Price	Class	Packaging
507800N	2	3/4" x EUROK	40 mm	Blue or Red (reversible)	26,13 €	NG	8 / 32
507801N	3	3/4" x EUROK	40 mm	Blue or Red (reversible)	36,56 €	NG	5 / 20
507802N	4	3/4" x EUROK	40 mm	Blue or Red (reversible)	46,93 €	NG	4 / 16
507830N	5	3/4" x EUROK	40 mm	Blue or Red (reversible)	61,56 €	NG	5
507815N	2	1" x EUROK	40 mm	Blue or Red (reversible)	30,05 €	NG	8 / 32
507816N	3	1" x EUROK	40 mm	Blue or Red (reversible)	40,57 €	NG	5 / 20
507817N	4	1" x EUROK	40 mm	Blue or Red (reversible)	51,10 €	NG	4 / 16

CI 490 N

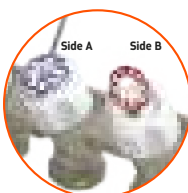

- Collettore componibile serie EASY LOCK (interasse 40 mm) con valvole di intercettazione a manovra manuale e piastrina reversibile (calda/fredda) con indicazione del terminale di erogazione.
- Modular manifold EASY LOCK series (centre-to-centre distance 40 mm) with manually operated isolation valves and reversible plate (hot/cold) showing the element connected to the corresponding outtake.
- Collecteur à éléments série EASY LOCK (empattement 40 mm) avec des vannes d'interception à manoeuvre manuelle et plaque réversible (chaud / froid) avec indication du terminal de distribution.
- Einbauverteiler Serie EASY LOCK (Radstand 40 mm) mit Absperbareventile mit manueller Hebel und reversibler Platte (warm / kalt) mit Angabe des Ausgabe-Terminal.
- Colector componible serie EASY LOCK (distancia entre ejes 40 mm) con válvulas de cierre con cabeza manual y placa reversible (fría / caliente) con indicación de la terminal de dispensación.

Code	Ways	Size	OC distance	Color	Price	Class	Packaging
507300N	2	3/4" x EUROK	40 mm	Blue or Red (reversible)	21,28 €	NG	8 / 32
507301N	3	3/4" x EUROK	40 mm	Blue or Red (reversible)	28,88 €	NG	5 / 20
507302N	4	3/4" x EUROK	40 mm	Blue or Red (reversible)	36,75 €	NG	4 / 16
507320N	2	1" x EUROK	40 mm	Blue or Red (reversible)	23,56 €	NG	8 / 32
507321N	3	1" x EUROK	40 mm	Blue or Red (reversible)	32,22 €	NG	5 / 20
507322N	4	1" x EUROK	40 mm	Blue or Red (reversible)	40,08 €	NG	4 / 16

CI 490 NW

- Collettore componibile serie EASY LOCK (interasse 40 mm) con valvole di intercettazione a manovra manuale.
- Modular manifold EASY LOCK series (centre-to-centre distance 40 mm) with manually operated isolation valve.
- Collecteur à éléments série EASY LOCK (empattement 40 mm) avec des vannes d'interception à manoeuvre manuelle.
- Einbauverteiler Serie EASY LOCK (Radstand 40 mm) mit Absperbareventile mit manueller Hebel.
- Colector componible serie EASY LOCK (distancia entre ejes 40 mm) con válvulas de cierre con cabeza manual.

Code	Ways	Size	OC distance	Color	Price	Class	Packaging
507300NW	2	3/4" x EUROK	40 mm	□	20,15 €	NG	8 / 32
507301NW	3	3/4" x EUROK	40 mm	□	27,09 €	NG	5 / 20
507302NW	4	3/4" x EUROK	40 mm	□	34,35 €	NG	4 / 16
507320NW	2	1" x EUROK	40 mm	□	22,52 €	NG	8 / 32
507321NW	3	1" x EUROK	40 mm	□	30,66 €	NG	5 / 20
507322NW	4	1" x EUROK	40 mm	□	38,37 €	NG	4 / 16

CI 490 NB

- Collettore componibile serie EASY LOCK (interasse 40 mm) con valvole di intercettazione a manovra manuale.
- Modular manifold EASY LOCK series (centre-to-centre distance 40 mm) with manually operated isolation valve.
- Collecteur à éléments série EASY LOCK (empattement 40 mm) avec des vannes d'interception à manoeuvre manuelle.
- Einbauverteiler Serie EASY LOCK (Radstand 40 mm) mit Absperbareventile mit manueller Hebel.
- Colector componible serie EASY LOCK (distancia entre ejes 40 mm) con válvulas de cierre con cabeza manual.

Code	Ways	Size	OC distance	Color	Price	Class	Packaging
507300NB	2	3/4" x EUROK	40 mm	■	20,15 €	NG	8 / 32
507301NB	3	3/4" x EUROK	40 mm	■	27,09 €	NG	5 / 20
507302NB	4	3/4" x EUROK	40 mm	■	34,35 €	NG	4 / 16
507320NB	2	1" x EUROK	40 mm	■	22,52 €	NG	8 / 32
507321NB	3	1" x EUROK	40 mm	■	30,66 €	NG	5 / 20
507322NB	4	1" x EUROK	40 mm	■	38,37 €	NG	4 / 16

CI 490 NR

- Collettore componibile serie EASY LOCK (interasse 40 mm) con valvole di intercettazione a manovra manuale.
- Modular manifold EASY LOCK series (centre-to-centre distance 40 mm) with manually operated isolation valve.
- Collecteur à éléments série EASY LOCK (empattement 40 mm) avec des vannes d'interception à manoeuvre manuelle.
- Einbauverteiler Serie EASY LOCK (Radstand 40 mm) mit Absperbareventile mit manueller Hebel.
- Colector componible serie EASY LOCK (distancia entre ejes 40 mm) con válvulas de cierre con cabeza manual.

Code	Ways	Size	OC distance	Color	Price	Class	Packaging
507300NR	2	3/4" x EUROK	40 mm	■	20,15 €	NG	8 / 32
507301NR	3	3/4" x EUROK	40 mm	■	27,09 €	NG	5 / 20
507302NR	4	3/4" x EUROK	40 mm	■	34,35 €	NG	4 / 16
507320NR	2	1" x EUROK	40 mm	■	22,52 €	NG	8 / 32
507321NR	3	1" x EUROK	40 mm	■	30,66 €	NG	5 / 20
507322NR	4	1" x EUROK	40 mm	■	38,37 €	NG	4 / 16



- AC 655 NST >>p. 221,308,323

- Per cassette, kit di fissaggio e raccordi vedere la sezione "Accessori e raccordi per collettori sanitari".
- For cabinets, fixing kits and fittings see the "Accessories and fittings for sanitary manifolds" section.
- Pour les cassettes, les kits de fixation et les raccords, voir la section «Accessoires et raccords pour collecteurs sanitaires».
- Für Kästen, Befestigungssätzen und Verbinder beachten Sie Abschnitt „Zubehör und Verbinder für Sanitärverteiler“.
- Para cajas, kits de fijación y racores, consulte la sección "Accesorios y racores para colectores sanitarios".

EASY•LOCK manifolds with 1/2" M, 1/2" M TP and M24x1,5 connections and suitable fittings

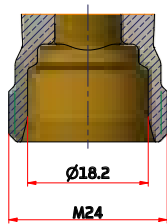

A) TA 420 >> p. 428

B) TP 410 >> p. 428

C) TR 430 >> p. 429

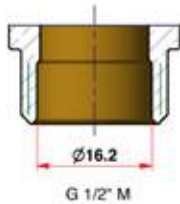
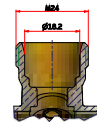
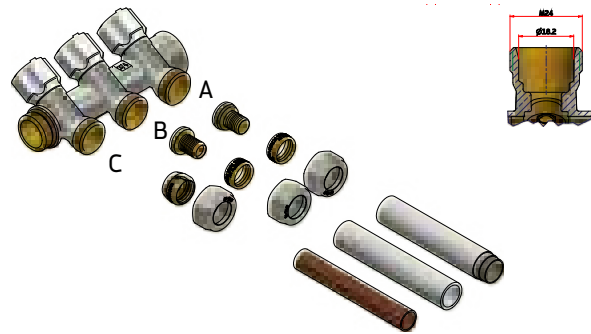

A) TA 420 P >> p. 428

B) TP 410 P >> p. 428

C) TR 430 P >> p. 429

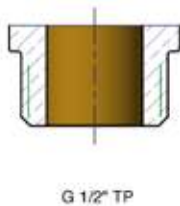
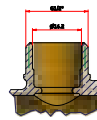
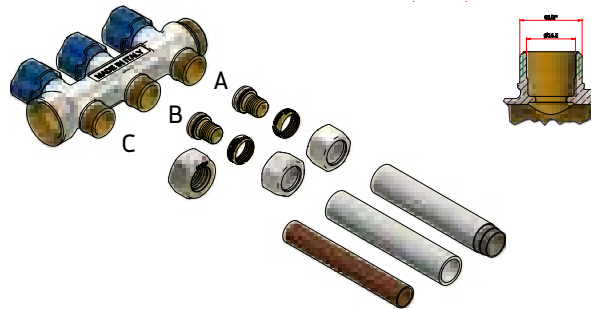

A) MPL 5703 >> p. 109

B) MP 5703 >> p. 95

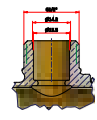
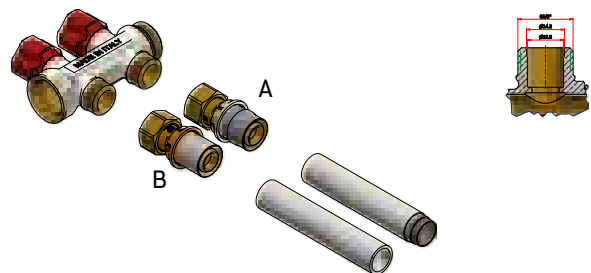

CI 350 N



- Collettore componibile serie EASY LOCK (interasse 40 mm) con valvole di intercettazione a manovra manuale, piastrina reversibile (calda/fredda) con indicazione del terminale di erogazione e attacchi inclinati a 30°.
- Modular manifold EASY LOCK series (centre-to-centre distance 40 mm) with manually operated isolation valves, reversible plate (hot/cold) showing the element connected to the corresponding outtake and 30° inclined connections.
- Collecteur à éléments série EASY LOCK (empattement 40 mm) avec des vannes d'interception à manoeuvre manuelle, plaque réversible (chaud / froid) avec indication du terminal de distribution et embouts inclinés à 30°.
- Einbauverteiler Serie EASY LOCK (Radstand 40 mm) mit Absperbareventile mit manueller Hebel, reversible Platte (warm / kalt) mit Angabe des Ausgabe-Terminal und bei 30° geneigt Anschließen.
- Colector componible serie EASY LOCK (distancia entre ejes 40 mm) con válvulas de cierre con cabeza manual, placa reversible (fría / caliente) con indicación de la terminal de dispensación y conexiones inclinadas en 30°

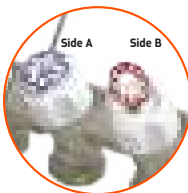

Code	Ways	Size	OC distance	Color	Price	Class	Packaging
506806N	2	3/4" x 1/2" M	40 mm	Blue or Red (reversible)	26,13 €	NG	30
506807N	3	3/4" x 1/2" M	40 mm	Blue or Red (reversible)	36,56 €	NG	25
506808N	4	3/4" x 1/2" M	40 mm	Blue or Red (reversible)	46,93 €	NG	20
506833N	5	3/4" x 1/2" M	40 mm	Blue or Red (reversible)	61,56 €	NG	15
506809N	2	3/4" x 1/2" M TP	40 mm	Blue or Red (reversible)	26,13 €	NG	30
506810N	3	3/4" x 1/2" M TP	40 mm	Blue or Red (reversible)	36,56 €	NG	25
506811N	4	3/4" x 1/2" M TP	40 mm	Blue or Red (reversible)	46,93 €	NG	20
506834N	5	3/4" x 1/2" M TP	40 mm	Blue or Red (reversible)	61,56 €	NG	15
506812N	2	3/4" x M24x1,5	40 mm	Blue or Red (reversible)	26,13 €	NG	30
506813N	3	3/4" x M24x1,5	40 mm	Blue or Red (reversible)	36,56 €	NG	25
506814N	4	3/4" x M24x1,5	40 mm	Blue or Red (reversible)	46,93 €	NG	20
506832N	5	3/4" x M24x1,5	40 mm	Blue or Red (reversible)	61,56 €	NG	15
506827N	2	1" x M24x1,5	40 mm	Blue or Red (reversible)	30,05 €	NG	30
506828N	3	1" x M24x1,5	40 mm	Blue or Red (reversible)	40,57 €	NG	25
506829N	4	1" x M24x1,5	40 mm	Blue or Red (reversible)	51,10 €	NG	20

CI 400 NBR

- Collettore componibile serie EASY LOCK (interasse 40 mm) con valvole di intercettazione a manovra manuale e piastrina reversibile (calda/fredda) con indicazione del terminale di erogazione.
- Modular manifold EASY LOCK series (centre-to-centre distance 40 mm) with manually operated isolation valves and reversible plate (hot/cold) showing the element connected to the corresponding outtake.
- Collecteur à éléments série EASY LOCK (empattement 40 mm) avec des vannes d'interception à manoeuvre manuelle et plaque réversible (chaud / froid) avec indication du terminal de distribution.
- Einbauverteiler Serie EASY LOCK (Radstand 40 mm) mit Absperbareventile mit manueller Hebel und reversibler Platte (warm / kalt) mit Angabe des Ausgabe-Terminal.
- Colector componible serie EASY LOCK (distancia entre ejes 40 mm) con válvulas de cierre con cabeza manual y placa reversible (fría / caliente) con indicación de la terminal de dispensación.

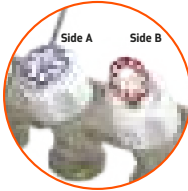

Code	Ways	Size	OC distance	Color	Price	Class	Packaging
506312NBR	2	3/4" x 1/2" M	40 mm	Blue or Red (reversible)	22,08 €	NG	55
506313NBR	3	3/4" x 1/2" M	40 mm	Blue or Red (reversible)	29,43 €	NG	35
506314NBR	4	3/4" x 1/2" M	40 mm	Blue or Red (reversible)	37,10 €	NG	28
506316NBR	2	3/4" x 1/2" M TP	40 mm	Blue or Red (reversible)	22,08 €	NG	55
506317NBR	3	3/4" x 1/2" M TP	40 mm	Blue or Red (reversible)	29,43 €	NG	35
506318NBR	4	3/4" x 1/2" M TP	40 mm	Blue or Red (reversible)	37,10 €	NG	28
506304NBR	2	3/4" x M24x1,5	40 mm	Blue or Red (reversible)	22,08 €	NG	55
506305NBR	3	3/4" x M24x1,5	40 mm	Blue or Red (reversible)	29,43 €	NG	35
506306NBR	4	3/4" x M24x1,5	40 mm	Blue or Red (reversible)	37,10 €	NG	28
506324NBR	2	1" x M24x1,5	40 mm	Blue or Red (reversible)	23,79 €	NG	35
506325NBR	3	1" x M24x1,5	40 mm	Blue or Red (reversible)	32,52 €	NG	30
506326NBR	4	1" x M24x1,5	40 mm	Blue or Red (reversible)	40,45 €	NG	20

CI 400 N

- Collettore componibile serie EASY LOCK (interasse 40 mm) con valvole di intercettazione a manovra manuale.
- Modular manifold EASY LOCK series (centre-to-centre distance 40 mm) with manually operated isolation valves.
- Collecteur à éléments série EASY LOCK (empattement 40 mm) avec des vannes d'interception à manoeuvre manuelle.
- Einbauverteiler Serie EASY LOCK (Radstand 40 mm) mit Absperbareventile mit manueller Hebel.
- Colector componible serie EASY LOCK (distancia entre ejes 40 mm) con válvulas de cierre con cabeza manual.

Code	Ways	Size	OC distance	Color	Price	Class	Packaging
506312N	2	3/4" x 1/2" M	40 mm	□	20,15 €	NG	55
506313N	3	3/4" x 1/2" M	40 mm	□	27,09 €	NG	35
506314N	4	3/4" x 1/2" M	40 mm	□	34,35 €	NG	28
506316N	2	3/4" x 1/2" M TP	40 mm	□	20,15 €	NG	55
506317N	3	3/4" x 1/2" M TP	40 mm	□	27,09 €	NG	35
506318N	4	3/4" x 1/2" M TP	40 mm	□	34,35 €	NG	28
506304N	2	3/4" x M24x1,5	40 mm	□	20,15 €	NG	55
506305N	3	3/4" x M24x1,5	40 mm	□	27,09 €	NG	35
506306N	4	3/4" x M24x1,5	40 mm	□	34,35 €	NG	28
506324N	2	1" x M24x1,5	40 mm	□	22,52 €	NG	45
506325N	3	1" x M24x1,5	40 mm	□	30,66 €	NG	30
506326N	4	1" x M24x1,5	40 mm	□	38,37 €	NG	20



- AC 655 NST >>p. 221,308,323

- Per cassette, kit di fissaggio e raccordi vedere la sezione "Accessori e raccordi per collettori sanitari".
- For cabinets, fixing kits and fittings see the "Accessories and fittings for sanitary manifolds" section.
- Pour les cassettes, les kits de fixation et les raccords, voir la section «Accessoires et raccords pour collecteurs sanitaires».
- Für Kästen, Befestigungssätzen und Verbinder beachten Sie Abschnitt „Zubehör und Verbinder für Sanitärverteiler“.
- Para cajas, kits de fijación y racores, consulte la sección "Accesorios y racores para colectores sanitarios".

■ CI 400 NB



- Collettore componibile serie EASY LOCK (interasse 40 mm) con valvole di intercettazione a manovra manuale.
- Modular manifold EASY LOCK series (centre-to-centre distance 40 mm) with manually operated isolation valves.
- Collecteur à éléments série EASY LOCK (empattement 40 mm) avec des vannes d'interception à manoeuvre manuelle.
- Einbauverteiler Serie EASY LOCK (Radstand 40 mm) mit Absperbareventile mit manueller Hebel.
- Colector componible serie EASY LOCK (distancia entre ejes 40 mm) con válvulas de cierre con cabeza manual.

Code	Ways	Size	OC distance	Color	Price	Class	Packaging
506312NB	2	3/4" x 1/2" M	40 mm	■	20,15 €	NG	55
506313NB	3	3/4" x 1/2" M	40 mm	■	27,09 €	NG	35
506314NB	4	3/4" x 1/2" M	40 mm	■	34,35 €	NG	28
506316NB	2	3/4" x 1/2" M TP	40 mm	■	20,15 €	NG	55
506317NB	3	3/4" x 1/2" M TP	40 mm	■	27,09 €	NG	35
506318NB	4	3/4" x 1/2" M TP	40 mm	■	34,35 €	NG	28
506304NB	2	3/4" x M24x1,5	40 mm	■	20,15 €	NG	55
506305NB	3	3/4" x M24x1,5	40 mm	■	27,09 €	NG	35
506306NB	4	3/4" x M24x1,5	40 mm	■	34,35 €	NG	28
506324NB	2	1" x M24x1,5	40 mm	■	22,52 €	NG	45
506325NB	3	1" x M24x1,5	40 mm	■	30,66 €	NG	30
506326NB	4	1" x M24x1,5	40 mm	■	38,37 €	NG	20

■ CI 400 NR



- Collettore componibile serie EASY LOCK (interasse 40 mm) con valvole di intercettazione a manovra manuale.
- Modular manifold EASY LOCK series (centre-to-centre distance 40 mm) with manually operated isolation valves.
- Collecteur à éléments série EASY LOCK (empattement 40 mm) avec des vannes d'interception à manoeuvre manuelle.
- Einbauverteiler Serie EASY LOCK (Radstand 40 mm) mit Absperbareventile mit manueller Hebel.
- Colector componible serie EASY LOCK (distancia entre ejes 40 mm) con válvulas de cierre con cabeza manual.

Code	Ways	Size	OC distance	Color	Price	Class	Packaging
506312NR	2	3/4" x 1/2" M	40 mm	■	20,15 €	NG	55
506313NR	3	3/4" x 1/2" M	40 mm	■	27,09 €	NG	35
506314NR	4	3/4" x 1/2" M	40 mm	■	34,35 €	NG	28
506316NR	2	3/4" x 1/2" M TP	40 mm	■	20,15 €	NG	55
506317NR	3	3/4" x 1/2" M TP	40 mm	■	27,09 €	NG	35
506318NR	4	3/4" x 1/2" M TP	40 mm	■	34,35 €	NG	28
506304NR	2	3/4" x M24x1,5	40 mm	■	20,15 €	NG	55
506305NR	3	3/4" x M24x1,5	40 mm	■	27,09 €	NG	35
506306NR	4	3/4" x M24x1,5	40 mm	■	34,35 €	NG	28
506324NR	2	1" x M24x1,5	40 mm	■	22,52 €	NG	45
506325NR	3	1" x M24x1,5	40 mm	■	30,66 €	NG	30
506326NR	4	1" x M24x1,5	40 mm	■	38,37 €	NG	20



• AC 655 NST >>p. 221,308,323

- Per cassette, kit di fissaggio e raccordi vedere la sezione "Accessori e raccordi per collettori sanitari".
- For cabinets, fixing kits and fittings see the "Accessories and fittings for sanitary manifolds" section.
- Pour les cassettes, les kits de fixation et les raccords, voir la section «Accessoires et raccords pour collecteurs sanitaires».
- Für Kästen, Befestigungssätzen und Verbinder beachten Sie Abschnitt „Zubehör und Verbinder für Sanitärverteiler“.
- Para cajas, kits de fijación y racores, consulte la sección "Accesorios y racores para colectores sanitarios".

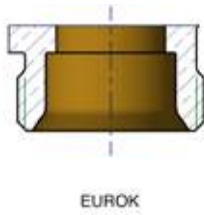
EASY-LOCK manifolds (CS 200 N) with EUROK and 1/2" F connections and suitable fittings

- A) MPL 5705 >> p. 109
- B) MP 5705 >> p. 95
- C) TR 4430 >> p. 126
- D) TP 4410 >> p. 124
- E) TA 4420 >> p. 123

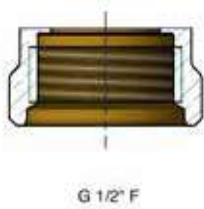
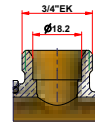
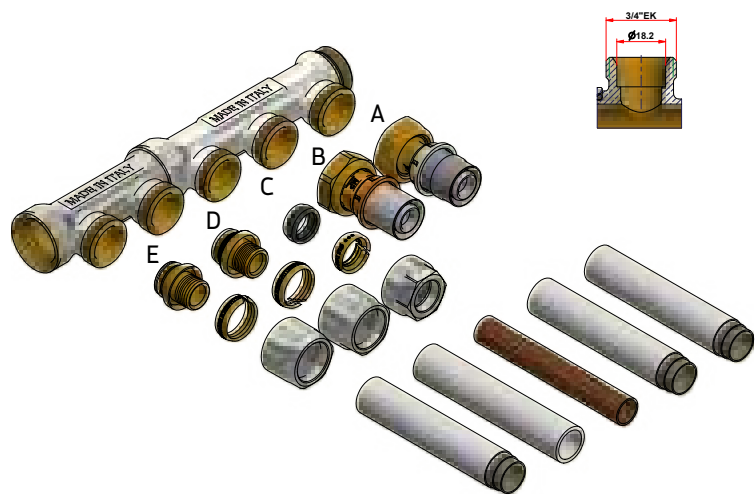

- A) MP 5609 >> p. 90
- B) MPL 5609 >> p. 109

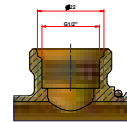
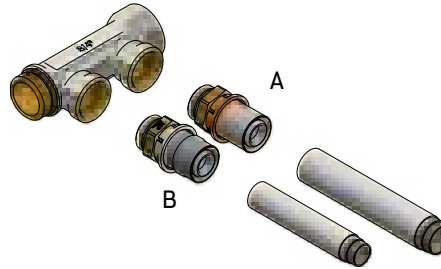
CS 200 N

- Collettore componibile semplice serie EASY LOCK (interasse 40 mm).
- Modular plain manifold EASY LOCK series (centre-to-centre distance 40 mm).
- Collecteur simple à éléments série EASY LOCK (empattement 40 mm).
- Einbauverteiler Serie EASY LOCK (Radstand 40 mm).
- Colector componible simple serie EASY LOCK (distancia entre ejes 40 mm).

Code	Ways	Size	OC distance	Price	Class	Packaging
501705N	2	3/4" x EUROK	40 mm	13,18 €	NG	80
501707N	3	3/4" x EUROK	40 mm	15,85 €	NG	54
501709N	4	3/4" x EUROK	40 mm	20,44 €	NG	40
501701N	2	3/4" x 1/2" F	40 mm	13,18 €	NG	80
501702N	3	3/4" x 1/2" F	40 mm	15,85 €	NG	54
501703N	4	3/4" x 1/2" F	40 mm	20,44 €	NG	40
501685N	2	1" x EUROK	40 mm	14,93 €	NG	70
501687N	3	1" x EUROK	40 mm	18,55 €	NG	50
501689N	4	1" x EUROK	40 mm	23,67 €	NG	30
501681N	2	1" x 1/2" F	40 mm	14,93 €	NG	70
501682N	3	1" x 1/2" F	40 mm	18,55 €	NG	50
501683N	4	1" x 1/2" F	40 mm	23,67 €	NG	30

MANIFOLD DIMENSIONS (Octagonal section) ○

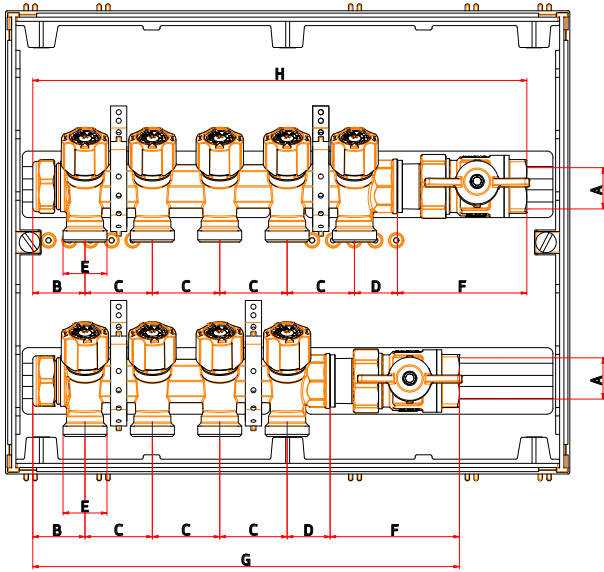

A	B	C	D	E	F	G	H
G 3/4" F	32 mm	40 mm	25,5 mm	EUROK	77 mm	254,5 mm	294,5 mm
G 1" F	34,5 mm	40 mm	25,5 mm	EUROK	80 mm	260 mm	300 mm

MANIFOLD DIMENSIONS (Octagonal section) ○

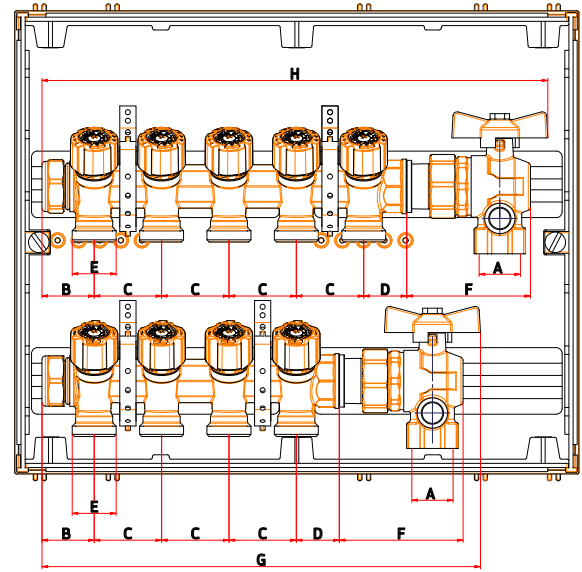

A	B	C	D	E	F	G	H
G 3/4" F	32 mm	40 mm	25,5 mm	EUROK	73,5 mm	261,5 mm	301,5 mm
G 1" F	34,5 mm	40 mm	25,5 mm	EUROK	93 mm	272,5 mm	312,5 mm

MANIFOLD DIMENSIONS (Round section) ○

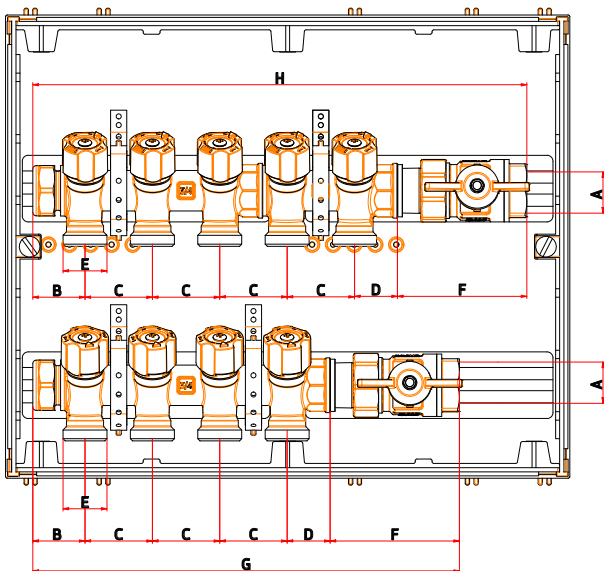

A	B	C	D	E	F	G	H
G 3/4" F	32 mm	40 mm	25,5 mm	EUROK* 1/2" F* 1/2" M 1/2" M TP M24x1,5	77 mm	254,5 mm	294,5 mm
G 1" F	34,5 mm	40 mm	25,5 mm	EUROK* 1/2" F* M24x1,5	80 mm	260 mm	300 mm

*CS 200 N only

MANIFOLD DIMENSIONS (Round section) ○

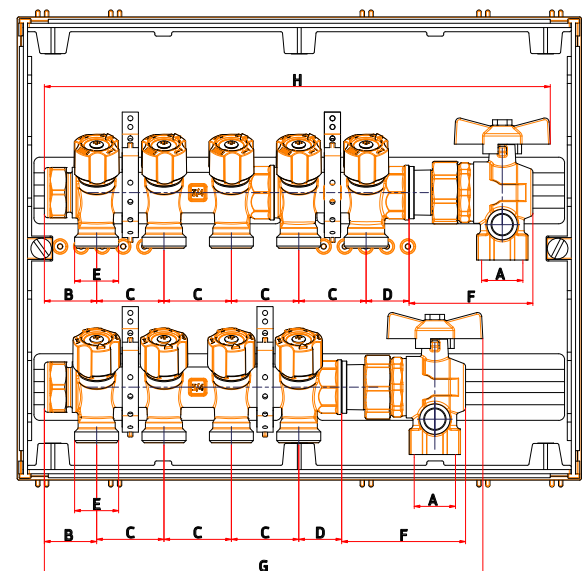

A	B	C	D	E	F	G	H
G 3/4" F	32 mm	40 mm	25,5 mm	EUROK* 1/2" F* 1/2" M 1/2" M TP M24x1,5	73,5 mm	261,5 mm	301,5 mm
G 1" F	34,5 mm	40 mm	25,5 mm	EUROK* 1/2" F* M24x1,5	93 mm	272,5 mm	312,5 mm

*CS 200 N only

BASIC SERIES MANIFOLDS

The manifolds in the BASIC range feature the option for practical and simple interconnection with one another. Thanks to the offset design of the threads, BASIC manifolds remain aligned and the action of an O-ring ensures perfect sealing efficiency. This means that it is prohibited to use sealing systems such as hemp or PTFE, or to use additional sealants. When shut-off valves or caps are fitted to the BASIC series manifolds, the best solution is always to use IVAR components with the same sealing technology – soft seal with o-ring.

If it is necessary to make a connection to a threaded component without soft seal technology, the use of hemp is still prohibited; it is recommended instead to use PTFE tape or a thread sealing cord (e.g. Loctite® 55), of which the appropriate quantity should be used, applying a **maximum tightening torque of between 15 and 20 Nm** with a tool.

The manifolds are nickel plated on the exterior only, and therefore remain yellow on the inside, ensuring conformity for conveying drinking water.

Available in 3/4" size, as well as branches with external thread of 1/2" or M24x1.5, and 2, 3 or 4 outlets.

In addition to the simple manifold, there are models with ways that can be shut off independently, offered with 30° angled valves to facilitate control of operations. The valve knobs can be fitted with a red or blue cap (both included on models CI 370 NT) or a reversible red/blue tab to indicate the connected terminal (supplied with models CI 370 N).

Materials

Brass parts: CW617N nickel-plated on exterior only

Sealing elements: peroxide EPDM

Technical specifications

Max. fluid temp. inside manifold: 120 °C (series CS 368 N);

100 °C (series CI 370 N / CI 370 NT)

Maximum operating pressure: 10 bar

Outlet interaxis: 35 mm

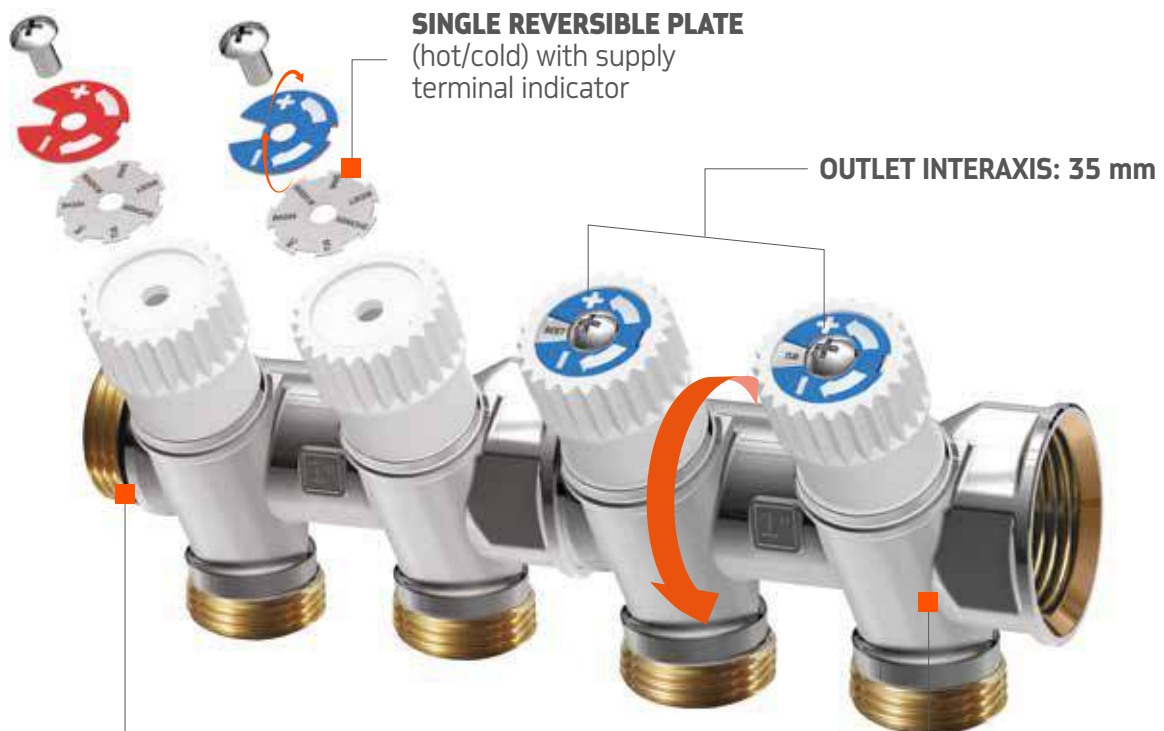

O-RING FOR SOFT SEAL:
no additional sealant such as hemp or Teflon required.

AUTOMATIC ALIGNMENT BY HAND THANKS TO OFFSET THREADS. NO tightening tool is required.



BASIC series manifolds with 1/2" M and M24x1,5 connections and suitable fittings

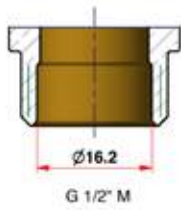

- A) TA 420 P >> p. 428
- B) TP 410 P >> p. 428
- C) TR 430 P >> p. 429

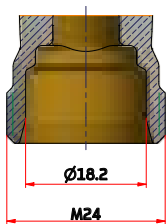
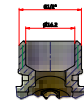
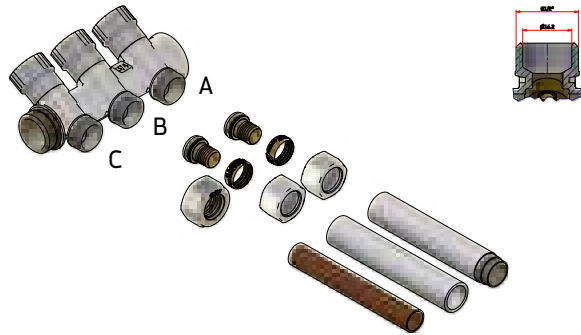

- A) TA 420 >> p. 428
- B) TP 410 >> p. 428
- C) TR 430 >> p. 429

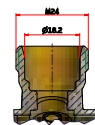
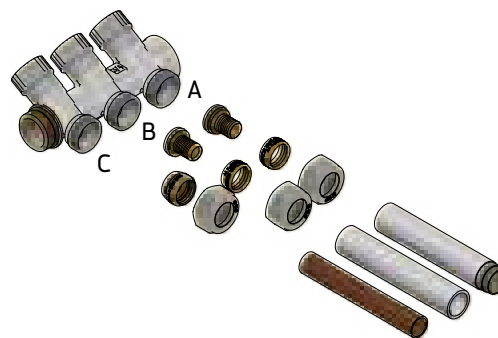

MANIFOLDS DIMENSIONS

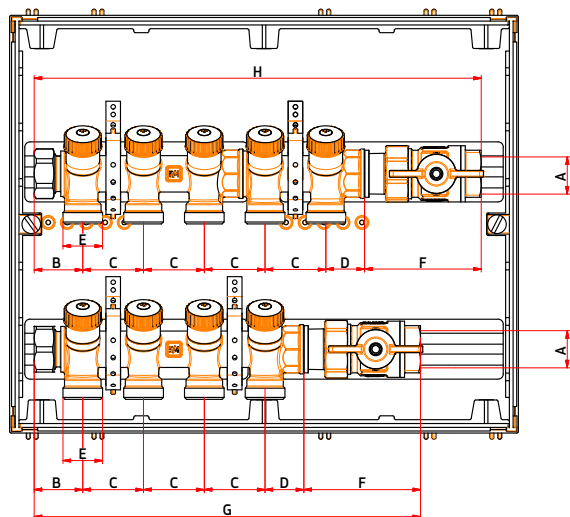

A	B	C	D	E	F	G	H
G 3/4" F	29,5 mm	35 mm	23 mm	1/2" M M24x1,5	77 mm	234,5 mm	269,5 mm

MANIFOLDS DIMENSIONS

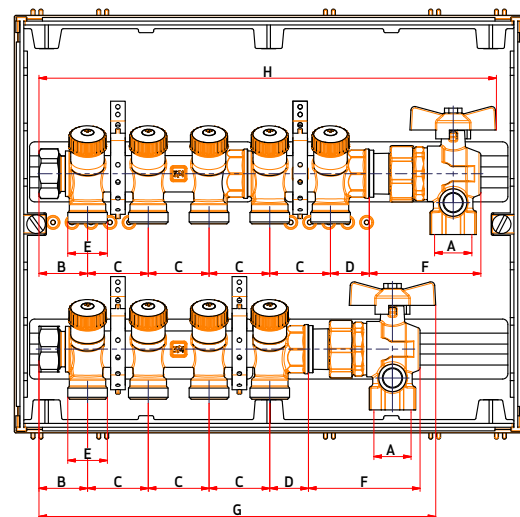

A	B	C	D	E	F	G	H
G 3/4" F	29,5 mm	35 mm	23 mm	1/2" M M24x1,5	73,5 mm	231 mm	266 mm

CI 370 N

- Collettore componibile serie BASIC (interasse 35 mm) con valvole di intercettazione a manovra manuale, piastrina reversibile (calda/fredda) con indicazione del terminale di erogazione e attacchi inclinati a 30 °.
- Modular manifold BASIC series (centre-to-centre distance 35 mm) with manually operated isolation valves, reversible plate (hot/cold) showing the element connected to the corresponding outtake and 30 ° inclined connections.
- Collecteur à éléments série BASIC (empattement 35 mm) avec des vannes d'interception à manoeuvre manuelle, plaque réversible (chaud / froid) avec indication du terminal de distribution et embouts inclinés à 30 °.
- Einbauverteiler Serie BASIC (Radstand 35 mm) mit Absperbareventile mit manueller Hebel, reversible Platte (warm / kalt) mit Angabe des Ausgabe-Terminal und bei 30 ° geneigt Anschließen.
- Colector componible serie BASIC (distancia entre ejes 35 mm) con válvulas de cierre con cabeza manual, placa reversible (fría / caliente) con indicación de la terminal de dispensación y conexiones inclinadas en 30 °.

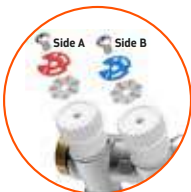

Code	Ways	Size	OC distance	Color	Price	Class	Packaging
506838N	2	3/4" x 1/2" M	35 mm	Blue or Red (reversible)	20,85 €	NG	30
506839N	3	3/4" x 1/2" M	35 mm	Blue or Red (reversible)	30,43 €	NG	25
506840N	4	3/4" x 1/2" M	35 mm	Blue or Red (reversible)	39,56 €	NG	20
506835N	2	3/4" x M24x1,5	35 mm	Blue or Red (reversible)	20,85 €	NG	30
506836N	3	3/4" x M24x1,5	35 mm	Blue or Red (reversible)	30,43 €	NG	25
506837N	4	3/4" x M24x1,5	35 mm	Blue or Red (reversible)	39,56 €	NG	20

CI 370 NT

- Collettore componibile serie BASIC (interasse 35 mm) con valvole di intercettazione a manovra manuale e attacchi inclinati a 30 °, senza indicazione del terminale di erogazione.
- Modular manifold BASIC series (centre-to-centre distance 35 mm) with manually operated isolation valves and 30 ° inclined connections, without indication of the element connected to the corresponding outtake.
- Collecteur à éléments série BASIC (empattement 35 mm) avec des vannes d'interception à manoeuvre manuelle et embouts inclinés à 30 °, sans indication du terminal de distribution.
- Einbauverteiler Serie BASIC (Radstand 35 mm) mit Absperbareventile mit manueller Hebel und bei 30 ° geneigt Anschließen, ohne Angabe des Ausgabe-Terminal.
- Colector componible serie BASIC (distancia entre ejes 35 mm) con válvulas de cierre con cabeza manual y conexiones inclinadas en 30 °, sin indicación de la terminal de dispensación.

Code	Ways	Size	OC distance	Color	Price	Class	Packaging
506838NT	2	3/4" x 1/2" M	35 mm	Blue or Red	20,06 €	NG	30
506839NT	3	3/4" x 1/2" M	35 mm	Blue or Red	29,64 €	NG	25
506840NT	4	3/4" x 1/2" M	35 mm	Blue or Red	37,90 €	NG	20
506835NT	2	3/4" x M24x1,5	35 mm	Blue or Red	20,06 €	NG	30
506836NT	3	3/4" x M24x1,5	35 mm	Blue or Red	29,64 €	NG	25
506837NT	4	3/4" x M24x1,5	35 mm	Blue or Red	37,90 €	NG	20

CS 368 N

- Collettore componibile semplice serie BASIC (interasse 35 mm).
- Modular plain manifold BASIC series (centre-to-centre distance 35 mm).
- Collecteur simple à éléments série BASIC (empattement 35 mm).
- Einbauverteiler Serie BASIC (Radstand 35 mm).
- Colector componible simple serie BASIC (distancia entre ejes 35 mm).

Code	Ways	Size	OC distance	Price	Class	Packaging
506850N	2	3/4" x 1/2" M	35 mm	10,18 €	NG	80
506851N	3	3/4" x 1/2" M	35 mm	13,18 €	NG	54
506852N	4	3/4" x 1/2" M	35 mm	16,96 €	NG	40
506847N	2	3/4" x M24x1,5	35 mm	10,18 €	NG	80
506848N	3	3/4" x M24x1,5	35 mm	13,18 €	NG	54
506849N	4	3/4" x M24x1,5	35 mm	16,96 €	NG	40



- AC 655 NST >>p. 221,308,323

- Per cassette, kit di fissaggio e raccordi vedere la sezione "Accessori e raccordi per collettori sanitari".
- For cabinets, fixing kits and fittings see the "Accessories and fittings for sanitary manifolds" section.
- Pour les cassettes, les kits de fixation et les raccords, voir la section «Accessoires et raccords pour collecteurs sanitaires».
- Für Kästen, Befestigungssätzen und Verbinder beachten Sie Abschnitt „Zubehör und Verbinder für Sanitärverteiler“.
- Para cajas, kits de fijación y racores, consulte la sección "Accesorios y racores para colectores sanitarios".

ACCESSORIES FOR SANITARY MANIFOLDS

AC 850



- Cassetta in plastica con fondo e kit di fissaggio per collettori coplanari e componibili.
- Plastic cabinet with bottom and fastening kit for coplanar and modular manifolds.
- Casette en plastique avec fond et kit de fixation pour collecteurs coplanaires et à éléments.
- Unterputz Verteilerschrank aus Kunststoff mit Boden und Fixierung-kit für koplanare und Einbau-Verteiler.
- Caja de plástico con fondo y kit de montaje para colectores coplanares y componibles.

Code	Height	Width	Depth	Price	Class	Packaging
SAM-032	260 mm	320 mm	95 mm	33,01 €	NW	20
SAM-040	260 mm	400 mm	95 mm	36,49 €	NW	20
SAM-050	260 mm	500 mm	95 mm	40,53 €	NW	10
SAM-060	260 mm	600 mm	95 mm	46,32 €	NW	10

AC 851



- Kit di fissaggio per collettori coplanari e componibili in cassetta di plastica tipo AC 850.
- Kit for coplanar and modular manifolds fastening in plastic cabinet AC 850.
- Kit de fixation pour collecteurs coplanaires et à éléments dans la cassette en plastique AC 850.
- Fixierung-kit für koplanare und Einbau-Verteiler in Unterputz Verteilerschrank aus Kunststoff AC 850.
- Kit de montaje para colectores coplanares y componibles en caja de plástico tipo AC 850.

Code	Manifolds type	Price	Class	Packaging
SAM-001	EASY•RADIANT / EASY•LOCK / BASIC series	14,77 €	NW	1

AC 852



- Cassetta in plastica con fondo per collettori componibili e coplanari (senza kit di fissaggio, da ordinare separatamente).
- Plastic cabinet with bottom for modular and coplanar manifolds (without fastening kit, to be ordered separately).
- Casette en plastique avec fond pour collecteurs à éléments et coplanaires (sans kit de fixation, à commander séparément).
- Unterputz Verteilerschrank aus Kunststoff mit Boden für Einbau- und koplanare Verteiler (ohne Fixierung-kit, bitte bestellen getrennt).
- Caja de plástico con fondo para colectores componibles y coplanares (sin kit de montaje, para pedir separatamente).

Code	Height	Width	Depth	Price	Class	Packaging
SAM-135	350 mm	350 mm	90 mm	42,92 €	NW	1
SAM-150	350 mm	500 mm	90 mm	54,34 €	NW	1
SAM-165	350 mm	650 mm	90 mm	71,83 €	NW	1
SAM-180	400 mm	800 mm	95 mm	97,87 €	NW	1

AC 853



- Kit di fissaggio per collettori coplanari e componibili in cassetta di plastica tipo AC 852.
- Kit for coplanar and modular manifolds fastening in plastic cabinet AC 852.
- Kit de fixation pour collecteurs coplanaires et à éléments dans la cassette en plastique AC 852.
- Fixierung-kit für koplanare und Einbau-Verteiler in Unterputz Verteilerschrank aus Kunststoff AC 852.
- Kit de montaje para colectores coplanares y componibles en caja de plástico de tipo AC 852.

Code	Manifolds type	Price	Class	Packaging
SAM-010	EASY•RADIANT / EASY•LOCK / BASIC series	8,09 €	NW	1

AC 628

- Staffa doppia per collettori componibili serie EASY-LOCK / BASIC / EASY-RADIANT.
- Double bracket for modular manifolds EASY-LOCK / BASIC / EASY-RADIANT series.
- Étrier double pour collecteurs à éléments de la série EASY-LOCK / BASIC / EASY-RADIANT.
- Doppelt Wandalterung für Einbauverteiler der Serie EASY-LOCK / BASIC / EASY-RADIANT.
- Soporte doble para colectores componibles de la serie EASY-LOCK / BASIC / EASY-RADIANT.

Code	OC distance	Depth	Manifolds type	Price	Class	Packaging
501160P80	200 mm	80 mm	3/4" (EASY-LOCK / BASIC series)	7,54 €	NJ	2 / 40
501160	200 mm	95 mm	3/4" (EASY-LOCK / BASIC series)	7,54 €	NJ	2 / 40
501632	200 mm	80 mm	1" (EASY-LOCK / BASIC / EASY-RADIANT series)	8,07 €	NJ	2 / 70
501639	200 mm	95 mm	1" (EASY-LOCK / BASIC / EASY-RADIANT series)	7,54 €	NJ	2 / 70

AC 639

- Staffa singola per collettori componibili serie EASY-LOCK / BASIC.
- Single bracket for modular manifolds EASY-LOCK / BASIC series.
- Étrier simple pour collecteurs à éléments de la série EASY-LOCK / BASIC.
- Einzel Wandalterung für Einbauverteiler der Serie EASY-LOCK / BASIC.
- Soporte simple para colectores componibles de la serie EASY-LOCK / BASIC.

Code	Manifolds type	Price	Class	Packaging
502061	3/4" (EASY-LOCK / BASIC series)	3,978 €	NJ	2 / 150
501645	1" (EASY-LOCK / BASIC series)	3,978 €	NJ	2 / 150

AC 649

- Staffa singola per collettori componibili serie EASY-LOCK / BASIC.
- Single bracket for modular manifolds EASY-LOCK / BASIC series.
- Étrier simple pour collecteurs à éléments de la série EASY-LOCK / BASIC.
- Einzel Wandalterung für Einbauverteiler der Serie EASY-LOCK / BASIC.
- Soporte simple para colectores componibles de la serie EASY-LOCK / BASIC.

Code	Manifolds type	Price	Class	Packaging
501641	3/4" (EASY-LOCK / BASIC series)	4,497 €	NJ	2 / 70
501643	1" (EASY-LOCK / BASIC series)	4,497 €	NJ	2 / 70

MCC 04 B

- Manopola per collettori componibili EASY LOCK con valvole di intercettazione a manovra manuale.
- Hand wheel for modular manifolds EASY LOCK series with manually operated isolation valves.
- Poignée pour collecteurs à éléments série EASY LOCK avec des vannes d'interception à manoeuvre manuelle.
- Griff für Einbauverteiler Serie EASY LOCK mit Absperbarenventile mit manueller Hebel.
- Mando para colectores componibles serie EASY LOCK con válvulas de cierre con cabeza manual.

Code	Manifolds type	Color	Price	Class	Packaging
507351B	CI 490 NB - CI 400 NB		1,713 €	NG	50 / 400

MCC 04 R

- Manopola per collettori componibili EASY LOCK con valvole di intercettazione a manovra manuale.
- Hand wheel for modular manifolds EASY LOCK series with manually operated isolation valves.
- Poignée pour collecteurs à éléments série EASY LOCK avec des vannes d'interception à manoeuvre manuelle.
- Griff für Einbauverteiler Serie EASY LOCK mit Absperbarenventile mit manueller Hebel.
- Mando para colectores componibles serie EASY LOCK con válvulas de cierre con cabeza manual.

Code	Manifolds type	Color	Price	Class	Packaging
507351R	CI 490 NR - CI 400 NR		1,713 €	NG	50 / 400

MCC 04 W

- Manopola per collettori componibili EASY LOCK con valvole di intercettazione a manovra manuale.
- Hand wheel for modular manifolds EASY LOCK series with manually operated isolation valves.
- Poignée pour collecteurs à éléments série EASY LOCK avec des vannes d'interception à manoeuvre manuelle.
- Griff für Einbauverteiler Serie EASY LOCK mit Absperbarenventile mit manueller Hebel.
- Mando para colectores componibles serie EASY LOCK con válvulas de cierre con cabeza manual.

Code	Manifolds type	Color	Price	Class	Packaging
507351W	CI 400 N - CI 490 NW		1,713 €	NG	50 / 400

MCC 05

- Manopola reversibile per collettori componibili serie EASY LOCK con valvole di intercettazione a manovra manuale.
- Reversible hand wheel for modular manifolds EASY LOCK series with manually operated isolation valves.
- Poignée réversible pour collecteurs à éléments série EASY LOCK avec des vannes d'interception à manoeuvre manuelle.
- Reversibelgriff für Einbauverteiler Serie EASY LOCK mit Absperbarenventile mit manueller Hebel.
- Mando reversibile para colectores componibles serie EASY LOCK con válvulas de cierre con cabeza manual.

Code	Manifolds type	Color	Price	Class	Packaging
507139	CI 490 N - CI 390 N - CI 400 NBR - CI 350 N	or (reversible)	5,65 €	NG	20 / 80

■ TA 4420



- Raccordo EUROK per tubo multistrato e in polietilene.
- EUROK fitting for multilayer and polyethylene pipe.
- Raccord EUROK pour tube multicouches et en polyéthylène.
- EUROK-Verschraubung für Verbund- und für Polyäthylen-Rohr.
- Conexión EUROK para tubo multicapa y de polietileno.

Code	Size	Color	Price	Class	Packaging
506061	EUROK x 12/1,8	■	3,893 €	JA	40 / 320
500683	EUROK x 14/2	■	3,893 €	JA	40 / 320
500400	EUROK x 15/1,5	■	4,012 €	JA	40 / 320
500684	EUROK x 16/2	■	3,893 €	JA	40 / 320
500579	EUROK x 16/2,25	■	3,893 €	JA	40 / 320
506040	EUROK x 16,2/2,6	■	3,893 €	JA	40 / 320
500012	EUROK x 17/2	■	4,169 €	JA	40 / 320
500685	EUROK x 18/2	■	4,169 €	JA	40 / 320
500754	EUROK x 18/2,5	■	4,169 €	JA	40 / 320
500914	EUROK x 20/2	■	4,348 €	JA	40 / 320
500009	EUROK x 20/2,25	■	4,575 €	JA	40 / 320
501010	EUROK x 20/2,5	■	4,348 €	JA	40 / 320
506295	EUROK x 20/2,9	■	5,94 €	JA	40 / 320



FOCUS: Fittings for multilayer and PEX pipe

See page 122.

■ TP 4410



- Raccordo EUROK per tubo in polietilene.
- EUROK fitting for polyethylene pipe.
- Raccord EUROK pour tube en polyéthylène.
- EUROK-Verschraubung für Polyäthylen-Rohr.
- Conexión EUROK para tubo de polietileno.

Code	Size	Color	Price	Class	Packaging
500590	EUROK x 12/1	■	3,673 €	JA	40 / 320
520041	EUROK x 12/2	■	3,673 €	JA	40 / 320
500679	EUROK x 14/2	■	3,593 €	JA	40 / 320
500148	EUROK x 15/1,7	■	3,893 €	JA	40 / 320
500769	EUROK x 15/2,5	■	3,737 €	JA	40 / 320
500591	EUROK x 16/1,5	■	3,51 €	JA	40 / 320
500680	EUROK x 16/2	■	3,51 €	JA	40 / 320
500681	EUROK x 16/2,2	■	3,51 €	JA	40 / 320
500682	EUROK x 17/2	■	3,737 €	JA	40 / 320
500145	EUROK x 18/1,8	■	3,737 €	JA	40 / 320
500650	EUROK x 18/2	■	4,169 €	JA	40 / 320
506020	EUROK x 18/2,5	■	3,737 €	JA	40 / 320
500651	EUROK x 20/2	■	4,169 €	JA	40 / 320
500649	EUROK x 20/2,8	■	4,025 €	JA	40 / 320
506200	EUROK x 20/3,4	■	4,025 €	JA	40 / 320
500753	EUROK x 21/2,5	■	4,528 €	JA	40 / 320

■ TA 420



- Raccordo M24 per tubo multistrato e in polietilene.
- M24 fitting for multilayer and polyethylene pipe.
- Raccord M24 pour tube multicouches et en polyéthylène.
- M24-Verschraubung für Verbund- und für Polyäthylen-Rohr.
- Conexión M24 para tubo multicapa y de polietileno.

Code	Size	Color	Price	Class	Packaging
501040	M24x1,5 x 14/2	■	3,221 €	JA	50 / 400
501028	M24x1,5 x 16/2	■	3,138 €	JA	50 / 400
501025	M24x1,5 x 16/2,2	■	3,221 €	JA	50 / 400
500049	M24x1,5 x 17/2,3	■	3,318 €	JA	50 / 400
501027	M24x1,5 x 18/2	■	3,318 €	JA	50 / 400
506215	M24x1,5 x 20/2	■	4,935 €	JA	40 / 320

■ TA 420 P



- Raccordo 1/2" F per tubo multistrato e in polietilene.
- 1/2" F fitting for multilayer and polyethylene pipe.
- Raccord 1/2" F pour tube multicouches et en polyéthylène.
- Verschraubung 1/2" IG für Verbund- und für Polyäthylen-Rohr.
- Conexión 1/2" F para tubo multicapa y de polietileno.

Code	Size	Color	Price	Class	Packaging
506265	1/2" F x 14/2	■	3,138 €	JA	50 / 400
500759	1/2" F x 16/2	■	3,138 €	JA	40 / 320
506267	1/2" F x 16/2,25	■	3,138 €	JA	50 / 400

■ TP 410



- Raccordo M24 per tubo in polietilene.
- M24 fitting for polyethylene pipe.
- Raccord M24 pour tube en polyéthylène.
- M24-Verschraubung für Polyäthylen-Rohr.
- Conexión M24 para tubo de polietileno.

Code	Size	Color	Price	Class	Packaging
501056	M24x1,5 x 12/1	■	3,21 €	JA	50 / 400
501032	M24x1,5 x 14/2	■	3,078 €	JA	50 / 400
501022	M24x1,5 x 16/1,5	■	3,051 €	JA	50 / 400
501034	M24x1,5 x 16/2	■	2,911 €	JA	50 / 400
501035	M24x1,5 x 16/2,2	■	2,911 €	JA	50 / 400
501048	M24x1,5 x 17/2	■	3,051 €	JA	50 / 400
501037	M24x1,5 x 18/2	■	3,318 €	JA	50 / 400

■ TP 410 P



- Raccordo 1/2" F per tubo in polietilene.
- 1/2" F fitting for polyethylene pipe.
- Raccord 1/2" F pour tube en polyéthylène.
- Verschraubung 1/2" IG für Polyäthylen-Rohr.
- Conexión 1/2" F para tubo de polietileno.

Code	Size	Color	Price	Class	Packaging
506268	1/2" F x 12/1,1	■	3,138 €	JA	50 / 400
506269	1/2" F x 12/2	■	3,138 €	JA	50 / 400
506272	1/2" F x 15/2,5	■	3,138 €	JA	50 / 400
506273	1/2" F x 16/1,5	■	3,138 €	JA	50 / 400
506275	1/2" F x 16/2,2	■	3,138 €	JA	50 / 400

TR 4430

- Raccordo EUROK per tubo rame ed acciaio dolce.
- EUROK fitting for copper and mild steel pipe.
- Raccord EUROK pour tube en cuivre et en acier doux.
- EUROK-Verschraubung für Kupferrohre und Weichstahlrohre.
- Conexión EUROK para tubo de cobre y acero dulce.

Code	Size	Color	Price	Class	Packaging
500998	EUROK x 10/1	■	3,282 €	JA	40 / 320
500157	EUROK x 12/1	■	2,712 €	JA	40 / 320
500024	EUROK x 14/1	■	2,671 €	JA	40 / 320
500025	EUROK x 15/1	■	2,671 €	JA	40 / 320
500026	EUROK x 16/1	■	2,671 €	JA	40 / 320

TR 4430-18

- Raccordo EUROK per tubo rame ed acciaio dolce.
- EUROK fitting for copper and mild steel pipe.
- Raccord EUROK pour tube en cuivre et en acier doux.
- EUROK-Verschraubung für Kupferrohre und Weichstahlrohre.
- Conexión EUROK para tubo de cobre y acero dulce.

Code	Size	Color	Price	Class	Packaging
500417	EUROK x 18/1	■	4,30 €	JA	40 / 320

AC 601 K

- Kit tappo femmina con adattatore per tenuta piatta.
- Female plug kit with adaptor for flat seal.
- Kit bouchon femelle avec adaptateur pour tenue plate.
- Verschluss Set mit Innengewinde und Flachdichtung Adapter.
- Kit tapón hembra con adaptador para junta plana.

Code	Size	Accessories	Color	Price	Class	Packaging
506206	EUROK	2 gaskets	■	3,939 €	NJ	50 / 400
506206N	EUROK	2 gaskets	■	4,07 €	NJ	50 / 400

TR 430

- Raccordo M24 per tubo rame ed acciaio dolce.
- M24 fitting for copper and mild steel pipe.
- Raccord M24 pour tube en cuivre et en acier doux.
- M24-Verschraubung für Kupferrohre und Weichstahlrohre.
- Conexión M24 para tubo de cobre y acero dulce.

Code	Size	Color	Price	Class	Packaging
500938	M24x1,5 x 10/1	■	3,007 €	JA	50 / 400
500141	M24x1,5 x 12/1	■	2,599 €	JA	50 / 400
500014	M24x1,5 x 14/1	■	2,479 €	JA	50 / 400
500007	M24x1,5 x 15/1	■	2,479 €	JA	50 / 400
500016	M24x1,5 x 16/1	■	2,479 €	JA	50 / 400

TR 430 P

- Raccordo 1/2" F a stringere per tubo rame ed acciaio dolce con bussola in NBR.
- 1/2" F fitting for copper and mild steel pipe with NBR bushing.
- Raccord 1/2" F pour tube en cuivre et en acier doux avec douille en NBR.
- Verschraubung 1/2" IG für Kupferrohre und Weichstahlrohre mit Hülsen aus NBR.
- Conexión 1/2" F para tubo de cobre y acero dulce con buje en NBR.

Code	Size	Color	Price	Class	Packaging
506260	1/2" F x 10/1	■	2,659 €	JA	50 / 400
506261	1/2" F x 12/1	■	2,659 €	JA	50 / 400
506262	1/2" F x 14/1	■	2,659 €	JA	50 / 400
506263	1/2" F x 15/1	■	2,935 €	JA	50 / 400
506264	1/2" F x 16/1	■	2,935 €	JA	50 / 400

AC 601



- Tappo femmina.
- Female plug.
- Bouchon femelle.
- IG Verschluss.
- Tapón hembra.

Code	Size	Accessories	Color	Price	Class	Packaging
550016	1/2"	1 gasket	■	2,159 €	NJ	50 / 400
500022	3/4"	2 gaskets	■	2,397 €	NJ	100 / 400
500625	1"	1 gasket	■	4,141 €	NJ	35 / 280
550016N	1/2"	1 gasket	■	2,159 €	NJ	50 / 400
550090	3/4"	2 gaskets	■	2,48 €	NJ	100 / 400
500625N	1"	1 gasket	■	4,284 €	NJ	35 / 280
550089	M24x1,5	1 gasket	■	2,48 €	NJ	100 / 800

RTV is an automatic proportional valve with thermostatic insert which controls the return temperature in the circulation circuits, using an injection system to limit flow rates along the pipelines and therefore also heat dispersion. In this way the maximum comfort is ensured for system users, who will always have hot water at the right temperature. The thermostat controller, installed on all circuit branches, automatically keeps the system temperature constant and ensures balancing when required.

⊕ PLUS

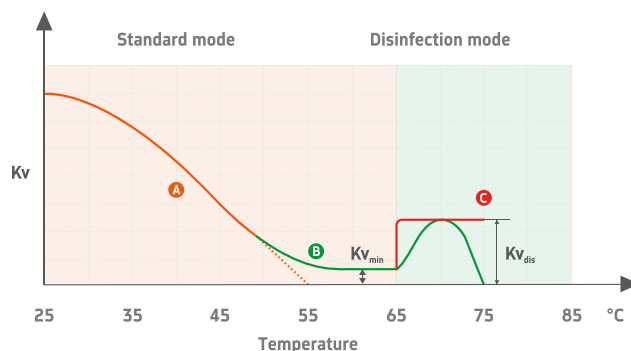
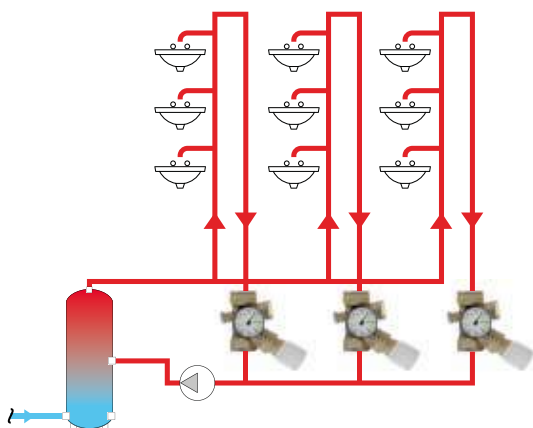
- Wide temperature regulation range 35 °C – 60 °C
- Reduction of heat dispersion thanks to limitation of maximum flow rate in circuit branches.
- Available in sizes DN 15-20 with 1/2" F - 3/4" F connections in the 3 variants A - B - C
- An anti-legionella cycle with mechanical or electronically controlled bypass can also be included



Segment A on the graph indicates the decrease of the Kv (therefore the flow rate) as the temperature of the recirculating water increases.

Segment B (up to 65°C) shows the minimum recirculation flow rate, which is always present.

Finally, between 65 - 75°C there is the disinfection zone (anti-legionella treatment) with mechanical (green line) or automatic (red line) activation.

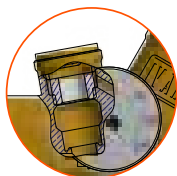

A

Temperature control only

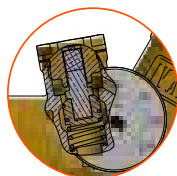

B

Temperature control and
mechanical bypass for
heat disinfection

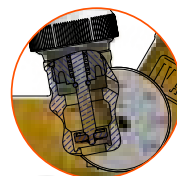

C

Temperature control and
electronic bypass management
for heat disinfection

RTV A

- Valvola termostatica per il controllo della temperatura dei rami di ricircolo sanitario, con/senza coibentazione termica.
- Thermostatic valve for temperature control of sanitary recirculation circuits, with/without thermal insulation.
- Robinet thermostatique pour le contrôle de la température des circuits de recirculation sanitaire, avec/sans isolation thermique.
- Thermostatventil für die Temperaturregelung der Brauchwasserrückführungskreisläufe, mit/ohne Wärmedämmung.
- Válvula termostática para el control de la temperatura de los circuitos de recirculación de agua doméstica, con/sin aislamiento térmico.

Code	Size	Range	Insulation	Price	Class	Packaging
506187	1/2" F	35 – 60 °C	-	131,77 €	OE	1 / 22
507036	3/4" F	35 – 60 °C	-	131,77 €	OE	1 / 22
506187I	1/2" F	35 – 60 °C	✓	148,98 €	OE	1 / 12
507036I	3/4" F	35 – 60 °C	✓	148,98 €	OE	1 / 12

RTV B

- Valvola termostatica per il controllo della temperatura dei rami di ricircolo sanitario con bypass meccanico per la disinfezione termica degli impianti idrosanitari, con/senza coibentazione termica.
- Thermostatic valve for temperature control of sanitary recirculation circuits with mechanical bypass for thermal disinfection of sanitary systems, with/without thermal insulation.
- Robinet thermostatique pour le contrôle de la température des circuits de recirculation sanitaire avec bypass mécanique pour la désinfection thermique des systèmes sanitaires, avec/sans isolation thermique.
- Thermostatventil für die Temperaturregelung der Brauchwasserrückführungskreisläufe mit mechanischem Bypass zur thermischen Desinfektion von Sanitäreanlagen, mit/ohne Wärmedämmung.
- Válvula termostática para el control de la temperatura de los circuitos de recirculación de agua doméstica con bypass mecánico para la desinfección térmica de sistemas sanitarios, con/sin aislamiento térmico.

Code	Size	Range	Insulation	Price	Class	Packaging
506188	1/2" F	35 – 60 °C	-	161,51 €	OE	1 / 22
507037	3/4" F	35 – 60 °C	-	161,51 €	OE	1 / 22
506188I	1/2" F	35 – 60 °C	✓	178,71 €	OE	1 / 12
507037I	3/4" F	35 – 60 °C	✓	178,71 €	OE	1 / 12

RTV C

- Valvola termostatica per il controllo della temperatura dei rami di ricircolo sanitario con bypass a controllo elettronico per la disinfezione termica degli impianti idrosanitari, con/senza coibentazione termica (testa elettrotermica non inclusa).
- Thermostatic valve for temperature control of sanitary recirculation circuits with electronically controlled bypass for thermal disinfection of sanitary systems, with/without thermal insulation (electrothermal head not included).
- Robinet thermostatique pour le contrôle de la température des circuits de recirculation sanitaire avec bypass à commande électronique pour la désinfection thermique des systèmes sanitaires, avec/sans isolation thermique (tête électrothermique non incluse).
- Thermostatventil für die Temperaturregelung der Brauchwasserrückführungskreisläufe mit elektronischem gesteuertem Bypass zur thermischen Desinfektion von Sanitäreanlagen, mit/ohne Wärmedämmung (Elektrothermischer Stellantriebe nicht enthalten).
- Válvula termostática para el control de la temperatura de los circuitos de recirculación de agua doméstica con bypass controlado electrónicamente para la desinfección térmica de sistemas sanitarios, con/sin aislamiento térmico (cabeza electrotérmica no incluida).

Code	Size	Range	Insulation	Price	Class	Packaging
506189	1/2" F	35 – 60 °C	-	161,51 €	OE	1 / 22
507038	3/4" F	35 – 60 °C	-	161,51 €	OE	1 / 22
506189I	1/2" F	35 – 60 °C	✓	178,71 €	OE	1 / 12
507038I	3/4" F	35 – 60 °C	✓	178,71 €	OE	1 / 12



• >>p. 220,360,397,477,488

CRTV 02

- Coibentazione termica per valvola RTV.
- Thermal insulation for RTV valve.
- Isolation thermique pour robinet RTV.
- Wärmedämmung für RTV-Ventil.
- Aislamiento térmico para válvula RTV.

Code	Price	Class	Packaging
506190	17,21 €	OE	1 / 12

LEGIO-BOX

LEGIO-BOX is a device designed to provide comfort and safety for domestic water distribution.

During supply to the terminals, LEGIO-BOX controls the distribution of cold and hot water (Fig. B), whose temperature it regulates through the thermostatic mixer MT 05. This is an anti-scald thermostatic mixer, with adjustable temperature between 36°C and 50°C, which guarantees a very high level of operating performance. If the temperature or water pressure changes suddenly, the MT 05 reacts immediately, ensuring people's safety by preventing them from being scalded.

During the programmed thermal disinfection, the thermostatic mixer is bypassed by an electronic control sent to the thermoelectric head (Fig. A). This way, by opening the taps of the different end components, the water will arrive at high temperature to carry out the thermal disinfection of the system.

Materials

Brass parts: CW617N

Sealing elements: peroxide EPDM

Technical specifications

Max. fluid temperature inside manifold: 90 °C

Maximum operating pressure: 10 bar

Max pressure differential at the ends of the zone valve: 1 bar

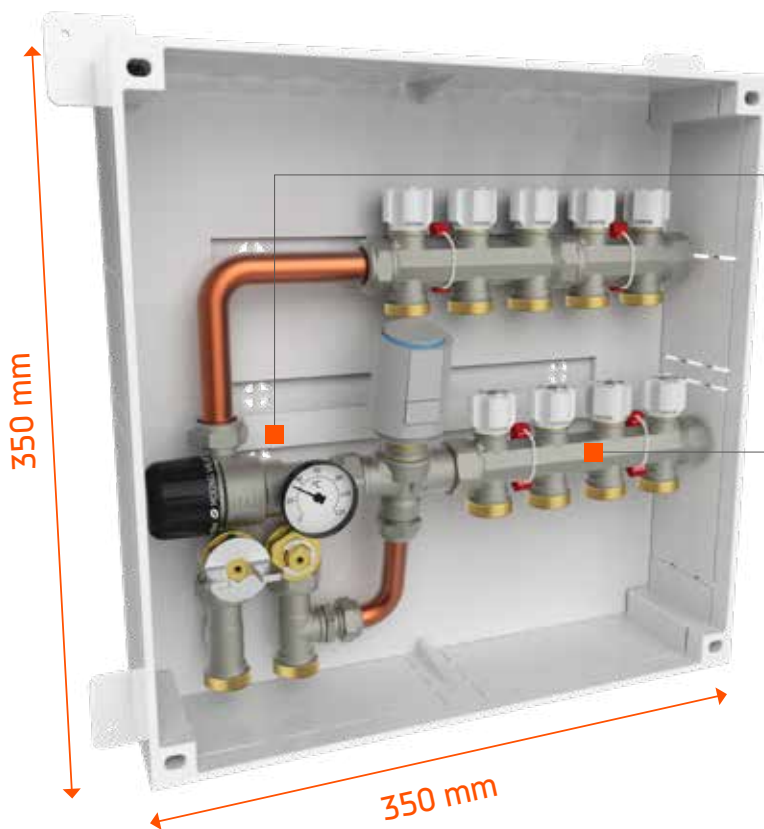

DOMESTIC WATER DISTRIBUTION, ANTI-SCALD THERMOSTATIC CONTROL AND THERMAL DISINFECTION in one compact and versatile product.

Available both in the complete version with domestic water manifolds and the box, or with just the device and the box.

Upon request, the anti-legionella cycle management control electronics are available.

Fig. A

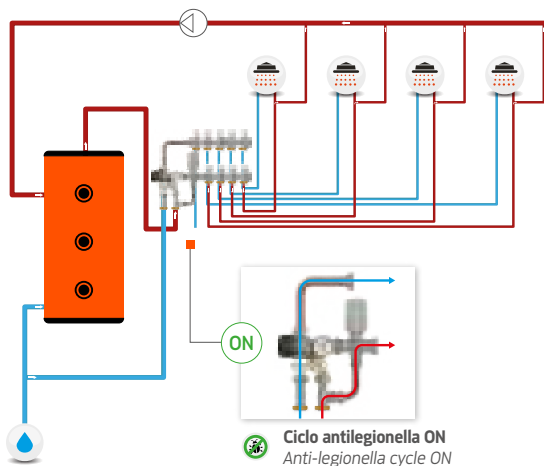
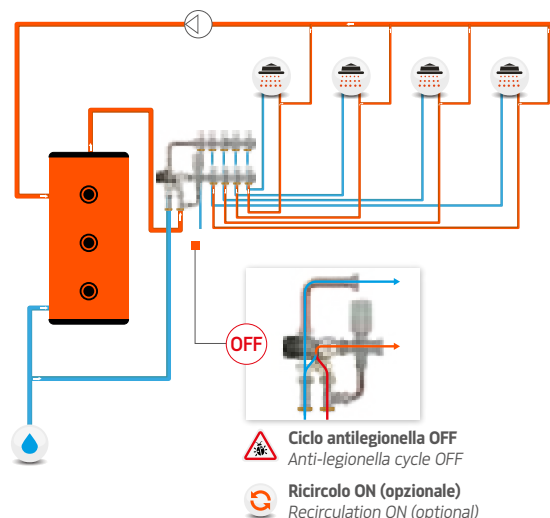

Fig. B



LEGIO-BOX 1

- Sistema multifunzione con/senza testa elettrotermica per il controllo della temperatura e disinfezione termica per impianti sanitari, completo di collettori, cassetta e kit di fissaggio.
- Multifunction temperature control and thermal disinfection system with/without electrothermal head for sanitary systems, complete with manifolds, box and fastening kit.
- Système multifonctions avec/sans tête électrothermique pour le contrôle de la température et la désinfection thermique des systèmes sanitaires, complet avec collecteurs, cassette et kit de fixation.
- Multifunktionssystem mit/ohne Elektrothermischer Stellantriebe zur Temperaturkontrolle und thermischen Desinfektion der Leitungen, komplett mit Verteiler, Schrank und Fixierung-kit.
- Sistema multifunción con/sin cabeza electrotérmico para el control de la temperatura y desinfección térmica para instalaciones sanitarias, completo con colectores, caja y kit de fijación.

Code	Cabinet	Hot / Cold ways	Head	Price	Class	Packaging
507039	✓	2 HOT / 3 COLD	✓	523,18 €	OE	1
507040	✓	2 HOT / 3 COLD	-	483,56 €	OE	1
507041	✓	3 HOT / 4 COLD	✓	537,13 €	OE	1
507042	✓	3 HOT / 4 COLD	-	497,52 €	OE	1
507043	✓	4 HOT / 5 COLD	✓	557,46 €	OE	1
507044	✓	4 HOT / 5 COLD	-	517,86 €	OE	1

LEGIO-BOX 2

- Sistema multifunzione con/senza testa elettrotermica per il controllo della temperatura e disinfezione termica per impianti idrosanitari, completo di cassetta e kit di fissaggio per collettori.
- Multifunction temperature control and thermal disinfection system with/without electrothermal head for sanitary systems, complete with box and fastening kit for manifolds.
- Système multifonctions avec/sans tête électrothermique pour le contrôle de la température et la désinfection thermique des systèmes sanitaires, complet avec cassette et kit de fixation pour collecteurs.
- Multifunktionssystem mit/ohne Elektrothermischer Stellantriebe zur Temperaturkontrolle und thermischen Desinfektion der Leitungen, komplett mit Schrank und Fixierung-kit für Verteiler.
- Sistema multifunción con/sin cabeza electrotérmico para el control de la temperatura y desinfección térmica para instalaciones sanitarias, completo con caja y kit de montaje para los colectores.

Code	Cabinet	Head	Price	Class	Packaging
507045	✓	✓	475,49 €	OE	1
507046	✓	-	435,87 €	OE	1

LEGIO-BOX 3

- Sistema multifunzione con/senza testa elettrotermica per il controllo della temperatura e disinfezione termica per impianti sanitari.
- Multifunction temperature control and thermal disinfection system with/without electrothermal head for sanitary systems.
- Système multifonctions avec/sans tête électrothermique pour le contrôle de la température et la désinfection thermique des systèmes sanitaires.
- Multifunktionssystem mit/ohne Elektrothermischer Stellantriebe zur Temperaturkontrolle und thermischen Desinfektion der Leitungen.
- Sistema multifunción con / sin cabeza electrotérmico para el control de la temperatura y desinfección térmica para instalaciones sanitarias.

Code	Head	Price	Class	Packaging
507047	✓	418,99 €	OE	1
507048	-	391,93 €	OE	1

IKLE01

- Modulo base di gestione dei cicli antilegionella con schermo integrato, kit morsetti e sonda di temperatura.
- Basic module for antilegionella cycles management with built-in screen, clamp kit and temperature probe.
- Module de base pour la gestion des cycles anti-Légionelle avec écran intégré, kit de bornes et sonde de température.
- Grundmodul für die Verwaltung der Antilegionellen-Zyklen mit integriertem Schirm, Klemmsatz und Temperaturfühler.
- Módulo base para la gestión de los ciclos antilegionella con pantalla incorporada, kit de bornes y sonda de temperatura.

Code	Size	Price	Class	Packaging
IKLE01	12-24 V AC	1.050,14 €	OE	1

IKGE01

- Sonda opzionale.
- Optional probe.
- Sonde optionnelle.
- Optionale Fühler.
- Sonda opcional.

Code	Range	Length	Price	Class	Packaging
IKGE01	-40 / 110 °C	1.50 m	On request	OE	1

THERMOSTATIC BLENDERS

Thermostatic mixers are used mainly in domestic water systems to mix hot and cold water and keep the outlet water at a constant temperature. For this reason, the device is used for several applications:

- ① as a delivery point mixer to cool the domestic hot water temperature
- ② as a temperature limiter downstream from electric storage water heaters
- ③ as a mixer for tanks where the hot water storage temperature may vary over time

The thermostatic mixer can also be considered a safety device because of its anti-scald function. In fact, if there is no cold water in the inlet, the device reacts by closing the hot water inlet instantly and avoiding scalding hazards for users. This feature makes the device particularly suitable in facilities such as hospitals, kindergartens or schools where the people, such as children and the elderly, are most at risk and where there are accumulations of domestic hot water subject to cycles of thermal disinfection (over 65° C) against the hazards of legionella.



CERTIFICATION

IVAR is one of three companies in the world that has received the prestigious French NF mark of approval (NF 079 doc. 08) from the CSTB thermostatic mixer certification laboratory for its MT 00 and MT 05 mixers. For example, this standard provides for an anti-scald device at the maximum adjusted temperature.



Materials

Body: brass CW617N
Parts in rubber: EPDM
Spring: stainless steel
Shutter: Ultem + silicon
Control cap or knob: ABS

Technical specifications

Max. static operating pressure: 10 bar
Max. temperature on inlets: 90 °C (NF, HT); 110 °C (SOL)
Min temperature difference between hot inlet and cold inlet to ensure anti-scalding function (NF, SOL): 15 °C

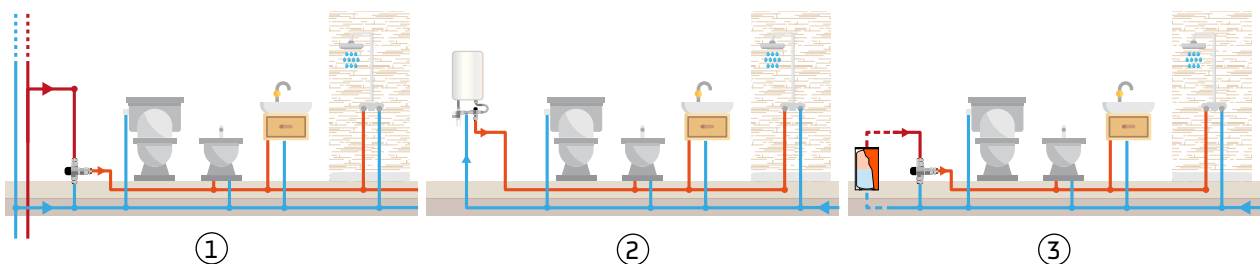

PLUS

- **Maximum comfort thanks to constant temperature**
- **Including inlet check valves**
- **Anti-scald safety device:** if there is no cold water the valve closes automatically avoiding the scalding of users
- **Recommended where there are DHW storage tanks where the accumulated water may undergo thermal shocks from an anti-legionella cycle**



MT

NF certified anti-scald line
(black cap/knob)

50 °C / 36-50 °C - Max 90 °C

- Delivery temperature control
- Fixed or adjustable calibration



MT SOL

Solar anti-scald line
(orange cap/knob)

50 °C / 36-50 °C - Max 120 °C

- For solar applications
- Delivery temperature control
- Fixed or adjustable calibration



MT HT

High temperature line
(green cap/knob)

63 °C / 50-63 °C - Max 90 °C

- High temperature
- Delivery temperature control
- Fixed or adjustable calibration

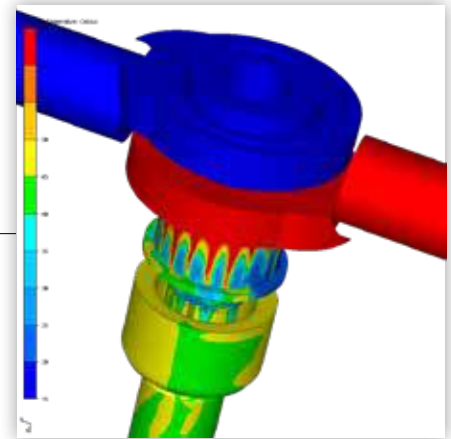

Wax expansion thermostat that expands and contracts according to the perceived temperature

The device is able to react to changes in the flow rate, inlet temperature (hot and/or cold water), inlet pressure and keep the temperature of the water delivered to users constant.

■ MT 00



- Miscelatore termostatico a taratura fissa completo di bocchettoni con valvola di non ritorno agli ingressi (temperatura max. ingresso: 90 °C).
- Thermostatic blender with fixed setting complete with fittings with non-return valve at the inlets (max. intake temperature: 90 °C).
- Limiteur de température à étalonnage fixe complet avec raccords avec clapet anti-retour aux entrées (température d'entrée max. : 90 °C).
- Thermostat-Mischer mit fester Eichung komplett mit Anschlüssen mit Rückschlagventil an den Eingängen (max. Einlauftemperatur: 90 °C).
- Mezclador termostático a valor fijo completo con manguitos con válvula de retención en las entradas (temperatura máx. de entrada: 90 °C).

Code	Size	Range	Color	Price	Class	Packaging
507020	1/2" M	50 (+0/-3) °C	■	87,02 €	QA	1 / 22
507030	3/4" M	50 (+0/-3) °C	■	99,53 €	QA	1 / 22

■ MT 05



- Miscelatore termostatico regolabile completo di bocchettoni con valvola di non ritorno agli ingressi (temperatura max. ingresso: 90 °C).
- Adjustable thermostatic blender complete with fittings with non-return valve at the inlets (max. intake temperature: 90 °C).
- Limiteur de température réglable complet avec raccords avec clapet anti-retour aux entrées (température d'entrée max. : 90 °C).
- Einstellbarer Thermostat-Mischer komplett mit Anschlüssen mit Rückschlagventil an den Eingängen (max. Einlauftemperatur: 90 °C).
- Mezclador termostático ajustable completo con manguitos con válvula de retención en las entradas (temperatura máx. de entrada: 90 °C).

Code	Size	Range	Color	Price	Class	Packaging
507025	1/2" M	36-50 °C	■	87,02 €	QA	1 / 22
507035	3/4" M	36-50 °C	■	99,53 €	QA	1 / 22

■ MT 00 SOL



- Miscelatore termostatico a taratura fissa per applicazioni solari completo di bocchettoni con valvola di non ritorno agli ingressi (temperatura max. ingresso: 110 °C).
- Thermostatic blender with fixed setting for solar applications complete with fittings with non-return valve at the inlets (max. intake temperature: 110 °C).
- Limiteur de température à étalonnage fixe pour des applications solaires complet avec raccords avec clapet anti-retour aux entrées (température d'entrée max. : 110 °C).
- Thermostat-Mischer mit fester Eichung für Solaranwendungen komplett mit Anschlüssen mit Rückschlagventil an den Eingängen (max. Einlauftemperatur: 110 °C).
- Mezclador termostático a valor fijo para aplicaciones solares completo con manguitos con válvula de retención en las entradas (temperatura máx. de entrada: 110 °C).

Code	Size	Range	Color	Price	Class	Packaging
507020SOL	1/2" M	50 (+0/-3) °C	■	104,82 €	QA	1 / 22
507030SOL	3/4" M	50 (+0/-3) °C	■	114,42 €	QA	1 / 22

■ MT 05 SOL



- Miscelatore termostatico regolabile per applicazioni solari completo di bocchettoni con valvola di non ritorno agli ingressi (temperatura max. ingresso: 110 °C).
- Adjustable thermostatic blender for solar applications complete with fittings with non-return valve at the inlets (max. intake temperature: 110 °C).
- Limiteur de température réglable pour des applications solaires complet avec raccords avec clapet anti-retour aux entrées (température d'entrée max. : 110 °C).
- Einstellbarer Thermostat-Mischer für Solaranwendungen komplett mit Anschlüssen mit Rückschlagventil an den Eingängen (max. Einlauftemperatur: 110 °C).
- Mezclador termostático ajustable para aplicaciones solares completo con manguitos con válvula de retención en las entradas (temperatura máx. de entrada: 110 °C).

Code	Size	Range	Color	Price	Class	Packaging
507025SOL	1/2" M	36-50 °C	■	104,82 €	QA	1 / 22
507035SOL	3/4" M	36-50 °C	■	114,42 €	QA	1 / 22

MT 00 HT

- Miscelatore termostatico a taratura fissa ad alta temperatura completo di bocchettoni con valvola di non ritorno agli ingressi (temperatura max. ingresso: 90 °C).
- High temperature thermostatic blender with fixed setting complete with fittings with non-return valve at the inlets (max. intake temperature: 90 °C).
- Limiteur de température à haute température à étalonnage fixe complet avec raccords avec clapet anti-retour aux entrées (température d'entrée max. : 90 °C).
- Thermostat-Mischer Hochtemperatur mit fester Eichung komplett mit Anschlüssen mit Rückschlagventil an den Eingängen (max. Einlauftemperatur: 90 °C).
- Mezclador termostático a valor fijo a alta temperatura completo con manguitos con válvula de retención en las entradas (temperatura máx. de entrada: 90 °C).

Code	Size	Range	Color	Price	Class	Packaging
507070	1/2" M	63 (+0/-3) °C	■	90,48 €	QA	1 / 28
507080	3/4" M	63 (+0/-3) °C	■	103,01 €	QA	1 / 28

MT 05 HT

- Miscelatore termostatico regolabile ad alta temperatura completo di bocchettoni con valvola di non ritorno agli ingressi (temperatura max. ingresso: 90 °C).
- Adjustable high temperature thermostatic blender complete with fittings with non-return valve at the inlets (max. intake temperature: 90 °C).
- Limiteur de température réglable à haute température complet avec raccords avec clapet anti-retour aux entrées (température d'entrée max. : 90 °C).
- Einstellbarer Thermostat-Mischer Hochtemperatur komplett mit Anschlüssen mit Rückschlagventil an den Eingängen (max. Einlauftemperatur: 90 °C).
- Mezclador termostático ajustable a alta temperatura completo con manguitos con válvula de retención en las entradas (temperatura máx. de entrada: 90 °C).

Code	Size	Range	Color	Price	Class	Packaging
507075	1/2" M	50-63 °C	■	90,48 €	QA	1 / 22
507085	3/4" M	50-63 °C	■	103,01 €	QA	1 / 22

AMT 01

- Bocchettone a tenuta morbida con/senza valvola di non ritorno anti-inquinamento per miscelatore termostatico.
- Soft-seal pipe fitting with/without anti-pollution non return valve for thermostatic blender.
- Goulotte à étanchéité souple avec/sans clapet anti-retour antipollution pour limiteur de température.
- Stutzen mit weicher Dichtung mit/ohne nicht-verschmutzendes Rückschlagventil für Thermostat-Mischer.
- Manguito de unión con junta blanda con/sin válvula de no retorno anti-contaminación para mezclador termostático.

Code	Size	Non return valve	Price	Class	Packaging
501669	1/2" M	-	5,13 €	QA	75 / 600
500499	1/2" M	✓	6,73 €	QA	75 / 600
501902	3/4" M	-	5,49 €	QA	75 / 600
501903	3/4" M	✓	7,25 €	QA	50 / 200



SAFETY UNITS

The safety unit is used in domestic plumbing systems for the following purposes:

- it prevents water pressure from reaching excessive and hazardous levels inside a water heater storage tank; this is why it is equipped with a safety valve that releases any excessive pressure that goes over the valve's pressure settings;
- through a check valve, it prevents any water from returning to the cold supply network (anti-contamination);
- through a shut-off valve, it facilitates maintenance operations on the heaters without having to drain down the entire system;
- it allows the manual emptying of the water heater through the manual drain valve.

The IVAR safety units are available with 3 different types of seats for the safety valve seal:

- Brass: suitable for soft water (little limescale).
- Teflon: its anti-stick and lubricating properties make it suitable in the presence of hard water - rich in limescale.
- Stainless steel: suitable for slightly acidic water.

The choice of the model with integrated dielectric connection allows the plant to be protected from possible electrolysis, which causes corrosion and therefore rust.

A tundish, which is also certified and essential for code-compliant installation, is also available for the system, for the protection of both the end user and the installer.

Materials

Body: brass CW617N (nickel-plated on exterior only)
Sealing parts: EPDM

Technical specifications

Max. fluid temperature inside component: 120 °C
Safety valve calibration pressure: 7 bar
Drainage flow rate at 8.4 bar:
- water: > 650 l/h
- steam: > 225 kg/h

⊕ PLUS

- **Anti-contamination function thanks to the built-in check valve**
- **Special versions for hard water with a PTFE seal or for acidic water with a stainless steel seal**
- **Safety function against overpressure (safety valve set at 7 bar)**
- **Manual draining and cut off available for maintenance operations**



CERTIFICATION

The safety units have been manufactured in accordance with the EN 1487 standard. According to the Ministry of Trade and Industry Circular No.9571 of 26 March 2003, these are to be installed on storage water heater delivery systems.



Straight drain



Square drain



Adjustable drain



GS 00 E

- Gruppo di sicurezza con scarico dritto.
- Safety unit with straight drainage valve.
- Groupe de sécurité avec robinet de vidange droit.
- Sicherheitsaggregat mit Entladeventil Durchgangsform.
- Grupo de seguridad con descarga recta.

Code	Size	Max inlet pressure	Color	Price	Class	Packaging
507053	3/4" - BRASS	7 bar	■	40,23 €	TA	1 / 8
507054	3/4" - TEFLON	7 bar	■	43,97 €	TA	1 / 8
507055	3/4" - STAINLESS STEEL	7 bar	■	43,97 €	TA	1 / 8

GS 10 E

- Gruppo di sicurezza con scarico a squadra.
- Safety unit with angle drainage valve.
- Groupe de sécurité avec robinet de vidange équerre.
- Sicherheitsaggregat mit Entladeventil Eckform.
- Grupo de seguridad con descarga de escuadra.

Code	Size	Max inlet pressure	Color	Price	Class	Packaging
507056	3/4" - BRASS	7 bar	■	41,26 €	TA	1 / 8
507057	3/4" - TEFLON	7 bar	■	45,53 €	TA	1 / 8
507058	3/4" - STAINLESS STEEL	7 bar	■	45,27 €	TA	1 / 8

GS 20 E

- Gruppo di sicurezza con scarico orientabile.
- Safety unit with swiveling drainage valve.
- Groupe de sécurité avec robinet de vidange orientable.
- Sicherheitsaggregat mit drehbarer Entladeventil.
- Grupo de seguridad con descarga orientable.



Code	Size	Max inlet pressure	Color	Price	Class	Packaging
507063	3/4" - BRASS	7 bar	■	45,27 €	TA	1 / 8
507064	3/4" - TEFLON	7 bar	■	48,69 €	TA	1 / 8
507065	3/4" - STAINLESS STEEL	7 bar	■	49,20 €	TA	1 / 8

GS 20 D

- Gruppo di sicurezza serie pesante con scarico orientabile e raccordo dielettrico.
- Safety unit heavy series with swiveling drainage valve and dielectric fitting.
- Groupe de sécurité série lourde avec robinet de vidange orientable et raccord diélectrique.
- Sicherheitsaggregat schwere Serie mit drehbarer Entladeventil und dielektrisch Verbinder.
- Grupo de seguridad serie pesada con descarga orientable y racor dieléctrico.



Code	Size	Max inlet pressure	Color	Price	Class	Packaging
507059	3/4" - TEFLON	7 bar	■	76,89 €	TA	1 / 16
506626	3/4" - STAINLESS STEEL	7 bar	■	77,28 €	TA	1 / 16

GS 101

- Gruppo di sicurezza dritto con manopola.
- Straight safety unit with knob.
- Groupe de sécurité droit avec poignée.
- Durchgangs-Sicherheitsaggregat mit Griff.
- Grupo de seguridad recto con mando.

Code	Size	Max inlet pressure	Color	Price	Class	Packaging
508050	1/2"	7 bar	■	44,16 €	TA	1 / 24

AGS 01

- Imbuto di scarico.
- Drain funnel.
- Entonnoir de vidange.
- Ablasstrichter.
- Embudo de vaciado.

Code	Price	Class	Packaging
507090	4,532 €	TC	1

AGS 00

- Raccordo dielettrico.
- Dielectric fitting.
- Raccord diélectrique.
- Dielektrisch Verbinder.
- Racor dieléctrico.

Code	Size	Price	Class	Packaging
506585	3/4" F x 1" M	9,93 €	TA	25 / 200

AGS 03

- Kit raccordi per collegamento boiler a gruppo sicurezza e miscelatore termostatico.
- Fittings kit for the connection of the boiler to the safety unit and thermostatic blender.
- Kit de raccords pour raccordement du chauffe-eau au groupe sécurité et limiteur de température.
- Bausatz Anschlüsse für die Verbindung des Boilers mit Sicherheitsgruppe und thermostatischem Mischer.
- Conjunto racores para conexión caldera con grupo de seguridad y mezclador termostático.

Code	Size	Price	Class	Packaging
507093	3/4" M x 3/4" G.	12,25 €	TC	5 / 40

SAFEMIX

Combining the thermostatic mixer with the safety unit led to the SAFEMIX unit, a multifunctional monobloc that performs all safety and control functions with only four connections. IVAR is the only company that has implemented this type of solution to date.

Perfect for electric water heaters, SAFEMIX comes with a dielectric connection for decoupling metal parts. The swivelling drain and the special accessory kit with connection pipe and trap make for an even neater installation. The thermostatic mixer is available in adjustable or fixed calibration versions.

Materials

Body: brass CW617N (nickel-plated on exterior only)

Sealing parts: EPDM

Technical specifications

Maximum operating temperature: 90 °C

Maximum operating pressure: 10 bar

Safety valve calibration pressure: 7 bar

⊕ PLUS

- A thermostatic mixer and a safety unit in a single component
- Ease of installation
- Including a dielectric connection for electrical insulation

CERTIFICATION



MT 00



GS 20 D

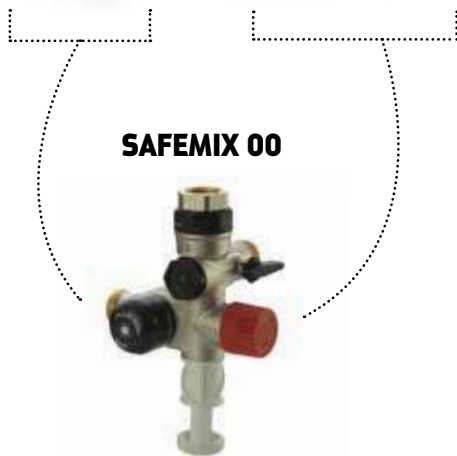

SAFEMIX 00

MT 05



GS 20 D

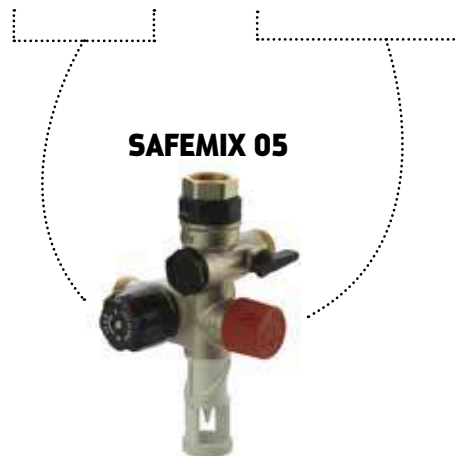

SAFEMIX 05

SAFEMIX 00

- Gruppo di sicurezza con scarico orientabile, miscelatore termostatico a taratura fissa integrato e raccordo dielettrico.
- Safety unit with swiveling drainage valve, integrated thermostatic blender with fixed setting and dielectric fitting.
- Groupe de sécurité avec robinet de vidange orientable, limiteur de température à étalonnage fixe intégré et raccord diélectrique.
- Sicherheitsaggregat mit drehbarer Entladeventil, ergänzt Thermostat-Mischer mit fester Eichung und dielektrisch Verbinder.
- Grupo de seguridad con descarga orientable, mezclador termostático a valor fijo integrado y racor dieléctrico.

Code	Size	Range	Max inlet pressure	Color	Price	Class	Packaging
507069	3/4" x 1" F - TEFLON	50 (+0/-3) °C	7 bar		200,46 €	TA	1 / 6
506573	3/4" x 1" F - STAINLESS STEEL	50 (+0/-3) °C	7 bar		200,46 €	TA	1 / 6

SAFEMIX 05

- Gruppo di sicurezza con scarico orientabile, miscelatore termostatico regolabile integrato e raccordo dielettrico.
- Safety unit with swiveling drainage valve, integrated adjustable thermostatic blender and dielectric fitting.
- Groupe de sécurité avec robinet de vidange orientable, limiteur de température réglable intégré et raccord diélectrique.
- Sicherheitsaggregat mit drehbarer Entladeventil, ergänzt einstellbarer Thermostat-Mischer und dielektrisch Verbinder.
- Grupo de seguridad con descarga orientable, mezclador termostático a valor fijo integrado y racor dieléctrico.

Code	Size	Range	Max inlet pressure	Color	Price	Class	Packaging
507071	3/4" x 1" F - TEFLON	36-50 °C	7 bar		200,46 €	TA	1 / 6
506574	3/4" x 1" F - STAINLESS STEEL	36-50 °C	7 bar		200,46 €	TA	1 / 6

SAFEMIX 10

- Gruppo di sicurezza con scarico orientabile, miscelatore termostatico a taratura fissa integrato, raccordi dielettrici e kit di collegamento al boiler.
- Safety unit with swiveling drainage valve, integrated thermostatic blender with fixed setting, dielectric fittings and boiler connection kit.
- Groupe de sécurité avec robinet de vidange orientable, limiteur de température à étalonnage fixe intégré, raccords diélectriques et kit pour raccordement au chauffe-eau.
- Sicherheitsaggregat mit drehbarer Entladeventil, ergänzt Thermostat-Mischer mit fester Eichung, dielektrisch Verbinder und Kit für die Verbindung des Boilers.
- Grupo de seguridad con descarga orientable, mezclador termostático a valor fijo integrado, racores dieléctricos y kit de conexión a la caldera.

Code	Size	Range	OC distance	Max inlet pressure	Color	Price	Class	Packaging
506579	3/4" - TEFLON	50 (+0/-3) °C	230 mm	7 bar		256,07 €	TA	1 / 6
506577	3/4" - STAINLESS STEEL	50 (+0/-3) °C	230 mm	7 bar		256,07 €	TA	1 / 6

SAFEMIX 15

- Gruppo di sicurezza con scarico orientabile, miscelatore termostatico regolabile integrato, raccordi dielettrici e kit di collegamento al boiler.
- Safety unit with swiveling drainage valve, integrated adjustable thermostatic blender, dielectric fittings and boiler connection kit.
- Groupe de sécurité avec robinet de vidange orientable, limiteur de température réglable intégré, raccords diélectriques et kit pour raccordement au chauffe-eau.
- Sicherheitsaggregat mit drehbarer Entladeventil, ergänzt einstellbarer Thermostat-Mischer, dielektrisch Verbinder und Kit für die Verbindung des Boilers.
- Grupo de seguridad con descarga orientable, mezclador termostático ajustable integrado, racores dieléctricos y kit de conexión a la caldera.

Code	Size	Range	OC distance	Max inlet pressure	Color	Price	Class	Packaging
506580	3/4" - TEFLON	36-50 °C	230 mm	7 bar		256,07 €	TA	1 / 6
506578	3/4" - STAINLESS STEEL	36-50 °C	230 mm	7 bar		256,07 €	TA	1 / 6

ASM 05

- Kit di collegamento al boiler con raccordo dielettrico.
- Boiler connection kit equipped with dielectric fitting.
- Kit pour raccordement au chauffe-eau équipé de raccord diélectrique.
- Kit für die Verbindung des Boilers mit dielektrisch Verbinder.
- Kit de conexión a la caldera con racor dieléctrico.

Code	Size	OC distance	Price	Class	Packaging
506586	3/4"	230 mm	40,47 €	TA	1 / 8

SAFETY VALVES

SAFETY VALVES FOR SANITARY APPLICATIONS

Safety valves are overpressure control devices which, when they reach the calibration value, drain fluid to prevent dangerous operating conditions. Suited for use in DHW systems (calibration 7 bar), IVAR valves are available with different connection threads and with or without pressure gauge connection.

VSC 00 S



- Valvola di sicurezza femmina-femmina.
- Female-female safety valve.
- Clapet de sécurité femelle-femelle.
- Sicherheitsventil IG-IG.
- Válvula de seguridad hembra-hembra.

Code	Size	Max inlet pressure	Color	Price	Class	Packaging
5702307	1/2" F x 1/2" F	7 bar	■	12,83 €	TA	10 / 80
5702317	3/4" F x 3/4" F	7 bar	■	15,07 €	TA	15 / 120

VSC 10 S



- Valvola di sicurezza maschio-femmina.
- Male-female safety valve.
- Clapet de sécurité mâle-femelle.
- Sicherheitsventil AG-IG.
- Válvula de seguridad macho-hembra.

Code	Size	Max inlet pressure	Color	Price	Class	Packaging
5702327	1/2" F x 1/2" M	7 bar	■	13,04 €	TA	20 / 160
5702337	3/4" F x 3/4" M	7 bar	■	15,11 €	TA	15 / 120

VSC 01 S



- Valvola di sicurezza femmina-femmina con attacco per manometro.
- Female-female safety valve with connection for pressure gauge.
- Clapet de sécurité femelle-femelle avec embout pour manomètre.
- Sicherheitsventil IG-IG mit Anschluß für Manometer.
- Válvula de seguridad hembra-hembra con conexión para manómetro.

Code	Size	Max inlet pressure	Color	Price	Class	Packaging
5702447	1/2" F x 1/2" F	7 bar	■	14,36 €	TA	20 / 160
5702457	3/4" F x 3/4" F	7 bar	■	16,18 €	TA	15 / 120

VSC 11 S



- Valvola di sicurezza maschio-femmina con attacco per manometro.
- Male-female safety valve with connection for pressure gauge.
- Clapet de sécurité mâle-femelle avec embout pour manomètre.
- Sicherheitsventil AG-IG mit Anschluß für Manometer.
- Válvula de seguridad macho-hembra con conexión para manómetro.

Code	Size	Max inlet pressure	Color	Price	Class	Packaging
5702467	1/2" M x 1/2" F	7 bar	■	14,60 €	TA	20 / 160
5702477	3/4" M x 3/4" F	7 bar	■	16,08 €	TA	15 / 120

VSC 05 S



- Valvola di sicurezza femmina-femmina con manometro.
- Female-female safety valve with pressure gauge.
- Clapet de sécurité femelle-femelle avec manomètre.
- Sicherheitsventil IG-IG mit Manometer.
- Válvula de seguridad hembra-hembra con manómetro.

Code	Size	Max inlet pressure	Color	Price	Class	Packaging
5702347	1/2" F x 1/2" F	7 bar	■	25,24 €	TA	1
5702357	3/4" F x 3/4" F	7 bar	■	27,06 €	TA	1

VSC 15 S



- Valvola di sicurezza maschio-femmina con manometro.
- Male-female safety valve with pressure gauge.
- Clapet de sécurité mâle-femelle avec manomètre.
- Sicherheitsventil AG-IG mit Manometer.
- Válvula de seguridad macho-hembra con manómetro.

Code	Size	Max inlet pressure	Color	Price	Class	Packaging
5702367	1/2" M x 1/2" F	7 bar	■	25,48 €	TA	1
5702377	3/4" M x 3/4" F	7 bar	■	26,97 €	TA	1

MA 10



- Manometro con attacco posteriore.
- Pressure gauge with rear connection.
- Manomètre avec embout postérieur.
- Manometer mit rückwärtigem Anschluss.
- Manómetro con conexión posterior.

Code	Size	Range	Price	Class	Packaging
509160	1/4" M	0-10 bar	10,89 €	TA	3 / 48

CHECK VALVES

Check valves are devices that prevent the reversal of the direction of flow.

IVAR offers anti-contamination non-return check valves, which, suitably positioned between the water main and user lines, prevent backflow by avoiding direct contact between the two networks and therefore contamination of the water distributed by the mains.

The product range also includes the Europa Valve®, which, because of its special threaded filter, and the water hammer shock absorber, which absorbs any overpressure that might build up in the system, while protecting the components most at risk, can be converted into a foot valve.

⊕ PLUS

- EA type devices, can be inspected: because of the two control ports, the correct operation of the check valve can be verified
- Suitable for applications with category 2 water

■ VNR 01



- Valvola di non ritorno anti-inquinamento.
- Anti-pollution non return valve.
- Clapet anti-retour antipollution.
- Nicht-verschmutzendes Rückschlagventil.
- Válvula de no retorno anti-contaminación.

Code	Size	Price	Class	Packaging
500899	3/4" - L. 58 mm	13,38 €	HD	180
500900	3/4" - L. 77,5 mm	15,55 €	HD	140

■ VR 00



- Valvola modello EUROPA.
- EUROPA model valve.
- Clapet modèle EUROPA.
- Ventil Modell EUROPA.
- Válvula modelo EUROPA.

Code	Size	Max inlet pressure	Operating temp.	Price	Class	Packaging
509045	3/8" F x 3/8" F	25 bar	-20 °C / 100 °C	11,72 €	HD	20 / 80
509046	1/2" F x 1/2" F	25 bar	-20 °C / 100 °C	13,76 €	HD	20 / 80
509047	3/4" F x 3/4" F	25 bar	-20 °C / 100 °C	18,55 €	HD	10 / 40
509048	1" F x 1" F	25 bar	-20 °C / 100 °C	25,28 €	HD	12 / 48
509049	1"1/4 F x 1"1/4 F	18 bar	-20 °C / 100 °C	39,48 €	HD	6 / 24
509050	1"1/2 F x 1"1/2 F	18 bar	-20 °C / 100 °C	53,56 €	HD	4 / 16
509051	2" F x 2" F	18 bar	-20 °C / 100 °C	82,11 €	HD	2 / 8
509052	2"1/2 F x 2"1/2 F	12 bar	-20 °C / 100 °C	187,98 €	HD	3
509053	3" F x 3" F	12 bar	-20 °C / 100 °C	280,59 €	HD	1
509054	4" F x 4" F	12 bar	-20 °C / 100 °C	467,55 €	HD	1

■ ACA 00



- Ammortizzatore colpo d'ariete.
- Water-hammer shock absorber.
- Anti de Coup de Bélier.
- Druckstoßdämpfer.
- Amortiguador golpe de ariete.

Code	Size	Max inlet pressure	Max operating temp.	Price	Class	Packaging
509029	1/2" M	10 bar	130 °C	35,13 €	HD	4 / 12

STRAINERS

AVR 00



- Filtro per valvola di fondo modello EUROPA.
- Filter for EUROPA model foot valve.
- Filtre pour clapet de fond modèle EUROPA.
- Filter für Bodenventil Modell EUROPA.
- Filtro para válvula de fondo modelo EUROPA.

Code	Size	Filtration capacity	Price	Class	Packaging
509055	3/8" M	1200 µm	1,911 €	HD	30 / 120
509056	1/2" M	1200 µm	1,93 €	HD	25 / 100
509057	3/4" M	1200 µm	2,176 €	HD	25 / 100
509058	1" M	1200 µm	2,817 €	HD	20 / 80
509059	1"1/4 M	1200 µm	3,679 €	HD	10 / 40
509060	1"1/2 M	1200 µm	4,014 €	HD	10 / 40
509061	2" M	1200 µm	6,12 €	HD	4 / 16
509062	2"1/2 M	2000 µm	10,94 €	HD	2 / 8
509063	3" M	2000 µm	13,05 €	HD	2 / 8
509064	4" M	2000 µm	16,92 €	HD	4

FI 00



- Filtro autopulente con 2 manometri, cartuccia filtrante estraibile e rubinetto di scarico.
- Self-cleaning filter with 2 pressure gauges, pull-out filter cartridge and discharge cock.
- Filtre autonettoyant avec 2 manomètres, cartouche filtrante extractible et robinet de décharge.
- Selbstreinigender Filter mit 2 Manometer, herausnehmbarem Filtereinsatz und Ablasshahn.
- Filtro autolimpiador con 2 manómetros, cartucho filtrante extraíble y llave de vaciado.

Code	Size	Max inlet pressure	Max operating temp.	Filtration capacity	Price	Class	Packaging
509030	1/2" F x 1/2" F	25 bar	110 °C	100 µm	126,99 €	HD	2
509031	3/4" F x 3/4" F	25 bar	110 °C	100 µm	126,99 €	HD	2
509032	1" F x 1" F	25 bar	110 °C	100 µm	158,67 €	HD	2
509033	1"1/4 F x 1"1/4 F	25 bar	110 °C	100 µm	158,67 €	HD	2
509034	1"1/2 F x 1"1/2 F	25 bar	110 °C	100 µm	218,12 €	HD	2
509035	2" F x 2" F	25 bar	110 °C	100 µm	218,12 €	HD	2
5090303	1/2" F x 1/2" F	25 bar	110 °C	300 µm	124,13 €	HD	2
5090313	3/4" F x 3/4" F	25 bar	110 °C	300 µm	124,13 €	HD	2
5090323	1" F x 1" F	25 bar	110 °C	300 µm	155,56 €	HD	2
5090333	1"1/4 F x 1"1/4 F	25 bar	110 °C	300 µm	155,56 €	HD	2
5090343	1"1/2 F x 1"1/2 F	25 bar	110 °C	300 µm	218,12 €	HD	2
5090353	2" F x 2" F	25 bar	110 °C	300 µm	218,12 €	HD	2

FI 10



- **Filtro a Y completo di cartuccia filtrante e tappo d'ispezione.**
- *Y-filter complete with filter cartridge and inspection plug.*
- **Filtre à Y doté de cartouche filtrante et bouchon d'inspection.**
- *Y-Filter mit Filtereinsatz und Prüfstopfen.*
- **Filtro en Y completo de cartucho filtrante y tapón de inspección.**

Code	Size	Operating temp.	Filtration capacity	Price	Class	Packaging
509036	1/2" F x 1/2" F	-20 °C / 110 °C	500 µm	9,22 €	HD	25
509037	3/4" F x 3/4" F	-20 °C / 110 °C	500 µm	14,98 €	HD	12
509038	1" F x 1" F	-20 °C / 110 °C	500 µm	23,64 €	HD	8
509039	1"1/4 F x 1"1/4 F	-20 °C / 110 °C	500 µm	35,56 €	HD	4
509040	1"1/2 F x 1"1/2 F	-20 °C / 110 °C	500 µm	47,37 €	HD	2
509041	2" F x 2" F	-20 °C / 110 °C	500 µm	76,83 €	HD	1 / 4
509042	2"1/2 F x 2"1/2 F	-20 °C / 110 °C	800 µm	136,62 €	HD	3
509043	3" F x 3" F	-20 °C / 110 °C	800 µm	185,03 €	HD	3

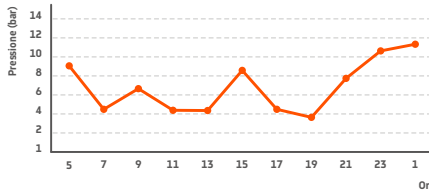

PRESSURE REDUCING VALVES

Pressure reducers are devices that are installed at the main inlet of homes to reduce and maintain a constant pressure in domestic users' lines even when there are changes in the mains pressure.



During the day, in fact, the pressure in the mains can vary significantly, especially during peak usage periods in an urban context. Over 24 hours, there is generally a maximum pressure trend at night when water use by users is lower with significant decreases in pressure during daylight hours when water use is more frequent and distributed.

These devices are installed to reduce the pressure in domestic lines compared to the mains pressure in the public network and to keep the pressure constant regardless of any fluctuations caused by the diversity of demand that might occur in the aqueduct. That is why pressure reducers take on more than one meaning in an installation:

- They protect the system from excessive pressure. Generally, the components installed inside a dwelling have a maximum static working pressure of 10 bar, while the pressure of the mains can reach higher levels, which could damage the most critical components;
- they stabilize the pressure in the domestic plumbing system. If this were not the case, there would be different pressures and different flow rates to the individual taps during the day resulting in poor results in terms of convenience in use;
- they reduce wasted water. By stabilising the pressure, they provide correct design flow at the taps, avoiding waste caused by pressure peaks in the mains.
- they avoid noise in the system due to excessive water speed (generated by high flow rates, in turn caused by high pressures) during use as well as vibration phenomena of the pipes and/or their brackets that can be caused by overpressure.

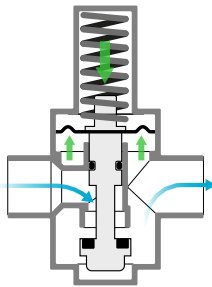

The PRV line of pressure reducers is of the cartridge type with compensated seat: in general, pressure reduction and stabilisation are obtained by the opposed action of the two forces that strike the shutter: one, which tends to close, is exerted by the pressure on the membrane, the other, which tends to open, is the elastic force of a spring. The devices with a compensated seat have the design detail that causes the discharge of the inlet pressure in the same way on both the seat and the spring. This makes the reaction of the device independent of the inlet pressure. Only the outlet pressure, which is discharged on the diaphragm acts on the contrast spring. This makes compensated seat PRVs significantly superior in terms of pressure regulation and stabilisation compared to uncompensated seat PRVs.

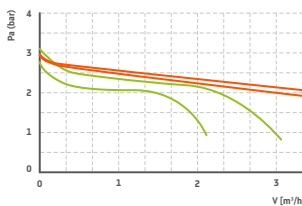

PRV pressure reducers also have an indicator for easy calibration of the outlet pressure with a special fitting for the installation of a pressure gauge to read and check downstream pressure (Fig. 1). Furthermore, the knob can be rotated to make the indicator always visible regardless of its installation position.

Also, the cartridge has a filter that can be easily cleaned by removing the cap and cutting off the downstream pressure reducer (Fig. 2).

The PRV are available in sizes DN 15, 20, 25, 32 and 40, also in the version with outlets. The PRV series pressure reducers have also been certified according to the EN 1567 European standard by the SVGW institute for applications in cold water (30°C) with inlet pressures not exceeding 16 bar. Nevertheless, IVAR guarantees the product up to a temperature of 70°C and a maximum inlet pressure of 25 bar.



Fig. 1



Fig. 2

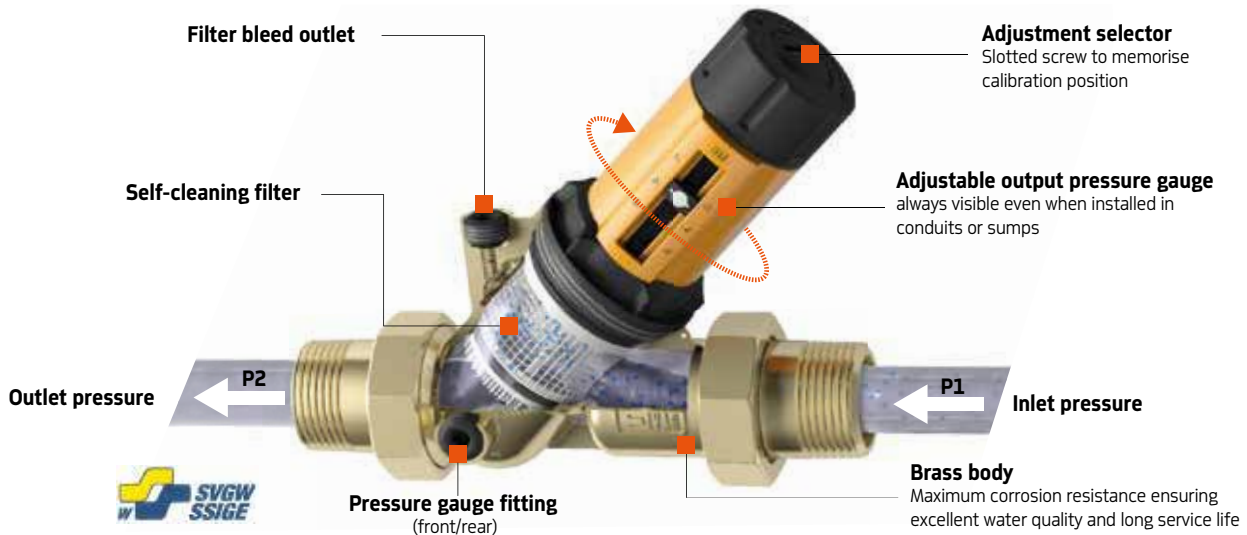

PLUS

- Protects the lines from excessive pressure
- Reduces wasted water
- Prevents noise phenomena in the lines
- The filter can be cleaned without having to remove it

PRV



- Riduttore di pressione regolabile con filtro autopulente (certificato secondo la norma UNI EN 1567 per acqua fredda: 30 °C, 16 bar).
- Adjustable pressure reducing valve with self-cleaning strainer (certified according to UNI EN 1567 standard for cold water: 30 °C, 16 bar).
- Réducteur de pression réglable avec filtre auto-nettoyant (certifié selon la norme UNI EN 1567 pour l'eau froide: 30 °C, 16 bar).
- Regelbar Druckminderer mit selbstreigener Kartusche Einsatz (Zertifizierung nach Standard UNI EN 1567 für Kaltwasser: 30 °C, 16 bar).
- Reductor de presión con regulación y con filtro autolimpiador (certificado según la norma UNI EN 1567 para el agua fría: 30 °C, 16 bar).

Code	Size	Range	Max inlet pressure	Preset	Max operating temp.	Filtration capacity	Price	Class	Packaging
509126	DN 15 x 1/2" M fitting	1,5 - 6 bar	25 bar	4 bar	70 °C	500 µm	101,36 €	HD	1
509127	DN 20 x 3/4" M fitting	1,5 - 6 bar	25 bar	4 bar	70 °C	500 µm	121,63 €	HD	1
509128	DN 25 x 1" M fitting	1,5 - 6 bar	25 bar	4 bar	70 °C	500 µm	155,43 €	HD	1
509129	DN 32 x 1"1/4 M fitting	1,5 - 6 bar	25 bar	4 bar	70 °C	500 µm	324,36 €	HD	1
509130	DN 40 x 1"1/2 M fitting	1,5 - 6 bar	25 bar	4 bar	70 °C	500 µm	473,02 €	HD	1

PRV NB



- Riduttore di pressione regolabile con filtro autopulente senza bocchettoni (certificato secondo la norma UNI EN 1567 per acqua fredda: 30 °C, 16 bar).
- Adjustable pressure reducing valve with self-cleaning strainer without fittings (certified according to UNI EN 1567 standard for cold water: 30 °C, 16 bar).
- Réducteur de pression réglable avec filtre auto-nettoyant sans raccords (certifié selon la norme UNI EN 1567 pour l'eau froide: 30 °C, 16 bar).
- Regelbar Druckminderer mit selbstreigener Kartusche Einsatz ohne Verschraubungen (Zertifizierung nach Standard UNI EN 1567 für Kaltwasser: 30 °C, 16 bar).
- Reductor de presión con regulación y con filtro autolimpiador sin racores (certificado según la norma UNI EN 1567 para el agua fría: 30 °C, 16 bar).

Code	Size	Range	Max inlet pressure	Preset	Max operating temp.	Filtration capacity	Price	Class	Packaging
509151	DN 15 x 3/4" M	1,5 - 6 bar	25 bar	4 bar	70 °C	500 µm	87,85 €	HD	1
509152	DN 20 x 1" M	1,5 - 6 bar	25 bar	4 bar	70 °C	500 µm	105,42 €	HD	1
509153	DN 25 x 1"1/4 M	1,5 - 6 bar	25 bar	4 bar	70 °C	500 µm	122,99 €	HD	1
509154	DN 32 x 1"1/2 M	1,5 - 6 bar	25 bar	4 bar	70 °C	500 µm	283,81 €	HD	1
509155	DN 40 x 2" M	1,5 - 6 bar	25 bar	4 bar	70 °C	500 µm	412,21 €	HD	1

RDP 00



- Riduttore di pressione con filtro ispezionabile in entrata e 2 manometri, funzionamento a membrana.
- Pressure reducing valve with inspection filter on the inlet and 2 pressure gauges, membrane operation.
- Réducteur de pression avec filtre pouvant être inspecté en entrée et 2 manomètres, fonctionnement à membrane.
- Druckminderer mit prüfbarem Filter im Eingang und 2 Manometer, Membranbetrieb.
- Reductor de presión con filtro ispezionabile en entrada y 2 manómetros, operación de membrana.

Code	Size	Range	Max inlet pressure	Preset	Max operating temp.	Price	Class	Packaging
509001	1/2" M x 1/2" M	0,5 - 6 bar	25 bar	3 bar	80 °C	120,51 €	HD	1
509002	3/4" M x 3/4" M	0,5 - 6 bar	25 bar	3 bar	80 °C	148,05 €	HD	1

RDP 10



- Riduttore di pressione, funzionamento a pistone.
- Pressure reducing valve, piston operation.
- Réducteur de pression, fonctionnement à piston.
- Druckminderer, Kolbenbetrieb.
- Reductor de presión, operación de pistón.

Code	Size	Range	Max inlet pressure	Preset	Max operating temp.	Price	Class	Packaging
509003	3/8" F x 3/8" F	1 - 4 bar	15 bar	3 bar	80 °C	25,81 €	HD	1
509004	1/2" F x 1/2" F	1 - 6 bar	15 bar	3 bar	80 °C	26,58 €	HD	1
509005	3/4" F x 3/4" F	1 - 4 bar	15 bar	3 bar	80 °C	28,57 €	HD	1

RDP 20



- Riduttore di pressione con attacco per manometro, funzionamento a pistone.
- Pressure reducing valve with pressure gauge coupling, piston operation.
- Réducteur de pression avec attache pour manomètre, fonctionnement à piston.
- Druckminderer mit Anschluss für Manometer, Kolbenbetrie.
- Reductor de presión con ataque por manómetro, operación de pistón.

Code	Size	Range	Max inlet pressure	Preset	Max operating temp.	Price	Class	Packaging
509006	3/8" F x 3/8" F	1 - 4 bar	15 bar	3 bar	80 °C	26,09 €	HD	1
509007	1/2" F x 1/2" F	1 - 4 bar	15 bar	3 bar	80 °C	26,54 €	HD	1
509008	3/4" F x 3/4" F	1 - 4 bar	15 bar	3 bar	80 °C	28,79 €	HD	5

RDP 30



- Riduttore di pressione con sede in acciaio e attacchi per manometro, funzionamento a pistone.
- Pressure reducing valve with steel seat and pressure gauge fittings, piston operation.
- Réducteur de pression avec siège en acier et attaches pour manomètre, fonctionnement à piston.
- Druckminderer mit Stahlaufnahme und Anschlüssen für Manometer, Kolbenbetrieb.
- Reductor de presión con asiento de acero y ataques para manómetro, operación de pistón.

Code	Size	Range	Max inlet pressure	Preset	Max operating temp.	Price	Class	Packaging
509009	3/8" F x 3/8" F	1 - 6 bar	25 bar	3 bar	80 °C	46,61 €	HD	1
509010	1/2" F x 1/2" F	1 - 6 bar	25 bar	3 bar	80 °C	55,96 €	HD	4 / 32
509011	3/4" F x 3/4" F	1 - 6 bar	25 bar	3 bar	80 °C	62,03 €	HD	2 / 8
509012	1" F x 1" F	1 - 6 bar	25 bar	3 bar	80 °C	90,43 €	HD	1 / 4
509013	1"1/4 F x 1"1/4 F	1 - 6 bar	25 bar	3 bar	80 °C	181,07 €	HD	1 / 4
509014	1"1/2 F x 1"1/2 F	1 - 6 bar	25 bar	3 bar	80 °C	203,07 €	HD	1 / 4
509015	2" F x 2" F	1 - 6 bar	25 bar	3 bar	80 °C	305,08 €	HD	3
509016	2"1/2 F x 2"1/2 F	1 - 6 bar	25 bar	3 bar	80 °C	529,30 €	HD	1
509017	3" F x 3" F	1 - 6 bar	25 bar	3 bar	80 °C	739,10 €	HD	1
509018	4" F x 4" F	1 - 6 bar	25 bar	3 bar	80 °C	1.686,94 €	HD	1

RDP 40

- **Riduttore di pressione con sede in acciaio e attacchi per manometro, funzionamento a pistone.**
- *Pressure reducing valve with steel seat and pressure gauge fittings, piston operation.*
- **Réducteur de pression avec siège en acier et attaches pour manomètre, fonctionnement à piston.**
- *Druckminderer mit Stahlaufnahme und Anschlüssen für Manometer, Kolbenbetrieb.*
- **Reductor de presión con asiento en acero y ataques por manómetros, operación de pistón.**

Code	Size	Range	Max inlet pressure	Preset	Max operating temp.	Price	Class	Packaging
509020	1/2" M x 1/2" M	1 - 6 bar	25 bar	3 bar	80 °C	64,20 €	HD	3
509021	3/4" M x 3/4" M	1 - 6 bar	25 bar	3 bar	80 °C	87,21 €	HD	3 / 24
509022	1" M x 1" M	1 - 6 bar	25 bar	3 bar	80 °C	122,54 €	HD	1 / 8
509023	1"1/4 M x 1"1/4 M	1 - 6 bar	25 bar	3 bar	80 °C	242,24 €	HD	1
509024	1"1/2 M x 1"1/2 M	1 - 6 bar	25 bar	3 bar	80 °C	256,71 €	HD	1
509025	2" M x 2" M	1 - 6 bar	25 bar	3 bar	80 °C	391,34 €	HD	2

MA 00

- **Manometro con attacco radiale.**
- *Pressure gauge with radial coupling.*
- **Manomètre avec attache radiale.**
- *Manometer mit Radialanschluss.*
- **Manómetro con ataque radial.**

Code	Size	Range	Price	Class	Packaging
509065	1/4" M	0-16 bar	10,40 €	HD	3 / 96

MA 16

- **Manometro con attacco posteriore.**
- *Pressure gauge with rear connection.*
- **Manomètre avec embout postérieur.**
- *Manometer mit rückwärtigem Anschluss.*
- **Manómetro con conexión posterior.**

Code	Size	Range	Price	Class	Packaging
509066	1/4" M	0-16 bar	10,40 €	HD	1 / 32





SYSTEMS FOR GAS



pim.ivar-group.com/short/IT-10

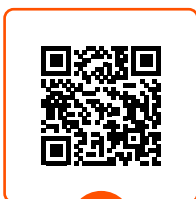

DOWNLOAD
Focus tecnici



pim.ivar-group.com/short/FR-10

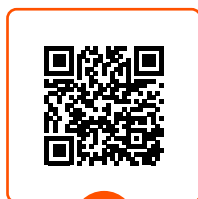

DOWNLOAD
Détails techniques



pim.ivar-group.com/short/DE-10

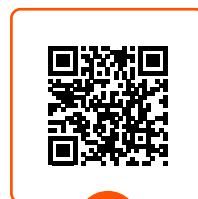

DOWNLOAD
Technische Details



pim.ivar-group.com/short/ES-10

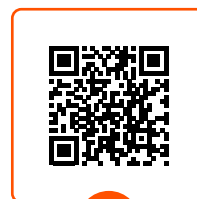

DOWNLOAD
Profundizaciones técnicas





Sistema tubazioni / raccordi a pressione per gas 453
Gas pipes / press fittings system
Système tuyaux / raccords à presser pour gaz
Gas-Rohre / Press Fittings System
Sistema tuberías / accesorios a presar para gas



Valvole di intercettazione per contatori gas 458
Isolation valves for gas meters
Vannes d'arrêt pour compteurs de gaz
Absperrventile für Gaszähler
Válvulas de interceptación para contadores de gas



Sistemi di distribuzione ed intercettazione linee gas sottotraccia domestiche 462
Distribution and isolation systems for chased domestic gas lines
Systèmes de distribution et d'arrêt de lignes de gaz domestiques sous plancher
Verteilungs- und Absperrsystem für Gas-Hausanlagen Unterputz
Sistemas de distribución e interceptación de líneas de tendido subterráneo domésticas



Accessori per sistemi gas 466
Accessories for gas systems
Accessoires pour systèmes pour le gaz
Zubehör für Gas-Systeme
Accesorios para sistemas gas

INSTALLATION LAYOUT

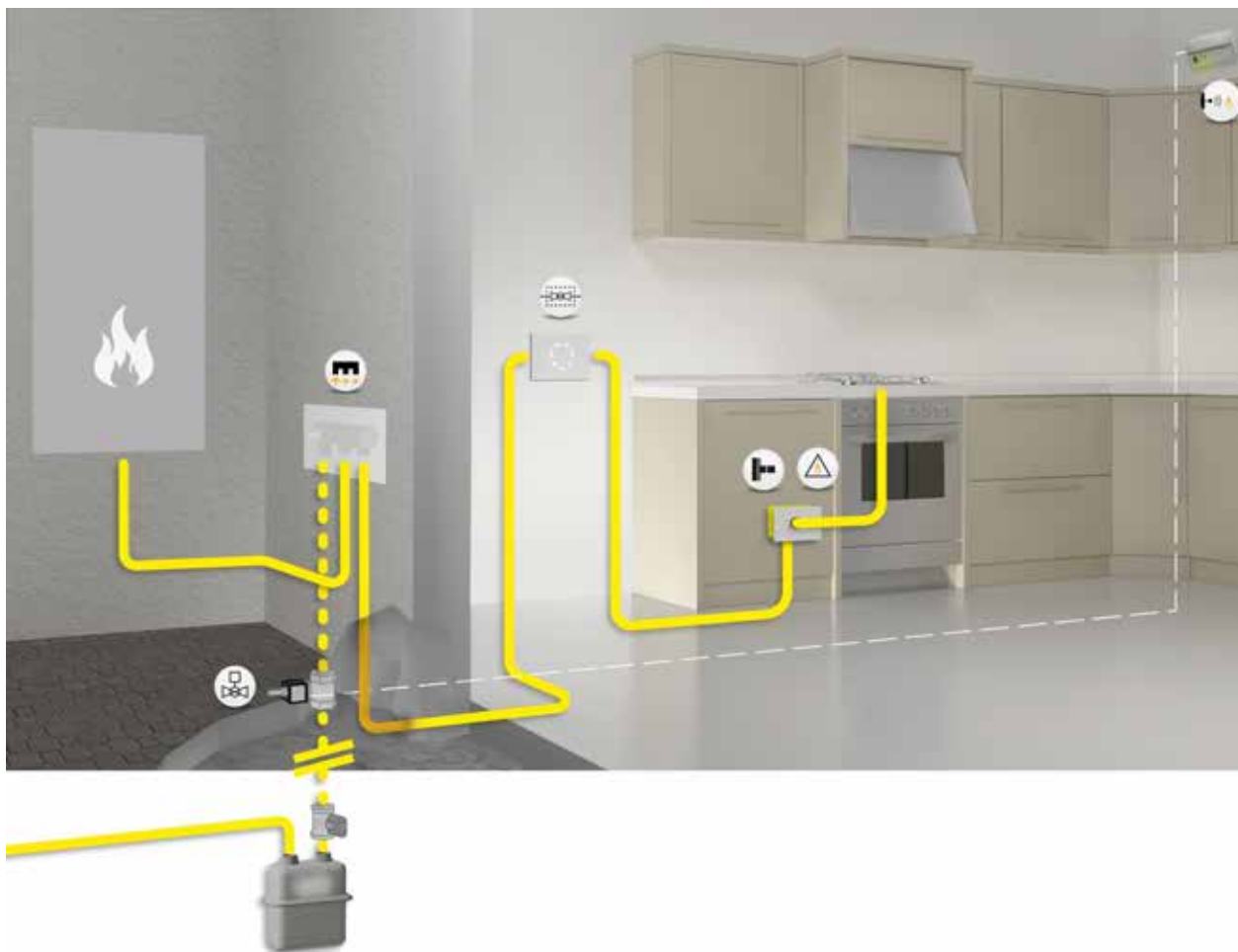

MULTI•PRESS•GAS

MULTI•PRESS GAS SYSTEM - ISO 17484 INTERNATIONAL STANDARD

IVAR S.p.A. is pleased to inform you that we have obtained the KIWA system certification in compliance with standard ISO 17484 – Plastic piping systems – Multilayer pipe systems for indoor gas installations with a maximum operating pressure up to and including 5 bar (500 kPa).

This document certifies the conformity of the MULTIPRESS GAS SYSTEM, consisting of MULTIPRESS GAS fitting combined with the ALPEX GAS pipe by Fraenkische (made in Germany) and with the TH, B (in case of REMS tool) or BE (in case of ROTHENBERGER tool) clamping profiles on diameters 16x2 - 20x2 - 26x3 - 32x3, to the above-mentioned standard.

IVAR S.p.A. reminds you that, as specified in the title of the standard, the certification refers to the entire system, which includes pressing pipe/fitting/tool (which must be supplied by IVAR, REMS or ROTHENBERGER). Moreover, the pressing machine must have a rated thrust force of at least 32 kN.

Therefore, IVAR S.p.A. will not be held liable, either in contractual or extra-contractual terms, for installations involving components that are not included in the MULTIPRESS GAS system or for installations that do not comply with the standards in force in the countries in which ISO 17484 certified systems (gas system installations) are accepted.

⊕ PLUS

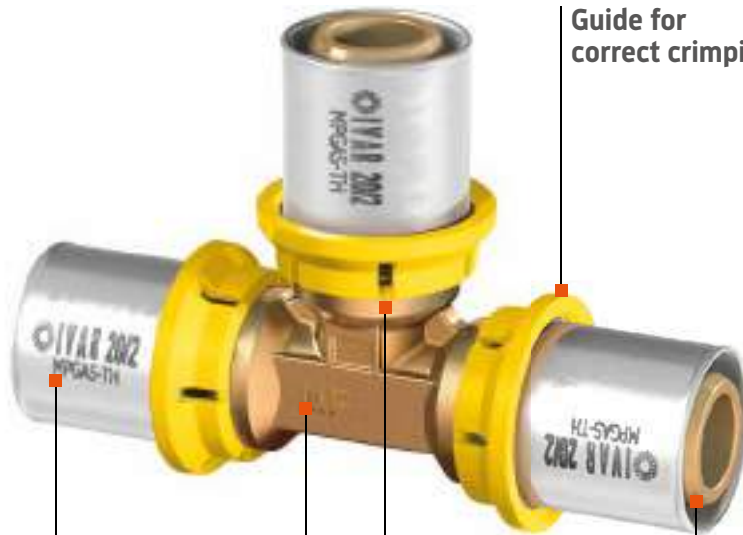

Guide for correct crimping



ISO 17484

Solution-treated stainless steel
to protect the crimper

Fitting can be rotated
even after crimping

Extended slots
to check for proper pipe insertion

Double O-Ring in yellow HNBR,
EN 549 compliant



- **Compatible with TH - B/BE crimping profiles**
- **Complete range of figures**
- **Ø from 16 to 32 mm**

Ø (mm)	16	20	26	32
Thickness (mm)	2	2	3	3
 BE**	■	■	■	■
B***	■	■	■	■
TH*	■	■	■	■

* Rothenberger/Rems ** Rothenberger *** Rems

The mentioned pressing jaws are integrated in the system; therefore, they must be supplied by IVAR, REMS or ROTHENBERGER. Moreover, the pressing machine must have a rated thrust force of at least 32 Kn



ALPEX GAS B



- Tubo multistrato PE-HD/Al/PE-Xb in barre.
- PE-HD/Al/PE-Xb multilayer pipe in bars.
- Tuyau multicouche PE-HD/Al/PE-Xb en barres.
- Verbundrohr PE-HD/Al/PE-Xb in Stangen.
- Tubo multicapa PE-HD/Al/PE-Xb en barras.

FRANKISCHE

Code	Size	Length	Color	Price	Class	Packaging
ALPEX-16BGAS	Ø16/2 (Aluminium 0,20 mm)	5 m	Yellow	4,086 €/m	HY	5 m
ALPEX-20BGAS	Ø20/2 (Aluminium 0,40 mm)	5 m	Yellow	5,661 €/m	HY	5 m
ALPEX-26BGAS	Ø26/3 (Aluminium 0,65 mm)	5 m	Yellow	8,756 €/m	HY	5 m
ALPEX-32BGAS	Ø32/3 (Aluminium 0,85 mm)	5 m	Yellow	14,878 €/m	HY	20 m

ALPEX GAS R



- Tubo multistrato PE-HD/Al/PE-Xb in rotoli.
- PE-HD/Al/PE-Xb multilayer pipe in coils.
- Tuyau multicouche PE-HD/Al/PE-Xb en rouleaux.
- Verbundrohr PE-HD/Al/PE-Xb in Rollen.
- Tubo multicapa PE-Xb/Al/PE-Xb en rollos.

FRANKISCHE

Code	Size	Color	Price	Class	Packaging
ALPEX-16RGAS	Ø16/2 (Aluminium 0,20 mm)	Yellow	2,984 €/m	HY	100 m
ALPEX-20RGAS	Ø20/2 (Aluminium 0,30 mm)	Yellow	4,142 €/m	HY	100 m
ALPEX-26RGAS	Ø26/3 (Aluminium 0,65 mm)	Yellow	7,947 €/m	HY	50 m
ALPEX-32RGAS	Ø32/3 (Aluminium 0,85 mm)	Yellow	13,497 €/m	HY	50 m

HD GAS



- Guaina corrugata proteggitubo.
- Pipe protection corrugated sheath.
- Gaine de protection tuyau ondulée.
- Wellschlauch zum Schutz der Rohre.
- Vaina corrugada de protección del tubo.

FRANKISCHE

Code	Size	Color	Price	Class	Packaging
HD34GAS	Ø16/2	Yellow	0,977 €/m	HY	50 / 800 m
HD35GAS	Ø20/2	Yellow	1,059 €/m	HY	50 / 800 m
HD36GAS	Ø26/3	Yellow	2,426 €/m	HY	25 / 400 m
HD37GAS	Ø32/3	Yellow	3,291 €/m	HY	25 / 400 m

MP 5608 GAS



- Raccordo diritto maschio.
- Straight male fitting.
- Raccord droit mâle.
- Durchgang AG Verbinder.
- Racor recto macho.

Code	Size	Price	Class	Packaging
510084MPGAS	3/8" M x 16/2	6,07 €	IQ	50
510001MPGAS	1/2" M x 16/2	4,408 €	IQ	40
510105MPGAS	3/4" M x 16/2	6,94 €	IQ	30
510002MPGAS	1/2" M x 20/2	5,10 €	IQ	40
510003MPGAS	3/4" M x 20/2	6,47 €	IQ	30
510004MPGAS	3/4" M x 26/3	8,44 €	IQ	30
510044MPGAS	1" M x 26/3	10,58 €	IQ	20
510021MPGAS	1" M x 32/3	12,75 €	IQ	20

MP 5711 GAS



- Raccordo ad angolo maschio.
- Male angle fitting.
- Raccord à angle mâle.
- AG Winkel-Verbinder.
- Racor codo macho.

Code	Size	Price	Class	Packaging
511001MPGAS	1/2" M x 16/2	5,50 €	IQ	40
511002MPGAS	1/2" M x 20/2	6,55 €	IQ	30
511003MPGAS	3/4" M x 20/2	8,24 €	IQ	20
511004MPGAS	3/4" M x 26/3	9,80 €	IQ	20
511113MPGAS	1" M x 26/3	15,20 €	IQ	10
511013MPGAS	1" M x 32/3	16,60 €	IQ	10

MP 5721 GAS



- Raccordo a T maschio.
- Male tee fitting.
- Raccord à T mâle.
- AG T-Stück.
- Racor Te rosca macho.

Code	Size	Price	Class	Packaging
512029MPGAS	16/2 x 1/2" M x 16/2	10,00 €	IQ	20
512030MPGAS	20/2 x 1/2" M x 20/2	11,13 €	IQ	16
512031MPGAS	16/2 x 3/4" M x 16/2	12,15 €	IQ	20
512032MPGAS	20/2 x 3/4" M x 20/2	12,71 €	IQ	16
512067MPGAS	26/3 x 3/4" M x 26/3	14,77 €	IQ	10

MP 5700 R GAS



- Raccordo diritto ridotto.
- Straight reduced fitting.
- Raccord droit réduit.
- Reduzierter Durchgangs-Verbinder.
- Racor recto reducido.

Code	Size	Price	Class	Packaging
510008MPGAS	16/2 x 20/2	6,86 €	IQ	40
510009MPGAS	16/2 x 26/3	9,29 €	IQ	30
510024MPGAS	16/2 x 32/3	12,26 €	IQ	15
510010MPGAS	20/2 x 26/3	9,63 €	IQ	20
510023MPGAS	20/2 x 32/3	13,05 €	IQ	15
510019MPGAS	26/3 x 32/3	14,06 €	IQ	15

MP 5700 GAS

- **Raccordo diritto.**
- *Straight fitting.*
- **Raccord droit.**
- *Kupplung.*
- **Racor recto.**

Code	Size	Price	Class	Packaging
510005MPGAS	16/2 x 16/2	5,70 €	IQ	40
510006MPGAS	20/2 x 20/2	7,45 €	IQ	30
510007MPGAS	26/3 x 26/3	11,11 €	IQ	20
510020MPGAS	32/3 x 32/3	16,41 €	IQ	15

MP 5720 GAS

- **Raccordo a T.**
- *Tee fitting.*
- **Raccord à T.**
- *T-Stück.*
- **Racor en Te.**

Code	Size	Price	Class	Packaging
512001MPGAS	16/2 x 16/2 x 16/2	8,46 €	IQ	20
512002MPGAS	20/2 x 20/2 x 20/2	11,87 €	IQ	16
512003MPGAS	26/3 x 26/3 x 26/3	18,23 €	IQ	10
512020MPGAS	32/3 x 32/3 x 32/3	29,13 €	IQ	8

MP 5720 RC GAS

- **Raccordo a T con attacco centrale ridotto.**
- *Tee fitting with reduced central connection.*
- **Raccord à T avec connexion centrale réduite.**
- *T-Stück mit reduziertem Zentralanschluss.*
- **Racor en Te con conexión central reducida.**

Code	Size	Price	Class	Packaging
512004MPGAS	20/2 x 16/2 x 20/2	11,50 €	IQ	16
512005MPGAS	26/3 x 16/2 x 26/3	16,74 €	IQ	12
512006MPGAS	26/3 x 20/2 x 26/3	17,15 €	IQ	12
512015MPGAS	32/3 x 16/2 x 32/3	23,93 €	IQ	8
512016MPGAS	32/3 x 20/2 x 32/3	26,59 €	IQ	8
512018MPGAS	32/3 x 26/3 x 32/3	27,91 €	IQ	8

MP 5720 RCL GAS

- **Raccordo a T con attacco centrale e laterale ridotti.**
- *Tee fitting with reduced central and side connection.*
- **Raccord à T avec connexion centrale et latérale réduites.**
- *T-Stück mit reduziertem Mittel- und Seitenanschluss.*
- **Racor en Te con conexión central y lateral reducida.**

Code	Size	Price	Class	Packaging
512009MPGAS	16/2 x 16/2 x 20/2	11,09 €	IQ	16
512012MPGAS	20/2 x 20/2 x 26/3	16,74 €	IQ	12
512021MPGAS	20/2 x 20/2 x 32/3	25,49 €	IQ	8
512017MPGAS	26/3 x 26/3 x 32/3	26,49 €	IQ	8

MP 5710 GAS

- **Raccordo ad angolo.**
- *Angle fitting.*
- **Raccord à angle.**
- *Winkel-Kupplung.*
- **Racor codo.**

Code	Size	Price	Class	Packaging
511009MPGAS	16/2 x 16/2	6,62 €	IQ	30
511010MPGAS	20/2 x 20/2	8,22 €	IQ	30
511011MPGAS	26/3 x 26/3	12,32 €	IQ	15
511012MPGAS	32/3 x 32/3	18,33 €	IQ	10

MP 5720 RLL GAS

- **Raccordo a T con attacchi laterali ridotti.**
- *Tee fitting with reduced side connections.*
- **Raccord à T avec connexions latérales réduites.**
- *T-Stück mit reduzierten seitlichen Anschlüssen.*
- **Racor en Te con conexiones laterales reducidas.**

Code	Size	Price	Class	Packaging
512013MPGAS	16/2 x 20/2 x 16/2	11,09 €	IQ	16
512014MPGAS	20/2 x 26/3 x 20/2	16,74 €	IQ	12
512051MPGAS	20/2 x 32/3 x 20/2	25,49 €	IQ	8
512019MPGAS	26/3 x 32/3 x 26/3	26,49 €	IQ	8

MP 5720 RL GAS

- **Raccordo a T con attacco laterale ridotto.**
- *Tee fitting with reduced side connection.*
- **Raccord à T avec connexion latérale réduite.**
- *T-Stück mit reduziertem seitlichen Anschluss.*
- **Racor en Te con conexión lateral reducida.**

Code	Size	Price	Class	Packaging
512007MPGAS	20/2 x 20/2 x 16/2	11,50 €	IQ	16
512048MPGAS	26/3 x 26/3 x 16/2	16,74 €	IQ	12
512008MPGAS	26/3 x 26/3 x 20/2	17,14 €	IQ	12
512068MPGAS	32/3 x 32/3 x 16/2	23,93 €	IQ	8
512052MPGAS	32/3 x 32/3 x 20/2	26,59 €	IQ	8
512053MPGAS	32/3 x 32/3 x 26/3	27,91 €	IQ	8

MP 5720 RR GAS

- **Raccordo a T con attacchi a doppia riduzione.**
- *Tee fitting with double reduction connections.*
- **Raccord à T avec des connexions à double réduction.**
- *T-Stück mit Doppel Reduktion Anschlüssen.*
- **Racor en Te con conexiones de doble reducción.**

Code	Size	Price	Class	Packaging
512010MPGAS	26/3 x 16/2 x 20/2	15,19 €	IQ	12
512011MPGAS	26/3 x 20/2 x 16/2	15,19 €	IQ	12
512050MPGAS	32/3 x 20/2 x 26/3	25,63 €	IQ	8
512024MPGAS	32/3 x 26/3 x 20/2	25,63 €	IQ	8



MP 5613 GAS



- Raccordo diritto femmina.
- Straight female fitting.
- Raccord droit femelle.
- Durchgang IG Verbinder.
- Racor recto hembra.

Code	Size	Price	Class	Packaging
510011MPGAS	1/2" F x 16/2	4,935 €	IQ	40
510109MPGAS	3/4" F x 16/2	6,51 €	IQ	30
510012MPGAS	1/2" F x 20/2	5,84 €	IQ	40
510013MPGAS	3/4" F x 20/2	6,93 €	IQ	30
510014MPGAS	3/4" F x 26/3	7,94 €	IQ	20
510047MPGAS	1" F x 26/3	9,45 €	IQ	15
510022MPGAS	1" F x 32/3	11,83 €	IQ	15

MP 5703 GAS



- Raccordo diritto con dado girevole a tenuta piana.
- Straight fitting with flat seal and rotating nut.
- Raccord droit avec écrou tournant à joint plat étanche.
- Gerades Verbindungsstück mit flach abgedichteter drehbarer Mutter.
- Racor recto con arandela y junta de estanqueidad plana.

Code	Size	Price	Class	Packaging
510085MPGAS	1/2" F x 16/2	5,50 €	IQ	40
510087MPGAS	1/2" F x 20/2	6,44 €	IQ	30
510076MPGAS	3/4" F x 16/2	6,44 €	IQ	30
510078MPGAS	3/4" F x 20/2	6,98 €	IQ	30
510088MPGAS	3/4" F x 26/3	8,45 €	IQ	30
510079MPGAS	1" F x 26/3	9,93 €	IQ	25
510089MPGAS	1" F x 32/3	13,42 €	IQ	20
510080MPGAS	1"1/4 F x 32/3	14,68 €	IQ	15

MP 5712 GAS



- Raccordo ad angolo femmina.
- Female angle fitting.
- Raccord à angle femelle.
- IG Winkel-Verbinder.
- Racor codo hembra.

Code	Size	Price	Class	Packaging
511005MPGAS	1/2" F x 16/2	5,16 €	IQ	30
511006MPGAS	1/2" F x 20/2	6,29 €	IQ	30
511007MPGAS	3/4" F x 20/2	8,11 €	IQ	25
511008MPGAS	3/4" F x 26/3	10,01 €	IQ	20
511114MPGAS	1" F x 26/3	15,26 €	IQ	10
511014MPGAS	1" F x 32/3	15,38 €	IQ	10

MP 5712 L GAS



- Raccordo ad angolo femmina lungo.
- Female angle fitting long.
- Raccord à angle femelle long.
- IG Winkel-Verbinder lang.
- Racor codo hembra largo.

Code	Size	Price	Class	Packaging
511029MPGAS	1/2" F x 16/2	5,77 €	IQ	25
511103MPGAS	1/2" F x 20/2	6,90 €	IQ	25

MP 5722 GAS



- Raccordo a T femmina.
- Female tee fitting.
- Raccord à T femelle.
- IG T-Stück.
- Racor Te rosca hembra.

Code	Size	Price	Class	Packaging
512022MPGAS	16/2 x 1/2" F x 16/2	9,01 €	IQ	20
512028MPGAS	16/2 x 3/4" F x 16/2	10,42 €	IQ	16
512027MPGAS	20/2 x 1/2" F x 20/2	10,72 €	IQ	16
512023MPGAS	20/2 x 3/4" F x 20/2	12,92 €	IQ	16
512047MPGAS	26/3 x 1/2" F x 20/2	15,36 €	IQ	12
512046MPGAS	26/3 x 1/2" F x 26/3	14,96 €	IQ	12
512042MPGAS	26/3 x 3/4" F x 26/3	14,11 €	IQ	10
512104MPGAS	26/3 x 1" F x 26/3	21,14 €	IQ	10
512043MPGAS	32/3 x 3/4" F x 32/3	23,15 €	IQ	10
512044MPGAS	32/3 x 1" F x 32/3	23,17 €	IQ	10

MP 5760 GAS



- Raccordo murale.
- Wall fitting.
- Raccord mural.
- Wand-Verbinder.
- Racor codo con base.

Code	Size	Height	Price	Class	Packaging
513001CMPGAS	1/2" F x 16/2	40 mm	8,86 €	IQ	15
513002CMPGAS	1/2" F x 20/2	40 mm	9,29 €	IQ	15
513001MPGAS	1/2" F x 16/2	52 mm	9,05 €	IQ	15
513002MPGAS	1/2" F x 20/2	52 mm	10,11 €	IQ	15
513003MPGAS	3/4" F x 20/2	57 mm	13,21 €	IQ	10
513004MPGAS	3/4" F x 26/3	57 mm	13,97 €	IQ	10

MP 5701 GAS

- Tappo.
- Plug.
- Bouchon.
- Verschluss.
- Tapón.

Code	Size	Price	Class	Packaging
510071MPGAS	16/2	4,935 €	IQ	40
510073MPGAS	20/2	6,51 €	IQ	40
510074MPGAS	26/3	9,10 €	IQ	35
510075MPGAS	32/3	12,46 €	IQ	30

AR 08 MP GAS

- Boccole di ricambio per MULTI PRESS GAS.
- Spare bushes for MULTI PRESS GAS.
- Douilles de rechange pour MULTI PRESS GAS.
- Ersatzhülsen für MULTI PRESS GAS.
- Casquillo para MULTI PRESS GAS.

Code	Size	Price	Class	Packaging
502120MPGAS	16/2	1,57 €	IG	50
502122MPGAS	20/2	1,713 €	IG	50
502124MPGAS	26/3	2,383 €	IG	20
502125MPGAS	32/3	2,599 €	IG	15

AR 10 R

- Pinze per raccordi a pressare.
- Jaws for press fittings.
- Pincas pour raccords à presser.
- Zangen für Pressanschlüsse.
- Pinzas para accesorios a presensar.



Code	Size	Price	Class	Packaging
501741RBE	Ø16 BE	694,10 €	IR	1
501743RBE	Ø20 BE	694,10 €	IR	1
501744RBE	Ø26 BE	694,10 €	IR	1
501745RBE	Ø32 BE	694,10 €	IR	1
501741RR	Ø16 R	390,75 €	IR	1
501742RR	Ø18 R	390,75 €	IR	1
501743RR	Ø20 R	390,75 €	IR	1
501730RR	Ø25 R	511,65 €	IR	1
501744RR	Ø26 R	390,75 €	IR	1
501745RR	Ø32 R	390,75 €	IR	1
501741RTH	Ø16 TH	318,16 €	IR	1
501742RTH	Ø18 TH	390,75 €	IR	1
501743RTH	Ø20 TH	318,16 €	IR	1
501730RTH	Ø25 TH	390,75 €	IR	1
501744RTH	Ø26 TH	318,16 €	IR	1
501745RTH	Ø32 TH	318,16 €	IR	1
501746RTH	Ø40 TH	792,80 €	IR	1
501741RU	Ø16 U	390,75 €	IR	1
501742RU	Ø18 U	390,75 €	IR	1
501743RU	Ø20 U	390,75 €	IR	1
501730RU	Ø25 U	390,75 €	IR	1
501745RU	Ø32 U	390,75 €	IR	1
501746RU	Ø40 U	792,80 €	IR	1



ISOLATION VALVES FOR METERS

The shut-off valves for gas meters made by IVAR are equipped with a pressure fitting for fast and secure system testing and with a safety handle to prevent accidental operation.

The pressure fitting is DVGW certified according to VP 308 and complies with the requirements of UNI 7129-1:2015 and UNI 11137. Thanks to a system with a double safety valve, the system test takes place safely without risk of gas leakage (fig. 1).

The valves for meters are equipped with a safety handle for locking them in the closed position, to prevent accidental openings. The valve is opened by pressing the handle. This safety device is recommended in the event that the valve can be accessed exclusively by an individual user (fig. 2).

In the event that the shut-off valve can also be accessed by other staff, standard UNI 7129-1:2015, section 4.1 requires the use of a handle with a safety key. This key can also be used in event of a default situation (fig. 3).

O: the key can be removed, and in this position the valve can be closed even without a key.

U: The key cannot be removed and the valve can be opened

M: PASSPARTOUT function that prevents the user key from being used.

The shut-off valves for meters are DVGW certified according to standard EN 331.

Technical characteristics

Operating pressure MOP 5

Operating temperature: -20°C; +60°C

Connections: threaded EN 10226-1 or ISO 228-1 (connection con swivel nut)

Fields of application: transport of all types of gas as specified in EN 437 and DVGW G260/1 (methane, butane, propane).

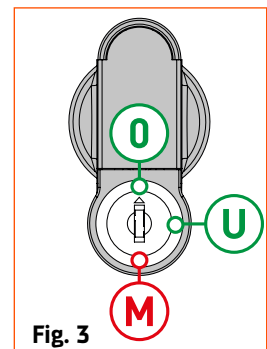
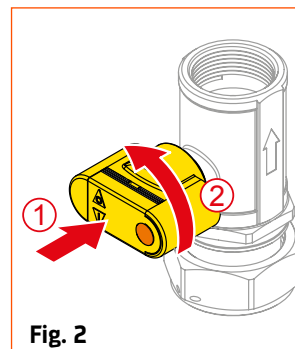
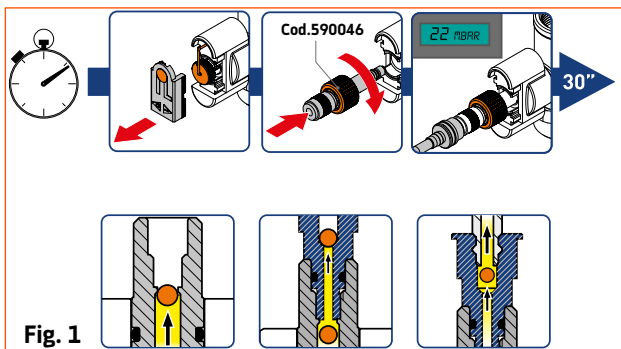

KPI 00



- Kit presa di pressione per prova impianto, completo di innesto rapido filettato 1/4" F.
- Pressure fitting kit the system testing, complete with threaded 1/4" F quick coupling
- Kit de prise de pression pour test d'installation, avec raccord à enclenchement rapide fileté 1/4" F
- Druckprüf-Kit zur Anlagenprüfung, einschließlich 1/4" IG Schnellkupplung
- Kit de toma de presión para la prueba de la instalación, con conexión rápida roscada 1/4" F.

Code	Size	Price	Class	Packaging
590046	1/4" F	40,99 €	ZF	1

■ VGD 00

- Valvola diritta per intercettazione contatore gas, completa di presa di pressione e maniglia di sicurezza. Attacchi: femmina-femmina
- Straight valve for gas meter interception, complete with pressure fitting and safety handle. Connections: female-female
- Vanne droite d'arrêt pour compteur de gaz, avec prise de pression et poignée de sécurité. Raccords : femelle-femelle
- Durchgangsventil zum Absperren des Gaszählers, komplett mit Prüföffnung und Sicherheitshandgriff. Anschlüsse: IG-IG
- Válvula recta de interceptación para contador de gas, con toma de presión y manilla de seguridad. Conexiones: hembra-hembra

Code	Size (D1 x D2)	Color	Price	Class	Packaging
590047	3/4" F x 3/4" F		96,13 €	ZF	1
590048	1" F x 1" F		97,73 €	ZF	1

■ VGDX 00



- Valvola a 90° destra per intercettazione contatore gas, completa di presa di pressione e maniglia di sicurezza. Attacchi: femmina-femmina
- Right hand 90° valve for gas meter interception, complete with pressure fitting and safety handle. Connections: female-female
- Vanne à 90° à droite d'arrêt pour compteur de gaz, avec prise de pression et poignée de sécurité Raccords : femelle-femelle
- 90°-Ventil rechts zum Absperren des Gaszählers, komplett mit Prüföffnung und Sicherheitshandgriff. Anschlüsse: IG-IG
- Válvula a 90° derecha de interceptación para contador de gas, con toma de presión y manilla de seguridad. Conexiones: hembra-hembra

Code	Size (D1 x D2)	Color	Price	Class	Packaging
590053	1" F x 1" F		110,95 €	ZF	1

■ VGS 00

- Valvola ad angolo per intercettazione contatore gas, completa di presa di pressione e maniglia di sicurezza. Attacchi: femmina-femmina.
- Angle valve for gas meter interception, complete with pressure fitting and safety handle. Connections: female-female
- Vanne à angle d'arrêt pour compteur de gaz, avec prise de pression et poignée de sécurité Raccords : femelle-femelle
- Eckventil zum Absperren des Gaszählers, komplett mit Prüföffnung und Sicherheitshandgriff. Anschlüsse: IG-IG
- Válvula angular de interceptación para contador de gas, con toma de presión y manilla de seguridad. Conexiones: hembra-hembra

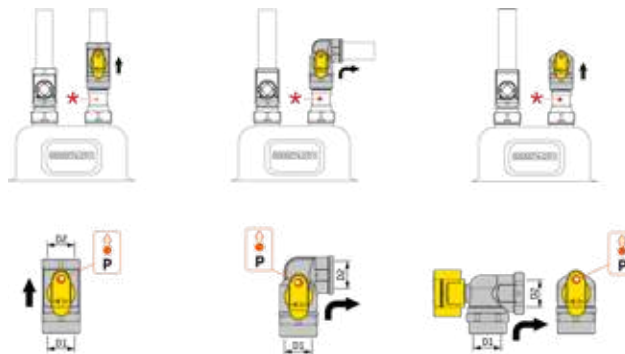
Code	Size (D1 x D2)	Color	Price	Class	Packaging
590054	1" F x 1" F		96,13 €	ZF	1





- Zona di accesso ad uso esclusivo del singolo utente. | *Raccordo di uscita a carico del distributore.
- Exclusive individual user use access area. | *Output fitting is the distributor's responsibility.
- Zone d'accès à l'usage exclusif de l'utilisateur individuel. | *Raccord de sortie à charge du distributeur.
- Die Nutzung des Zugangsbereichs ist ausschließlich dem Eigentümer vorbehalten. | *Auslaufanschluss zu Lasten des Vertellers.
- Zona de acceso de uso de un solo usuario exclusivamente. | *Racor de salida a cargo del distribuidor.



■ VGD 05



- **Valvola diritta per intercettazione contatore gas, completa di presa di pressione, maniglia con chiave di sicurezza e morosità.**
Attacchi: femmina – femmina
- *Straight valve for gas meter interception, complete with pressure fitting, handle with safety and default procedure key.*
Connections: female - female
- **Vanne droite d'arrêt pour compteur de gaz, avec prise de pression et poignée à clé de sécurité et suspension pour défaut de paiement.**
Raccords : femelle-femelle
- *Durchgangsventil zum Absperren des Gaszählers, komplett mit Prüföffnung und Handgriff mit Sicherheitsschlüssel und Absperrung bei Zahlungsverzug. Anschlüsse: IG-IG*
- **Válvula recta de interceptación para contador de gas, con toma de presión y manilla con clave de seguridad y morosidad.**
Conexiones: hembra – hembra

Code	Size (D1 x D2)	Color	Price	Class	Packaging
590057	3/4" F x 3/4" F		151,44 €	ZF	1
590058	1" F x 1" F		152,81 €	ZF	1

■ VGDX 05



- **Valvola a 90° destra per intercettazione contatore gas, completa di presa di pressione, maniglia con chiave di sicurezza e morosità.**
Attacchi: femmina – femmina
- *Right hand 90° valve for gas meter interception, complete with pressure fitting, handle with safety and default procedure key.*
Connections: female - female
- **Vanne à 90° à droite d'arrêt pour compteur de gaz, avec prise de pression et poignée à clé de sécurité et suspension pour défaut de paiement.**
Raccords : femelle-femelle
- *90°-Ventil zum Absperren des Gaszählers, komplett mit Prüföffnung und Handgriff mit Sicherheitsschlüssel und Absperrung bei Zahlungsverzug. Anschlüsse: IG-IG*
- **Válvula a 90° derecha de interceptación para contador de gas, con toma de presión y manilla con clave de seguridad y morosidad.**
Conexiones: hembra – hembra

Code	Size (D1 x D2)	Color	Price	Class	Packaging
590059	1" F x 1" F		166,02 €	ZF	1

■ VGS 05



- **Valvola ad angolo per intercettazione contatore gas, completa di presa di pressione e maniglia con chiave di sicurezza e morosità.**
Attacchi: femmina - femmina
- *Angle valve for gas meter interception, complete with pressure fitting and handle with safety and default procedure key.*
Connections: female - female
- **Vanne à angle d'arrêt pour compteur de gaz, avec prise de pression et poignée à clé de sécurité et suspension pour défaut de paiement.**
Raccords : femelle-femelle
- *Eckventil zum Absperren des Gaszählers, komplett mit Prüföffnung und Handgriff mit Sicherheitsschlüssel und Absperrung bei Zahlungsverzug. Anschlüsse: IG-IG*
- **Válvula angular de interceptación para contador de gas, con toma de presión y manilla con clave de seguridad y morosidad.**
Conexiones: hembra - hembra

Code	Size (D1 x D2)	Color	Price	Class	Packaging
590060	1" F x 1" F		207,69 €	ZF	1

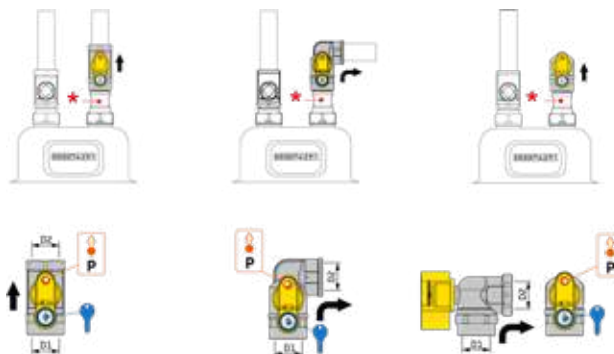

- **Zona di accesso ad uso esclusivo del singolo utente. | *Raccordo di uscita a carico del distributore.**
- *Exclusive individual user use access area. | *Output fitting is the distributor's responsibility.*
- **Zone d'accès à l'usage exclusif de l'utilisateur individuel. | *Raccord de sortie à charge du distributeur.**
- *Die Nutzung des Zugangsbereichs ist ausschließlich dem Eigentümer vorbehalten. | *Auslaufanschluss zu Lasten des Verteilers.*
- **Zona de acceso de uso de un solo usuario exclusivamente. | *Racor de salida a cargo del distribuidor.**

■ VGD 10

- **Valvola diritta per intercettazione contatore gas, completa di presa di pressione e maniglia di sicurezza.**
Attacchi: dado girevole ingresso –femmina uscita
- *Straight valve for gas meter interception, complete with pressure fitting and safety handle.*
Connections: swivel nut on inlet - female on outlet
- **Vanne droite d'arrêt pour compteur de gaz, avec prise de pression et poignée de sécurité.**
Raccords : écrou pivotant à l'entrée - femelle à la sortie
- *Durchgangsventil zum Absperren des Gaszählers, komplett mit Prüföffnung und Sicherheitshandgriff.*
Anschlüsse: Eingang Überwurfmutter – Ausgang Innengewinde
- **Válvula recta de interceptación para contador de gas, con toma de presión y manilla de seguridad.**
Conexiones: tuerca giratoria entrada – hembra salida

Code	Size (D1 x D2)	Color	Price	Class	Packaging
590049	1"1/4 swivel x 3/4" F		115,62 €	ZF	1
590050	1"1/4 swivel x 1" F		117,29 €	ZF	1
590051	1" swivel x 3/4" F		115,62 €	ZF	1
590052	1" swivel x 1" F		117,29 €	ZF	1

■ VGDX 10



- **Valvola a 90° destra per intercettazione contatore gas, completa di presa di pressione e maniglia di sicurezza.**
Attacchi: dado girevole ingresso –femmina uscita
- *Right hand 90° valve for gas meter interception, complete with pressure fitting and safety handle.*
Connections: swivel nut on inlet - female on outlet
- **Vanne à 90° à droite d'arrêt pour compteur de gaz, avec prise de pression et poignée de sécurité**
Raccords : écrou pivotant à l'entrée - femelle à la sortie
- *90°-Ventil rechts zum Absperren des Gaszählers, komplett mit Prüföffnung und Sicherheitshandgriff.*
Anschlüsse: Eingang Überwurfmutter – Ausgang Innengewinde
- **Válvula a 90° derecha de interceptación para contador de gas, con toma de presión y manilla de seguridad.**
Conexiones: tuerca giratoria entrada – hembra salida

Code	Size (D1 x D2)	Color	Price	Class	Packaging
590055	1" swivel x 1" F		130,52 €	ZF	1

■ VGS 10

- **Valvola ad angolo per intercettazione contatore gas, completa di presa di pressione e maniglia di sicurezza.**
Attacchi: dado girevole ingresso –femmina uscita
- *Angle valve for gas meter interception, complete with pressure fitting and safety handle.*
Connections: swivel nut on inlet - female on outlet
- **Vanne à angle d'arrêt pour compteur de gaz, avec prise de pression et poignée de sécurité**
Raccords : écrou pivotant à l'entrée - femelle à la sortie
- *Eckventil zum Absperren des Gaszählers, komplett mit Prüföffnung und Sicherheitshandgriff.*
Anschlüsse: Eingang Überwurfmutter – Ausgang Innengewinde
- **Válvula angular de interceptación para contador de gas, con toma de presión y manilla de seguridad.**
Conexiones: tuerca giratoria entrada – hembra salida

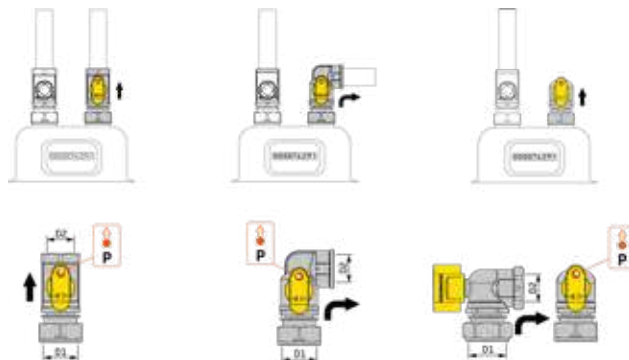
Code	Size (D1 x D2)	Color	Price	Class	Packaging
590056	1" swivel x 1" F		119,23 €	ZF	1



- **Zona di accesso ad uso esclusivo del singolo utente.**
- *Exclusive individual user use access area.*
- **Zone d'accès à l'usage exclusif de l'utilisateur individuel.**
- *Die Nutzung des Zugangsbereichs ist ausschließlich dem Eigentümer vorbehalten.*
- **Zona de acceso de uso de un solo usuario exclusivamente.**



DISTRIBUTION AND ISOLATION



Images for illustration purposes only

MANIFOLDS AND UNDER-FLOOR VALVES CONNECTIONS WITH SUITABLE FITTINGS

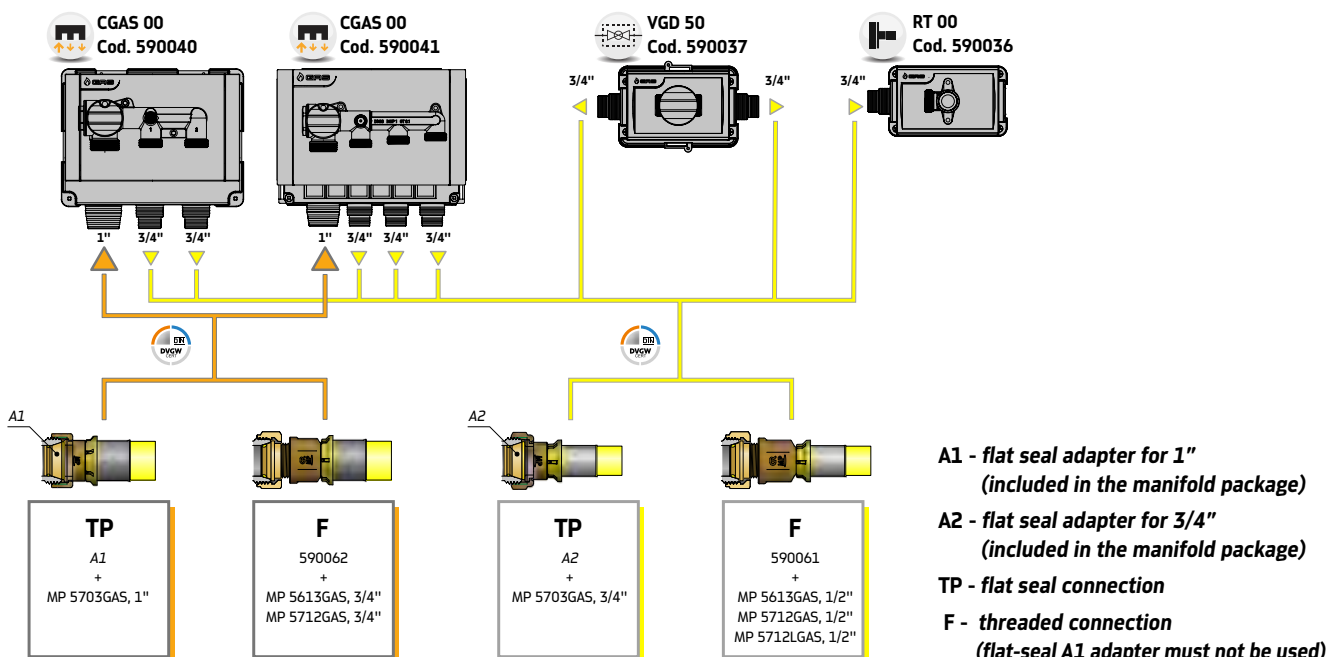

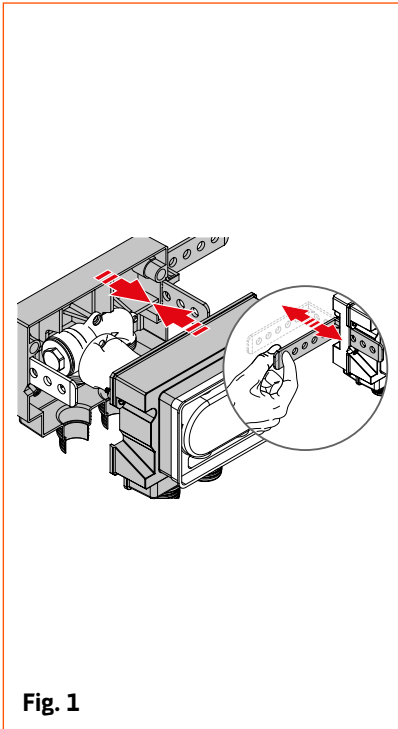
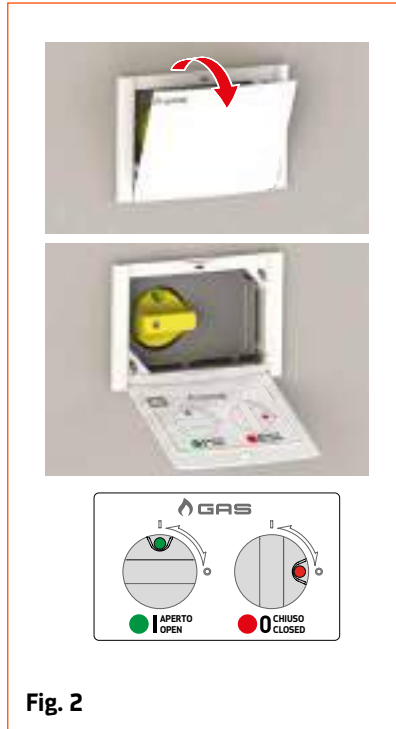

Fig. 1

Fig. 2

Fig. 3

IVAR offers a series of components suitable for the distribution and interception of chased gas lines in domestic systems: distribution manifolds with integrated shut-off valves, for general interception and simple utility shut-off valves, all DVGW certified according to standard EN 331 .

A general interception device is a device (tap or valve) whose purpose is to close an internal system and is usually installed on the first system branch.

Utility shut-off valves must be installed upstream of each appliance being used, i.e. upstream of the flexible or rigid connection between the appliance and the internal system. These devices must always be installed in order to be easily accessible by any user.

The chased installation of the devices is facilitated by special sandwich boxes with depth-adjustable brackets (fig.1).

These components ensure easy access to interception devices in compliance with the standards, but without affecting the aesthetics of the environment, thanks to cover plates with an accurate design and finish (fig.2).

In addition, the boxes for utility shut-off valves and manifolds ensure effective ventilation to the outside in the event of leaks, without using sealant, in accordance with standard UNI 7129-1: 2015 (fig.3).

The manifolds and shut-off valves are fitted with a flat seal adapter (equipped with a high temperature resistance gasket) for possible connection to multilayer gas pipes with flat seal press fittings.

An alternative is to use a special nozzle that ensures connection with a female EN 10226-1 compliant fitting.

ATTENTION: the manifold and valve connections are not compatible with EUROKONUS profile fittings!

The distribution and interception manifolds are also equipped with a pressure fitting for system testing.

Technical characteristics

Operating pressure MOP 1

Operating temperature: -20°C; +60°C

Thermal resistance: HTB GT 0.1 650°C x 30 min.

Connections: tapered seal (+ flat seal adapter)

Fields of application: for all types of gas as specified in EN 437 and DVGW G260/1



■ CGAS 00



- Collettore di distribuzione monointercettazione a due o tre uscite, completo di scatola per installazione sottotraccia, presa di pressione. Attacco principale (D1) e attacchi di distribuzione (D2) a tenuta conica con adattatore a tenuta piana incluso.
- Mono-interception distribution manifold with two or three outlets, complete with box for chased installation, pressure fitting. Main connection (D1) and distribution connections (D2) with tapered seal and flat seal adapter included
- Collecteur de distribution avec une seule vanne d'arrêt, à deux ou trois sortie, avec boîtier pour l'installation sous plancher et prise de pression. Raccord principal (D1) et raccords de distribution (D2) à joint d'étanchéité conique avec adaptateur à joint d'étanchéité plat inclus.
- Mono-Absperrverteiler mit zwei oder drei Ausgängen, komplett mit UP-Gehäuse, Prüföffnung. Hauptanschluss (D1) und Abgänge (D2) konisch dichtend, einschließlich Adapter mit Flachdichtung
- Colector de distribución monointercettazione con dos o tres salidas, con caja para la instalación de tendido subterráneo y toma de presión. Conexión principal (D1) y conexiones de distribución (D2) con junta de estanqueidad cónica con adaptador con junta de estanqueidad plana incluida

Code	Ways	Size (D1 x D2)	Color	Price	Class	Packaging
590040	2	1" x 3/4"	Yellow	186,21 €	ZF	1
590041	3	1" x 3/4"	Yellow	209,51 €	ZF	1

■ ACGAS 05



- Placca bianca di copertura per scatola ad incasso collettori di distribuzione monointercettazione
- White cover plate for recessed mono-interception distribution manifold box
- Plaque blanche de couverture pour boîtier encastrable pour les collecteurs de distribution à vanne d'arrêt unique
- Weiße Abdeckplatte für UP-Gehäuse für Mono-Absperrverteiler
- Placa blanca de cobertura para caja de empotrado de colectores de distribución monointercettazione

Code	Size	Manifolds type	Color	Price	Class	Packaging
590042	196 x 120 mm	590040	White	39,56 €	ZF	1
590043	230 x 140 mm	590041	White	47,97 €	ZF	1

■ VGD 50



- Valvola diritta di intercettazione utenza, completa di scatola per installazione sottotraccia. Attacchi a tenuta conica con adattatore a tenuta piana incluso.
- Straight utility shut-off valve, complete with box for chased installation. Tapered seal connections with flat seal adapter included
- Vanne droite d'arrêt d'application, avec boîtier pour installation sous plancher. Raccords à joint d'étanchéité conique avec adaptateur à joint d'étanchéité plat inclus
- Durchgangsabsperventil für Geräte, einschließlich Unterputzgehäuse. Konisch dichtende Anschlüsse, einschließlich Adapter mit Flachdichtung.
- Válvula recta de interceptación para suministro, con caja para instalación de tendido subterráneo. Conexiones con junta de estanqueidad cónica con adaptador con junta de estanqueidad plana incluido

Code	Size	Color	Price	Class	Packaging
590037	3/4" x 3/4"	Yellow	92,21 €	ZF	1

■ AVGD 50



- Placca di copertura per scatola ad incasso valvole di intercettazione utenza. Disponibile nelle varianti bianca e cromata.
- White cover plate for recessed utility shut-off valve box. Available in white and chrome
- Plaque blanche de couverture pour boîtier encastrable pour vannes d'arrêt d'application. Disponible en version blanche et chromée
- Abdeckplatte für UP-Gehäuse für Geräteabsperventile. Erhältlich in weißer und verchromter Ausführung
- Placa de cobertura para caja de empotrado de válvulas de interceptación para suministro. Disponible en las variantes blanca y cromada

Code	Size	Color	Price	Class	Packaging
590039	120 x 80 mm	White	17,42 €	ZF	1
590038	120 x 80 mm	Chrome	29,90 €	ZF	1

■ ACGAS 00





- Bocchettone adattatore per connessione ai terminali dei collettori di intercettazione e valvole intercettazione utenza.
- Adapter nozzle for connection to the terminals of the interception manifolds and utility shut-off valves
- Embout adaptateur pour connexion aux terminaux des collecteurs d'arrêt et vannes d'arrêt d'application
- Adapterstützen zur Verbindung mit den Anschlüssen der Absperrverteiler und Geräteabsperventile
- Boquillas adaptadoras para la conexión a los terminales de los colectores de interceptación y válvulas de interceptación para suministro

Code	Size	Color	Price	Class	Packaging
590061	3/4" swivel x 1/2" M	Yellow	12,15 €	ZF	1
590062	1" swivel x 3/4" M	Yellow	21,20 €	ZF	1



VSGD 00

- Valvola a sfera diritta per gas, nichelata con maniglia a leva plastificata gialla. Connessioni femmina/femmina. Conforme alla norma UNI EN 331.
- Straight gas ball valve, nickel-plated with yellow plastic lever handle. Female/female connections. Compliant with standard UNI EN 331
- Vanne à bille droite pour gaz, nickelée, avec poignée à levier plastifiée jaune. Connexions femelle/femelle. Conforme à la norme UNI EN 331
- Durchgangskugelhahn für Gas, vernickelt mit Hebelgriff mit gelber Kunststoffbeschichtung. Anschlüsse IG/IG. Gemäß UNI EN 331
- Válvula de esfera recta para gas, niquelada con manilla de palanca plastificada amarilla. Conexiones hembra/hembra. Conforme con la norma UNI EN 331

Code	Size	Color	Price	Class	Packaging
503100	1/2" F x 1/2" F		14,23 €	ZF	12 / 96
503101	3/4" F x 3/4" F		19,91 €	ZF	10 / 80
503102	1" F x 1" F		33,95 €	ZF	8 / 32

VSGD 05

- Valvola a sfera diritta per gas, nichelata con maniglia a leva plastificata gialla. Connessioni maschio/femmina. Conforme alla norma UNI EN 331.
- Straight gas ball valve, nickel-plated with yellow plastic lever handle. Male/female connections. Compliant with standard UNI EN 331
- Vanne à bille droite pour gaz, nickelée, avec poignée à levier plastifiée jaune. Connexions mâle/femelle. Conforme à la norme UNI EN 331
- Durchgangskugelhahn für Gas, vernickelt mit Hebelgriff mit gelber Kunststoffbeschichtung. Anschlüsse AG/IG. Gemäß UNI EN 331
- Válvula de esfera recta para gas, niquelada con manilla de palanca plastificada amarilla. Conexiones macho/hembra. Conforme con la norma UNI EN 331

Code	Size	Color	Price	Class	Packaging
503103	1/2" M x 1/2" F		14,42 €	ZF	12 / 96
503104	3/4" M x 3/4" F		20,67 €	ZF	10 / 80
503105	1" M x 1" F		36,01 €	ZF	8 / 32

VSGS 00

- Valvola a sfera ad angolo per gas, nichelata con farfalla in alluminio verniciata gialla. Connessioni femmina (F)/dado girevole (G). Conforme alla norma UNI EN 331
- Angle gas ball valve, nickel-plated with yellow painted aluminium butterfly valve. Female (F)/swivel nut(G) connections. Compliant with standard UNI EN 331
- Vanne à bille à angle pour gaz, nickelée avec papillon en aluminium peinte en jaune. Connexions femelle (F)/écrou pivotant (G). Conforme à la norme UNI EN 331
- Winkelkugelhahn für Gas, vernickelt mit gelb lackierten Knebelgriff aus Aluminium. Anschlüsse Innengewinde (F)/Überwurfmutter (G). Gemäß UNI EN 331
- Válvula de esfera angular para gas, niquelada con mariposa de aluminio pintada de amarillo. Conexiones hembra (F)/tuerca giratoria (G). Conforme con la norma UNI EN 331

Code	Size	Color	Price	Class	Packaging
503106	1/2" F x 3/4" swivel		21,80 €	ZF	10 / 80
503107	3/4" F x 3/4" swivel		29,84 €	ZF	8 / 64
503108	3/4" F x 1" swivel		31,89 €	ZF	6 / 48
503109	1" F x 1" 1/4 swivel		50,16 €	ZF	4 / 32

VSGS 05

- Valvola a sfera ad angolo per gas, nichelata con farfalla in alluminio verniciata gialla. Connessioni maschio (M)/dado girevole (G). Conforme alla norma UNI EN 331
- Angle gas ball valve, nickel-plated with yellow painted aluminium butterfly valve. Male (F)/swivel nut(G) connections. Compliant with standard UNI EN 331
- Vanne à bille à angle pour gaz, nickelée avec papillon en aluminium peinte en jaune. Connexions mâle (M)/écrou pivotant (G). Conforme à la norme UNI EN 331
- Winkelkugelhahn für Gas, vernickelt mit gelb lackierten Knebelgriff aus Aluminium. Anschlüsse Außengewinde (M)/Überwurfmutter (G). Gemäß UNI EN 331
- Válvula de esfera angular para gas, niquelada con mariposa de aluminio pintada de amarillo. Conexiones macho (M)/tuerca giratoria (G). Conforme con la norma UNI EN 331

Code	Size	Color	Price	Class	Packaging
503110	1/2" M x 3/4" swivel		23,53 €	ZF	10 / 80
503111	3/4" M x 3/4" swivel		30,42 €	ZF	8 / 64
503112	3/4" M x 1" swivel		32,00 €	ZF	6 / 48
503113	1" M x 1" 1/4 swivel		50,16 €	ZF	4 / 32



ACCESSORIES FOR GAS SYSTEMS



RT 00 - RST 00



RG 00

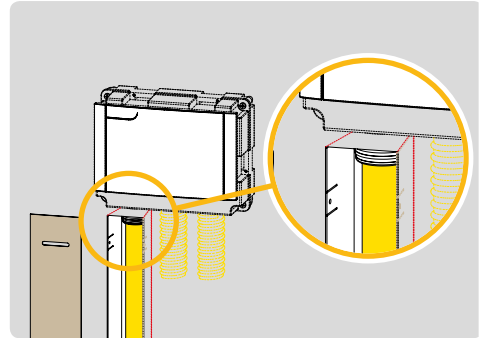

CMG 00

IVAR solutions for domestic gas installations also include two devices relating to safety.

RST 00 is a curved connection with an integrated thermal safety device, usually coupled with an end fitting (RT 00) inserted in a chased box accessible for inspection. The device prevents gas leakage from the mains in the event of fire and limits the possible development of a fire, activating thermally between 95°C and 100°C (with operating resistance up to 925°C for one hour).

Field of use: -20°C; +60°C. MOP 5. HTB GT5 925°C for 60 min.

RT 00 is a terminal fitting placed inside a chased box accessible for inspection, which allows compliance with standard UNI/TS 11343:4.3.2.2; therefore, the fittings can be buried or chased provided that they are installed in a specific well accessible for inspection with a cover that must not be sealed. The junction points near the fittings inside the wells must be suitably protected against corrosion, in compliance with standard UNI EN 12954.

RG 00 is the methane gas leak detector, which promptly triggers an alarm in the presence of gas through both optical and acoustic signals, as well as interrupting the flow by acting on a special solenoid valve.

The range of solenoid valves is available in versions with max pressure up to 0.5 bar or up to 6 bar, in sizes DN 15-20-25 and in normally open or normally closed versions with manual reset. The latter are a positive safety device, namely they close the gas supply when power is missing (even in case of a black-out) and are CE approved according to EN 161. They also comply with the Gas Directive 2009/142/EC and the PED Directive 97/23/EC for 6 bar versions.

IVAR offers a range of compact-type gas filters, which are capable of blocking the flow of dust particles or debris carried by gas, thus preserving regulation and safety devices. The cartridge, made of a synthetic material, is washable and fully removable to allow adequate cleaning and inspection. Moreover, these filters are equipped with a suitable fitting for pressure measurement.

It should finally be noted that standard UNI 7129-1:2015 requires that pipes on the external perimeter walls cannot be chased and, for multilayer pipes, that they cannot even be in view. They can however be installed within appropriate metal ventilated channels, accessible for inspection. For this purpose, IVAR solutions include a channel accessible for inspection (CMG 00) for the recessed installation of external building pipes, complete with a cover with screws.

RST 00



- Raccordo a 90° con dispositivo ad attivazione termica di sicurezza per tubo flessibile per apparecchiature gas
- 90° fitting with thermal activation safety device for gas appliance hoses
- Raccord à 90° avec dispositif de sécurité à déclenchement thermique pour tuyau flexible pour les appareils à gaz
- 90°-Winkelstück mit thermischer Sicherheitseinrichtung für flexible Anschlussleitungen von Gasgeräten
- Racor a 90° con dispositivo de activación térmica de seguridad para tubo flexible para aparatos de gas

RG 00



- Rilevatore gas metano con segnalazione ottica e acustica d'allarme. Uscita con contatto in scambio per elettrovalvola. Conforme normativa EN 50194-1.
- Methane gas detector with optical and acoustic alarm. Outlet with changeover contact for solenoid valve. Compliant with standard EN 50194-1
- Détecteur de gaz méthane avec signalisation visuelle et sonore. Sortie avec contact de commutation pour électrovanne. Conforme à la norme EN 50194-1
- Methan-Gasdetektor mit optischem und akustischem Alarm. Ausgang mit Wechselkontakt für Magnetventil. Entspricht der Norm EN 50194-1
- Detector de gas metano con señalización óptica y acústica de alarma. Salida con contacto en intercambio para electroválvula. Conforme con la normativa EN 50194-1

Code	Size (D1 x D2)	Color	Price	Class	Packaging
590045	1/2" M x 1/2" M	■	39,89 €	ZF	1

Code	Color	Price	Class	Packaging
590077	□	205,57 €	ZF	2 / 16

RT 00

- Scatola da incasso con raccordo terminale in uscita completa di placca bianca di copertura
- Recessed box with terminal fitting on outlet, complete with white cover plate
- Boîtier encastrable avec raccord terminal de sortie et plaque blanche de couverture
- UP-Gehäuse mit Anschlussstück für Abgang einschließlich weißer Abdeckplatte
- Caja de empotrado con racor terminal en la salida, con placa blanca de cobertura

Code	Size (D1 x D2)	Color	Price	Class	Packaging
590036	3/4" TC x 1/2" F	□	59,19 €	ZF	1

CMG 00

- Canaletta metallica ispezionabile per incasso tubazioni esterne all'edificio
- Metal channel accessible for inspection for the recessed installation of external building pipes
- Goulotte métallique pouvant être inspectée pour l'encastrement des tuyaux externes au bâtiment
- Prüfbarer Metallkanal für Unterputzinstallation von Rohren an der Gebäudeaußenseite
- Canalización metálica inspeccionable para empotrado de tuberías externas al edificio

Code	Size	Price	Class	Packaging
590044	750 x 50 mm	38,01 €	ZF	1

EVG 00

- Elettrovalvola di intercettazione flusso gas normalmente chiusa a riarmo manuale. Alimentazione 230 VAC. Connessioni femmina-femmina.
- Gas flow isolation solenoid valve normally closed with manual reset. 230 VAC power supply. Female-female connections.
- Électrovanne d'arrêt du flux de gaz normalement fermée à réenclenchement manuel. Alimentation 230 VAC. Connexions femelle-femelle.
- Magnet-Absperrventil für Gas, normal geschlossen mit manueller Rückstellrichtung. Versorgung 230 VAC. Anschlüsse mit Innengewinde.
- Electroválvula de cierre del flujo del gas normalmente cerrada de rearme manual. Alimentación 230 V CA. Conexiones hembra-hembra.

Code	Size	Max inlet pressure	Price	Class	Packaging
590083	DN 15	0.50 bar	167,64 €	ZF	1
590064	DN 20	0.50 bar	174,44 €	ZF	1
590084	DN 25	0.50 bar	202,96 €	ZF	1
590085	DN 15	6 bar	170,45 €	ZF	1
590086	DN 20	6 bar	170,45 €	ZF	1
590087	DN 25	6 bar	205,76 €	ZF	1

EVG 01

- Elettrovalvola di intercettazione flusso gas normalmente aperta a riarmo manuale. Alimentazione 230 VAC. Connessioni femmina-femmina.
- Gas flow isolation solenoid valve normally open with manual reset. 230 VAC power supply. Female-female connections.
- Électrovanne d'arrêt du flux de gaz normalement ouverte à réenclenchement manuel. Alimentation 230 VAC. Connexions femelle-femelle.
- Magnet-Absperrventil für Gas, normal geöffnet mit manueller Rückstellrichtung. Versorgung 230 VAC. Anschlüsse mit Innengewinde.
- Electroválvula de cierre del flujo de gas normalmente abierta de rearme manual. Alimentación 230 V CA. Conexiones hembra-hembra.

Code	Size	Max inlet pressure	Price	Class	Packaging
590088	DN 15	0.50 bar	97,00 €	ZF	1
590089	DN 20	0.50 bar	97,00 €	ZF	1
590090	DN 25	0.50 bar	138,43 €	ZF	1
590091	DN 15	6 bar	123,92 €	ZF	1
590092	DN 20	6 bar	123,92 €	ZF	1
590093	DN 25	6 bar	161,03 €	ZF	1

FMC

- Filtro compact per gas con presa di pressione.
- Compact filter for gas with pressure socket.
- Filtre compact pour gaz avec prise de pression.
- Filter kompakt für Gas mit Druckanschluss.
- Filtro compacto para gas con toma de presión.

Code	Size	Max inlet pressure	Filtration capacity	Price	Class	Packaging
FMC02SC	DN 15	2 bar	50 µm	31,87 €	ZF	30
FMC03SC	DN 20	2 bar	50 µm	31,87 €	ZF	30
FMC04SC	DN 25	2 bar	50 µm	31,87 €	ZF	30

VST 00



- Valvola ad angolo con dispositivo di sicurezza termica
- Angle valve with thermal safety device
- Vanne à angle avec dispositif de sécurité thermique
- Eckventil mit thermischer Absperrreinheit
- Válvula angular con dispositivo de seguridad térmica

Code	Size	Color	Price	Class	Packaging
590063	1/2" M x 1/2" M	■	46,79 €	ZF	1



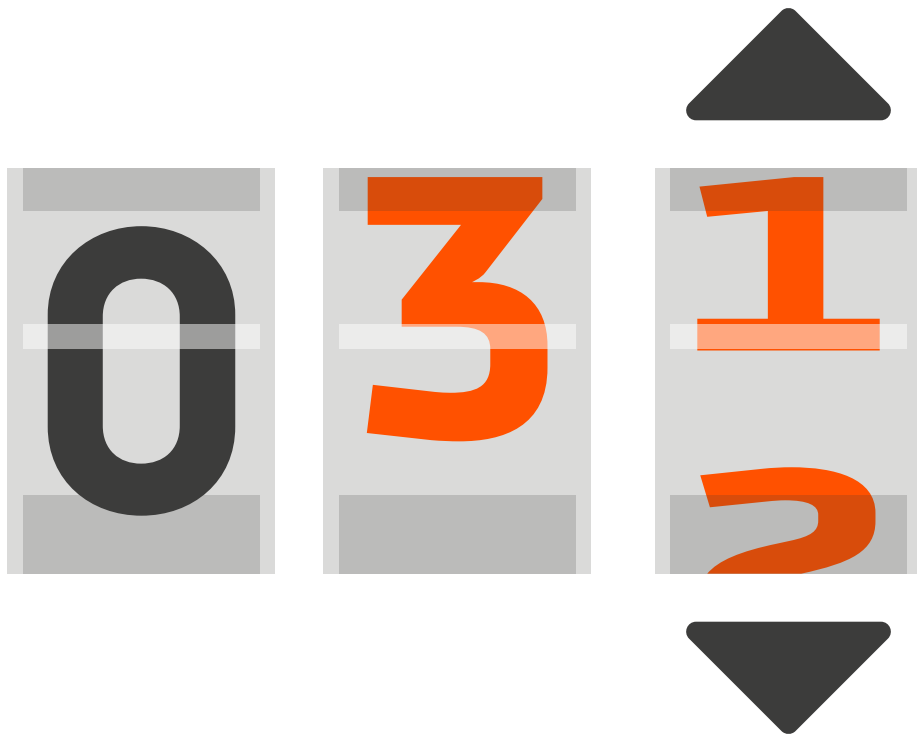

METERING SYSTEMS



pim.ivar-group.com/short/IT-11

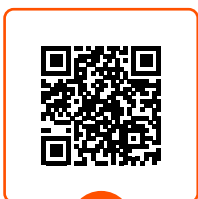

DOWNLOAD
Focus tecnici



pim.ivar-group.com/short/FR-11

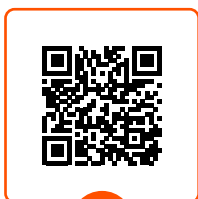

DOWNLOAD
Détails techniques



pim.ivar-group.com/short/DE-11

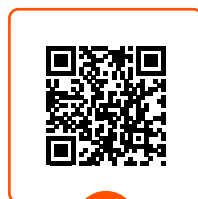

DOWNLOAD
Technische Details



pim.ivar-group.com/short/ES-11





DOWNLOAD
Profundizaciones técnicas

In apartment buildings characterised by a single heat generator, current energy-saving standards make it mandatory to apply thermoregulation and heat metering systems which give the individual users management autonomy, and at the same time to correctly allocate heat costs among residents.

For horizontal loop distribution systems (a), IVAR proposes user modules for direct heat metering by means of meters. User modules are units developed for direct metering of heat and DHW which include a wide range of functions to control the heating system: a zone valve, a filter, shut-off and balancing valves. Both solutions with three-way zone valve for fixed flow rate systems and two-way zone valves for variable flow rate systems are available. For satellite modules please look the at the dedicated section.

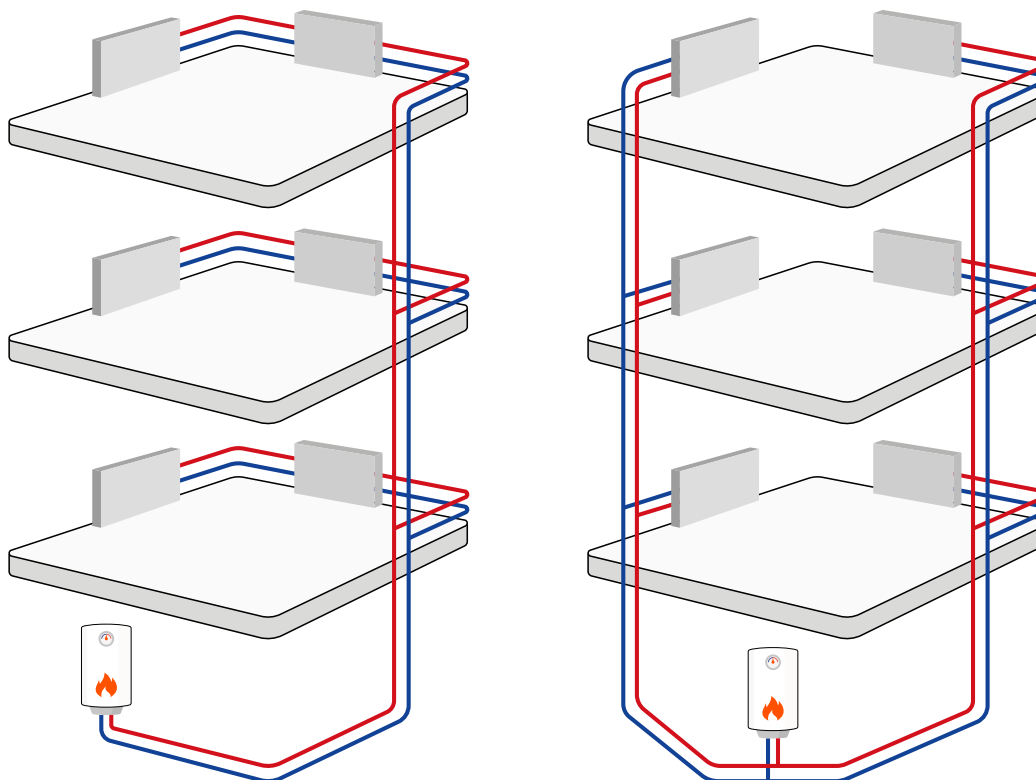
On the other hand, the offer for vertical distribution systems (b) is based on indirect metering devices with heat cost allocators.



	<p>Moduli a 3 vie per la contabilizzazione diretta EQUIMETER e MC <i>3-way modules for direct metering EQUIMETER and MC</i></p> <p>Modules à 3 voies pour la comptabilisation directe EQUIMETER et MC <i>3-Wege-Module zur Direkten Messung EQUIMETER und MC</i></p> <p>Módulos de 3 vías para la contabilización directa EQUIMETER y MC</p>	472
	<p>Moduli a 2 vie per la contabilizzazione diretta EQUICOMPACT®, EQUIDYNAMIC e MC4 <i>2-way modules for direct metering EQUICOMPACT®, EQUIDYNAMIC and MC4</i></p> <p>Modules à 2 voies pour la comptabilisation directe EQUICOMPACT®, EQUIDYNAMIC et MC4 <i>2-Wege-Module zur Direkten Messung EQUICOMPACT®, EQUIDYNAMIC und MC4</i></p> <p>Módulos de 2 vías para la contabilización directa EQUICOMPACT®, EQUIDYNAMIC y MC4</p>	482
	<p>Moduli per la contabilizzazione diretta dell'acqua sanitaria <i>Modules for domestic water direct metering</i></p> <p>Modules pour la comptabilisation directe de l'eau sanitaire <i>Module zur Direkten Messung von Trinkwasser</i></p> <p>Módulos para la contabilización directa del agua sanitaria</p>	494
	<p>Moduli di contabilizzazione diretta per applicazioni speciali <i>Direct metering modules for special applications</i></p> <p>Modules de comptabilisation directe pour des applications spéciales <i>Module zur Direkten Messung für Spezielle Anwendungen</i></p> <p>Módulos de contabilización directa para aplicaciones especiales</p>	495
	<p>Accessori per moduli di contabilizzazione diretta <i>Accessories for direct metering modules</i></p> <p>Accessoires pour modules de comptabilisation directe <i>Zubehör für Module zur Direkten Messung</i></p> <p>Accesorios para módulos de contabilización directa</p>	502
	<p>Contatori per la contabilizzazione diretta <i>Meters for direct metering</i></p> <p>Compteurs pour la comptabilisation directe <i>Zähler für Direkte Messung</i></p> <p>Contadores para la contabilización directa</p>	504
	<p>Sistema CALOR•MET per la contabilizzazione indiretta del calore <i>CALOR•MET system for heat indirect metering</i></p> <p>Système CALOR•MET pour la comptabilisation indirecte de la chaleur <i>System CALOR•MET zur Indirekten Messung von Wärme</i></p> <p>Sistema CALOR•MET para la contabilización indirecta de calor</p>	511
	<p>Dispositivi per centralizzazione dati <i>Devices for data centralisation</i></p> <p>Dispositifs pour la centralisation des données <i>Vorrichtungen zur Datenzentralisierung</i></p> <p>Dispositivos para centralizar los datos</p>	518

3-WAY MODULES

EQUIMETER

EQUIMETER is a compact three-way metering module which offers the option to regulate both supply and by-pass section by exploiting the flow reading of the heat meter, simplifying hydraulic balancing operations. Available in two power/flow rate variants, it houses a 1.5 m³/h or 2.5 m³/h heat meter, while still keeping the main G 3/4" flat seal connections to the upright columns and to the utilities. DHW lines are customisable and allow up to three displacement meters to be installed, or up to two by adding a thermostatic mixing valve. EQUIMETER are supplied on a frame, pre-assembled or in a jig with separate components. The cabinet and all the electronic components are supplied separately; electronic devices are chosen depending on the individual installations thanks to a complete range of meters for direct reading on individual devices or concentration of data at a single reading point by means of M-BUS or RADIO protocol.

EQUIMETER power (*) with Kv=2.25: approximately 14 kW

EQUIMETER power (*) with Kv=2.75: approximately 17 kW

(*) Thermal gradient = 10 °C; differential pressure at ends of module = 300 mbar

MC

MC is a classical pre-assembled module intended to meet high flow rate requirements thanks to the low hydraulic resistance of the circuit. MC is available in two power/flow rate variants, with different corresponding connections to the upright columns and to the utilities: MC1 has G 1" connections and can house heat meters from 2.5 m³/h. MC2 is equipped with G 1" 1/4 connections and can house larger meters with G 1" 1/4 connections and a nominal flow rate of 3.5 or 6.0 m³/h. In this case again the DHW lines are customisable and allow up to three displacement meters to be installed, or up to two with thermostatic mixing valve. Heat module and DHW module are on different frames and can be built according to requirements. The cabinet and all the electronic components are supplied separately; electronic devices are chosen depending on the individual installations thanks to a complete range of meters for direct reading on individual devices or concentration of data at a single reading point by means of M-BUS or RADIO protocol.

MC power (*) with Kv=3.5: approximately 22 kW

MC power (*) with Kv=7.0(**): approximately 35 kW

(*) Thermal gradient = 10 °C; differential pressure at ends of module = 300 mbar

(**) Kv=7.0 is supplied with ultrasound meter application with nominal flow rate of 6.0 m³/h

PLUS (EQUIMETER)

- **Freely configurable with volumetric meters for DHW, DCW and dual water**
- **Simplified and patented procedure for balancing utilities**
- **Connections to utilities with 3/4" flat-seal fittings for all versions**
- **Pre-assembled or in a template with separate components**

EQUIMETER

DOMESTIC WATER LINES

Customizable with no, 1, 2 or 3 meters

Available with 2 domestic water lines and anti-scald thermostatic mixer

CONTROL BLOCK

3-Way zone valve with piston

Well for delivery heat meter probe

Inlet and bypass balancing valves

Components can be cut off with ball valves

Thermally insulated heat block

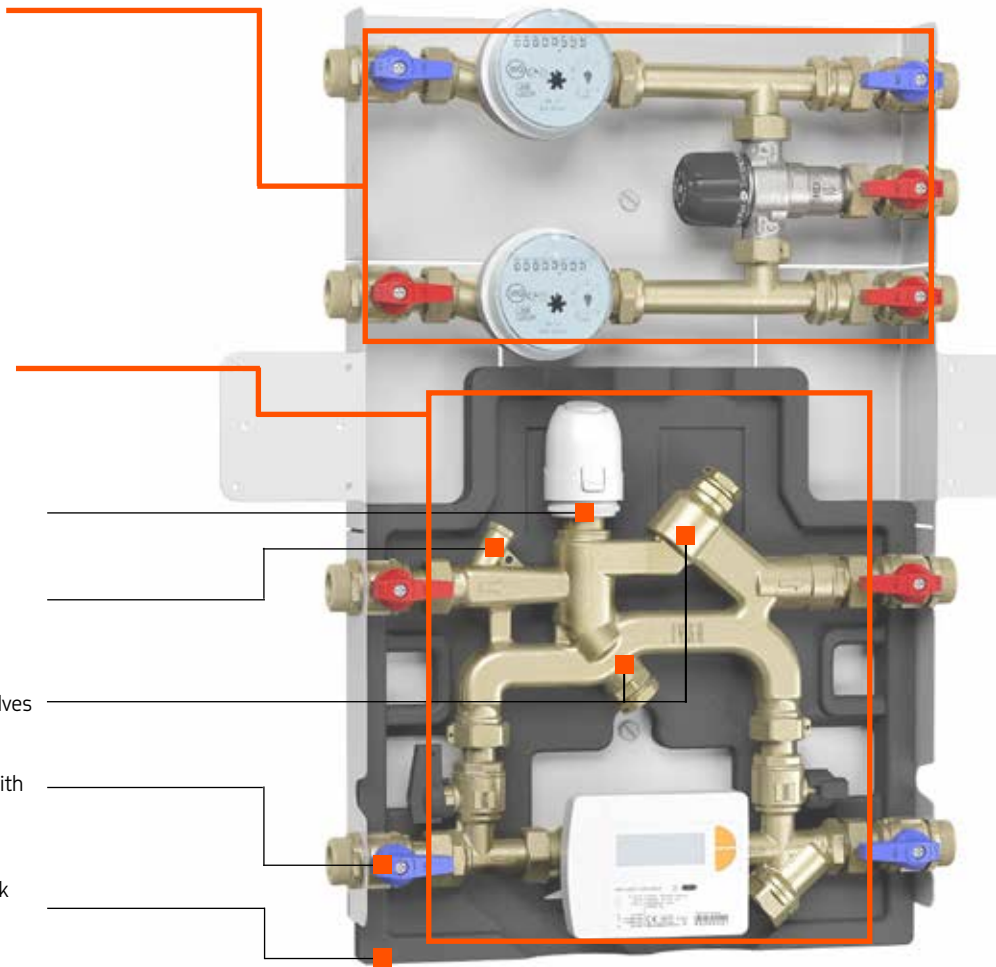

PATENTED SYSTEM

“In-line” balancing with instantaneous flow rate reading on the meter **both in delivery** (fig. 1) **and in bypass** (balancing and operation, fig. 2 and 3).

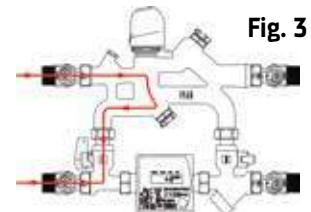
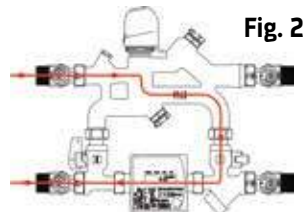
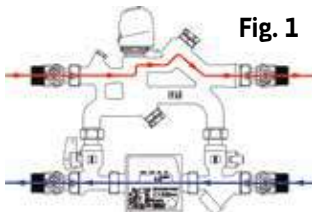

KEY FOR METERING UNITS

Heating units.

Domestic cold water units.

Domestic hot water units.

Thermostatic mixer.

■ EQM1 (Kv 2,25) - EQM2 (Kv 2,75)

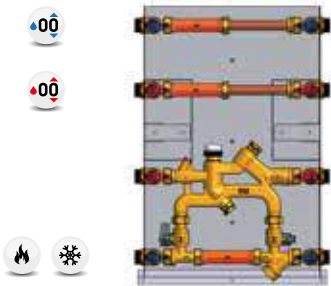

- Modulo di contabilizzazione Equimeter per impianti di riscaldamento e raffrescamento con unità per calore, acqua calda sanitaria e acqua fredda sanitaria
- Equimeter metering module for heating and cooling systems with units for heat, domestic hot water and domestic cold water
- Module de comptabilisation Equimeter pour les systèmes de chauffage et de refroidissement avec unités pour chaleur, eau chaude sanitaire et eau froide sanitaire
- Messungsmodul Equimeter für Heiz- und Kühlsysteme mit Einheiten für Wärme, Trinkwarmwasser und Trinkkaltwasser
- Módulo de contabilización Equimeter para sistemas de calefacción y refrigeración con unidades para calor, agua caliente sanitaria y agua fría sanitaria

Code	Heat unit	Domestic water units	Suitable Cabinet	Cabinet width	Price	Class	Packaging
506370	Kv 2,25 (Qn 1,5 m³/h) - G 3/4"	HOT+COLD (Q3 2,5 m³/h) - G 3/4"	200085	550 mm	591,66 €	UA	1
506371	Kv 2,75 (Qn 2,5 m³/h) - G 3/4"	HOT+COLD (Q3 2,5 m³/h) - G 3/4"	200085	550 mm	626,98 €	UA	1

■ EQM11 (Kv 2,25) - EQM21 (Kv 2,75)

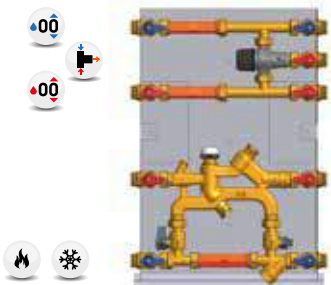

- Modulo di contabilizzazione Equimeter per impianti di riscaldamento e raffrescamento con unità per calore, acqua calda sanitaria, acqua fredda sanitaria e miscelatore termostatico
- Equimeter metering module for heating and cooling systems with units for heat, domestic hot water, domestic cold water and thermostatic mixer
- Module de comptabilisation Equimeter pour les systèmes de chauffage et de refroidissement avec unités pour chaleur, eau chaude sanitaire, eau froide sanitaire et limiteur de température
- Messungsmodul Equimeter für Heiz- und Kühlsysteme mit Einheiten für Wärme, Trinkwarmwasser, Trinkkaltwasser und thermostatischem Mischer
- Módulo de contabilización Equimeter para sistemas de calefacción y refrigeración con unidades para calor, agua caliente sanitaria, agua fría sanitaria y mezclador termostático

Code	Heat unit	Domestic water units	Suitable Cabinet	Cabinet width	Price	Class	Packaging
506372	Kv 2,25 (Qn 1,5 m³/h) - G 3/4"	HOT+COLD (Q3 2,5 m³/h) + MIX - G 3/4"	200085	550 mm	685,41 €	UA	1
506373	Kv 2,75 (Qn 2,5 m³/h) - G 3/4"	HOT+COLD (Q3 2,5 m³/h) + MIX - G 3/4"	200085	550 mm	698,63 €	UA	1

■ EQM12 (Kv 2,25) - EQM22 (Kv 2,75)

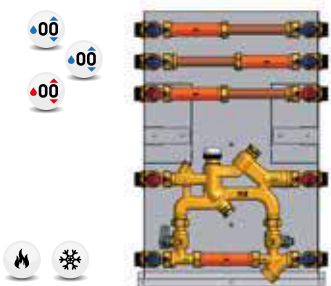

- Modulo di contabilizzazione Equimeter per impianti di riscaldamento e raffrescamento con unità per calore, acqua calda sanitaria, acqua fredda sanitaria e acqua fredda duale
- Equimeter metering module for heating and cooling systems with units for heat, domestic hot water, domestic cold water and dual cold water
- Module de comptabilisation Equimeter pour les systèmes de chauffage et de refroidissement avec unités pour chaleur, eau chaude sanitaire, eau froide sanitaire et eau froide duale
- Messungsmodul Equimeter für Heiz- und Kühlsysteme mit Einheiten für Wärme, Trinkwarmwasser, Trinkkaltwasser und Dualkaltwasser
- Módulo de contabilización Equimeter para sistemas de calefacción y refrigeración con unidades para calor, agua caliente sanitaria, agua fría sanitaria y agua fría dual

Code	Heat unit	Domestic water units	Suitable Cabinet	Cabinet width	Price	Class	Packaging
506374	Kv 2,25 (Qn 1,5 m³/h) - G 3/4"	HOT+COLD+DUAL (Q3 2,5 m³/h) - G 3/4"	200085	550 mm	642,24 €	UA	1
506375	Kv 2,75 (Qn 2,5 m³/h) - G 3/4"	HOT+COLD+DUAL (Q3 2,5 m³/h) - G 3/4"	200085	550 mm	663,56 €	UA	1



• >> p. 503



• >> p. 504



• >> p. 506



• Radio WALK-BY >> p. 523



• Radio AMR >> p. 522

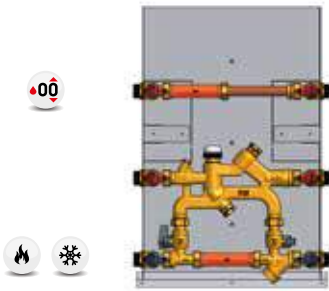

• M-BUS >> p. 519

EQM13 (Kv 2,25) - EQM23 (Kv 2,75)

- Modulo di contabilizzazione Equimeter per impianti di riscaldamento e raffrescamento con unità per calore e acqua calda sanitaria
- Equimeter metering module for heating and cooling systems with units for heat and domestic hot water
- Module de comptabilisation Equimeter pour les systèmes de chauffage et de refroidissement avec unités pour chaleur et eau chaude sanitaire
- Messungsmodul Equimeter für Heiz- und Kühlsysteme mit Einheiten für Wärme und Trinkwarmwasser
- Módulo de contabilización Equimeter para sistemas de calefacción y refrigeración con unidades para calor y agua caliente sanitaria

Code	Heat unit	Domestic water units	Suitable Cabinet	Cabinet width	Price	Class	Packaging
506376	Kv 2,25 (Qn 1,5 m³/h) - G 3/4"	HOT (Q3 2,5 m³/h) - G 3/4"	200085	550 mm	531,72 €	UA	1
506377	Kv 2,75 (Qn 2,5 m³/h) - G 3/4"	HOT (Q3 2,5 m³/h) - G 3/4"	200085	550 mm	553,06 €	UA	1

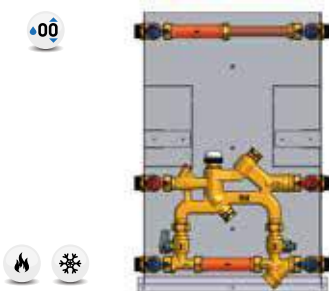
EQM14 (Kv 2,25) - EQM24 (Kv 2,75)

- Modulo di contabilizzazione Equimeter per impianti di riscaldamento e raffrescamento con unità per calore e acqua fredda sanitaria
- Equimeter metering module for heating and cooling systems with units for heat and domestic cold water
- Module de comptabilisation Equimeter pour les systèmes de chauffage et de refroidissement Equimeter avec unités pour chaleur et eau froide sanitaire
- Messungsmodul Equimeter für Heiz- und Kühlsysteme mit Einheiten für Wärme und Trinkkaltwasser
- Módulo de contabilización Equimeter para sistemas de calefacción y refrigeración con unidades para calor y agua fría sanitaria

Code	Heat unit	Domestic water units	Suitable Cabinet	Cabinet width	Price	Class	Packaging
506378	Kv 2,25 (Qn 1,5 m³/h) - G 3/4"	COLD (Q3 2,5 m³/h) - G 3/4"	200085	550 mm	529,61 €	UA	1
506379	Kv 2,75 (Qn 2,5 m³/h) - G 3/4"	COLD (Q3 2,5 m³/h) - G 3/4"	200085	550 mm	550,91 €	UA	1

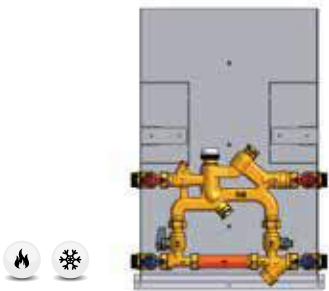
EQM15 (Kv 2,25) - EQM25 (Kv 2,75)

- Modulo di contabilizzazione Equimeter per impianti di riscaldamento e raffrescamento solo con unità per il calore
- Equimeter metering module for heating and cooling systems with unit for heat only
- Module de comptabilisation Equimeter pour les systèmes de chauffage et de refroidissement uniquement avec unité pour la chaleur
- Messungsmodul Equimeter für Heiz- und Kühlsysteme nur mit Einheit für Wärme
- Módulo de contabilización Equimeter para sistemas de calefacción y refrigeración sólo con unidad para el calor

Code	Heat unit	Suitable Cabinet	Cabinet width	Price	Class	Packaging
506380	Kv 2,25 (Qn 1,5 m³/h) - G 3/4"	200085	550 mm	454,72 €	UA	1
506381	Kv 2,75 (Qn 2,5 m³/h) - G 3/4"	200085	550 mm	495,65 €	UA	1

AC 110

- Kit sdoppiatore lato uscita per moduli Equimeter.
- Splitter fittings kit for Equimeter modules outakes.
- Kit de raccords dédoubleurs pour les sorties des modules Equimeter.
- Vertdoppler-Anschlüsse-Bausatz für die Ausgängen der Module Equimeter.
- Kit de accesorios divisores para las salidas de los módulos Equimeter.

Code	Size	Price	Class	Packaging
509131	3/4"	143,24 €	UA	1

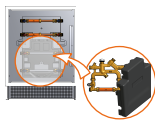

For the supply of modules in separate components (template + functional blocks) please refer to the following tables.

EQM1/2 Template



- Dima per modulo di contabilizzazione Equimeter con unità per calore, acqua calda sanitaria e acqua fredda sanitaria.
- Template for Equimeter metering module with units for heat, domestic hot water and domestic cold water.
- Gabarit pour module de comptabilisation Equimeter avec unités pour chaleur, eau chaude sanitaire et eau froide sanitaire.
- Schablone für Messungsmodul Equimeter mit Einheiten für Wärme, Trinkwarmwasser und Trinkkaltwasser.
- Plantilla para módulo de contabilización Equimeter con unidades para calor, agua caliente sanitaria y agua fría sanitaria.

Code	Suitable Cabinet	Price	Class	Packaging
509161	200085	326,50 €	UA	1

EQM11/21 Template



- Dima per modulo di contabilizzazione Equimeter con unità per calore, acqua calda sanitaria, acqua fredda sanitaria e miscelatore termostatico.
- Template for Equimeter metering module with units for heat, domestic hot water, domestic cold water and thermostatic mixer.
- Gabarit pour module de comptabilisation Equimeter avec unités pour chaleur, eau chaude sanitaire, eau froide sanitaire et limiteur de température.
- Schablone für Messungsmodul Equimeter mit Einheiten für Wärme, Trinkwarmwasser, Trinkkaltwasser und thermostatischem Mischer.
- Plantilla para módulo de contabilización Equimeter con unidades para calor, agua caliente sanitaria, agua fría sanitaria y mezclador termostático.

Code	Suitable Cabinet	Price	Class	Packaging
509162	200085	411,26 €	UA	1

EQM12/22 Template



- Dima per modulo di contabilizzazione Equimeter con unità per calore, acqua calda sanitaria, acqua fredda sanitaria e acqua fredda duale.
- Template for Equimeter metering module with units for heat, domestic hot water, domestic cold water and dual cold water.
- Gabarit pour module de comptabilisation Equimeter avec unités pour chaleur, eau chaude sanitaire, eau froide sanitaire et eau froide duale.
- Schablone für Messungsmodul Equimeter mit Einheiten für Wärme, Trinkwarmwasser, Trinkkaltwasser und Dualkaltwasser.
- Plantilla para módulo de contabilización Equimeter con unidades para calor, agua caliente sanitaria, agua fría sanitaria y agua fría dual.

Code	Suitable Cabinet	Price	Class	Packaging
509163	200085	376,01 €	UA	1

EQM13/23 Template



- Dima per modulo di contabilizzazione Equimeter con unità per calore e acqua calda sanitaria.
- Template for Equimeter metering module with units for heat and domestic hot water.
- Gabarit pour module de comptabilisation Equimeter avec unités pour chaleur et eau chaude sanitaire.
- Schablone für Messungsmodul Equimeter mit Einheiten für Wärme und Trinkwarmwasser.
- Plantilla para módulo de contabilización Equimeter con unidades para calor y agua caliente sanitaria.

Code	Suitable Cabinet	Price	Class	Packaging
509164	200085	271,03 €	UA	1

EQM14/24 Template



- Dima per modulo di contabilizzazione Equimeter con unità per calore e acqua fredda sanitaria.
- Template for Equimeter metering module with units for heat and domestic cold water.
- Gabarit pour module de comptabilisation Equimeter avec unités pour chaleur et eau froide sanitaire.
- Schablone für Messungsmodul Equimeter mit Einheiten für Wärme und Trinkkaltwasser.
- Plantilla para módulo de contabilización Equimeter con unidades para calor y agua fría sanitaria.

Code	Suitable Cabinet	Price	Class	Packaging
509165	200085	268,89 €	UA	1

EQM15/25 Template



- Dima per modulo di contabilizzazione Equimeter solo con unità per il calore.
- Template for Equimeter metering module with unit for heat only.
- Gabarit pour module de comptabilisation Equimeter uniquement avec unité pour la chaleur.
- Schablone für Messungsmodul Equimeter nur mit Einheit für Wärme.
- Plantilla para módulo de contabilización Equimeter sólo con unidad para el calor.

Code	Suitable Cabinet	Price	Class	Packaging
509166	200085	213,65 €	UA	1



>>p. 503

EQM1 Complementary module

- Modulo complementare per EQUIMETER (Kv 2,25).
- Complementary module for EQUIMETER (Kv 2,25).
- Module complémentaire pour EQUIMETER (Kv 2,25).
- Ergänzungsmodul für EQUIMETER (Kv 2,25).
- Módulo complementario para EQUIMETER (Kv 2,25).

Code	Heat unit	Price	Class	Packaging
KSB0028	Kv 2,25 (Qn 1,5 m³/h) - G 3/4"	318,83 €	UA	1

EQM2 Complementary module

- Modulo complementare per EQUIMETER (Kv 2,75).
- Complementary module for EQUIMETER (Kv 2,75).
- Module complémentaire pour EQUIMETER (Kv 2,75).
- Ergänzungsmodul für EQUIMETER (Kv 2,75).
- Módulo complementario para EQUIMETER (Kv 2,75).

Code	Heat unit	Price	Class	Packaging
KSB0033	Kv 2,75 (Qn 2,5 m³/h) - G 3/4"	322,08 €	UA	1

TE 3040 IV

- Testa elettrotermica normalmente chiusa (2 fili). Compatibile con tutti i vitoni termostattizzabili IVAR e i collettori con interasse ≥ 40 mm.
- Electrothermal head normally closed (2 wires). Suitable for all IVAR thermostatic inserts and manifolds with centre-to-centre distance ≥ 40 mm.
- Tête électrothermique normalement fermée (2 fils). Adaptée pour tous les inserts thermostatisables IVAR et aux collecteurs avec entraxe ≥ 40 mm.
- Elektrothermischer Stellantrieb stromlos-zu (2 Kabel). Geeignet für alle Thermostat-Regulievorrichtungen IVAR und für Verteiler mit Achsabstand ≥ 40 mm.
- Cabeza electrotérmica normalmente cerrada (de 2 hilos). Adecuada para todos los tornillos termostatisables IVAR y los colectores con distancia entre centros ≥ 40 mm.

Code	Size	Price	Class	Packaging
501508E	M30 x 1,5 ; ON / OFF (230 V AC)	29,64 €	AC	100

TE 3040

- Testa elettrotermica normalmente chiusa (2 fili). Compatibile con tutti i vitoni termostattizzabili IVAR e i collettori con interasse ≥ 50 mm (no EASY-RADIANT).
- Electrothermal head normally closed (2 wires). Suitable for all IVAR thermostatic inserts and manifolds with centre-to-centre distance ≥ 50 mm (no EASY-RADIANT).
- Tête électrothermique normalement fermée (2 fils). Adaptée pour tous les inserts thermostatisables IVAR et aux collecteurs avec entraxe ≥ 50 mm (non EASY-RADIANT).
- Elektrothermischer Stellantrieb stromlos-zu (2 Kabel). Geeignet für alle Thermostat-Regulievorrichtungen IVAR und für Verteiler mit Achsabstand ≥ 50 mm (keine EASY-RADIANT).
- Cabeza electrotérmica normalmente cerrada (de 2 hilos). Adecuada para todos los tornillos termostatisables IVAR y los colectores con distancia entre centros ≥ 50 mm (no EASY-RADIANT).

Code	Size	Price	Class	Packaging
501508	M30 x 1,5 ; ON / OFF (230 V AC)	36,60 €	AC	100
501524	M30 x 1,5 ; ON / OFF (24 V AC/DC)	36,60 €	AC	100

TE 3050 MC

- Testa elettrotermica normalmente chiusa con contatto di fine corsa (4 fili). Compatibile con tutti i vitoni termostattizzabili IVAR e i collettori con interasse ≥ 40 mm.
- Electrothermal head normally closed with limit switch contact (4 wires). Suitable for all IVAR thermostatic inserts and manifolds with centre-to-centre distance ≥ 40 mm.
- Tête électrothermique normalement fermée avec contact de fin de course (4 fils). Adaptée pour tous les inserts thermostatisables IVAR et aux collecteurs avec entraxe ≥ 40 mm.
- Elektrothermischer Stellantrieb stromlos-zu mit Endschalterkontakt (4 Kabel). Geeignet für alle Thermostat-Regulievorrichtungen IVAR und für Verteiler mit Achsabstand ≥ 40 mm.
- Cabeza electrotérmica normalmente cerrada con contacto de fin de carrera (de 4 hilos). Adecuada para todos los tornillos termostatisables IVAR y los colectores con distancia entre centros ≥ 40 mm.

Code	Size	Price	Class	Packaging
500808MC	M30 x 1,5 ; ON / OFF (230 V AC)	43,43 €	AC	100

TE 3050 M

- Testa elettrotermica normalmente chiusa con contatto di fine corsa (4 fili). Compatibile con tutti i vitoni termostattizzabili IVAR e i collettori con interasse ≥ 50 mm (no EASY-RADIANT).
- Electrothermal head normally closed with limit switch contact (4 wires). Suitable for all IVAR thermostatic inserts and manifolds with centre-to-centre distance ≥ 50 mm (no EASY-RADIANT).
- Tête électrothermique normalement fermée avec contact de fin de course (4 fils). Adaptée pour tous les inserts thermostatisables IVAR et aux collecteurs avec entraxe ≥ 50 mm (non EASY-RADIANT).
- Elektrothermischer Stellantrieb stromlos-zu mit Endschalterkontakt (4 Kabel). Geeignet für alle Thermostat-Regulievorrichtungen IVAR und für Verteiler mit Achsabstand ≥ 50 mm (keine EASY-RADIANT).
- Cabeza electrotérmica normalmente cerrada con contacto de fin de carrera (de 4 hilos). Adecuada para todos los tornillos termostatisables IVAR y los colectores con distancia entre centros ≥ 50 mm (no EASY-RADIANT).

Code	Size	Price	Class	Packaging
500808M	M30 x 1,5 ; ON / OFF (230 V AC)	43,43 €	AC	100
500028M	M30 x 1,5 ; ON / OFF (24 V AC/DC)	43,43 €	AC	100

MC1 (Kv 3,50) - MC2 (Kv 7,00)

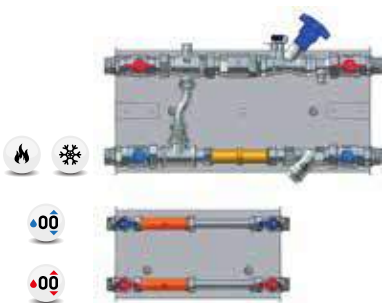

- Modulo di contabilizzazione MC1/MC2 per impianti di riscaldamento e raffrescamento con unità per calore, acqua calda sanitaria e acqua fredda sanitaria
- MC1/MC2 metering module for heating and cooling systems with units for heat, domestic hot water and domestic cold water
- Module de comptabilisation MC1/MC2 pour les systèmes de chauffage et de refroidissement avec unités pour chaleur, eau chaude sanitaire et eau froide sanitaire
- Messungsmodul MC1/MC2 für Heiz- und Kühlsysteme mit Einheiten für Wärme, Trinkwarmwasser und Trinkkaltwasser
- Módulo de contabilización MC1/MC2 para sistemas de calefacción y refrigeración con unidades para calor, agua caliente sanitaria y agua fría sanitaria

Code	Heat unit	Domestic water units	Suitable Cabinet	Cabinet width	Price	Class	Packaging
506500	Kv 3,50 (Qn 2,5 m³/h) - G 1"	HOT+COLD (Q3 2,5 m³/h) - G 3/4"	200090	700 mm	876,90 €	UA	1
506501	Kv 3,50 (Qn 2,5 m³/h) - G 1"	HOT+COLD (Q3 4 m³/h) - G 1"	200090	700 mm	972,77 €	UA	1
506510	Kv 7,00 (Qn 3,5 - 6 m³/h) - G 1"1/4	HOT+COLD (Q3 2,5 m³/h) - G 3/4"	200190	900 mm	918,14 €	UA	1
506511	Kv 7,00 (Qn 3,5 - 6 m³/h) - G 1"1/4	HOT+COLD (Q3 4 m³/h) - G 1"	200190	900 mm	1.013,97 €	UA	1

MC11 (Kv 3,50) - MC21 (Kv 7,00)

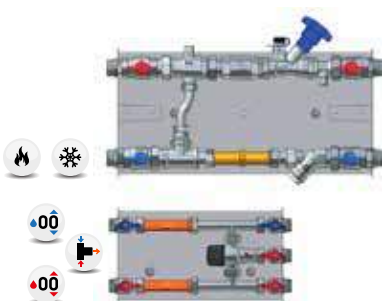

- Modulo di contabilizzazione MC1/MC2 per impianti di riscaldamento e raffrescamento con unità per calore, acqua calda sanitaria, acqua fredda sanitaria e miscelatore termostatico
- MC1/MC2 metering module for heating and cooling systems with units for heat, domestic hot water, domestic cold water and thermostatic mixer
- Module de comptabilisation MC1/MC2 pour les systèmes de chauffage et de refroidissement avec unités pour chaleur, eau chaude sanitaire, eau froide sanitaire et limiteur de température
- Messungsmodul MC1/MC2 für Heiz- und Kühlsysteme mit Einheiten für Wärme, Trinkwarmwasser, Trinkkaltwasser und thermostatischem Mischer
- Módulo de contabilización MC1/MC2 para sistemas de calefacción y refrigeración con unidades para calor, agua caliente sanitaria, agua fría sanitaria y mezclador termostático

Code	Heat unit	Domestic water units	Suitable Cabinet	Cabinet width	Price	Class	Packaging
506502	Kv 3,50 (Qn 2,5 m³/h) - G 1"	HOT+COLD (Q3 2,5 m³/h) + MIX - G 3/4"	200090	700 mm	952,74 €	UA	1
506512	Kv 7,00 (Qn 3,5 - 6 m³/h) - G 1"1/4	HOT+COLD (Q3 2,5 m³/h) + MIX - G 3/4"	200190	900 mm	993,97 €	UA	1

MC12 (Kv 3,50) - MC22 (Kv 7,00)

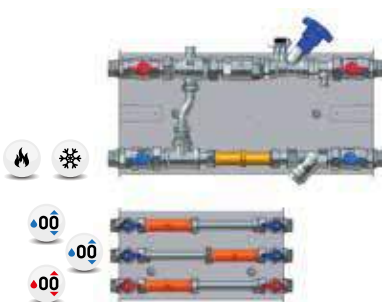

- Modulo di contabilizzazione MC1/MC2 per impianti di riscaldamento e raffrescamento con unità per calore, acqua calda sanitaria, acqua fredda sanitaria e acqua fredda duale
- MC1/MC2 metering module for heating and cooling systems with units for heat, domestic hot water, domestic cold water and dual cold water
- Module de comptabilisation MC1/MC2 pour les systèmes de chauffage et de refroidissement avec unités pour chaleur, eau chaude sanitaire, eau froide sanitaire et eau froide duale
- Messungsmodul MC1/MC2 für Heiz- und Kühlsysteme mit Einheiten für Wärme, Trinkwarmwasser, Trinkkaltwasser und Dualkaltwasser
- Módulo de contabilización MC1/MC2 para sistemas de calefacción y refrigeración con unidades para calor, agua caliente sanitaria, agua fría sanitaria y agua fría dual

Code	Heat unit	Domestic water units	Suitable Cabinet	Cabinet width	Price	Class	Packaging
506503	Kv 3,50 (Qn 2,5 m³/h) - G 1"	HOT+COLD+DUAL (Q3 2,5 m³/h) - G 3/4"	200090	700 mm	921,99 €	UA	1
506504	Kv 3,50 (Qn 2,5 m³/h) - G 1"	HOT+COLD+DUAL (Q3 4 m³/h) - G 1"	200090	700 mm	1.077,43 €	UA	1
506513	Kv 7,00 (Qn 3,5 - 6 m³/h) - G 1"1/4	HOT+COLD+DUAL (Q3 2,5 m³/h) - G 3/4"	200190	900 mm	963,21 €	UA	1
506514	Kv 7,00 (Qn 3,5 - 6 m³/h) - G 1"1/4	HOT+COLD+DUAL (Q3 4 m³/h) - G 1"	200190	900 mm	1.118,65 €	UA	1

• Su richiesta sono disponibili moduli MC DN 40 e DN 50.
 • DN 40 and DN 50 MC modules are available on request.
 • Modules MC DN 40 et DN 50 sont disponibles sur demande.
 • MC-Module DN 40 und DN 50 sind auf Anfrage erhältlich.
 • Módulos MC DN 40 y DN 50 están disponibles bajo petición.

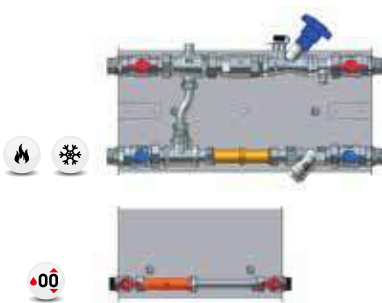
MC13 (Kv 3,50) - MC23 (Kv 7,00)

- Modulo di contabilizzazione MC1/MC2 per impianti di riscaldamento e raffrescamento con unità per calore e acqua calda sanitaria
- MC1/MC2 metering module for heating and cooling systems with units for heat and domestic hot water
- Module de comptabilisation MC1/MC2 pour les systèmes de chauffage et de refroidissement avec unités pour chaleur et eau chaude sanitaire
- Messungsmodul MC1/MC2 für Heiz- und Kühlsysteme mit Einheiten für Wärme und Trinkwarmwasser
- Módulo de contabilización MC1/MC2 para sistemas de calefacción y refrigeración con unidades para calor y agua caliente sanitaria

Code	Heat unit	Domestic water units	Suitable Cabinet	Cabinet width	Price	Class	Packaging
506505	Kv 3,50 (Qn 2,5 m³/h) - G 1"	HOT (Q3 2,5 m³/h) - G 3/4"	200090	700 mm	807,16 €	UA	1
506506	Kv 3,50 (Qn 2,5 m³/h) - G 1"	HOT (Q3 4 m³/h) - G 1"	200090	700 mm	859,46 €	UA	1
506515	Kv 7,00 (Qn 3,5 - 6 m³/h) - G 1"1/4	HOT (Q3 2,5 m³/h) - G 3/4"	200190	900 mm	848,37 €	UA	1
506516	Kv 7,00 (Qn 3,5 - 6 m³/h) - G 1"1/4	HOT (Q3 4 m³/h) - G 1"	200190	900 mm	900,68 €	UA	1

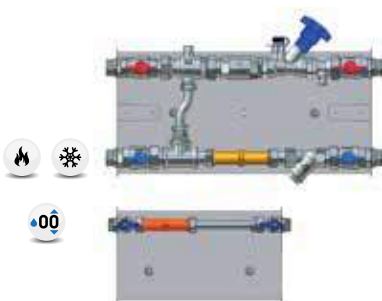
MC14 (Kv 3,50) - MC24 (Kv 7,00)

- Modulo di contabilizzazione MC1/MC2 per impianti di riscaldamento e raffrescamento con unità per calore e acqua fredda sanitaria
- MC1/MC2 metering module for heating and cooling systems with units for heat and domestic cold water
- Module de comptabilisation MC1/MC2 pour les systèmes de chauffage et de refroidissement avec unités pour chaleur et eau froide sanitaire
- Messungsmodul MC1/MC2 für Heiz- und Kühlsysteme mit Einheiten für Wärme und Trinkkaltwasser
- Módulo de contabilización MC1/MC2 para sistemas de calefacción y refrigeración con unidades para calor y agua fría sanitaria

Code	Heat unit	Domestic water units	Suitable Cabinet	Cabinet width	Price	Class	Packaging
506507	Kv 3,50 (Qn 2,5 m³/h) - G 1"	COLD (Q3 2,5 m³/h) - G 3/4"	200090	700 mm	805,01 €	UA	1
506508	Kv 3,50 (Qn 2,5 m³/h) - G 1"	COLD (Q3 4 m³/h) - G 1"	200090	700 mm	859,46 €	UA	1
506517	Kv 7,00 (Qn 3,5 - 6 m³/h) - G 1"1/4	COLD (Q3 2,5 m³/h) - G 3/4"	200190	900 mm	846,23 €	UA	1
506518	Kv 7,00 (Qn 3,5 - 6 m³/h) - G 1"1/4	COLD (Q3 4 m³/h) - G 1"	200190	900 mm	900,68 €	UA	1

MC15 (Kv 3,50) - MC25 (Kv 7,00)

- Modulo di contabilizzazione MC1/MC2 per impianti di riscaldamento e raffrescamento solo con unità per il calore
- MC1/MC2 metering module for heating and cooling systems with unit for heat only
- Module de comptabilisation pour les systèmes de chauffage et de refroidissement MC1/MC2 uniquement avec unité pour la chaleur
- Messungsmodul MC1/MC2 für Heiz- und Kühlsysteme nur mit Einheit für Wärme
- Módulo de contabilización MC1/MC2 para sistemas de calefacción y refrigeración sólo con unidad para el calor

Code	Heat unit	Suitable Cabinet	Cabinet width	Price	Class	Packaging
506509	Kv 3,50 (Qn 2,5 m³/h) - G 1"	200090	700 mm	723,12 €	UA	1
506519	Kv 7,00 (Qn 3,5 - 6 m³/h) - G 1"1/4	200190	900 mm	760,16 €	UA	1



• >> p. 204,316,396,503



• >> p. 504



• >> p. 506



• Radio WALK-BY >> p. 523



• Radio AMR >> p. 522



• M-BUS >> p. 519

- Su richiesta sono disponibili moduli MC DN 40 e DN 50.
- DN 40 and DN 50 MC modules are available on request.
- Modules MC DN 40 et DN 50 sont disponibles sur demande.
- MC-Module DN 40 und DN 50 sind Auf Anfrage erhältlich.
- Módulos MC DN 40 y DN 50 están disponibles bajo petición.

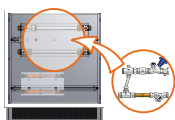

For the supply of modules in separate components (template + functional blocks) please refer to the following tables.

MC1 Template



- Dima per modulo di contabilizzazione MC1.
- Template for MC1 metering module.
- Gabarit pour module de comptabilisation MC1.
- Schablone für Messungsmodul MC1.
- Plantilla para módulo de contabilización MC1.

Code	Suitable Cabinet	Price	Class	Packaging
509167	200090	287,38 €	UA	1

- Dima per unità di contabilizzazione acqua sanitaria non inclusa.
- Template for domestic water metering units not included.
- Gabarit pour unités de comptabilisation eau sanitaire non inclus.
- Schablone für Sanitärwasserzähler nicht enthalten.
- Plantilla para unidades de contabilización de agua sanitaria no incluida.

MC2 Template



- Dima per modulo di contabilizzazione MC2.
- Template for MC2 metering module.
- Gabarit pour module de comptabilisation MC2.
- Schablone für Messungsmodul MC2.
- Plantilla para módulo de contabilización MC2.

Code	Suitable Cabinet	Price	Class	Packaging
509168	200190	322,89 €	UA	1

- Dima per unità di contabilizzazione acqua sanitaria non inclusa.
- Template for domestic water metering units not included.
- Gabarit pour unités de comptabilisation eau sanitaire non inclus.
- Schablone für Sanitärwasserzähler nicht enthalten.
- Plantilla para unidades de contabilización de agua sanitaria no incluida.

MC1 Complementary module



- Modulo complementare per MC1.
- Complementary module for MC1.
- Module complémentaire pour MC1.
- Ergänzungsmodul für MC1.
- Módulo complementario para MC1.

Code	Heat unit	Price	Class	Packaging
KSB0030	Kv 3,50 (Qn 2,5 m ³ /h) - G 1"	449,98 €	UA	1

MC2 Complementary module



- Modulo complementare per MC2.
- Complementary module for MC2.
- Module complémentaire pour MC2.
- Ergänzungsmodul für MC2.
- Módulo complementario para MC2.

Code	Heat unit	Price	Class	Packaging
KSB0032	Kv 7,00 (Qn 3,5 - 6 m ³ /h) - G 1"1/4	563,12 €	UA	1

AVZS 00

- **Servomotore per valvole di zona a sfera.**
- *Servo motor for ball zone valves.*
- **Servomoteur pour vannes de zone à bille.**
- *Stellantriebe für Zonenkugelventile.*
- **Servomotor para válvulas de zona de bola.**

Code	Size	Price	Class	Packaging
506241	230 V AC - 50 sec.	178,16 €	NN	1

AVZS 01

- **Servomotore per valvole di zona a sfera.**
- *Servo motor for ball zone valves.*
- **Servomoteur pour vannes de zone à bille.**
- *Stellantriebe für Zonenkugelventile.*
- **Servomotor para válvulas de zona de bola.**

Code	Size	Price	Class	Packaging
506241V	230 V AC - 25 sec.	188,54 €	NN	1

AVZS 10

- **Servomotore per valvole di zona a sfera con dispositivo di sblocco.**
- *Servo motor for ball zone valves with release device.*
- **Servomoteur pour les vannes de zone à bille avec dispositif de déblocage.**
- *Stellantriebe für Zonenkugelventile mit Entriegelungsvorrichtung.*
- **Servomotor para válvulas de zona de bola con dispositivo de desbloqueo.**

Code	Size	Price	Class	Packaging
506242	24 V AC - 50 sec.	190,26 €	NN	1
506243	230 V AC - 50 sec.	189,32 €	NN	2 / 8

AVZS 11

- **Servomotore per valvole di zona a sfera con dispositivo di sblocco.**
- *Servo motor for ball zone valves with release device.*
- **Servomoteur pour les vannes de zone à bille avec dispositif de déblocage.**
- *Stellantriebe für Zonenkugelventile mit Entriegelungsvorrichtung.*
- **Servomotor para válvulas de zona de bola con dispositivo de desbloqueo.**

Code	Size	Price	Class	Packaging
506242V	24 V AC - 25 sec.	192,45 €	NN	1
506243V	230 V AC - 25 sec.	190,08 €	NN	1 / 8

2-WAY MODULES

The two-way utility modules are used in plants with variable speed pump thermal power stations which reduce average flow rate circulating in the plant and obtain lower return temperatures, thus increasing the efficiency of the condensing boilers and district heating.

In this field, IVAR proposes EQUICOMPACT, EQUIDYNAMIC and MC 4.

EQUICOMPACT

EQUICOMPACT is the ultra-compact, versatile utility module with two-way zone valve, essential for heat management. Aside from the standard components of a utility module, such as ball valves, zone valve, filter and stub pipe for heat meter, EQUICOMPACT also houses the differential pressure regulator capillary for dynamic balancing of circuits. In order to meet installation site needs, EQUICOMPACT can also be supplied as installation jig and separate functional components. The measuring electronics is supplied separately with a large choice depending on the requirements of the individual installations.

EQUICOMPACT is also characterised by some variants regarding the available recessed cabinet:

- AC 860 B (supplied separately): standard version with a galvanised sheet-metal cover painted white;
- AC 860 L (supplied separately): version with sheet-metal structure and cover set up for plastering;
- AC 860 IB (included for modules with code suffix CIB): version with insulated polypropylene structure and sheet metal cover painted white.

EQUICOMPACT power (*) with Kv=2.5: approximately 16 kW

EQUICOMPACT power (*) with Kv=3.0: approximately 19 kW

(*) Thermal gradient = 10 °C; differential pressure at ends of module = 300 mbar

EQUIDYNAMIC

The EQUIDYNAMIC system is a standard module with ¼ heat metering connections with dynamic balancing. The system is supplied with shut-off valves, filter, probe holder pit on supply line and body of a PICV (Pressure independent control valve): once the system has been washed and filled, the installer applies the insert most suitable for the application, choosing between the models PICC 01, PICC 02 and PICC 03. These inserts stabilise the flow rate at the set value, thus avoiding unbalancing in the different branches of the system. For further information on the inserts, see the PICV section.

⊕ PLUS (EQUICOMPACT)

- Suitable for applications with electronic variable displacement pumps
- Prearranged for use with EQUIFLUID for dynamic balancing of utilities
- Extremely compact for installation in any compartment

TYPES OF CABINETS AVAILABLE FOR EQUICOMPACT/EQUIDYNAMIC MODULES

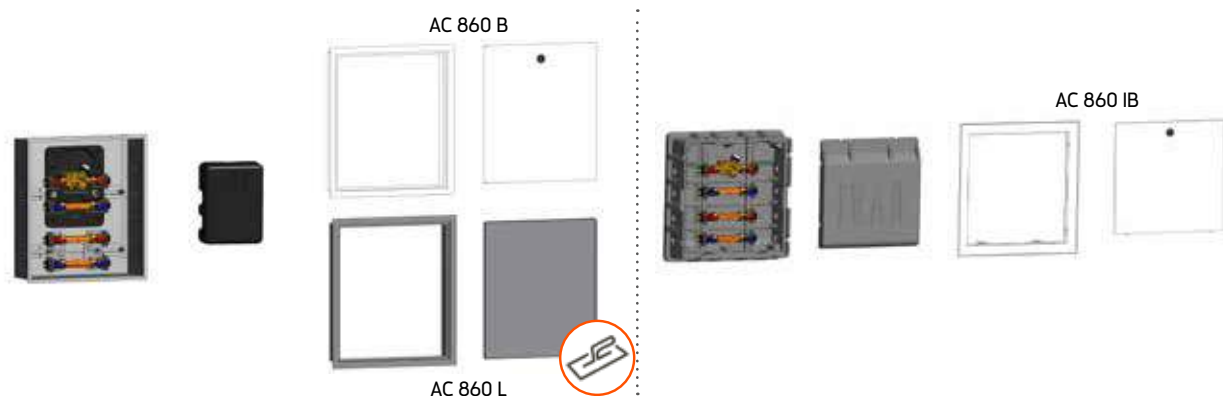

EQUICOMPACT

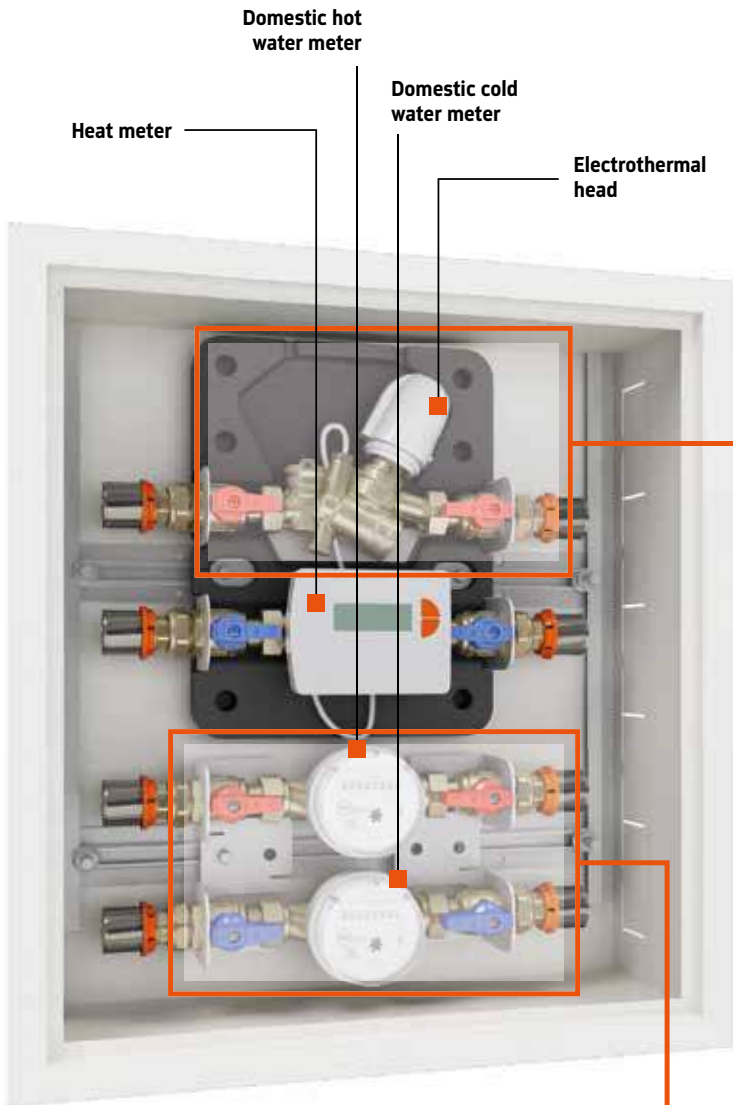

CONTROL BLOCK

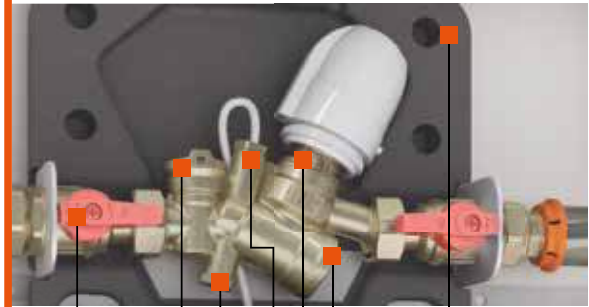

- Balancing selector** with slot for lead seal
- Well for differential pressure regulator** (to be installed on the return line)
- Components that can be cut off** using ball valves that can be lead-sealed
- Thermally insulated heat block**
- 500-micron filter**
- 2-Way zone valve** with piston
- Well for delivery heat meter probe**

DOMESTIC WATER LINES

The EQC heat block **can be integrated with one or two domestic water lines**

The EQC can be supplied **pre-assembled (without cabinet)** in the desired configuration **or as separate components**

KEY FOR METERING UNITS ON THE PAGES BELOW



Heating units.



Domestic hot water units.



Domestic cold water units.

EQCP1



- Modulo di contabilizzazione Equicompact® per impianti di riscaldamento e raffrescamento con unità per calore, acqua calda sanitaria e acqua fredda sanitaria.
- Equicompact® metering module for heating and cooling systems with units for heat, domestic hot water and domestic cold water.
- Module de comptabilisation Equicompact® pour les systèmes de chauffage et de refroidissement avec unités pour chaleur, eau chaude sanitaire et eau froide sanitaire.
- Messungsmodul Equicompact® für Heiz- und Kühlsysteme mit Einheiten für Wärme, Trinkwarmwasser und Trinkkaltwasser.
- Módulo de contabilización Equicompact® para sistemas de calefacción y refrigeración con unidades para calor, agua caliente sanitaria y agua fría sanitaria.

Code	Heat unit	Domestic water units	Suitable Cabinet	Price	Class	Packaging
506587	Kv 2,50 (Qn 1,5 m³/h) - G 3/4"	HOT+COLD (Q3 2,5 m³/h) - G 3/4"	AC 860 B - AC 860 L	447,03 €	UA	1
506539	Kv 3,00 (Qn 2,5 m³/h) - G 3/4"	HOT+COLD (Q3 2,5 m³/h) - G 3/4"	AC 860 B - AC 860 L	473,33 €	UA	1

EQCP13



- Modulo di contabilizzazione Equicompact® per impianti di riscaldamento e raffrescamento con unità per calore e acqua calda sanitaria.
- Equicompact® metering module for heating and cooling systems with units for heat and domestic hot water.
- Module de comptabilisation Equicompact® pour les systèmes de chauffage et de refroidissement avec unités pour chaleur et eau chaude sanitaire.
- Messungsmodul Equicompact® für Heiz- und Kühlsysteme mit Einheiten für Wärme und Trinkwarmwasser.
- Módulo de contabilización Equicompact® para sistemas de calefacción y refrigeración con unidades para calor y agua caliente sanitaria.

Code	Heat unit	Domestic water units	Suitable Cabinet	Price	Class	Packaging
506638	Kv 2,50 (Qn 1,5 m³/h) - G 3/4"	HOT (Q3 2,5 m³/h) - G 3/4"	AC 860 B - AC 860 L	390,09 €	UA	1
506540	Kv 3,00 (Qn 2,5 m³/h) - G 3/4"	HOT (Q3 2,5 m³/h) - G 3/4"	AC 860 B - AC 860 L	416,38 €	UA	1

EQCP14



- Modulo di contabilizzazione Equicompact® per impianti di riscaldamento e raffrescamento con unità per calore e acqua fredda sanitaria.
- Equicompact® metering module for heating and cooling systems with units for heat and domestic cold water.
- Module de comptabilisation Equicompact® pour les systèmes de chauffage et de refroidissement avec unités pour chaleur et eau froide sanitaire.
- Messungsmodul Equicompact® für Heiz- und Kühlsysteme mit Einheiten für Wärme und Trinkkaltwasser.
- Módulo de contabilización Equicompact® para sistemas de calefacción y refrigeración con unidades para calor y agua fría sanitaria.

Code	Heat unit	Domestic water units	Suitable Cabinet	Price	Class	Packaging
506663	Kv 2,50 (Qn 1,5 m³/h) - G 3/4"	COLD (Q3 2,5 m³/h) - G 3/4"	AC 860 B - AC 860 L	390,09 €	UA	1
506541	Kv 3,00 (Qn 2,5 m³/h) - G 3/4"	COLD (Q3 2,5 m³/h) - G 3/4"	AC 860 B - AC 860 L	416,38 €	UA	1

EQCP15 (Kv 2,50) - EQCP25 (Kv 3,00)



- Unità calore con staffe per modulo di contabilizzazione Equicompact® per impianti di riscaldamento e raffrescamento.
- Heat unit with brackets for Equicompact metering module for heating and cooling systems.
- Unité chaleur avec étriers pour module de comptabilisation Equicompact® pour les systèmes de chauffage et de refroidissement .
- Wärme-Einheit mit Wandalterungen für Messungsmodul Equicompact® für Heiz- und Kühlsysteme.
- Unidad calor con soportes para módulo de contabilización Equicompact® para sistemas de calefacción y refrigeración.

Code	Heat unit	Insulation	Suitable Cabinet	Price	Class	Packaging
506575S	Kv 2,50 (Qn 1,5 m³/h) - G 3/4"	-	AC 860 B - AC 860 L	245,90 €	UA	1
506575SI	Kv 2,50 (Qn 1,5 m³/h) - G 3/4"	✓	AC 860 B - AC 860 L	281,54 €	UA	1
506576S	Kv 3,00 (Qn 2,5 m³/h) - G 3/4"	-	AC 860 B - AC 860 L	272,19 €	UA	1
506576SI	Kv 3,00 (Qn 2,5 m³/h) - G 3/4"	✓	AC 860 B - AC 860 L	307,85 €	UA	1



• AC 860 B / L >> p. 489



• >>p. 504



• >> p. 506



• Radio WALK-BY >> p. 523



• AMR >> p. 522

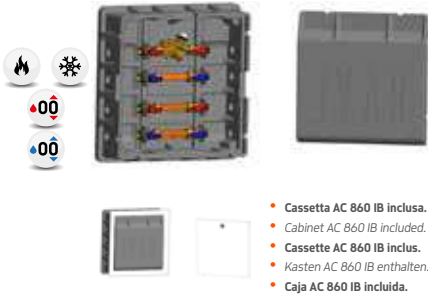

• M-BUS >>p. 519

EQCP1 I

- Modulo di contabilizzazione Equicompact® per impianti di riscaldamento e raffrescamento con unità per calore, acqua calda sanitaria e acqua fredda sanitaria.
- Equicompact® metering module for heating and cooling systems with units for heat, domestic hot water and domestic cold water.
- Module de comptabilisation Equicompact® pour les systèmes de chauffage et de refroidissement avec unités pour chaleur, eau chaude sanitaire et eau froide sanitaire.
- Messungsmodul Equicompact® für Heiz- und Kühlsysteme mit Einheiten für Wärme, Trinkwarmwasser und Trinkkaltwasser.
- Módulo de contabilización Equicompact® para sistemas de calefacción y refrigeración con unidades para calor, agua caliente sanitaria y agua fría sanitaria.

- Cassetta AC 860 IB inclusa.
- Cabinet AC 860 IB included.
- Casette AC 860 IB inclus.
- Kasten AC 860 IB enthalten.
- Caja AC 860 IB incluida.

Code	Heat unit	Domestic water units	Suitable Cabinet	Price	Class	Packaging
506587CIB	Kv 2,50 (Qn 1,5 m³/h) - G 3/4"	HOT+COLD (Q3 2,5 m³/h) - G 3/4"	AC 860 IB (Included)	622,88 €	UA	1

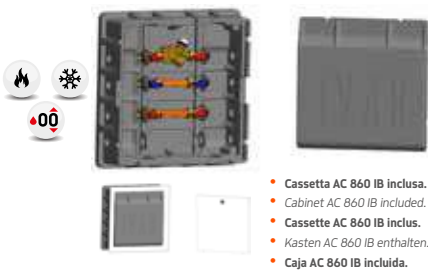
EQCP13 I

- Modulo di contabilizzazione Equicompact® per impianti di riscaldamento e raffrescamento con unità per calore e acqua calda sanitaria.
- Equicompact® metering module for heating and cooling systems with units for heat and domestic hot water.
- Module de comptabilisation Equicompact® pour les systèmes de chauffage et de refroidissement avec unités pour chaleur et eau chaude sanitaire.
- Messungsmodul Equicompact® für Heiz- und Kühlsysteme mit Einheiten für Wärme und Trinkwarmwasser.
- Módulo de contabilización Equicompact® para sistemas de calefacción y refrigeración con unidades para calor y agua caliente sanitaria.

- Cassetta AC 860 IB inclusa.
- Cabinet AC 860 IB included.
- Casette AC 860 IB inclus.
- Kasten AC 860 IB enthalten.
- Caja AC 860 IB incluida.

Code	Heat unit	Domestic water units	Suitable Cabinet	Price	Class	Packaging
506638CIB	Kv 2,50 (Qn 1,5 m³/h) - G 3/4"	HOT (Q3 2,5 m³/h) - G 3/4"	AC 860 IB (Included)	580,89 €	UA	1

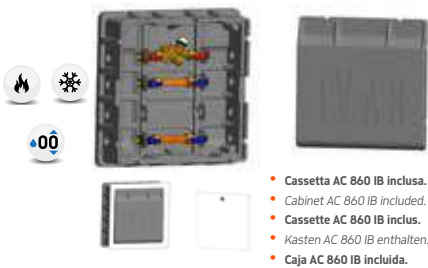
EQCP14 I

- Modulo di contabilizzazione Equicompact® per impianti di riscaldamento e raffrescamento con unità per calore e acqua fredda sanitaria.
- Equicompact® metering module for heating and cooling systems with units for heat and domestic cold water.
- Module de comptabilisation Equicompact® pour les systèmes de chauffage et de refroidissement avec unités pour chaleur et eau froide sanitaire.
- Messungsmodul Equicompact® für Heiz- und Kühlsysteme mit Einheiten für Wärme und Trinkkaltwasser.
- Módulo de contabilización Equicompact® para sistemas de calefacción y refrigeración con unidades para calor y agua fría sanitaria.

- Cassetta AC 860 IB inclusa.
- Cabinet AC 860 IB included.
- Casette AC 860 IB inclus.
- Kasten AC 860 IB enthalten.
- Caja AC 860 IB incluida.

Code	Heat unit	Domestic water units	Suitable Cabinet	Price	Class	Packaging
506663CIB	Kv 2,50 (Qn 1,5 m³/h) - G 3/4"	COLD (Q3 2,5 m³/h) - G 3/4"	AC 860 IB (Included)	580,89 €	UA	1

EQCP15 I (Kv 2,50)

- Unità calore per modulo di contabilizzazione Equicompact® per impianti di riscaldamento e raffrescamento.
- Heat unit for Equicompact® metering module for heating and cooling systems.
- Unité chaleur pour module de comptabilisation Equicompact® pour les systèmes de chauffage et de refroidissement.
- Wärme-Einheit für Messungsmodul Equicompact® für Heiz- und Kühlsysteme.
- Unidad calor para módulo de contabilización Equicompact® para sistemas de calefacción y refrigeración.

Code	Heat unit	Suitable Cabinet	Price	Class	Packaging
506575	Kv 2,50 (Qn 1,5 m³/h) - G 3/4"	AC 860 IB	215,95 €	UA	1



• AC 860 IB >> p. 489



• >> p. 504



• >> p. 506



• Radio WALK-BY >> p. 523



• AMR >> p. 522



• M-BUS >> p. 519

EQDYN1



- Modulo di contabilizzazione Equidynamic per impianti di riscaldamento e raffrescamento con unità per calore, acqua calda sanitaria e acqua fredda sanitaria.
- Equidynamic metering module for heating and cooling systems with units for heat, domestic hot water and domestic cold water.
- Module de comptabilisation Equidynamic pour les systèmes de chauffage et de refroidissement avec unités pour chaleur, eau chaude sanitaire et eau froide sanitaire.
- Messungsmodul Equidynamic für Heiz- und Kühlsysteme mit Einheiten für Wärme, Trinkwarmwasser und Trinkkaltwasser.
- Módulo de contabilización Equidynamic para sistemas de calefacción y refrigeración con unidades para calor, agua caliente sanitaria y agua fría sanitaria.

Code	Heat unit	Domestic water units	Suitable Cabinet	Price	Class	Packaging
506669	Self-balancing (Qn 1,5 m³/h) - G 3/4"	HOT+COLD (Q3 2,5 m³/h) - G 3/4"	AC 860 B - AC 860 L	407,90 €	UA	1
506859	Self-balancing (Qn 2,5 m³/h) - G 3/4"	HOT+COLD (Q3 2,5 m³/h) - G 3/4"	AC 860 B - AC 860 L	434,20 €	UA	1

EQDYN13



- Modulo di contabilizzazione Equidynamic per impianti di riscaldamento e raffrescamento con unità per calore e acqua calda sanitaria.
- Equidynamic metering module for heating and cooling systems with units for heat and domestic hot water.
- Module de comptabilisation Equidynamic pour les systèmes de chauffage et de refroidissement avec unités pour chaleur et eau chaude sanitaire.
- Messungsmodul Equidynamic für Heiz- und Kühlsysteme mit Einheiten für Wärme und Trinkwarmwasser.
- Módulo de contabilización Equidynamic para sistemas de calefacción y refrigeración con unidades para calor y agua caliente sanitaria.

Code	Heat unit	Domestic water units	Suitable Cabinet	Price	Class	Packaging
506670	Self-balancing (Qn 1,5 m³/h) - G 3/4"	HOT (Q3 2,5 m³/h) - G 3/4"	AC 860 B - AC 860 L	350,94 €	UA	1
506860	Self-balancing (Qn 2,5 m³/h) - G 3/4"	HOT (Q3 2,5 m³/h) - G 3/4"	AC 860 B - AC 860 L	377,24 €	UA	1

EQDYN14



- Modulo di contabilizzazione Equidynamic per impianti di riscaldamento e raffrescamento con unità per calore e acqua fredda sanitaria.
- Equidynamic metering module for heating and cooling systems with units for heat and domestic cold water.
- Module de comptabilisation Equidynamic pour les systèmes de chauffage et de refroidissement avec unités pour chaleur et eau froide sanitaire.
- Messungsmodul Equidynamic für Heiz- und Kühlsysteme mit Einheiten für Wärme und Trinkkaltwasser.
- Módulo de contabilización Equidynamic para sistemas de calefacción y refrigeración con unidades para calor y agua fría sanitaria.

Code	Heat unit	Domestic water units	Suitable Cabinet	Price	Class	Packaging
506671	Self-balancing (Qn 1,5 m³/h) - G 3/4"	COLD (Q3 2,5 m³/h) - G 3/4"	AC 860 B - AC 860 L	350,94 €	UA	1
506861	Self-balancing (Qn 2,5 m³/h) - G 3/4"	COLD (Q3 2,5 m³/h) - G 3/4"	AC 860 B - AC 860 L	377,24 €	UA	1

EQDYN15 - EQDYN25

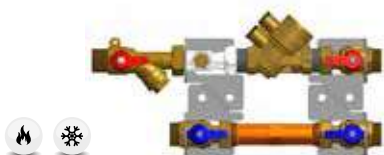

- Unità calore con staffe per modulo di contabilizzazione Equidynamic per impianti di riscaldamento e raffrescamento.
- Heat unit with brackets for Equidynamic metering module for heating and cooling systems.
- Unité chaleur avec étriers pour module de comptabilisation Equidynamic pour les systèmes de chauffage et de refroidissement.
- Wärme-Einheit mit Wandalterungen für Messungsmodul Equidynamic für Heiz- und Kühlsysteme.
- Unidad calor con soportes para módulo de contabilización Equidynamic para sistemas de calefacción y refrigeración.

Code	Heat unit	Insulation	Suitable Cabinet	Price	Class	Packaging
506632S	Self-balancing (Qn 1,5 m³/h) - G 3/4"	-	AC 860 B - AC 860 L	206,76 €	UA	1
506632SI	Self-balancing (Qn 1,5 m³/h) - G 3/4"	✓	AC 860 B - AC 860 L	242,42 €	UA	1
506633S	Self-balancing (Qn 2,5 m³/h) - G 3/4"	-	AC 860 B - AC 860 L	232,98 €	UA	1
506633SI	Self-balancing (Qn 2,5 m³/h) - G 3/4"	✓	AC 860 B - AC 860 L	268,62 €	UA	1



• AC 860 B / L >> p. 489



• >> p. 504



• >> p. 506



• PICC 01 >> p. 373



• PICC 02 >> p. 373

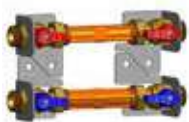

• PICC 03 >> p. 373

MC3A

- Unità acqua calda sanitaria e acqua fredda sanitaria con staffe per moduli di contabilizzazione Equicompat®/Equidynamic.
- Domestic hot water and domestic cold water units with brackets for Equicompat®/Equidynamic metering modules.
- Unités eau chaude sanitaire et eau froide sanitaire avec étriers pour modules de comptabilisation Equicompat®/Equidynamic.
- Trinkwarmwasser- und Trinkkaltwasser-Einheiten mit Wandalterungen für Messungsmodule Equicompat®/Equidynamic.
- Unidades agua caliente sanitaria y agua fría sanitaria con soportes para módulos de contabilización Equicompat®/Equidynamic.

Code	Domestic water units	Suitable Cabinet	Price	Class	Packaging
506627S	HOT+COLD (Q3 2,5 m³/h) - G 3/4"	AC 860 B - AC 860 L	130,44 €	UA	1

MC33A

- Unità acqua calda sanitaria con staffe per moduli di contabilizzazione Equicompat®/Equidynamic.
- Domestic hot water unit with brackets for Equicompat®/Equidynamic metering modules.
- Unité eau chaude sanitaire avec étrier pour modules de comptabilisation Equicompat®/Equidynamic.
- Trinkwarmwasser-Einheit mit Wandalterungen für Messungsmodule Equicompat®/Equidynamic.
- Unidad agua caliente sanitaria con soportes para módulo de contabilización Equicompat®/Equidynamic.

Code	Domestic water units	Suitable Cabinet	Price	Class	Packaging
506628S	HOT (Q3 2,5 m³/h) - G 3/4"	AC 860 B - AC 860 L	74,03 €	UA	2

MC34A

- Unità acqua fredda sanitaria con staffe per moduli di contabilizzazione Equicompat®/Equidynamic.
- Domestic cold water unit with brackets for Equicompat®/Equidynamic metering modules.
- Unité eau froide sanitaire avec étrier pour modules de comptabilisation Equicompat®/Equidynamic.
- Trinkkaltwasser-Einheit mit Wandalterungen für Messungsmodule Equicompat®/Equidynamic.
- Unidad agua fría sanitaria con soportes para módulos de contabilización Equicompat®/Equidynamic.

Code	Domestic water units	Suitable Cabinet	Price	Class	Packaging
506629S	COLD (Q3 2,5 m³/h) - G 3/4"	AC 860 B - AC 860 L	71,83 €	UA	2

MC3A I

- Unità acqua calda sanitaria e acqua fredda sanitaria per modulo di contabilizzazione Equicompat®.
- Domestic hot water and domestic cold water units for Equicompat® metering module.
- Unités eau chaude sanitaire et eau froide sanitaire pour module de comptabilisation Equicompat®.
- Trinkwarmwasser- und Trinkkaltwasser-Einheiten für Messungsmodule Equicompat®.
- Unidades agua caliente sanitaria y agua fría sanitaria para módulo de contabilización Equicompat®.

Code	Domestic water units	Suitable Cabinet	Price	Class	Packaging
506627	HOT+COLD (Q3 2,5 m³/h) - G 3/4"	AC 860 IB	100,76 €	UA	1

MC33A I

- Unità acqua calda sanitaria per modulo di contabilizzazione Equicompat®.
- Domestic hot water unit for Equicompat® metering module.
- Unité eau chaude sanitaire pour module de comptabilisation Equicompat®.
- Trinkwarmwasser-Einheit für Messungsmodule Equicompat®.
- Unidad agua caliente sanitaria para módulo de contabilización Equicompat®.

Code	Domestic water units	Suitable Cabinet	Price	Class	Packaging
506628	HOT (Q3 2,5 m³/h) - G 3/4"	AC 860 IB	59,19 €	UA	1

MC34A I

- Unità acqua fredda sanitaria per modulo di contabilizzazione Equicompat®.
- Domestic cold water unit for Equicompat® metering module.
- Unité eau froide sanitaire pour module de comptabilisation Equicompat®.
- Trinkkaltwasser-Einheit für Messungsmodule Equicompat®.
- Unidad agua fría sanitaria para módulo de contabilización Equicompat®.

Code	Domestic water units	Suitable Cabinet	Price	Class	Packaging
506629	COLD (Q3 2,5 m³/h) - G 3/4"	AC 860 IB	57,00 €	UA	12



• Radio WALK-BY >> p. 523



• AMR >> p. 522



• M-BUS >> p. 519

EQCP05



- Valvola a 2 vie per modulo di contabilizzazione Equicompact®.
- 2-way valve for Equicompact® metering module.
- Vanne à 2 voies pour module de comptabilisation Equicompact®.
- 2-Wege Ventil für Messungsmodul Equicompact®.
- Válvula de 2 vías para módulo de contabilización Equicompact®.

Code	Size	Price	Class	Packaging
506596	G 3/4"	109,62 €	UA	1 / 24

TE 3040 IV



- Testa elettrotermica normalmente chiusa (2 fili). Compatibile con tutti i vitoni termostattizzabili IVAR e i collettori con interasse ≥ 40 mm.
- Electrothermal head normally closed (2 wires). Suitable for all IVAR thermostatic inserts and manifolds with centre-to-centre distance ≥ 40 mm.
- Tête électrothermique normalement fermée (2 fils). Adaptée pour tous les inserts thermostatisables IVAR et aux collecteurs avec entraxe ≥ 40 mm.
- Elektrothermischer Stellantrieb stromlos-zu (2 Kabel). Geeignet für alle Thermostat-Regulievorrichtungen IVAR und für Verteiler mit Achsabstand ≥ 40 mm.
- Cabeza electrotrémica normalmente cerrada (de 2 hilos). Adecuada para todos los tornillos termostatzables IVAR y los colectores con distancia entre centros ≥ 40 mm.

Code	Size	Price	Class	Packaging
501508E	M30 x 1,5 ; ON / OFF (230 V AC)	29,64 €	AC	100

TE 3040



- Testa elettrotermica normalmente chiusa (2 fili). Compatibile con tutti i vitoni termostattizzabili IVAR e i collettori con interasse ≥ 50 mm (no EASY-RADIANT).
- Electrothermal head normally closed (2 wires). Suitable for all IVAR thermostatic inserts and manifolds with centre-to-centre distance ≥ 50 mm (no EASY-RADIANT).
- Tête électrothermique normalement fermée (2 fils). Adaptée pour tous les inserts thermostatisables IVAR et aux collecteurs avec entraxe ≥ 50 mm (non EASY-RADIANT).
- Elektrothermischer Stellantrieb stromlos-zu (2 Kabel). Geeignet für alle Thermostat-Regulievorrichtungen IVAR und für Verteiler mit Achsabstand ≥ 50 mm (keine EASY-RADIANT).
- Cabeza electrotrémica normalmente cerrada (de 2 hilos). Adecuada para todos los tornillos termostatzables IVAR y los colectores con distancia entre centros ≥ 50 mm (no EASY-RADIANT).

Code	Size	Price	Class	Packaging
501508	M30 x 1,5 ; ON / OFF (230 V AC)	36,60 €	AC	100
501524	M30 x 1,5 ; ON / OFF (24 V AC/DC)	36,60 €	AC	100

TE 3050 MC



- Testa elettrotermica normalmente chiusa con contatto di fine corsa (4 fili). Compatibile con tutti i vitoni termostattizzabili IVAR e i collettori con interasse ≥ 40 mm.
- Electrothermal head normally closed with limit switch contact (4 wires). Suitable for all IVAR thermostatic inserts and manifolds with centre-to-centre distance ≥ 40 mm.
- Tête électrothermique normalement fermée avec contact de fin de course (4 fils). Adaptée pour tous les inserts thermostatisables IVAR et aux collecteurs avec entraxe ≥ 40 mm.
- Elektrothermischer Stellantrieb stromlos-zu mit Endschalterkontakt (4 Kabel). Geeignet für alle Thermostat-Regulievorrichtungen IVAR und für Verteiler mit Achsabstand ≥ 40 mm.
- Cabeza electrotrémica normalmente cerrada con contacto de fin de carrera (de 4 hilos). Adecuada para todos los tornillos termostatzables IVAR y los colectores con distancia entre centros ≥ 40 mm.

Code	Size	Price	Class	Packaging
500808MC	M30 x 1,5 ; ON / OFF (230 V AC)	43,43 €	AC	100

TE 3050 M



- Testa elettrotermica normalmente chiusa con contatto di fine corsa (4 fili). Compatibile con tutti i vitoni termostattizzabili IVAR e i collettori con interasse ≥ 50 mm (no EASY-RADIANT).
- Electrothermal head normally closed with limit switch contact (4 wires). Suitable for all IVAR thermostatic inserts and manifolds with centre-to-centre distance ≥ 50 mm (no EASY-RADIANT).
- Tête électrothermique normalement fermée avec contact de fin de course (4 fils). Adaptée pour tous les inserts thermostatisables IVAR et aux collecteurs avec entraxe ≥ 50 mm (non EASY-RADIANT).
- Elektrothermischer Stellantrieb stromlos-zu mit Endschalterkontakt (4 Kabel). Geeignet für alle Thermostat-Regulievorrichtungen IVAR und für Verteiler mit Achsabstand ≥ 50 mm (keine EASY-RADIANT).
- Cabeza electrotrémica normalmente cerrada con contacto de fin de carrera (de 4 hilos). Adecuada para todos los tornillos termostatzables IVAR y los colectores con distancia entre centros ≥ 50 mm (no EASY-RADIANT).

Code	Size	Price	Class	Packaging
500808M	M30 x 1,5 ; ON / OFF (230 V AC)	43,43 €	AC	100
500028M	M30 x 1,5 ; ON / OFF (24 V AC/DC)	43,43 €	AC	100

■ PICV 05

- **Corpo valvola di bilanciamento dinamico, completo di tappo e predisposizione per prese piezometriche. Connessioni maschio – maschio**
- *Dynamic balancing valve body, complete with plug and arrangement for piezometric inlets. Male - male connections.*
- **Corps de vanne d'équilibrage dynamique, avec bouchon et prédisposition pour prises piézométriques. Connexions mâle - mâle**
- *Körper dynamisches Abgleichventil, komplett mit Kappe und Vorrüstung für Piezometeranschlüsse. AG - AG anschlüsse*
- **Cuerpo de válvula de equilibrado dinámico provisto de tapón y preparado para tomas piezométricas. Conexiones macho - macho**

Code	Size	Color	Price	Class	Packaging
590069	3/4" M x 3/4" M		42,16 €	TE	5 / 40

■ AVB 10

- **Presca piezometrica.**
- *Piezometric socket.*
- **Prise piézométrique.**
- *Piezometrischer Messventil.*
- **Toma piezométrica.**

Code	Size	Color	Price	Class	Packaging
509088B	1/4" M		6,78 €	TE	100
509088R	1/4" M		6,78 €	TE	100

■ AC 860 B

- **Cassetta murale da incasso (versione base) per moduli di contabilizzazione Equicompact®/Equidynamic.**
- *Wall fitted cabinet (basic version) for metering modules Equicompact®/Equidynamic.*
- **Caisse murale encastrable (version de base) pour modules de comptabilisation Equicompact®/Equidynamic.**
- *Einbauwandkasten (Grundausführung) für Messungsmodule Equicompact®/Equidynamic.*
- **Caja mural de empotrar (versión básica) para módulos de contabilización Equicompact®/Equidynamic.**

Code	Height	Width	Depth	Price	Class	Packaging
200199	450 mm	450 mm	135-160 mm	238,24 €	NZ	1

■ AC 860 L

- **Cassetta murale da incasso (versione con coperchio predisposto per l'intonacatura) per moduli di contabilizzazione Equicompact®/Equidynamic.**
- *Wall fitted cabinet (version with cover suitable for plastering) for metering modules Equicompact®/Equidynamic.*
- **Caisse murale encastrable (version avec couverture adaptée pour le plâtre) pour modules de comptabilisation Equicompact®/Equidynamic.**
- *Einbauwandkasten (Ausführung mit Abdeckung geeignet für das Berappen) für Messungsmodule Equicompact®/Equidynamic.*
- **Caja mural de empotrar (versión con cubierta adecuada para enyesar) para módulos de contabilización Equicompact®/Equidynamic.**

Code	Height	Width	Depth	Price	Class	Packaging
200299	450 mm	450 mm	135-160 mm	389,96 €	NZ	1

■ AMEQCP 01

- **Guscio di coibentazione per unità di contabilizzazione del calore per moduli Equicompact®/Equidynamic.**
- *Insulation shell for heat metering unit for Equicompact®/Equidynamic modules.*
- **Coque d'isolation pour unité de comptabilisation de chaleur pour modules Equicompact®/Equidynamic.**
- *Isolierschale für Wärmemesseung Einheit für module Equicompact®/Equidynamic.*
- **Cobertura aislante para la unidad de contabilización de calor para módulos Equicompact®/Equidynamic.**

Code	Module	Price	Class	Packaging
506666	EQCP15 - EQCP25 - EQDYN15 - EQDYN25	35,65 €	UA	5

■ AC 860 IB

- **Cassetta murale da incasso in polipropilene (versione base) per moduli di contabilizzazione Equicompact®.**
- *Wall polypropylene fitted cabinet (basic version) for metering modules Equicompact®.*
- **Caisse murale encastrable en polypropylène (version de base) pour modules de comptabilisation Equicompact®.**
- *Einbauwandkasten aus Polypropylen (Grundausführung) für Messungsmodule Equicompact®.*
- **Caja mural de empotrar de polipropileno (versión básica) para módulos de contabilización Equicompact®.**

Code	Height	Width	Depth	Price	Class	Packaging
506665B	470 mm	470 mm	120-160 mm	268,80 €	UA	1

MC 4

IVAR completes its range of two-way utility modules with the family of MC4 modules, compact unit which includes a PICV (pressure independent control valve) with insert PICC 01/11, PICC 02/12 or thermostatic insert PICC 03 /13, with the double function of flow rate stabilisation valve to ensure ideal dynamic balancing and shut-off valve. This device allows you to choose among 41 flow rate values and assures stability; it can also be managed by an on/off or proportional 0-10 V electrothermal actuator which allows it to be modulated/limited as the demand of the utility varies.

The module is completed with shut-off valve on the primary circuit side and utility side, filter, non-return valve, set up for heat valves and double pit for supply and return probes. The cabinet is supplied separately.

MC4 modules are available in the version with main connections measuring 3/4" or 1".

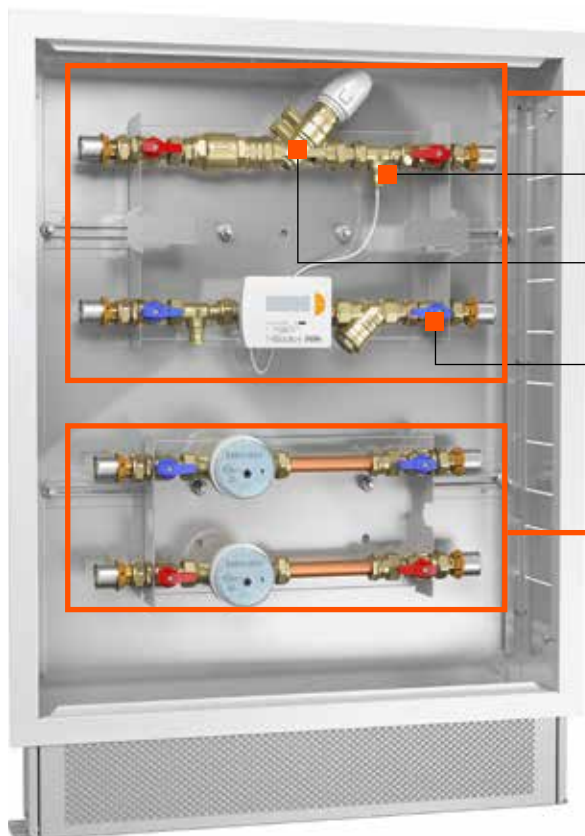

CONTROL BLOCK

Well for delivery heat meter probe

PICV for dynamic balancing of the flow rate

Components can be cut off with ball valves

DOMESTIC WATER LINES

Customizable with no, 1, 2 or 3 meters

Available with 2 domestic water lines and anti-scald thermostatic mixer

+ PLUS

- Freely configurable with volumetric meters for DHW, DCW and dual water
- Equipped with a PICV valve for dynamic balancing of the flow rate
- Pre-assembled or in a template with separate components

KEY FOR METERING UNITS



Heating units.



Domestic cold water units.



Domestic hot water units.

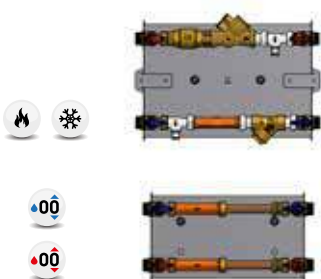

Thermostatic mixer.

MC4

- Modulo di contabilizzazione MC4 per impianti di riscaldamento e raffrescamento con unità calore, acqua calda sanitaria e acqua fredda sanitaria.
- MC4 metering module for heating and cooling systems with heat unit, domestic hot water and domestic cold water.
- Module de comptabilisation MC4 pour les systèmes de chauffage et de refroidissement avec unité de chaleur, eau chaude sanitaire et eau froide sanitaire.
- Messungsmodul MC4 für Heiz- und Kühlsysteme mit Einheiten für Wärme, Trinkwarmwasser und Trinkkaltwasser.
- Módulo de contabilización MC4 para sistemas de calefacción y refrigeración con unidad para calor, agua caliente sanitaria y agua fría sanitaria.

Code	Heat unit	Domestic water units	Suitable Cabinet	Cabinet width	Price	Class	Packaging
506706	Qn 1,5 m³/h – G 3/4"	HOT+COLD (Q3 2,5 m³/h) – G 3/4"	200590	600 mm	465,11 €	UA	1
506640	Qn 2,5 m³/h – G 1"	HOT+COLD (Q3 2,5 m³/h) – G 3/4"	200090	700 mm	629,07 €	UA	1
506707	Qn 1,5 m³/h – G 3/4"	HOT+COLD (Q3 4 m³/h) – G 1"	200590	600 mm	573,83 €	UA	1
506641	Qn 2,5 m³/h – G 1"	HOT+COLD (Q3 4 m³/h) – G 1"	200090	700 mm	737,79 €	UA	1

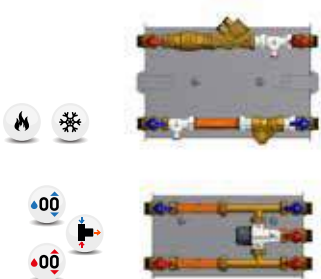
MC41

- Modulo di contabilizzazione MC4 per impianti di riscaldamento e raffrescamento con unità calore, acqua calda sanitaria, acqua fredda sanitaria e miscelatore termostatico.
- MC4 metering module for heating and cooling systems with heat unit, domestic hot water, domestic cold water and thermostatic blender.
- Module de comptabilisation MC4 pour les systèmes de chauffage et de refroidissement avec unité de chaleur, eau chaude sanitaire, eau froide sanitaire et limiteur de température.
- Messungsmodul MC4 für Heiz- und Kühlsysteme mit Einheiten für Wärme, Trinkwarmwasser, Trinkkaltwasser und thermostatischem Mischer.
- Módulo de contabilización MC4 para sistemas de calefacción y refrigeración con unidad para calor, agua caliente sanitaria, agua fría sanitaria y mezclador termostático.

Code	Heat unit	Domestic water units	Suitable Cabinet	Cabinet width	Price	Class	Packaging
506708	Qn 1,5 m³/h – G 3/4"	HOT+COLD (Q3 2,5 m³/h) + MIX – G 3/4"	200590	600 mm	553,81 €	UA	1
506642	Qn 2,5 m³/h – G 1"	HOT+COLD (Q3 2,5 m³/h) + MIX – G 3/4"	200090	700 mm	717,79 €	UA	1

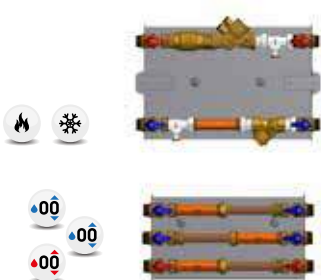
MC42

- Modulo di contabilizzazione MC4 per impianti di riscaldamento e raffrescamento con unità calore, acqua calda sanitaria, acqua fredda sanitaria e acqua duale.
- MC4 metering module for heating and cooling systems with heat unit, domestic hot water, domestic cold water and dual water.
- Module de comptabilisation MC4 pour les systèmes de chauffage et de refroidissement avec unité de chaleur, eau chaude sanitaire, eau froide sanitaire et eau duale.
- Messungsmodul MC4 für Heiz- und Kühlsysteme mit Einheiten für Wärme, Trinkwarmwasser, Trinkkaltwasser und Dualkaltwasser.
- Módulo de contabilización MC4 para sistemas de calefacción y refrigeración con unidad para calor, agua caliente sanitaria, agua fría sanitaria y agua fría dual.

Code	Heat unit	Domestic water units	Suitable Cabinet	Cabinet width	Price	Class	Packaging
506709	Qn 1,5 m³/h – G 3/4"	HOT+COLD+DUAL (Q3 2,5 m³/h) – G 3/4"	200590	600 mm	523,05 €	UA	1
506643	Qn 2,5 m³/h – G 1"	HOT+COLD+DUAL (Q3 2,5 m³/h) – G 3/4"	200090	700 mm	687,02 €	UA	1
506710	Qn 1,5 m³/h – G 3/4"	HOT+COLD+DUAL (Q3 4 m³/h) – G 1"	200590	600 mm	678,51 €	UA	1
506644	Qn 2,5 m³/h – G 1"	HOT+COLD+DUAL (Q3 4 m³/h) – G 1"	200090	700 mm	842,47 €	UA	1



>> p. 204,316,396,503



>> p. 504



>> p. 506



• P1CC 01 (MC 3/4") / P1CC 11 (MC 1") >> p. 373



• P1CC 02 (MC 3/4") / P1CC 12 (MC 1") >> p. 373



• P1CC 03 (MC 3/4") / P1CC 13 (MC 1") >> p. 373



• Radio WALK-BY >> p. 523



• AMR >> p. 522



• M-BUS >> p. 519

MC43

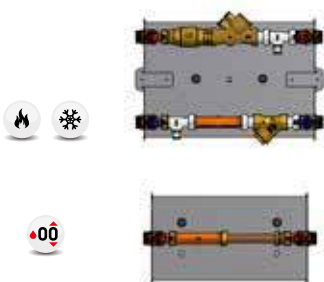

- Modulo di contabilizzazione MC4 per impianti di riscaldamento e raffrescamento con unità calore e acqua calda sanitaria.
- MC4 metering module for heating and cooling systems with heat unit and domestic hot water.
- Module de comptabilisation MC4 pour les systèmes de chauffage et de refroidissement avec unité de chaleur et eau chaude sanitaire.
- Messungsmodule MC4 für Heiz- und Kühlsysteme mit Einheiten für Wärme und Trinkwarmwasser.
- Módulo de contabilización MC4 para sistemas de calefacción y refrigeración con unidad para calor y agua caliente sanitaria.

Code	Heat unit	Domestic water units	Suitable Cabinet	Cabinet width	Price	Class	Packaging
506711	Qn 1,5 m³/h – G 3/4"	HOT (Q3 2,5 m³/h) – G 3/4"	200590	600 mm	408,22 €	UA	1
506645	Qn 2,5 m³/h – G 1"	HOT (Q3 2,5 m³/h) – G 3/4"	200090	700 mm	572,19 €	UA	1
506712	Qn 1,5 m³/h – G 3/4"	HOT (Q3 4 m³/h) – G 1"	200590	600 mm	460,53 €	UA	1
506646	Qn 2,5 m³/h – G 1"	HOT (Q3 4 m³/h) – G 1"	200090	700 mm	624,49 €	UA	1

MC44

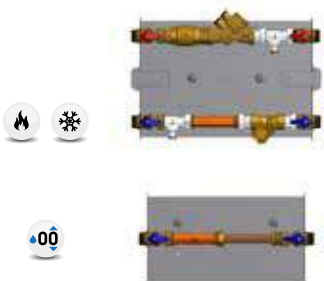

- Modulo di contabilizzazione MC4 per impianti di riscaldamento e raffrescamento con unità calore e acqua fredda sanitaria.
- MC4 metering module for heating and cooling systems with heat unit and domestic cold water.
- Module de comptabilisation MC4 pour les systèmes de chauffage et de refroidissement avec unité de chaleur et eau froide sanitaire.
- Messungsmodule MC4 für Heiz- und Kühlsysteme mit Einheiten für Wärme und Trinkkaltwasser.
- Módulo de contabilización MC4 para sistemas de calefacción y refrigeración con unidad para calor y agua fría sanitaria.

Code	Heat unit	Domestic water units	Suitable Cabinet	Cabinet width	Price	Class	Packaging
506713	Qn 1,5 m³/h – G 3/4"	COLD (Q3 2,5 m³/h) – G 3/4"	200590	600 mm	406,09 €	UA	1
506647	Qn 2,5 m³/h – G 1"	COLD (Q3 2,5 m³/h) – G 3/4"	200090	700 mm	570,05 €	UA	1
506714	Qn 1,5 m³/h – G 3/4"	COLD (Q3 4 m³/h) – G 1"	200590	600 mm	460,53 €	UA	1
506648	Qn 2,5 m³/h – G 1"	COLD (Q3 4 m³/h) – G 1"	200090	700 mm	624,49 €	UA	1

MC45

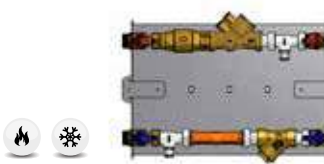

- Modulo di contabilizzazione MC4 per impianti di riscaldamento e raffrescamento solo con unità calore.
- MC4 metering module for heating and cooling systems with unit for heat only.
- Module de comptabilisation MC4 pour les systèmes de chauffage et de refroidissement uniquement avec unité de chaleur.
- Messungsmodule MC4 für Heiz- und Kühlsysteme nur mit Einheit für Wärme.
- Módulo de contabilización MC4 para sistemas de calefacción y refrigeración sólo con unidad para el calor.

Code	Heat unit	Suitable Cabinet	Cabinet width	Price	Class	Packaging
506715	Qn 1,5 m³/h – G 3/4"	200686	600 mm	320,02 €	UA	1
506649	Qn 2,5 m³/h – G 1"	200186	700 mm	483,98 €	UA	1



>> p. 204,316,396,503



>> p. 504



>> p. 506



PICC 01 (MC 3/4") / PICC 11 (MC 1") >> p. 373



PICC 02 (MC 3/4") / PICC 12 (MC 1") >> p. 373



PICC 03 (MC 3/4") / PICC 13 (MC 1") >> p. 373



Radio WALK-BY >> p. 523



AMR >> p. 522



M-BUS >> p. 519

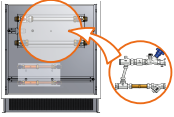

For the supply of modules in separate components (template + functional blocks) please refer to the following tables.

MC4 Template



- Dima per modulo di contabilizzazione MC4.
- Template for MC4 metering module.
- Gabarit pour module de comptabilisation MC4.
- Schablone für Messungsmodul MC4.
- Plantilla para módulo de contabilización MC4.

Code	Suitable Cabinet	Price	Class	Packaging
506639	200590	255,22 €	UA	1
509169	200090	313,15 €	UA	1

- Dima per unità di contabilizzazione acqua sanitaria non inclusa.
- Template for domestic water metering units not included.
- Gabarit pour unités de comptabilisation eau sanitaire non inclus.
- Schablone für Sanitärwasserzähler nicht enthalten.
- Plantilla para unidades de contabilización de agua sanitaria no incluida.

MC4 Complementary module



- Modulo complementare per MC4.
- Complementary module for MC4.
- Module complémentaire pour MC4.
- Ergänzungsmodul für MC4.
- Módulo complementario para MC4.

Code	Heat unit	Price	Class	Packaging
KSB0043	Qn 1,5 m³/h – G 3/4"	219,46 €	UA	1
KSB0038	Qn 2,5 m³/h – G 1"	214,45 €	UA	1
KSB0038MR	Qn 2,5 m³/h – G 1"	287,53 €	UA	1

- KSB003MR: modulo stand-alone, utilizzabile senza dima MC4 Template.
- KSB003MR: stand-alone module, no MC4 Template needed.
- KSB003MR: module autonome, aucun gabarit MC4 Template requis.
- KSB003MR: Standalone-Modul, keine Schablone MC4 Template erforderlich.
- KSB003MR: módulo independiente, no se necesita plantilla MC4 Template.

MODULES FOR DW METERING

KEY FOR METERING UNITS



Domestic hot water units.



Domestic cold water units.



Thermostatic mixer.

MC3

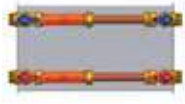

- Modulo di contabilizzazione MC3 con unità per acqua calda sanitaria e acqua fredda sanitaria
- MC3 metering module with units for domestic hot water and domestic cold water
- Module de comptabilisation MC3 avec unités pour eau chaude sanitaire et eau froide sanitaire
- Messungsmodul MC3 mit Einheiten für Trinkwarmwasser und Trinkkaltwasser
- Módulo de contabilización MC3 con unidades para agua caliente sanitaria y agua fría sanitaria

Code	Domestic water units	Suitable Cabinet	Cabinet width	Price	Class	Packaging
506520	HOT+COLD (Q3 2,5 m³/h) - G 3/4"	200086	500 mm	155,95 €	UA	1
506521	HOT+COLD (Q3 4 m³/h) - G 1"	200086	500 mm	261,92 €	UA	1

MC31

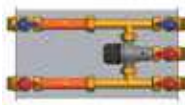

- Modulo di contabilizzazione MC3 con unità per acqua calda sanitaria, acqua fredda sanitaria e miscelatore termostatico
- MC3 metering module with units for domestic hot water, domestic cold water and thermostatic mixer
- Module de comptabilisation MC3 avec unités pour eau chaude sanitaire, eau froide sanitaire et limiteur de température
- Messungsmodul MC3 mit Einheiten für Trinkwarmwasser, Trinkkaltwasser und thermostatischem Mischer
- Módulo de contabilización MC3 con unidades para agua caliente sanitaria, agua fría sanitaria y mezclador termostático

Code	Domestic water units	Suitable Cabinet	Cabinet width	Price	Class	Packaging
506522	HOT+COLD (Q3 2,5 m³/h) + MIX - G 3/4"	200086	500 mm	241,88 €	UA	1

MC32

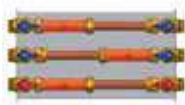

- Modulo di contabilizzazione MC3 con unità per acqua calda sanitaria, acqua fredda sanitaria e acqua fredda duale
- MC3 metering module with units for domestic hot water, domestic cold water and dual cold water
- Module de comptabilisation MC3 avec unités pour eau chaude sanitaire, eau froide sanitaire et eau froide duale
- Messungsmodul MC3 mit Einheiten für Trinkwarmwasser, Trinkkaltwasser und Dualkaltwasser
- Módulo de contabilización MC3 con unidades para agua caliente sanitaria, agua fría sanitaria y agua fría dual

Code	Domestic water units	Suitable Cabinet	Cabinet width	Price	Class	Packaging
506523	HOT+COLD+DUAL (Q3 2,5 m³/h) - G 3/4"	200086	500 mm	211,14 €	UA	1
506524	HOT+COLD+DUAL (Q3 4 m³/h) - G 1"	200086	500 mm	366,59 €	UA	1

MC33



- Modulo di contabilizzazione MC3 solo con unità per acqua calda sanitaria
- MC3 metering module with unit for domestic hot water only
- Module de comptabilisation MC3 uniquement avec unité pour l'eau chaude sanitaire
- Messungsmodul MC3 nur mit Einheit für Trinkwarmwasser
- Módulo de contabilización MC3 sólo con unidad para agua caliente sanitaria

Code	Domestic water units	Suitable Cabinet	Cabinet width	Price	Class	Packaging
506525	HOT (Q3 2,5 m³/h) - G 3/4"	200086	500 mm	96,31 €	UA	1
506526	HOT (Q3 4 m³/h) - G 1"	200086	500 mm	151,40 €	UA	1

MC34



- Modulo di contabilizzazione MC3 solo con unità per acqua fredda sanitaria
- MC3 metering module with unit for domestic cold water only
- Module de comptabilisation MC3 uniquement avec unité pour l'eau froide sanitaire
- Messungsmodul MC3 nur mit Einheit für Trinkkaltwasser
- Módulo de contabilización MC3 sólo con unidad para agua fría sanitaria

Code	Domestic water units	Suitable Cabinet	Cabinet width	Price	Class	Packaging
506527	COLD (Q3 2,5 m³/h) - G 3/4"	200086	500 mm	94,16 €	UA	1
506528	COLD (Q3 4 m³/h) - G 1"	200086	500 mm	152,87 €	UA	1



• >> p. 204,503



• >> p. 506



• Radio WALK-BY >> p. 523



• Radio AMR >> p. 522



• M-BUS >> p. 519

SPECIAL MODULES

EQM FLOOR

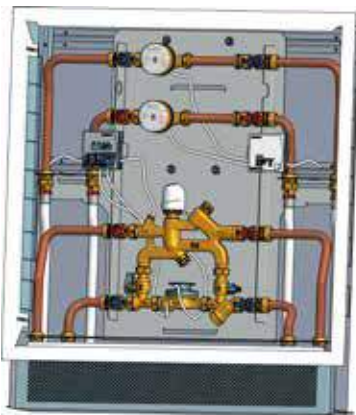

- EQM FLOOR è una versione speciale di Equimeter dotata di supporto in lamiera speciale che permette, mediante alette forate ripiegate verso l'esterno, il fissaggio di tubi appositamente curvati per l'alimentazione e distribuzione dal e verso il basso. Tale soluzione permette di arrivare con le tubazioni direttamente dal basso, evitando dispendiose operazioni di curvatura dei tubi.
- EQM FLOOR is a special version of Equimeter equipped with a special sheet metal support which fixes specifically bent pipes, by means of perforated flaps bent outwards, to feed and distribute from and to the floor. The solution allows pipes to arrive directly from the floor, avoiding difficult pipe curvature operations.
- EQM FLOOR est une version spéciale d'Equimeter dotée d'un support en tôle spéciale qui permet, au moyen d'ailettes percées repliées vers l'extérieur, la fixation de tubes expressément courbés pour l'alimentation et la distribution du et vers le bas. Cette solution permet d'arriver avec les conduites directement du bas, en évitant des opérations de courbure difficiles des tubes.
- EQM FLOOR ist eine spezielle Version des Equimeter mit einem besonderen Blechhalter, bei dem mittels nach außen gebogenen perforierten Lamellen die Montage entsprechender gebogener Rohre für die Versorgung und Verteilung von und nach unten möglich wird. Diese Lösung erlaubt eine Zuführung der Leitungen direkt von unten, ohne schwierige Rohrbiegungen.
- EQM FLOOR es una versión especial de Equimeter con soporte de chapa especial que permite, mediante aletas perforadas dobladas hacia el exterior, la fijación de tubos curvados de manera que la alimentación y distribución se produzcan desde y hacia abajo. Dicha solución permite llegar con las tuberías directamente desde abajo, evitando operaciones complicadas de curvatura de los tubos.

EQM DOUBLE H/C

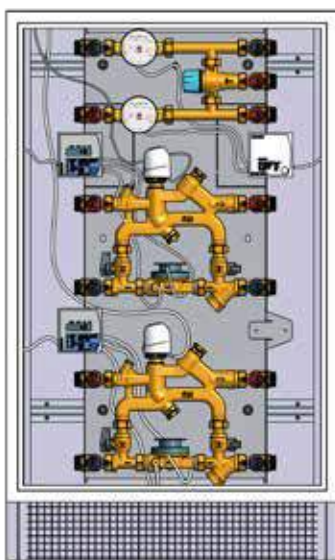

- Il sistema EQM DOUBLE è una soluzione ingegnerizzata per gli impianti a quattro tubi in cui i circuiti di alimentazione per riscaldamento e per raffreddamento risultano separati. Il modulo presenta, oltre alla parte di contabilizzazione sanitaria, due moduli Equimeter, uno per la contabilizzazione di energia in riscaldamento l'altro per quella in raffreddamento. Il tutto è alloggiato su apposito telaio in lamiera zincata che può essere inserito in cassetta speciale.
- The EQM DOUBLE system is a solution engineered for four-pipe plants in which the feed circuits for heating and cooling are separate. Aside from the DHW metering part, the module has two Equimeter modules, one to meter heating energy and the other for cooling. It is all housed in a specific galvanised sheet metal frame which can be inserted in a special cabinet.
- Le système EQM DOUBLE est une solution d'ingénierie pour les installations à quatre tubes o les circuits d'alimentation pour chauffage et pour refroidissement sont séparés. Le module présente, outre la partie de comptabilisation sanitaire, deux modules Equimeter, un pour la comptabilisation d'énergie en chauffage, l'autre pour celle en refroidissement. Le tout é logé sur un châssis approprié en tôle zinguée qui peut être inséré dans un boîtier spécial.
- Das System EQM DOUBLE ist eine technische Lösung für Vierrohrsysteme, bei denen die Versorgungskreise für Heizung und Kühlung getrennt sind. Das Modul besitzt, zusätzlich zu dem Teil der Warmwassermessung, zwei Equimeter-Module, eines für die Wärmemengenmessung beim Heizen und eines für die Kühlung. Sämtliche Teile sind auf einem entsprechenden Rahmen aus verzinktem Stahlblech vormontiert, der in einem speziellen Schrank installiert werden kann.
- El sistema EQM DOUBLE es una solución de ingeniería para las instalaciones de cuatro tubos en las que los circuitos de alimentación para calefacción y para aire acondicionado resultan separados. El módulo presenta, además de la parte de contabilización sanitaria, dos módulos Equimeter, uno para la contabilización de energía en calefacción y el otro para la del aire acondicionado. El conjunto se encuentra alojado en un marco de montaje de chapa galvanizada que se puede aplicar a una caja especial.

PLURIMETER

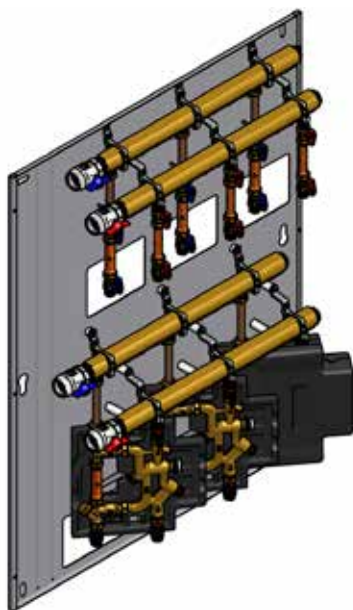

- PLURIMETER è sistema multiutenza completo assemblato su telaio che prevede più moduli EQUIMETER installati verticalmente e collegati direttamente sul lato primario a dei collettori principali di distribuzione che derivano dalle colonne montanti dell'edificio. Analogamente anche le linee sanitarie delle singole utenze sono collegate a dei collettori principali di distribuzione. Tale soluzione che si sviluppa soprattutto in orizzontale (rispetto ai moduli CMI) permette di concentrare in un'unica zona tecnica i collegamenti idraulici, elettrici e le letture dei dispositivi.
- PLURIMETER is the complete multi-utility system assembled on a frame with several EQUIMETER modules installed vertically and connected directly on the primary side to the main distribution manifolds coming from the upright columns of the building. In the same way the DHW lines of the individual utilities are connected to the main distribution manifolds. This solution is especially developed horizontally (with respect to CMI modules) concentrating the hydraulic and electrical connections and reading devices in a single technical area.
- PLURIMETER est système à plusieurs installations complet, assemblé sur un châssis qui prévoit plusieurs modules EQUIMETER installés verticalement et reliés directement sur le côté primaire à des collecteurs principaux de distribution qui dérivent des colonnes montantes de l'édifice. De façon analogue, les lignes sanitaires de chaque installation sont également reliées à des collecteurs principaux de distribution. Cette solution qui se développe surtout horizontalement (par rapport aux modules CMI) permet de concentrer les raccordements hydrauliques, électriques et les lectures des dispositifs dans une unique zone technique.
- PLURIMETER ist ein System für mehrere Verbraucher, vollständig auf einem Rahmen vormontiert, bei dem mehrere EQUIMETER-Module vertikal eingebaut und direkt mit der Primärseite der Hauptverteiler der Steigleitungen des Gebäudes verbunden sind. Auf gleiche Weise sind auch die Warmwasserleitungen der einzelnen Verbraucher mit den Hauptverteilern verbunden. Diese im wesentlichen waagrecht ausgerichtete Lösung (gegenüber den CMI-Modulen) ermöglicht eine gebündelte Anordnung aller hydraulischen und elektrischen Anschlüsse in einem Technikbereich mit zentraler Ablesung der Einheiten.
- PLURIMETER es un sistema multiusuario completo, ensamblado en marco de montaje que prevé varios módulos EQUIMETER instalados verticalmente y conectados directamente en el lado primario a colectores principales de distribución que derivan de las columnas ascendentes del edificio. De manera parecida también las líneas sanitarias de cada usuario están conectadas y unos colectores principales de distribución. Dicha solución que se desarrolla sobre todo en horizontal (respecto a los módulos CMI) permite concentrar en una única zona técnica las conexiones hidráulicas, eléctricas y las lecturas de los dispositivos.

CMI

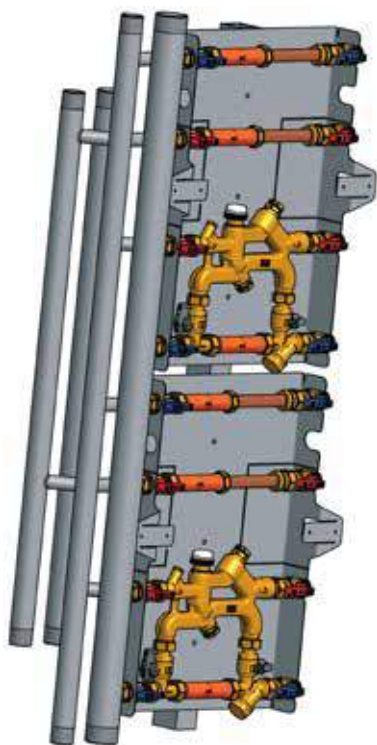

- I moduli CMI (connessioni multiple da incasso) sono soluzioni pensate per l'installazione in appositi vani tecnici realizzati ai singoli piani: in sostituzione delle tradizionali cassette da incasso contenenti i singoli moduli e che vengono installate al di fuori della singola utenza, CMI è un kit preassemblato su apposito telaio che include più moduli Equipimeter (da due a cinque) già connessi alle colonne di distribuzione. Gli stacchi possono essere a destra, a sinistra o da ambo i lati delle colonne. Le colonne possono essere realizzate di differenti diametri.
- CMI modules (multiple recessed connections) are solutions designed for installation in specific technical compartments implemented on the single floors: they replace the traditional recessed cabinets containing the individual modules and installed outside the single utility. CMI is a kit pre-assembled on a specific frame including some Equipimeter modules (from two to five) already connected to the distribution columns. The units can be on the right, on the left or on both sides of the columns. The columns can be made in different diameters.
- Les modules CMI (connexions multiples à encastrer) sont des solutions pensées pour l'installation en locaux techniques appropriés, réalisés à chaque plan : en substitution des boîtiers traditionnels à encastrer contenant chaque module et qui sont installés au dehors de chaque installation. CMI est un kit pré-assemblé sur un châssis approprié qui comprend plusieurs modules Equipimeter (de deux à cinq) déjà reliés aux colonnes de distribution. Les détachements peuvent être à droite, à gauche ou des deux côtés des colonnes. Les colonnes peuvent être réalisées en différents diamètres.
- Die CMI-Module (mehrfache Einbauanschlüsse) sind Lösungen für den Einbau in spezielle Technikräume, die auf den einzelnen Stockwerken vorgesehen werden: anstelle der traditionellen Unterputzschränke mit den einzelnen Modulen, die außerhalb der einzelnen Verbrauchereinheiten installiert werden handelt es sich bei dem CMI um einen vormontierten Kit auf einem speziellen Rahmen, der mehrere Equipimeter-Module (zwei bis fünf) umfasst, die bereits mit den Verteilsträngen verbunden sind. Die Abgänge können rechts, links oder auf beiden Seiten der Steigstränge vorgesehen werden. Die Steigstränge können in verschiedenen Durchmessern hergestellt werden.
- Los módulos CMI (conexiones múltiples empotrables) son soluciones pensadas para la instalación en compartimentos adecuados técnicos realizados en cada planta: en sustitución de las cajas tradicionales empotrables que contienen cada uno de los módulos y que se instalan fuera de cada dispositivo, CMI es un ékit pre-ensamblado en un marco de montaje adecuado que incluye más de un módulo Equipimeter (de dos a cinco) ya conectados a las columnas de distribución. Las desconexiones pueden estar en la derecha, en la izquierda o en ambos lados de las columnas. Las columnas se pueden hacer en diferentes diámetros.

UNIMETER

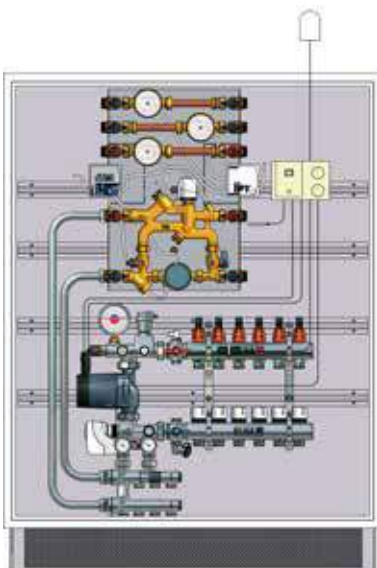

- Unimeter unisce all'interno di un'unica cassetta i sistemi Equipimeter per la contabilizzazione del calore e il sistema UNIMIX per la miscelazione e distribuzione agli impianti radianti a pavimento. In questo caso la soluzione si sviluppa verticalmente riducendo gli ingombri in orizzontale. UNIMIX può quindi essere equipaggiato sia con i collettori di bassa temperatura (con relativi accessori) sia con i collettori di alta temperatura. Fino ad un massimo di 10 uscite sui circuiti a pavimento UNIMETER può essere alloggiato in cassette aventi luce utile di 1100 mm (altezza) x 900 mm (larghezza) x 110 mm (profondità). Nel caso di uscite da 11 a 13 è necessario passare a cassette con luce 1100 mm x 1100 mm x 110 mm.
- Unimeter unites Equipimeter systems for metering heat and the UNIMIX system for mixing and distributing radiant floor systems in one cabinet. In this case, the solution is developed vertically, reducing horizontal encumbrances. UNIMIX can therefore be equipped both with low temperature manifolds (with relative accessories) and with high temperature manifolds. With up to a maximum of 10 outlets on floor circuits, UNIMETER can be housed in cabinets with useful space of 1100 mm (height) x 900 mm (width) x 110 mm (depth). With 11 to 13 outlets, cabinets 1100 mm x 1100 mm x 110 mm need to be used.
- Unimeter unit à l'intérieur d'un seul boîtier les systèmes Equipimeter pour la comptabilisation de la chaleur et le système UNIMIX pour le mélange et la distribution aux installations radiantes au sol. Dans ce cas, la solution se développe verticalement réduisant ainsi les encombrements horizontaux. UNIMIX peut donc être équipé soit avec les collecteurs de basse température (avec les accessoires correspondants) soit avec les collecteurs de haute température. Jusqu'à un maximum de 10 sorties sur les circuits au sol UNIMETER peut être logé dans des boîtiers ayant un jour utile de 1100 mm (hauteur) x 900 mm (largeur) x 110 mm (profondeur). En cas de sorties de 11 à 13, il faut passer à des boîtiers ayant un jour de 1100 mm x 1100 mm x 110 mm.
- Unimeter vereint in einem einzigen Schrank die Equipimeter-Systeme zur Wärmemessung und das UNIMIX-System für Mischung und Verteilung an die Fußbodenheizungskreise. In diesem Fall ist die Lösung vertikal ausgerichtet, wodurch sich eine geringe Breite ergibt. UNIMIX kann daher sowohl mit Niedertemperaturverteilern (mit entsprechendem Zubehör) als auch mit Hochtemperaturverteilern ausgestattet werden. Es können maximal 10 UNIMETER-Fußbodenkreise in einem Schrank mit den lichten Abmessungen 1100 mm (Höhe) x 900 mm (Breite) x 110 mm (Tiefe) untergebracht werden. Bei 11 – 13 Abgängen muss ein Schrank mit lichtigem Maß 1100 mm x 1100 mm x 110 mm vorgesehen werden.
- Unimeter reúne dentro de una única caja los sistemas para la contabilización del calor y el sistema UNIMIX para la mezcla y distribución en las instalaciones radiantes de suelo. En este caso la solución se desarrolla verticalmente reduciendo las dimensiones en horizontal. UNIMIX por lo tanto se puede equipar ya sea con los colectores de baja temperatura (con los correspondientes accesorios), ya sea con los colectores de alta temperatura. Hasta un máximo de 10 salidas en los circuitos por suelo UNIMETER puede alojarse en cajas con un espacio útil de 1100 mm (altura) x 900 mm (anchura) x 110 mm (profundidad). En el caso de salidas de 11 a 13 es necesario pasar a cajas con luz 1100 mm x 1100 mm x 110 mm.

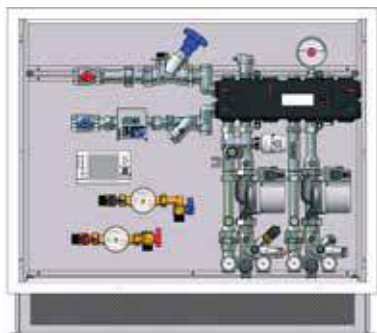
MULTIMETER

- MULTIMETER** abbina un sistema di contabilizzazione del calore e dell'acqua sanitaria ad un gruppo MULTIMIX. La parte di contabilizzazione calore comprende due valvole di intercettazione all'ingresso e all'uscita del modulo, una valvola di bilanciamento, un filtro e il tronchetto per l'alloggiamento del contatore di calore sul ritorno. Grazie a due raccordi eccentrici il sistema viene collegato al collettore/separatore idraulico del gruppo MULTIMIX che a seconda delle esigenze specifiche può essere completato con i moduli di distribuzione di alta e/o bassa temperatura.
- MULTIMETER** combines a heat and DHW metering system to a MULTIMIX unit. The heat metering part includes two shut-off valves at the inlet and outlet of the module, a balancing valve, a filter and the stub pipe housing the heat meter on the return line. The system is connected to the hydraulic manifold/separator of the MULTIMIX unit by two eccentric fittings. According to specific requirements, it can be completed with high and/or low temperature distribution modules.
- MULTIMETER** associe un système de comptabilisation de la chaleur et de l'eau sanitaire à un groupe MULTIMIX. La partie de comptabilisation de la chaleur comprend deux vannes d'interception à l'entrée et à la sortie du module, une vanne d'équilibrage, un filtre et les tricoises pour le logement du compteur de chaleur sur le retour. Gr. ce à deux raccords excentriques, le système est relié au collecteur/séparateur hydraulique du groupe MULTIMIX qui peut, selon les exigences spécifiques, être complété avec les modules de distribution de haute et/ou basse température.
- MULTI** kombiniert ein Heizwärme- und Warmwasser-Messsystem mit einer MULTIMIX-Gruppe. Der Abschnitt der Heizwärmemessung umfasst zwei Absperrventile am Zu- und Ablauf des Moduls, ein Abgleichventil, ein Filter und das Passstück für den Wärmehähler im Rücklauf. Dank zweier Exzenterverschraubungen wird das System mit dem Verteiler/der hydraulischen Weiche der MULTIMIX-Gruppe verbunden, die nach Bedarf mit den Hoch-/Niedertemperatur-Verteilermodulen vervollständigt werden kann.
- MULTIMETER** combina un sistema de contabilización del calor y del agua sanitaria a un grupo MULTIMIX. La parte de contabilización del calor comprende dos válvulas de interceptación en la entrada y la salida del módulo, una válvula de equilibrio, un filtro y el tronco para el alojamiento del contador de calor en el retorno. Gracias a los dos racores excéntricos el sistema se conecta al colector/separador hidráulico del grupo MULTIMIX que según las necesidades específicas se puede completar con los módulos de distribución de alta y/o baja temperatura.

VARIMETER

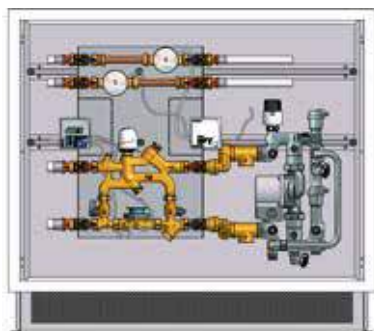

- VARIMETER** è un gruppo di contabilizzazione del solo calore che sfrutta la componentistica del sistema VARIMIX. Il modulo VARIMETER presenta una pompa di rilancio sulla mandata, valvole di intercettazione sul lato utenza, termometri sulla mandata e ritorno e tronchetto per l'alloggiamento del contatore di calore. VARIMETER, come il sistema VARIMIX, può essere collegato ai collettori paralleli VAR 30, creando sottostazioni multiple di contabilizzazione e rilancio. Portate disponibili 1,5 - 2,5 - 3,5 - 6 m³/h.
- VARIMETER** is a metering unit for heat only which exploits the components of the VARIMIX system. The VARIMETER module has a booster pump on the delivery line, shut-off valves on the utility side, thermometers on the delivery and return line and stub pipe housing the heat meter. Like the VARIMIX system, VARIMETER can be connected to parallel VAR 30 manifolds, creating multiple metering and booster substations. Available flow rates 1.5 - 2.5 - 3.5 - 6 m³/h.
- VARIMETER** est un groupe de comptabilisation de la chaleur seule qui exploite les composants du système VARIMIX. Le module VARIMETER possède une pompe de relance sur le refoulement, des vannes d'interception sur le côté installation, des thermomètres sur le refoulement et le retour, et des tricoises pour le logement du compteur de chaleur. VARIMETER peut, comme le système VARIMIX, être relié aux collecteurs parallèles VAR 30, en créant des sous-stations multiples de comptabilisation et de relance. Débits disponibles 1,5 - 2,5 - 3,5 - 6 m³/h.
- VARIMETER** ist eine reine Heizwärme-Messgruppe, die Komponenten des VARIMIX-Systems nutzt. Das VARIMETER-Modul besitzt eine Umwälzpumpe im Vorlauf, Absperrventile auf der Verbraucherseite, Thermometer im Vor- und Rücklauf und ein Passstück zur Aufnahme des Wärmehählers. VARIMETER, wie das VARIMIX-System, kann an die Parallelverteiler VAR 30 angeschlossen werden, um mehrere Unterstationen mit Wärmemengenmessung und Umwälzung anzuschließen. Verfügbare Durchflussraten 1,5 - 2,5 - 3,5 - 6 m³/h.
- VARIMETER** es un grupo que contabiliza solo el calor que utilizan los componentes del sistema VARIMIX. El módulo VARIMETER presenta una bomba de relanzamiento en el impulso, válvulas de interceptación en el lado usuario, termómetros en el impulso y retorno y tronco para el alojamiento del contador de calor. VARIMETER, como el sistema VARIMIX, se puede conectar a los colectores paralelos VAR 30, creando subestaciones múltiples de contabilización y relanzamiento. Caudales disponibles 1,5 - 2,5 - 3,5 - 6 m³/h.

■ COMBIMETER

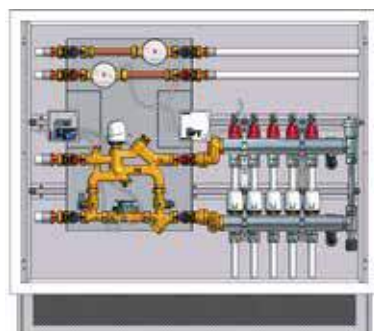

- **COMBIMETER** è un sistema che unisce due prodotti standard del catalogo IVAR: Combimix ed Equimeter. All'interno di un'unica cassetta è possibile quindi avere la contabilizzazione dell'acqua sanitaria (calda e fredda), la contabilizzazione del calore e il gruppo di miscelazione e rilancio per distribuzione a pavimento. Inoltre Combimeter presenta tra il modulo Equimeter e il Combimix dei raccordi a T dai quali è possibile staccare la distribuzione in alta temperatura.
- **COMBIMETER** is a system which unites two standard products of the IVAR catalogue: Combimix and Equimeter. In a single cabinet you can have metering of sanitary water (hot and cold), metering of heat and the mixing and booster unit for floor distribution. Furthermore Combimeter has tee fittings between the Equimeter and Combimix module, from which high temperature distribution can be detached.
- **COMBIMETER** est un système qui unit deux produits standards du catalogue IVAR : Combimix et Equimeter. À l'intérieur d'un seul boîtier, il est donc possible d'avoir la comptabilisation de l'eau sanitaire (chaude et froide), la comptabilisation de la chaleur et le groupe de mélange et de relance pour distribution au sol. En outre, Combimeter présente entre le module Equimeter et le Combimix des raccords en T d'où on peut détacher la distribution en haute température.
- **COMBIMETER** ist ein System, das zwei Standardprodukte des IVAR-Katalogs vereint: Combimix und Equimeter. Innerhalb eines einzigen Schrankes kann die Trinkwassermessung (Warm- und Kaltwasser), die Heizwärmemessung sowie die Regel-/Mischerstation mit Umwälzpumpe für die Fußbodenheizung untergebracht werden. Zusätzlich verfügt Combimeter zwischen dem Combimix-Modul und dem Equimeter-Modul über T-Stücke, an denen Abgänge für die Hochtemperaturverteilung vorgesehen werden können.
- **COMBIMETER** es un sistema que une dos productos estándar del catálogo IVAR: Combimix y Equimeter. Dentro de una única caja, por lo tanto, se puede tener la contabilización del agua sanitaria (caliente y fría), la contabilización del calor y el grupo de mezcla e impulso para la distribución por el suelo. Además Combimeter presenta, entre el módulo Equimeter y el Combimix, unos racores en forma de T de los cuales se puede desconectar la distribución en alta temperatura.

■ COLLMETER



• >>p. 204,316,396,503

- **COLLMETER** è una soluzione preassemblata in cassetta da incasso che prevede il modulo Equimeter collegato a collettori di distribuzione. I collettori sono completi di dispositivi Fluxer per il bilanciamento e visualizzazione della portata sui singoli circuiti, valvole di intercettazione sul ritorno, rubinetti di carico/scarico e valvole sfiato aria. Realizzabile anche con modulo di contabilizzazione MC per grandi portate.
- **COLLMETER** is a pre-assembled solution in a recessed cabinet including an Equimeter module connected to distribution manifolds. The manifolds are complete with Fluxer devices for balancing and displaying the flow rate of the individual circuits, shut-off valves on the return line, filling/draining valves and air vent valves. Also available with MC metering module for large flow rates.
- **COLLMETER** est une solution pré-assemblée dans un boîtier à encastrer qui prévoit le module Equimeter relié à des collecteurs de distribution. Les collecteurs comprennent les dispositifs Fluxer pour l'équilibrage et la visualisation du débit sur chaque circuit, vannes d'interception sur le retour, robinets de chargement/déchargement et purgeurs d'air. Également disponible avec le module de mesure MC pour des débits élevés.
- **COLLMETER** ist eine im Unterputzschrank vormontierte Lösung, bei der das Equimeter-Modul an die Verteilerleitungen angeschlossen wird. Die Verteiler sind mit Fluxer-Einheiten zum Abgleich und Durchflussanzeige der einzelnen Kreise, Absperventile im Rücklauf, Füll-/Entleerhähne sowie Entlüftungsventile ausgestattet. Auch mit MC-Messmodul für hohe Durchflussraten erhältlich.
- **COLLMETER** es una solución pre-ensamblada en caja para empotrar, que prevé el módulo Equimeter conectado a colectores de distribución. Los colectores cuentan con dispositivos Fluxer para el equilibrado y visualización del caudal en cada circuito, válvulas de interceptación en el retorno, grifos de carga/descarga y válvulas para purgar el aire. También disponible con módulo de medición MC para caudales elevados.

Manifold ways	Suitable box	Height	Width	Depth
2	200690	860-960 mm	800 mm	110-160 mm
3	200690	860-960 mm	800 mm	110-160 mm
4	200190	860-960 mm	900 mm	110-160 mm
5	200190	860-960 mm	900 mm	110-160 mm
6	200790	860-960 mm	1.000 mm	110-160 mm
7	200790	860-960 mm	1.000 mm	110-160 mm
8	200290	860-960 mm	1.100 mm	110-160 mm
9	200290	860-960 mm	1.100 mm	110-160 mm
10	200890	860-960 mm	1.200 mm	110-160 mm
11	200890	860-960 mm	1.200 mm	110-160 mm
12	200390	860-960 mm	1.300 mm	110-160 mm
13	200390	860-960 mm	1.300 mm	110-160 mm

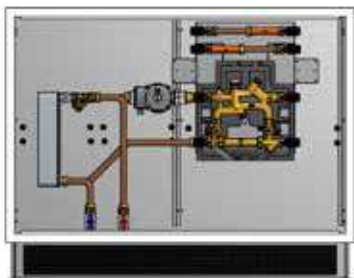
SATMETER

- SATMETER è un modulo EQUIMETER con scambiatore di calore e pompa di rilancio integrati.
- SATMETER is an EQUIMETER module with integrated heat exchanger and booster pump.
- SATMETER est un module EQUIMETER avec échangeur de chaleur et pompe de surpression intégrés.
- SATMETER ist ein EQUIMETER-Modul mit integrierten Wärmetauscher und Druckerhöhungspumpe.
- SATMETER es un módulo EQUIMETER con intercambiador de calor y bomba de refuerzo integrados.

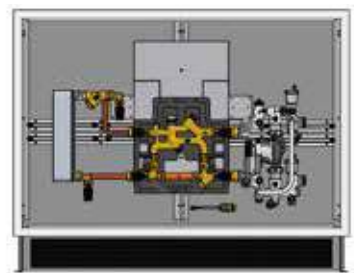
COMBI-SATMETER

- COMBI-SATMETER nasce dall'unione di SATMETER e COMBIMIX.
- COMBI-SATMETER is conceived from combining SATMETER and COMBIMIX.
- COMBI-SATMETER naît de l'union de SATMETER et COMBIMIX.
- COMBI-SATMETER entsteht aus der Vereinigung von SATMETER und COMBIMIX.
- COMBI-SATMETER nace de la unión de SATMETER y COMBIMIX.

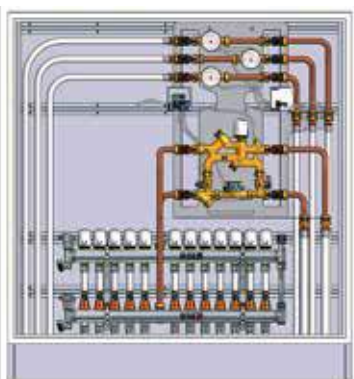
COLLMETER FLOOR

• >>p. 204,316,396,503

- COLLMETER FLOOR presenta gli attacchi dal basso rispetto al COLLMETER standard: tale soluzione prevede un supporto in lamiera appositamente studiato con alette esterne per il fissaggio dei tubi provenienti dal basso. I collettori di distribuzione sono disposti al di sotto del modulo Equimeter e vengono alimentati centralmente sfruttando una delle vie del collettore. La soluzione risulta più compatta orizzontalmente, sviluppandosi in verticale. La seguente tabella suggerisce le cassette consigliate in funzione del numero di uscite del collettore.
- COLLMETER FLOOR has bottom connections with respect to COLLMETER standard: this solution includes a sheet metal support specifically designed with external flaps to fix pipes coming from the floor. The distribution manifolds are arranged underneath the Equimeter module and are fed in the middle by exploiting one of the manifold routes. The solution is more compact horizontally, developing vertically. The following table shows the suggested cabinets depending on the number of manifold outlets.
- COLLMETER FLOOR présente les raccords du bas par rapport à COLLMETER standard : cette solution prévoit un support en tôle expressément étudié avec des ailettes externes pour la fixation des tubes provenant du bas. Les collecteurs de distribution sont disposés au-dessous du module Equimeter et sont alimentés de façon centrale en exploitant une des voies du collecteur. La solution est plus compacte horizontalement, en se développant verticalement. Le tableau suivant suggère les boîtiers conseillés en fonction du nombre de sorties du collecteur.
- Beim COLLMETER FLOOR sind im Gegensatz zum COLLMETER Standard die Anschlüsse unten angeordnet: Diese Lösung besitzt einen speziell entwickelten Blechhalter mit externen Lamellen zur Befestigung der von unten kommenden Leitungen. Die Verteiler sind unterhalb des Equimeter-Moduls angeordnet und werden zentral über einen der Verteileranschlüsse gespeist. Die Lösung ist schmaler, da sie sich mehr in vertikaler Richtung entwickelt. Die folgende Tabelle zeigt das empfohlene Schrankmodell entsprechend der Anzahl der Verteilerabgänge.
- COLLMETER FLOOR presenta las conexiones desde abajo respecto al COLLMETER estándar: dicha solución prevé un soporte de chapa estudiado específicamente con aletas externas para la fijación de los tubos provenientes desde abajo. Los colectores de distribución están colocados por debajo del módulo Equimeter y se alimentan centralmente aprovechando una de las vías del colector. La solución resulta más compacta horizontalmente, desarrollándose en vertical. La siguiente tabla sugiere las cajas aconsejadas en base al número de salidas del collettore.

Manifold ways	Suitable box	Height	Width	Depth
2	200190	860-960 mm	900 mm	110-160 mm
3	200190	860-960 mm	900 mm	110-160 mm
4	200190	860-960 mm	900 mm	110-160 mm
5	200190	860-960 mm	900 mm	110-160 mm
6	200790	860-960 mm	1.000 mm	110-160 mm
7	200790	860-960 mm	1.000 mm	110-160 mm
8	200790	860-960 mm	1.000 mm	110-160 mm
9	200790	860-960 mm	1.000 mm	110-160 mm
10	200290	860-960 mm	1.100 mm	110-160 mm
11	200290	860-960 mm	1.100 mm	110-160 mm
12	200290	860-960 mm	1.100 mm	110-160 mm
13	200290	860-960 mm	1.100 mm	110-160 mm

SEPMEETER

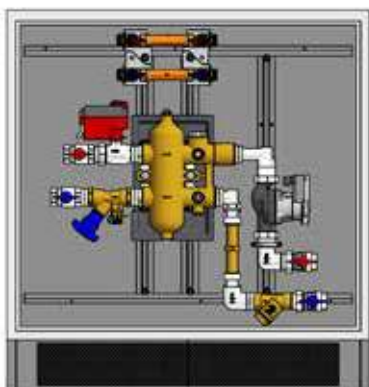

- SEPMEETER è una soluzione che prevede la separazione idraulica tra il circuito primario di caldaia e il circuito della singola utenza. Il sistema prevede un separatore idraulico al centro che divide la parte primaria del modulo, su cui sono montate valvole a sfera di ingresso e uscita e una valvola di bilanciamento, da quella secondaria completa di valvola di ritegno, pompa di rilancio, valvole di intercettazione, filtro e tronchetto per alloggiamento contatore di calore. Il modulo si completa con le linee di distribuzione sanitaria. SEPMEETER è anche disponibile nella variante con valvola miscelatrice sul lato secondario per poter distribuire acqua a bassa temperatura ad impianti radianti.
- SEPMEETER is a solution which hydraulically separates the primary boiler circuit and the single utility circuit. The system has a hydraulic separator in the middle which divides the primary part of the module, upon which inlet and outlet ball valves and a balancing valve are mounted, from the secondary part complete with check valve, booster pump, shut-off valves, filter and stub pipe housing the heat meter. The module is completed with DHW distribution lines. SEPMEETER is also available in the variant with mixer valve on the secondary side to distribute low temperature water to radiant systems.
- SEPMEETER est une solution qui prévoit la séparation hydraulique entre le circuit primaire de la chaudière et le circuit de chaque installation. Le système prévoit un séparateur hydraulique au centre, qui divise la partie primaire du module sur lequel sont montés des soupapes à bille d'entrée et de sortie, et une vanne d'équilibrage, et la partie secondaire avec vanne de retenue, pompe de relance, vannes d'interception, filtre et tricoises pour le logement du compteur de chaleur. Le module se complète avec les lignes de distribution sanitaire. SEPMEETER est également disponible dans la variante avec vanne mélangeuse sur le côté secondaire pour pouvoir distribuer de l'eau à basse température à des installations radiantes.
- SEPMEETER ist eine Lösung für die hydraulische Trennung zwischen Primärkesselkreis und dem Kreislauf der einzelnen Verbraucher. Das System besitzt in der Mitte eine hydraulische Weiche, die den Primärteil des Moduls trennt. In diesem sind Kugelhähne am Zu- und Ablauf sowie ein Abgleichventil installiert, im Sekundärteil sind Rückschlagventil, Umwälzpumpe, Absperrventile, Filter und Passstück für Wärmezähler. Das Modul wird mit den Trinkwasser-Verteilungen vervollständigt. SEPMEETER steht auch als Variante mit Mischventil auf der Sekundärseite zur Verfügung, um Niedertemperaturheizkreise mit Wasser zu versorgen.
- SEPMEETER es una solución que prevé la separación hidráulica entre el circuito primario de la caldera y el circuito del punto de uso individual. El sistema prevé un separador hidráulico al centro que divide la parte primaria del módulo, en el que están montadas las válvulas de esfera de entrada y salida y una válvula de equilibrio, de aquella secundaria con válvula de retención, bomba de relanzamiento, válvulas de interceptación, filtro y tronco para alojamiento del contador de calor. El módulo se completa con las líneas de distribución sanitaria. SEPMEETER también está disponible en la versión con válvula mezcladora en el lado secundario para poder distribuir agua a baja temperatura a las instalaciones radiantes.

COLL-COMBIMETER

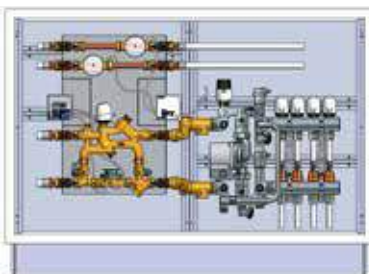

- E' una soluzione che include all'interno di un'unica cassetta un sistema Combimeter e i collettori per la distribuzione a pavimento completi di dispositivi Fluxer per il bilanciamento e la visualizzazione della portata sui singoli circuiti e valvole di intercettazione sul ritorno.
- This solution includes a Combimeter system and manifolds for floor distribution in a single cabinet, complete with Fluxer devices for balancing and displaying the flow rate of the individual circuits and shut-off valves on the return line.
- C'est une solution qui inclut à l'intérieur d'un seul boîtier un système Combimeter et les collecteurs pour la distribution au sol, avec dispositifs Fluxer pour l'équilibrage et la visualisation du débit sur chaque circuit et vannes d'interception sur le retour.
- Es handelt sich um eine Lösung, bei der in einem einzigen Schrank ein Combimeter-System sowie Fußbodenheizungsverteiler mit Fluxer-Einheiten zum Abgleich und Durchflussanzeige der einzelnen Kreise und Absperrventile im Rücklauf installiert sind.
- Es una solución que incluye dentro de una sola caja un sistema Combimeter y los colectores, para la distribución por el suelo, con dispositivos Fluxer para el equilibrio y la visualización del caudal en cada uno de los circuitos y válvulas de interceptación en el retorno.



>> p. 204,316,396,503

Manifold ways	Suitable box	Height	Width	Depth
2	200190	860-960 mm	900 mm	110-160 mm
3	200790	860-960 mm	1.000 mm	110-160 mm
4	200790	860-960 mm	1.000 mm	110-160 mm
5	200290	860-960 mm	1.100 mm	110-160 mm
6	200290	860-960 mm	1.100 mm	110-160 mm
7	200890	860-960 mm	1.200 mm	110-160 mm
8	200890	860-960 mm	1.200 mm	110-160 mm
9	200390	860-960 mm	1.300 mm	110-160 mm
10	200390	860-960 mm	1.300 mm	110-160 mm
11	200490	860-960 mm	1.500 mm	110-160 mm
12	200490	860-960 mm	1.500 mm	110-160 mm
13	200490	860-960 mm	1.500 mm	110-160 mm

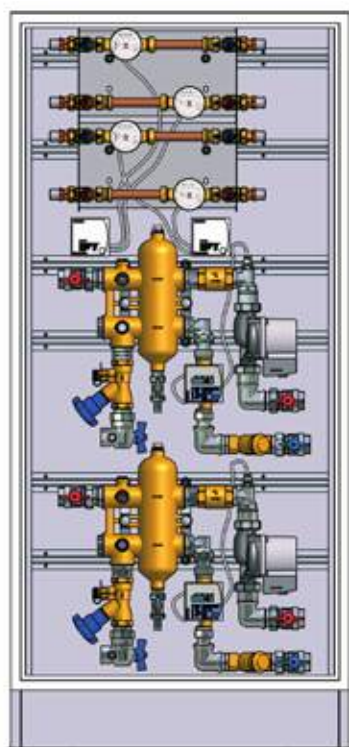
MULTI-SEPMETER

- **MULTI-SEPMETER è un sistema che prevede più SEPMETER alloggiati all'interno della stessa cassetta. Tale soluzione presenta il vantaggio di concentrare in un'unica area le connessioni idrauliche, elettriche e la lettura dei dispositivi.**
- *MULTI-SEPMETER is a system which includes several SEPMETER units housed in the same cabinet. This solution has the advantage of concentrating hydraulic and electrical connections and reading devices in the same area.*
- **MULTI-SEPMETER est un système qui prévoit plusieurs SEPMETER logés à l'intérieur du même boîtier. Cette solution présente l'avantage de concentrer les connexions hydrauliques, électriques et la lecture des dispositifs dans une seule zone.**
- *Bei dem MULTI-SEPMETER-System werden mehrere SEPMETER im gleichen Schrank untergebracht. Diese Lösung bietet den Vorteil, die hydraulischen und elektrischen Anschlüsse sowie den Ablesepunkt der Zähler an einer Stelle zusammenzufassen.*
- **MULTI-SEPMETER es un sistema que prevé varios SEPMETER alojados dentro de la misma caja. Dicha solución presenta la ventaja de concentrar en una única área las conexiones hidráulicas, eléctricas y la lectura de los dispositivos.**

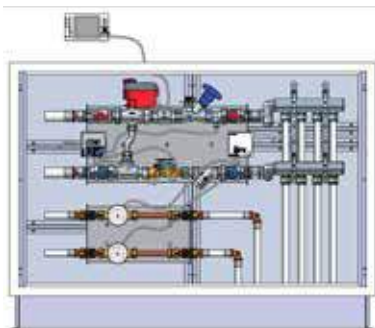
COLL-MC

• >>p. 204,316,396,503

- **È un modulo d'utenza che unisce il modulo MC con i collettori di distribuzione da barra. E' possibile personalizzare i collettori con dispositivi Fluxer di bilanciamento e visualizzazione della portata, valvole di intercettazione sul ritorno, rubinetti carico/scarico e valvole sfiato aria. La seguente tabella riporta le cassette suggerite in funzione del numero di uscite sui collettori.**
- *This utility module unites the MC module with bar distribution manifolds. The manifolds can be customised with Fluxer devices for balancing and displaying the flow rate, shut-off valves on the return line, filling/draining valves and air vent valves. The following table shows the suggested cabinetes depending on the number of manifold outlets.*
- **C'est un module d'installation qui unit le module MC avec les collecteurs de distribution à barre. Il est possible de personnaliser les collecteurs avec dispositifs Fluxer d'équilibrage et de visualisation du débit, vannes d'interception sur le retour, robinets chargement/déchargement et purgeurs d'air. Le tableau suivant reporte les boîtiers suggérés en fonction du nombre de sorties sur les collecteurs.**
- *Dieses Verbrauchermodul vereint das MC-Modul mit den Stangenverteilern. Die Verteiler können mit Fluxer-Einheiten zum Abgleich und Durchflussanzeige, Absperrventile im Rücklauf, Füll-/Entleerhähne sowie Entlüftungsventile individuell angepasst werden. Die folgende Tabelle zeigt das empfohlene Schrankmodell entsprechend der Anzahl der Verteilerabgänge.*
- **Es un módulo de usuario que une el módulo MC con los colectores de distribución de barra. Los colectores se pueden personalizar con dispositivos Fluxer de equilibrio y visualización del caudal, válvulas de interceptación en el retorno, grifos de carga/descarga y válvulas para purgar el aire. La siguiente tabla indica las cajas aconsejadas en base al número de salidas en los colectores.**

Manifold ways	Suitable box	Height	Width	Depth
2	200190	860-960 mm	900 mm	110-160 mm
3	200190	860-960 mm	900 mm	110-160 mm
4	200790	860-960 mm	1.000 mm	110-160 mm
5	200790	860-960 mm	1.000 mm	110-160 mm
6	200290	860-960 mm	1.100 mm	110-160 mm
7	200290	860-960 mm	1.100 mm	110-160 mm
8	200890	860-960 mm	1.200 mm	110-160 mm
9	200890	860-960 mm	1.200 mm	110-160 mm
10	200390	860-960 mm	1.300 mm	110-160 mm
11	200390	860-960 mm	1.300 mm	110-160 mm
12	200490	860-960 mm	1.500 mm	110-160 mm
13	200490	860-960 mm	1.500 mm	110-160 mm

ACCESSORIES FOR METERING MODULES

L-CAP



- Cappuccio di piombatura per valvola di bilanciamento a sfera per moduli Equimeter.
- Meter seal for ball balancing valve for Equimeter modules.
- Capuchon de plombage pour vanne d'équilibrage à bille pour modules Equimeter.
- Verplombungskappe für Steuerkugelventil für Module Equimeter.
- Tapa de emplomadura para la válvula de bola de equilibrado para módulos Equimeter.

Code	Price	Class	Packaging
0063.01	2,433 €	UA	1

AMCD 01



- Guscio di coibentazione per unità di contabilizzazione del calore.
- Insulation shell for heat metering unit.
- Coque d'isolation pour unité de comptabilisation de chaleur.
- Isolierschale für Wärmemesseung Einheit.
- Cobertura aislante para la unidad de contabilización de calor.

Code	Module	Price	Class	Packaging
506704	EQM series	54,18 €	UA	2
506219	MC1 series	96,81 €	UA	2
502510	MC2 series	124,03 €	UA	1
506384	MC4 series	98,28 €	UA	1

M 01



- Pozzetto per sonda di temperatura. Disponibile nella versione in plastica ed ottone.
- Well for temperature probe. Available in plastic and brass version.
- Regard pour sonde de température. Disponible dans la version en plastique et en laiton.
- Schacht für Temperatursonde. Erhältlich in Version aus Plastik und Messing.
- Registro para sonda de temperatura. Disponible en las versiones de plástico y latón.

Code	Size	Price	Class	Packaging
00M100001	M10 x 1 - Plastic	8,14 €	UG	1
00M100003	M10 x 1 - Brass	12,62 €	UG	1

KIT R CAL



- Kit di ricircolo per Equimeter, Equicompact, Equidynamic, MC1, MC2, MC4.
- Recirculation kit for Equimeter, Equicompact, Equidynamic, MC1, MC2, MC4.
- Kit de recirculation pour Equimeter, Equicompact, Equidynamic, MC1, MC2, MC4.
- Rückführung-Bausatz für Equimeter, Equicompact, Equidynamic, MC1, MC2, MC4.
- Kit de recirculación para Equimeter, Equicompact, Equidynamic, MC1, MC2, MC4.

Code	Price	Class	Packaging
KSB0163	121,26 €	UA	1

AC 659 NR



- Valvola a sfera dritta femmina-femmina completa di dado girevole e pozzetto per sonda di temperatura, manovra a farfalla, (rossa).
- Female-female straight ball valve with swivelling nut and well for temperature probe, butterfly operation (red).
- Vanne à bille droite femelle-femelle avec écrou rotatif et regard pour sonde de température, manoeuvre à papillon (rouge).
- Durchgangs-Kugelventil IG-IG mit drehbarer Mutter, Schacht für Temperatursonde und Flügelgriff (rot).
- Válvula de bola recta hembra-hembra completa de tuerca giratoria y registro para sonda de temperatura, vuelta a mariposa (roja).

Code	Size	Color	Price	Class	Packaging
501901NR	3/4" F	■	39,19 €	NO	10 / 40

AC 111



- Pozzetto portasonda con o-ring e tappo.
- Probe-holder fitting with o-ring and plug.
- Raccord porte-sonde avec joint torique et bouchon.
- Anschluss Sondenhalter mit O-ring und Verschluss.
- Racor portasonda con junta tórica y tapa.

Code	Size	Price	Class	Packaging
506227	3/8" x M10	9,18 €	UA	25 / 100

AC 840

- Cassetta murale ad incasso per collettori e moduli MC con altezza e profondità variabili.
- Wall fitted cabinet for manifolds and MC modules with variable height and depth.
- Casette murale encastrable pour collecteurs et modules MC avec hauteur et profondeur variables.
- Einbauwandkasten für Verteiler und Module MC mit variabler Höhe und Tiefe.
- Caja mural de empotrar para colectores y modulos MC de altura y profundidad variables.

Code	Height	Width	Depth	Module	Price	Class	Packaging
200086	600-700 mm	500 mm	80-130 mm	MC3 series	231,99 €	NZ	1
200186	600-700 mm	700 mm	80-130 mm	MC15	275,12 €	NZ	1

AC 830

- Cassetta murale ad incasso per collettori e moduli MC / IVAR-SAT / MULTIMIX / MULTIMIX-C con altezza e profondità variabili.
- Wall fitted cabinet for manifolds and MC / IVAR-SAT / MULTIMIX / MULTIMIX-C modules with variable height and depth.
- Casette murale encastrable pour collecteurs et modules MC / IVAR-SAT / MULTIMIX / MULTIMIX-C avec hauteur et profondeur variables.
- Einbauwandkasten für Verteiler und Module MC / IVAR-SAT / MULTIMIX / MULTIMIX-C mit variabler Höhe und Tiefe.
- Caja mural de empotrar para colectores y modulos MC / IVAR-SAT / MULTIMIX / MULTIMIX-C de altura y profundidad variables.

Code	Height	Width	Depth	Module	Price	Class	Packaging
200590	860-960 mm	600 mm	110-160 mm	MC4 series (3/4")	335,14 €	NZ	1
200090	860-960 mm	700 mm	110-160 mm	MC 1/11/12/13/14 - MC4 series (1") - IVAR-SAT H/L/LE - 3-way Multimix/Multimix-C	342,76 €	NZ	1
200190	860-960 mm	900 mm	110-160 mm	MC2 series - IVAR-SAT HL/HLE	452,88 €	NZ	1

AC 830 S

- Cassetta murale ad incasso per moduli EQM con altezza e profondità variabili.
- Wall fitted box for EQM modules with variable height and depth.
- Casette murale encastrable pour modules EQM avec hauteur et profondeur variables.
- Einbauwandkasten für Module EQM mit variabler Höhe und Tiefe.
- Caja mural de empotrar para modulos EQM de altura y profundidad variables.

Code	Height	Width	Depth	Module	Price	Class	Packaging
200085	770-870 mm	550 mm	110-160 mm	EQM series	276,93 €	NZ	1
200091	1.000-1.100 mm	550 mm	110-160 mm	EQM double H/C	439,47 €	NZ	1
200095	1.900-2.000 mm	700 mm	200 mm	3-module CMI	1.078,95 €	NZ	1

METERS

IVAR offers a complete range of heat meters ranging from the smallest sizes, for use in modules or heating interface units, to larger sizes for use in a heating plant. The smaller counters are compact and are available in both the single-jet mechanical version and the ultrasonic version. Both the single-jet mechanical meter and the ultrasonic meter are available in modular formats with basic versions (for heating only or for heating/cooling), direct reading to which external modules can be applied to obtain versions with M-BUS output, AMR radio or Walk-by. For more specific applications, there are also meters with M-BUS output and two impulse inputs for the connection of domestic hot water flowmeters. All meters comply with the MID directive.

HMR-M



- Contatore di calore meccanico con uscita M-BUS e due ingressi impulsivi per installazione in cassetta.
- Mechanical heat meter with M-BUS output and two pulsed inputs for box installation.
- Compteur de chaleur mécanique avec sortie M-BUS et deux entrées impulsives pour installation dans la cassette.
- Mechanischer Wärmehähler mit M-BUS-Ausgang und zwei Impulseingänge zur Installation in der Kasten.
- Contador de calor mecánico con salida M-BUS y dos entradas impulsivas para instalación en la caja.

Code	Reading	Size	Qp	Type	Accessories	Price	Class	Packaging
HMR15MFI	M-BUS + 2 pulse IN	G 3/4"	1.50 m³/h	Heat/Cold		477,40 €	UG	1
HMR20MFI	M-BUS + 2 pulse IN	G 1"	2.50 m³/h	Heat/Cold		493,61 €	UG	1
HMR15MFI B	M-BUS + 2 pulse IN	G 3/4"	1.50 m³/h	Heat/Cold	Fittings	487,45 €	UG	1
HMR20MFI B	M-BUS + 2 pulse IN	G 1"	2.50 m³/h	Heat/Cold	Fittings	514,03 €	UG	1

HMR-D



- Contatore di calore a lettura diretta per installazione in cassetta.
- Heat meter with direct reading for box installation.
- Compteur de chaleur à lecture directe pour installation dans la cassette.
- Wärmehähler mit direkter Ablesung zur Installation in der Kasten.
- Contador de calor con lectura directa para instalación en la caja.

Code	Reading	Size	Qp	Type	Accessories	Price	Class	Packaging
HMR15DF	Direct reading	G 3/4"	1.50 m³/h	Heat/Cold		499,97 €	UG	1
HMR20DF	Direct reading	G 1"	2.50 m³/h	Heat/Cold		525,63 €	UG	1
HMR15DF B	Direct reading	G 3/4"	1.50 m³/h	Heat/Cold	Fittings	510,01 €	UG	1
HMR20DF B	Direct reading	G 1"	2.50 m³/h	Heat/Cold	Fittings	546,06 €	UG	1

US-QD



- Contatore di calore ad ultrasuoni a lettura diretta per installazione in cassetta.
- Ultrasonic heat meter with direct reading for box installation.
- Compteur de chaleur à ultrasons à lecture directe pour installation dans la cassette.
- Ultraschall-Wärmehähler mit direkter Ablesung zur Installation in der Kasten.
- Contador de calor con ultrasonidos con lectura directa para instalación en la caja.

Code	Reading	Size	Qp	Type	Accessories	Price	Class	Packaging
US15QD	Direct reading	G 3/4"	1.50 m³/h	Heat only		595,30 €	UG	1
US20QD	Direct reading	G 1"	2.50 m³/h	Heat only		626,61 €	UG	1
US15QD B	Direct reading	G 3/4"	1.50 m³/h	Heat only	Fittings	605,35 €	UG	1
US20QD B	Direct reading	G 1"	2.50 m³/h	Heat only	Fittings	647,03 €	UG	1

- È possibile ordinare i contatori completi di bocchettoni utilizzando il codice con la "B" finale.
- It is possible to order the meters complete with fittings using the code with "B" at the end.
- Il est possible de commander les compteurs complets avec raccords en utilisant le code avec le «B» final.
- Es ist möglich, die Zähler komplett mit Stutzen zu bestellen, indem Sie den Code mit dem „B“ am Ende verwenden.
- Es posible pedir los contadores completos con uniones utilizando el código con la "B" al final.

HMRI-K001-001



- Kit di fissaggio a parete per display HMR e US-QD.
- Wall mounting kit for HMR and US-QD display.
- Kit pour montage mural pour écran des compteurs HMR et US-QD.
- Bausatz für die Wandmontage für Anzeige der Zähler HMR und US-QD.
- Kit de montaje en pared para display de los contadores HMR y US-QD.

Code	Price	Class	Packaging
HMRI-K001-001	19,16 €	UG	1

AC 111



- Pozzetto portasonda con o-ring e tappo.
- Probe-holder fitting with o-ring and plug.
- Raccord porte-sonde avec joint torique et bouchon.
- Anschluss Sondenhalter mit O-ring und Verschluss.
- Racor portasonda con junta tórica y tapa.

Code	Size	Price	Class	Packaging
506227	3/8" x M10	9,18 €	UA	25 / 100

MHM5-00A2-00

- Modulo per la conversione del contatore a lettura diretta in un contatore con uscita centralizzabile M-BUS.
- Module to convert the direct-reading meter into a meter with an M-BUS output that can be centralised.
- Module de conversion du compteur à lecture directe en compteur avec sortie centralisée M-BUS.
- Modul zur Umwandlung der Zähler mit direkter Lesung in Zähler mit zentralisierbarem M-BUS-Ausgang.
- Módulo para convertir el contador de lectura directa en contador con salida centralizada M-BUS.

Code	Reading	Price	Class	Packaging
MHM5-00A2-00	Direct reading >> M-BUS (cable included)	290,58 €	UG	1

RHM500

- Modulo per la conversione del contatore a lettura diretta in un contatore con uscita centralizzabile radio WALK-BY / AMR.
- Module to convert the direct-reading meter into a meter with a WALK-BY / AMR radio output that can be centralised.
- Module de conversion du compteur à lecture directe en compteur avec sortie centralisée radio WALK-BY / AMR.
- Modul zur Umwandlung der Zähler mit direkter Lesung in Zähler mit zentralisierbarem WALK-BY / AMR Radio-Ausgang.
- Módulo para convertir el contador de lectura directa en contador con salida centralizada radio WALK-BY / AMR.

Code	Reading	Price	Class	Packaging
RHM500AT0000Z	Direct reading >> Radio WALK-BY / AMR	218,16 €	UG	1

USF

- Contatore di calore a ultrasuoni con uscita M-BUS e due ingressi impulsivi per installazione in cassetta.
- Ultrasonic heat meter with M-BUS output and two pulsed inputs for box installation.
- Compteur de chaleur à ultrasons avec sortie M-BUS et deux entrées impulsives pour installation dans la cassette.
- Ultraschall-Wärmezähler mit M-BUS-Ausgang und zwei Impulseingänge zur Installation in der Kasten.
- Contador de calor con ultrasonidos con salida M-BUS y dos entradas impulsivas para instalación en la caja.

Code	Reading	Size	Qp	Type	Accessories	Price	Class	Packaging
US15F	M-BUS + 2 pulse IN	DN 15	1.50 m³/h	Heat/Cold		778,85 €	UG	1
US20F	M-BUS + 2 pulse IN	DN 20	2.50 m³/h	Heat/Cold		842,04 €	UG	1
US15FB	M-BUS + 2 pulse IN	DN 15	1.50 m³/h	Heat/Cold	Fittings	851,84 €	UG	1
US20FB	M-BUS + 2 pulse IN	DN 20	2.50 m³/h	Heat/Cold	Fittings	1.020,05 €	UG	1
US25-3500F	M-BUS + 2 pulse IN	DN 25	3.50 m³/h	Heat/Cold		1.989,69 €	UG	1
US25-6000F	M-BUS + 2 pulse IN	DN 25	6 m³/h	Heat/Cold		2.058,02 €	UG	1

- È possibile ordinare i contatori DN15 e DN20 completi di bocchettoni utilizzando il codice con la "B" finale.
- It is possible to order the DN15 and DN20 meters complete with fittings using the code with "B" at the end.
- Il est possible de commander les compteurs DN15 et DN20 complets avec raccords en utilisant le même code avec le «B» final.
- Es ist möglich, die Zähler DN15 und DN20 komplett mit Stutzen zu bestellen, indem Sie den Code mit dem „B“ am Ende verwenden.
- Es posible pedir los contadores DN15 y DN20 completos con uniones utilizando el código con la "B" al final.

WFZ-IrDA-USB

- Cavo con interfaccia ottica per la programmazione dei contatori HMR e dei ripartitori. Connessione USB.
- Cable with optical interface for HMR meters and heat cost allocator programming. USB connection.
- Câble avec interface optique pour la programmation des compteurs HMR et des répartiteurs. Connexion USB.
- Kabel mit optischer Schnittstelle für die Programmierung der Zähler HMR und der Verteiler. USB-Verbindung.
- Cable de interfaz óptica para la programación de los contadores HMR y los repartidores. Conexión USB.

Code	Price	Class	Packaging
WFZ-IRDA-USB	638,30 €	UG	1

OG1

- Cavo con interfaccia ottica per la programmazione dei contatori USF.
- Cable with optical interface for USF meters programming.
- Câble avec interface optique pour la programmation des compteurs USF.
- Kabel mit optischer Schnittstelle für die Programmierung der Zähler USF.
- Cable de interfaz óptica para la programación de los contadores USF.

Code	Price	Class	Packaging
OG1	762,86 €	UG	1

WSW5 S

- Software per la programmazione di contatori HMR e ripartitori di calore.
- Software for HMR meters and heat cost allocator programming.
- Logiciel pour la programmation compteurs HMR et répartiteurs de chaleur.
- Software für die Zähler HMR und Wärmeverteiler-Programmierung.
- Software para la programación de los contadores HMR y repartidores de costes de calefacción.

Code	Price	Class	Packaging
WSW5-00CABCG	105,78 €	UG	1

SW-US

- Software di programmazione contatori USF.
- Software for USF meters programming.
- Logiciel pour la programmation des compteurs USF.
- Software für die Programmierung der Zähler USF.
- Software para la programación de los contadores USF.

Code	Price	Class	Packaging
SW-US	1.394,18 €	UG	1

WFK



- **Contatore volumetrico per acqua fredda sanitaria a lettura diretta per installazione in cassetta.**
- *Volumetric meter for domestic cold water with direct reading for box installation.*
- **Compteur volumétrique d'eau froide sanitaire à lecture directe pour installation dans la cassette.**
- *Volumenzähler für Brauchkaltwasser mit direkter Lesung zur Installation in der Kasten.*
- **Contador volumétrico para agua fría sanitaria con lectura directa para instalación en caja.**

Code	Reading	Size	Q3	Type	Accessories	Price	Class	Packaging
WFK30-D110	Direct reading	G 3/4"	2.50 m ³ /h	Cold water (T max 30 °C)		72,83 €	UG	1
WFK30-D130	Direct reading	G 1"	4 m ³ /h	Cold water (T max 30 °C)		93,00 €	UG	1
WFK30-D110B	Direct reading	G 3/4"	2.50 m ³ /h	Cold water (T max 30 °C)	Fittings	82,89 €	UG	1
WFK30-D130B	Direct reading	G 1"	4 m ³ /h	Cold water (T max 30 °C)	Fittings	121,59 €	UG	1

WFW



- **Contatore volumetrico per acqua calda sanitaria a lettura diretta per installazione in cassetta.**
- *Volumetric meter for domestic hot water with direct reading for box installation.*
- **Compteur volumétrique d'eau chaude sanitaire à lecture directe pour installation dans la cassette.**
- *Volumenzähler für Brauchwarmwasser mit direkter Lesung zur Installation in der Kasten.*
- **Contador volumétrico para agua caliente sanitaria con lectura directa para instalación en caja.**

Code	Reading	Size	Q3	Type	Accessories	Price	Class	Packaging
WFW30-D110	Direct reading	G 3/4"	2.50 m ³ /h	Hot water (T max 90 °C)		72,83 €	UG	1
WFW30-D130	Direct reading	G 1"	4 m ³ /h	Hot water (T max 90 °C)		93,00 €	UG	1
WFW30-D110B	Direct reading	G 3/4"	2.50 m ³ /h	Hot water (T max 90 °C)	Fittings	82,89 €	UG	1
WFW30-D130B	Direct reading	G 1"	4 m ³ /h	Hot water (T max 90 °C)	Fittings	121,59 €	UG	1

- **È possibile ordinare i contatori completi di bocchettoni utilizzando il codice con la "B" finale.**
- *It is possible to order the meters complete with fittings using the code with "B" at the end.*
- **Il est possible de commander les compteurs complets avec raccords en utilisant le code avec le «B» final.**
- *Es ist möglich, die Zähler komplett mit Stutzen zu bestellen, indem Sie den Code mit dem „B“ am Ende verwenden.*
- **Es posible pedir los contadores completos con uniones utilizando el código con la "B" al final.**

RWM



- **Modulo per la conversione dei contatori WFK e WFW a lettura diretta in contatori con uscita centralizzabile radio WALK-BY o AMR (S-mode o C-mode).**
- *Module to convert the direct-reading WFK and WFW meters into meters with a WALK-BY or AMR (S-mode or C-mode) radio output that can be centralised.*
- **Module de conversion des compteurs WFK et WFW à lecture directe en compteurs avec sortie centralisée radio WALK-BY ou AMR (S-mode ou C-mode).**
- *Modul zur Umwandlung der Zähler WFK und WFW mit direkter Lesung in Zähler mit zentralisierbarem WALK-BY oder AMR (S-mode oder C-mode) Radio-Ausgang.*
- **Módulo para convertir los contadores WFK y WFW de lectura directa en contadores con salida centralizada radio WALK-BY o AMR (S-mode o C-mode).**

Code	Reading	Price	Class	Packaging
RWM5-000N	Direct reading >> Radio WALK-BY / AMR	164,42 €	UG	1

CAFS-D REED

- Contatore volumetrico per acqua fredda sanitaria a lettura diretta con predisposizione per uscita impulsiva tramite contatto Reed, per installazione in cassetta.
- Volumetric meter for domestic cold water with direct reading and designed for pulsed output via Reed contact, for box installation.
- Compteur volumétrique d'eau froide sanitaire à lecture directe, avec prédisposition pour sortie impulsive au moyen du contact Reed, pour installation dans la cassette.
- Volumenzähler für Brauchkaltwasser mit direkter Lesung und Vorrüstung für einen Impulsausgang über Reed-Kontakt, zur Installation in der Kasten.
- Contador volumétrico para agua fría sanitaria con lectura directa preparado para salida impulsiva con contacto Reed, para instalación en caja.

Code	Reading	Size	Q3	Type	Accessories	Price	Class	Packaging
SFU-P-13SRP	Direct reading	G 3/4"	2.50 m ³ /h	Cold water (T max 30 °C)		57,09 €	UG	1
SFU-P-20SRP	Direct reading	G 1"	4 m ³ /h	Cold water (T max 30 °C)		67,34 €	UG	1
SFU-P-13SRPB	Direct reading	G 3/4"	2.50 m ³ /h	Cold water (T max 30 °C)	Fittings	67,14 €	UG	1
SFU-P-20SRPB	Direct reading	G 1"	4 m ³ /h	Cold water (T max 30 °C)	Fittings	94,20 €	UG	1

CACS-D REED

- Contatore volumetrico per acqua calda sanitaria a lettura diretta con predisposizione per uscita impulsiva tramite contatto Reed, per installazione in cassetta.
- Volumetric meter for domestic hot water with direct reading and designed for pulsed output via Reed contact, for box installation.
- Compteur volumétrique d'eau chaude sanitaire à lecture directe, avec prédisposition pour sortie impulsive au moyen du contact Reed, pour installation dans la cassette.
- Volumenzähler für Brauchwarmwasser mit direkter Lesung und Vorrüstung für einen Impulsausgang über Reed-Kontakt, zur Installation in der Kasten.
- Contador volumétrico para agua caliente sanitaria y lectura directa preparado para salida impulsiva con contacto Reed, para instalación en caja.

Code	Reading	Size	Q3	Type	Accessories	Price	Class	Packaging
SCU-P-13SRP	Direct reading	G 3/4"	2.50 m ³ /h	Hot water (T max 90 °C)		67,61 €	UG	1
SCU-P-20SRP	Direct reading	G 1"	4 m ³ /h	Hot water (T max 90 °C)		89,35 €	UG	1
SCU-P-13SRPB	Direct reading	G 3/4"	2.50 m ³ /h	Hot water (T max 90 °C)	Fittings	77,66 €	UG	1
SCU-P-20SRPB	Direct reading	G 1"	4 m ³ /h	Hot water (T max 90 °C)	Fittings	116,19 €	UG	1

- È possibile ordinare i contatori completi di bocchettoni utilizzando il codice con la "B" finale.
- It is possible to order the meters complete with fittings using the code with "B" at the end.
- Il est possible de commander les compteurs complets avec raccords en utilisant le code avec le «B» final.
- Es ist möglich, die Zähler komplett mit Stutzen zu bestellen, indem Sie den Code mit dem „B“ am Ende verwenden.
- Es posible pedir los contadores completos con uniones utilizando el código con la "B" al final.

CAV-IMP

- Cavo per la conversione del contatore a lettura diretta tipo "-D REED" in un contatore con uscita impulsiva.
- Cable to convert the direct reading meter "-D REED" type into a meter with pulsed output.
- Câble pour la conversion du compteur à lecture directe type "-D REED" en compteur avec sortie impulsive.
- Kabel zur Umwandlung der Zähler mit direkter Lesung Typ "-D REED" in Zähler mit Impulsausgang.
- Cable para convertir el contador de lectura directa tipo "-D REED" en un contador con salida impulsiva.

Code	Reading	Length	Price	Class	Packaging
CAV-IMP	Direct reading >> Impulsive	2 m	27,36 €	UG	1

LOCK 01

- Piombini per contatore
- Lead seals for meter.
- Plombs pour compteur.
- Plombe für Zähler.
- Plomos para contador

Code	Price	Class	Packaging
506445	6,84 €	UG	1

The meters for installation in the technical room can be split. Their volumetric systems can be mechanical-multijet (up to DN 50), Woltmann (for larger sizes up to DN 200) or ultrasound. They include a pair of temperature probes (wet or dry installation) and a calculation unit that uses the information received from the volumetric system and the probes to calculate the energy consumed. Similarly, IVAR is also offering a complete series of domestic water, flowmeters for cold and hot water. These are available for direct reading or for impulse output, in sizes ranging from DN 15 to DN 250.

CACML-I



- **Contatore di calore meccanico multigetto con uscita impulsiva, uscita M-BUS e due ingressi impulsivi per installazione in orizzontale.**
- **Multi-jet mechanical heat meter with pulsed output, M-BUS output and two pulsed inputs for horizontal installation.**
- **Compteur de chaleur mécanique à jet multiple avec sortie impulsive, sortie M-BUS et deux entrées impulsives pour installation horizontale.**
- **Mechanischer Mehrstrahl-Wärmezähler mit Impulsausgang, M-BUS-Ausgang und zwei Impulseingänge zur horizontalen Installation.**
- **Contador de calor mecánico multichorro con salida impulsiva, salida M-BUS y dos entradas impulsivas para instalación horizontal.**



Code	Reading	Size	Qp	Type	Installation	Accessories	Price	Class	Packaging
CACML25IF	Impulsive (H)	DN 25	3.50 m ³ /h	Heat/Cold	Wet		1.303,03 €	UG	1
CACML32IF	Impulsive (H)	DN 32	6 m ³ /h	Heat/Cold	Wet		1.460,49 €	UG	1
CACML40IF	Impulsive (H)	DN 40	10 m ³ /h	Heat/Cold	Dry		1.776,16 €	UG	1
CACML25IFB	Impulsive (H)	DN 25	3.50 m ³ /h	Heat/Cold	Wet	Fittings	1.348,16 €	UG	1
CACML32IFB	Impulsive (H)	DN 32	6 m ³ /h	Heat/Cold	Wet	Fittings	1.518,41 €	UG	1
CACML40IFB	Impulsive (H)	DN 40	10 m ³ /h	Heat/Cold	Dry	Fittings	1.853,39 €	UG	1

HS-I



- **Contatore di calore a ultrasuoni con uscita impulsiva, uscita M-BUS e due ingressi impulsivi per installazione in orizzontale e verticale.**
- **Ultrasonic heat meter with pulsed output, M-BUS output and two pulsed inputs for horizontal and vertical installation.**
- **Compteur de chaleur à ultrasons avec sortie impulsive, sortie M-BUS et deux entrées impulsives pour installation horizontale et verticale.**
- **Ultraschall-Wärmezähler mit Impulsausgang, M-BUS-Ausgang und zwei Impulseingänge zur horizontalen und vertikalen Installation.**
- **Contador de calor con ultrasonidos con salida impulsiva, salida M-BUS y dos entradas impulsivas para instalación horizontal y vertical.**



Code	Reading	Size	Qp	Type	Installation	Accessories	Price	Class	Packaging
HS25FI	Impulsive (H/V)	DN 25	3.60 m ³ /h	Heat/Cold	Wet		1.604,65 €	UG	1
HS32FI	Impulsive (H/V)	DN 32	6 m ³ /h	Heat/Cold	Wet		1.677,63 €	UG	1
HS40FI	Impulsive (H/V)	DN 40	10 m ³ /h	Heat/Cold	Dry		2.053,16 €	UG	1
HS25FIB	Impulsive (H/V)	DN 25	3.60 m ³ /h	Heat/Cold	Wet	Fittings	1.646,77 €	UG	1
HS32FIB	Impulsive (H/V)	DN 32	6 m ³ /h	Heat/Cold	Wet	Fittings	1.715,01 €	UG	1
HS40FIB	Impulsive (H/V)	DN 40	10 m ³ /h	Heat/Cold	Dry	Fittings	2.130,41 €	UG	1
HS50FI	Impulsive (H/V)	DN 50	15 m ³ /h	Heat/Cold	Dry	Flanges	2.840,02 €	UG	1
HS65FI	Impulsive (H/V)	DN 65	25 m ³ /h	Heat/Cold	Dry	Flanges	3.870,86 €	UG	1
HS80FI	Impulsive (H/V)	DN 80	40 m ³ /h	Heat/Cold	Dry	Flanges	4.138,64 €	UG	1
HS100FI	Impulsive (H/V)	DN 100	60 m ³ /h	Heat/Cold	Dry	Flanges	5.340,02 €	UG	1

- È possibile ordinare i contatori completi di bocchettoni utilizzando il codice con la "B" finale.
- It is possible to order the meters complete with fittings using the code with "B" at the end.
- Il est possible de commander les compteurs complets avec raccords en utilisant le code avec le «B» final.
- Es ist möglich, die Zähler komplett mit Stutzen zu bestellen, indem Sie den Code mit dem „B“ am Ende verwenden.
- Es posible pedir los contadores completos con uniones utilizando el código con la "B" al final.

CACML-TOOL



- **Kit per la programmazione dei contatori CACML e HS.**
- **Kit for CACML and HS meters programming.**
- **Kit pour la programmation des compteurs CACML et HS.**
- **Bausatz für die Programmierung der Zähler CACML und HS.**
- **Conjunto para la programación de los contadores CACML y HS.**

Code	Price	Class	Packaging
CACML-TOOL	1.137,71 €	UG	1

CCWO-I

- Contatore di calore tipo Woltmann con uscita impulsiva, uscita M-BUS e due ingressi impulsivi per installazione in orizzontale e verticale.
- Woltmann heat meter with pulsed output, M-BUS output and two pulsed inputs for horizontal and vertical installation.
- Compteur de chaleur de type Woltmann avec sortie impulsive, sortie M-BUS et deux entrées impulsives pour installation horizontale et verticale.
- Wärmehähler vom Typ Woltmann mit Impulsausgang, M-BUS-Ausgang und zwei Impulseingänge zur horizontalen und vertikalen Installation.
- Contador de calor tipo Woltmann con salida impulsiva, salida M-BUS y dos entradas impulsivas para instalación horizontal y vertical.

Code	Reading	Size	Qp	Type	Installation	Price	Class	Packaging
CCW050IF	Impulsive (H/V)	DN 50	15 m ³ /h	Heat/Cold	Dry	2.579,42 €	UG	1
CCW065IF	Impulsive (H/V)	DN 65	25 m ³ /h	Heat/Cold	Dry	2.774,50 €	UG	1
CCW080IF	Impulsive (H/V)	DN 80	40 m ³ /h	Heat/Cold	Dry	2.954,42 €	UG	1
CCW0100IF	Impulsive (H/V)	DN 100	60 m ³ /h	Heat/Cold	Dry	3.114,79 €	UG	1
CCW0125IF	Impulsive (H/V)	DN 125	100 m ³ /h	Heat/Cold	Dry	3.455,13 €	UG	1
CCW0150IF	Impulsive (H/V)	DN 150	150 m ³ /h	Heat/Cold	Dry	4.770,83 €	UG	1
CCW0200IF	Impulsive (H/V)	DN 200	250 m ³ /h	Heat/Cold	Dry	5.902,34 €	UG	1

M-BUS pulse adapter

- Adattatore di impulsi per convertire l'uscita impulsiva in segnale M-BUS
- Pulse adapter to convert the pulsed output into an M-BUS signal
- Adaptateur d'impulsions pour convertir la sortie impulsive en signal M-BUS
- Impulsadapter zur Umwandlung eines Impulsausgangs in M-BUS-Signal.
- Adaptador de impulsos para convertir la salida impulsiva en señal M-BUS

Code	Size	Price	Class	Packaging
AEW310.2	Impulsive (2 Inputs) >> M-BUS	208,50 €	UG	1
ADA4	Impulsive (4 Inputs) >> M-BUS	328,29 €	UG	1

WALK-BY pulse adapter

- Adattatore di impulsi per convertire l'uscita impulsiva in segnale radio WALK-BY
- Pulse adapter to convert the pulsed output into a WALK-BY radio signal
- Adaptateur d'impulsions pour convertir la sortie impulsive en signal radio WALK-BY
- Impulsadapter zur Umwandlung eines Impulsausgangs in WALK-BY Radiosignal.
- Adaptador de impulsos para convertir la salida impulsiva en señal de radio WALK-BY

Code	Size	Price	Class	Packaging
AEW366.2	Impulsive (2 Inputs) >> Radio WALK-BY	223,59 €	UG	1

AMR pulse adapter

- Adattatore di impulsi per convertire l'uscita impulsiva in segnale radio AMR
- Pulse adapter to convert the pulsed output into an AMR radio signal
- Adaptateur d'impulsions pour convertir la sortie impulsive en signal radio AMR
- Impulsadapter zur Umwandlung eines Impulsausgangs in AMR Radiosignal.
- Adaptador de impulsos para convertir la salida impulsiva en señal de radio AMR

Code	Size	Price	Class	Packaging
AEW366.2	Impulsive (2 Inputs) >> Radio AMR	226,32 €	UG	1

ACT 20

- Software per la programmazione degli adattatori AEW.
- Software for AEW adapters programming.
- Logiciel pour la programmation des adaptateurs AEW.
- Software für die Programmierung der Adapter AEW.
- Software para la programación de los adaptadores AEW.

Code	Price	Class	Packaging
ACT20	381,28 €	UG	1

WFZ-MBM-USB

- Cavo per la programmazione degli adattatori AEW.
- Cable for AEW adapters programming.
- Câble pour la programmation des adaptateurs AEW.
- Kabel für die Programmierung der Adapter AEW.
- Cable para la programación de los adaptadores AEW.

Code	Price	Class	Packaging
WFZ-MBM-USB	1.676,98 €	UG	1

■ AFUL



- **Contatore volumetrico per acqua fredda sanitaria con uscita impulsiva per installazione in orizzontale e verticale**
- *Volumetric meter for domestic cold water with pulsed output for horizontal and vertical installation*
- **Compteur volumétrique d'eau froide sanitaire avec sortie impulsive pour installation horizontale et verticale**
- *Volumenzähler für Brauchkaltwasser mit Impulsausgang zur horizontalen und vertikalen Installation*
- **Contador volumétrico para agua fría sanitaria con salida impulsiva para instalar en horizontal y vertical**

Code	Reading	Size	Q3	Type	Price	Class	Packaging
AFUL25	Impulsive (H/V)	DN 25	6.30 m³/h	Cold water	199,82 €	UG	1
AFUL32	Impulsive (H/V)	DN 32	10 m³/h	Cold water	246,34 €	UG	1
AFUL40	Impulsive (H/V)	DN 40	16 m³/h	Cold water	485,08 €	UG	1
AFUL50	Impulsive (H/V)	DN 50	25 m³/h	Cold water	873,60 €	UG	1

■ ACUL



- **Contatore volumetrico per acqua calda sanitaria con uscita impulsiva per installazione in orizzontale e verticale**
- *Volumetric meter for domestic hot water with pulsed output for horizontal and vertical installation*
- **Compteur volumétrique d'eau chaude sanitaire avec sortie impulsive pour installation horizontale et verticale**
- *Volumenzähler für Brauchwarmwasser mit Impulsausgang zur horizontalen und vertikalen Installation*
- **Contador volumétrico para agua caliente sanitaria con salida impulsiva para instalar en horizontal y vertical**

Code	Reading	Size	Q3	Type	Price	Class	Packaging
ACUL25	Impulsive (H/V)	DN 25	6.30 m³/h	Hot water	232,42 €	UG	1
ACUL32	Impulsive (H/V)	DN 32	10 m³/h	Hot water	279,73 €	UG	1
ACUL40	Impulsive (H/V)	DN 40	16 m³/h	Hot water	523,74 €	UG	1
ACUL50	Impulsive (H/V)	DN 50	25 m³/h	Hot water	992,78 €	UG	1

■ CAFSWO-I



- **Contatore volumetrico tipo Woltmann per acqua fredda sanitaria con uscita impulsiva per installazione in orizzontale e verticale**
- *Woltmann volumetric meter for domestic cold water with pulsed output for horizontal and vertical installation*
- **Compteur volumétrique de type Woltmann d'eau froide sanitaire avec sortie impulsive pour installation horizontale et verticale**
- *Volumenzähler vom Typ Woltmann für Brauchkaltwasser mit Impulsausgang zur horizontalen und vertikalen Installation*
- **Contador volumétrico tipo Woltmann para agua fría sanitaria con salida impulsiva para instalar en horizontal y vertical**

Code	Reading	Size	Q3	Type	Price	Class	Packaging
CAFSWO65I	Impulsive (H/V)	DN 65	25 m³/h	Cold water	910,27 €	UG	1
CAFSWO80I	Impulsive (H/V)	DN 80	40 m³/h	Cold water	1.064,25 €	UG	1
CAFSWO100I	Impulsive (H/V)	DN 100	60 m³/h	Cold water	1.111,80 €	UG	1
CAFSWO125I	Impulsive (H/V)	DN 125	100 m³/h	Cold water	1.322,38 €	UG	1
CAFSWO150I	Impulsive (H/V)	DN 150	150 m³/h	Cold water	1.548,81 €	UG	1
CAFSWO200I	Impulsive (H/V)	DN 200	250 m³/h	Cold water	2.603,98 €	UG	1

■ CACSWO-I



Factory tested

- **Contatore volumetrico tipo Woltmann per acqua calda sanitaria con uscita impulsiva per installazione in orizzontale e verticale**
- *Woltmann volumetric meter for domestic hot water with pulsed output for horizontal and vertical installation*
- **Compteur volumétrique de type Woltmann d'eau chaude sanitaire avec sortie impulsive pour installation horizontale et verticale**
- *Volumenzähler vom Typ Woltmann für Brauchwarmwasser mit Impulsausgang zur horizontalen und vertikalen Installation*
- **Contador volumétrico tipo Woltmann para agua caliente sanitaria con salida impulsiva para instalar en horizontal y vertical**

Code	Reading	Size	Q3	Type	Price	Class	Packaging
CACSWO65I	Impulsive (H/V)	DN 65	25 m³/h	Hot water	1.050,66 €	UG	1
CACSWO80I	Impulsive (H/V)	DN 80	40 m³/h	Hot water	1.107,92 €	UG	1
CACSWO100I	Impulsive (H/V)	DN 100	60 m³/h	Hot water	1.248,22 €	UG	1
CACSWO125I	Impulsive (H/V)	DN 125	100 m³/h	Hot water	1.421,53 €	UG	1
CACSWO150I	Impulsive (H/V)	DN 150	150 m³/h	Hot water	1.801,16 €	UG	1
CACSWO200I	Impulsive (H/V)	DN 200	250 m³/h	Hot water	2.203,49 €	UG	1

Thermoregulation and metering guarantee independent management and transparency in the measurement of consumption for central heating systems in apartment buildings. In vertical distribution systems, heat distributors are used for metering purposes, which, when programmed based on the characteristics of the heating unit, count units in proportion to consumption. IVAR offers a complete range of heat distributors in compliance with EN 834 and accessories for programming, installation, data centralisation and reading. Thermoregulation is entrusted to thermostatic valves with low thermal inertia or to the smart CUBODOMO® system.

Thermoregulation makes individual management (unit A - B - C) of each person's comfort conditions possible. These conditions are chosen by the user and maintained automatically by the control system. **Metering** makes it possible to monitor consumption levels and to pay the main share of the heating expenditure on the basis of those levels.

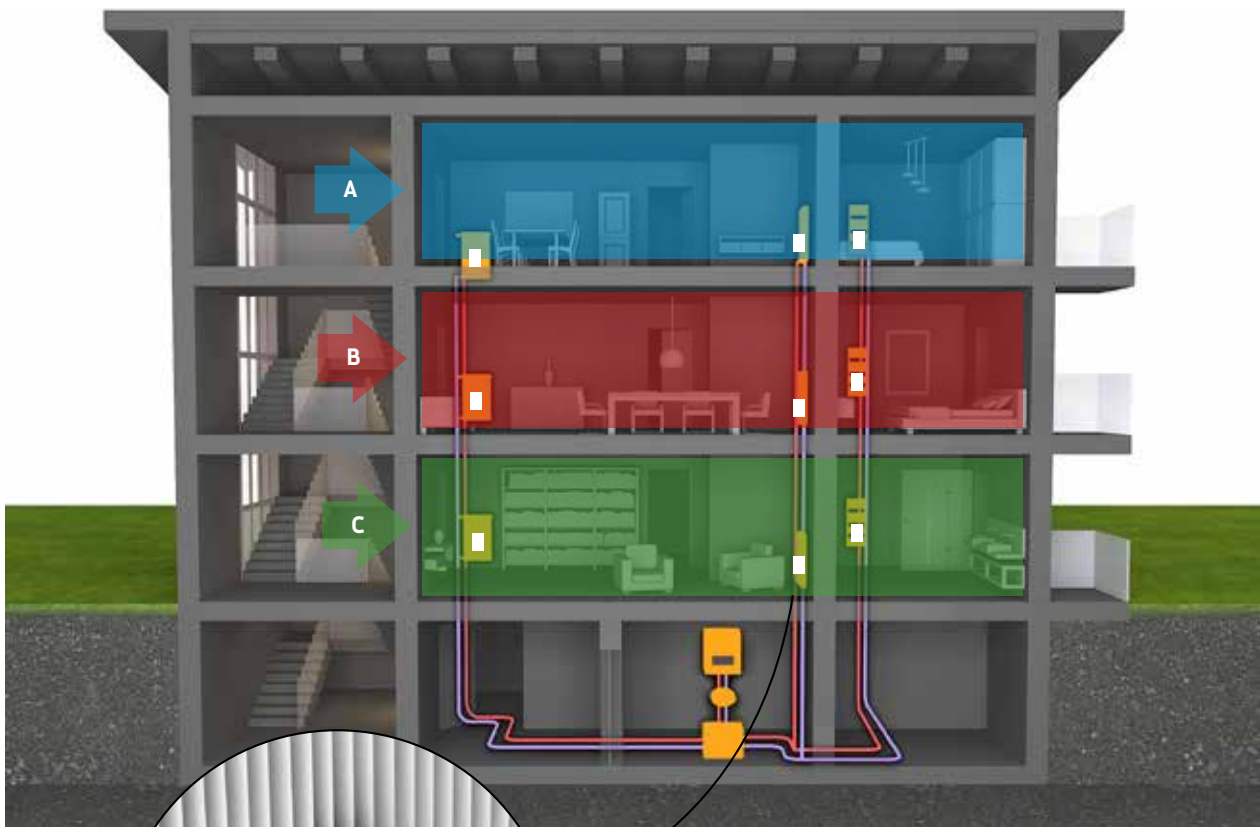

HEAT COST ALLOCATOR

This is an EN 834-compliant device for indirect metering of heating consumption.

It is programmed according to the characteristics of the specific radiator before installation so that there is proportionality between the metering and the energy consumed.

Communications can occur in two distinct modes: S-mode and C-mode (parallel transmission of AMR and Walk-by telegrams).

■ Q5.5 C-mode



- Ripartitore di calore a due sensori - modalità Walk-by e AMR in C-mode.
- Walk-by and AMR heat cost allocator in C-mode with 2 sensors.
- Répartiteur de chaleur Walk-by et AMR en C-mode avec 2 capteurs.
- Walk-by und AMR Heizkostenverteiler in C-Mode mit 2 Fühlern.
- Repartidores de costes de calefacción Walk-by y AME en C-mode con 2 sensores.

Code	Size	Price	Class	Packaging
551004	2 SENSORS - WALK-BY/AMR - C mode	121,15 €	UC	1

■ KSPR



- Kit di supporto a parete per ripartitore con sensore remoto.
- Wall mounting kit for heat cost allocators with remote sensor.
- Kit pour montage mural pour les répartiteurs équipés de capteur à distance.
- Bausatz für die Wandmontage für Heizkostenverteiler mit Fernfühler.
- Kit de montaje en pared para repartidores con sensor de distancia.

Code	Price	Class	Packaging
551024	8,12 €	UC	1

■ AMU 05



- Sigillo antimanomissione piastra di fissaggio.
- Fixing plate tamper evident seal.
- Scellé anti-altération de la plaque de fixation.
- Versiegelung Beschädigungsschutz Befestigungsplatte
- Precinto contra las manipulaciones indebidas de la placa de fijación.

Code	Price	Class	Packaging
551081	0,688 €	UC	1

■ AMU 15



- Basetta per la programmazione dei ripartitori privi di interfaccia ottica IrDA.
- Base for heat cost allocator programming without IrDA optical interface.
- Plaque pour la programmation des répartiteurs dépourvus d'interface optique IrDA.
- Klemmbrett für die Programmierung der Verteiler ohne optische Schnittstelle IrDA.
- Placa para la distribución de los repartidores que no disponen de interfaz óptica IrDA.

Code	Price	Class	Packaging
HCAP-H001-001	483,57 €	UC	1

■ WSW5 DB



- Database KC per la programmazione dei ripartitori di calore.
- KC database for heat cost allocator programming.
- Database KC pour la programmation des répartiteurs de chaleur.
- Database KC für die Wärmeverteiler-Programmierung.
- Database KC para la programación de los repartidores de costes de calefacción.

Code	Price	Class	Packaging
WSW5-00KCBCG	106,02 €	UG	1

■ AMS 01



- Dado con codolo per montaggio a saldatura.
- Nut with a shank for welded assembly.
- Embout à écrou pour montage à souder.
- Mutter mit Schaft für Schweißmontage.
- Tuerca con espiga para el montaje con soldadura.

Code	Size	Price	Class	Packaging
551043	M3 x 3 mm	1,163 €	UC	1
551044	M3 x 6 mm	1,163 €	UC	1
551045	M3 x 9,5 mm	1,376 €	UC	1

■ AMS 02



- Rondella per montaggio a saldatura.
- Washer for welded assembly.
- Rondelle pour montage à souder.
- Unterlegscheibe für Schweißmontage.
- Arandela para el montaje con soldadura.

Code	Size	Price	Class	Packaging
551083	M4	0,107 €	UC	1

■ WFZ-IrDA-USB



- Cavo con interfaccia ottica per la programmazione dei contatori HMR e dei ripartitori. Connessione USB.
- Cable with optical interface for HMR meters and heat cost allocators programming. USB connection.
- Câble avec interface optique pour la programmation des compteurs HMR et des répartiteurs. Connexion USB.
- Kabel mit optischer Schnittstelle für die Programmierung der Zähler HMR und der Verteiler. USB-Verbindung.
- Cable de interfaz óptica para la programación de los contadores HMR y los repartidores. Conexión USB.

Code	Price	Class	Packaging
WFZ-IRDA-USB	638,30 €	UG	1

■ WSW5 S



- Software per la programmazione di contatori HMR e ripartitori di calore.
- Software for HMR meters and heat cost allocator programming.
- Logiciel pour la programmation compteurs HMR et répartiteurs de chaleur.
- Software für die Zähler HMR und Wärmeverteiler-Programmierung.
- Software para la programación de los contadores HMR y repartidores de costes de calefacción.

Code	Price	Class	Packaging
WSW5-00CABCG	105,78 €	UG	1



• Radio WALK-BY >>> p. 523



• Radio AMR >>> p. 522

Q5 FIXING KITS

Q5 FIX 008



Code	Price	Class	Packaging
551008	9,06 €	UC	1

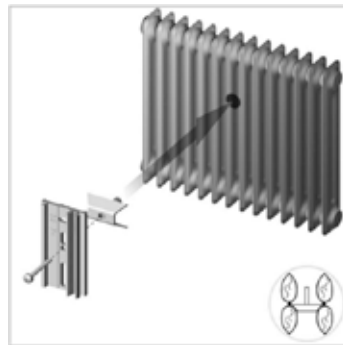

Q5 FIX 009



Code	Price	Class	Packaging
551009	37,71 €	UC	1



Q5 FIX 010



Code	Price	Class	Packaging
551010	21,88 €	UC	1

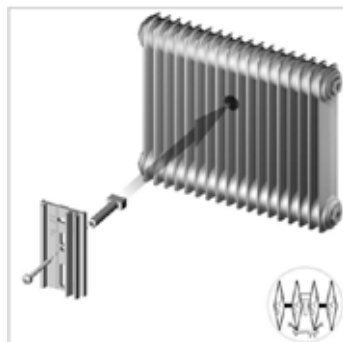

Q5 FIX 011



Code	Price	Class	Packaging
551011	14,90 €	UC	1



Q5 FIX 012



Code	Price	Class	Packaging
551012	11,20 €	UC	1

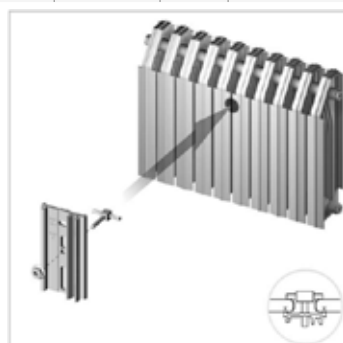

Q5 FIX 013



Code	Price	Class	Packaging
551013	30,26 €	UC	1



■ Q5 FIX 014



Code	Price	Class	Packaging
551014	7,44 €	UC	1

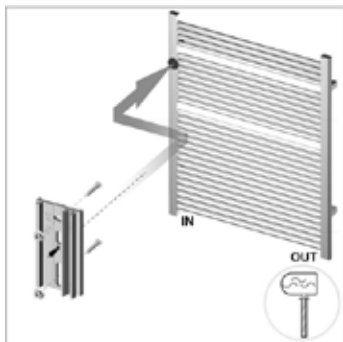

■ Q5 FIX 015



Code	Price	Class	Packaging
551015	7,44 €	UC	1

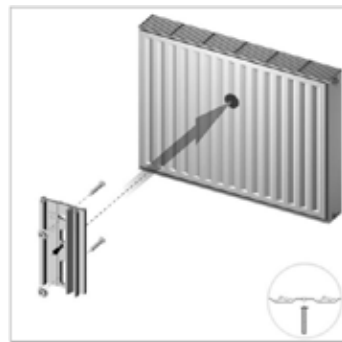

■ Q5 FIX 016



Code	Price	Class	Packaging
551016	60,27 €	UC	1



■ Q5 FIX 017



Code	Price	Class	Packaging
551017	8,84 €	UC	1



■ Q5 FIX 018



Code	Price	Class	Packaging
551018	7,21 €	UC	1



■ Q5 FIX 019



Code	Price	Class	Packaging
551019	37,01 €	UC	1

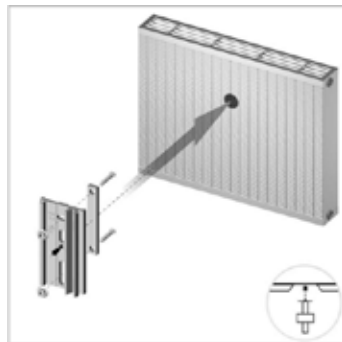

■ Q5 FIX 020



Code	Price	Class	Packaging
551020	7,21 €	UC	1



■ Q5 FIX 021



Code	Price	Class	Packaging
551021	12,11 €	UC	1



■ Q5 FIX 022



Code	Price	Class	Packaging
551022	39,09 €	UC	1



■ Q5 FIX 023



Code	Price	Class	Packaging
551023	12,59 €	UC	1



■ AMU 01



- Sensore remoto (posizionamento su radiatore).
- Remote sensor (positioning on radiator).
- Capteur à distance (positionnement sur radiateur).
- Fernfühler (Positionierung am Radiator)
- Sensor remoto (colocación en radiadores).

Code	Length	Price	Class	Packaging
551025	1.50 m	48,91 €	UC	1
551026	2.50 m	58,21 €	UC	1
551027	5 m	83,83 €	UC	1

■ AMU 10



- Coperchio di sicurezza per corpo sensore.
- Safety cover for sensor body.
- Couvercle de sécurité pour corps capteur.
- Sicherheitsabdeckung für Sensorkörper
- Tapa de seguridad para el cuerpo del sensor.

Code	Price	Class	Packaging
551082	2,326 €	UC	1

AMU 01 FIXING KITS

■ AMU 01 FIX 028



Code	Price	Class	Packaging
551028	56,38 €	UC	1



■ AMU 01 FIX 029



Code	Price	Class	Packaging
551029	85,22 €	UC	1

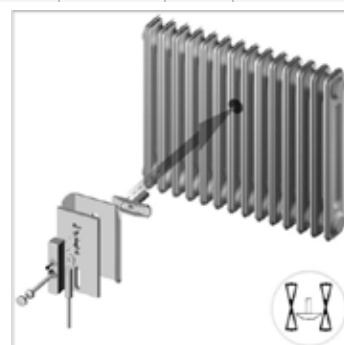

■ AMU 01 FIX 030



Code	Price	Class	Packaging
551030	56,38 €	UC	1

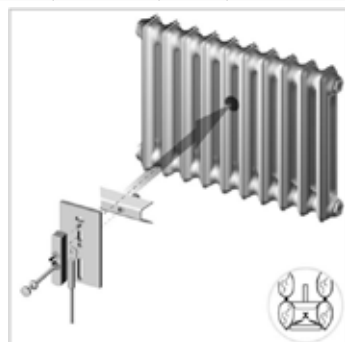

■ AMU 01 FIX 031



Code	Price	Class	Packaging
551031	62,42 €	UC	1

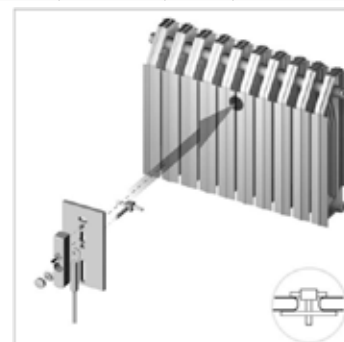

AMU 01 FIX 032

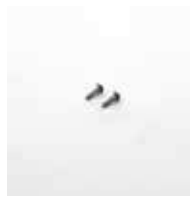

Code	Price	Class	Packaging
551032	4,45 €	UC	1

AMU 01 FIX 033

Code	Price	Class	Packaging
551033	4,213 €	UC	1

AMU 01 FIX 034

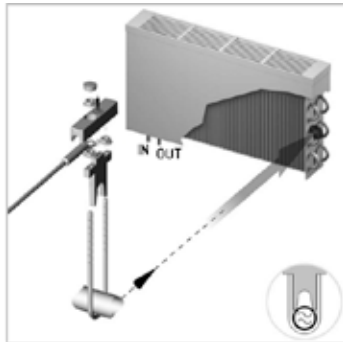
Code	Price	Class	Packaging
551034	19,80 €	UC	1

AMU 01 FIX 035

Code	Price	Class	Packaging
551035	59,82 €	UC	1

AMU 01 FIX 036

Code	Price	Class	Packaging
551036	59,35 €	UC	1



DATA CENTRALISATION

In small plants, personnel can read consumption data directly from the individual meters/distributors. On the other hand, in large buildings, where there are numerous metering devices, it is advisable to centralise the data in a single collection point. This strategy not only makes reading operations much easier it also eliminates the age-old problem of access to private homes and offers security and flexibility for billing management.

The concentration of data at one point requires the use of measuring instruments and centralisation devices suitable for the chosen solution, which can be with M-BUS or radio data transmission (AMR or Walk-By).

IVAR is also able to provide consultation and data processing services through its IVAR CLOUD dedicated portal.

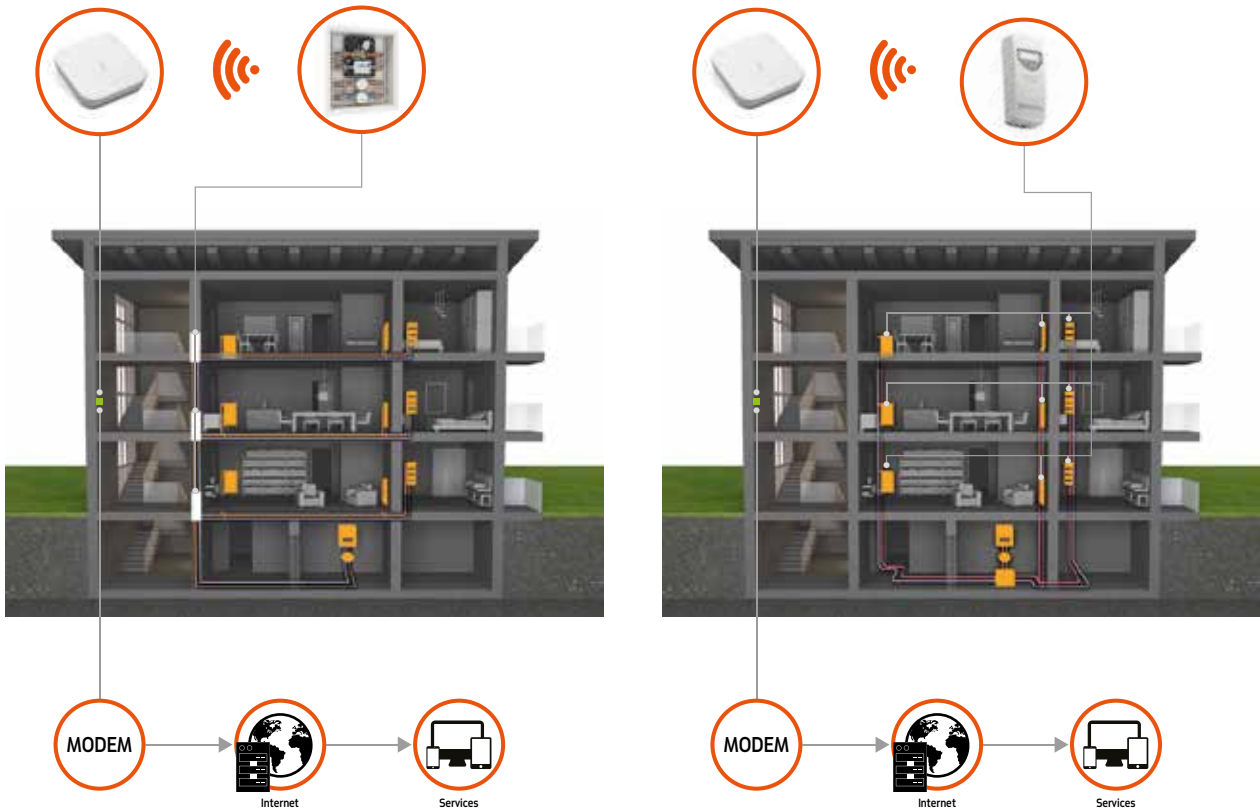

Direct metering

Systems, where the heat consumed can be measured by the housing unit at a single point, are metered at the connections between the boiler and the distribution manifold.

Indirect metering

Vertical distribution systems with more than one input/output to a user component are metered at the level of the individual radiator

IVAR CLOUD



M-BUS SYSTEMS

The M-BUS communications protocol is one of the most frequently used in of direct metering system installations with heat meters and domestic water flowmeters. This is an open system, in compliance with the EN 1434-3 European standard, which provides for the wiring between the various devices (in branch configuration, star configuration or in line) until a collection point is reached where the data concentrator is located. This device allows the individual instruments installed along the backbone to be read, thus facilitating consumption data collection operations.

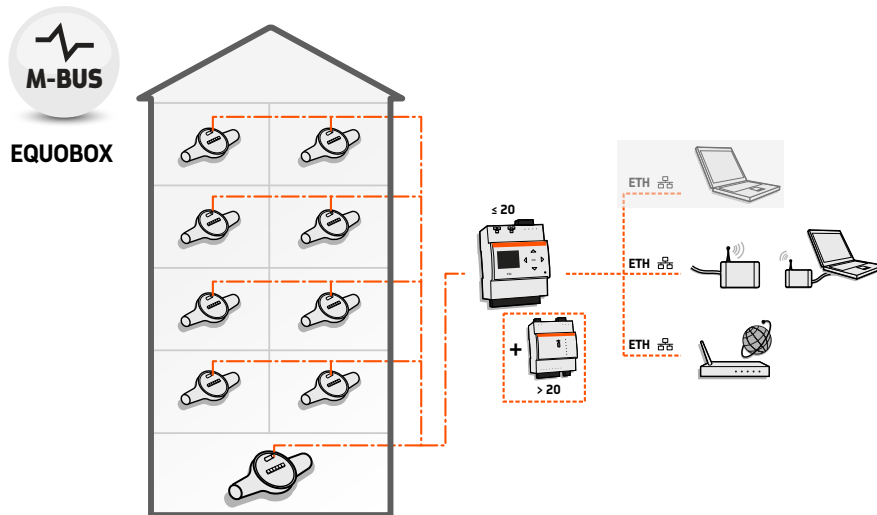

The EQUOBOX system is essentially characterised by its modularity and by how easy and intuitive it is to use. The system is based on three modules that can be combined to create more and more complex architectures.

The modules are:

- Unit GWYMH, which is a central unit, includes a display and data logger function for data acquisition and archiving. Allows up to 20 devices to be read via M-BUS protocol and is expandable to read up to 500 device loads on two separate M-BUS lines (each of max 250 devices) by adding an appropriate Level Converter (B12). The same GWYMH unit also functions as a gateway for Multi-hop radio AMR systems and via dedicated backbone composed of RPTMH antennas is able to read up to 2500 W-MBUS devices, allowing storage of daily readings for up to 10 years.
- The B12 Level Converter is a device that allows the actual reading of M-BUS devices. Each Level Converter can read up to 60 devices. However, it is expandable by connecting other Level Converters, which can also act as repeaters in the case of particularly large backbones. This device has no display, but allows local reading via PC, USB interface and free reading software. Data archiving is not possible.

GWYMH

- Gateway multi-hop wireless + M-BUS cablato.
- Gateway multi-hop wireless + wired M-BUS.
- Passerelle à plusieurs bonds sans fil + M-BUS avec fil.
- Drahtloses Multi-Hop + verdrahtet M-BUS Gateway.
- Gateway multi-hop inalámbrico + M-BUS alámbrico.

Code	Reading	Price	Class	Packaging
590153	Max 2500 devices wireless + 500 wired	2.297,61 €	UG	1

B12

- Modulo Level Converter per la lettura di 60 carichi.
- Level Converter for reading 60 loads.
- Module convertisseur de niveaux pour la lecture de 60 charges.
- Level-Converter-Modul für das Auslesen von 60 Geräten.
- Módulo Level Converter para la lectura de 60 cargas.

Code	Reading	Size	Price	Class	Packaging
590130	Max 60 devices	24 VAC – 12 W	1.148,24 €	UG	1

AB10

- Alimentatore 24 V DC.
- 24 V DC power supply.
- Alimentateur 24 V DC.
- Netzteil 24 V DC.
- Alimentador de 24 V CC.

Code	Size	Price	Class	Packaging
590133	24 VDC – 15 W	157,05 €	UG	1
590134	24 VDC – 60 W	193,35 €	UG	1

MOD 02

- Router per la lettura remota delle unità centrali.
- Router for remote reading of the central units.
- Router pour la lecture à distance des unités centrales.
- Router für das Fernauslesen der Zentraleinheiten.
- Router para la lectura a distancia de las unidades centrales.

Code	Price	Class	Packaging
590135	890,06 €	UG	1



AMR RADIO SYSTEM

The AMR radio system provides for wireless communication between the installed measurement devices and the data collection devices. IVAR offers two different opportunities for backbone construction: a single-hop mode and a multi-hop mode.

The single-hop mode is essentially based on two devices that work using standard procedures allowed by the W-MBUS: it is a repeater (code 590140) and a gateway (code 590136). Both items are able to receive data from devices (meters, distributors, pulse adapters, etc.) installed up to a maximum limit of 200 wireless devices on the network created. The only limit is represented by the size of the network: the connection between gateway and repeater can only take place if it is direct between the two devices. Actually, it is not possible to create a backbone in which several repeaters connect to each other and then to the gateway. This feature makes the single-hop system suitable for small apartment buildings.

The gateway is equipped with a data SIM which allows remote reading of the metering data. The reading is made with a weekly transmission frequency.

The multi-hop mode is also based on two devices, namely a repeater (code 590138) and a gateway (code 590153). Nevertheless, this technology is freed from the wireless M-BUS in the construction of the backbone and, thanks to a proprietary and enhanced transmission mode, each repeater (and only the repeaters) is able to receive consumption information from the installed devices and exchange it via a mesh network with the other nodes (repeaters) until it reaches the gateway.

Through the new gateway, the maximum limit of radio devices which can be read is 2500, using the corresponding repeaters (code 590138) up to a maximum of 23, each of which offers a maximum of 500 devices.

Furthermore, the multi-hop gateway is of hybrid type: it can read up to 2500 wireless devices, but also has an M-BUS port that allows the direct wired connection of up to 20 M-BUS meters, which is expandable up to 500 using two backbones and special level converters (code 590130) or WTT16.RNN5 antennas.

SINGLE-HOP

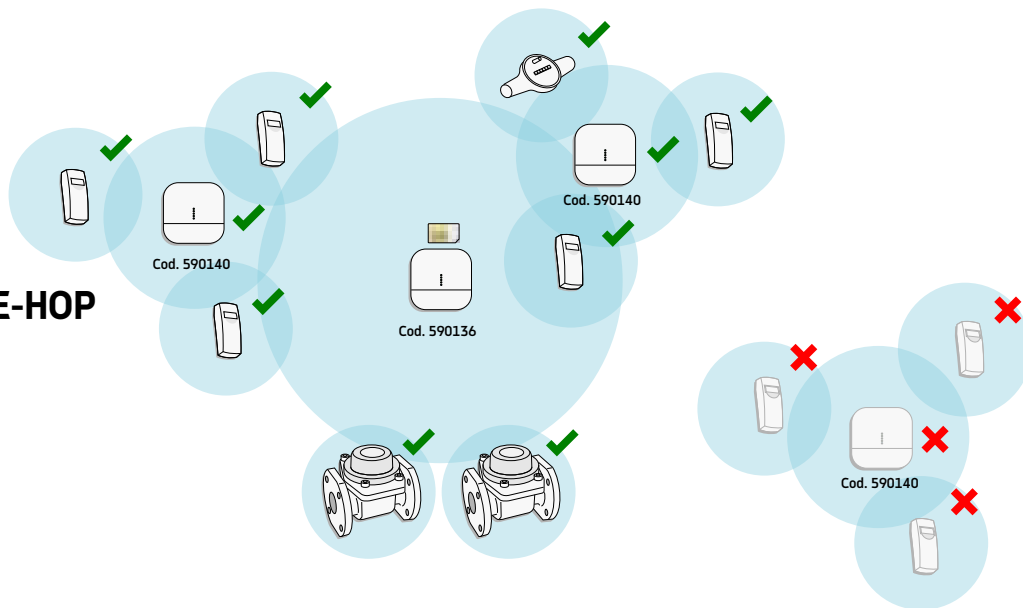

MULTI-HOP

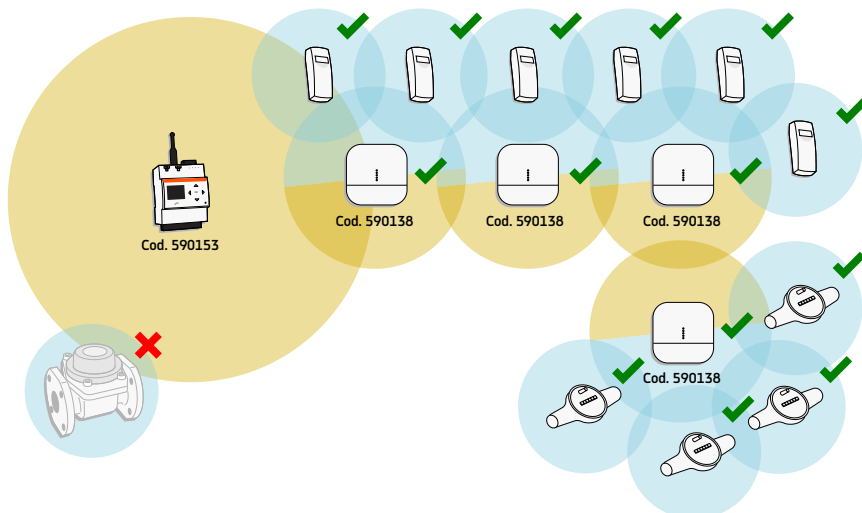

Both systems are compatible with the standard W-MBUS transmission modes and are therefore able to read devices made by other manufacturers (provided they communicate in W-MBUS) whether in T, S or C modes. Each gateway can be read locally or remotely by internet connection (in case there is no ADSL, a router is provided).

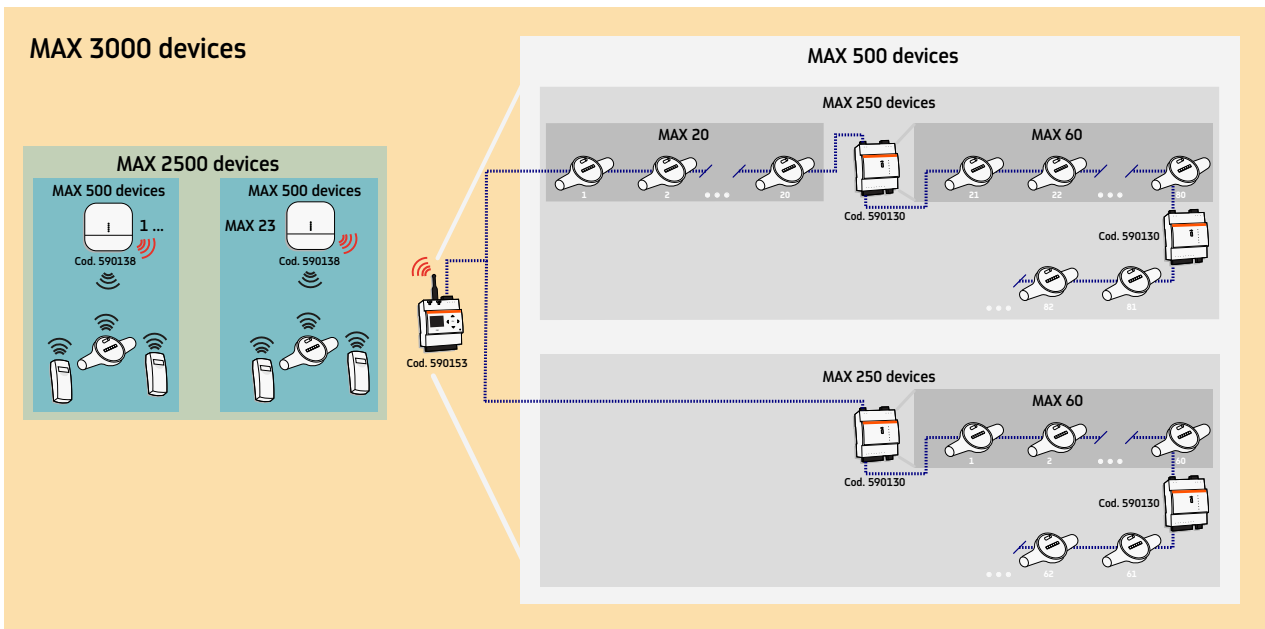
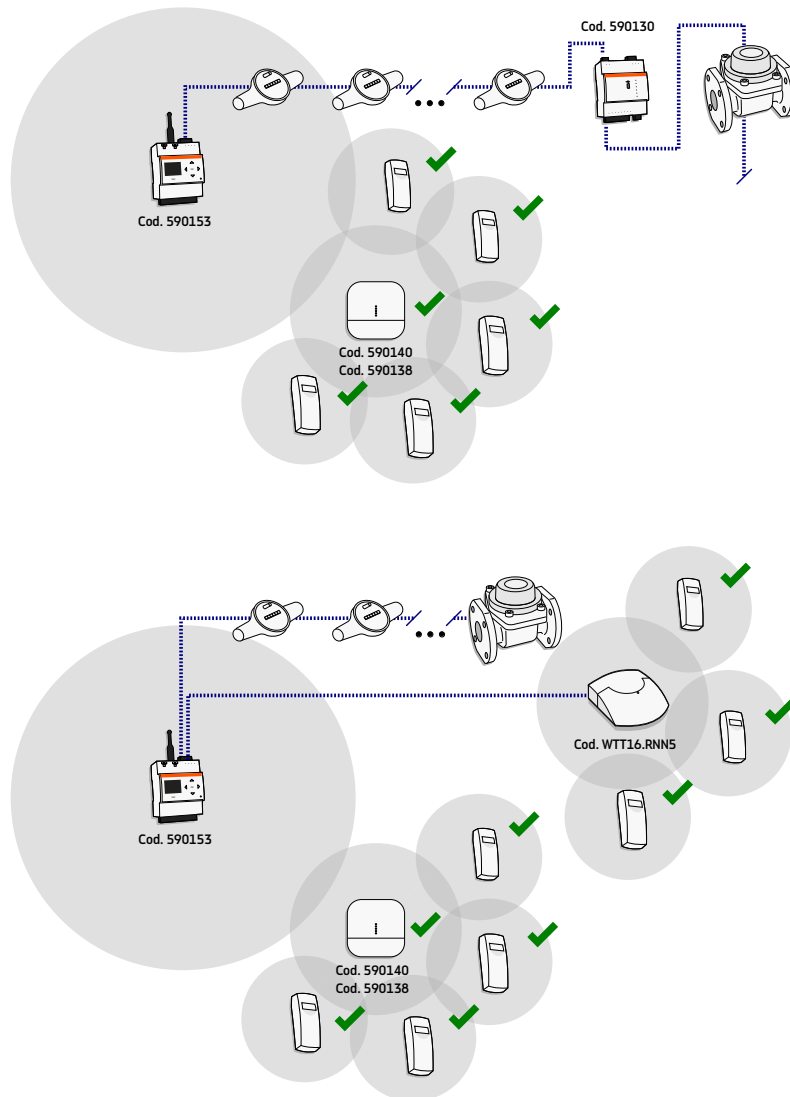

■ WT



- Antenna ricetrasmittente radio AMR. Possibilità di centralizzazione e lettura in M-BUS
- AMR radio transmitter-receiver antenna. Option of centralising and reading via M-BUS
- Antenne récepteur-émetteur radio AMR. Possibilité de centralisation et lecture en M-BUS.
- Sende-Empfangs-Radioantenne AMR. Möglichkeit zur Zentralisierung und Ablesung in M-BUS
- Antena transmisora/receptora de radio AMR. Posibilidad de centralización y de lectura en M-BUS

Code	Size	Price	Class	Packaging
WTT16.RNN5	Max. 500 devices - Battery powered - USB	705,52 €	UG	1

■ RPT1H



- Repeater unidirezionale single-hop wireless M-BUS.
- Repeater unidirectional single-hop wireless M-BUS.
- Répéteur unidirectionnel à un seul bond sans fil M-BUS.
- Unidirektionaler drahtloser Single-Hop Repeater M-BUS.
- Repetidor unidireccional single-hop inalámbrico M-BUS.

Code	Reading	Price	Class	Packaging
590140	C/S mode compatible	730,32 €	UG	1

■ GWY1H



- Gateway single-hop wireless M-BUS.
- Gateway single-hop wireless M-BUS.
- Passerelle à un seul bond sans fil M-BUS.
- Drahtloses Single-Hop Gateway M-BUS.
- Gateway single-hop inalámbrico M-BUS.

Code	Reading	Price	Class	Packaging
590154	C/S mode compatible (max 200 devices)	1.356,00 €	UG	1

■ AB10



- Alimentatore 24 V DC.
- 24 V DC power supply.
- Alimentateur 24 V DC.
- Netzteil 24 V DC.
- Alimentador de 24 V CC.

Code	Size	Price	Class	Packaging
590133	24 VDC – 15 W	157,05 €	UG	1
590134	24 VDC – 60 W	193,35 €	UG	1

■ ACT 26



- Tool di service per la formazione del network e lettura locale dei dispositivi.
- Service tool for the network creation and devices local reading.
- Outil de service pour la formation du réseau et la lecture locale des dispositifs.
- Service Tool für die Bildung des Netzes und der lokalen Ablesung.
- Tool de servicio para la formación de la red y la lectura local de los dispositivos.

Code	Price	Class	Packaging
ACT26	1.289,08 €	UG	1

■ ACT 27



- Cavetto con interfaccia USB per la lettura e programmazione locale delle antenne RNN5.
- Cable with USB interface for local reading and programming of RNN5 antennas.
- Câble avec interface USB pour la lecture et la programmation locale des antennes RNN5.
- Kabel mit Schnittstelle USB für die lokale Ablesung und Programmierung der Antennen RNN5.
- Cable de interfaz USB para la lectura y la programación local de las antenas RNN5.

Code	Price	Class	Packaging
RNNPH0010010	811,32 €	UG	1

■ RPTMH



- Repeater multi-hop wireless M-BUS.
- Repeater multi-hop wireless M-BUS.
- Répéteur à plusieurs bonds sans fil M-BUS.
- Drahtloser Multi-Hop Repeater M-BUS.
- Repetidor multi-hop inalámbrico M-BUS.

Code	Reading	Price	Class	Packaging
590138	C/S mode compatible	934,78 €	UG	1

■ GWYMH



- Gateway multi-hop wireless + M-BUS cablato.
- Gateway multi-hop wireless + wired M-BUS.
- Passerelle à plusieurs bonds sans fil + M-BUS avec fil.
- Drahtloses Multi-Hop + verdrahtet M-BUS Gateway.
- Gateway multi-hop inalámbrico + M-BUS alámbrico.

Code	Reading	Price	Class	Packaging
590153	Max 2500 devices wireless + 500 wired	2.297,61 €	UG	1

■ MOD 02



- Router per la lettura remota delle unità centrali.
- Router for remote reading of the central units.
- Router pour la lecture à distance des unités centrales.
- Router für das Fernauslesen der Zentraleinheiten.
- Router para la lectura a distancia de las unidades centrales.

Code	Price	Class	Packaging
590135	890,06 €	UG	1

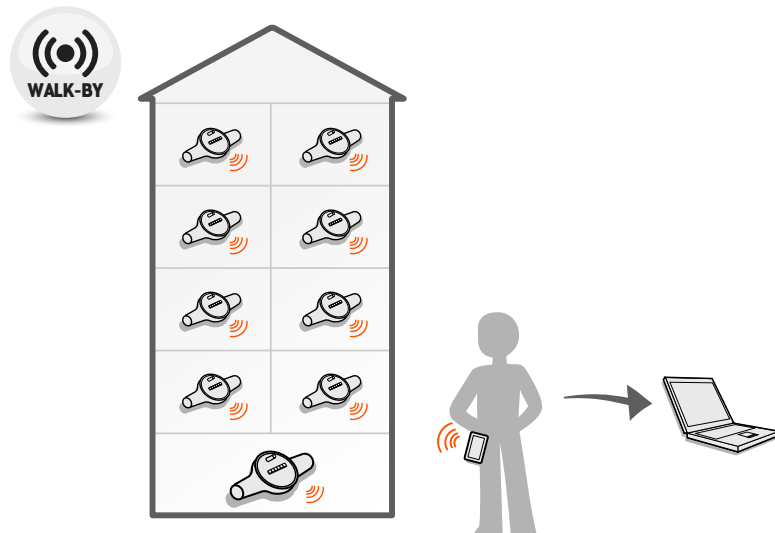

WALK-BY SYSTEM

The WALK-BY reading system is still based on wireless communication, but unlike AMR technology, the WALK-BY system does not require the installation of antennas in the building's stairwell. However, an operator will have to go near the building to make the reading using special equipment (Qlog). The advantage is that reading is convenient without installing additional devices, but at the same time, there is the disadvantage of having to go on site to take the readings.

There are two modes of radio transmission of WALK-BY devices (also AMR):

S-mode: the devices wake up and transmit for 10 hours a day on the first 4 days of the month or for 48 consecutive days after a specified reference day.

C-mode: Devices transmit for 10 hours each day, 365 days a year.

The new Q-log antenna can read both transmission modes. Therefore, it can be used both in buildings with already installed distributors operating in S-mode and in new ones operating in C-mode.

Qlog



- **Antenna mobile per lettura Walk-by in modalità S-mode e C-mode.**
- *Mobile antenna for Walk-by reading in S-mode and C-mode.*
- **Antenne mobile pour la lecture Walk-by en modalit  S-mode et C-mode.**
- *Mobilantenne f r Ablesung Walk-by in S-mode und C-mode.*
- **Antena m vil por la lectura Walk-by en modalidad S-mode y C-mode.**

Code	Size	Price	Class	Packaging
Qlog	Radio Walk-by S-mode/C-mode	2.015,73 �	UG	1

ACT46



- **Software per la lettura dei dispositivi Walk-by.**
- *Software for Walk-by devices reading.*
- **Logiciel pour la lecture des dispositifs Walk-by.**
- *Software f r die Ablesung der Vorrichtungen Walk-by.*
- **Software para la lectura de los dispositivos Walk-by.**

Code	Price	Class	Packaging
ACT46-PC	On request	UG	1



SOLAR SYSTEMS

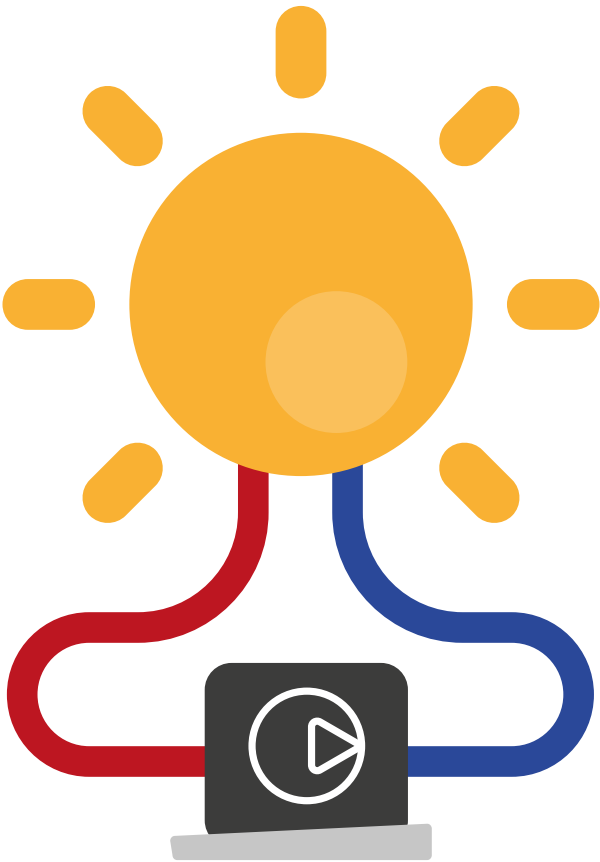

pim.ivar-group.com/short/IT-12



DOWNLOAD



pim.ivar-group.com/short/FR-12



DOWNLOAD



pim.ivar-group.com/short/DE-12



DOWNLOAD



pim.ivar-group.com/short/ES-12



DOWNLOAD





Gruppi di circolazione
Circulation groups
Groupes de circulation
Zirkulationseinheiten
Grupos de circulación

528



Regolatori elettronici
Electronic control units
Régulateurs électroniques
Elektronische Regler
Reguladores electrónicos

530



Accessori per gruppi di circolazione e sistemi solari
Accessories for circulation groups and solar systems
Accessoires pour groupes de circulation et systèmes solaires
Zubehör für Zirkulationseinheiten und Solarsysteme
Accesorios para grupos de circulación y sistemas solares

531



Tubazioni e raccorderia
Pipes and fittings
Tuyaux et raccords
Rohre und Verbinder
Tuberías y accesorios

532

INSTALLATION LAYOUTS

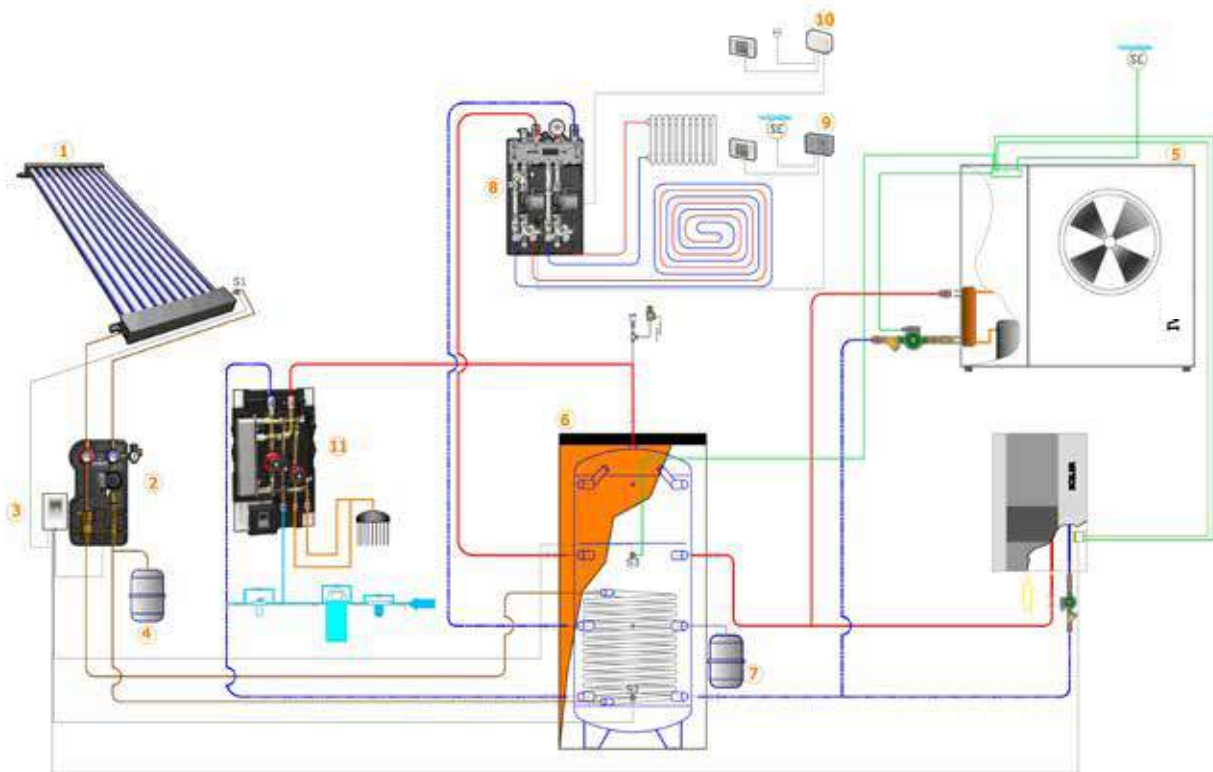
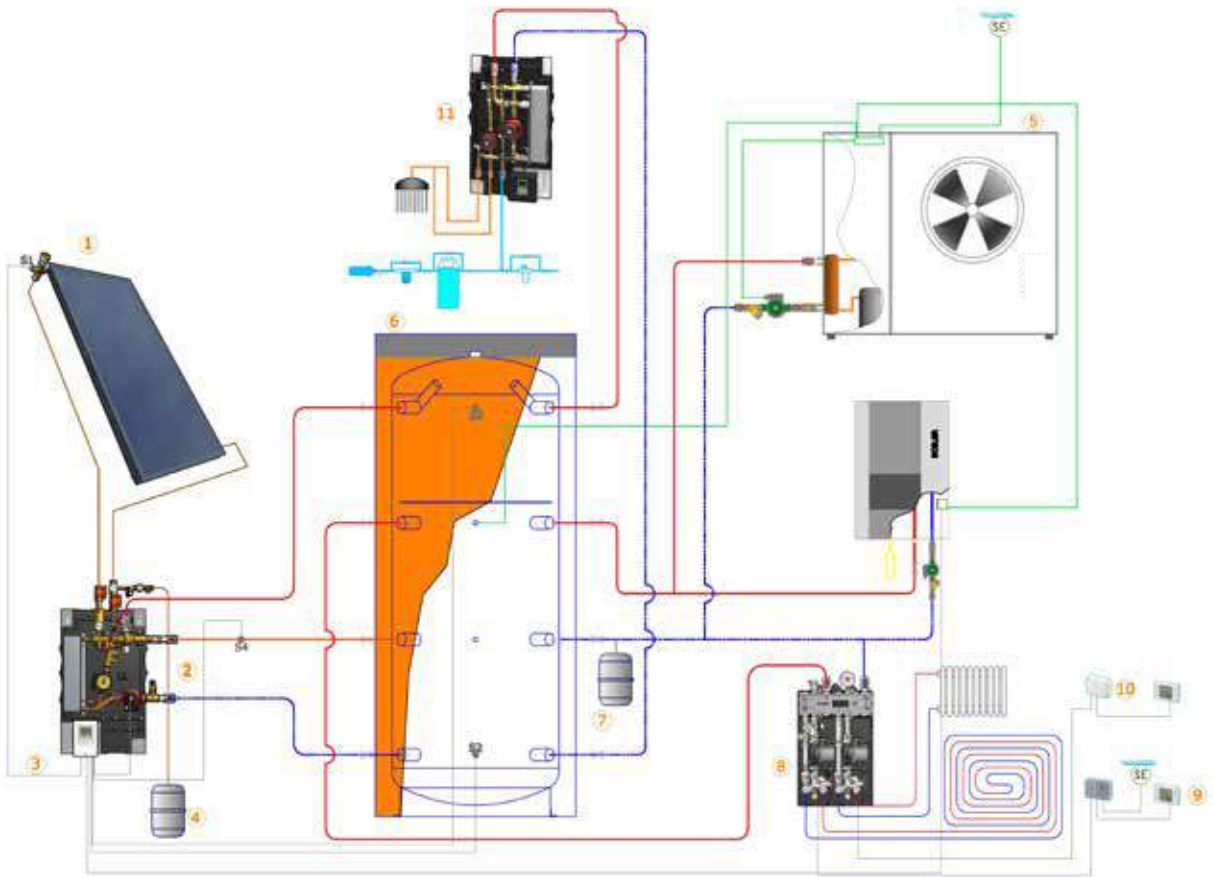

CIRCULATION GROUPS

Pumping stations for forced circulation systems come in three sizes with delivery and return lines complete with accessories. The smaller size is also available with only the pumping line. The IVAR offer is completed with a unit for mechanical stratification with external heat exchanger. See the section "Electronic control units" to find the most suitable regulation control unit, as shown in the table in the next page.

GP6010E



ErP

- Gruppo di circolazione monovia con flussimetro e circolatore ad alta efficienza (PWM).
- Single way circulation group with flow meter and high efficiency pump (PWM).
- Groupe de circulation à une voie avec débit-mètre et pompe à haut rendement (PWM).
- Ein-weg-Zirkulationseinheit mit Durchflussmesser und Pumpe mit hoher Effizienz (PWM).
- Grupo de circulación de una vía con medidor de caudal y bomba alta eficiencia (PWM).

Code	Ways	Size	Range	Pump type	Price	Class	Packaging
GP6010E	1	3/4" F	2-12 l/min	Variable speed (PWM)	781,35 €	Z6	1

GP7000E



ErP

- Gruppo di circolazione a due vie con flussimetro e circolatore ad alta efficienza (PWM).
- Two way circulation group with flow meter and high efficiency pump (PWM).
- Groupe de circulation a deux voies avec débit-mètre et pompe à haut rendement (PWM).
- 2-wege-Zirkulationseinheit mit Durchflussmesser und Pumpe mit hoher Effizienz (PWM).
- Grupo de circulación de dos vías con medidor de caudal y bomba alta eficiencia (PWM).

Code	Ways	Size	Range	Pump type	Price	Class	Packaging
GP7000E	2	3/4" F	2-12 l/min	Variable speed (PWM)	916,97 €	Z6	1

GP7000WE



ErP

- Gruppo di circolazione a due vie con flussimetro e circolatore ad alta efficienza (PWM).
- Two way circulation group with flow meter and high efficiency pump (PWM).
- Groupe de circulation a deux voies avec débit-mètre et pompe à haut rendement (PWM).
- 2-wege-Zirkulationseinheit mit Durchflussmesser und Pumpe mit hoher Effizienz (PWM).
- Grupo de circulación de dos vías con medidor de caudal y bomba alta eficiencia (PWM).

Code	Ways	Size	Range	Pump type	Price	Class	Packaging
GP7000WE	2	1" F	8-28 l/min	Variable speed (PWM)	993,52 €	Z6	1

Pump type	ErP			ErP		
Module	GP6010E	GP7000E	GP7000WE	GP6010	GP7000	GP7000W
Suitable control units	10303 16305			13300		

GP6010

- Gruppo di circolazione monovia con flussimetro e pompa standard a 3 velocità.
- Single way circulation group with flow meter and standard 3-speed pump.
- Groupe de circulation à une voie avec débit-mètre et pompe standard à 3 vitesses.
- Ein-weg-Zirkulationseinheit mit Durchflussmesser und Standardpumpe mit 3 Geschwindigkeiten.
- Grupo de circulación de una vía con medidor de caudal y bomba estándar de 3 velocidades.

Code	Ways	Size	Range	Pump type	Price	Class	Packaging
GP6010	1	3/4" F	2-12 l/min	3-speed	654,13 €	Z6	1

GP7000

- Gruppo di circolazione a due vie con flussimetro e pompa standard a 3 velocità.
- Two way circulation group with flow meter and standard 3-speed pump.
- Groupe de circulation a deux voies avec débit-mètre et pompe standard à 3 vitesses.
- 2-wege-Zirkulationseinheit mit Durchflussmesser und Standardpumpe mit 3 Geschwindigkeiten.
- Grupo de circulación de dos vías con medidor de caudal y bomba estándar de 3 velocidades.

Code	Ways	Size	Range	Pump type	Price	Class	Packaging
GP7000	2	3/4" F	2-12 l/min	3-speed	792,74 €	Z6	1

GP7000W

- Gruppo di circolazione a due vie con flussimetro e pompa standard a 3 velocità.
- Two way circulation group with flow meter and standard 3-speed pump.
- Groupe de circulation a deux voies avec débit-mètre et pompe standard à 3 vitesses.
- 2-wege-Zirkulationseinheit mit Durchflussmesser und Standardpumpe mit 3 Geschwindigkeiten.
- Grupo de circulación de dos vías con medidor de caudal y bomba estándar de 3 velocidades.

Code	Ways	Size	Range	Pump type	Price	Class	Packaging
GP7000W	2	1" F	8-28 l/min	3-speed	910,58 €	Z6	1

ELECTRONIC CONTROL UNITS

IS1-E



- **Regolatore per avviamento e spegnimento pompa solare ad alta efficienza su base differenziale.**
- *Controller for on/off regulation of high efficiency solar pump based on differential temperature.*
- **Unité de contrôle pour démarrer et arrêter la pompe solaire à haut rendement selon base différentielle.**
- *Steuereinheit zum Starten und Stoppen der Pumpe mit hoher Effizienz nach Differenzbasis.*
- **Regulador para encendido y apagado de bomba solar con alta eficiencia sobre base diferencial.**

Code	Size	Module	Price	Class	Packaging
10303	230 V AC	GP6010E - GP7000E - GP7000WE - GP8000FE - GP8000FKE	334,41 €	Z6	1

IS3-E



- **Regolatore per accensione, spegnimento e modulazione pompa solare ad alta efficienza. Funzione termostato per integrazione da altra fonte.**
- *Controller for high efficiency solar pump operation and modulation. Thermostat mode for integration from other sources.*
- **Régulateur pour la mise en marche, l'arrêt et la modulation de la pompe solaire à haut rendement. Fonction thermostat pour l'intégration d'autres sources.**
- *Regler zum Einschalten, Ausschalten und Modulation der Solarpumpe mit hoher Effizienz. Thermostatfunktion für die Integration von anderen Quellen.*
- **Regulador para encendido, apagado y modulación de bomba solar con alta eficiencia. Función de termostato para la integración de otras fuentes.**

Code	Size	Module	Price	Class	Packaging
16305	230 V AC	GP6010E - GP7000E - GP7000WE - GP8000E - GP8000KE - GP8000FE - GP8000FKE	445,07 €	Z6	1

IS4-E



- **Regolatore per accensione, spegnimento e modulazione pompa solare ad alta efficienza. Funzione termostato per integrazione da altra fonte. Gestione della stratificazione meccanica (GP9000HXE).**
- *Controller for high efficiency solar pump operation and modulation. Thermostat mode for integration from other sources. Management of mechanical stratification (GP9000HXE).*
- **Régulateur pour la mise en marche, l'arrêt et la modulation de la pompe solaire à haut rendement. Fonction thermostat pour l'intégration d'autres sources. Gestion de la stratification mécanique (GP9000HXE).**
- *Regler zum Einschalten, Ausschalten und Modulation der Solarpumpe mit hoher Effizienz. Thermostatfunktion für die Integration von anderen Quellen. Verwaltung von mechanischen Schichtung (GP9000HXE).*
- **Regulador para encendido, apagado y modulación de bomba solar con alta eficiencia. Función de termostato para la integración de otras fuentes. Gestión de la estratificación mecánica (GP9000HXE).**

Code	Size	Module	Price	Class	Packaging
17403	230 V AC	GP9000HXE	610,57 €	Z6	1

IS3



- **Regolatore per accensione, spegnimento e modulazione pompa solare. Possibilità di gestire on-off una seconda pompa.**
- *Controller for solar pump operation and modulation. Possibility to on/of control of an additional pump.*
- **Régulateur pour la mise en marche, l'arrêt et la modulation de la pompe solaire. Possibilité de gérer on/off une deuxième pompe.**
- *Regler zum Einschalten, Ausschalten und Modulation der Solarpumpe. Möglichkeit zum Ein- und Ausschalten einer zweiten Pumpe.*
- **Regulador para encendido, apagado y modulación de bomba solar. Posibilidad de gestionar on-off de una segunda bomba.**

Code	Size	Module	Price	Class	Packaging
13300	230 V AC	GP6010 - GP7000 - GP7000W - GP8000 - GP8000K - GP8000F - GP8000FK	417,73 €	Z6	1

IS4



- **Regolatore per accensione, spegnimento e modulazione pompa solare. Possibilità di gestire on-off una seconda pompa e una valvola deviatrice per stratificazione meccanica.**
- *Controller for solar pump operation and modulation. Possibility to on/of control of an additional pump and a diverter valve to mechanical layering.*
- **Régulateur pour la mise en marche, l'arrêt et la modulation de la pompe solaire. Possibilité de gerance on-off d'une deuxième pompe et d'une vanne de dérivation pour la superposition mécanique.**
- *Regler zum Einschalten, Ausschalten und Modulation der Solarpumpe. Fähigkeit, eine zweite Pumpe und ein Umschaltventil für mechanische Schichtung zu verwalten.*
- **Regulador para encendido, apagado y modulación de bomba solar. Posibilidad de gestionar on-off de una segunda bomba y una válvula desviadora para la estratificación mecánica.**

Code	Size	Module	Price	Class	Packaging
14300S	230 V AC	GP9000HX	555,21 €	Z6	1

ACCESSORIES FOR SOLAR SYSTEMS

FLB70



- Flussmetro con by-pass per elevate portate.
- By-pass balancing flow meter for large flow rates.
- Débitmètre avec by-pass pour des débits élevés.
- Flussmesser mit Bypass für hohe Durchflussmengen.
- Caudalímetro con bypass para caudales elevados.

Code	Size	Range	Max operating temp.	Price	Class	Packaging
FLB70	1"1/4 F (DN 32)	20-70 l/min	100 °C	451,44 €	Z6	1
FLB70SOL	1"1/4 F (DN 32)	20-70 l/min	130 °C	529,88 €	Z6	1

FLI-SOL



- Flussmetro in linea per il bilanciamento di banchi solari.
- On-line flow meter for solar bank balancing.
- Débitmètre en ligne pour l'équilibrage des bancs solaires.
- Flussmesser in Linie für Auswuchtung der Solarreihen.
- Caudalímetro en línea para el equilibrado de bancadas solares.

Code	Size	Range	Max operating temp.	Price	Class	Packaging
FLI06SOL	1" M x 1" F (DN 20)	1,5-6 l/min	130 °C	209,62 €	Z6	1
FLI16SOL	1" M x 1" F (DN 20)	4-16 l/min	130 °C	209,62 €	Z6	1

IVANTIGELO



- Glicole propilenico antigelo per circuito solare.
- Antifreeze propylene glycol for solar circuit.
- Propylèneglycol antigel pour circuit solaire.
- Propylenglykol Frostschutz für Solarkreislauf.
- Propilenglicol anticongelante para circuito solar.

Code	Operating temp.	Price	Class	Packaging
IVANTIGELO	32-220 °C	9,90 €/Kg	Z6	10 Kg

VSC 00 SOL



- Valvola di sicurezza per applicazioni solari.
- Safety valve for solar applications.
- Clapet de sécurité pour des applications solaires.
- Sicherheitsventil für Solaranwendungen.
- Valvula de seguridad para aplicaciones solares.

Code	Size	Max inlet pressure	Price	Class	Packaging
10005520	3/4" F x 3/4" F	6 bar	20,02 €	Z6	1

AC 606 HT



- Nipplo girevole per gruppi GP8000 (F, K, FK).
- Turnable nipple for GP8000 (F, K, FK) groups.
- Mamelon pivotant pour des groupes GP8000 (F, K, FK).
- Drehbare Nippel für Einheiten GP8000 (F, K, FK).
- Niple giratorio para grupos GP8000 (F, K, FK).

Code	Size	Price	Class	Packaging
506700HT	1"1/4 M x 1"1/4 M	20,93 €	Z6	1

AC 600 HT



- Tappo per collettore modulare.
- Plug for modular manifold.
- Bouchon pour collecteur modulaire.
- Verschluss für Modularverteiler.
- Tapón para colector modular.

Code	Size	Price	Class	Packaging
500904HT	1"1/4 M	6,47 €	Z6	35 / 280

VAR 30 HT



- Collettore modulare per gruppi GP8000K/ GP8000FK connessi in parallelo.
- Modular manifold for GP8000K/ GP8000FK units connected in parallel.
- Collecteur modulaire pour des groupes GP8000K/ GP8000FK connectés en parallèle.
- Modularverteiler für Einheiten GP8000K/ GP8000FK, parallel geschaltet verbunden.
- Colector modular para grupos GP8000K/ GP8000FK conectados en paralelo.

Code	Size	Price	Class	Packaging
550630HT	1"1/4 F	279,57 €	Z6	1

VESOL



- Vaso di espansione chiuso a membrana per circuito solare.
- Membrane closed expansion vessel for solar circuits.
- Vase d'expansion fermé à membrane pour circuit solaire.
- Expansionsgefäß, mit Membran verschlossen, für Solarkreislauf.
- Vaso de expansión cerrado con membrana para circuito solar.

Code	Size	Height	Price	Class	Packaging
VESOL8	8 l - Ø195 mm - G 3/4"	325 mm	59,89 €	Z2	1
VESOL15	15 l - Ø260 mm - G 3/4"	360 mm	70,51 €	Z2	1
VESOL20	20 l - Ø260 mm - G 3/4"	420 mm	74,58 €	Z2	1
VESOL24	24 l - Ø295 mm - G 1"	420 mm	80,23 €	Z2	1
VESOL33	33 l - Ø365 mm - G 1"	415 mm	101,70 €	Z2	1
VESOL50	50 l - Ø370 mm - G 1"	790 mm	204,08 €	Z2	1
VESOL60	60 l - Ø415 mm - G 1"	745 mm	216,06 €	Z2	1
VESOL80	80 l - Ø460 mm - G 1"	785 mm	273,91 €	Z2	1



PIPES AND FITTINGS

500



- Tubo corrugato in acciaio inox austenitico AISI 316L, con isolante in EPDM a celle chiuse, pellicola protettiva anti raggi UV e cavo per sonda di temperatura. Ogni confezione contiene un kit di raccordi (4 dadi, 4 guarnizioni, 4 anelli e 2 nipples).
- Austenitic stainless steel AISI 316L pipe with closed cell EPDM insulation, protective anti-UV film and electric cable for temperature probe. Fitting kit (4 nuts, 4 gaskets, 4 rings and 2 nipples) also included.
- Tuyau ondulé en acier inox austénitique AISI 316L, avec isolant en EPDM à cellules fermées, pellicule de protection contre les rayons UV et câble pour sonde de température. Chaque paquet contient un kit de raccords (4 écrous, 4 joints, 4 anneaux et 2 mamelons).
- Wellrohr aus authentischem Edelstahl AISI 316L mit geschlossenzelligem Isolierstoff aus EPDM, Schutzfolie gegen UV Bestrahlung und Kabel für Temperatursonde. Jede Verpackung enthält einen Anschlussbausatz (4 Muttern, 4 Dichtungen, 4 Ringe und 2 Nippel).
- Tubo corrugado de acero inoxidable austenítico AISI 316L, con aislante de EPDM de celdas cerradas, film protector contra los rayos UV y cable para sonda de temperatura. Cada paquete contiene un kit de racores (4 tuercas, 4 juntas, 4 anillos y 2 nipples).

Code	Size	Length	Price	Class	Packaging
S0016010	DN 16 - Fitting 3/4"	10 m	71,04 €/m	Z6	10 m
S0016015	DN 16 - Fitting 3/4"	15 m	69,26 €/m	Z6	15 m
S0016020	DN 16 - Fitting 3/4"	20 m	68,41 €/m	Z6	20 m
S0016025	DN 16 - Fitting 3/4"	25 m	67,80 €/m	Z6	25 m
S0020010	DN 20 - Fitting 1"	10 m	81,10 €/m	Z6	10 m
S0020015	DN 20 - Fitting 1"	15 m	79,02 €/m	Z6	15 m
S0020020	DN 20 - Fitting 1"	20 m	78,03 €/m	Z6	20 m
S0020025	DN 20 - Fitting 1"	25 m	77,33 €/m	Z6	25 m
S0025015	DN 25 - Fitting 1"1/4	15 m	102,22 €/m	Z6	15 m
S0025025	DN 25 - Fitting 1"1/4	25 m	99,62 €/m	Z6	25 m

RR 500



- Kit di raccordi per tubo corrugato costituito da 4 dadi, 4 guarnizioni, 4 anelli e 2 nipples a tenuta piatta.
- Fitting kit for corrugated pipe consisting of 4 nuts, 4 gaskets, 4 rings and 2 flat-seal nipples.
- Kit de raccords pour tuyau ondulé composé de 4 écrous, 4 joints, 4 anneaux et 2 mamelons à étanchéité plate.
- Bausatz mit Anschlüssen für das Wellrohr, bestehend aus 4 Muttern, 4 Dichtungen, 4 Ringe und 2 Dichtungsnippeln.
- Kit de racores para tubo corrugado compuesto por 4 tuercas, 4 juntas, 4 anillos y 2 nipples con junta plana.

Code	Size	Price	Class	Packaging
S0304160	3/4"	26,37 €	Z6	1
S0304200	1"	50,15 €	Z6	1
S0304250	1"1/4	93,30 €	Z6	1

RR S030 TP



- Nipplo a tenuta piatta maschio-maschio.
- Male-male flat seal nipple.
- Mamelon à étanchéité plate mâle-mâle.
- Flachdichtungsnippel AG-AG.
- Niple con junta plana macho-macho.

Code	Size	Price	Class	Packaging
S0301160	3/4" M x 3/4" M	4,64 €	Z6	1
S0307200	1" M x 3/4" M	10,07 €	Z6	1
S0301200	1" M x 1" M	11,41 €	Z6	1
S0307250	1"1/4 M x 1" M	20,11 €	Z6	1
S0301250	1"1/4 M x 1"1/4 M	23,54 €	Z6	1

RR 781 TP



- Raccordo diritto con attacco per tubo rame e filetto maschio a tenuta piatta.
- Straight fitting with copper pipe connection and male flat-seal thread.
- Raccord droit avec connection pour tuyau en cuivre et filetage mâle à étanchéité plate.
- Gerade Verbindung mit Anschluss für Kupferrohr und Gewinverschraubung AG mit Flachdichtung.
- Racor recto con conexión para tubo de cobre roscada macho y junta plana.

Code	Size	Price	Class	Packaging
19805041	22 mm x 3/4" M	6,84 €	Z6	1
IV2052	22 mm x 1" M	20,31 €	Z6	1

RR 881 TP



- Raccordo a gomito con attacco tubo rame, filetto maschio tenuta piatta.
- Elbow fitting with copper pipe connection and male flat seal thread.
- Raccord coudé avec connection pour tuyau en cuivre, filetage mâle à étanchéité plate.
- Krümmer mit Anschluss für Kupferrohr, Gewinverschraubung AG mit Flachdichtung.
- Racor en codo con conexión tubo de cobre, rosca macho junta plana.

Code	Size	Price	Class	Packaging
IV2021	22 mm x 3/4"	25,18 €	Z6	1
IV2022	22 mm x 1"	40,41 €	Z6	1

AC 602 TP

- Riduzioni maschio-femmina con sede piana.
- Male-female flat-seal reduction.
- Réductions mâle-femelle avec logement plat.
- Reduzierstück AG-IG mit Flachsitz
- Reducciones macho-hembra con sede plana.

Code	Size	Price	Class	Packaging
IV2122	3/4" F x 1" M	9,56 €	Z6	1
IV2123	1" F x 1"1/4 M	15,55 €	Z6	1

AC 636 HT

- Valvole a sfera di intercettazione per applicazioni solari.
- Shut-off ball valves for solar applications.
- Robinet d'arrêt à sphère pour des applications solaires.
- Kugelabsperventile für Solaranwendungen.
- Válvulas de esfera de interceptación para aplicaciones solares.

Code	Size	Price	Class	Packaging
8366N007HT	1"1/4 F x 1"1/4 F	58,62 €	Z6	1

PS I-SUNF

- Raccordo portasonda con valvola di intercettazione e attacco per valvola di sfiato automatica, adatto a collettori solari piani I-SUNF, con attacchi tubo rame.
- Fitting with probe holder, connection and interception for automatic air vent valve, suitable to I-SUNF flat plate solar panels, with copper pipe connections.
- Raccord porte-sonde avec soupape d'arrêt et raccord pour purgeur d'air automatique, approprié aux collecteurs solaires plans I-SUNF, avec raccords tuyau en cuivre.
- Anschluss Sondenhalter mit Absperrventil und Anschluss für automatisches Entlüftungsventil, geeignet für Flachsolarverteiler-SUNF, mit Anschlüssen für Kupferrohre.
- Racor portasonda con válvula de interceptación y conexión para válvula purgadora automática, idóneo para colectores solares planos I-SUNF, con conexiones para tubo de cobre.

Code	Size	Price	Class	Packaging
506031	22 mm x 22 mm	48,86 €	Z6	5 / 40

PS I-SUNKSR

- Kit composto da valvola di sfiato e portasonda per collettori sottovuoto I-SUNKSR.
- Kit consisting of air vent valve and probe holder for vacuum tube collectors I-SUNKSR.
- Kit comprenant une vanne de purge et un porte-sonde pour des collecteurs sous vide I-SUNKSR.
- Bausatz bestehend aus Entlüftungsventil und Sondenhalter für Vakuumverteiler I-SUNKSR.
- Kit compuesto por válvula purgadora y portasonda para colectores de vacío I-SUNKSR.

Code	Size	Price	Class	Packaging
470201SR	3/4" F x 3/4" M flat seal	33,49 €	Z6	1

AC 601 HT

- Tappo 3/4" femmina con guarnizione per alte temperature.
- 3/4" female plug with seal for high temperature.
- Bouchon 3/4" femelle avec le joint pour des hautes températures.
- IG Verschluss 3/4" mit Dichtung für Hochtemperatur.
- Tapón 3/4" hembra con junta para altas temperaturas.

Code	Size	Price	Class	Packaging
500022HT	3/4"	4,474 €	Z6	100 / 800

AC 620 SOL

- Valvola di sfiato automatica per campo solare costituito di collettori piani I-SUNF.
- Automatic air vent valve for solar field of I-SUNF solar panels.
- Purgeur d'air automatique pour champ solaire comprenant des collecteurs plans I-SUNF.
- Automatisches Entlüftungsventil für Solarfeld, bestehend aus Flachverteiltern I-SUNF.
- Válvula purgadora automática para campo solar compuesto por colectores planos I-SUNF.

Code	Size	Max inlet pressure	Price	Class	Packaging
506701	1/2" M	10 bar	16,23 €	Z6	10 / 80

RR I-SUNF

- Raccordo di giunzione per pannelli solari piani I-SUNF con attacco doppio tubo rame.
- Joint fitting for I-SUNF flat solar panels with double copper pipe connection.
- Raccord de jonction pour des panneaux solaires plans I-SUNF avec raccord double tuyau en cuivre.
- Verbindungen für Flachsolarverteiler I-SUNF mit Doppelanschluss Kupferrohr.
- Racor para paneles solares planos I-SUNF con conexión doble tubo de cobre.

Code	Size	Price	Class	Packaging
3156	22 mm x 22 mm	9,22 €	Z6	1

RF I-SUNKSR

- Raccordo di giunzione flessibile per collettori sottovuoto I-SUNKSR. Dado e guarnizioni incluse.
- Flexible joint connection for I-SUNKSR vacuum pipe collectors. Nut and gaskets included.
- Raccord de jonction flexible pour des collecteurs sous vide I-SUNKSR. Écrou et joints inclus.
- Flexible Verbindung für Vakuumverteiler I-SUNKSR. Inklusive Mutter und Dichtung.
- Racor flexible para colectores de vacío I-SUNKSR. Tuerca y juntas incluidas.

Code	Size	Price	Class	Packaging
420100	3/4"	12,41 €	Z6	1



ANALYTICAL INDEX AND CODE LIST



PRODUCT	Page	PRODUCT	Page	PRODUCT	Page	PRODUCT	Page	PRODUCT	Page
■ AB10	519	■ AC 647	215	■ ACB 00	347	■ AMU 01 FIX 035	517	■ AVAR 00	323
■ AB10	522	■ AC 649	427	■ ACB 05	346	■ AMU 01 FIX 036	517	■ AVAR 01	323
■ ABX 01	301	■ AC 650	206	■ ACB 05	358	■ AMU 05	512	■ AVAR 02	323
■ AC 110	475	■ AC 651	69	■ ACB 07	346	■ AMU 10	516	■ AVAR 03	322
■ AC 111	502	■ AC 652	219	■ ACB 10	349	■ AMU 15	512	■ AVAR 04	322
■ AC 111	504	■ AC 654 G	225	■ ACGAS 00	464	■ AMUL 01	317	■ AVAR 05	322
■ AC 600	216	■ AC 654 NB	222	■ ACGAS 05	464	■ APF 01	298	■ AVAR 06	321
■ AC 600	322	■ AC 654 NR	222	■ ACH 41	352	■ APF 02	298	■ AVB 00	369
■ AC 600 HT	531	■ AC 655 G	295	■ ACH 42	352	■ APF 03	297	■ AVB 10	369
■ AC 601	216	■ AC 655 N	221	■ ACH 43	353	■ AQUASTOP	217	■ AVB 10	376
■ AC 601	429	■ AC 655 NST	221	■ ACM 01	241	■ AQUASTOP XL	217	■ AVB 10	489
■ AC 601 HT	533	■ AC 655 NST	308	■ ACM 667	314	■ AR 01	131	■ AVB 20	368
■ AC 601 K	216	■ AC 655 NST	323	■ ACT 20	509	■ AR 02	131	■ AVGD 50	464
■ AC 601 K	429	■ AC 656	229	■ ACT 26	522	■ AR 04	131	■ AVK 01	13
■ AC 602	216	■ AC 657 N	206	■ ACT 27	522	■ AR 07	116	■ AVK 01	52
■ AC 602 TP	533	■ AC 658 N	221	■ ACT46	523	■ AR 07	121	■ AVK 01	58
■ AC 603	215	■ AC 659 NR	502	■ ACUL	510	■ AR 08 MP	100	■ AVK 01	67
■ AC 605	215	■ AC 662	236	■ ACV 01	292	■ AR 08 MP GAS	457	■ AVK 02	58
■ AC 606	215	■ AC 664/L	236	■ AD 01	20	■ AR 08 MPL	112	■ AVM 1319	64
■ AC 606	309	■ AC 664 M/ML	236	■ AD 02	20	■ AR 08 PMP	103	■ AVM 1321	64
■ AC 606	322	■ AC 665	210	■ AD 03	13	■ AR 08 PMP L	115	■ AVM 1324	64
■ AC 606 HT	531	■ AC 666	210	■ AD 03 M	12	■ AR 09	131	■ AVM 1325	64
■ AC 608	364	■ AC 667	210	■ AD 04	20	■ AR 10 R	133	■ AVM 1326	64
■ AC 609	209	■ AC 668	211	■ AD 05	20	■ AR 10 R	457	■ AVM 1327	64
■ AC 609 (1*1/2)	209	■ AC 669 N	221	■ AD 06	20	■ AR 21	116	■ AVM 1328	64
■ AC 610	208	■ AC 670	131	■ ADD-M	282	■ AR 22	116	■ AVM 1329	64
■ AC 611	208	■ AC 671	131	■ ADI 01	61	■ AR 22	411	■ AVR 00	444
■ AC 613 C	364	■ AC 672	315	■ ADI 01	67	■ AR 23	116	■ AVT 02	68
■ AC 613 CU	252	■ AC 673	208	■ AEOQ 01	379	■ AR 24	116	■ AVT 03	218
■ AC 613 F	364	■ AC 674	218	■ AEOQ 11	379	■ AR 32	130	■ AVZS 00	229
■ AC 613 FU	252	■ AC 677	206	■ AFUL	510	■ AR 32 L	130	■ AVZS 00	323
■ AC 613 S	364	■ AC 678	206	■ AGE 01 N	67	■ AR 37	133	■ AVZS 00	481
■ AC 613 SI	364	■ AC 679	211	■ AGE 01 N	223	■ AR 37 B	133	■ AVZS 01	229
■ AC 613 SU	252	■ AC 681	211	■ AGE 04	65	■ AR 37 C	133	■ AVZS 01	323
■ AC 614	364	■ AC 682 N	221	■ AGE 05	68	■ AR 42	130	■ AVZS 01	481
■ AC 616	364	■ AC 682 NST	221	■ AGE 05	219	■ AR 42 L	130	■ AVZS 02	229
■ AC 616 I	364	■ AC 688	386	■ AGE 06	69	■ AR 43	130	■ AVZS 10	229
■ AC 617	215	■ AC 688 S	386	■ AGE 07	69	■ AR 43 L	130	■ AVZS 10	323
■ AC 617 I	223	■ AC 689	208	■ AGE 09	68	■ AR 50	132	■ AVZS 10	481
■ AC 619	224	■ AC 690	219	■ AGE 09	219	■ AR 55	134	■ AVZS 11	229
■ AC 619 L	224	■ AC 691	141	■ AGE 09 D	68	■ AR 60	134	■ AVZS 11	323
■ AC 620	207	■ AC 693	219	■ AGE 09 N	68	■ AR 63	130	■ AVZS 11	481
■ AC 620	308	■ AC 693 F	219	■ AGE 09 NH	68	■ AR 63 L	130	■ B12	519
■ AC 620 SOL	533	■ AC 694	141	■ AGE 10	67	■ AR 64	130	■ BIN	282
■ AC 621	207	■ AC 701	359	■ AGE 11	67	■ AR 67	130	■ BIN-INDUSTRY	282
■ AC 623 N	339	■ AC 701 A	359	■ AGE 12	237	■ AR 70	134	■ BRA 24A	377
■ AC 624	119	■ AC 701 B	359	■ AGE 13	237	■ AR 71	134	■ BRA 065	377
■ AC 624	216	■ AC 702	236	■ AGE 14	69	■ AR 72	134	■ BRIX	301
■ AC 625	207	■ AC 710	359	■ AGE 15	65	■ AR 73	134	■ BSF	330
■ AC 625 M	69	■ AC 710 T	359	■ AGE 16	67	■ AR 74	134	■ BSF2S	330
■ AC 625 M	207	■ AC 711	359	■ AGE 17	69	■ AR 75	132	■ BU	281
■ AC 626	255	■ AC 820	205	■ AGE 17	348	■ AR 76	132	■ CACML-I	508
■ AC 627	216	■ AC 830	204	■ AGS 00	439	■ AR 77	132	■ CACML-TOOL	508
■ AC 627	292	■ AC 830	316	■ AGS 01	439	■ AR 110	133	■ CACS-D REED	507
■ AC 627	324	■ AC 830	396	■ AGS 03	439	■ AR 120	133	■ CACSWO-I	510
■ AC 628	141	■ AC 830	503	■ ALC 01	363	■ AR 1920	132	■ CAFS-D REED	507
■ AC 628	427	■ AC 830 P	396	■ ALPEX DUO	81	■ AR 1921	132	■ CAFSWO-I	510
■ AC 629	209	■ AC 830 S	503	■ ALPEX DUO XS	82	■ AS 1010 C	348	■ CASS 00 P	286
■ AC 629 (1*1/2)	209	■ AC 840	204	■ ALPEX DUO XS RCB	82	■ AS 1925	99	■ CAV-IMP	507
■ AC 630	206	■ AC 840	503	■ ALPEX DUO XS RCR	82	■ AS 1925	128	■ CBL 01	252
■ AC 631	206	■ AC 840 E	204	■ ALPEX GAS B	454	■ AS 1926	129	■ CBL 01	363
■ AC 632	322	■ AC 850	205	■ ALPEX GAS R	454	■ AS 1927	116	■ CBL 02	397
■ AC 633	236	■ AC 850	426	■ ALPEX RCFG	84	■ AS 1927	121	■ CC 25	321
■ AC 633	242	■ AC 851	205	■ AMCD 01	502	■ AS 1928	116	■ CC 25	336
■ AC 633	255	■ AC 851	426	■ AMEQCP 01	489	■ AS 1929	116	■ CC 25	362
■ AC 634	364	■ AC 852	205	■ AMF 01	245	■ AS 1929	120	■ CCWO-I	509
■ AC 635 BCM	223	■ AC 852	426	■ AMIX 01	336	■ AS 4000	326	■ CEP/02 - CEP/03	242
■ AC 635 NB	222	■ AC 853	205	■ AMR pulse ad.	509	■ ASM 05	441	■ CEP/02 I - CEP/03	1242
■ AC 635 NR	222	■ AC 853	426	■ AMS 01	512	■ AT 0001	25	■ CGAS 00	464
■ AC 635 RCM	223	■ AC 860 B	489	■ AMS 02	512	■ AT 0001E	25	■ CHUB-EXP	351
■ AC 636 HT	533	■ AC 860 IB	489	■ AMT 01	437	■ ATR01-07	283	■ CI 350 N	418
■ AC 636 NB	222	■ AC 860 L	489	■ AMU 01	516	■ ATR02/03	283	■ CI 370 N	425
■ AC 636 NR	222	■ AC 4604	118	■ AMU 01 FIX 028	516	■ ATR04	283	■ CI 370 NT	425
■ AC 637 N	223	■ AC 4612	218	■ AMU 01 FIX 029	516	■ ATR05/06	283	■ CI 390 N	416
■ AC 639	427	■ AC 4615 N	215	■ AMU 01 FIX 030	516	■ AUM 01	253	■ CI 400 FLX	140
■ AC 643 NB	223	■ AC 4615 N	254	■ AMU 01 FIX 031	516	■ AUM 02	253	■ CI 400 KC	140
■ AC 643 NR	223	■ AC 4648	218	■ AMU 01 FIX 032	517	■ AUM 03	247	■ CI 400 N	419
■ AC 645	224	■ AC 6450	224	■ AMU 01 FIX 033	517	■ AUM 11 D/S	253	■ CI 400 NB	420
■ AC 645 G	224	■ ACA 00	443	■ AMU 01 FIX 034	517	■ AUM 12 D/S	253	■ CI 400 NBR	419

PRODUCT	Page	PRODUCT	Page	PRODUCT	Page	PRODUCT	Page		
■ CI 400 NR	420	■ CS 580	182	■ DV 104 B	18	■ HMR-M	504	■ KD 301 LN	57
■ CI 400 VT	140	■ CS 584	188	■ EPM	325	■ HS-I	508	■ KD 305 B	56
■ CI 490 N	416	■ CTC 20	321	■ EQCP1	484	■ IC-BOX 1	257	■ KD 305 BN	57
■ CI 490 NB	417	■ CTC 20	336	■ EQCP1 I	485	■ IC-BOX 2	257	■ KD 305 L	56
■ CI 490 NR	417	■ CTC 20	362	■ EQCP05	488	■ IC-BOX 3	258	■ KD 305 LN	57
■ CI 490 NW	417	■ CUB 01	345	■ EQCP13	484	■ IC-BOX 4	258	■ KEKO 01	380
■ CI 552 (1"1/2)	172	■ DB 1405	61	■ EQCP13 I	485	■ IC-BOX 5	259	■ KEKO 03	380
■ CI 552 N	148	■ DB 1406	61	■ EQCP14	484	■ IFWC3	404	■ KIT 1 IS BOX	411
■ CI 553 (1"1/2)	172	■ DCD 212 DX	51	■ EQCP14 I	485	■ IKGE01	433	■ KIT 2 IS BOX	411
■ CI 553 N	149	■ DCD 216 DX	51	■ EQCP15 I	485	■ IKK01	404	■ KIT 3 IS BOX	411
■ CI 554 C (1"1/2)	173	■ DCS 212 SX	51	■ EQCP15 - EQCP25	484	■ IKK02	404	■ KIT 4 IS BOX	411
■ CI 554 CN	152	■ DCS 216 SX	51	■ EQDYN1	486	■ IKLE01	433	■ KIT MIX SAP-C	403
■ CI 554 M (1"1/2)	174	■ DD 201	50	■ EQDYN13	486	■ INDUSTRY	275	■ KIT R CAL	502
■ CI 554 MN	154	■ DD 205	50	■ EQDYN14	486	■ IS1-E	530	■ KIT R IVARSAT	395
■ CI 555 C (1"1/2)	173	■ DD 227	50	■ EQDYN15 - EQDYN25	486	■ IS3	530	■ KIT R SAP	403
■ CI 555 CN	153	■ DD 301	49	■ EQF 01	378	■ IS3-E	530	■ KIT R SAP-C	403
■ CI 555 M (1"1/2)	174	■ DD 305	49	■ EQF 01 H	387	■ IS4	530	■ KPI 00	458
■ CI 555 MN	155	■ DD 311	49	■ EQF 01 P	387	■ IS4-E	530	■ KS 302 B	56
■ CI 562 CN	156	■ DD 321	236	■ EQF 02	379	■ IS-BOX 1	410	■ KS 302 BN	57
■ CI 562 MN	158	■ DD 327	49	■ EQF 03	379	■ IS-BOX 2	410	■ KS 302 L	56
■ CI 583	186	■ DD 345	58	■ EQM1/2 Temp.	476	■ IS-BOX 3	410	■ KS 302 LN	57
■ CI 583 SP	187	■ DD 355	58	■ EQM1 C. mod.	477	■ IS-BOX 4	410	■ KS 306 B	56
■ CI 585 C	191	■ DEUCL-P	286	■ EQM1 - EQM2	474	■ IS-BOX MPLUS	413	■ KS 306 BN	57
■ CI 586 C	195	■ DEUCL-S	285	■ EQM2 C. mod.	477	■ IS-BOX PLUS	412	■ KS 306 L	56
■ CI 587 C	193	■ DEU-P	286	■ EQM11/21 Temp.	476	■ ISOL	280	■ KS 306 LN	57
■ CI 588 C	190	■ DEU-S	285	■ EQM11 - EQM21	474	■ ISOL	283	■ KSA 003 (1"1/2)	175
■ CI 589 C	194	■ DF 01	21	■ EQM12/22 Temp.	476	■ ISOL-PPSU	284	■ KSA 005 (1"1/2)	175
■ CI 590 C	189	■ DF 02	21	■ EQM12 - EQM22	474	■ ISOL-SOUND	280	■ KSA 034 (1"1/2)	176
■ CI 591 C	192	■ DF 03	21	■ EQM13/23 Temp.	476	■ IV 100 HT	293	■ KSA 035 (1"1/2)	176
■ CI 592 C	196	■ DH 01 CHROME	12	■ EQM13 - EQM23	475	■ IV 100 LT	282	■ KSA 036 (1"1/2)	177
■ CI 592 KC (1")	197	■ DH 01 INOX	12	■ EQM14/24 Temp.	476	■ IV 100 LT	293	■ KSA 037 (1"1/2)	177
■ CI 592 KC (1"1/4)	197	■ DH 01 WHITE	12	■ EQM14 - EQM24	475	■ IV 400	282	■ KSPR	512
■ CI 594 CN	157	■ DIRTSTOP®	292	■ EQM15/25 Temp.	476	■ IV 400	293	■ L-CAP	502
■ CI 594 MN	159	■ DIRTSTOP® XL	295	■ EQM15 - EQM25	475	■ IVANTIGELO	531	■ LEGIO-BOX 1	433
■ CI 595 CN	160	■ DIRTSTOP® XL B	295	■ EQM DOUBLE H/C	495	■ IVAR-APEX B	81	■ LEGIO-BOX 2	433
■ CI 595 MN	162	■ DIRTSTOP® XL P	295	■ EQM FLOOR	495	■ IVAR-APEX R	83	■ LEGIO-BOX 3	433
■ CI 596 CN	161	■ DM 1415	61	■ E-SAT	399	■ IVAR-APEX RCB	83	■ LOCK 01	507
■ CI 596 MN	163	■ DM 1416	61	■ EVG 00	467	■ IVAR-APEX RCF	84	■ M 01	502
■ CI 598	184	■ DPCV XL	380	■ EVG 01	467	■ IVAR-APEX RCR	83	■ M 106	321
■ CI 598 SP	185	■ DS 202	50	■ FAS	280	■ IVAR-ESAT DUAL	386	■ M 106	336
■ CI 599	183	■ DS 206	50	■ FAS-INDUSTRY	280	■ IVAR-PE-RT 5	85	■ M 106	362
■ CI 599 SP	183	■ DS 302	49	■ FAS-SLIM	280	■ IVAR-PE-Xa 3	87	■ MA 00	449
■ CI 600 N	150	■ DS 306	49	■ FAS-SR	283	■ IVAR-PE-Xa B	283	■ MA 10	337
■ CI 601 N	151	■ DS 312	49	■ FAST-ORG	271	■ IVAR-PE-Xa R	283	■ MA 10	442
■ CLIMA-HUB 01	354	■ DS 322	236	■ FCU-KIT 00	75	■ IVARSAT-H	394	■ MA 16	449
■ CLIMA-HUB 02	355	■ DS 330	49	■ FCU-KIT 01	76	■ IVARSAT-H C. mod.	394	■ MA 20	247
■ CLIMA-HUB 04	351	■ DS 336	52	■ FF-Therm PE-Xa	87	■ IVARSAT-HL	390	■ MA 20 R	247
■ CLIP03	281	■ DS 346	58	■ FI 00	444	■ IVARSAT-HL C. mod.	391	■ MA 20 R	309
■ CLIP-AUT	281	■ DS 356	58	■ FI 10	445	■ IVARSAT-HLE	390	■ M-BUS pulse ad.	509
■ CLIP-FLAT 17	281	■ DS 402	54	■ FIB	282	■ IVARSAT-HLE C. mod.	391	■ MC1 C. mod.	480
■ CLIP-FLAT 20	281	■ DS 404	54	■ FLAT-ORG	273	■ IVARSAT-HL/HLE Temp.	391	■ MC1 - MC2	478
■ CLIP-FLAT 25	281	■ DSK 01	292	■ FLB70	531	■ IVARSAT-H Temp.	394	■ MC1 Temp.	480
■ CLIP-MAN	281	■ DV 011	15	■ FLC 15	219	■ IVARSAT-L	392	■ MC2 C. mod.	480
■ CLIP-NET	281	■ DV 013	14	■ FLI-SOL	531	■ IVARSAT-L C. mod.	393	■ MC2 Temp.	480
■ CMG 00	467	■ DV 015	17	■ FMC	467	■ IVARSAT-LE	392	■ MC3	494
■ CMI	496	■ DV 016	17	■ GA 00	338	■ IVARSAT-LE C. mod.	393	■ MC3A	487
■ COLL-COMBIMETER	500	■ DV 017	16	■ GIU	280	■ IVARSAT-L/LE Temp.	393	■ MC3A I	487
■ COLL-MC	501	■ DV 018	16	■ GP6010	529	■ IVAR.SR	326	■ MC4	491
■ COLLMETER	498	■ DV 019	15	■ GP6010E	528	■ JUSTO	358	■ MC4 C. mod.	493
■ COLLMETER FLOOR	499	■ DV 020	14	■ GP7000	529	■ JUSTO LITE	358	■ MC4 Temp.	493
■ COMBI M	241	■ DV 021	15	■ GP7000E	528	■ JUSTO LITE W	358	■ MC11 - MC21	478
■ COMBIMETER	498	■ DV 023	14	■ GP7000W	529	■ JUSTO W	358	■ MC12 - MC22	478
■ COMBI MNB	241	■ DV 025	16	■ GP7000WE	528	■ KC 01 A (1")	166	■ MC13 - MC23	479
■ COMBI-SATMETER	499	■ DV 026	16	■ GRAPH	267	■ KC 01 A (1"1/4)	166	■ MC14 - MC24	479
■ COMBI T	240	■ DV 027	17	■ GRF 00 P	286	■ KC 01 AS (1")	168	■ MC15 - MC25	479
■ COMBI TNB	240	■ DV 028	17	■ GS 00 E	439	■ KC 01 AS (1"1/4)	168	■ MC31	494
■ CP 001 (1"1/4)	203	■ DV 029	15	■ GS 10 E	439	■ KC 01 KC (1")	164	■ MC32	494
■ CP 002 KC (1")	201	■ DV 030	14	■ GS 20 D	439	■ KC 01 KC (1"1/4)	164	■ MC33	494
■ CPS 10	337	■ DV 031	15	■ GS 20 E	439	■ KC 02 A (1")	167	■ MC33A	487
■ CPS 20	337	■ DV 032	14	■ GS 101	439	■ KC 02 A (1"1/4)	167	■ MC33A I	487
■ CRTH	359	■ DV 041	15	■ GWY1H	522	■ KC 02 AS (1")	169	■ MC34	494
■ CRTV 02	431	■ DV 042	14	■ GWYMH	519	■ KC 02 AS (1"1/4)	169	■ MC34A	487
■ CS 200 N	421	■ DV 101	19	■ GWYMH	522	■ KC 02 KC (1")	165	■ MC34A I	487
■ CS 368 N	425	■ DV 101 B	19	■ HD09	281	■ KC 02 KC (1"1/4)	165	■ MC41	491
■ CS 500 (1"1/2)	171	■ DV 102	19	■ HD17	131	■ KCA 02 A (1")	198	■ MC42	491
■ CS 500 N	145	■ DV 102 B	19	■ HD GAS	454	■ KCA 02 AS (1")	199	■ MC43	492
■ CS 501 (1"1/2)	171	■ DV 103	18	■ HK PE-RT	85	■ KD 301 B	56	■ MC44	492
■ CS 501 N	146	■ DV 103 B	18	■ HMR-D	504	■ KD 301 BN	57	■ MC45	492
■ CS 502 N	147	■ DV 104	18	■ HMRI-K001-001	504	■ KD 301 L	56	■ MCC 04 B	427

PRODUCT	Page	PRODUCT	Page	PRODUCT	Page	PRODUCT	Page	PRODUCT	Page
■ MCC 04 R	427	■ MPL 5609	109	■ MUL-C 3LE	312	■ Q5 FIX 013	513	■ RST 00	466
■ MCC 04 W	427	■ MPL 5613	108	■ MUL-C 10 E	314	■ Q5 FIX 014	514	■ RT 00	467
■ MCC 05	427	■ MPL 5700	106	■ MUL-C 20 E	314	■ Q5 FIX 015	514	■ RTV A	431
■ METAL-CLIMA A	279	■ MPL 5700 R	106	■ MUL-C 0032 AC	314	■ Q5 FIX 016	514	■ RTV B	431
■ METAL-CLIMA P	279	■ MPL 5701	111	■ MUL-C 0033 AC	314	■ Q5 FIX 017	514	■ RTV C	431
■ MF 01	245	■ MPL 5702	112	■ MULTIMETER	497	■ Q5 FIX 018	514	■ RV 01	237
■ MHM5-00A2-00	505	■ MPL 5703	109	■ MULTI-SEPMETER	501	■ Q5 FIX 019	514	■ RV 01	241
■ MINIGRAPH	265	■ MPL 5704	106	■ NET-FLAT	281	■ Q5 FIX 020	515	■ RV 01	252
■ MIX 3W	336	■ MPL 5705	109	■ OG1	505	■ Q5 FIX 021	515	■ RV 01	315
■ MIX 4W	336	■ MPL 5710	106	■ PICC 01	373	■ Q5 FIX 022	515	■ RV 01	362
■ MOB 00 P	286	■ MPL 5711	108	■ PICC 02	373	■ Q5 FIX 023	515	■ RV 01	396
■ MOD 02	519	■ MPL 5712	108	■ PICC 03	373	■ Qlog	523	■ RV 03	376
■ MOD 02	522	■ MPL 5712 L	108	■ PICC 11	373	■ RA 761	123	■ RW 701 JL	358
■ MP 5607	93	■ MPL 5715	112	■ PICC 12	373	■ RA 761	214	■ RW 711 J	358
■ MP 5608	93	■ MPL 5716	112	■ PICC 13	373	■ RA 761	315	■ RWM	506
■ MP 5608 GAS	454	■ MPL 5717	109	■ PICC 20	375	■ RA 761	324	■ S00	532
■ MP 5609	90	■ MPL 5720	106	■ PICC 22	374	■ RA 761 N	123	■ SAFEMIX 00	441
■ MP 5610 B	99	■ MPL 5720 RC	107	■ PICV 00	372	■ RA 761 N	213	■ SAFEMIX 05	441
■ MP 5610 R	99	■ MPL 5720 RCL	107	■ PICV 00 FCU	76	■ RA 762	125	■ SAFEMIX 10	441
■ MP 5613	94	■ MPL 5720 RL	107	■ PICV 05	372	■ RA 861	125	■ SAFEMIX 15	441
■ MP 5613 GAS	456	■ MPL 5720 RLL	106	■ PICV 05	489	■ RA 862	125	■ SAP	402
■ MP 5700	90	■ MPL 5720 RR	107	■ PICV 10	372	■ RDC	285	■ SAP-C	403
■ MP 5700 GAS	455	■ MPL 5721	108	■ PICV 100	372	■ RDP 00	448	■ SATMETER	499
■ MP 5700 R	90	■ MPL 5722	109	■ PICV 105	372	■ RDP 10	448	■ SEPMETER	500
■ MP 5700 R GAS	454	■ MPL 5724	110	■ PICV 110	372	■ RDP 20	448	■ SF 1325 F	225
■ MP 5701	98	■ MPL 5725	110	■ PICV 200	374	■ RDP 30	448	■ SF 1335 F	225
■ MP 5701 GAS	457	■ MPL 5728	111	■ PICV 205	374	■ RDP 40	449	■ SF 1570	225
■ MP 5702	100	■ MPL 5729	107	■ PICV 210	374	■ REGCU	280	■ SIL	285
■ MP 5703	95	■ MPL 5730	107	■ PICV 300	375	■ RE SOL	331	■ SIL-CL	285
■ MP 5703 GAS	456	■ MPL 5760	111	■ PICV XL	377	■ RF 800	119	■ SLIM	263
■ MP 5704	90	■ MPL 5761	111	■ PLEN-D160	285	■ RF 800	324	■ SOUND	280
■ MP 5705	95	■ MPL 5762	111	■ PLURIMETER	495	■ RF 810	119	■ SP	327
■ MP 5710	91	■ MPL 5763	111	■ PMP 5700	102	■ RF 811	118	■ SPS	327
■ MP 5710 GAS	455	■ MPL 5764	110	■ PMP 5700 R	102	■ RF 820	119	■ SS 1710 B	128
■ MP 5711	93	■ MPL 5765	110	■ PMP 5710	102	■ RF I-SUNKSR	533	■ SS 1710 BR	128
■ MP 5711 GAS	454	■ MPL 5766	110	■ PMP 5720	102	■ RG 00	466	■ SS 1710 R	128
■ MP 5712	94	■ MPL 5769	110	■ PMP 5720 RC	103	■ RHM500	505	■ SS 1711 B	128
■ MP 5712 GAS	456	■ MPL 5780	110	■ PMP 5720 RCL	102	■ RM 780	120	■ SS 1711 R	128
■ MP 5712 L	94	■ MPL 5781	110	■ PMP 5720 RL	103	■ RM 4760	120	■ SS 1730	129
■ MP 5712 L GAS	456	■ MR 01	333	■ PMP 5720 RLL	102	■ RM 4770	120	■ SS 1731	129
■ MP 5715	100	■ MR 02	333	■ PMP 5720 RR	103	■ RMK 780	120	■ SS 1735	129
■ MP 5716	100	■ MR 03	333	■ PMPL 5700	114	■ RMK 781	121	■ SS 1740	129
■ MP 5717	94	■ MR 22	332	■ PMPL 5700 R	114	■ RMK 4760	120	■ SW-US	505
■ MP 5720	91	■ MR 32	332	■ PMPL 5710	114	■ RMK 4761	121	■ T 1500	25
■ MP 5720 GAS	455	■ M-SAT	398	■ PMPL 5720	114	■ RMK 4770	120	■ T 1500	53
■ MP 5720 RC	92	■ MT 00	436	■ PMPL 5720 RC	115	■ RMK 4771	121	■ T 5000	24
■ MP 5720 RC GAS	455	■ MT 00 HT	437	■ PMPL 5720 RCL	114	■ RP 731	124	■ T 5000	259
■ MP 5720 RCL	91	■ MT 00 SOL	436	■ PMPL 5720 RL	115	■ RP 731	214	■ T 5000 CHROME	25
■ MP 5720 RCL GAS	455	■ MT 05	436	■ PMPL 5720 RLL	114	■ RP 731	315	■ T 5000 CHROME	259
■ MP 5720 RL	92	■ MT 05 HT	437	■ PMPL 5720 RR	115	■ RP 731	324	■ T 5005	25
■ MP 5720 RL GAS	455	■ MT 05 SOL	436	■ POLIFEMO®	297	■ RP 731 N	124	■ T 5010	24
■ MP 5720 RLL	91	■ MUL 1H/1L	307	■ POLIFEMO® 1"	297	■ RP 731 N	213	■ T 5011	237
■ MP 5720 RLL GAS	455	■ MUL 1H/2L	307	■ POLIFEMO® EXTRA	297	■ RP 732	125	■ T 5011	240
■ MP 5720 RR	92	■ MUL 1HE/1LE	305	■ POLIFEMO® PLUS	298	■ RP 5700	280	■ T 5011 U	252
■ MP 5720 RR GAS	455	■ MUL 1HE/2LE	305	■ PPSU1	284	■ RPT1H	522	■ T 5011 U	315
■ MP 5721	93	■ MUL 2H	306	■ PPSU2	284	■ RPTMH	522	■ T 5011 U	396
■ MP 5721 GAS	454	■ MUL 2H/1L	307	■ PPSU3	284	■ RR 701	65	■ T 5012	237
■ MP 5722	95	■ MUL 2HE	304	■ PPSU4	284	■ RR 702	129	■ T 5020	24
■ MP 5722 GAS	456	■ MUL 2HE/1LE	305	■ PPSU5	284	■ RR 702 OPTIMA	20	■ T 5030	24
■ MP 5723	98	■ MUL 2L	306	■ PPSU6	284	■ RR 703	118	■ T 5030	259
■ MP 5724	98	■ MUL 2LE	304	■ PPSU7	284	■ RR 704	121	■ TA 420	55
■ MP 5725	98	■ MUL 3H	306	■ PPSU8	284	■ RR 723	121	■ TA 420	428
■ MP 5728	98	■ MUL 3HE	304	■ PPSU9	284	■ RR 781 N	126	■ TA 420 P	55
■ MP 5729	100	■ MUL 3L	306	■ PRV	447	■ RR 781 TP	532	■ TA 420 P	123
■ MP 5730	100	■ MUL 3LE	304	■ PRV NB	447	■ RR 881 TP	532	■ TA 420 P	428
■ MP 5760	97	■ MUL 10 E	309	■ PS	328	■ RR 4608	117	■ TA 4420	66
■ MP 5760 GAS	456	■ MUL 11	309	■ PS I-SUNF	533	■ RR 4613	65	■ TA 4420	123
■ MP 5761	97	■ MUL 20	309	■ PS I-SUNKSR	533	■ RR 4613	118	■ TA 4420	212
■ MP 5762	97	■ MUL 20 E	309	■ PSR	329	■ RR 4700	117	■ TA 4420	428
■ MP 5763	98	■ MUL 0032	308	■ PSRR	329	■ RR 4710	117	■ TE 3003	376
■ MP 5764	98	■ MUL 0032 AC	308	■ PSS	328	■ RR 4711	117	■ TE 3040	220
■ MP 5765	97	■ MUL 0033	308	■ PT 1000	404	■ RR 4712	118	■ TE 3040	360
■ MP 5766	97	■ MUL 0033 AC	308	■ PT 5706	134	■ RR 4720	117	■ TE 3040	397
■ MP 5767	99	■ MUL-C 1HE/1LE	313	■ Q5.5 C-mode	512	■ RR 4721	117	■ TE 3040	477
■ MP 5769	97	■ MUL-C 1HE/2LE	313	■ Q5 FIX 008	513	■ RR 4722	118	■ TE 3040	488
■ MP 5780	96	■ MUL-C 2HE	312	■ Q5 FIX 009	513	■ RR 4723	121	■ TE 3040 IV	141
■ MP 5781	96	■ MUL-C 2HE/1LE	313	■ Q5 FIX 010	513	■ RR I-SUNF	533	■ TE 3040 IV	220
■ MPL 5607	109	■ MUL-C 2LE	312	■ Q5 FIX 011	513	■ RR 500	532	■ TE 3040 IV	361
■ MPL 5608	108	■ MUL-C 3HE	312	■ Q5 FIX 012	513	■ RR 5030 TP	532	■ TE 3040 IV	477

PRODUCT	Page	PRODUCT	Page	PRODUCT	Page	PRODUCT	Page
TE 3040 IV	488	VCD 2166 DX	34	VNR 01	443	WWM	325
TE 3050 M	220	VCD 2166 DXT	34	VR 00	443		
TE 3050 M	360	VCD 2166 N DX	42	VS1	326		
TE 3050 M	397	VCD 2166 N DXT	42	VS 002 DRM	47		
TE 3050 M	477	VCD 2166 NH DX	30	VS3	326		
TE 3050 M	488	VCR 232	46	VS 006 DRM	47		
TE 3050 MC	141	VCR 236	46	VS 102	54		
TE 3050 MC	220	VCR 2132	33	VS 104	54		
TE 3050 MC	361	VCR 2132 N	41	VS 202	46		
TE 3050 MC	477	VCR 2132 NH	29	VS 206	46		
TE 3050 MC	488	VCR 2132 NT	41	VS 1102	53		
TE 3061	237	VCR 2132 T	33	VS 1104	53		
TE 3061	241	VCR 2136	32	VS 2102	33		
TE 3061	361	VCR 2136 N	40	VS 2102 N	41		
TE 4040 A	360	VCR 2136 NH	28	VS 2102 NH	29		
TECHNO TNB	244	VCR 2136 NT	40	VS 2102 NT	41		
Test kit DW IVARSAT	395	VCR 2136 T	32	VS 2102 T	33		
Test kit H/B IVARSAT	395	VCS 2162 NH SX	30	VS 2102 XL	37		
THERM	269	VCS 2162 N SX	43	VS 2106	32		
TM 00	369	VCS 2162 N SXT	43	VS 2106 N	40		
TM 10	369	VCS 2162 SX	35	VS 2106 NH	28		
TM 3052	68	VCS 2162 SXT	35	VS 2106 NT	40		
TM 3053	68	VCS 2166 NH SX	30	VS 2106 T	32		
TM 3053	219	VCS 2166 N SX	42	VS 2146	59		
TOP-CLIMA A	277	VCS 2166 N SXT	42	VS 2156	59		
TOP-CLIMA P	277	VCS 2166 SX	34	VSBDZR	327		
TP 410	55	VCS 2166 SXT	34	VSC 00 H	337		
TP 410	428	VD 001 DRM	47	VSC 00 S	442		
TP 410 P	55	VD 005 DRM	47	VSC 00 SOL	531		
TP 410 P	124	VD 201	46	VSC 01 H	337		
TP 410 P	428	VD 205	46	VSC 01 S	442		
TP 4410	66	VD 2101	33	VSC 05 H	337		
TP 4410	124	VD 2101 N	41	VSC 05 S	442		
TP 4410	212	VD 2101 NH	29	VSC 10 H	337		
TP 4410	428	VD 2101 NT	41	VSC 10 S	442		
TP 4410 HK	124	VD 2101 T	33	VSC 11 H	337		
TR 401	67	VD 2101 XL	37	VSC 11 S	442		
TR 401	126	VD 2105	32	VSC 15 H	337		
TR 402	67	VD 2105 N	40	VSC 15 S	442		
TR 402	126	VD 2105 NH	28	VSGD 00	465		
TR 430	55	VD 2105 NT	40	VSGD 05	465		
TR 430	429	VD 2105 T	32	VSGS 00	465		
TR 430 P	55	VD 2111	36	VSGS 05	465		
TR 430 P	126	VD 2111 N	44	VSRDZR	327		
TR 430 P	429	VD 2115	36	VS SAP 01	404		
TR 4430	61	VD 2115 N	44	VS SAP 02	404		
TR 4430	66	VD 2127	36	VST 00	467		
TR 4430	126	VD 2127 N	44	VTC 30	218		
TR 4430	429	VD 2127 NT	44	VTC 30 PL	218		
TR 4430-18	66	VD 2127 T	36	VTT 02	68		
TR 4430-18	126	VD 2145	59	VTT 03	68		
TR 4430-18	429	VD 2155	59	VZ 00	227		
TSP	331	VDC 31	218	VZ 30	227		
TT	331	VDC 31 PL	218	VZS 00	228		
UF 01	254	VDS 01	237	VZS 05	228		
UM 01	247	VDS 02	237	VZS 10	228		
UM 01 D/S	247	VEARS	331	VZS 20	228		
UMC 01	251	VESOL	531	VZS 21	228		
UMC 01 D/S	251	VFC 01	71	WALK-BY pulse ad.	509		
UNIMETER	496	VFC 02	71	WFK	506		
USF	505	VFC 03	71	WFW	506		
US-QD	504	VFS	404	WFZ-IrDA-USB	505		
VA 80	361	VGD 00	459	WFZ-IrDA-USB	512		
VAR 00	322	VGD 05	460	WFZ-MBM-USB	509		
VAR 10	321	VGD 10	461	WILO3F	236		
VAR 11	321	VGD 50	464	WILO3F	242		
VAR 20-21-22-23	320	VGD 50	464	WILO3F	255		
VAR 20-21-22-23 LT	320	VGDX 00	459	WILO3F	307		
VAR 30	322	VGDX 05	460	WILO3F	322		
VAR 30 HT	531	VGDX 10	461	WILO4F	236		
VARIMETER	497	VGS 00	459	WILO4F	242		
VB 00	368	VGS 05	460	WILO4F	255		
VB 10	368	VGS 10	461	WILO4F	305		
VB 20	368	VIT 51	59	WILO4F	313		
VCD 2162 DX	35	VIT 52	59	WILO4F	322		
VCD 2162 DXT	35	VM 1303 R	62	WSW5 DB	512		
VCD 2162 N DX	43	VM 1405	63	WSW5 S	505		
VCD 2162 N DXT	43	VM 1415	63	WSW5 S	512		
VCD 2162 NH DX	30	VM 1505	63	WT	522		
		VM 1515	63				



CODE	Page	CODE	Page	CODE	Page	CODE	Page	CODE	Page
0EPJ00	353	1V54505	329	200186	204	400089N	148	400283CN	156
0KC2TH	352	1V54805	329	200186	503	400090N	148	400283MN	158
00M100001	502	1VD5A05	331	200190	204	400091N	148	400284CN	156
00M100003	502	1VD5A35	331	200190	316	400092N	148	400284MN	158
0SDTH01	352	1VD5A55	331	200190	396	400093N	148	400285CN	156
1J09A55	326	1VD5B05	331	200190	503	400122CN	152	400285MN	158
1J09B05	326	1VD5585	331	200194	396	400122MN	154	400286CN	156
1J09C05	326	1VD5805	331	200199	489	400123CN	152	400286MN	158
1J09D05	326	1Y59A05	325	200286	204	400123MN	154	400287CN	156
1J09E05	326	1Y5920D	325	200290	204	400124CN	152	400287MN	158
1J11A55	326	1Y5930D	325	200294	396	400124MN	154	400288CN	156
1J11B05	326	1Y5940D	325	200299	489	400125CN	152	400288MN	158
1J11B55	326	1Y5950D	325	200386	204	400125MN	154	400289CN	156
1J11C05	326	1Y7830D	325	200390	204	400126CN	152	400289MN	158
1J11D05	326	1Y7850D	325	200486	204	400126MN	154	400290CN	156
1J11E05	326	1Y59805	325	200490	204	400127CN	152	400290MN	158
1K01A0Z	327	0063.01	502	200586	204	400127MN	154	400291CN	156
1K02A0Z	327	3156	533	200590	204	400128CN	152	400291MN	158
1K04A05	330	8366N007HT	533	200590	503	400128MN	154	400292CN	156
1K04A55	330	10303	530	200686	204	400129CN	152	400292MN	158
1K04B05	330	13300	530	200690	204	400129MN	154	400293CN	156
1K09A05	326	143005	530	200786	204	400130CN	152	400293MN	158
1K11A05	326	16305	530	200790	204	400130MN	154	400342CN	157
1K53A05	330	17403	530	200886	204	400131CN	152	400342MN	159
1K53A55	330	23065	132	200890	204	400131MN	154	400343CN	157
1K53B05	330	23095	132	200986	204	400132CN	152	400343MN	159
1K0115D	327	43000	404	220080	208	400132MN	154	400344CN	157
1K0120D	327	52000	130	400002N	149	400133CN	152	400344MN	159
1K0130D	327	52030	130	400003N	149	400133MN	154	400345CN	157
1K0140D	327	52031	130	400004N	149	400242CN	156	400345MN	159
1K0150D	327	52040	130	400005N	149	400242CNP80	156	400346CN	157
1K0160D	327	52041	130	400006N	149	400242MN	158	400346MN	159
1K0180Z	327	52042	130	400007N	149	400242MNP80	158	400347CN	157
1K0220D	327	60200	134	400008N	149	400243CN	156	400347MN	159
1K0230D	327	60250	134	400009N	149	400243CNP80	156	400348CN	157
1K0240D	327	61185	134	400010N	149	400243MN	158	400348MN	159
1K0250D	327	70031	130	400011N	149	400243MNP80	158	400349CN	157
1K0260D	327	70109	130	400012N	149	400244CN	156	400349MN	159
1K0280Z	327	070110X	132	400022CN	153	400244CNP80	156	400350CN	157
1K04605	330	070111X	132	400022MN	155	400244MN	158	400350MN	159
1K04755	330	070112X	132	400023CN	153	400244MNP80	158	400351CN	157
1K09309	326	070188D	130	400023MN	155	400245CN	156	400351MN	159
1K09509	326	70490	132	400024CN	153	400245CNP80	156	400352CN	157
1K09805	326	78040	404	400024MN	155	400245MN	158	400352MN	159
1K11805	326	78100	404	400025CN	153	400245MNP80	158	400362N	146
1K53605	330	78400	404	400025MN	155	400246CN	156	400363N	146
1K53755	330	81215	404	400026CN	153	400246CNP80	156	400364N	146
1V12A05	328	88700	130	400026MN	155	400246MN	158	400365N	146
1V12A35	328	140039	132	400027CN	153	400246MNP80	158	400366N	146
1V12A55	328	140042	132	400027MN	155	400247CN	156	400367N	146
1V12B05	328	140043	132	400028CN	153	400247CNP80	156	400368N	146
1V12C05	328	140044	132	400028MN	155	400247MN	158	400369N	146
1V12D05	328	140045	132	400029CN	153	400247MNP80	158	400370N	146
1V12E05	328	140060	132	400029MN	155	400248CN	156	400371N	146
1V13A05	329	140066	132	400030CN	153	400248CNP80	156	400372N	146
1V13A35	329	140068	132	400030MN	155	400248MN	158	400373N	146
1V13A55	329	140069	132	400031CN	153	400248MNP80	158	400392N	147
1V13B05	329	140081	132	400031MN	155	400249CN	156	400393N	147
1V13C05	329	140082	132	400032CN	153	400249CNP80	156	400394N	147
1V13D05	329	180006	323	400032MN	155	400249MN	158	400395N	147
1V13E05	329	190099BDZR	327	400042N	148	400249MNP80	158	400396N	147
1V19A01	328	190099RDZR	327	400043N	148	400250CN	156	400397N	147
1V54A05	329	200085	503	400044N	148	400250CNP80	156	400398N	147
1V54A35	329	200086	204	400045N	148	400250MN	158	400399N	147
1V54A55	329	200086	503	400046N	148	400250MNP80	158	400400N	147
1V1905D	328	200089	204	400047N	148	400251CN	156	400401N	147
1V1910D	328	200089	316	400048N	148	400251CNP80	156	400402N	147
1V1920D	328	200090	204	400049N	148	400251MN	158	400403N	147
1V1930D	328	200090	316	400050N	148	400251MNP80	158	400432N	147
1V1950D	328	200090	396	400051N	148	400252CN	156	400433N	147
1V5730DSTT3	331	200090	503	400052N	148	400252CNP80	156	400434N	147
1V5750DSTT4	331	200091	503	400053N	148	400252MN	158	400435N	147
1V12305	328	200094	396	400082N	148	400252MNP80	158	400436N	147
1V12505	328	200095	503	400083N	148	400253CN	156	400437N	147
1V12805	328	200130	204	400084N	148	400253CNP80	156	400438N	147
1V13305	329	200131	204	400085N	148	400253MN	158	400439N	147
1V13505	329	200132	204	400086N	148	400253MNP80	158	400440N	147
1V13805	329	200133	204	400087N	148	400282CN	156	400441N	147
1V19801	328	200147	315	400088N	148	400282MN	158	400442N	147

CODE	Page	CODE	Page	CODE	Page	CODE	Page	CODE	Page
400443N	147	500035N	145	500090CN	160	500175	65	500395	61
400742	201	500036N	145	500090CNP80	160	500175	118	500399	33
400743	201	500037N	145	500090MN	162	500176	117	500399RC	33
400744	201	500038N	145	500090MNP80	162	500177	117	500399T	33
400745	201	500039N	145	500091CN	160	500181	117	500399TRC	33
400746	201	500040N	145	500091CNP80	160	500193	117	500400	66
400747	201	500041N	145	500091MN	162	500194	117	500400	123
400748	201	500042N	145	500091MNP80	162	500195	118	500400	212
400749	201	500043	123	500092CN	160	500196	118	500400	428
400750	201	500043	214	500092CNP80	160	500197	118	500401	120
400751	201	500043	324	500092MN	162	500198	118	500403	237
400752	201	500043N	123	500092MNP80	162	500199	117	500403M	237
400753	201	500043N	214	500093CN	160	500201	67	500405	120
400754	201	500043N	315	500093CNP80	160	500203	123	500406	131
400812N	147	500043N	324	500093MN	162	500203	324	500407	131
400813N	147	500046	68	500093MNP80	162	500203N	123	500408	131
400814N	147	500046	219	500097	117	500203N	324	500409	131
400815N	147	500047	68	500098	117	500250	25	500410	240
400816N	147	500048	47	500099	117	500255	206	500410NB	240
400817N	147	500048R	47	500106	67	500256	206	500410PE	240
400818N	147	500048RC	47	500106	223	500257	206	500414	245
400819N	147	500048RCR	47	500109	69	500258	206	500414P	245
400820N	147	500049	55	500110	69	500259N	121	500414PE	245
410702	203	500049	428	500118	117	500261N	121	500417	66
410703	203	500053	49	500119	118	500280	216	500417	126
410704	203	500053R	49	500120	118	500304MP	99	500417	429
410705	203	500053RC	49	500122	123	500304RMP	99	500423	59
410706	203	500053RCR	49	500122	214	500306MP	99	500424	59
410707	203	500056	68	500122	324	500306RMP	99	500430	34
410708	203	500056	219	500122N	123	500307	120	500430R	34
410709	203	500059	117	500122N	214	500308	33	500430RC	34
410710	203	500060	121	500122N	315	500308RC	33	500430RCR	34
410711	203	500063	215	500124	224	500308T	33	500430T	34
410712	203	500064	210	500124G	224	500308TRC	33	500430TR	34
410713	203	500064P80	210	500125	206	500309	33	500430TRC	34
410714	203	500069	67	500125	210	500309RC	33	500430TRCR	34
410715	203	500070	215	500126	210	500309T	33	500431	42
410716	203	500070	309	500126P80	210	500309TRC	33	500431R	42
420100	533	500071	215	500127	210	500317	58	500431RC	42
470201SR	533	500072	215	500127G	210	500317B	58	500431RCR	42
500007	55	500073	224	500127GP80	210	500323	58	500431T	42
500007	429	500073G	224	500127P80	210	500323B	58	500431TR	42
500009	66	500077	117	500128	211	500325	386	500431TRC	42
500009	123	500080	65	500128G	211	500325A	386	500431TRCR	42
500009	212	500080	118	500131	128	500325AC	386	500433	35
500009	428	500081	65	500131R	128	500325C	386	500433RC	35
500012	66	500081	118	500132	128	500357	215	500433T	35
500012	123	500082CN	160	500132R	128	500357N	215	500433TRC	35
500012	212	500082CNP80	160	500134	141	500362	386	500438	247
500012	428	500082MN	162	500135	117	500362A	386	500438D	247
500014	55	500082MNP80	162	500136	117	500362AC	386	500438DP130	247
500014	429	500083CN	160	500137	117	500362C	386	500438DPE130	247
500016	55	500083CNP80	160	500138	117	500363	386	500438P130	247
500016	429	500083MN	162	500139	118	500363A	386	500438PE130	247
500022	216	500083MNP80	162	500140	118	500363AC	386	500438S	247
500022	429	500084CN	160	500141	55	500363C	386	500438SP130	247
500022HT	533	500084CNP80	160	500141	429	500377	117	500438SPE130	247
500024	61	500084MN	162	500145	66	500378	117	500439	33
500024	66	500084MNP80	162	500145	124	500379	225	500439RC	33
500024	126	500085CN	160	500145	212	500381	61	500439T	33
500024	429	500085CNP80	160	500145	428	500382	41	500439TRC	33
500025	61	500085MN	162	500147	236	500382RC	41	500440	33
500025	66	500085MNP80	162	500147L	236	500382T	41	500440RC	33
500025	126	500086CN	160	500147M	236	500382TRC	41	500440T	33
500025	429	500086CNP80	160	500148	66	500384	41	500440TRC	33
500026	61	500086MN	162	500148	124	500384RC	41	500454	240
500026	66	500086MNP80	162	500148	212	500384T	41	500454NB	240
500026	126	500087CN	160	500148	428	500384TRC	41	500454P	240
500026	429	500087CNP80	160	500154	129	500386	215	500454PE	240
500028M	220	500087MN	162	500155	129	500386N	215	500456	253
500028M	360	500087MNP80	162	500156	129	500387	215	500456S	253
500028M	397	500088CN	160	500157	61	500387	322	500459	41
500028M	477	500088CNP80	160	500157	66	500387N	215	500459RC	41
500028M	488	500088MN	162	500157	66	500387N	322	500459T	41
500029	131	500088MNP80	162	500157	126	500388	237	500459TRC	41
500030	131	500089CN	160	500157	429	500388M	237	500462CN	153
500032N	145	500089CNP80	160	500161	64	500389N	339	500462MN	155
500033N	145	500089MN	162	500174	65	500393	61	500463CN	153
500034N	145	500089MNP80	162	500174	118	500394	61		

CODE	Page	CODE	Page	CODE	Page	CODE	Page	CODE	Page
500463MN	155	500518R	34	500591	428	500697	219	500827TRCR	40
500464CN	153	500518RC	34	500594	120	500699	215	500829	35
500464MN	155	500518RCR	34	500598	52	500750	49	500829RC	35
500465CN	153	500518T	34	500605N	67	500751	49	500829T	35
500465MN	155	500518TR	34	500605N	223	500751R	49	500829TRC	35
500466CN	153	500518TRC	34	500623	49	500751RC	49	500831	59
500466MN	155	500518TRCR	34	500624	65	500751RCR	49	500845	58
500467CN	153	500519	42	500624N	65	500753	66	500845B	58
500467MN	155	500519R	42	500625	216	500753	124	500848	58
500468CN	153	500519RC	42	500625	429	500753	212	500848B	58
500468MN	155	500519RCR	42	500625N	216	500753	428	500867	219
500469CN	153	500519T	42	500625N	429	500754	66	500870	41
500469MN	155	500519TR	42	500632	65	500754	123	500870RC	41
500470CN	153	500519TRC	42	500632N	65	500754	212	500870T	41
500470MN	155	500519TRCR	42	500634RC	236	500754	428	500870TRC	41
500471CN	153	500522	217	500641	209	500759	55	500887	237
500471MN	155	500523	224	500642	49	500759	123	500887	241
500472CN	153	500523G	224	500642RC	49	500759	428	500887	361
500472MN	155	500526	224	500644	49	500769	66	500888	41
500473	32	500526G	224	500644RC	49	500769	124	500888RC	41
500473R	32	500527	236	500645RC	236	500769	212	500888T	41
500473RC	32	500528	224	500647	49	500769	428	500888TRC	41
500473RCR	32	500528G	224	500647RC	49	500770	13	500890	36
500473T	32	500529	224	500649	66	500770	52	500890T	36
500473TR	32	500529G	224	500649	124	500770	58	500891	44
500473TRC	32	500530	237	500649	212	500770	67	500891T	44
500473TRCR	32	500530U	237	500649	428	500784	49	500893	225
500474	40	500543	68	500650	66	500792N	145	500897	251
500474R	40	500544	68	500650	124	500793N	145	500897D	251
500474RC	40	500546	43	500650	212	500794N	145	500897DE	251
500474RCR	40	500546RC	43	500650	428	500795N	145	500897DWP	251
500474T	40	500546T	43	500651	66	500796N	145	500897E	251
500474TR	40	500546TRC	43	500651	124	500797N	145	500897S	251
500474TRC	40	500547	43	500651	212	500798N	145	500897SE	251
500474TRCR	40	500547RC	43	500651	428	500799N	145	500897SWP	251
500479	36	500547T	43	500652	49	500800N	145	500897WP	251
500480	44	500547TRC	43	500652RC	49	500801N	145	500899	443
500495	217	500557	49	500655	49	500802N	145	500900	443
500496	36	500558	32	500655RC	49	500803N	145	500901	209
500497	44	500558R	32	500656	49	500804	215	500902	209
500499	437	500558RC	32	500656RC	49	500804	254	500903	209
500500	33	500558RCR	32	500667	118	500805	32	500904	216
500500RC	33	500558T	32	500667N	118	500805R	32	500904HT	531
500500T	33	500558TR	32	500670	216	500805RC	32	500904	322
500500TRC	33	500558TRC	32	500672	119	500805RCR	32	500905	216
500501	33	500558TRCR	32	500674	207	500805T	32	500905	322
500501RC	33	500561	47	500674M	69	500805TR	32	500906	216
500501T	33	500561RC	47	500674M	207	500805TRC	32	500907	216
500501TRC	33	500562	47	500675	207	500805TRCR	32	500908	216
500502	37	500562RC	47	500675M	69	500806	40	500909	216
500502RC	37	500563	47	500675M	207	500806R	40	500910	216
500503	37	500563RC	47	500679	66	500806RC	40	500911	216
500503RC	37	500565	47	500679	124	500806RCR	40	500912	215
500504	37	500565RC	47	500679	212	500806T	40	500913	215
500504RC	37	500566	47	500679	428	500806TR	40	500914	66
500505	37	500566RC	47	500680	66	500806TRC	40	500914	123
500505RC	37	500567	47	500680	124	500806TRCR	40	500914	212
500506	25	500567RC	47	500680	212	500808M	220	500914	428
500507	30	500571	47	500680	428	500808M	360	500915	119
500507RC	30	500571R	47	500681	66	500808M	397	500916	119
500508	30	500571RC	47	500681	124	500808M	477	500917	119
500508RC	30	500571RCR	47	500681	212	500808M	488	500919	215
500509	30	500574	116	500681	428	500808MC	141	500919N	215
500509R	30	500574	120	500682	66	500808MC	220	500920	218
500509RC	30	500579	66	500682	124	500808MC	361	500920PL	218
500509RCR	30	500579	123	500682	212	500808MC	477	500922CN	157
500510	30	500579	212	500682	428	500808MC	488	500922CNP80	157
500510RC	30	500579	428	500683	66	500810	41	500922MN	159
500511	30	500585	64	500683	123	500810RC	41	500922MNP80	159
500511RC	30	500586	253	500683	212	500810T	41	500923CN	157
500512	30	500586D	253	500683	428	500810TRC	41	500923CNP80	157
500512RC	30	500586S	253	500684	66	500823	59	500923MN	159
500512RCR	30	500590	66	500684	123	500827	40	500923MNP80	159
500513	41	500590	124	500684	212	500827R	40	500924CN	157
500513RC	41	500590	212	500684	428	500827RC	40	500924CNP80	157
500513T	41	500590	428	500685	66	500827RCR	40	500924MN	159
500513TRC	41	500591	66	500685	123	500827TRC	40	500924MNP80	159
500513TRCR	41	500591	124	500685	212	500827T	40	500925CN	157
500518	34	500591	212	500685	428	500827TR	40	500925CNP80	157
						500827TRC	40		

CODE	Page	CODE	Page	CODE	Page	CODE	Page	CODE	Page
500925MN	159	501032	55	501172C	259	501357N	223	501459RC	46
500925MNP80	159	501032	428	501173	24	501359	208	501459RCR	46
500926CN	157	501034	55	501174	24	501360	208	501497	123
500926CNP80	157	501034	428	501175	237	501361	123	501497	214
500926MN	159	501035	55	501175	240	501361	214	501497	324
500926MNP80	159	501035	428	501175U	252	501361	324	501497N	123
500927CN	157	501037	55	501175U	315	501361N	123	501497N	214
500927CNP80	157	501037	428	501175U	396	501361N	214	501497N	315
500927MN	159	501040	55	501176	237	501361N	315	501497N	324
500927MNP80	159	501040	428	501177	24	501361N	324	501498	124
500928CN	157	501041	119	501178	24	501363N	218	501498	214
500928CNP80	157	501042	119	501179	24	501365	129	501498	324
500928MN	159	501043	119	501179	259	501368N	218	501498N	124
500928MNP80	159	501047	67	501180	24	501370	364	501498N	214
500929CN	157	501047	126	501180	259	501381	237	501498N	315
500929CNP80	157	501048	55	501181	131	501381	241	501498N	324
500929MN	159	501048	428	501183	29	501381	252	501501	216
500929MNP80	159	501051	124	501183RC	29	501381	315	501508	220
500930CN	157	501051	214	501184	29	501381	362	501508	360
500930CNP80	157	501051	324	501184RC	29	501381	396	501508	397
500930MN	159	501051N	124	501185	28	501383	237	501508	477
500930MNP80	159	501051N	214	501185R	28	501383	241	501508	488
500931CN	157	501051N	315	501185RC	28	501383	252	501508A	360
500931CNP80	157	501051N	324	501185RCR	28	501383	315	501508E	141
500931MN	159	501052	124	501186	29	501383	362	501508E	220
500931MNP80	159	501052	214	501186RC	29	501383	396	501508E	361
500932CN	157	501052	324	501187	29	501384	376	501508E	477
500932CNP80	157	501052N	124	501187RC	29	501385	376	501508E	488
500932MN	159	501052N	214	501188	28	501386	376	501509	216
500932MNP80	159	501052N	315	501188R	28	501387	376	501524	220
500933	236	501052N	324	501188RC	28	501388	376	501524	360
500933	242	501054	124	501188RCR	28	501389	376	501524	397
500933	255	501054	214	501189	29	501394	321	501524	477
500934	236	501054	324	501189RC	29	501394	336	501524	488
500934	242	501054N	124	501190	29	501394	362	501524A	360
500934	255	501054N	214	501190RC	29	501395	321	501533	361
500935	209	501054N	315	501192	28	501395	336	501547	336
500936	209	501054N	324	501192R	28	501395	362	501548	336
500938	55	501056	55	501192RC	28	501396	321	501549	336
500938	429	501056	428	501192RCR	28	501396	336	501550	336
500954M	69	501058	118	501201	65	501396	362	501551	336
500954M	207	501063	119	501214N	67	501398	225	501552	336
500962N	149	501064	119	501214N	223	501402N	145	501553	336
500963N	149	501065	119	501215N	67	501403N	145	501554	336
500964N	149	501066	119	501215N	223	501404N	145	501555	336
500965N	149	501067	119	501217	58	501405N	145	501556	336
500966N	149	501068	119	501218	208	501406N	145	501557	336
500967N	149	501078	118	501219	67	501407N	145	501558	336
500968N	149	501079	118	501219	223	501408N	145	501559	336
500969N	149	501082	118	501263	210	501409N	145	501560	336
500970N	149	501084	123	501263G	210	501410N	145	501562	336
500971N	149	501084	214	501263GP80	210	501411N	145	501563	336
500972N	149	501084	324	501263P80	210	501412N	145	501564	336
500998	61	501084N	123	501278	68	501413N	145	501565	336
500998	66	501084N	214	501278	219	501418NB	222	501567	46
500998	126	501084N	315	501278D	68	501418NR	222	501567R	46
500998	429	501084N	324	501278DRN	68	501419	118	501567RC	46
501009	67	501094	119	501278NH	68	501419N	118	501567RCR	46
501009	126	501095	119	501279	67	501420	333	501570	336
501010	66	501096	119	501279	223	501421	333	501578	332
501010	123	501098	208	501296N	218	501422	333	501579	332
501010	212	501098P80	208	501297N	218	501424	69	501613	63
501010	428	501099	216	501301	64	501425	65	501614	63
501011	99	501101	215	501302	64	501451	46	501616	63
501011	128	501102	216	501307	119	501451RC	46	501618	119
501016	206	501103	216	501308	69	501452	46	501618	216
501019	208	501104	216	501323	207	501452RC	46	501618N	119
501019P80	208	501107	119	501323	308	501453	46	501618N	216
501020	208	501108	216	501325	207	501453RC	46	501619	119
501022	55	501111	208	501325	308	501455	222	501619	216
501022	428	501131	118	501327	207	501455B	222	501619N	119
501023	118	501131N	118	501329	207	501456	46	501619N	216
501024	118	501132	118	501352N	222	501456RC	46	501620	119
501025	55	501132N	118	501352NB	222	501457	46	501620	216
501025	428	501160	427	501353N	222	501457RC	46	501620N	119
501027	55	501160P80	427	501353NB	222	501458	46	501620N	216
501027	428	501172	24	501354N	222	501458RC	46	501621	119
501028	55	501172	259	501354NB	222	501459	46	501621	216
501028	428	501172C	25	501356N	223	501459R	46	501621N	119

CODE	Page	CODE	Page	CODE	Page	CODE	Page	CODE	Page
501621N	216	501741RTH	133	502124MP	100	502259MN	163	503111	465
501622	64	501741RTH	457	502124MPGAS	457	502259MNP80	163	503112	465
501623	64	501741RU	133	502124MPL	112	502260CN	161	503113	465
501624	64	501741RU	457	502124PMP	103	502260CNP80	161	503182	186
501625	403	501742RR	133	502124PMPL	115	502260MN	163	503183	186
501626	403	501742RR	457	502125MP	100	502260MNP80	163	503184	186
501632	141	501742RTH	133	502125MPGAS	457	502261CN	161	503185	186
501632	427	501742RTH	457	502125MPL	112	502261CNP80	161	503186	186
501636	46	501742RU	133	502125PMP	103	502261MN	163	503187	186
501636RC	46	501742RU	457	502125PMPL	115	502261MNP80	163	503188	186
501638	46	501743RBE	133	502126	100	502262CN	161	503189	186
501638RC	46	501743RBE	457	502127	100	502262CNP80	161	503190	186
501639	141	501743RR	133	502128	100	502262MN	163	503191	186
501639	427	501743RR	457	502142CN	160	502262MNP80	163	503192	186
501641	427	501743RTH	133	502142MN	162	502272CN	161	503193	186
501643	427	501743RTH	457	502143CN	160	502272MN	163	503194	186
501645	427	501743RU	133	502143MN	162	502273CN	161	503195	186
501647	321	501743RU	457	502144CN	160	502273MN	163	503196	186
501647	336	501744RBE	133	502144MN	162	502274CN	161	503202	194
501647	362	501744RBE	457	502145CN	160	502274MN	163	503202AIV	198
501648	321	501744RR	133	502145MN	162	502275CN	161	503202ASIV	199
501648	336	501744RR	457	502146CN	160	502275MN	163	503202P80	194
501648	362	501744RTH	133	502146MN	162	502276CN	161	503203	194
501650CN	152	501744RTH	457	502147CN	160	502276MN	163	503203AIV	198
501650MN	154	501745RBE	133	502147MN	162	502277CN	161	503203ASIV	199
501651CN	152	501745RBE	457	502148CN	160	502277MN	163	503203P80	194
501651MN	154	501745RR	133	502148MN	162	502278CN	161	503204	194
501652CN	152	501745RR	457	502149CN	160	502278MN	163	503204AIV	198
501652MN	154	501745RTH	133	502149MN	162	502279CN	161	503204ASIV	199
501653CN	152	501745RTH	457	502150CN	160	502279MN	163	503204P80	194
501653MN	154	501745RU	133	502150MN	162	502280CN	161	503205	194
501654CN	152	501745RU	457	502151CN	160	502280MN	163	503205AIV	198
501654MN	154	501746RTH	133	502151MN	162	502281CN	161	503205ASIV	199
501655CN	152	501746RTH	457	502152CN	160	502281MN	163	503205P80	194
501655MN	154	501746RU	133	502152MN	162	502282CN	161	503206	194
501656CN	152	501746RU	457	502153CN	160	502282MN	163	503206AIV	198
501656MN	154	501797	131	502153MN	162	502304	403	503206ASIV	199
501657CN	152	501804	116	502182N	151	502305	403	503206P80	194
501657MN	154	501804	121	502183N	151	502372N	150	503207	194
501658CN	152	501823	59	502184N	151	502373N	150	503207AIV	198
501658MN	154	501826	59	502185N	151	502374N	150	503207ASIV	199
501659CN	152	501828I	252	502186N	151	502375N	150	503207P80	194
501659MN	154	501828I	363	502187N	151	502376N	150	503208	194
501660CN	152	501901NR	502	502188N	151	502377N	150	503208AIV	198
501660MN	154	501902	437	502189N	151	502378N	150	503208ASIV	199
501661CN	152	501903	437	502190N	151	502379N	150	503208P80	194
501661MN	154	501905NB	222	502191N	151	502380N	150	503209	194
501669	437	501905NR	222	502192N	151	502381N	150	503209AIV	198
501677	64	501964	69	502230N	215	502382N	150	503209ASIV	199
501681N	421	501965	69	502252CN	161	502383N	150	503209P80	194
501682N	421	502061	427	502252CNP80	161	502392N	150	503210	194
501683N	421	502082N	151	502252MN	163	502393N	150	503210AIV	198
501685N	421	502083N	151	502252MNP80	163	502394N	150	503210ASIV	199
501687N	421	502084N	151	502253CN	161	502395N	150	503210P80	194
501689N	421	502085N	151	502253CNP80	161	502396N	150	503211	194
501701N	421	502086N	151	502253MN	163	502397N	150	503211AIV	198
501702N	421	502087N	151	502253MNP80	163	502398N	150	503211ASIV	199
501703N	421	502088N	151	502254CN	161	502399N	150	503211P80	194
501705N	421	502089N	151	502254CNP80	161	502400N	150	503212	194
501707N	421	502090N	151	502254MN	163	502401N	150	503212AIV	198
501709N	421	502091N	151	502254MNP80	163	502402N	150	503212ASIV	199
501728	241	502092N	151	502255CN	161	502403N	150	503212P80	194
501728NB	241	502100	242	502255CNP80	161	502442	63	503213	194
501728P	241	502103	242	502255MN	163	502443	63	503213AIV	198
501728PE	241	502105	242	502255MNP80	163	502445	63	503213ASIV	199
501729	241	502106	242	502256CN	161	502510	502	503213P80	194
501729NB	241	502120MP	100	502256CNP80	161	502841	25	503222	192
501729P	241	502120MPGAS	457	502256MN	163	502841	53	503222P80	192
501729PE	241	502120MPL	112	502256MNP80	163	503100	465	503223	192
501730RR	133	502120PMP	103	502257CN	161	503101	465	503223P80	192
501730RR	457	502120PMPL	115	502257CNP80	161	503102	465	503224	192
501730RTH	133	502121MP	100	502257MN	163	503103	465	503224P80	192
501730RTH	457	502122MP	100	502257MNP80	163	503104	465	503225	192
501730RU	133	502122MPGAS	457	502258CN	161	503105	465	503225P80	192
501730RU	457	502122MPL	112	502258CNP80	161	503106	465	503226	192
501741RBE	133	502122PMP	103	502258MN	163	503107	465	503226P80	192
501741RBE	457	502122PMPL	115	502258MNP80	163	503108	465	503227	192
501741RR	133	502123MP	100	502259CN	161	503109	465	503227P80	192
501741RR	457	502123PMP	103	502259CNP80	161	503110	465	503228	192

CODE	Page	CODE	Page	CODE	Page	CODE	Page	CODE	Page
503228P80	192	503287	189	503411	183	503525	191	506020	428
503229	192	503287P80	189	503412	183	503525P80	191	506029	347
503229P80	192	503288	189	503413	183	503526	191	506031	533
503230	192	503288P80	189	503414	183	503526P80	191	506032N	67
503230P80	192	503289	189	503415	183	503527	191	506032N	223
503231	192	503289P80	189	503442	184	503527P80	191	506040	66
503231P80	192	503290	189	503443	184	503528	191	506040	123
503232	192	503290P80	189	503444	184	503528P80	191	506040	212
503232P80	192	503291	189	503445	184	503529	191	506040	428
503233	192	503291P80	189	503446	184	503529P80	191	506057	123
503233P80	192	503292	189	503447	184	503530	191	506057	324
503242	196	503292P80	189	503448	184	503530P80	191	506057N	123
503242KC	197	503322	184	503449	184	503531	191	506057N	324
503242P80	196	503323	184	503450	184	503531P80	191	506058	64
503243	196	503324	184	503451	184	503532	191	506059	64
503243KC	197	503325	184	503452	184	503532P80	191	506060N	67
503243P80	196	503326	184	503453	184	503542	195	506060N	223
503244	196	503327	184	503454	184	503542P80	195	506061	66
503244KC	197	503328	184	503455	184	503543	195	506061	123
503244P80	196	503329	184	503455	184	503543P80	195	506061	212
503245	196	503330	184	503456	184	503544	195	506061	428
503245KC	197	503331	184	503462	185	503544P80	195	506062	348
503245P80	196	503332	184	503463	185	503545	195	506062	348
503246	196	503333	184	503463	185	503545P80	195	506063	345
503246KC	197	503334	184	503464	185	503546	195	506066	349
503246P80	196	503335	184	503466	185	503546P80	195	506068	337
503247	196	503336	184	503467	185	503547	195	506069	337
503247KC	197	503342	183	503468	185	503547P80	195	506070	346
503247P80	196	503343	183	503469	185	503548	195	506070	358
503248	196	503344	183	503470	185	503548P80	195	506073	346
503248KC	197	503345	183	503471	185	503549	195	506074	67
503248P80	196	503346	183	503472	185	503549P80	195	506074	223
503249	196	503347	183	503473	185	503550	195	506075	236
503249KC	197	503348	183	503474	185	503550P80	195	506076	67
503249P80	196	503349	183	503475	185	503551	195	506077DX	35
503250	196	503350	183	503482	186	503551P80	195	506077DXRC	35
503250KC	197	503351	183	503483	186	503552	195	506077DXT	35
503250P80	196	503352	183	503484	186	503552P80	195	506077DXTRC	35
503251	196	503353	183	503485	186	503552P80	195	506077SX	35
503251KC	197	503354	183	503486	186	503572	190	506077SXRC	35
503251P80	196	503355	183	503487	186	503572P80	190	506077SXT	35
503252	196	503356	183	503488	186	503573	190	506077SXTRC	35
503252KC	197	503362	187	503489	186	503573P80	190	506084	411
503252P80	196	503363	187	503489	186	503574	190	506084CR	411
503253	196	503364	187	503490	186	503574P80	190	506098	71
503253KC	197	503365	187	503491	186	503575	190	506102	120
503253P80	196	503366	187	503492	186	503575P80	190	506103	120
503262	193	503367	187	503493	186	503576	190	506106	121
503262P80	193	503368	187	503494	186	503576P80	190	506107	121
503263	193	503369	187	503495	186	503577	190	506109	120
503263P80	193	503370	187	503502	188	503577P80	190	506111	121
503264	193	503371	187	503502P80	188	503578	190	506112	120
503264P80	193	503372	187	503503	188	503578P80	190	506113	121
503265	193	503373	187	503503P80	188	503579	190	506138	215
503265P80	193	503374	187	503504	188	503579P80	190	506166	229
503266	193	503375	187	503504P80	188	503580	190	506168	218
503266P80	193	503375	185	503505	188	503580P80	190	506187	431
503267	193	503382	185	503505P80	188	503581	190	506187	431
503267P80	193	503383	185	503506	188	503581P80	190	506188	431
503268	193	503384	185	503506P80	188	503582	190	506188	431
503268P80	193	503385	185	503507	188	503582P80	190	506189	431
503269	193	503386	185	503507P80	188	503583	190	506189	431
503269P80	193	503387	185	503508	188	503583P80	190	506190	431
503270	193	503388	185	503508P80	188	503622	182	506195	209
503270P80	193	503389	185	503509	188	503623	182	506196	209
503271	193	503390	185	503509P80	188	503624	182	506200	66
503271P80	193	503391	185	503510	188	503625	182	506200	124
503272	193	503392	185	503510P80	188	503626	182	506200	212
503272P80	193	503393	185	503511	188	503627	182	506200	428
503282	189	503394	185	503511P80	188	503628	182	506201	67
503282P80	189	503395	185	503512	188	503629	182	506202	67
503283	189	503402	183	503512P80	188	503630	182	506203	67
503283P80	189	503403	183	503513	188	503631	182	506204	218
503284	189	503404	183	503513P80	188	503632	182	506206	216
503284P80	189	503405	183	503522	191	503633	182	506206	429
503285	189	503406	183	503522P80	191	506017	216	506206N	216
503285P80	189	503407	183	503523	191	506018	216	506206N	429
503286	189	503408	183	503523P80	191	506020	66	506208DX	43
503286P80	189	503409	183	503524	191	506020	124	506208DXRC	43
		503410	183	503524P80	191	506020	212	506208DXT	43

CODE	Page	CODE	Page	CODE	Page	CODE	Page	CODE	Page
506208DXTRC	43	506265	428	506314NBR	419	506458	125	506515	479
506208SX	43	506267	55	506314NR	420	506458N	125	506516	479
506208SXRC	43	506267	123	506316N	419	506459	125	506517	479
506208SXT	43	506267	428	506316NB	420	506459N	125	506518	479
506208SXTRC	43	506268	55	506316NBR	419	506460	125	506519	479
506209	124	506268	124	506316NR	420	506460N	125	506520	494
506209	214	506268	428	506317N	419	506461	125	506521	494
506209	324	506269	55	506317NB	420	506461N	125	506522	494
506209N	124	506269	124	506317NBR	419	506462	125	506523	494
506209N	214	506269	428	506317NR	420	506462N	125	506524	494
506209N	315	506270	219	506318N	419	506463	125	506525	494
506209N	324	506271	245	506318NB	420	506463N	125	506526	494
506210	228	506272	55	506318NBR	419	506464	125	506527	494
506211	228	506272	124	506318NR	420	506464N	125	506528	494
506212	228	506272	428	506324N	419	506469	125	506539	484
506215	55	506273	55	506324NB	420	506469N	125	506540	484
506215	428	506273	124	506324NBR	419	506470	125	506541	484
506219	502	506273	428	506324NR	420	506470N	125	506547	141
506220	228	506275	55	506325N	419	506471	125	506573	441
506221	228	506275	124	506325NB	420	506471N	125	506574	441
506222	228	506275	428	506325NBR	419	506472	125	506575	485
506223	228	506276	323	506325NR	420	506472N	125	506575S	484
506224	228	506280	309	506326N	419	506473	125	506575SI	484
506227	502	506280NB	309	506326NB	420	506473N	125	506576S	484
506227	504	506280P	309	506326NBR	419	506474	125	506576SI	484
506230	228	506280PE	309	506326NR	420	506474N	125	506577	441
506230L	228	506280PEI	309	506356	71	506483	125	506578	441
506231	228	506281	309	506360	317	506483N	125	506579	441
506231L	228	506281NB	309	506361	317	506484	125	506580	441
506231P80	228	506281P	309	506362	317	506484N	125	506585	439
506235	206	506281PE	309	506369	398	506485	125	506586	441
506236	221	506281PEI	309	506370	474	506485N	125	506587	484
506237	221	506281PI	309	506371	474	506486	125	506587CIB	485
506241	229	506282	308	506372	474	506486N	125	506592	410
506241	323	506283	308	506373	474	506487	125	506592CR	410
506241	481	506284	308	506374	474	506487N	125	506593	410
506241V	229	506285	308	506375	474	506488	125	506593CR	410
506241V	323	506285PEI	305	506376	475	506488N	125	506594	410
506241V	481	506285PI	307	506377	475	506489	123	506594CR	410
506242	229	506286PEI	305	506378	475	506489	324	506595	410
506242	323	506286PI	307	506379	475	506489N	123	506595CR	410
506242	481	506287PEI	305	506380	475	506489N	324	506596	488
506242V	229	506287PI	307	506381	475	506490	123	506602	257
506242V	323	506288PEI	304	506384	502	506490	324	506602CR	257
506242V	481	506288PI	306	506400B	222	506490N	123	506603	257
506243	229	506289PEI	304	506400R	222	506490N	324	506603CR	257
506243	323	506289PI	306	506401B	222	506491	125	506604	258
506243	481	506290PEI	304	506401R	222	506491N	125	506604CR	258
506243V	229	506290PI	306	506402B	222	506492	124	506606	258
506243V	323	506291PEI	304	506402R	222	506492	324	506606CR	258
506243V	481	506291PI	306	506403B	222	506492N	124	506607	259
506246	206	506295	66	506403R	222	506492N	324	506607CR	259
506251DX	69	506295	123	506404	221	506493	124	506610	119
506251SX	69	506295	212	506405	221	506493	324	506610N	119
506252DX	69	506295	428	506406	221	506493N	124	506611	119
506252SX	69	506299NB	222	506406	308	506493N	324	506611	324
506253	219	506299NR	222	506407	221	506494	125	506611N	119
506254	219	506304N	419	506407	323	506494N	125	506611N	324
506255	241	506304NB	420	506408	221	506495	125	506612	119
506256	247	506304NBR	419	506409	395	506495N	125	506612N	119
506257B	223	506304NR	420	506410	229	506496	125	506613	119
506257R	223	506305N	419	506444	219	506496N	125	506613N	119
506260	55	506305NB	420	506445	507	506499	125	506614	119
506260	126	506305NBR	419	506450	125	506499N	125	506614N	119
506260	429	506305NR	420	506450N	125	506500	478	506615	119
506261	55	506306N	419	506451	125	506501	478	506615N	119
506261	126	506306NB	420	506451N	125	506502	478	506616	119
506261	429	506306NBR	419	506452	125	506503	478	506616N	119
506262	55	506306NR	420	506452N	125	506504	478	506617	119
506262	126	506312N	419	506453	125	506505	479	506617N	119
506262	429	506312NB	420	506453N	125	506506	479	506619	118
506263	55	506312NBR	419	506454	125	506507	479	506619N	118
506263	126	506312NR	420	506454N	125	506508	479	506620	118
506263	429	506313N	419	506455	125	506509	479	506620N	118
506264	55	506313NB	420	506455N	125	506510	478	506621	118
506264	126	506313NBR	419	506456	125	506511	478	506621N	118
506264	429	506313NR	420	506456N	125	506512	478	506622	119
506265	55	506314N	419	506457	125	506513	478	506622N	119
506265	123	506314NB	420	506457N	125	506514	478	506623	119

CODE	Page	CODE	Page	CODE	Page	CODE	Page	CODE	Page
506623N	119	506699HLE1	390	507005N	146	507171AIV	166	508000NB	223
506624	119	506699HLR	390	507006N	146	507171ASIV	168	508000NR	223
506624N	119	506699HLR1	390	507007N	146	507171KC	164	508001NB	223
506626	439	506699HLRE	390	507008N	146	507172AIV	166	508001NR	223
506627	487	506699HLRE1	390	507009N	146	507172ASIV	168	508002NB	223
506627S	487	506699HR	394	507010N	146	507172KC	164	508002NR	223
506628	487	506699HR1	394	507011N	146	507173AIV	166	508005	221
506628S	487	506699L	392	507012N	146	507173ASIV	168	508005ST	221
506629	487	506699L1	392	507013N	146	507173KC	164	508006	221
506629S	487	506699LE	392	507020	436	507182AIV	167	508006ST	221
506632S	486	506699LE1	392	507020SOL	436	507182ASIV	169	508010	223
506632SI	486	506699LR	392	507025	436	507182KC	165	508012	386
506633S	486	506699LR1	392	507025SOL	436	507183AIV	167	508013	386
506633SI	486	506699LRE	392	507030	436	507183ASIV	169	508050	439
506638	484	506699LRE1	392	507030SOL	436	507183KC	165	508100	244
506638CIB	485	506700HT	531	507035	436	507184AIV	167	508134PEI	313
506639	493	506701	533	507035SOL	436	507184ASIV	169	508135PEI	313
506640	491	506703	399	507036	431	507184KC	165	508136PEI	313
506641	491	506704	502	507036i	431	507185AIV	167	508137PEI	312
506642	491	506706	491	507037	431	507185ASIV	169	508138PEI	312
506643	491	506707	491	507037i	431	507185KC	165	508139PEI	312
506644	491	506708	491	507038	431	507186AIV	167	508140PEI	312
506645	492	506709	491	507038i	431	507186ASIV	169	508141	314
506646	492	506710	491	507039	433	507186KC	165	508153	314
506647	492	506711	492	507040	433	507187AIV	167	508154	314
506648	492	506712	492	507041	433	507187ASIV	169	508155	314
506649	492	506713	492	507042	433	507187KC	165	508155i	314
506650	411	506714	492	507043	433	507188AIV	167	508155PE	314
506650CR	411	506715	492	507044	433	507188ASIV	169	508155PEI	314
506651	411	506717W	254	507045	433	507188KC	165	508156	314
506651CR	411	506717WP	254	507046	433	507189AIV	167	508156i	314
506652	411	506806N	418	507047	433	507189ASIV	169	508156PE	314
506652CR	411	506807N	418	507048	433	507189KC	165	508156PEI	314
506663	484	506808N	418	507053	439	507190AIV	167	508162AIV	166
506663CIB	485	506809N	418	507054	439	507190ASIV	169	508162ASIV	168
506664	413	506810N	418	507055	439	507190KC	165	508162KC	164
506665B	489	506811N	418	507056	439	507191AIV	167	508163AIV	166
506666	489	506812N	418	507057	439	507191ASIV	169	508163ASIV	168
506669	486	506813N	418	507058	439	507191KC	165	508163KC	164
506670	486	506814N	418	507059	439	507192AIV	167	508164AIV	166
506671	486	506827N	418	507063	439	507192ASIV	169	508164ASIV	168
506684	412	506828N	418	507064	439	507192KC	165	508164KC	164
506697H	394	506829N	418	507065	439	507193AIV	167	508165AIV	166
506697H1	394	506832N	418	507069	441	507193ASIV	169	508165ASIV	168
506697HL	391	506833N	418	507070	437	507193KC	165	508165KC	164
506697HL1	391	506834N	418	507071	441	507300N	416	508166AIV	166
506697HLE	391	506835N	425	507075	437	507300NB	417	508166ASIV	168
506697HLE1	391	506835NT	425	507080	437	507300NR	417	508166KC	164
506697HLR	391	506836N	425	507085	437	507300NW	417	508167AIV	166
506697HLR1	391	506836NT	425	507090	439	507301N	416	508167ASIV	168
506697HLRE	391	506837N	425	507093	439	507301NB	417	508167KC	164
506697HLRE1	391	506837NT	425	507139	427	507301NR	417	508168AIV	166
506697HR	394	506838N	425	507162AIV	166	507301NW	417	508168ASIV	168
506697HR1	394	506838NT	425	507162ASIV	168	507302N	416	508168KC	164
506697L	393	506839N	425	507162KC	164	507302NB	417	508169AIV	166
506697L1	393	506839NT	425	507163AIV	166	507302NR	417	508169ASIV	168
506697LE	393	506840N	425	507163ASIV	168	507302NW	417	508169KC	164
506697LE1	393	506840NT	425	507163KC	164	507320N	416	508170AIV	166
506697LR	393	506847N	425	507164AIV	166	507320NB	417	508170ASIV	168
506697LR1	393	506848N	425	507164ASIV	168	507320NR	417	508170KC	164
506697LRE	393	506849N	425	507164KC	164	507320NW	417	508171AIV	166
506697LRE1	393	506850N	425	507165AIV	166	507321N	416	508171ASIV	168
506698H	394	506851N	425	507165ASIV	168	507321NB	417	508171KC	164
506698H1	394	506852N	425	507165KC	164	507321NR	417	508172AIV	166
506698HL	391	506859	486	507166AIV	166	507321NW	417	508172ASIV	168
506698HL1	391	506860	486	507166ASIV	168	507322N	416	508172KC	164
506698HLR	391	506861	486	507166KC	164	507322NB	417	508182AIV	167
506698HLR1	391	506862	140	507167AIV	166	507322NR	417	508182ASIV	169
506698HR	394	506863	140	507167ASIV	168	507322NW	417	508182KC	165
506698HR1	394	506864	140	507167KC	164	507351B	427	508183AIV	167
506698L	393	506865C	140	507168AIV	166	507351R	427	508183ASIV	169
506698L1	393	506866C	140	507168ASIV	168	507351W	427	508183KC	165
506698LR	393	506867C	140	507168KC	164	507800N	416	508184AIV	167
506698LR1	393	506875	140	507169AIV	166	507801N	416	508184ASIV	169
506699H	394	506876	140	507169ASIV	168	507802N	416	508184KC	165
506699H1	394	506877	140	507169KC	164	507815N	416	508185AIV	167
506699HL	390	507002N	146	507170AIV	166	507816N	416	508185ASIV	169
506699HL1	390	507003N	146	507170ASIV	168	507817N	416	508185KC	165
506699HLE	390	507004N	146	507170KC	164	507830N	416	508186AIV	167

CODE	Page	CODE	Page	CODE	Page	CODE	Page	CODE	Page
508186ASIV	169	509064	444	510002MPGAS	454	510028	90	510084MPGAS	454
508186KC	165	509065	449	510002MPL	108	510029	90	510084MPL	108
508187AIV	167	509066	449	510003MP	93	510030	90	510085MP	95
508187ASIV	169	509067	368	510003MPGAS	454	510031	90	510085MPGAS	456
508187KC	165	509068	368	510003MPL	108	510032	93	510085MPL	109
508188AIV	167	509069	368	510004MP	93	510033	93	510087MP	95
508188ASIV	169	509070	368	510004MPGAS	454	510034	93	510087MPGAS	456
508188KC	165	509071	368	510004MPL	108	510035	91	510087MPL	109
508189AIV	167	509072	368	510005MP	90	510036	91	510088MP	95
508189ASIV	169	509078	369	510005MPGAS	455	510037	116	510088MPGAS	456
508189KC	165	509079	369	510005MPL	106	510038MP	90	510088MPL	109
508190AIV	167	509080	369	510005PMP	102	510039MP	90	510089MP	95
508190ASIV	169	509081	369	510005PMPL	114	510040MP	90	510089MPGAS	456
508190KC	165	509082	369	510006MP	90	510041MP	90	510089MPL	109
508191AIV	167	509083	369	510006MPGAS	455	510042MP	93	510090MP	100
508191ASIV	169	509084	369	510006MPL	106	510043MP	93	510090MPL	112
508191KC	165	509085	369	510006PMP	102	510044MP	93	510091MP	100
508192AIV	167	509086	369	510006PMPL	114	510044MPGAS	454	510091MPL	112
508192ASIV	169	509087	369	510007MP	90	510044MPL	108	510098	95
508192KC	165	509088B	369	510007MPGAS	455	510045MP	94	510099MP	90
509000	338	509088B	376	510007MPL	106	510046MP	94	510099MPL	106
509001	448	509088B	489	510007PMP	102	510047MP	94	510100MP	90
509002	448	509088R	369	510007PMPL	114	510047MPGAS	456	510100MPL	106
509003	448	509088R	376	510008MP	90	510047MPL	108	510101	90
509004	448	509088R	489	510008MPGAS	454	510048MP	90	510102	90
509005	448	509089	368	510008MPL	106	510048MPL	109	510103	90
509006	448	509126	447	510008PMP	102	510050MP	90	510105MP	93
509007	448	509127	447	510008PMPL	114	510050MPL	109	510105MPGAS	454
509008	448	509128	447	510009MP	90	510052	93	510105MPL	108
509009	448	509129	447	510009MPGAS	454	510053	90	510106MP	93
509010	448	509130	447	510009MPL	106	510054	90	510106MPL	108
509011	448	509131	475	510009PMP	102	510055	90	510108	90
509012	448	509133	368	510009PMPL	114	510056	91	510109MP	94
509013	448	509134	380	510010MP	90	510057	93	510109MPGAS	456
509014	448	509135	368	510010MPGAS	454	510058	91	510109MPL	108
509015	448	509136	368	510010MPL	106	510059	92	510110MP	95
509016	448	509137	368	510010PMP	102	510060	95	510110MPL	109
509017	448	509138	368	510010PMPL	114	510061	95	510112	134
509018	448	509139	368	510011MP	94	510062MP	96	510114	134
509020	449	509140	368	510011MPGAS	456	510062MPL	110	510115	95
509021	449	509141	247	510011MPL	108	510064MP	96	510116	91
509022	449	509141R	247	510012MP	94	510064MPL	110	510117	92
509023	449	509141R	309	510012MPGAS	456	510065MP	100	510118	91
509024	449	509142	380	510012MPL	108	510065MPL	112	510119	92
509025	449	509145	377	510013MP	94	510066MP	100	510120	91
509029	443	509146	377	510013MPGAS	456	510066MPL	112	510121	91
509030	444	509147	377	510013MPL	108	510067MP	100	510122	91
509031	444	509151	447	510013PMPL	108	510067MPL	112	510123	92
509032	444	509152	447	510014MP	94	510068MP	100	510124	92
509033	444	509153	447	510014MPGAS	456	510068MPL	112	510125	91
509034	444	509154	447	510014MPL	108	510071MP	98	510126	92
509035	444	509155	447	510017MP	95	510071MPGAS	457	510127	91
509036	445	509160	337	510017MPL	109	510071MPL	111	510128	90
509037	445	509160	442	510018MP	95	510073MP	98	510129	90
509038	445	509161	476	510018MPL	109	510073MPGAS	457	510130MP	93
509039	445	509162	476	510019MP	90	510073MPL	111	510131MP	93
509040	445	509163	476	510019MPGAS	454	510074MP	98	510132MP	94
509041	445	509164	476	510019MPL	106	510074MPGAS	457	510133MP	94
509042	445	509165	476	510019PMP	102	510074MPL	111	510134MP	90
509043	445	509166	476	510019PMPL	114	510075MP	98	510134PMP	102
509045	443	509167	480	510020MP	90	510075MPGAS	457	510135MP	90
509046	443	509168	480	510020MPGAS	455	510075MPL	111	510135PMP	102
509047	443	509169	493	510020MPL	106	510076MP	95	510137MP	90
509048	443	509170	368	510020PMP	102	510076MPGAS	456	510137PMP	102
509049	443	509171	368	510020PMPL	114	510076MPL	109	510138MP	90
509050	443	509172	368	510021MP	93	510077MP	95	510138PMP	102
509051	443	509173	368	510021MPGAS	454	510078MP	95	510139	90
509052	443	509174	368	510021MPL	108	510078MPGAS	456	510140MP	91
509053	443	509175	368	510022MP	94	510078MPL	109	510140PMP	102
509054	443	509176	368	510022MPGAS	456	510079MP	95	510141MP	93
509055	444	509177	368	510022MPL	108	510079MPGAS	456	510142MP	94
509056	444	509178	368	510023MP	90	510079MPL	109	510143MP	91
509057	444	509200	237	510023MPGAS	454	510079PMPL	109	510143PMP	102
509058	444	510000	116	510023MPL	106	510080MP	95	510144MP	92
509059	444	510000	121	510023PMP	102	510080MPGAS	456	510144PMP	103
509060	444	510001	93	510023PMPL	114	510080MPL	109	510146MP	92
509061	444	510001MP	93	510024MP	90	510081	95	510146PMP	103
509062	444	510001MPGAS	454	510024MPGAS	454	510082	95	510147MP	91
509063	444	510001MPL	108	510024MPL	106	510083	95	510147PMP	102
		510002MP	93	510027	93	510084MP	93		

CODE	Page	CODE	Page	CODE	Page	CODE	Page	CODE	Page
510148MP	92	510217	54	511017MP	100	511106MP	96	512011MPGAS	455
510148PMP	103	510217RC	54	511017MPL	112	511106MPL	110	512011MPL	107
510150MP	92	510218	54	511018MP	91	511108MP	96	512011PMP	103
510150PMP	103	510218RC	54	511019MP	94	511108MPL	110	512011PMPL	115
510151MP	92	510219	54	511021MP	93	511109MP	97	512012MP	91
510151PMP	103	510219RC	54	511025MP	100	511109MPL	110	512012MPGAS	455
510152	92	510220	53	511025MPL	112	511111MP	97	512012MPL	107
510154MP	91	510220RC	53	511026MP	100	511111MPL	110	512012PMP	102
510154PMP	102	510221	54	511026MPL	112	511113MP	93	512012PMPL	114
510155MP	91	510221RC	54	511027MP	100	511113MPGAS	454	512013MP	91
510155PMP	102	510222	54	511027MPL	112	511113MPL	108	512013MPGAS	455
510156	91	510222RC	54	511029MP	94	511114MP	94	512013MPL	106
510157MP	92	510223	53	511029MPGAS	456	511114MPGAS	456	512013PMP	102
510157PMP	103	510223RC	53	511029MPL	108	511114MPL	108	512013PMPL	114
510158MP	92	510224	54	511030MP	90	511115MP	93	512014MP	91
510158PMP	103	510224RC	54	511031MP	90	511115MPL	109	512014MPGAS	455
510159MP	92	510225	54	511032MP	90	511116MP	93	512014MPL	106
510159PMP	103	510225RC	54	511034MP	90	511117MP	93	512014PMP	102
510160MP	92	510226	53	511035MP	90	511118MP	93	512014PMPL	114
510161MP	93	510226RC	53	511036MP	90	511118MPL	109	512015MP	92
510162MP	95	510227	54	511037MP	90	511119MP	93	512015MPGAS	455
510163MP	95	510227RC	54	511038MP	90	511120MP	93	512015MPL	107
510164MP	95	510228	54	511039MP	90	511121MP	93	512015PMP	103
510167MP	97	510228RC	54	511040MP	94	511122MP	93	512015PMPL	115
510168MP	100	510229MP	93	511041MP	94	511122MPL	109	512016MP	92
510169MP	90	511001MP	93	511042MP	94	511123MP	93	512016MPGAS	455
510170MP	98	511001MPGAS	454	511044MP	94	511124	95	512016MPL	107
510171MP	95	511001MPL	108	511045MP	93	511125	95	512016PMP	103
510172MP	95	511002MP	93	511046MP	93	512001MP	91	512016PMPL	115
510173	90	511002MPGAS	454	511047MP	93	512001MPGAS	455	512017MP	91
510174MP	92	511002MPL	108	511048MP	93	512001MPL	106	512017MPGAS	455
510174PMP	103	511003MP	93	511049MP	93	512001PMP	102	512017MPL	107
510175	92	511003MPGAS	454	511050MP	90	512001PMPL	114	512017PMP	102
510176	92	511003MPL	108	511051MP	90	512002MP	91	512017PMPL	114
510177	92	511004MP	93	511053MP	91	512002MPGAS	455	512018MP	92
510179MP	91	511004MPGAS	454	511054MP	91	512002MPL	106	512018MPGAS	455
510179PMP	102	511004MPL	108	511055MP	91	512002PMP	102	512018MPL	107
510180	219	511005MP	94	511056MP	94	512002PMPL	114	512018PMP	103
510181MP	90	511005MPGAS	456	511057MP	94	512003MP	91	512018PMPL	115
510182MP	92	511005MPL	108	511058MP	94	512003MPGAS	455	512019MP	91
510183	94	511006MP	94	511059MP	94	512003MPL	106	512019MPGAS	455
510184	94	511006MPGAS	456	511060MP	94	512003PMP	102	512019MPL	106
510185	94	511006MPL	108	511061MP	94	512003PMPL	114	512019PMP	102
510186	94	511007MP	94	511062MP	93	512004MP	92	512019PMPL	114
510187	94	511007MPGAS	456	511063MP	93	512004MPGAS	455	512020MP	91
510188	94	511007MPL	108	511064MP	93	512004MPL	107	512020MPGAS	455
510189CMP	100	511008MP	94	511065MP	93	512004PMP	103	512020MPL	106
510189CMPL	107	511008MPGAS	456	511066MP	93	512004PMPL	115	512020PMP	102
510189MMP	100	511008MPL	108	511067MP	91	512005MP	92	512020PMPL	114
510189MMPL	107	511009MP	91	511068MP	91	512005MPGAS	455	512021MP	91
510190CMP	100	511009MPGAS	455	511070MP	91	512005MPL	107	512021MPGAS	455
510190MMP	100	511009MPL	106	511071MP	92	512005PMP	103	512021MPL	107
510191CMP	100	511009PMP	102	511072MP	92	512005PMPL	115	512021PMP	102
510191CMPL	107	511009PMPL	114	511074MP	92	512006MP	92	512021PMPL	114
510191MMP	100	511010MP	91	511075MP	92	512006MPGAS	455	512022MP	95
510191MMPL	107	511010MPGAS	455	511076MP	92	512006MPL	107	512022MPGAS	456
510192CMP	100	511010MPL	106	511077MP	92	512006PMP	103	512022MPL	109
510192MMP	100	511010PMP	102	511078MP	92	512006PMPL	115	512023MP	95
510193CMP	100	511010PMPL	114	511081MP	92	512007MP	92	512023MPGAS	456
510193MMP	100	511011MP	91	511082MP	92	512007MPGAS	455	512023MPL	109
510194CMP	100	511011MPGAS	455	511083MP	95	512007MPL	107	512024MP	92
510194MMP	100	511011MPL	106	511084MP	95	512007PMP	103	512024MPGAS	455
510195MP	95	511011PMP	102	511085MP	95	512007PMPL	115	512024MPL	107
510197	65	511011PMPL	114	511089MP	95	512008MP	92	512024PMP	103
510198	65	511012MP	91	511091MP	93	512008MPGAS	455	512024PMPL	115
510200MP	90	511012MPGAS	455	511092MP	93	512008MPL	107	512027MP	95
510201	280	511012MPL	106	511093	90	512008PMP	103	512027MPGAS	456
510211	53	511012PMP	102	511096MP	97	512008PMPL	115	512027MPL	109
510211RC	53	511012PMPL	114	511097MP	97	512009MP	91	512028MP	95
510212	53	511013MP	93	511098MP	97	512009MPGAS	455	512028MPGAS	456
510212RC	53	511013MPGAS	454	511099MP	97	512009MPL	107	512028MPL	109
510213	53	511013MPL	108	511100MP	97	512009PMP	102	512029MP	93
510213RC	53	511014MP	94	511101MP	93	512009PMPL	114	512029MPGAS	454
510214	54	511014MPGAS	456	511102MP	94	512010MP	92	512029MPL	108
510214RC	54	511014MPL	108	511103MP	94	512010MPGAS	455	512030MP	93
510215	54	511015MP	100	511103MPGAS	456	512010MPL	107	512030MPGAS	454
510215RC	54	511015MPL	112	511103MPL	108	512010PMP	103	512030MPL	108
510216	54	511016MP	100	511104MP	94	512010PMPL	115	512031MP	93
510216RC	54	511016MPL	112	511105MP	94	512011MP	92	512031MPGAS	454

CODE	Page	CODE	Page	CODE	Page	CODE	Page	CODE	Page
512031MPL	108	512082MP	98	513025MP	97	514371	187	520174VL	57
512032MP	93	512082MPL	111	513025MPL	111	514372	187	520174VLRC	57
512032MPGAS	454	512083MP	98	513026CMP	97	514373	187	520175SB	56
512032MPL	108	512083MPL	111	513026MP	97	514374	187	520175SBRC	56
512033MP	94	512084MP	98	513027CMP	97	514375	187	520175SL	56
512033MPL	109	512084MPL	111	513027CMPL	111	520001	129	520175SLRC	56
512034MP	94	512085MP	98	513027LMP	97	520003	129	520175VB	57
512034MPL	109	512085MPL	111	513027LMPL	111	520022	255	520175VBRC	57
512035	91	512086MP	98	513027MP	97	520041	66	520175VL	57
512036	91	512086MPL	111	513027MPL	111	520041	124	520175VLRC	57
512037	92	512087	95	513028CMP	97	520041	212	520176SB	56
512038	92	512088	95	513028MP	97	520041	428	520176SBRC	56
512039	92	512089	92	513029CMP	97	520046	395	520176SL	56
512040	95	512090	92	513029CMPL	111	520047	395	520176SLRC	56
512041	95	512091	92	513029LMP	97	520049	292	520176VB	57
512042MP	95	512092	92	513029LMPL	111	520049W	292	520176VBRC	57
512042MPGAS	456	512093	92	513029MP	97	520050HT	292	520176VL	57
512042MPL	109	512094	92	513029MPL	111	520050LT	292	520176VLRC	57
512043MP	95	512095	92	513030MP	98	520050WHT	292	520177SB	56
512043MPGAS	456	512096MP	98	513030MPL	111	520050WLT	292	520177SBRC	56
512043MPL	109	512096MPL	111	513032MP	98	520060	128	520177SL	56
512044MP	95	512097MP	98	513032MPL	111	520070	50	520177SLRC	56
512044MPGAS	456	512097MPL	111	513033MP	98	520070RC	50	520177VB	57
512044MPL	109	512101MP	91	513034MP	98	520071	50	520177VBRC	57
512045MP	95	512103MP	90	513035MP	98	520071RC	50	520177VL	57
512046MP	95	512104MPGAS	456	513035MPL	110	520072	50	520177VLRC	57
512046MPGAS	456	512109MP	94	513036MP	97	520072RC	50	520178SB	56
512046MPL	109	512110MP	94	513036MPL	110	520073	50	520178SBRC	56
512047MP	95	512111MP	94	513038MP	97	520073RC	50	520178SL	56
512047MPGAS	456	512112MP	94	513038MPL	110	520074	50	520178SLRC	56
512047MPL	109	512113MP	94	513039MP	97	520074RC	50	520178VB	57
512048MP	92	513001CMP	97	513039MPL	110	520075	50	520178VBRC	57
512048MPGAS	455	513001CMPGAS	456	513041MP	97	520075RC	50	520178VL	57
512048MPL	107	513001CMPL	111	513041MPL	110	520077	50	520178VLRC	57
512048PMP	103	513001LMP	97	513042MP	99	520077R	50	520179SB	56
512048PMPL	115	513001LMPL	111	513044MP	99	520077RC	50	520179SBRC	56
512049	95	513001MP	97	514202	194	520077RCR	50	520179SL	56
512050MP	92	513001MPGAS	456	514203	194	520079	50	520179SLRC	56
512050MPGAS	455	513001MPHD	97	514204	194	520079R	50	520179VB	57
512050MPL	107	513001MPL	111	514205	194	520079RC	50	520179VBRC	57
512050PMP	103	513002CMP	97	514206	194	520079RCR	50	520179VL	57
512050PMPL	115	513002CMPGAS	456	514207	194	520080	51	520179VLRC	57
512051MP	91	513002CMPL	111	514208	194	520080RC	51	520180SB	56
512051MPGAS	455	513002LMP	97	514209	194	520081	51	520180SBRC	56
512051MPL	106	513002LMPL	111	514210	194	520081RC	51	520180SL	56
512051PMP	102	513002MP	97	514211	194	520084	51	520180SLRC	56
512051PMPL	114	513002MPGAS	456	514212	194	520084R	51	520180VB	57
512052MP	92	513002MPL	111	514213	194	520084RC	51	520180VBRC	57
512052MPGAS	455	513003MP	97	514222	195	520084RCR	51	520180VL	57
512052MPL	107	513003MPGAS	456	514223	195	520085	51	520180VLRC	57
512052PMP	103	513003MPL	111	514224	195	520085R	51	520181SB	56
512052PMPL	115	513004MP	97	514225	195	520085RC	51	520181SBRC	56
512053MP	92	513004MPGAS	456	514226	195	520085RCR	51	520181SL	56
512053MPGAS	455	513004MPL	111	514227	195	520086	50	520181SLRC	56
512053MPL	107	513005MP	98	514228	195	520110	51	520181VB	57
512053PMP	103	513007MP	98	514229	195	520110RC	51	520181VBRC	57
512053PMPL	115	513008MP	98	514230	195	520111	51	520181VL	57
512054MP	91	513008MPL	110	514231	195	520111RC	51	520181VLRC	57
512055MP	92	513009MP	98	514232	195	520119	397	520188SB	56
512056MP	91	513009MPL	110	514242KC	197	520124	295	520188SBRC	56
512058MP	91	513010MP	98	514243KC	197	520126	292	520188SL	56
512059MP	92	513011MP	98	514244KC	197	520132	221	520188SLRC	56
512060MP	92	513012MP	98	514245KC	197	520133	221	520188VB	57
512062MP	91	513012MPL	110	514246KC	197	520135	295	520188VBRC	57
512063MP	92	513013MP	98	514247KC	197	520136	295	520188VL	57
512064MP	91	513013MPL	110	514248KC	197	520139	295	520188VLRC	57
512065MP	95	513014CMP	97	514249KC	197	520149	76	520189SB	56
512066MP	93	513014MP	97	514250KC	197	520151	298	520189SBRC	56
512067MP	93	513020MP	95	514251KC	197	520152	298	520189SL	56
512067MPGAS	454	513024CMP	97	514252KC	197	520153	295	520189SLRC	56
512067MPL	108	513024CMPL	111	514362	187	520154	295	520189VB	57
512068MP	92	513024LMP	97	514363	187	520172	62	520189VBRC	57
512068MPGAS	455	513024LMPL	111	514364	187	520173	62	520189VL	57
512068MPL	107	513024MP	97	514365	187	520174SB	56	520189VLRC	57
512077MP	100	513024MPL	111	514366	187	520174SBRC	56	520194	295
512079MP	100	513025CMP	97	514367	187	520174SL	56	520195	295
512079MPL	112	513025CMPL	111	514368	187	520174SLRC	56	520196	295
512080MP	98	513025LMP	97	514369	187	520174VB	57	520197	295
512080MPL	111	513025LMPL	111	514370	187	520174VBRC	57	520200	301

CODE	Page	CODE	Page	CODE	Page	CODE	Page	CODE	Page
520201	301	530031	20	550028	216	550145	380	551014	514
520203	301	530031INOX	20	550038	129	550146	380	551015	514
520210	297	530031WHITE	20	550042	124	550147	387	551016	514
520211	297	530032	20	550042	214	550148	387	551017	514
520212	297	530032INOX	20	550042	324	550149	379	551018	514
520213	297	530032WHITE	20	550042N	124	550150	379	551019	514
520218	297	530033	13	550042N	214	550151	379	551020	515
530004	19	530033INOX	13	550042N	315	550196	116	551021	515
530004B	19	530033M	12	550042N	324	550197	116	551022	515
530004INOX	19	530033MINOX	12	550044N	218	550198	116	551023	515
530004INOXB	19	530033MWHITE	12	550044NPL	218	550199	116	551024	512
530004WHITE	19	530033WHITE	13	550084	216	550199	411	551025	516
530004WHITEB	19	530033M	15	550085	216	550530	323	551026	516
530005	18	530038INOX	15	550086	216	550551	216	551027	516
530005B	18	530038WHITE	15	550087	216	550551	292	551028	516
530005INOX	18	530039	15	550089	429	550551	324	551029	516
530005INOXB	18	530039INOX	15	550090	216	550551N	216	551030	516
530005WHITE	18	530039WHITE	15	550090	429	550551N	292	551031	516
530005WHITEB	18	530040	14	550091	216	550551N	324	551032	517
530006	19	530040INOX	14	550092	216	550552	216	551033	517
530006B	19	530040WHITE	14	550093	216	550552	324	551034	517
530006INOX	19	530041	14	550094	216	550552N	216	551035	517
530006INOXB	19	530041INOX	14	550095	216	550552N	324	551036	517
530006WHITE	19	530041WHITE	14	550096	215	550580	322	551043	512
530006WHITEB	19	530042	15	550097	215	550600	322	551044	512
530007	18	530042INOX	15	550098	215	550601	322	551045	512
530007B	18	530042WHITE	15	550099	215	550602	322	551081	512
530007INOX	18	530043	15	550100	378	550603	322	551082	516
530007INOXB	18	530043INOX	15	550100SI	378	550610	321	551083	512
530007WHITE	18	530043WHITE	15	550101	378	550610P	321	553003	68
530007WHITEB	18	530044	14	550101SI	378	550610PE	321	553004	218
530008	14	530044INOX	14	550103	379	550611	321	560001	69
530008INOX	14	530044WHITE	14	550103SI	379	550611P	321	560001	348
530008WHITE	14	530045	14	550104	379	550620	320	560002	172
530009	14	530045INOX	14	550104SI	379	550620LT	320	560002S	172
530009INOX	14	530045WHITE	14	550105	379	550620NB	320	560003	172
530009WHITE	14	530046	21	550105SI	379	550620NBTL	320	560003S	172
530010	17	530046INOX	21	550106	379	550620P	320	560004	172
530010INOX	17	530047	21	550106SI	379	550620PE	320	560004S	172
530010WHITE	17	530047INOX	21	550109	379	550620PELT	320	560005	172
530011	16	530048	21	550109SI	379	550620PLT	320	560005S	172
530011INOX	16	530048INOX	21	550110	379	550621	320	560006	172
530011WHITE	16	530049	21	550110SI	379	550621LT	320	560006S	172
530012	16	530049INOX	21	550111	379	550621NB	320	560007	172
530012INOX	16	530052	21	550111SI	379	550621NBTL	320	560007S	172
530012WHITE	16	530052INOX	21	550112	379	550621P	320	560008	172
530013	17	530053	21	550112SI	379	550621PE	320	560008S	172
530013INOX	17	530053INOX	21	550113	378	550621PELT	320	560009	172
530013WHITE	17	530055	20	550113SI	378	550621PLT	320	560009S	172
530014	21	530055WHITE	20	550114	378	550622	320	560010	172
530014INOX	21	530056	20	550114SI	378	550622LT	320	560010S	172
530015	21	530056WHITE	20	550115	378	550622NB	320	560011	172
530015INOX	21	530057	20	550115SI	378	550622NBTL	320	560011S	172
530016	21	530057WHITE	20	550116	378	550622P	320	560012	172
530016INOX	21	530058	20	550116SI	378	550622PE	320	560012S	172
530021	12	530058WHITE	20	550117	378	550622PELT	320	560013	172
530021INOX	12	530059	20	550117SI	378	550622PLT	320	560022	171
530021WHITE	12	530059WHITE	20	550118	378	550626	320	560022S	171
530024	15	530060	20	550118SI	378	550626LT	320	560023	171
530024INOX	15	530060WHITE	20	550119	379	550626NB	320	560023S	171
530024WHITE	15	530061	20	550126	377	550626NBTL	320	560024	171
530025	15	530061WHITE	20	550127	377	550626P	320	560024S	171
530025INOX	15	530062	20	550128	377	550626PE	320	560025	171
530025WHITE	15	530062WHITE	20	550129	377	550626PELT	320	560025S	171
530026	17	530063	21	550130	377	550626PLT	320	560026	171
530026INOX	17	530063INOX	21	550131	380	550630	322	560026S	171
530026WHITE	17	530066	21	550132	380	550630HT	531	560027	171
530027	16	530066INOX	21	550133	380	550700	227	560027S	171
530027INOX	16	540020	205	550134	380	550710	227	560028	171
530027WHITE	16	540021	205	550135	380	550711	227	560028S	171
530028	16	540022	205	550136	380	550715	227	560029	171
530028INOX	16	540023	205	550137	380	550715P80	227	560029S	171
530028WHITE	16	550009	216	550138	380	551004	512	560030	171
530029	17	550015	61	550139	380	551008	513	560030S	171
530029INOX	17	550015	67	550140	380	551009	513	560031	171
530029WHITE	17	550016	216	550141	380	551010	513	560031S	171
530030	20	550016	429	550142	380	551011	513	560032	171
530030INOX	20	550016N	216	550143	380	551012	513	560032S	171
530030WHITE	20	550016N	429	550144	380	551013	513	560033	171

CODE	Page	CODE	Page	CODE	Page	CODE	Page	CODE	Page
560033S	171	570026N	124	590040	464	590127	373	590255	375
560042C	173	570026N	213	590041	464	590130	519	590256	375
560042M	174	570027N	124	590042	464	590133	519	590257	375
560042SC	173	570027N	213	590043	464	590133	522	590258	375
560042SM	174	570028N	124	590044	467	590134	519	590259	375
560043C	173	570028N	213	590045	466	590134	522	590260	375
560043M	174	570029N	124	590046	458	590135	519	590261	375
560043SC	173	570029N	213	590047	459	590135	522	590262	375
560043SM	174	570030N	124	590048	459	590138	522	590263	375
560044C	173	570030N	213	590049	461	590140	522	590264	375
560044M	174	570031N	124	590050	461	590141	372	590265	375
560044SC	173	570031N	213	590051	461	590142	374	590266	375
560044SM	174	570032N	124	590052	461	590143	374	590267	375
560045C	173	570032N	213	590053	459	590144	372	590268	375
560045M	174	570033N	124	590054	459	590145	372	590269	375
560045SC	173	570033N	213	590055	461	590146	374	590270	375
560045SM	174	570051N	126	590056	461	590147	374	590271	375
560046C	173	570053N	126	590057	460	590148	372	590272	375
560046M	174	570054N	126	590058	460	590149	372	590273	375
560046SC	173	570055N	126	590059	460	590150	374	590274	375
560046SM	174	570056N	126	590060	460	590151	374	590275	375
560047C	173	570057N	126	590061	464	590153	519	590276	375
560047M	174	570200	71	590062	464	590153	522	590277	375
560047SC	173	570201	71	590063	467	590154	522	590278	375
560047SM	174	570202	71	590064	467	590200	375	590279	375
560048C	173	570203	71	590065	372	590201	375	590280	375
560048M	174	570204	71	590066	372	590202	375	590281	375
560048SC	173	570205	71	590067	372	590203	375	590282	375
560048SM	174	570206	71	590068	372	590204	375	590283	375
560049C	173	570207	71	590069	372	590205	375	590284	375
560049M	174	570208	71	590069	489	590206	375	590285	375
560049SC	173	570209	71	590070	372	590207	375	590286	375
560049SM	174	570210	71	590071	372	590208	375	590287	375
560050C	173	570211	71	590072	372	590209	375	590288	375
560050M	174	570212	71	590073	372	590210	375	590289	375
560050SC	173	570213	71	590074	372	590211	375	590290	375
560050SM	174	570214	71	590075	372	590212	375	590291	375
560051C	173	570216	71	590076	372	590213	375	590292	375
560051M	174	570220	71	590077	466	590214	375	590293	375
560051SC	173	570221	71	590082	216	590215	375	590294	375
560051SM	174	570224	206	590083	467	590216	375	590295	375
560052C	173	570225	206	590084	467	590217	375	590296	375
560052M	174	570225P	206	590085	467	590218	375	590297	375
560052SC	173	570226	211	590086	467	590219	375	590298	375
560052SM	174	570226P	211	590087	467	590220	375	590299	375
560053C	173	570226P80	211	590088	467	590221	375	590300	375
560053M	174	570226PP80	211	590089	467	590222	375	590301	375
570000N	123	570227	211	590090	467	590223	375	590302	375
570000N	213	570227P	211	590091	467	590224	375	590303	375
570001N	123	570227P80	211	590092	467	590225	375	591142	25
570001N	213	570227PP80	211	590093	467	590226	375	991310	124
570002N	123	580000	364	590099	372	590227	375	991310	324
570002N	213	580000U	252	590100	373	590228	375	991310N	124
570003N	123	580001	364	590101	373	590229	375	991310N	324
570003N	213	580001U	252	590102	373	590230	375	4000200	326
570004N	123	580002	364	590103	373	590231	375	4000201	326
570004N	213	580003	364	590104	373	590232	375	4000202	326
570005N	123	580007	364	590105	373	590233	375	4000205	326
570005N	213	580008	364	590106	373	590234	375	4000607	326
570006N	123	580009	364	590107	373	590235	375	4000608	326
570006N	213	580010	358	590108	373	590236	375	4000609	326
570007N	123	580011	359	590109	373	590237	375	4000610	326
570007N	213	580012	359	590110	373	590238	375	4000611	326
570008N	123	580014	364	590111	373	590239	375	4000612	326
570008N	213	580014U	252	590112	373	590240	375	5003891N	339
570009N	123	580015	359	590113	373	590241	375	5016135	63
570009N	213	580016	359	590114	373	590242	375	5016145	63
570020N	124	580017	359	590115	373	590243	375	5016165	63
570020N	213	580018	359	590116	373	590244	375	5090303	444
570021N	124	580020	364	590117	373	590245	375	5090313	444
570021N	213	580021	358	590118	373	590246	375	5090323	444
570022N	124	580022	358	590119	373	590247	375	5090333	444
570022N	213	580023	358	590120	373	590248	375	5090343	444
570023N	124	580024	358	590121	373	590249	375	5090353	444
570023N	213	580025	358	590122	373	590250	375	5201941	225
570024N	124	590036	467	590123	373	590251	375	5201951	225
570024N	213	590037	464	590124	373	590252	375	5201961	225
570025N	124	590038	464	590125	373	590253	375	5201971	225
570025N	213	590039	464	590126	374	590254	375	5702303	337

CODE	Page	CODE	Page	CODE	Page	CODE	Page	CODE	Page
5702307	442	ACUL40	510	CACSW080I	510	GP7000W	529	I-PERT5L17R25	85
5702313	337	ACUL50	510	CACSW0100I	510	GP7000WE	528	I-PERT5L17R60	85
5702317	442	ADA4	509	CACSW0125I	510	GRAPH23	267	I-PERT5L20R25	85
5702323	337	ADD-10M	282	CACSW0150I	510	GRAPH38	267	I-PERT5L20R50	85
5702327	442	AEW36.2	509	CACSW0200I	510	GRAPH45	267	I-PEXA3L16R12	87
5702333	337	AEW310.2	509	CAFSW065I	510	GRAPH60	267	I-PEXA3L16R25	87
5702337	442	AEW366.2	509	CAFSW080I	510	GRF200P	286	I-PEXA3L16R60	87
5702343	337	AFUL25	510	CAFSW0100I	510	GRF300P	286	I-PEXA3L17R25	87
5702347	442	AFUL32	510	CAFSW0125I	510	HCAP-H001-001	512	I-PEXA3L17R60	87
5702353	337	AFUL40	510	CAFSW0150I	510	HD09	281	I-PEXA3L20R25	87
5702357	442	AFUL50	510	CAFSW0200I	510	HD17	131	I-PEXA3L20R50	87
5702363	337	ALC01	363	CASS200P	286	HD34GAS	454	I-PEXA20RCB25	283
5702367	442	ALPEX-16B	81	CASS300P	286	HD35GAS	454	I-PEXA20RCR25	283
5702373	337	ALPEX-16BGAS	454	CAV-IMP	507	HD36GAS	454	ISOL-10	283
5702377	442	ALPEX-16R1	82	CCW050IF	509	HD37GAS	454	ISOL-17	280
5702443	337	ALPEX-16R3	82	CCW065IF	509	HK-PERT10R2	85	ISOL-17	283
5702447	442	ALPEX-16RCB	82	CCW080IF	509	HK-PERT10R10	85	ISOL-20	280
5702453	337	ALPEX-16RCFG	84	CCW0100IF	509	HMR15DF	504	ISOL-20	283
5702457	442	ALPEX-16RCR	82	CCW0125IF	509	HMR15DFB	504	ISOL-25	280
5702463	337	ALPEX-16RGAS	454	CCW0150IF	509	HMR15MFI	504	ISOL-25	283
5702467	442	ALPEX-18R1	82	CCW0200IF	509	HMR15MFI	504	ISOL-RACC	284
5702473	337	ALPEX-18R3	82	CH0002	298	HMR20DF	504	ISOL-SOUND	280
5702477	442	ALPEX-18RCB	82	CHUB01	354	HMR20DFB	504	IV100HT	293
10005520	531	ALPEX-18RCR	82	CHUB02	355	HMR20MFI	504	IV100HT-10	293
19805041	532	ALPEX-20B	81	CHUB04	351	HMR20MFI	504	IV100LT	282
52014503	75	ALPEX-20BGAS	454	CHUB-EXP	351	HMRI-K001-001	504	IV100LT	293
52014503I	75	ALPEX-20R1	82	CLIP03	281	HS25FI	508	IV100LT-10	282
52014504	75	ALPEX-20R3	82	CLIP17F3	281	HS25FIB	508	IV100LT-10	293
52014504I	75	ALPEX-20RCB	82	CLIP20	281	HS32FI	508	IV400	282
52014506	75	ALPEX-20RCFG	84	CLIP20AUT	281	HS32FIB	508	IV400	293
52014506I	75	ALPEX-20RCR	82	CLIP20F3	281	HS40FI	508	IV400-10	282
52014508	75	ALPEX-20RGAS	454	CLIP25F6	281	HS40FIB	508	IV400-10	293
52014508I	75	ALPEX-26B	81	CLIP2025F8	281	HS50FI	508	IV2021	532
52014510	75	ALPEX-26BGAS	454	CRTH	359	HS65FI	508	IV2022	532
52014510I	75	ALPEX-26R	82	D200P	286	HS80FI	508	IV2052	532
52014511	75	ALPEX-26RCB	82	D300	285	HS100FI	508	IV2122	533
52014511I	75	ALPEX-26RCFG	84	D300P	286	I-APEX16B4	81	IV2123	533
52014603	75	ALPEX-26RCR	82	D550	285	I-APEX16R100	83	IVANTIGELO	531
52014603I	75	ALPEX-26RGAS	454	D1000	285	I-APEX16R200	83	KSA0003B02	175
52014604	75	ALPEX-32B	81	DCL300	285	I-APEX16R400	83	KSA0003B03	175
52014604I	75	ALPEX-32BGAS	454	DCL300P	286	I-APEX16RCB50	83	KSA0003B04	175
52014606	75	ALPEX-32R	82	DCL550	285	I-APEX16RCF50	84	KSA0003B05	175
52014606I	75	ALPEX-32RCFG	84	DCL1000	285	I-APEX16RCR50	83	KSA0003B06	175
52014608	75	ALPEX-32RGAS	454	FAS-080L	280	I-APEX18R50	83	KSA0003B07	175
52014608I	75	ALPEX-40B	81	FAS-150	280	I-APEX18R100	83	KSA0003B08	175
52014610	75	ALPEX-50B	81	FAS-150SR	283	I-APEX18R200	83	KSA0003B09	175
52014610I	75	ALPEX-63B	81	FAS-300	280	I-APEX20B4	81	KSA0003B10	175
52014611	75	ATR01-PPSU	283	FAST20-ORG	271	I-APEX20R100	83	KSA0003B11	175
52014611I	75	ATR02-PPSU	283	FAST30-ORG	271	I-APEX20RCB50	83	KSA0003B12	175
52014703	76	ATR03-PPSU	283	FAST40-ORG	271	I-APEX20RCF50	84	KSA0005B02	175
52014704	76	ATR04-PPSU	283	FF-PEXA16R1	87	I-APEX20RCR50	83	KSA0005B03	175
52014706	76	ATR05-PPSU	283	FF-PEXA16R2	87	I-APEX25B4	81	KSA0005B04	175
52014708	76	ATR06-PPSU	283	FF-PEXA16R6	87	I-APEX25R50	83	KSA0005B05	175
52014710	76	ATR07-PPSU	283	FF-PEXA17R1	87	I-APEX25RCB25	83	KSA0005B06	175
52014711	76	BIN-17B	282	FF-PEXA17R6	87	I-APEX25RCR25	83	KSA0005B07	175
52014803	76	BIN-20B50	282	FF-PEXA17R25	87	I-APEX26B4	81	KSA0005B08	175
52014804	76	BIN-25B50	282	FF-PEXA18R2	87	I-APEX26R50	83	KSA0005B09	175
52014806	76	BU-100	281	FF-PEXA18R6	87	I-APEX26RCB50	83	KSA0005B10	175
52014808	76	CA0001	131	FF-PEXA20R2	87	I-APEX26RCF50	84	KSA0005B11	175
52014810	76	CA0002	131	FF-PEXA20R5	87	I-APEX26RCR50	83	KSA0005B12	175
52014811	76	CA0003	131	FF-PEXA20R25	87	I-APEX32B4	81	KSA0005B13	175
1000000145	134	CA0004	131	FF-PEXA25R2	87	I-APEX32R50	83	KSA0034B02	176
1000000842	134	CA0005	131	FF-PEXA25R45	87	I-APEX32RCB25	83	KSA0034B03	176
1000001126	133	CA0006	131	FIB-12	282	I-APEX32RCF25	84	KSA0034B04	176
1000001134	134	CA0007	131	FLAT20-ORG	273	I-APEX32RCR25	83	KSA0034B05	176
1000001654	133	CA0008	131	FLAT30-ORG	273	IKGE01	433	KSA0034B06	176
1000001810	133	CA0009	131	FLAT40-ORG	273	IKK01	404	KSA0034B07	176
1000001811	133	CA0013	131	FLB70	531	IKK02	404	KSA0034B08	176
1000002548	133	CA0015	131	FLI06SOL	531	IKLE01	433	KSA0034B09	176
1000002683	133	CA0016	131	FLI16SOL	531	IKLRQ24A	404	KSA0034B10	176
1000002699	132	CA0017	131	FMC02SC	467	IKR415D	404	KSA0034B11	176
1500000135	134	CACML25IF	508	FMC03SC	467	IM0001	131	KSA0034B12	176
1500003000	134	CACML25IFB	508	FMC04SC	467	INDUSTRY30	275	KSA0034B13	176
1500003001	134	CACML32IF	508	GIU-90	280	INDUSTRY40	275	KSA0035B02	176
ACT20	509	CACML32IFB	508	GP6010	529	INDUSTRY50	275	KSA0035B03	176
ACT26	522	CACML40IF	508	GP6010E	528	I-PERT5L16R12	85	KSA0035B04	176
ACT46-PC	523	CACML40IFB	508	GP7000	529	I-PERT5L16R25	85	KSA0035B05	176
ACUL25	510	CACML-TOOL	508	GP7000E	528	I-PERT5L16R60	85	KSA0035B06	176
ACUL32	510	CACSW065I	510			I-PERT5L17R12	85	KSA0035B07	176

CODE	Page	CODE	Page	CODE	Page	CODE	Page
KSA0035B08	176	S0020015	532	SAP-C-35MRE	403	WILO4F-110	255
KSA0035B09	176	S0020020	532	SAP-C-40E	403	WILO4F-110	313
KSA0035B10	176	S0020025	532	SAP-C-40RE	403	WILO4F-180	236
KSA0035B11	176	S0025015	532	SCU-P-13SRP	507	WILO4F-180	242
KSA0035B12	176	S0025025	532	SCU-P-13SRPB	507	WILO4F-180	255
KSA0036B02	177	S0301160	532	SCU-P-20SRP	507	WILO4F-180	322
KSA0036B03	177	S0301200	532	SCU-P-20SRPB	507	WSW5-00CABCG	505
KSA0036B04	177	S0301250	532	SFU-P-13SRP	507	WSW5-00CABCG	512
KSA0036B05	177	S0304160	532	SFU-P-13SRPB	507	WSW5-00KBCBG	512
KSA0036B06	177	S0304200	532	SFU-P-20SRP	507	WTT16.RNN5	522
KSA0036B07	177	S0304250	532	SFU-P-20SRPB	507		
KSA0036B08	177	S0307200	532	SIL300	285		
KSA0036B09	177	S0307250	532	SIL300CL	285		
KSA0036B10	177	SAM-001	205	SLIM22	263		
KSA0036B11	177	SAM-001	426	SOUND-09	280		
KSA0036B12	177	SAM-010	205	SW-US	505		
KSA0036B13	177	SAM-010	426	TFEK10-1	124		
KSA0037B02	177	SAM-011	205	THERM10	269		
KSA0037B03	177	SAM-032	205	THERM20	269		
KSA0037B04	177	SAM-032	426	THERM30	269		
KSA0037B05	177	SAM-040	205	TOP-A1006	277		
KSA0037B06	177	SAM-040	426	TOP-A1012	277		
KSA0037B07	177	SAM-050	205	TOP-A2006	277		
KSA0037B08	177	SAM-050	426	TOP-A2012	277		
KSA0037B09	177	SAM-060	205	TOP-P2012	277		
KSA0037B10	177	SAM-060	426	US15F	505		
KSA0037B11	177	SAM-135	205	US15FB	505		
KSA0037B12	177	SAM-135	426	US15QD	504		
KSB0028	477	SAM-150	205	US15QDB	504		
KSB0030	480	SAM-150	426	US20F	505		
KSB0032	480	SAM-165	205	US20FB	505		
KSB0033	477	SAM-165	426	US20QD	504		
KSB0038	493	SAM-180	205	US20QDB	504		
KSB0038MR	493	SAM-180	426	US25-3500F	505		
KSB0043	493	SAP-30M	402	US25-6000F	505		
KSB0163	502	SAP-30ME	402	VEARS5	331		
KSB0171	321	SAP-30MR	402	VEARS8	331		
METAL-AF	279	SAP-30MRE	402	VEARS15	331		
METAL-AL	279	SAP-35	402	VEARS20	331		
METAL-PF	279	SAP-35E	402	VEARS24	331		
METAL-PL	279	SAP-35R	402	VEARS33	331		
MHM5-00A2-00	505	SAP-35RE	402	VEARS50	331		
MINIGRAPH5	265	SAP-40M	402	VEARS60	331		
MOB300P	286	SAP-40ME	402	VEARS80	331		
OG1	505	SAP-40MR	402	VEARS100	331		
PLEN3-D160	285	SAP-40MRE	402	VEARS150	331		
PLEN5-D160	285	SAP-45	402	VEARS200	331		
PPSU1RV	284	SAP-45E	402	VEARS300	331		
PPSU2RV	284	SAP-45R	402	VESOL8	531		
PPSU3RV	284	SAP-45RE	402	VESOL15	531		
PPSU4RV	284	SAP-50M	402	VESOL20	531		
PPSU5RV	284	SAP-50ME	402	VESOL24	531		
PPSU6RV	284	SAP-50MR	402	VESOL33	531		
PPSU7RV	284	SAP-50MRE	402	VESOL50	531		
PPSU8RV	284	SAP-60	402	VESOL60	531		
PPSU9RV	284	SAP-60E	402	VESOL80	531		
Qlog	523	SAP-60R	402	WFK30-D110	506		
RDC300-150	285	SAP-60RE	402	WFK30-D110B	506		
RDC380-220	285	SAP-70M	402	WFK30-D130	506		
RE-50F2	281	SAP-70ME	402	WFK30-D130B	506		
RE-100F3	281	SAP-70MR	402	WFW30-D110	506		
REGCU-17	280	SAP-70MRE	402	WFW30-D110B	506		
REGCU-20	280	SAP-80	402	WFW30-D130	506		
REGCU-25	280	SAP-80E	402	WFW30-D130B	506		
REM1	331	SAP-80R	402	WFZ-IRDA-USB	505		
REM3	331	SAP-80RE	402	WFZ-IRDA-USB	512		
RET3	331	SAP-90M	402	WFZ-MBM-USB	509		
RET4	331	SAP-90ME	402	WILO3F	236		
RET6	331	SAP-90MR	402	WILO3F	242		
RET7	331	SAP-90MRE	402	WILO3F	255		
RET9	331	SAP-100	402	WILO3F	307		
RHM500AT0000Z	505	SAP-100E	402	WILO3F-180	236		
RNNPH0010010	522	SAP-100R	402	WILO3F-180	242		
RWM5-000N	506	SAP-100RE	402	WILO3F-180	255		
S0016010	532	SAP-C-25ME	403	WILO3F-180	322		
S0016015	532	SAP-C-25MRE	403	WILO4F	236		
S0016020	532	SAP-C-30E	403	WILO4F	242		
S0016025	532	SAP-C-30RE	403	WILO4F	255		
S0020010	532	SAP-C-35ME	403	WILO4F	305		

1. Premesse

- 1.1 I contratti di vendita stipulati da I.V.A.R. S.p.A. (di seguito anche "venditore") nell'esercizio della propria attività imprenditoriale sono regolati dalle presenti condizioni generali di contratto, salvo deroghe risultanti da accordo scritto recante l'approvazione dall'Ufficio commerciale del venditore.
- 1.2 Eventuali condizioni generali del compratore, ed in particolare condizioni d'acquisto, non troveranno applicazione ai contratti di vendita stipulati dal venditore se non espressamente accettate per iscritto dall'Ufficio commerciale del venditore; in tal caso, tuttavia, salvo deroga scritta, tali condizioni non escluderanno l'efficacia delle presenti condizioni generali di contratto.
- 1.3 L'eventuale nullità e/o inefficacia di una o più disposizioni delle presenti condizioni generali di vendita non incide sulla validità del contratto nel suo complesso.
- 1.4 Le presenti condizioni generali di vendita si intendono integralmente lette ed accettate dal compratore con il conferimento dell'ordine di acquisto.

2. Formazione del contratto e sua esecuzione

- 2.1 Gli ordini e/o gli impegni assunti da rappresentanti, agenti e/o altri ausiliari del venditore non hanno in alcun modo il potere di vincolare il venditore medesimo; né consegue che tutti gli ordini gestiti da i predetti rappresentanti, agenti e ausiliari acquistano validità ed efficacia solo con la conferma scritta dell'Ufficio commerciale del venditore.
- 2.2 Qualsiasi modifica dell'ordine sarà valida e vincolante per il venditore solo previa approvazione scritta dell'Ufficio commerciale del venditore.
- 2.3 L'esecuzione del contratto potrà essere sospesa in qualsiasi momento nel caso di mutamento delle condizioni patrimoniali del compratore ai sensi ed agli effetti dell'art. 1461 del Codice Civile, salvo il risarcimento del danno. Al venditore è attribuita la facoltà di richiedere, anche in corso di esecuzione del contratto, idonee garanzie di pagamento. La mancata prestazione delle garanzie richieste costituirà causa di risoluzione del contratto ai sensi dell'art. 1456 Codice Civile.

3. Cataloghi e listini-prezzi

- 3.1 I dati, le misure, gli articoli, i prezzi, le caratteristiche, le prestazioni e tutti gli altri dati riprodotti nei cataloghi, listini, prospetti, circolari ecc. del venditore hanno carattere indicativo; essi possono essere variati senza alcun preavviso e hanno valore vincolante per il venditore unicamente in caso di loro espressa indicazione nell'accettazione/conferma d'ordine.
- 3.2 I listini-prezzi del venditore non costituiscono offerta; essi sono puramente indicativi e possono essere modificati unilateralmente dal venditore senza preavviso.
- 3.3 I prezzi si considerano di norma, salvo diverso accordo, "franco stabilimento del venditore - exw", imballaggio incluso. Sono, pertanto, a carico del compratore le tasse, imposte e diritti vigenti al momento della consegna. I prezzi non comprendono prestazioni od oneri non menzionati.
- 3.4 Le spese di assicurazione della merce sono a carico dell'acquirente, come pure le eventuali spese e gli eventuali diritti di dogana dovuti per il ritardo nello sdoganamento o per altre cause.

4. Modalità di pagamento; decadenza del beneficio del termine; recesso unilaterale; interessi moratori; accettazione della fattura e ricognizione di debito.

- 4.1 Salvo deroghe scritte, tutti i pagamenti devono essere effettuati presso la sede del venditore ed in valuta Euro. Tratte od altri mezzi di pagamento concordati non comportano in alcun modo modifiche o deroghe alla presente norma.
- 4.2 I prezzi riportati sul listino-prezzi del venditore si intendono al netto di I.V.A., che verrà applicata al tasso in vigore al momento della data di fatturazione.
- 4.3 Per ogni giorno di ritardo rispetto al pattuito termine di pagamento verranno conteggiati gli interessi moratori ai sensi del D.lgs. n. 231/2002.
- 4.4 In caso di pagamento dilazionato/rateale dell'importo della fattura, la mancata osservanza di un termine di pagamento comporta l'automatica decadenza dal beneficio del termine, l'esigibilità immediata dell'intero ammontare e la decorrenza degli interessi moratori ai sensi del D.lgs. n. 231/2002.
- 4.5 In caso di fallimento o di ammissione del compratore a procedure concorsuali nonché in caso di assoggettamento del compratore a procedure esecutive e/o a protesti, i debiti del compratore si considerano immediatamente esigibili e il venditore avrà facoltà, ai sensi dell'art. 1373 Codice Civile, di risolvere il contratto mediante l'invio di lettera raccomandata a/r ovvero mediante invio di posta certificata (P.E.C.).
- 4.6 Qualora sia convenuto un regolamento cambiario, sono a carico del compratore sia gli interessi di sconto che le spese e commissioni relative; gli interessi saranno conteggiati al tasso ufficiale di sconto maggiorato di tre unità. In caso di mancato pagamento o mancata accettazione di un effetto cambiario, le somme dovute diverranno immediatamente esigibili qualunque siano le condizioni convenute in precedenza.
- 4.7 Il decorso di dieci (10) giorni dal ricevimento della fattura senza che sia intervenuta qualsivoglia contestazione scritta da parte del compratore, da indirizzare all'Ufficio commerciale del venditore, circa l'ammontare della somma di denaro ivi indicata implica l'avvenuta ricognizione da parte del cliente del debito recato dalla predetta fattura ai sensi dell'art. 1988 Codice Civile.

5. Messa a disposizione "franco stabilimento del venditore - exw" e spedizione della merce

Il venditore comunicherà al compratore, per lettera e/o telegramma e/o telex e/o e-mail e/o posta certificata (P.E.C.), la data di messa a disposizione della merce presso lo stabilimento del venditore. Qualora il compratore non proceda al ritiro della merce presso lo stabilimento del venditore entro dieci (10) giorni dalla suddetta comunicazione, il venditore procederà alla spedizione della merce presso il domicilio del compratore da quest'ultimo specificato nell'ordine di acquisto. Nel caso di ritardata spedizione indipendente da fatto proprio, il venditore ha facoltà di addebitare al compratore le eventuali spese di immagazzinaggio, manutenzione, custodia e assicurazione della merce.

6. Consegna e trasferimento dei rischi

La consegna del materiale s'intende effettuata "franco stabilimento del venditore - exw" e "franco partenza". Ogni responsabilità del venditore cessa con la consegna al compratore o al vettore; ne consegue che il materiale viaggia a rischio e pericolo del compratore. Nei casi in cui, per accordi specifici intervenuti con il compratore, il materiale sia venduto "franco destino" non verranno comunque accettate contestazioni per eventuali furti, danneggiamenti o manomissioni. Eventuali accordi con spedizionieri, ivi compreso l'ammontare ed il pagamento del prezzo del trasporto, s'intenderanno sempre conclusi in nome e per conto del compratore, che sin d'ora accetta e ratifica l'operato del venditore.

7. Trasporto ed imballaggi; responsabilità per perdite ed avarie

- 7.1 L'onere della gestione del trasporto del materiale dallo stabilimento del venditore fino al luogo di destinazione s'intende normalmente a carico del compratore, salvo diverso accordo risultante dalla conferma d'ordine. Le spese di trasporto sono, in ogni caso, a carico del compratore. Il compratore assume tutti i rischi inerenti al trasporto fin dalla consegna del materiale al trasportatore o vettore, anche in caso di riserva del diritto di proprietà.
- 7.2 Il venditore provvederà all'imballaggio secondo le regole d'uso. Il venditore è comunque esonerato da ogni responsabilità per perdite e avarie che non dipendano da dolo o colpa grave del venditore e che non siano diretta e immediata conseguenza della sua condotta. Per particolari tipi di imballaggio saranno conteggiati in fattura gli extra prezzo indicati nel listino-prezzi, ove indicati, o nella conferma d'ordine.

8. Garanzia convenzionale e limitazioni di responsabilità

- 8.1 Tutti i prodotti del venditore vengono accuratamente collaudati in stabilimento; essi sono coperti da garanzia per il periodo di dieci anni dalla data di emissione della fattura, fatta eccezione per i componenti elettronici, che sono coperti da garanzia per il periodo di due anni dalla data di emissione della fattura.
- 8.2 La garanzia del venditore si limita alla sostituzione pura e semplice del pezzo difettoso, che deve essere previamente restituito al venditore (e sono, pertanto, tassativamente escluse dalla copertura della garanzia eventuali spese, danni, interessi od indennizzi di sorta). In ogni caso, i particolari di produzione del venditore dal medesimo riconosciuti difettosi, previo reclamo formulato dal compratore entro il termine massimo previsto dalla normativa in vigore, saranno sostituiti esclusivamente dal venditore. Resta comunque inteso che la responsabilità del venditore si limita ai difetti che si manifestino nelle condizioni d'impiego normale e nel corso di un'utilizzazione corretta del prodotto.
- 8.3 Ogni danno a persone, a cose e/o ad animali causato dal cattivo funzionamento del prodotto deve essere segnalato entro 24 ore, comunicando il nome del danneggiato e l'ammontare approssimativo del danno. Successivamente dovranno essere inviate le fotografie attestanti il danno, unitamente al prodotto causa del danno lamentato ai fini dell'esame di laboratorio. Tutto quanto possa evidenziare l'entità del danno deve essere tenuto a disposizione del venditore sino alla chiusura della pratica. Ogni eventuale intervento di ripristino eseguito in assenza di preventiva documentazione fotografica del danno comporterà la decadenza dal diritto alla garanzia dal venditore.
- 8.4 Il venditore declina ogni responsabilità per eventuali danni a persone, animali o cose derivanti dall'utilizzo dei prodotti senza l'osservanza delle prescrizioni di sicurezza o comunque non installati correttamente e/o installati senza effettuare i debiti controlli d'uso.

9. Reclami

- 9.1 Il compratore è tenuto ad esaminare in modo accurato la merce nel momento in cui ne riceve la consegna e a comunicare nel dettaglio al venditore, entro otto (8) giorni dalla consegna/ricevimento, eventuali vizi e/o mancanza di qualità riscontrati nel prodotto. Nel caso in cui il compratore non effettui la predetta comunicazione secondo la tempistica appena indicata, il prodotto sarà considerato definitivamente accettato e conforme all'ordine; resta ferma la possibilità, entro un (1) anno dalla consegna del prodotto a pena di prescrizione della azione, di denunciare eventuali vizi occulti e/o mancanza di qualità entro il termine di decadenza di otto (8) giorni dalla scoperta degli stessi in conformità a quanto previsto dagli artt. 1495 e 1497 Codice Civile.

- 9.2 Eventuali reclami e/o contestazioni circa vizi e/o mancanza di qualità del prodotto non attribuiranno al compratore il diritto di omettere o ritardare i pagamenti della fornitura.
- 9.3 Reclami e/o contestazioni circa vizi o mancanza di qualità del prodotto dovranno essere indirizzati esclusivamente all'Ufficio commerciale del venditore compilando in ogni sua parte l'apposito modulo "SEGNALAZIONE RECLAMO" scaricabile online pim.ivar-group.com/Segnalazione_reclami/Segnalazione_reclami_it.pdf.
- 9.4 Per una corretta e rapida gestione del reclamo è fondamentale comunicare informazioni dettagliate sui vizi e/o sulla mancanza di qualità contestati.
- 9.5 Nel caso in cui i prodotti restituiti al venditore non presentino i vizi e/o la mancanza di qualità contestate dal compratore, quest'ultimo dovrà versare al venditore la somma forfetaria pari al 10% del valore della merce a titolo di rimborso delle spese derivanti dalla gestione della procedura di reclamo.

10. Termini di consegna e restituzione della merce; limitazione di responsabilità

- 10.1 Il termine di consegna convenuto tra le parti decorre dal giorno successivo a quello in cui sarà stato raggiunto l'accordo su ogni elemento del contratto e saranno state ricevute dal venditore tutte le informazioni necessarie all'esecuzione della consegna. Resta in ogni caso inteso che i termini di consegna indicati nelle offerte del venditore e/o nelle conferme d'ordine sono puramente indicativi e non vincolanti.
- 10.2 Nel caso sia richiesta una licenza d'importazione da parte del paese del compratore, il termine di consegna decorrerà dal momento in cui il venditore è stato informato per iscritto dell'avvenuta concessione della licenza.
- 10.3 La consegna della merce, anche se parziale, non può essere rifiutata dal compratore; le consegne parziali di merce non attribuiscono al compratore il diritto di annullare l'ordine.
- 10.4 Nessuna responsabilità sarà ascrivibile al venditore, e nulla pertanto sarà dovuto al compratore, ove il ritardo nella consegna non sia imputabile al venditore – come in caso di ritardi di terzi, inclusi fornitori e subfornitori, cause di forza maggiore come mobilitazioni, sommosse, scioperi o serrate, guerre, epidemie, chiusura, incidenti o guasti alle macchine o utensili, incendi, crolli inondazioni, terremoti, temperature eccessive, eventi metereologici e in genere in qualunque altro caso che comporti l'inattività totale o parziale degli stabilimenti del venditore e l'arresto o il rallentamento della produzione.
- 10.5 In ogni caso, il compratore non potrà avvalersi del ritardo nella consegna per risolvere il contratto.
- 10.6 Fatto salvo quanto previsto nel numero 8. in tema di garanzia, il cliente non potrà restituire per alcuna ragione il materiale consegnatogli senza espressa autorizzazione scritta del venditore. Nel caso di ottenimento del consenso alla restituzione, il compratore, per avere diritto al rimborso del corrispettivo di acquisto già pagato, dovrà restituire il materiale secondo le seguenti modalità:
- il materiale non dovrà essere stato utilizzato dal compratore e dovrà essere restituito nelle medesime condizioni in cui il compratore lo aveva ricevuto;
 - la restituzione del materiale dovrà avvenire entro giorni quindici (15) dalla data della fattura di acquisto;
 - il materiale dovrà essere restituito a I.V.A.R. S.p.A. - a cura, spese e rischio del compratore - presso la sede di Prevalle (BS), via IV Novembre, 181.

11. Recesso e sospensione della fornitura

- 11.1 Nel caso di eventi imprevisi, forza maggiore e caso fortuito (quali, a mero titolo esemplificativo, scioperi o serrate, mancato o ridotto approvvigionamento di materie prime, difficoltà di trasporti, guerre, insurrezioni, interruzioni di comunicazioni comunque provocate, guasti agli impianti del venditore ecc.) il venditore avrà la facoltà di recedere dal presente accordo e/o di sospendere la fornitura in corso quando tali eventi imprevisi, ovunque essi avvengano, alterino in modo sostanziale lo stato dei mercati, il valore della moneta, le condizioni dell'industria italiana, o si verificino circostanze anche endogene che, a giudizio insindacabile del venditore, non consentano la utile prosecuzione del rapporto di fornitura.
- 11.2 In caso di mancato pagamento, anche parziale, delle fatture emesse dal venditore, anche se relative a precedenti e già eseguite forniture di prodotti, il venditore si riserva la facoltà di sospendere le forniture di prodotti relative alle conferme d'ordine in corso di esecuzione.
- 11.3 In ogni caso, previsto dalle presenti condizioni generali di contratto, di recesso dal contratto e/o di sospensione della fornitura di materiale, il compratore non avrà diritto ad indennizzi, compensi, rimborsi o risarcimento dei danni.

12. Diritti di proprietà intellettuale – Utilizzo del marchio I.V.A.R.

- 12.1 Qualsiasi disegno o documento tecnico relativo ai prodotti del venditore, anche se rimesso al compratore, rimane di esclusiva proprietà del venditore e non può essere utilizzato dal compratore o copiato, riprodotto, trasmesso o comunicato a terzi senza la preventiva autorizzazione scritta del venditore.
- 12.2 Qualsiasi utilizzo del marchio I.V.A.R. da parte del compratore dovrà essere preventivamente autorizzato per iscritto da parte del venditore, pena il risarcimento dei danni per indebito utilizzo del marchio.

13. Legge applicabile. Giurisdizione. Foro competente.

- 13.1 Il contratto, anche nel caso in cui esso sia stipulato con compratori di nazionalità estera e in caso di prodotti forniti all'estero, sarà disciplinato dalla Legge italiana.
- 13.2 Qualsiasi controversia relativa al presente contratto e alla sua interpretazione e/o esecuzione è soggetta alla esclusiva giurisdizione italiana ed attribuita in via esclusiva alla competenza territoriale del Foro di Brescia.

14. Codice della Privacy

- 14.1 Il compratore presta il consenso al trattamento dei propri dati personali, dando atto di aver ricevuto l'informativa privacy redatta sulla base di molteplici ordinamenti legislativi, inclusi gli artt. 13 e 14 del Regolamento (UE) 2016/679, che può essere consultata sul nostro sito https://pim.ivar-group.com/short/Privacy_clienti
- 14.2 Titolare del trattamento dei dati del compratore è la società I.V.A.R. S.p.A., con sede in Prevalle (BS), Via IV Novembre, 181.
- 14.3 Il compratore potrà esercitare in ogni momento i propri diritti rivolgendosi direttamente al titolare del trattamento all'indirizzo mail notifiche.gdpr@ivar.it
- 14.4 I.V.A.R. S.p.A. garantisce che i dati personali del compratore saranno trattati in forma automatizzata per il solo fine ed ai soli effetti del contratto di vendita regolato dalle presenti condizioni generali di contratto. Il trattamento verrà svolto in forma automatizzata e sarà improntato ai principi di correttezza, liceità e trasparenza e di tutela della riservatezza e dei diritti del compratore.
- 14.5 Il conferimento dei dati è obbligatorio per dare corso all'esecuzione del contratto e per adempiere agli obblighi contabili e fiscali; l'eventuale rifiuto di fornire tali dati comporterà la mancata esecuzione del contratto per colpa del compratore.
- 14.6 I dati personali potranno essere comunicati, oltre che a soggetti legati alla società I.V.A.R. S.p.A. (ad es. dipendenti, agenti, procuratori, filiali e/o sedi secondarie, ecc.) a banche, compagnie assicurative e comunque, in genere, a consulenti e/o professionisti della società stessa.

15. Comunicazioni

Fatto salvo quanto diversamente previsto nelle altre condizioni generali di vendita, tutte le comunicazioni fra le parti dovranno essere effettuate per iscritto ed inviate all'indirizzo del destinatario indicato nel contratto ovvero alla sede legale del destinatario a mezzo lettera raccomandata A/R, telefax, e-mail, posta certificata (P.E.C.) o consegna a mano.

Il Compratore (data, timbro e firma)

Il compratore, nel dare atto di non rivestire la qualità di "consumatore", con conseguente esclusione della applicazione delle disposizioni e discipline di legge e/o di regolamento relative ai rapporti tra imprenditori e consumatori, dichiara di aver posto particolare attenzione alle seguenti clausole ai sensi degli artt. 1341 e 1342 c.c.:

- 2. Formazione del contratto e sua esecuzione;
- 4. Modalità di pagamento; decadenza dal beneficio del termine (4.4.); recesso unilaterale (4.5.); interessi moratori; accettazione della fattura e ricognizione di debito (4.7.).
- 6. Consegna a trasferimento dei rischi;
- 7. Trasporto ed imballaggi; responsabilità per perdite ed avarie (7.2.);
- 8. Garanzia convenzionale e limitazioni di responsabilità;
- 9. Reclami.
- 10. Termini di consegna e restituzione della merce; limitazione di responsabilità (10.4.);
- 11. Recesso e sospensione della fornitura;
- 13. Legge applicabile. Giurisdizione. Foro competente;

e di approvarle specificamente, prendendo e dando atto che l'esecuzione dell'ordine da parte di I.V.A.R. S.p.A. comporta l'integrale applicazione delle presenti condizioni generali di vendita.

Il Compratore (data, timbro e firma)

1. Introduction

- 1.1 The sales contracts entered into by IVAR S.p.A. (hereinafter the "seller") while conducting its business activities are governed by these general terms and conditions, unless there are exceptions resulting from an explicit written agreement and expressly approved in writing by the Sales Office of the seller.
- 1.2 Any terms and conditions of the buyer and, in particular, conditions of purchase, will not apply to the agreements stipulated by the seller unless expressly accepted in writing by the Sales Office of the seller: in this case, however, unless waived in writing, these terms and conditions remain in effect.
- 1.3 The possible invalidity and/or voidness of one or more provisions in these general conditions of sale will not affect the validity of the contract as a whole.
- 1.4 These general conditions of sale are considered to be fully read and accepted by the buyer upon order placement.

2. Formation of the contract and its execution

- 2.1 Orders taken and/or commitments made by representatives, agents and/or other collaborators of the seller cannot bind the seller in any way; it follows that all orders processed by the aforementioned representatives, agents and collaborators become valid and effective only upon written confirmation from the Sales Office of the seller.
- 2.2 Any changes to the order will be effective only upon written approval by the Sales Office of the seller.
- 2.3 The contract may be suspended at any time in case of changes in the financial conditions of the buyer pursuant to and under Art. 1461 of the [Italian] Civil Code, except claims for damages. The seller is given the right to request, in the course of execution of the order or contract, suitable guarantees of payment. The failure to provide the guarantees required will constitute grounds for termination of the contract pursuant to Art. 1456 of the [Italian] Civil Code.

3. Catalogues and price lists

- 3.1 The data, measurements, articles, prices, features, performance and all other data shown in our catalogues, price lists, prospectuses, circulars etc. are given only as indications; they may be changed without any warning and are only considered binding for the seller in the event of their explicit mention in the acceptance or confirmation of the order.
- 3.2 The price lists of the seller are not offers; they are only approximate and may be modified unilaterally by the seller without notice.
- 3.3 Unless otherwise agreed, prices are considered to be "ex-works of the seller", packaging included. Fees, taxes and duties in force at the time of delivery are the responsibility of the buyer. Prices do not include services or charges not mentioned.
- 3.4 Insurance expenses for the goods are to be borne by the buyer, as well as any expenses and customs duties due to delays in custom clearance or other reasons.

4. Payment methods; forfeiture; unilateral termination; default interests; acceptance of the invoice and debt acknowledgement

- 4.1 Barring written exceptions, all payments must be made at the offices of the seller in Euro. Bank drafts or other means of payment agreed upon do not imply modifications or exceptions to this rule.
- 4.2 The prices in the price list of the seller are exclusive of VAT, which will be applied at the rate in force at the time of the billing date.
- 4.3 For each day of delay with respect to the agreed upon payment terms, a default interest rate will be charged pursuant to [Italian] Legislative Decree. No. 231/2002.
- 4.4 In case of delayed payment/instalments, failure to meet a deadline results in the automatic forfeiture of the agreement, the immediate payment of the entire amount and charging of default interest pursuant to [Italian] Legislative Decree. No. 231/2002.
- 4.5 In the event of insolvency or involvement of the buyer in bankruptcy proceedings and if subjected to enforceable procedures and/or legal disputes, the debts of the buyer will be deemed immediately due and the seller will be entitled pursuant to art. 1373 of the [Italian] Civil Code to terminate the contract by sending a registered letter with return receipt or by sending a notice by certified mail (certified email address).
- 4.6 In the case where settlement is agreed upon via promissory note, the discount interests, costs and relative commissions are at the buyer's expense; interest is calculated at the official discount rate plus three points. In the event of non-payment or non-acceptance of a promissory note, the amount owed will become immediately due and payable regardless of the conditions agreed upon earlier.
- 4.7 If ten (10) days pass from the receipt of the invoice without any written complaint made by the buyer and addressed to the Sales Office of the seller as regards the amount specified therein, the debt will be considered acknowledged by the client in accordance with art. 1988 of the [Italian] Civil Code.

5. Provision and delivery of goods "ex-works of the seller"

The seller will notify by letter and/or telegram and/or telefax and/or e-mail and/or certified mail (certified email address) the date on which the goods are available at the seller's premises. If the buyer does not proceed with the collection of goods from the seller's premises within 10 days of such notice, the seller will proceed with the shipment of the goods to the buyer's address specified in the purchase order. In the case of delayed delivery independent of its own action, the seller has the right to charge the buyer any costs for storage, maintenance, protection and insurance of the goods.

6. Delivery and transfer of risk

The delivery of material is considered "ex-works of the seller" and "free on board". The responsibility of the seller stops with delivery to the buyer or carrier; consequently, the material is transported at the risk of the buyer. In cases in which, due to specific buyer interventions, the material is sold "free delivery", no disputes will be accepted for any thefts, damages or tampering. Any agreements with forwarding agents, including the amount and payment of the cost of transportation are considered settled in the name of and on behalf of the buyer who, from that moment onward, accepts and approves the conduct of the seller.

7. Transport and packaging; liability for loss and damage

- 7.1 The cost of transporting material from the seller's premises to the destination is normally intended to be borne by the buyer, unless otherwise agreed in the order confirmation. Transport costs are, in any case, to be borne by the buyer. The buyer assumes all risks inherent in the transportation starting from the delivery of the goods to the shipper or carrier, even if the right to property is reserved.
- 7.2 The seller will provide the packaging according to the rules of use. The seller is exempt from any liability for loss or damage, which does not result from intentional or gross negligence by the seller and is not the direct and immediate consequence of its conduct. For specific types of packaging, the extra amounts indicated in the price list or in the order, confirmation will be included in the invoice.

8. Standard warranty and liability restrictions

- 8.1 All the products of the seller are carefully tested on site; they are therefore covered by a warranty for a period of ten years from the date of issue of the invoice, except for electronic components, which are covered by a warranty of two years from the date of issue of the invoice.
- 8.2 The seller's warranty is limited to pure and simple replacement of the defective part, which must first be returned to the seller (and therefore any expenses, damages, interest or compensation of any kind are strictly excluded from the warranty). In any case, the components produced by the seller recognized as being faulty, preceded by a complaint made by the buyer within the maximum time period set forth by existing regulation, will be replaced only by the seller. Nevertheless the liability of the seller is limited to faults which appear under normal working conditions and during correct product use.
- 8.3 Any damage caused to things and/or animals by incorrect product operation must be made known within 24 hours, providing the name of the damaged part and the approximate amount of the damage. Subsequently photographs showing the damage must be sent, together with the product, which caused the alleged damage, for examination in the laboratory. Anything, which may provide evidence of the extent of the damage, must be made available to the seller until the case is closed.
- 8.4 The seller refuses all responsibility for any damage or injury to persons, animals or property derived from the use of the appliances without observing the safety provisions or from appliances, which are not installed correctly and/or were installed without performing the appropriate operation checks

9. Complaints

- 9.1 The buyer is required to examine the goods carefully when it receives delivery and notify the seller within eight (8) days from the delivery/receipt, of any defects or quality issues found in the product. If the buyer fails to make such notification within the time just indicated, the product is deemed to be definitively accepted and compliant with the order; it will still be possible, within one (1) year from the delivery of the product, under penalty of limitation of actions, to report any hidden faults and/or quality issues within the time limit of eight (8) days of discovery of the same in accordance with the requirements of Arts. 1495 and 1497 of the [Italian] Civil Code.
- 9.2 Any complaints and/or disputes about defects and/or quality issues of the product do not give the buyer the right to omit or delay payments of the supply.
- 9.3 Complaints and/or disputes about defects or quality issues of the product must be addressed exclusively to the Sales Office of the seller by filling in the "CLAIM REQUEST FORM", which can be downloaded from our website pim.ivar-group.com/Segnalazione_reclami/Segnalazione_reclami_en.pdf.
- 9.4 For a correct and swift management of the complaint it is essential to provide detailed information as regards the faults and/or quality issues.

9.5 If the products returned to the seller show no sign of the defects and/or quality issues reported by the buyer, the latter must pay to the seller a lump sum equal to 10% of the value of the goods as reimbursement for the cost of managing the complaint procedure.

10. Terms of delivery and return of goods; restriction of liability

10.1 The terms of delivery go into effect on the day following that on which the agreement is reached on each element of the contract and the seller receives all information necessary for execution. In any case, it is understood that the terms of delivery specified in the seller's offers and/or order confirmations only serve as guidelines and are not binding.

10.2 If an import license is requested from the country of the buyer, the delivery terms will go into effect from the moment the seller has been informed in writing of the granting of the license.

10.3 Deliveries of goods, even if partial, cannot be refused by the buyer; partial deliveries of goods do not give the buyer the right to cancel the order.

10.4 No liability will be due to the seller, and therefore nothing will be due to the buyer, if the delay is not attributable to the seller - as in the case of delays by third parties, including suppliers and subcontractors, due to force majeure such as demonstrations, riots, strikes or lockouts, wars, epidemics, closure, accidents or failures of machinery or tools, fires, collapses, floods, earthquakes, extreme temperatures, weather events and generally in any other case involving partial or total inactivity of the premises of the seller and production stoppage or slowdown.

10.5 In any case, the buyer cannot use the delay in delivery to terminate the contract.

10.6 Except as provided for in number 8. on the subject of warranty, the client cannot return delivered material without the express written permission of the seller for any reason. To obtain consent for return and be entitled to a refund of the purchase price already paid, the buyer must return the material as follows:

- the material must be unused and returned in the same condition in which the buyer received it;
- the material must be returned within fifteen days (15) of the date of the invoice;
- the material must be returned to IVAR s.p.a. - at the expense and risk of the buyer - to the headquarters in Prevalle (BS), via IV Novembre, 181.

11. Withdrawal and suspension of supply

11.1 In case of unforeseen circumstances, force majeure and fortuitous events (such as but not limited to strikes or lockouts, missed or reduced supply of raw materials, difficulty of transport, wars, insurrection, interruption of communications, however caused, plant breakdowns etc.) the seller has the right to withdraw from this agreement and/or suspend the current supply when these unexpected events, wherever they take place, substantially alter the state of the markets, the value of money, Italian industry conditions or circumstances arise, even endogenous, that according to the incontestable judgement of the Seller, do not allow for the useful continuation of the supply relationship.

11.2 In case of non-payment, although partial, of the invoices issued by the seller, even for products that have already been supplied, the seller reserves the right to suspend the supply orders being processed.

11.3 In any case, under these general conditions of sale regarding withdrawal from the contract and/or suspension of the supply of material, the buyer will not be entitled to reparation, compensation, reimbursement or damages.

12. Intellectual property rights

12.1 Any drawing or technical document related to products of the seller, even if given to the buyer, remains the exclusive property of the seller and cannot be used by the buyer or copied, reproduced, transmitted or communicated to third parties without the prior written authorization of the seller.

12.2 Any use of the I.V.A.R mark. by the buyer must be previously authorized in writing by the seller, penalty of compensation of damage. due to improper use of the mark.

13. Applicable law. Jurisdiction. Competent court

13.1 The contract, even if it is entered into with buyers of foreign nationality, and in case of goods supplied abroad, will be governed by Italian law.

13.2 Any dispute related to this contract and its interpretation and/or execution will be subject exclusively to Italian jurisdiction and attributed exclusively to the territorial jurisdiction of the Court of Brescia.

14. Privacy Code

14.1 The buyer gives its consent to the processing of its personal data, acknowledging that it has received the information provided by art. Art.13/14 of Regulation (EU) 2016/679 (General Data Protection Regulation) that is consultable on our website: https://pim.ivar-group.com/short/Client_supplier_Privacy_Policy

14.2 The data controller of the buyer is IVAR s.p.a. based in Prevalle (BS), Via IV Novembre, 181.

14.3 The buyer can exercise at any time by addressing the data controller directly at notifiche.gdpr@ivar.it

14.4 IVAR s.p.a. ensures that the personal information of the buyer will be processed automatically for the sole purpose and only to the effects of the sales contract governed by these general conditions of sale. The processing will be carried out automatically and will be based on the principles of correctness, lawfulness and transparency and the protection of privacy and the rights of the buyer.

14.5 The submission of data is compulsory to initiate the execution of the contract and to comply with accounting and tax obligations; any refusal to provide such data will result in the breach of contract because of the buyer.

14.6 In addition to subjects related to IVAR s.p.a. (e.g. employees, agents, brokers, subsidiaries and/or branches, etc.), personal data may be disclosed to banks, insurance companies and in general to consultants and/or professionals the same company.

15. Communication

Except if otherwise specified in the other general conditions of sale, all communication between the parties must be made in writing and sent to the address indicated in the contract or to the registered office of the addressee by registered letter with return receipt, telefax, e-mail, certified mail (certified email address) or delivered by hand.

The Buyer (date, stamp and signature)

The buyer, by not acting as a "consumer" and consequently being excluded from the application of rules and disciplines of law and/or regulations related to the relationship between businesses and consumers, declares to have paid particular attention to the following clauses under Articles 1341 and 1342 of the [Italian] Civil Code:

- 2. Formation and execution of the contract;
- 4. Payment methods; forfeiture (4.4.); unilateral termination (4.5.); default interests; acceptance of the invoice and debt acknowledgement (4.7.).
- 6. Delivery and transfer of risk;
- 7. Transport and packaging; liability for loss and damage (7.2.);
- 8. Conventional warranty and restrictions of liability;
- 9. Complaints.
- 10. Terms of delivery and return of goods; restriction of liability (9.4.);
- 11. Withdrawal and suspension of supply 13. Applicable law. Jurisdiction. Competent court;

and to have approved them specifically, acknowledging that the processing of the order by IVAR s.p.a. implies full application of these general conditions of sale.

The Buyer (date, stamp and signature)

1. Prémisses

- 1.1 Les contrats de vente stipulés par IVAR S.p.A. (ci-après dénommé « vendeur »), dans l'exercice de ses activités d'entreprise, sont régis par les présentes conditions générales de contrat, sauf dérogations résultant d'un accord écrit expressément approuvé par écrit par le Bureau Commercial du vendeur.
- 1.2 Les éventuelles conditions générales de l'acheteur, en particulier les conditions d'achat, ne s'appliqueront pas aux contrats de vente stipulés par le vendeur s'ils ne sont pas expressément acceptés par écrit par le Bureau Commercial du vendeur : dans ce cas, toutefois, sauf dérogation écrite, ces conditions n'affecteront pas l'efficacité des présentes conditions générales de contrat.
- 1.3 L'éventuelle nullité et/ou inefficacité d'une ou de plusieurs dispositions des présentes conditions générales de vente n'affecte pas la validité du contrat dans son ensemble.
- 1.4 Les conditions présentes générales de vente doivent être intégralement lues et acceptées par l'acheteur avec l'attribution de la commande de l'achat.

2. Formation du contrat et son exécution

- 2.1 Les commandes ou les engagements pris par les représentants, agents ou autres auxiliaires du vendeur n'ont pas le pouvoir de lier de quelque façon que ce soit le vendeur ; il s'ensuit que toutes les commandes effectuées par les représentants mentionnés ci-dessus, les agents et auxiliaires, ne deviennent valides et efficaces qu'avec la confirmation par écrit du Bureau Commercial du vendeur.
- 2.2 Toute modification de la commande n'obtiendra validité et ne sera contraignante qu'après approbation écrite du Bureau Commercial du vendeur.
- 2.3 A tout moment, l'exécution du contrat pourra être suspendue, en cas de changement des conditions du patrimoine de l'acheteur, conformément à l'art. 1461 du Code Civil, sauf l'indemnisation du dommage. Le vendeur a le droit de demander, même en cours d'exécution du contrat, des garanties appropriées de paiement. La non procuration des garanties demandées constituera un motif de résiliation du contrat conformément à l'art. 1456 du Code Civil.

3. Catalogues et catalogues des prix

- 3.1 Les données, les mesures, les articles, les prix, les caractéristiques, les prestations et toutes les autres données affichées dans nos catalogues, listes, prospectus, circulaires, etc. ont un caractère indicatif ; elles peuvent être changées sans aucun préavis, et ne sont pas contraignantes pour le vendeur qu'en cas d'expresse indication lors de l'acceptation ou lors de la confirmation de la commande.
- 3.2 Les listes de prix du vendeur ne constituent pas une offre ; ils sont purement indicatifs et peuvent être modifiés unilatéralement par le vendeur sans préavis.
- 3.3 Les prix sont normalement considérés, sauf accord contraire, « franco usine du vendeur », emballage utilisé. Les taxes, impôts et droits en vigueur au moment de la livraison sont à la charge de l'acheteur. Les prix ne comprennent pas les prestations et les charges non mentionnées.
- 3.4 Les frais d'assurance de la marchandise sont à la charge de l'acheteur, ainsi que les frais et droits éventuels de douane dus pour le retard dans le dédouanement ou pour d'autres raisons.

4. Mode de paiement : expiration du bénéfice des délais ; résiliation unilatérale ; intérêts moratoires ; acceptation de la facture et reconnaissance de dette

- 4.1 Sauf dérogations écrites, tous les paiements doivent être effectués auprès du siège du vendeur et en Euros. Les traites ou autres moyens de paiement accordés ne comportent en aucun cas des modifications ou des dérogations à cette norme.
- 4.2 Les prix reportés sur la liste de prix du vendeur sont nets de TVA, laquelle sera appliquée au taux en vigueur au moment de la date de facturation.
- 4.3 Pour chaque jour de retard par rapport au délai de paiement convenu, des intérêts moratoires seront comptabilisés, conformément au décret législatif n. 231/2002.
- 4.4 En cas de retard de paiement échelonné/différé, le non-respect d'un délai entraîne la déchéance automatique du terme, l'exigibilité immédiate de la totalité du montant et la prise d'effet des intérêts moratoires, conformément au décret législatif n. 231/2002.
- 4.5 En cas de faillite de l'acheteur ou d'ouverture de procédures collectives pour insolvabilité à l'encontre de ce dernier, ainsi qu'en cas d'assujettissement de l'acheteur à des procédures d'exécution et/ou à des protestations, les dettes de l'acheteur sont réputées immédiatement exigibles et le vendeur est en droit, en vertu de l'art. 1373 du Code Civil, de résilier le contrat par courrier recommandé a/r ou par courrier certifié (P.E.C.).
- 4.6 Si un paiement par lettre de change a été convenu, les intérêts d'escompte ainsi que les frais et commissions relatifs sont à la charge de l'acheteur ; l'intérêt sera calculé au taux officiel d'escompte plus trois unités. En cas de non-paiement ou de non-acceptation de la lettre de change, les sommes dues deviendront immédiatement exigibles, quelles que soient les conditions convenues antérieurement.
- 4.7 L'expiration de dix (10) jours à compter de la réception de la facture, sans l'intervention d'aucune contestation écrite de la part de l'acheteur à l'adresse du Bureau Commercial du vendeur quant au montant de la somme d'argent qui est indiquée, implique la reconnaissance de la dette, dont le montant est indiqué dans la facture, par le client, conformément à l'art. 1988 Code civil.

5. Mise à disposition « franco usine du vendeur exw », et expédition de la marchandise

Le vendeur communiquera à l'acheteur, par lettre et/ou télégramme et/ou fax et/ou e-mail et/ou courrier certifié (P.E.C.), la date de mise à disposition de la marchandise dans l'établissement du vendeur. Si l'acheteur ne procède pas à la récupération de la marchandise auprès de l'usine du vendeur dans les 10 jours à compter de la communication mentionnée ci-dessus, le vendeur procédera à l'envoi de la marchandise au domicile de l'acheteur indiqué dans le bon de commande. En cas de retard de l'envoi ne dépendant pas de ses actions, le vendeur a le droit de facturer à l'acheteur les éventuels frais de stockage, d'entretien, de garde et d'assurance de la marchandise.

6. Livraison et transfert des risques

La livraison du matériel est entendue effectuée « franco usine du vendeur - exw » et « franco départ ». Toute responsabilité du vendeur cesse dès la remise de la marchandise à l'acheteur ou au transporteur ; il s'ensuit que le matériel est transporté aux risques et périls de l'acheteur. Dans les cas où, après accords spécifiques pris avec l'acheteur, le matériel est vendu « port payé », les contestations pour vols, endommagements ou altérations ne seront de toute façon pas acceptées. D'éventuels accords avec les commissionnaires de transport, y compris le montant et le paiement du prix du transport, seront toujours conclus au nom et pour le compte de l'acheteur à partir du moment où il accepte et ratifie l'acte du vendeur.

7. Transport et emballages ; responsabilité pour pertes et avaries

- 7.1 Le coût du transport du matériel de l'usine du vendeur au lieu de destination est normalement à la charge du vendeur, sauf accord contraire venant de l'acheteur, de la commande. Les frais de transport sont, en tous les cas, à la charge de l'acheteur. L'acheteur assume tous les risques inhérents au transport depuis la remise du matériel au transporteur ou au vecteur, même en cas de réserve du droit de propriété.
- 7.2 Le vendeur fournira l'emballage selon les règles d'utilisation. Le vendeur est en tous les cas exonéré de toute responsabilité pour les pertes et dommages qui ne relèvent pas d'une faute intentionnelle ou grave du vendeur et qui ne découlent pas directement et immédiatement de sa conduite. Certains types d'emballages seront facturés en extra, d'après le surcoût indiqué dans la liste des prix, sur demande ou lors de la confirmation de la commande.

8. Garantie conventionnelles et limites de responsabilité

- 8.1 Tous les produits du vendeur sont soigneusement contrôlés en usine. Ils sont donc couverts par une garantie de 10 (dix) ans à partir de la date d'émission de la facture, à l'exception des composants électroniques pour lesquels est accordée une garantie de 2 (deux) ans à compter de la date d'émission de la facture.
- 8.2 La garantie du vendeur se limite purement et simplement au remplacement de la pièce défectueuse, qui doit d'abord être retournée au vendeur (les éventuels frais, dommages ou indemnités de toute nature sont donc strictement exclus de ce que couvre la garantie). Dans tous les cas, les détails de production du vendeur reconnus défectueux par ce dernier, sur plainte présentée par l'acheteur dans les délais prévus par la réglementation en vigueur, seront remplacés exclusivement par le vendeur. La responsabilité du vendeur se limite toutefois aux défauts qui se manifestent dans les conditions normales d'utilisation et au cours d'une utilisation correcte du produit.
- 8.3 Tout dommage causé par le mauvais fonctionnement du produit doit être signalé dans les 24 heures, en communiquant le nom du client qui a subi le dommage et le montant approximatif du dommage. Les photographies témoignant du dommage devront ensuite être envoyées, en alléguant le produit ayant causé le dommage, afin d'effectuer l'examen en laboratoire. Tout ce qui peut mettre en évidence l'étendue du dommage doit être tenu à disposition du vendeur jusqu'à la fermeture du dossier. Toute éventuelle intervention de rétablissement effectuée sans la présence de documentation photographique préalable du dommage entraînera la déchéance du droit à la garantie du vendeur.
- 8.4 Le vendeur décline toute responsabilité pour les éventuels dommages aux personnes, animaux ou choses dérivants de l'utilisation des produits sans observer les prescriptions de sécurité, ou de toute façon non installés correctement et/ou installés sans effectuer les contrôles d'utilisation nécessaires.

9. Réclamations

- 9.1 L'acheteur est tenu d'examiner la marchandise avec attention à la réception de la livraison et de signaler en détail au vendeur, dans les huit (8) jours suivant la livraison/réception, les éventuels défauts ou manque de qualité observés dans le produit. Dans le cas où l'acheteur n'effectue pas le signalement mentionné ci-dessus dans les délais indiqués précédemment, le produit sera considéré définitivement accepté et conforme à la commande ; il demeure possible, dans un délai d'un (1) an à compter de la livraison du produit, sous peine de description de l'action, de dénoncer d'éventuels défauts cachés et/ou manque de qualité avant l'expiration du délai de huit (8) jours à partir de la découverte de ces défauts, conformément aux dispositions des articles 1495 et 1497 du Code Civil.

- 9.2 Les éventuelles réclamations et/ou contestations concernant des défauts ou un manque de qualité du produit n'attribuent pas à l'acheteur le droit d'omettre ou de retarder les paiements de l'approvisionnement.
- 9.3 Des réclamations et/ou contestations de vices ou manque de qualité du produit devront être exclusivement communiqués au service commercial du vendeur en remplissant entièrement Le fichier "CLAIM REQUEST FORM" à télécharger en ligne pim.ivar-group.com/Segnalazione_reclami/Segnalazione_reclami_en.pdf. Pour pouvoir gérer rapidement et correctement la réclamation il est indispensable de fournir des informations détaillées sur les vices et/ou sur le manque de qualité contestés.
- 9.4 Si les produits restitués au vendeur ne présentent aucun vice et/ou le manque de qualité contesté par l'acheteur, ce dernier devra verser au vendeur une somme forfaitaire correspondant à 10% de la valeur de la marchandise à titre de remboursement des frais dérivant de la gestion de la procédure de réclamation.

10. Délais de livraison et restitution de la marchandise; limite de responsabilité

- 10.1 Le délai de livraison commence à partir du jour suivant celui où l'accord a été atteint concernant chaque élément du contrat, et où toutes les informations nécessaires à l'exécution ont été reçues par le vendeur. Il est en tout cas entendu que les conditions de livraison indiquées dans les offres du vendeur sont purement indicatives et non contraignantes.
- 10.2 Si le pays de l'acheteur exige un permis d'importation, le délai de livraison commencera à partir du moment où le vendeur aura été informé par écrit de la délivrance dupermis.
- 10.3 Les livraisons de la marchandise, même partielles, ne peuvent pas être refusées par l'acheteur ; les livraisons partielles de marchandise n'attribuent pas à l'acheteur le droit d'annuler la commande.
- 10.4 Aucune responsabilité ne sera attribuable au vendeur, et rien ne sera donc dû à l'acheteur, si le retard n'est pas imputable au vendeur - comme dans le cas de retards de tiers, y compris les fournisseurs et sous- traitants, les cas de force majeure comme les manifestations, les émeutes, les grèves et les lock-out, les guerres, les épidémies, la fermeture, les accidents ou les pannes de machines ou d'outils, les incendies, les effondrements, les inondations, les tremblements de terre, les températures excessives, les événements météorologiques et en général tous les autres cas impliquant l'inactivité totale ou partielle des usines du vendeur et l'arrêt ou le ralentissement de la production.
- 10.5 Dans tous les cas, le retard de livraison ne donne pas à l'acheteur le droit de résilier le contrat.
- 10.6 Sans préjudice des prévisions du numéro 8. en termes de garantie, le client ne peut pas retourner pour une raison quelconque le matériel qui lui a été livré sans autorisation expresse et écrite du vendeur. En cas d'obtention du consentement au retour du produit, l'acheteur, pour avoir droit au remboursement de l'achat déjà payé, devra retourner le matériel selon les modalités suivantes :
- le matériel ne devra pas avoir été utilisé par l'acheteur et il devra être retourné dans le même état que celui dans lequel l'acheteur l'avait reçu ;
 - le retour du matériel devra s'exécuter dans les quinze (15) jours suivant la date de la facture de l'achat ;
 - le matériel devra être retourné à IVAR s.p.a. - aux soins, frais et risques de l'acheteur - auprès du siège de Prevalle (BS), via IV Novembre, 181.

11. Retrait et suspension de l'approvisionnement

- 11.1 En cas d'événements imprévus, de force majeure et de cas fortuits (tels que, mais sans s'y limiter, les grèves ou lock-out, l'approvisionnement manqué ou réduit de matières premières, les problèmes de transports, les guerres, les insurrections, les interruptions de communication, peu importe la cause, les pannes des équipements du vendeur etc.) le vendeur est en droit de résilier le présent accord et/ou de suspendre l'approvisionnement lorsque ces événements inattendus, où qu'ils se produisent, modifient considérablement l'état des marchés, la valeur de la monnaie, les conditions de l'industrie italienne, ou que se produisent des circonstances endogènes qui, à la discrétion du vendeur, ne permettent pas la poursuite utile du rapport d'approvisionnement .
- 11.2 En cas de non paiement, même partiel, des factures émises par le vendeur, même si relatives à des fournitures de produit précédentes déjà effectuées, le vendeur se réserve le droit de suspendre les fournitures de produits relatifs aux confirmations de commande en cours d'exécution.
- 11.3 Dans tous les cas, au vu des conditions générales de contrat, de résiliation du contrat et/ou de suspension de l'approvisionnement de matériel, l'acheteur n'a pas droit à des indemnités, compensations, remboursements ou dommages et intérêts.

12. Droits de propriété intellectuelle

- 12.1 Tout dessin ou document technique concernant les produits du vendeur, même s'il est remis à l'acheteur, demeure la propriété exclusive du vendeur et ne peut être utilisé par l'acheteur ni copié, reproduit, transmis ou communiqué à des tiers sans l'accord écrit préalable du vendeur.
- 12.2 Toute utilisation de la marque I.V.A.R. par l'acheteur devra être préventivement autorisée par écrit par le vendeur, sous peine de dommages et intérêts pour utilisation indue de la marque.

13. Loi applicable. Juridiction. Tribunal compétent

- 13.1 Le contrat, même s'il est stipulé avec des acheteurs de nationalité étrangère et en cas de produit fournis à l'étranger, sera régi par la loi italienne.
- 13.2 Tout litige relatif au présent contrat et à son interprétation et/ou exécution est exclusivement soumis à la juridiction italienne et est exclusivement attribué à la juridiction territoriale du Tribunal de Brescia.

14. Code de confidentialité

- 14.1 L'acheteur donne son consentement au traitement des données à caractère personnel, en reconnaissant qu'il a reçu la notice prévue par l'article 13/14 du règlement européen 2016/679 (règlement général sur la protection des données) consultable sur notre site https://pim.ivar-group.com/short/Client_supplier_Privacy_Policy
- 14.2 Le titulaire du traitement des données par l'acheteur est la société IVAR s.p.a., ayant siège à Prevalle (BS), Via IV Novembre, 181.
- 14.3 L'acheteur peut à tout moment exercer ses droits en s'adressant directement au titulaire du traitement à l'adresse e-mail notifiche.gdpr@ivar.it
- 14.4 IVAR s.p.a. garantit que les données personnelles de l'acheteur seront traitées de manière automatique aux seules fins du contrat de vente régis par les présentes conditions générales de contrat. Le traitement s'effectuera de manière automatique et se fondera sur les principes de correction, de légalité, de transparence et de protection de la confidentialité et des droits de l'acheteur.
- 14.5 L'attribution des données est obligatoire pour donner cours à l'exécution du contrat et pour remplir les obligations comptables et fiscales; l'éventuel refus de fournir ces données impliquera l'inexécution du contrat à cause de l'acheteur.
- 14.6 Les données personnelles pourront être communiquées, outre aux sujets liés à la société IVAR s.p.a. (par ex. employés, agents, fournisseurs, filiales et/ou sièges secondaires, etc.) à des banques, à des compagnies d'assurance et, en général, à des consultants et/ou professionnels de la société même.

15. Communications

Sans préjudice aux prévisions des autres conditions générales de vente, toutes les communications entre les parties devront être effectuées par écrit et seront envoyées au destinataire à l'adresse indiquée dans le contrat, ou au siège légal du destinataire, par lettre recommandée A/R, télécopie, e-mail, courrier certifié (P.E.C.) ou à la main.

L'Acheteur (date, cachet etsignature)

L'acheteur, en reconnaissant qu'il ne revêt pas la qualité de « consommateur », ce qui entraînerait l'exclusion de l'application des dispositions et des disciplines de loi et/ou de réglementations relatives aux relations entre les entrepreneurs et les consommateurs, affirme avoir porté son attention aux clauses suivantes, conformément à l'art. c.c. 1341 et 1342 du code civil :

- 2. Formation du contrat et son exécution.
- 4. Mode de paiement : expiration du bénéfice des délais ; résiliation unilatérale ; intérêts moratoires ; acceptation de la facture et reconnaissance de dette.
- 6. Livraison et transfert des risques ;
- 7. Transport et emballages ; responsabilité pour pertes et avaries.
- 8. Garantie conventionnelles et limites de responsabilité.
- 9. Réclamations.
- 10. Délais de livraison et restitution de la marchandise ; limite de responsabilité (9.4.) ;
- 11. Retrait et suspension de l'approvisionnement ;
- 13. Loi applicable. Juridiction. Tribunal compétent ;

et de les approuver spécifiquement, en reconnaissant que l'exécution de la commande par IVAR s.p.a. implique l'application intégrale des présentes conditions générales de vente.

L'Acheteur (date, cachet etsignature)

1. Einleitung

- 1.1 Die von IVAR S.p.A. (im Folgenden „Verkäufer“ genannt) bei Ausübung seiner Unternehmenstätigkeit abgeschlossenen Verkaufsverträge unterliegen den vorliegenden allgemeinen Vertragsbedingungen, vorbehaltlich ausdrücklich anders lautender schriftlicher Vereinbarungen, denen die Handelsabteilung des Verkäufers ausdrücklich schriftlich zugestimmt hat.
- 1.2 Eventuelle allgemeine Bedingungen des Käufers, und insbesondere Kaufbedingungen, finden für die vom Verkäufer abgeschlossenen Verkaufsverträge keine Anwendung, wenn sie nicht ausdrücklich von der Handelsabteilung des Verkäufers schriftlich anerkannt werden; in diesem Fall wird jedoch die Wirksamkeit der vorliegenden allgemeinen Vertragsbedingungen nicht ausgeschlossen, außer es liegt eine schriftliche Ausnahmeregelung vor.
- 1.3 Die eventuelle Ungültigkeit einer oder mehrerer Verfügungen der vorliegenden allgemeinen Verkaufsbedingungen berührt nicht die Rechtsgültigkeit des Vertrags als Ganzes.
- 1.4 Die vorliegenden allgemeinen Verkaufsbedingungen werden mit der Erteilung des Kaufauftrags seitens des Käufers als gelesen und akzeptiert betrachtet.

2. Entstehung und Ausführung des Vertrags

- 2.1 Die von den Vertretern, Handelsagenten oder sonstigen, vom Verkäufer beauftragten Personen angenommenen Aufträge oder Verpflichtungen sind für den Verkäufer auf keinen Fall verpflichtend; daraus folgt, dass alle von den o.g. Vertretern, Handelsagenten oder sonstigen dazu beauftragten Personen angenommenen Aufträge erst dann gültig und wirksam werden, wenn die diesbezügliche schriftliche Bestätigung der Verkaufsabteilung des Verkäufers vorliegt.
- 2.2 Jede Änderung bezüglich des Auftrags ist nur dann gültig und für den Verkäufer bindend, wenn sie schriftlich von der Verkaufsabteilung des Verkäufers genehmigt wurde.
- 2.3 Im Falle von Veränderungen hinsichtlich der finanziellen Lage des Käufers kann die Ausführung des Vertrags gemäß Art. 1461 des italienischen Zivilgesetzbuchs jederzeit unter Vorbehalt einer Schadenersatzforderung unterbrochen werden. Der Verkäufer ist berechtigt, auch im Laufe der Vertrags- oder Auftragsausführung angemessene Zahlungsgarantien zu verlangen. Eine mangelnde Leistung dieser angeforderten Zahlungsgarantien bewirkt die Vertragsauflösung gemäß Art. 1456 des italienischen Zivilgesetzbuchs.

3. Kataloge und Preislisten

- 3.1 Die Daten, Abmessungen, Artikel, Preise, Eigenschaften, Leistungen und alle sonstigen in unseren Katalogen, Preislisten, Prospekten, Rundschreiben, etc. angegebenen Daten sind unverbindlich; sie können jederzeit ohne Voranmeldung abgeändert werden und werden erst dann für den Verkäufer verbindlich, wenn sie bei der Annahme des Auftrags oder Bestätigung ausdrücklich angegeben wurden.
- 3.2 Die Preislisten des Verkäufers gelten nicht als Angebot, sie sind unverbindlich und können vonseiten des Verkäufers jederzeit ohne Voranmeldung abgeändert werden.
- 3.3 Die Preise verstehen sich außer im Falle von anderen diesbezüglichen Vereinbarungen „Frei Werk des Verkäufers“, Verpackung inbegriffen. Steuern, Gebühren und sonstige im Moment der Lieferung zu leistende Abgaben gehen zu Lasten des Käufers. Die Preise schließen nicht ausdrücklich erwähnte Leistungen oder Verpflichtungen nicht ein.
- 3.4 Die Versicherungskosten für die Waren, sowie eventuell wegen verspäteter Verzollung oder aus anderen Gründen entstehende, zu bezahlende Spesen und Zollkosten gehen zu Lasten des Käufers.

4. Zahlungsweise; Verlust der Fristbegünstigung; einseitiger Rücktritt; Verzugszinsen; Annahme der Rechnung und Schuldanerkennung

- 4.1 Außer im Falle von abweichenden schriftlichen Vereinbarungen müssen die Zahlungen in Euro an den Sitz des Verkäufers geleistet werden. Wechsel oder sonstige vereinbarte Zahlungsbedingungen bewirken auf keinen Fall Änderungen oder Abweichungen bezüglich der vorliegenden Bestimmung.
- 4.2 Die in der Preisliste angegebenen Preise verstehen sich inklusive Mehrwertsteuer. Sie wird bei Rechnungsausstellung zum derzeit geltenden Satz verrechnet.
- 4.3 Für jeden Tag Verspätung im Verhältnis zur vereinbarten Zahlungsfrist werden gemäß Art. 231/2002 des Gesetzesdekrets Nr. 231/2002 Verzugszinsen berechnet.
- 4.4 Im Falle eines Zahlungsaufschubes oder einr Ratenzahlung bewirkt die nicht Einhaltung einer Zahlungsfrist den automatischen Verlust der Fristbegünstigung, die sofortige Fälligkeit des Gesamtbetrags und die Festsetzung des Datums, ab dem gemäß Gesetzesdekret Nr. 231/2002 Verzugszinsen berechnet werden.
- 4.5 Im Falle eines Konkurses oder des Antrags auf Eröffnung eines Insolvenzverfahrens seitens des Käufers, und auch falls der Käufer Zwangsvollstreckungen und/oder Wechsel- oder Scheckproteste unterworfen ist, werden die Schulden des Käufers als sofort fällig betrachtet, und der Verkäufer hat das Recht, gemäß Art. 1373 des italienischen Zivilgesetzbuchs den Vertrag mit einem Einschreibebrief mit Rückschein oder durch zertifizierte Post (P.E.C.) aufzulösen.
- 4.6 Falls eine Zahlung durch Wechsel vereinbart wurde, gehen die Diskontierungszinsen, sowie die dazugehörigen Bankgebühren und -kosten zu Lasten des Käufers. Die Zinsen werden zum offiziellen Zinssatz plus 3 Einheiten verrechnet. Im Falle mangelnder Zahlung oder mangelnden Akzepts eines Wechsels, werden die noch geschuldeten Beträge sofort fällig, unabhängig davon, welche Bedingungen zuvor vereinbart waren.
- 4.7 Wenn nach Ablauf von 10 (zehn) Tagen ab Rechnungserhalt keine schriftliche, an die Verkaufsabteilung des Verkäufers zu adressierende Beanstandung des in der Rechnung angegebenen Betrags seitens des Käufers eingegangen ist, bedeutet das, dass sich der Käufer mit der geschuldeten Summe der genannten Rechnung gemäß Art. 1988 des italienischen Zivilgesetzbuchs einverstanden erklärt.

5. Zurverfügungstellung „Frei Werk des Verkäufers - exw“ und Versand der Ware

Der Verkäufer teilt dem Käufer per Brief und/oder Telegramm und/oder Fax und/oder E-Mail und/oder zertifizierter Post (P.E.C.) das Datum mit, an dem die Ware im Werk des Verkäufers zur Verfügung steht. Falls der Käufer nicht innerhalb von zehn (10) Tagen ab dieser Mitteilung dafür sorgt, dass die Ware im Werk des Käufers abgeholt wird, wird der Verkäufer die Ware an den im Auftrag angegebenen Firmensitz des Käufers schicken. Im Falle einer nicht vom Verkäufer verschuldeten, verspäteten Spedition, hat der Verkäufer das Recht, dem Käufer eventuelle Spesen für die Einlagerung, Wartung, Obhut und Versicherung der Ware zu verrechnen.

6. Waren- und Risikoübergabe

Die Lieferung des Materials erfolgt „Frei Werk des Verkäufers - exw“ oder „frei Lieferort“. Jede Haftung für den Verkäufer erlischt mit der Übergabe der Ware an den Käufer oder an die Transportfirma, daraus folgt, dass der Käufer die Transportrisiken- und gefahren für das Material übernimmt. Falls in besonderen, mit dem Käufer vereinbarten Fällen der Verkauf «Frei Haus» erfolgt, werden dennoch auf keinen Fall Reklamationen wegen Diebstahls, Beschädigungen oder Aufbrechens akzeptiert. Eventuell getroffene Vereinbarungen mit den Transportfirmen, inbegriffen der Transportpreis und die dafür vorgesehene Zahlungsart, verstehen sich immer als im Namen und im Auftrag des Käufers abgeschlossen, der im voraus die vom Verkäufer ausgehandelten Transportbedingungen akzeptiert.

7. Transport und Verpackung; Verantwortung für Verlust und Beschädigungen

- 7.1 Die Bemühungen hinsichtlich des Transports vom Werk des Verkäufers bis zum Ankunftsort verstehen sich gewöhnlich zu Lasten des Käufers, ausgenommen es wurden in der Auftragsbestätigung andere Bedingungen vereinbart. Die Transportkosten gehen auf jeden Fall zu Lasten des Käufers. Der Käufer übernimmt alle mit dem Transport verbundenen Risiken ab der Übergabe des Materials an die Spedition oder den Frachtführer, auch im Falle einer Beibehaltung des Eigentumsrechts seitens des Verkäufers.
- 7.2 Der Verkäufer kümmert sich um eine angemessene Verpackung. Der Verkäufer ist auf jeden Fall nicht für Verluste oder Defekte der Ware verantwortlich, die nicht auf Vorsatz oder schweres Verschulden seinerseits zurückzuführen sind, und die nicht eine direkte oder sofortige Konsequenz seines Verhaltens darstellen. Bei besonderen Verpackungen werden dem Käufer in der Rechnung die in der Preisliste angegebenen Mehrkosten verrechnet, falls sie dort angegeben sind, ansonsten die in der Auftragsbestätigung angegebenen.

8. Vertragsgarantie und Haftungsbeschränkung

- 8.1 Alle Produkte werden vom Hersteller im eigenen Werk einer sorgfältigen Endabnahme unterzogen. Sie sind daher mit einer zehn Jahre langen Garantie ab dem Rechnungsdatum gedeckt, mit Ausnahme der elektronischen Bauteile, fuer die eine Garantie von zwei Jahren ab Rechnungsdatum gewährt wird.
- 8.2 Die vom Verkäufer geleistete Garantie ist auf das Auswechseln des defekten Bauteils beschränkt, das dem Verkäufer zuvor zgesehenicht werden muss (alle Spesen, entstehenden Schäden, Zinsen oder sonstigen Vergütungen jeglicher Art sind daher strikt von der Garantieleistung ausgeschlossen). Die vom Verkäufer im Falle einer Reklamation innerhalb der vorgesehenen Maximalfrist der geltenden Gesetzgebung als defekt anerkannten, vom Verkäufer hergestellten Bauteile werden nur vom Verkäufer direkt ausgewechselt. Es ist auf jeden Fall selbstverständlich, dass die Haftung des Verkäufers sich auf Defekte beschränkt, die bei normalen Betriebsbedingungen und im Laufe eines korrekten Betriebs des Produkts entstehen.
- 8.3 Jeder von schlechtem Funktionieren des Produkts entstandene Schaden an Personen, Sachen und/oder Tieren muss innerhalb von 24 Stunden gemeldet werden, in der Mitteilung muss der Name des Geschädigten und eine ungefähre Angabe des Betrags des Schadens enthalten sein. Nachfolgend müssen zusammen mit dem Produkt, das den beanstandeten Schaden verursacht hat, Fotos des Schadens übermittelt werden, damit Labortests ausgeführt werden können. Alles, was zur Bestimmung des Umfangs des Schadens dient, muss bis zum Abschluss des Schadensfalls für den Verkäufer zur Verfügung stehen und aufbewahrt werden. Falls Reparatureingriffe ohne vorherige photographische Dokumentation ausgeführt werden, besteht kein Anspruch auf eine Garantieleistung vonseiten des Verkäufers.
- 8.4 Der Verkäufer lehnt jede Haftung ab für Schäden an Personen, Tieren und Sachen, die wegen mangelnden Einhaltens der Sicherheitsvorschriften, wegen nicht korrekter Installation und/oder Installation ohne angemessene Endabnahme vor der Inbetriebnahme entstanden sind.

9. Reklamationen

- 9.1 Der Käufer muss die Ware bei der Auslieferung genaustens kontrollieren und dem Verkäufer detailliert innerhalb von 8 (acht) Tagen ab der Übergabe/dem Empfang der Ware eventuell am Produkt festgestellte Defekte oder Qualitätsmängel mitteilen. Falls der Käufer eine derartige Mitteilung nicht innerhalb der genannten Frist vornimmt, wird das Produkt als definitiv angenommen und mit dem Auftrag übereinstimmend betrachtet. Es besteht die Möglichkeit, eventuelle versteckte Schäden oder Qualitätsmängel innerhalb 1 (einem) Jahr, 8 (acht) Tagen nach der Wahrnehmung derselben gemäß Art. 1495 und 1497 des italienischen Zivilgesetzbuchs zu beanstanden.

- 9.2 Eventuelle Reklamationen und/oder Beanstandungen in Bezug auf Defekte oder Qualitätsmängel berechtigen den Käufer nicht dazu, die Zahlungen der Lieferung zu unterlassen oder verspätet vorzunehmen.
- 9.3 Reklamationen und/oder Beanstandungen wegen Fehler oder Qualitätsmängel des Produkts sind ausschließlich an die Handelsabteilung des Verkäufers mit dem vollständig ausgefüllten Vordruck "CLAIM REQUEST FORM" zu adressieren pim.ivar-group.com/Segnalazione_reclami/Segnalazione_reclami_en.pdf.
- 9.4 Eine korrekte und zeitnahe Erledigung der Reklamation kann nur auf der Grundlage Ihrer Bekanntgabe detaillierter Informationen über die beanstandeten Fehler und/oder Qualitätsmängel stattfinden.
- 9.5 Falls die dem Verkäufer zurückerstatteten Produkte keine Fehler und/oder Qualitätsmängel aufweisen, die vom Käufer beanstandet wurden, muss dieser letzter dem Verkäufer einen Forfait-Betrag von 10% des Warenwerts als Kostenvergütung für die für das Reklamationsverfahren getragenen Ausgaben zahlen.
- 10. Liefertermine und Rückerstattung der Ware; Haftungsbeschränkung**
- 10.1 Die zwischen den Parteien vereinbarte Lieferfrist beginnt ab dem ersten Tag zu laufen, nach dem alle Vertragsklauseln erfolgreich vereinbart wurden und dem Verkäufer alle notwendigen Informationen zur Auftragsausführung zugekommen sind. Es ist auf jeden Fall selbstverständlich, dass die in den Angeboten des Verkäufers und/oder in den Auftragsbestätigungen angegebenen Lieferfristen eine ungefähre Angabe darstellen und nicht verpflichtend sind.
- 10.2 Falls eine Importlizenz seitens des Landes des Käufers notwendig ist, läuft die Lieferfrist ab dem Augenblick, in dem der Verkäufer schriftlich von der erfolgten Ausstellung der Lizenz informiert wird.
- 10.3 Die Warenlieferungen können auch im Falle von Teillieferungen vom Käufer nicht abgelehnt werden; Teillieferungen berechtigen den Käufer nicht dazu, den Auftrag zu stornieren.
- 10.4 Dem Verkäufer kann keine Verantwortung zugeschrieben werden, und dem Käufer steht daher nichts zu, wenn die Verspätung nicht vom Verkäufer selbst abhängig ist, wie im Falle von Verspätungen seitens von Dritten, eingeschlossen Lieferanten und Unterlieferanten, wegen höherer Gewalt, wie Mobilmachungen, Aufständen, Streiks oder Arbeitersperrungen, Kriegen, Epidemien, Stilllegungen, Unglücksfällen oder Störungen an den Maschinen, Bränden, Einstürzen, Überschwemmungen, Erdbeben, zu hohen Temperaturen, meteorologischen Phänomenen und generell in jedem anderen Fall, der die komplette oder teilweise Betriebsunfähigkeit der Werke des Verkäufers oder die Einstellung oder Verlangsamung der Produktion bewirkt.
- 10.5 Der Käufer kann auf jeden Fall die Verspätung der Lieferung nicht als Grund zur Vertragsauflösung benutzen.
- 10.6 Mit Ausnahme der Angaben unter Punkt 8. bezüglich der Garantie kann der Kunde auf keinen Fall an ihn geliefertes Material zurückgeben, ohne über die ausdrückliche Genehmigung des Verkäufers zu verfügen. Falls die Genehmigung des Verkäufers für eine Materialrückgabe vorliegt, muss der Käufer, um das Recht auf Vergütung zu haben, das Material gemäß folgender Bestimmungen zurückgeben:
- Das Material darf vom Käufer nicht verwendet worden sein und muss genau so zurückgegeben werden, wie es der Käufer erhalten hat;
 - Das Material muss innerhalb von 15 (fünfzehn) Tagen ab Rechnungsdatum zurückgegeben werden;
 - Das Material muss folgendermaßen an IVAR s.p.a. zurückgegeben werden: - durch den Käufer und mit Kosten und Risiken zu Lasten des Käufers - an das Werk in Prevalle (BS), via IV Novembre, 181.
- 11. Vertragsrücktritt und Einstellen der Lieferung**
- 11.1 Im Falle von unvorhergesehenen Umständen, höherer Gewalt und zufälligen Ereignissen (hierzu als Beispiel Streiks oder Arbeitersperrungen, mangelnde oder reduzierte Versorgung mit Rohmaterialien, Transportschwierigkeiten, Kriege, Aufstände, provozierte Unterbrüche der Kommunikationsmöglichkeiten, Störungen an den Anlagen des Verkäufers, etc.) hat der Verkäufer das Recht, von der vorliegenden Vereinbarung zurückzutreten und/oder die laufende Lieferung einzustellen, wenn derartige unvorhergesehene Vorkommnisse, wo immer sie auch eintreten, den Zustand der Märkte, den Wert der Währung, die Bedingungen der italienischen Industrie erheblich verändern, oder wenn Umstände eintreten, auch endogene Umstände, die nach unanfechtbarem Urteil des Verkäufers eine nutzbringende Weiterführung des Lieferverhältnisses nicht mehr zulassen.
- 11.2 Bei selbst teilweise Ausbleiben einer Zahlung der vom Verkäufer ausgestellten Rechnungen, auch wenn sie sich auf vorhergehende bereits ausgeführte Lieferungen beziehen, behält sich der Verkäufer das Recht vor, jene Lieferungen einzustellen, die sich auf die in Ausführung befindlichen Auftragsbestätigungen beziehen.
- 11.3 In jedem in den vorliegenden, allgemeinen Vertragsbedingungen vorgesehenen Fall bezüglich eines Rücktritts vom Vertrag und/oder der Lieferaussetzung hat der Käufer kein Recht auf Vergütungen, Beiträge, Entschädigungen oder Schadenersatz.
- 12. Geistiges Eigentumsrecht**
- 12.1 Jede Zeichnung oder jedes technische Dokument im Zusammenhang mit den Produkten des Verkäufers bleibt auch nach eventueller Übermittlung an den Käufer ausschließlich Eigentum des Verkäufers und darf vom Käufer nicht verwendet, kopiert, vervielfältigt oder an Dritte weitergeleitet werden, ohne dass die schriftliche Ermächtigung des Verkäufers dazu vorliegt.
- 12.2 Das Verwenden des Markenzeichens I.V.A.R. kann vom Käufer ohne vorherige schriftliche Genehmigung des Verkäufers I.V.A.R. spa nicht verwendet werden, eine unberechtigte Nutzung des Markenzeichens kann zu Schadenersatzansprüchen führen.
- 13. Anwendbare Gesetzgebung. Jurisdiktion. Gerichtsstand**
- 13.1 Der Vertrag unterliegt der italienischen Gesetzgebung, auch wenn er mit ausländischen Käufern abgeschlossen wird, oder wenn die Produkte ins Ausland geliefert werden sollen.
- 13.2 Jeder Rechtsstreit in Bezug auf den vorliegenden Vertrag und seine Auslegung und/oder Ausführung unterliegt ausschließlich der italienischen Jurisdiktion und wird ausschließlich dem für das Gebiet zuständigen Gerichtsstand Brescia zugeordnet.
- 14. Datenschutzgesetz**
- 14.1 Der Käufer bewilligt die Verarbeitung der personenbezogenen Daten, und erklärt, dass diesbezügliche Informationsschreiben erhalten zu haben, das vom Art. 13/14 der Verordnung (EU) 2016/679 (Datenschutz Grundverordnung) vorgesehen ist. Dies kann auf unserer Website https://pim.ivar-group.com/short/Client_supplier_Privacy_Policy konsultiert werden.
- 14.2 Inhaber der Verarbeitung der personenbezogenen Daten des Käufers ist die Firma IVAR s.p.a., mit Sitz in Prevalle (BS), Via IV Novembre, 181.
- 14.3 Der Käufer kann seine Rechte jederzeit ausüben, indem er sich direkt an den für die Datenverarbeitung Verantwortlichen unter der E-Mail-Adresse notifiche.gdpr@ivar.it wendet.
- 14.4 IVAR s.p.a. garantiert, dass die personenbezogenen Daten des Käufers auf informative Weise und nur für die Zwecke und Auswirkungen des Kaufvertrags verwendet werden, der in diesen allgemeinen Geschäftsbedingungen geregelt ist. Die Datenverarbeitung erfolgt auf informative Weise und basiert auf dem Grundsatz des korrekten Verhaltens, der Rechtmäßigkeit, der Transparenz und des Schutzes der Privatsphäre, sowie der Rechte des Käufers.
- 14.5 Die Angabe der Daten ist obligatorisch, damit der Vertrag ausgeführt werden kann, sowie um den buchhaltungs- und steuertechnischen Verpflichtungen nachkommen zu können. Die eventuelle Verweigerung der Angabe dieser Daten bewirkt, dass der Vertrag durch Verschulden des Käufers nicht ausgeführt werden kann.
- 14.6 Die personenbezogenen Daten können außer an mit IVAR s.p.a. verbundenen Personen/Unternehmen (wie zum Beispiel Angestellte, Vertreter, Handelsvertreter, Filialen und /oder Sekundärwerke, etc.) an Banken, Versicherungsgesellschaften und allgemein an Berater und/oder Fachleute des Unternehmens weitergegeben werden.
- 15. Mitteilungen**
- Mit Ausnahme dessen, was in den weiteren allgemeinen Verkaufsbedingungen festgelegt ist, müssen alle Mitteilungen zwischen den Parteien schriftlich und an die im Vertrag angegebene Adresse des Empfängers übermittelt werden, das heißt an den Firmensitz des Empfängers und zwar mit Einschreibebrief mit Rückschein, per Telefax, via E-Mail, zertifizierte E-Mail oder von Hand übergeben.

Der Verkäufer (Datum, Stempel und Unterschrift)

Der Käufer erklärt, dass er nicht der „Benutzer“ ist, was die Anwendung der Vorschriften und Gesetze und/oder Verordnungen in Bezug auf das Verhältnis zwischen den Unternehmen und den Konsumenten ausschließt, und dass er gemäß der Artikel 1341 und 1342 des italienischen Zivilgesetzbuchs folgenden Klauseln besondere Aufmerksamkeit geschenkt hat:

- 2. Entstehung und Ausführung des Vertrags.
- 4. Zahlungsweise; Verlust der Fristbegünstigung (4.4); einseitiger Rücktritt; Verzugszinsen; Annahme der Rechnung und Schuldanerkennung (4.7).
- 6. Waren- und Risikoübergabe;
- 7. Transport und Verpackung; Verantwortung für Verlust und Beschädigungen.
- 8. Vertragsgarantie und Haftungsbeschränkung
- 9. Reklamationen.
- 10. Liefertermine und Rückerstattung der Ware; Haftungsbeschränkung.
- 11. Vertragsrücktritt und Einstellen der Lieferung;
- 13. Anwendbare Gesetzgebung. Jurisdiktion. Gerichtsstand;

und dass er sie ausdrücklich annimmt, indem er zur Kenntnis nimmt und akzeptiert, dass die Ausführung des Auftrags von Seiten der Firma IVAR s.p.a. eine ausnahmslose Anwendung der vorliegenden allgemeinen Verkaufsbedingungen mit sich bringt.

Der Verkäufer (Datum, Stempel und Unterschrift)

1. Premisas

- 1.1 Los contratos de venta estipulados por IVAR s.p.a. (de aquí en adelante el “vendedor), en el ejercicio su actividad empresarial, están regulados por las presentes condiciones generales de contrato, salvo excepciones resultantes de acuerdo escrito y aprobadas expresamente por escrito por el Departamento comercial del vendedor.
- 1.2 Las posibles condiciones generales del comprador y, en concreto, las condiciones de compra, no se aplicarán a los contratos de venta estipulados por el vendedor si no se han aceptado explícitamente por parte del Departamento comercial del vendedor; en tal caso, sin embargo, y salvo excepción escrita, dichas condiciones no excluirán la eficacia de estas condiciones generales de contrato.
- 1.3 La posible nulidad y/o ineficacia de una o varias disposiciones de estas condiciones generales de venta no influye sobre la validez del contrato en su conjunto.
- 1.4 Estas condiciones generales de venta se entienden leídas y aceptadas integralmente por el comprador con la concesión del pedido de compra.

2. Formación del contrato y su ejecución

- 2.1 Los pedidos y/o los compromisos asumidos por los representantes, agentes y/u otros colaboradores del vendedor no tienen ningún poder para vincular al vendedor mismo; de ello resulta que todos los pedidos gestionados por dichos representantes, agentes o colaboradores adquieren validez y eficacia sólo tras la confirmación escrita del Departamento comercial del vendedor.
- 2.2 Cualquier modificación del pedido será válida y vinculará al vendedor sólo tras la aprobación escrita del Departamento comercial del vendedor.
- 2.3 La ejecución del contrato podrá ser suspendida en cualquier momento en caso de que cambien las condiciones patrimoniales del comprador, con arreglo a los efectos del art. 1461 del Código Civil italiano, salvo el resarcimiento del daño. Se atribuye al vendedor la facultad de solicitar garantías de pago idóneas, también durante la ejecución del pedido o del contrato. La no presentación de las garantías solicitadas constituirá motivo de rescisión del contrato con arreglo al art.1456 del Código Civil italiano.

3. Catálogos y listados de precios

- 3.1 Los datos, las medidas, los artículos, los precios, las características, las prestaciones y todos los demás datos presentes en los catálogos, listados de precios, folletos, circulares, etc. del vendedor tienen un carácter indicativo; pueden variar sin ningún preaviso y tienen valor vinculante para el vendedor únicamente en caso de indicación expresa de aceptación/confirmación del pedido.
- 3.2 Los listados de precios no constituyen una oferta; son puramente indicativos y el vendedor puede modificarlos de forma unilateral sin preaviso.
- 3.3 Los precios se consideran normalmente, salvo acuerdos diferentes, “franco fábrica del vendedor – exw”, embalaje incluido. Por lo tanto, se consideran a cargo del comprador los impuestos y los derechos vigentes en el momento de la entrega. Los precios no comprenden prestaciones y cargas no mencionadas.
- 3.4 Los gastos de seguro de la mercancía son a cargo del comprador, como también los posibles gastos y derechos arancelarios debidos al retraso en el despacho aduanero o por otras causas.

4. Modos de pago; pérdida del beneficio del plazo; resolución unilateral; intereses de demora; aceptación de la factura y reconocimiento de la deuda

- 4.1 Salvo excepciones escritas, todos los pagos deben realizarse en la sede del vendedor y en Euros. Las letras de cambio u otros medios de pago acordados no conllevan de ninguna manera cambios o excepciones a esta norma.
- 4.2 Los precios que aparecen en el listado de precios del vendedor se consideran al neto de I.V.A., que se aplicará a la tasa vigente en el momento de la fecha de facturación.
- 4.3 Para todo día de retraso respecto al plazo de pago acordado, se contarán los intereses de mora con arreglo al Decreto Ley 231/2002.
- 4.4 En caso de pago diferido o por plazos del importe de la factura, el incumplimiento de un plazo conlleva la pérdida automática del beneficio del plazo, la exigibilidad inmediata de todo el pago y la aplicación de los intereses de demora con arreglo al DLgs 231/2002.
- 4.5 caso de quiebra o de admisión del comprador a procedimientos de insolvencia y, asimismo, en caso de sujeción del comprador a procedimientos ejecutivos y/o de protestos, las deudas del comprador se consideran exigibles inmediatamente y el vendedor tendrá la facultad de rescindir el contrato, con arreglo al art. 1373 del Código Civil italiano, mediante el envío de carta certificada con acuse de recibo o de correo electrónico certificado (P.E.C.).
- 4.6 En el caso de que se haya acordado una compensación bancaria, son a cargo del comprador tanto los intereses de descuento como los gastos y comisiones correspondientes; los intereses se contarán al tipo oficial de descuento con el aumento de tres unidades. En caso de falta de pago o falta de aceptación de un efecto bancario, las sumas debidas serán exigibles inmediatamente sean cuales sean las condiciones acordadas previamente.
- 4.7 Una vez transcurridos de diez (10) días a partir de la recepción de la factura, sin que se haya presentado ninguna contestación escrita de cualquier tipo por parte del comprador en relación a la suma de dinero en ella indicada, dirigida al Departamento comercial del vendedor, se considerará que se ha producido el reconocimiento de la deuda por parte del cliente con arreglo al art. 1988 del Código Civil italiano.

5. Puesta a disposición “franco fábrica del vendedor - exw” y envío de la mercancía

El vendedor comunicará al comprador, mediante carta y/o telegrama y/o fax y/o e-mail y/o correo certificado (P.E.C.), la fecha de puesta a disposición de la mercancía en la fábrica del vendedor. En el caso de que el comprador no recoja la mercancía en la fábrica del vendedor antes de diez (10) días a partir de dicha comunicación, el vendedor procederá a enviar la mercancía a la sede del comprador especificada por el mismo. En caso de envío con retraso que no dependa de cuestiones propias, el vendedor tendrá la facultad del cargar al comprador los posibles gastos de almacenamiento, mantenimiento, custodia y seguro de la mercancía.

6. Entrega y transferencia de los riesgos

La entrega del material se considera efectuada “franco fábrica del vendedor – exw” y “franco a bordo”. Toda responsabilidad del vendedor cesa con la entrega al comprador o al transportista; resulta de ello que el material viaja a riesgo y peligro del comprador. En el caso de que el material se haya vendido “entregado franco en el punto de destino” por acuerdos específicos que hayan intervenido con el comprador, no se aceptarán en cualquier caso reclamaciones por posibles robos, daños o alteraciones. Los posibles acuerdos con el transportista, incluidos en ellos el monto y el pago del precio de transporte, se entenderán siempre concluidos en nombre y por cuenta del comprador, que desde ahora acepta y ratifica el obrar del vendedor.

7. Transporte y embalajes; responsabilidad por pérdidas y averías

- 7.1 La responsabilidad de la gestión del transporte del material desde la fábrica del vendedor hasta el lugar de destino se entiende normalmente a cargo del comprador, salvo acuerdo diferente que resulte en la confirmación del pedido. En todos los casos, los gastos de transporte corren a cargo del comprador. El comprador asume todos los riesgos inherentes al transporte desde la entrega del material al transportista o camionero, incluso en caso de reserva del derecho de propiedad.
- 7.2 El vendedor se encargará del embalaje según las reglas de uso. El vendedor queda exonerado de toda responsabilidad por pérdidas o fallos que no dependan del dolo o culpa grave del vendedor y que no sean consecuencia directa e inmediata de su conducta. Para tipos de embalaje específicos, se incluirán en la factura los precios extra indicados en el listado de precios, de estar presentes, o en la confirmación del pedido.

8. Garantía convencional y limitaciones de responsabilidad

- 8.1 Todos los productos del vendedor se prueban cuidadosamente en la fábrica; así están cubiertos por la garantía durante un período de diez años a partir de la fecha de emisión de la factura, a excepción de los componentes electrónicos, que están cubiertos por la garantía durante un período de dos años a partir de la fecha de la factura.
- 8.2 La garantía del vendedor se limita a la sustitución pura y simple de la pieza defectuosa, que tiene que haberse devuelto previamente al vendedor (y están por tanto excluidas taxativamente de la cobertura de la garantía los posibles gastos, daños, intereses o indemnización de todo tipo). En todo caso, las piezas de fabricación del vendedor reconocidas por él mismo como defectuosas, previa reclamación formulada por el comprador antes del plazo máximo previsto por la normativa en vigor, serán sustituidas sólo y exclusivamente por parte del vendedor. Queda entendido, de todas formas, que la responsabilidad del vendedor se limita a los defectos que se manifiesten en las condiciones de empleo normal y a lo largo de un uso correcto del producto.
- 8.3 Cualquier daño a personas, cosas y/o animales provocado por el mal funcionamiento del producto debe notificarse antes de veinticuatro (24) horas, comunicando el nombre de la persona afectada y la cuantía aproximada del daño. Deberán enviarse sucesivamente las fotografías que comprueben el daño, junto con el producto que ha provocado el daño lamentado para el examen de laboratorio. Todo lo que pueda evidenciar la entidad del daño tiene que mantenerse a disposición del vendedor hasta el cierre del expediente. Cualquier intervención de restablecimiento, llevada a cabo sin la documentación fotográfica preventiva del daño, conllevará a la pérdida del derecho de garantía con el vendedor.
- 8.4 El vendedor declina toda responsabilidad por posibles daños a personas, animales o cosas que deriven del uso de los productos sin el cumplimiento de las disposiciones de seguridad o de todas formas no instalados correctamente y/o instalados sin realizar los controles de uso debidos.

9. Reclamaciones

- 9.1 El comprador debe examinar con atención la mercancía en el momento de su recepción y comunicar detalladamente al vendedor, antes de ocho (8) días a partir de la entrega/recepción, posibles vicios y/o problemas de calidad encontrados en el producto. En el caso de que el comprador no realice dicha comunicación según los plazos recién indicados, el producto se considerará aceptado definitivamente y conforme al pedido; dejando en firme la posibilidad, antes de un (1) año a partir de la entrega del producto bajo pena de prescripción de la acción, de denunciar posibles vicios ocultos y/o la falta de calidad antes del plazo de vencimiento de ocho (8) días a partir de descubrir los mismos con arreglo a lo previsto por los artículos 1495 y 1497 del Código Civil.
- 9.2 Las posibles reclamaciones y/o contestaciones acerca de vicios o problemas de calidad del producto no atribuirán al comprador el derecho de omitir o retrasar los pagos del suministro.

- 9.3 Las reclamaciones y/o quejas relativas a vicios o problemas de calidad del producto deberán enviarse únicamente al Departamento Comercial del vendedor, rellenando en todas sus partes el formulario "CLAIM REQUEST FORM", que es posible descargar online pim.ivar-group.com/Segnalazione_reclami/Segnalazione_reclami_en.pdf.
- 9.4 Para una gestión de la reclamación rápida y correcta, es fundamental comunicar toda la información detallada relativa a los defectos y/o a los problemas de calidad objeto de la reclamación misma.
- 9.5 En el caso de que los productos devueltos al vendedor no presenten los vicios y/o los problemas de calidad contestados por el comprador, éste deberá pagar al vendedor la suma establecida del 10% del valor de la mercancía a modo de reembolso de los gastos derivados de la gestión del procedimiento de reclamación.

10. Términos de entrega y devolución de la mercancía; limitación de responsabilidad

- 10.1 El plazo de entrega establecido entre las partes tiene validez a partir del día siguiente al día en que se llegue a un acuerdo sobre todos los elementos del contrato y el vendedor haya recibido toda la información necesaria para realizar la entrega. Queda entendido que los plazos de entrega indicados en las ofertas del vendedor y/o en las confirmaciones de los pedidos son puramente indicativos y no vinculantes.
- 10.2 En el caso de que se requiera una licencia de importación por parte del país comprador, el plazo de entrega tendrá efecto a partir del momento en que el vendedor ha sido informado por escrito de que se ha obtenido la concesión de la licencia.
- 10.3 La entrega de la mercancía, incluso parcial, no puede ser rechazada por el comprador; las entregas parciales de mercancía no atribuyen al comprador el derecho de cancelar el pedido.
- 10.4 No podrá atribuirse ninguna responsabilidad al vendedor, y nada se deberá por tanto al comprador, allí donde el retraso en la entrega no pueda imputarse al vendedor, como en caso de retraso de terceros, incluidos proveedores y subcontratistas, causas de fuerza mayor como movilizaciones, motines, huelgas o cierres patronales, guerras, epidemias, cierre, accidentes o fallos a las máquinas o herramientas, incendios, hundimientos, inundaciones, terremotos, temperaturas excesivas, eventos meteorológicos y cualquier otro caso en general que conlleve la inactividad total o parcial de las fábricas del vendedor o la parada o la ralentización de la producción.
- 10.5 De todas formas, el comprador no podrá valerse del retraso en la entrega para rescindir el contrato.
- 10.6 A excepción de lo previsto en el número 8 en tema de garantía, el cliente no podrá devolver material entregado por ninguna razón sin la autorización expresa y escrita del vendedor. En el caso de obtener la autorización para la devolución, el comprador tendrá que devolver el material según los siguientes modos, para tener derecho al reembolso del pago efectuado para la compra:
- el material no habrá sido utilizado por el comprador y tendrá que devolverse en las mismas condiciones en las que lo recibió;
 - la devolución del material tendrá que producirse antes de quince (15) días a partir de la fecha de la factura de compra;
 - el material tendrá que devolverse a I.V.A.R. S.p.A. - a cargo, gastos y riesgo del comprador - en la sede de Prevalle (BS), via IV Novembre, 181.

11. Renuncia y suspensión del suministro

- 11.1 En el caso de que eventos imprevistos, fuerza mayor o caso fortuito (como, por ejemplo, huelgas y cierres patronales, falta de suministro o suministro reducido de materias primas, dificultad de transporte, guerras, insurrecciones, interrupciones de la comunicación sin depender de como hayan sido provocadas, averías en las instalaciones del vendedor, etc.), el vendedor tendrá la facultad de renunciar al presente acuerdo y/o suspender el suministro en curso cuando dichos eventos imprevistos, sea cual sea el lugar donde se produzcan, alteren de manera sustancial el estado de los mercados, el valor de la divisa, las condiciones de la industria italiana, o se produzcan circunstancia incluso endógenas que, a juicio incuestionable del vendedor, no permitan la continuación útil del suministro.
- 11.2 En caso de incumplimiento del pago, incluso parcial, de las facturas emitidas por el vendedor, también para suministros de productos anteriores o ya efectuados, el vendedor se reserva el derecho de suspender los suministros de productos relativos a las confirmaciones de pedido en curso de ejecución.
- 11.3 En todo caso de resolución del contrato y/o suspensión del suministro de material, tal como está previsto por estas condiciones generales del contrato, el comprador no tendrá derecho a indemnizaciones, compensaciones, reembolsos o resarcimiento de daños.

12. Derechos de propiedad intelectual

- 12.1 Cualquier plano o documento técnico correspondiente a los productos del vendedor, incluso si entregado al comprador, sigue siendo de propiedad exclusiva del vendedor y el comprador no puede usarlo, copiarlo, reproducirlo, transmitirlo o comunicarlo a terceros sin la autorización previa y escrita del vendedor.
- 12.2 Cualquier uso de la marca I.V.A.R. por parte del comprador debe ser previamente autorizado por escrito por el vendedor, bajo pena de compensación por daños y perjuicios por el uso indebido de la marca.

13. Ley aplicable. Jurisdicción. Juzgado competente

- 13.1 El contrato, incluso en caso de que se estipule con compradores de nacionalidad extranjera y en caso de productos suministrados en el extranjero, estará disciplinado por la Ley italiana.
- 13.2 Toda controversia correspondiente a este contrato y a su interpretación y/o ejecución está sujeta a la jurisdicción exclusiva italiana y se atribuye en vía exclusiva a la competencia territorial del Juzgado de Brescia.

14. Código sobre la Intimidad

- 14.1 El comprador consiente al tratamiento de sus datos de carácter personal, reconociendo haber recibido la nota informativa prevista por los Arts. 13 y 14 del Reglamento (UE) 2016/679 (Reglamento general de protección de datos) que está disponible en nuestro sitio web https://pim.ivar-group.com/short/Client_supplier_Privacy_Policy
- 14.2 El titular del tratamiento de los datos del comprador es la sociedad I.V.A.R. s.p.a., con sede en Prevalle (BS), Via IV Novembre, 181.
- 14.3 El comprador podrá ejercer en todo momento los derechos, contactando directamente al titular del tratamiento en la dirección de correo electrónico: notifiche.gdpr@ivar.it
- 14.4 I.V.A.R. s.p.a. garantiza que los datos de carácter personal del comprador se tratarán de forma automatizada sólo para el fin y los efectos del contrato de venta regulado por estas condiciones generales de contrato. El tratamiento se llevará a cabo de forma automatizada y se caracterizará por los principios de corrección, licitud, transparencia, de protección de la intimidad y de los derechos del comprador.
- 14.5 La concesión de los datos es obligatoria para dar curso a la ejecución del contrato y para cumplir con las obligaciones contables y fiscales; el posible rechazo a facilitar dichos datos llevará a la imposibilidad de ejecutar el contrato por culpa del comprador.
- 14.6 Los datos personales podrán ser comunicados, además que a los sujetos vinculados con la sociedad I.V.A.R. s.p.a. (por ej. empleador, agentes, proveedores, filiales y/o sedes secundarias, etc.), a bancos, compañías de seguros y de todas formas, en general, a asesores y/o profesionales de la misma sociedad.

15. Comunicaciones

Excepto para lo previsto diversamente en las demás condiciones generales de venta, todas las comunicaciones entre las partes tendrán que realizarse por escrito y enviarse a la dirección del destinatario indicado en el contrato o bien en la sede legal del destinatario por medio de carta certificada con acuse de recibo, telefax, correo electrónico, correo electrónico certificado (P.E.C.) o entrega a mano.

El Comprador (fecha, sello y firma)

El comprador, al dar acto de no ostentar la calidad de "consumidor", con la consiguiente exclusión de la aplicación de las disposiciones y disciplinas de ley y/o de reglamento relativas a las relaciones entre empresarios y consumidores, declara haber prestado especial atención a las siguientes cláusulas con arreglo a los artículos 1341 y 1342 del Código Civil italiano:

- 2. Formación del contrato y su ejecución;
- 4. Modos de pago; pérdida del beneficio del plazo (4.4.); resolución unilateral (4.5.); intereses de demora; aceptación de la factura y reconocimiento de la deuda (4.7.);
- 6. Entrega y transferencia de los riesgos;
- 7. Transporte y embalajes; responsabilidad por pérdidas y averías (7.2.);
- 8. Garantía convencional y limitaciones de responsabilidad;
- 9. Reclamaciones.
- 10. Términos de entrega y devolución de la mercancía; limitación de responsabilidad (9.4.);
- 11. Renuncia y suspensión del suministro;
- 13. Ley aplicable. Jurisdicción. Juzgado competente;

y de aprobarlas específicamente, reconociendo que la ejecución del pedido por parte de I.V.A.R. s.p.a. conlleva la aplicación integral de estas condiciones generales de venta.

El Comprador (fecha, sello y firma)

A large grid of small orange dots, intended for taking notes.

A large grid of small orange dots for taking notes.

IVAR APP

is always with you.



I.V.A.R. S.p.A.

Via IV Novembre, 181

25080 Prevalle (BS) - Italy

T. +39 030 68028 - F. +39 030 6801329

www.ivar-group.com - info@ivar-group.com

follow us:

