

SISTEMA
NIRON

SISTEMA
NIRON PREMIUM

**Tuberías y accesorios
de PP-R & PP-R CT**

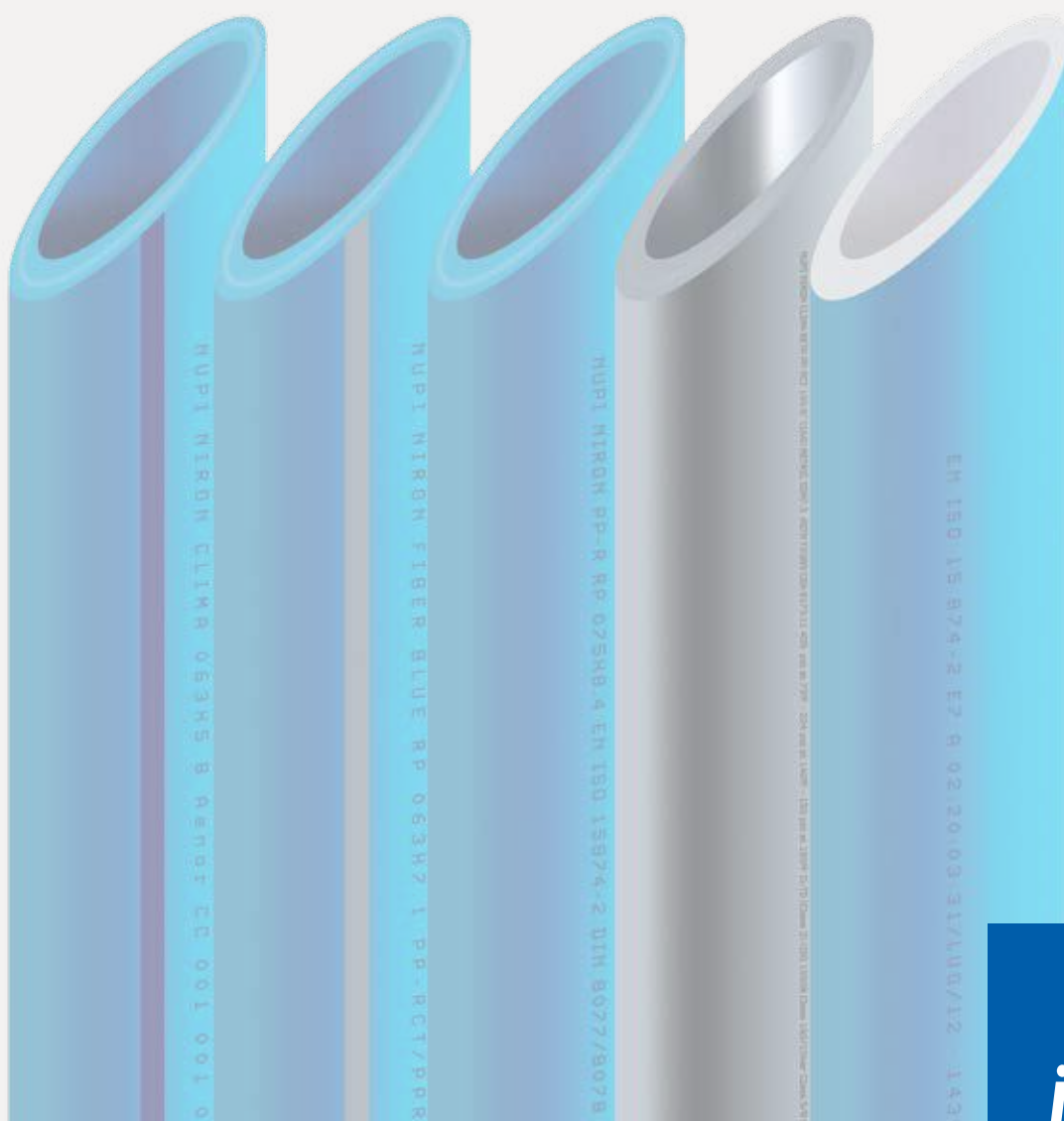

italsan

Tarifa PVP 2022

Ed. Enero

Calidad e innovación

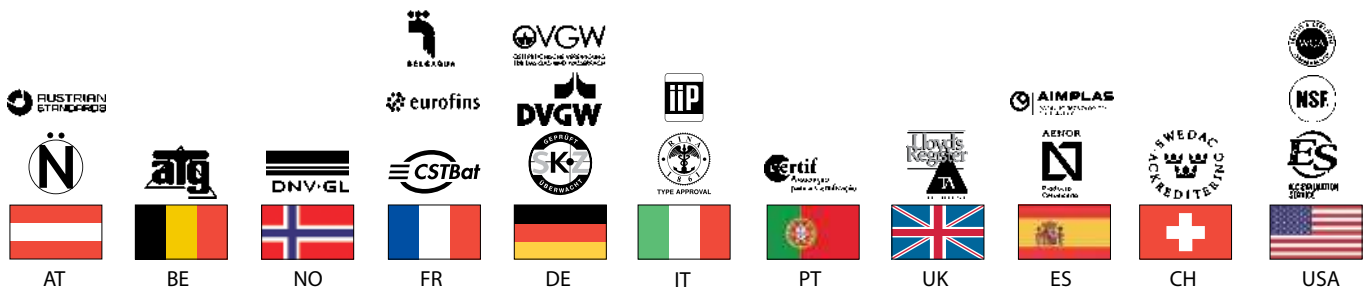

El “alma máter” de la empresa

Investigación, innovación, calidad, control y servicio nos han permitido lograr el mayor reconocimiento internacional.

La totalidad de los sistemas de tubería y accesorios se fabrican con las técnicas de producción más modernas y comercializan bajo distintas marcas, dando una solución técnica para todo tipo de instalación.

La garantía de calidad de nuestros productos queda reflejada en los certificados obtenidos y ensayos superados conforme a las normativas exigidas en los 5 continentes.



Indice

Sistema de tuberías y accesorios Sistema NIRON

5

Gamas de tubería

33

Accesorios
electrosoldables

41

Accesorios termofusión

63

Accesorios termofusión
roscados

73

Llaves y válvulas

79

Portabridas

Sistema de tuberías y accesorios Sistema NIRON PREMIUM

85

Tubería

89

Manguitos electrosoldables

91

Accesorios termofusión

101

Accesorios roscados

107

Llaves

109

Portabridas

Artículos comunes

111

Válvulas

115

Bridas

119

Abrazaderas

123

Collares de derivación

127

Herramientas

131

Máquinas

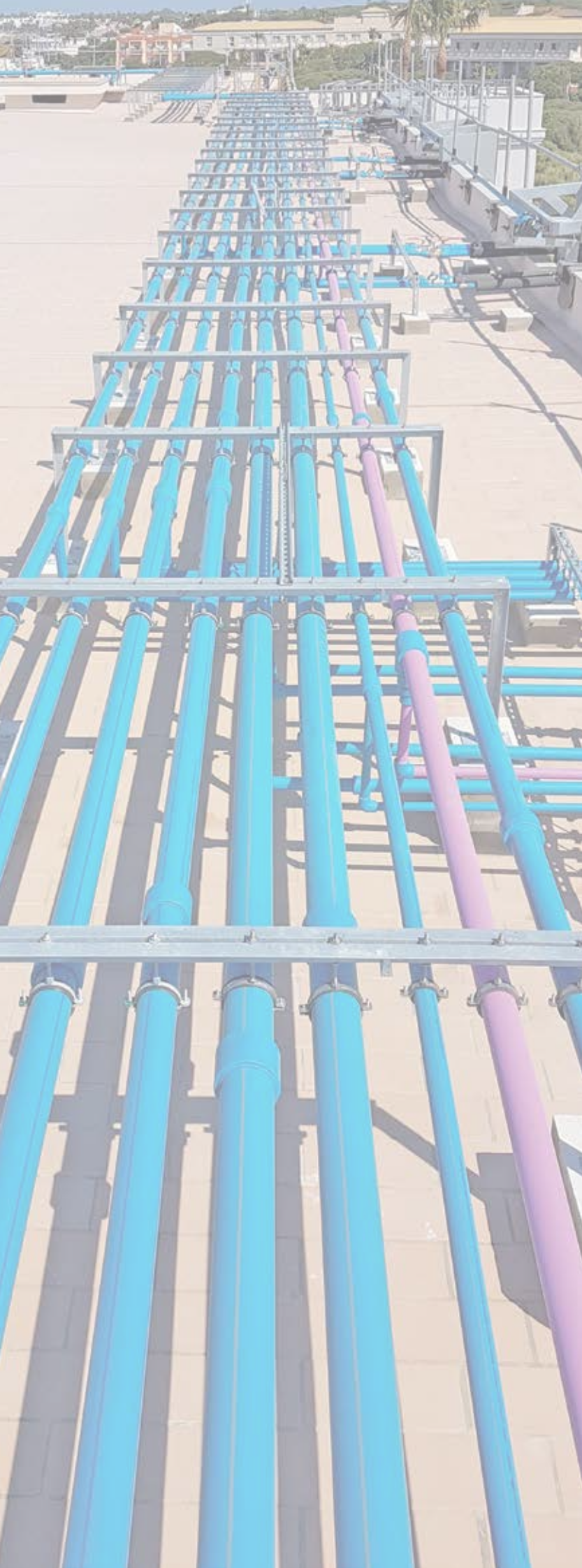

Tubería



Agua potable



Instalaciones
hidrosanitarias



Salas de
calderas



Instalaciones
climatización



Calefacción a
alta y baja
temperatura



Aplicaciones
de geotermia



Construcción
naval



Trasiego
productos
químicos



Aire
comprimido



Resistente
a radiación
UV DIRECTA



Aguas
recuperadas

Indice



Tubería Monocapa PP-R RP - Raised Pressure

Tubería monocapa RP SDR9/Serie 4



Descripción

- Tubo monocapa PP-R RP SDR9/SERIE 4
- Clase 1/8, clase 2/8
- Clase 4/8, clase 5/6

Suministro:

- En barras de 4 metros

Aplicaciones



Referencia	Ø	Espesor (mm)	L (m)	Metros/Bolsa	Palet (m)	Precio (€/m)
TNIRRRP2074 *	20 mm	2,8	4	100	3000	2,04
TNIRRRP2574 *	25 mm	3,5	4	100	2000	2,81
TNIRRRP329	32 mm	3,6	4	60	1320	4,51
TNIRRRP409	40 mm	4,5	4	40	800	7,17
TNIRRRP509	50 mm	5,6	4	20	560	10,78
TNIRRRP639	63 mm	7,1	4	16	352	16,71
TNIRRRP759	75 mm	8,4	4	12	240	23,88
TNIRRRP909	90 mm	10,1	4	8	160	41,04
TNIRRRP1109	110 mm	12,3	4	8	112	55,75
TNIRRRP1259	125 mm	14,0	4	4	80	71,49
TNIRRRP1609	160 mm	17,9	4	4	48	118,88
TNIRRRP2009	200 mm	22,4	4	4	32	181,58
TNIRRRP2509	250 mm	27,9	4	4	20	280,50
TNIRRRP3159	315 mm	35,2	4	4	12	465,74
TNIRRRP3559	355 mm	39,7	4	4	12	583,61

*** Descripción**

- Tubo monocapa PP-R RP SDR7,4/SERIE 3,2
- Clase 1/10, clase 2/10, clase 4/10, clase 5/8

Suministro:

- En barras de 4 metros



Tubería Monocapa PP-R RP - Raised Pressure

Presiones de servicio tubería monocapa RP SDR9/SERIE 4

Clase	NIRON Monocapa RP SDR9/Serie 4		NIRON Monocapa RP SDR7,4/Serie 3,2		
	1	8	10	10	
	2	8	10	10	
	4	8	10	10	
	5	6	8	8	
T máxima fluido (°C)	Años en ejercicio continuo	Presión servicio (bar)	Presión servicio (bar)	Presión servicio (bar)	Presión servicio (bar)
		Circuito abierto	Circuito cerrado	Circuito abierto	Circuito cerrado
10	1	24,0	28,8	30,2	36,2
	5	23,3	28,0	29,3	35,2
	10	22,9	27,5	28,9	34,7
	25	22,6	27,1	28,4	34,1
	50	22,3	26,8	28,0	33,6
20	1	20,8	25,0	26,3	31,6
	5	20,2	24,2	25,4	30,5
	10	19,9	23,9	25,1	30,1
	25	19,6	23,5	24,6	29,5
	50	19,3	23,2	24,3	29,2
30	1	18,1	21,7	22,7	27,2
	5	17,4	20,9	22,0	26,4
	10	17,2	20,6	21,7	26,0
	25	16,8	20,2	21,2	25,4
	50	16,6	19,9	20,9	25,1
40	1	15,5	18,6	19,6	23,5
	5	15,0	18,0	18,9	22,7
	10	14,8	17,8	18,6	22,3
	25	14,4	17,3	18,2	21,8
	50	14,3	17,2	17,9	21,5
50	1	13,3	16,0	16,7	20,0
	5	12,8	15,4	16,1	19,3
	10	12,6	15,1	15,8	19,0
	25	12,3	14,8	15,5	18,6
	50	12,1	14,5	15,2	18,2
60	1	11,3	13,6	14,2	17,0
	5	10,8	13,0	13,6	16,3
	10	10,6	12,7	13,4	16,1
	25	10,3	12,4	13,1	15,7
	50	10,2	12,2	12,8	15,4
70	1	9,4	11,3	11,9	14,3
	5	9,1	10,9	11,4	13,7
	10	8,9	10,7	11,2	13,4
	25	8,7	10,4	10,9	13,1
	50	8,5	10,2	10,7	12,8
80	1	7,9	9,5	9,9	11,9
	5	7,5	9,0	9,5	11,4
	10	7,4	8,9	9,3	11,2
	25	7,2	8,6	9,1	10,9
95	1	5,9	7,1	7,4	8,9
	5	5,6	6,7	7,1	8,5

Circuito abierto: Coeficiente de seguridad aplicado del 1,5 según norma UNE-EN ISO 15874

Circuito cerrado: Coeficiente de seguridad aplicado del 1,25 según norma DIN 8077/78

Tubería Monocapa PP-R

Tubería monocapa SDR6/Serie 2,5 (PN20)



Descripción

-Tubo monocapa SDR6/SERIE 2,5
-Clase 1/10 bar, clase 2/8 bar,
clase 4/10 bar, clase 5/6 bar

Suministro:

-En barras de 4 metros

Aplicaciones



Referencia	Ø	Espesor (mm)	L (m)	Metros/Bolsa	Palet (m)	Precio (€/m)
TNIRR16	16 mm	2,7	4	100	4600	1,62
TNIRR20	20 mm	3,4	4	100	3000	1,84
TNIRR25	25 mm	4,2	4	100	2000	3,31
TNIRR32	32 mm	5,4	4	60	1320	5,30
TNIRR40	40 mm	6,7	4	40	800	8,61
TNIRR50	50 mm	8,4	4	20	560	12,74
TNIRR63	63 mm	10,5	4	16	352	18,95
TNIRR75	75 mm	12,5	4	12	240	31,23
TNIRR90	90 mm	15,0	4	8	160	46,25
TNIRR110	110 mm	18,4	4	8	112	71,41
TNIRR125	125 mm	20,8	4	4	80	90,86
TNIRR160	160 mm	26,6	4	4	48	152,22

Tubería Monocapa PP-R

Presiones de servicio tubería monocapa SDR6/SERIE 2,5

NIRON Monocapa RP SDR6/Serie 2,5

Clase	1	10	
	2	8	
	4	10	
	5	6	
T máxima fluido (°C)	Años en ejercicio continuo	Presión servicio (bar)	Presión servicio (bar)
		Circuito abierto	Circuito cerrado
10	1	35,0	42,0
	5	33,2	39,8
	10	32,1	38,5
	25	31,1	37,3
	50	30,3	36,4
20	1	30,0	36,0
	5	28,1	33,7
	10	27,3	32,8
	25	26,5	31,8
	50	25,7	30,8
30	1	25,5	30,6
	5	23,9	28,7
	10	23,1	27,7
	25	22,3	26,8
	50	21,8	26,2
40	1	21,5	25,8
	5	20,2	24,2
	10	19,6	23,5
	25	18,8	22,6
	50	18,3	22,0
50	1	18,3	22,0
	5	17,0	20,4
	10	16,5	19,8
	25	15,9	19,1
	50	15,4	18,5
60	1	15,4	18,5
	5	14,3	17,2
	10	13,8	16,6
	25	13,3	16,0
	50	12,7	15,2
70	1	13,0	15,6
	5	11,9	14,3
	10	11,7	14,0
	25	10,1	12,1
	50	8,5	10,2
80	1	10,9	13,1
	5	9,6	11,5
	10	8,0	9,6
	25	6,4	7,7
95	1	7,7	9,2
	5	5,0	6,0

Circuito abierto: Coeficiente de seguridad aplicado del 1,5 según norma UNE-EN ISO 15874

Circuito cerrado: Coeficiente de seguridad aplicado del 1,25 según norma DIN 8077/78

Tubería Monocapa PP-R

Tubería monocapa SDR7,4/Serie 3,2 (PN16)



Descripción

-Tubo monocapa SDR7,4/SERIE 3,2
-Clase 1/8 bar, clase 2/6 bar,
clase 4/10 bar, clase 5/6 bar

Suministro:

-En barras de 4 metros

Aplicaciones



Referencia	Ø	Espesor (mm)	L (m)	Metros/Bolsa	Palet (m)	Precio (€/m)
TNIRR2516	25 mm	3,5	4	100	2000	2,95
TNIRR3216	32 mm	4,4	4	60	1320	4,73
TNIRR4016	40 mm	5,5	4	40	800	7,55
TNIRR5016	50 mm	6,9	4	20	560	11,28
TNIRR6316	63 mm	8,7	4	16	352	17,59
TNIRR7516	75 mm	10,4	4	12	240	25,13
TNIRR9016	90 mm	12,5	4	8	160	42,90
TNIRR11016	110 mm	15,2	4	8	112	58,80
TNIRR12516	125 mm	17,1	4	4	80	75,03
TNIRR16016	160 mm	21,9	4	4	48	124,26

Tubería Monocapa PP-R

Presiones de servicio tubería monocapa SDR7,4/SERIE 3,2

NIRON Monocapa SDR7,4/Serie 3,2

Clase	1	8		
	2	6		
	4	10		
	5	6		
T máxima fluido (°C)	Años en ejercicio continuo	Presión servicio (bar)	Presión servicio (bar)	
		Circuito abierto	Circuito cerrado	
10	1	27,8	33,4	
	5	26,4	31,7	
	10	25,5	30,6	
	25	24,7	29,6	
	50	24,0	28,8	
20	1	23,8	28,6	
	5	22,3	26,8	
	10	21,7	26,0	
	25	21,1	25,3	
	50	20,4	24,5	
30	1	20,2	24,2	
	5	19,0	22,8	
	10	18,3	22,0	
	25	17,7	21,2	
	50	17,3	20,8	
40	1	17,1	20,5	
	5	16,0	19,2	
	10	15,6	18,7	
	25	15,0	18,0	
	50	14,5	17,4	
50	1	14,5	17,4	
	5	13,5	16,2	
	10	13,1	15,7	
	25	12,6	15,1	
	50	12,2	14,6	
60	1	12,2	14,6	
	5	11,6	13,9	
	10	11,0	13,2	
	25	10,5	12,6	
	50	10,1	12,1	
70	1	10,3	12,4	
	5	9,5	11,4	
	10	9,3	11,2	
	25	8,0	9,6	
	50	6,7	8,0	
80	1	8,6	10,3	
	5	7,6	9,1	
	10	6,3	7,6	
	25	5,1	6,1	
	50	4,0	4,8	
95	1	6,1	7,3	
	5	4,0	4,8	

Circuito abierto: Coeficiente de seguridad aplicado del 1,5 según norma UNE-EN ISO 15874

Circuito cerrado: Coeficiente de seguridad aplicado del 1,25 según norma DIN 8077/78

Tubería Monocapa PP-R

Tubería monocapa SDR11/Serie 5 (PN10)



Descripción

- Tubo monocapa SDR11/SERIE 5
- Sólo para agua fría
- Clase 1/6 bar, clase 2/4 bar, clase 4/6 bar

Suministro:

- En barras de 4 metros

Aplicaciones



Referencia	Ø	Espesor (mm)	L (m)	Metros/Bolsa	Palet (m)	Precio (€/m)
TNIRR2510	25 mm	2,3	4	100	2000	2,34
TNIRR3210	32 mm	2,9	4	60	1320	3,87
TNIRR4010	40 mm	3,7	4	40	800	6,00
TNIRR5010	50 mm	4,6	4	20	560	9,56
TNIRR6310	63 mm	5,8	4	16	352	14,63
TNIRR7510	75 mm	6,8	4	12	240	20,37
TNIRR9010	90 mm	8,2	4	8	160	29,52
TNIRR11010	110 mm	10,0	4	8	112	43,65
TNIRR12510	125 mm	11,4	4	8	80	56,71
TNIRR16010	160 mm	14,6	4	4	48	104,54
TNIRR20010	200 mm	18,2	4	4	32	170,77
TNIRR25010	250 mm	22,7	4	4	20	234,65
TNIRR31510	315 mm	28,6	4	4	12	383,20
TNIRR35510	355 mm	32,2	4	4	12	517,33
TNIRR40010	400 mm	36,3	4	4	8	668,20
TNIRR45010	450 mm	40,9	4	4	8	977,73

Tubería Monocapa PP-R

Presiones de servicio tubería monocapa SDR11/SERIE 5

NIRON Monocapa SDR11/Serie 5

Clase	1	6		
	2	4		
	4	6		
	5	-		
T máxima fluido (°C)	Años en ejercicio continuo	Presión servicio (bar)	Presión servicio (bar)	
		Circuito abierto	Circuito cerrado	
10	1	17,6	21,1	
	5	16,6	19,9	
	10	16,1	19,3	
	25	15,6	18,7	
	50	15,2	18,2	
20	1	15,0	18,0	
	5	14,1	16,9	
	10	13,7	16,4	
	25	13,3	16,0	
	50	12,9	15,5	
30	1	12,8	15,4	
	5	12,0	14,4	
	10	11,6	13,9	
	25	11,2	13,4	
	50	10,9	13,1	

Circuito abierto: Coeficiente de seguridad aplicado del 1,5 según norma UNE-EN ISO 15874

Circuito cerrado: Coeficiente de seguridad aplicado del 1,25 según norma DIN 8077/78

Tubería Compuesta RP PP-R RP - Raised Pressure FIBER BLUE

Tubería compuesta RP SDR9/Serie 4



Descripción

- Tubo compuesto PP-R RP+FV SDR9/SERIE 4
- Banda color gris
- Clase 1/8, clase 2/8, clase 4/8, clase 5/6

Suministro:

- En barras de 4 metros

Aplicaciones



* Con certificado de potabilidad. Apto para trasiego de agua potable hasta diámetro 400 mm incluido.

Referencia	Ø	Espesor (mm)	L (m)	Metros/Bolsa	Palet (m)	Precio (€/m)
TNIRFBRP2074 *	20 mm	2,8	4	100	3000	2,66
TNIRFBRP2574 *	25 mm	3,5	4	100	2000	3,76
TNIRFBRP329	32 mm	3,6	4	60	1320	5,84
TNIRFBRP409	40 mm	4,5	4	40	800	9,86
TNIRFBRP509	50 mm	5,6	4	20	560	14,25
TNIRFBRP639	63 mm	7,1	4	16	352	19,67
TNIRFBRP759	75 mm	8,4	4	12	240	30,33
TNIRFBRP909	90 mm	10,1	4	8	160	43,97
TNIRFBRP1109	110 mm	12,3	4	8	112	60,47
TNIRFBRP1259	125 mm	14,0	4	8	80	76,61
TNIRFBRP1609	160 mm	17,9	4	4	48	140,10
TNIRFBRP2009	200 mm	22,4	4	4	32	230,91
TNIRFBRP2509	250 mm	27,9	4	4	20	364,28
TNIRFBRP3159	315 mm	35,2	4	4	12	604,87
TNIRFBRP3559	355 mm	39,7	4	4	12	757,94

*** Descripción**

- Tubo compuesto PP-R RP+FV SDR 7,4/SERIE 3,2
- Banda color gris
- Clase 1/10, clase 2/10, clase 4/10, clase 5/8

Suministro:

- En barras de 4 metros



Tubería Compuesta RP PP-R RP - Raised Pressure FIBER BLUE

Presiones de servicio tubería compuesta RP SDR9/SERIE 4

		NIRON Compuesto RP SDR9/Serie 4		NIRON Compuesto RP SDR7,4/Serie 3,2	
Clase		8	8	10	10
		8	8	10	10
		8	8	10	10
		6	6	8	8
T máxima fluido (°C)	Años en ejercicio continuo	Presión servicio (bar)	Presión servicio (bar)	Presión servicio (bar)	Presión servicio (bar)
		Circuito abierto	Circuito cerrado	Circuito abierto	Circuito cerrado
10	1	24,0	28,8	30,2	36,2
	5	23,3	28,0	29,3	35,2
	10	22,9	27,5	28,9	34,7
	25	22,6	27,1	28,4	34,1
	50	22,3	26,8	28,0	33,6
20	1	20,8	25,0	26,3	31,6
	5	20,2	24,2	25,4	30,5
	10	19,9	23,9	25,1	30,1
	25	19,6	23,5	24,6	29,5
	50	19,3	23,2	24,3	29,2
30	1	18,1	21,7	22,7	27,2
	5	17,4	20,9	22,0	26,4
	10	17,2	20,6	21,7	26,0
	25	16,8	20,2	21,2	25,4
	50	16,6	19,9	20,9	25,1
40	1	15,5	18,6	19,6	23,5
	5	15,0	18,0	18,9	22,7
	10	14,8	17,8	18,6	22,3
	25	14,4	17,3	18,2	21,8
	50	14,3	17,2	17,9	21,5
50	1	13,3	16,0	16,7	20,0
	5	12,8	15,4	16,1	19,3
	10	12,6	15,1	15,8	19,0
	25	12,3	14,8	15,5	18,6
	50	12,1	14,5	15,2	18,2
60	1	11,3	13,6	14,2	17,0
	5	10,8	13,0	13,6	16,3
	10	10,6	12,7	13,4	16,1
	25	10,3	12,4	13,1	15,7
	50	10,2	12,2	12,8	15,4
70	1	9,4	11,3	11,9	14,3
	5	9,1	10,9	11,4	13,7
	10	8,9	10,7	11,2	13,4
	25	8,7	10,4	10,9	13,1
	50	8,5	10,2	10,7	12,8
80	1	7,9	9,5	9,9	11,9
	5	7,5	9,0	9,5	11,4
	10	7,4	8,9	9,3	11,2
	25	7,2	8,6	9,1	10,9
95	1	5,9	7,1	7,4	8,9
	5	5,6	6,7	7,1	8,5

Circuito abierto: Coeficiente de seguridad aplicado del 1,5 según norma UNE-EN ISO 15874

Circuito cerrado: Coeficiente de seguridad aplicado del 1,25 según norma DIN 8077/78

Tubería PP-R Compuesta FIBER GLASS

Tubería compuesta SDR7,4/Serie 3,2



Descripción

- Tubo compuesto PP-R + FV
- SDR7,4/SERIE 3,2
- Banda color verde
- Clase 1/8 bar, clase 2/6 bar, clase 4/10 bar, clase 5/6 bar

Suministro:

- En barras de 4 metros

Aplicaciones



Referencia	Ø	Espesor (mm)	L (m)	Metros/Bolsa	Palet (m)	Precio (€/m)
TNIRRF1674	16 mm	2,2	4	100	3000	2,43
TNIRRF2074	20 mm	2,8	4	100	3000	2,69
TNIRRF2574	25 mm	3,5	4	100	2000	3,81
TNIRRF3274	32 mm	4,4	4	60	1320	6,36
TNIRRF4074	40 mm	5,5	4	40	800	10,72
TNIRRF5074	50 mm	6,9	4	20	560	15,51
TNIRRF6374	63 mm	8,7	4	16	352	21,46
TNIRRF7574	75 mm	10,4	4	12	240	32,99
TNIRRF9074	90 mm	12,5	4	8	160	47,84
TNIRRF11074	110 mm	15,2	4	8	112	65,79
TNIRRF12574	125 mm	17,1	4	4	80	81,72
TNIRRF16074	160 mm	21,9	4	4	48	145,89

Tubería PP-R Compuesta FIBER GLASS

Presiones de servicio tubería compuesta SDR7,4/SERIE 3,2

NIRON Compuesto SDR7,4/Serie 3,2			
Clase	1	8	
	2	6	
	4	10	
	5	6	
T máxima fluido (°C)	Años en ejercicio continuo	Presión servicio (bar)	Presión servicio (bar)
		Circuito abierto	Circuito cerrado
10	1	27,8	33,4
	5	26,4	31,7
	10	25,5	30,6
	25	24,7	29,6
	50	24,0	28,8
20	1	23,8	28,6
	5	22,3	26,8
	10	21,7	26,0
	25	21,1	25,3
	50	20,4	24,5
30	1	20,2	24,2
	5	19,0	22,8
	10	18,3	22,0
	25	17,7	21,2
	50	17,3	20,8
40	1	17,1	20,5
	5	16,0	19,2
	10	15,6	18,7
	25	15,0	18,0
	50	14,5	17,4
50	1	14,5	17,4
	5	13,5	16,2
	10	13,1	15,7
	25	12,6	15,1
	50	12,2	14,6
60	1	12,2	14,6
	5	11,6	13,9
	10	11,0	13,2
	25	10,5	12,6
	50	10,1	12,1
70	1	10,3	12,4
	5	9,5	11,4
	10	9,3	11,2
	25	8,0	9,6
	50	6,7	8,0
80	1	8,6	10,3
	5	7,6	9,1
	10	6,3	7,6
	25	5,1	6,1
95	1	6,1	7,3
	5	4,0	4,8

Circuito abierto: Coeficiente de seguridad aplicado del 1,5 según norma UNE-EN ISO 15874

Circuito cerrado: Coeficiente de seguridad aplicado del 1,25 según norma DIN 8077/78

Tubería PP-R 100 Compuesto NIRON CLIMA

Tubería compuesta SDR11/Serie 5



Descripción

-Tubo compuesto PP-R 100+FV
SDR11/SERIE 5
-Banda color azul
-Clase 1/6 bar, clase 2/4 bar,
clase 4/6 bar

Suministro:

-En barras de 4 metros

Aplicaciones



* Con certificado de potabilidad y apta para trasiego de agua potable hasta diámetro 400 mm incluido.

Referencia	Ø	Espesor (mm)	L (m)	Metros/Bolsa	Palet (m)	Precio (€/m)
TNIRCL2074 *	20 mm	2,8	4	100	3000	2,26
TNIRCL2574 *	25 mm	3,5	4	100	2000	3,35
TNIRCL3211	32 mm	2,9	4	60	1320	4,60
TNIRCL4011	40 mm	3,7	4	40	800	7,32
TNIRCL5011	50 mm	4,6	4	20	560	10,27
TNIRCL6311	63 mm	5,8	4	16	352	15,84
TNIRCL7511	75 mm	6,8	4	12	240	20,77
TNIRCL9011	90 mm	8,2	4	8	160	30,06
TNIRCL11011	110 mm	10,0	4	8	112	44,83
TNIRCL12511	125 mm	11,4	4	4	80	52,78
TNIRCL16011	160 mm	14,6	4	4	48	97,82
TNIRCL20011	200 mm	18,2	4	4	32	169,19
TNIRCL25011	250 mm	22,7	4	4	20	244,21
TNIRCL31511	315 mm	28,6	4	4	12	406,16
TNIRCL35511	355 mm	32,2	4	4	12	501,92
TNIRCL40011	400 mm	36,3	4	4	12	660,61
TNIRCL45011	450 mm	40,9	4	4	8	937,49

*** Descripción**

-Tubo compuesto PP-R 100+FV
SDR 7,4/SERIE 3,2
-Banda color azul
-Clase 1/8 bar, clase 2/6 bar,
clase 4/10 bar, clase 5/6 bar

Suministro:

-En barras de 4 metros



Tubería PP-R 100 Compuesto NIRON CLIMA

Presiones de servicio tubería compuesta SDR11/SERIE 5

NIRON Compuesto SDR11/Serie 5				NIRON Compuesto SDR7,4/Serie 3,2			
Clase	1	6		Clase	1	8	
	2	4			2	6	
T máxima fluido (°C)	Años en ejer. continuo	Presión servicio (bar)		T máxima fluido (°C)	Años en ejer. continuo	Presión servicio (bar)	
		Cir. abierto	Cir. cerrado			Cir. abierto	Cir. cerrado
10	1	21,9	26,3	10	1	27,8	33,4
	5	20,7	24,8		5	26,4	31,7
	10	20,2	24,2		10	25,5	30,6
	25	19,5	23,4		25	24,7	29,6
	50	19,0	22,8		50	24,0	28,8
20	1	18,8	22,6	20	1	23,8	28,6
	5	17,7	21,2		5	22,3	26,8
	10	17,2	20,6		10	21,7	26,0
	25	16,6	19,9		25	21,1	25,3
	50	16,2	19,4		50	20,4	24,5
30	1	16,0	19,2	30	1	20,2	24,2
	5	15,0	18,0		5	19,0	22,8
	10	14,6	17,5		10	18,3	22,0
	25	14,1	16,9		25	17,7	21,2
	50	13,7	16,4		50	17,3	20,8
40	1	13,6	16,3	40	1	17,1	20,5
	5	12,8	15,4		5	16,0	19,2
	10	12,4	14,9		10	15,6	18,7
	25	11,9	14,3		25	15,0	18,0
	50	11,6	13,9		50	14,5	17,4
50	1	11,6	13,9	50	1	14,5	17,4
	5	10,8	13,0		5	13,5	16,2
	10	10,5	12,6		10	13,1	15,7
	25	10,1	12,1		25	12,6	15,1
	50	9,8	11,8		50	12,2	14,6
55	1	10,7	12,8	60	1	12,2	14,6
	5	9,9	11,9		5	11,6	13,9
	10	9,6	11,5		10	11,0	13,2
	25	9,2	11,0		25	10,5	12,6
	50	9,0	10,8		50	10,1	12,1
60	1	9,8	11,8	70	1	10,3	12,4
	5	9,1	10,9		5	9,5	11,4
	10	8,8	10,6		10	9,3	11,2
	25	8,5	10,2		25	8,0	9,6
	50	8,2	9,8		50	6,7	8,0
70	1	8,3	10,0	80	1	8,6	10,3
	5	7,7	9,2		5	7,6	9,1
	10	7,4	8,9		10	6,3	7,6
	25	6,9	8,3		25	5,1	6,1
	50	6,3	7,6		95	6,1	7,3
				5	4,0	4,8	

Circuito abierto: Coeficiente de seguridad aplicado del 1,5 según norma UNE-EN ISO 15874

Circuito cerrado: Coeficiente de seguridad aplicado del 1,25 según norma DIN 8077/78

Tubería compuesta PP-R RP - Raised Pressure NIRON CLIMA

Tubería compuesta RP SDR17/Serie 8



Descripción

- Tubo compuesto PP-R RP+FV SDR17/SERIE 8
- Banda color azul
- Clase 1/4 bar, clase 2/4 bar, clase 4/4 bar

Suministro:

- En barras de 5,8 metros

Aplicaciones



* Con certificado de potabilidad. Apto para trasiego de agua potable hasta diámetro 400 mm incluido.

Referencia	Ø	Espesor (mm)	L (m)	Metros/Bolsa	Palet (m)	Precio (€/m)
TNIRCL16017B5,8	160 mm	9,5	5,8	5,8	69,6	71,32
TNIRCL20017B5,8	200 mm	11,9	5,8	5,8	46,4	116,24
TNIRCL25017B5,8	250 mm	14,9	5,8	5,8	29,0	166,53
TNIRCL31517B5,8	315 mm	18,7	5,8	5,8	17,4	248,04
TNIRCL35517B5,8	355 mm	21,1	5,8	5,8	17,4	327,95
TNIRCL40017B5,8	400 mm	23,7	5,8	5,8	11,6	419,73



Referencia	Ø	Espesor (mm)	L (m)	Metros/Bolsa	Palet (m)	Precio (€/m)
27TNIRCL45017B5,8	450 mm	26,4	5,8	5,8	5,8	542,72
27TNIRCL50017B5,8	500 mm	29,7	5,8	5,8	5,8	685,03
27TNIRCL56017B5,8	560 mm	33,2	5,8	5,8	5,8	879,10
27TNIRCL63017B5,8	630 mm	37,4	5,8	5,8	5,8	1.189,87

Tubería compuesta PP-R RP - Raised Pressure NIRON CLIMA

Presiones de servicio tubería compuesta RP SDR17/SERIE 8

NIRON Compuesto RP SDR17/Serie 8		
Clase		
	1	4
	2	4
	4	4
	5	-
T máxima fluido (°C)	Años en ejer. continuo	Presión servicio (bar)
Circuito cerrado		
10	1	14,4
	5	14,0
	10	13,8
	25	13,5
	50	13,4
20	1	12,5
	5	12,1
	10	12,0
	25	11,7
	50	11,6
30	1	10,8
	5	10,5
	10	10,3
	25	10,1
	50	10,0
40	1	9,3
	5	9,0
	10	8,8
	25	8,7
	50	8,5
50	1	8,0
	5	7,7
	10	7,5
	25	7,4
	50	7,2
60	1	6,7
	5	6,5
	10	6,4
	25	6,2
	50	6,1
70	1	5,7
	5	5,4
	10	5,3
	25	5,2
	50	5,1

Circuito cerrado: Coeficiente de seguridad aplicado del 1,25 según norma DIN 8077/78

NIRON[®] *Clima* Cool-pro

**La nueva gama de tuberías NIRON resistente a los rayos UV.
Indicada para los circuitos de recuperación de condensados
en torres de refrigeración.**



Para más información consulta el catálogo de producto

Tubería compuesta NIRON CLIMA COOL PRO PP-RCT RA7050 CON PROTECCIÓN UV

Tubería compuesta PP-RCT RA7050 con protección de dióxido de titanio SDR11/Serie 5



Descripción

- Tubo compuesto PP-RCT RA7050+ FV SDR11/SERIE 5
- Capa externa: Capa PP-RCT aditivado con masterbath resistente a radiación UV color blanco
- Capa interna: PP-RCT RA7050+FV color gris
- Clase 1/6 bar, clase 2/6 bar, clase 4/6 bar, clase 5/4 bar

Suministro:

- En barras de 5,8 metros

Aplicaciones



Referencia	Ø	Espesor (mm)	L (m)	Metros/Bolsa	Palet (m)	Precio (€/m)
27TNIRCLUV329 *	32	3,6	5,8	5,8	-	7,87
27TNIRCLUV4011	40	3,7	5,8	5,8	-	9,58
27TNIRCLUV5011	50	4,6	5,8	5,8	-	13,92
27TNIRCLUV6311	63	5,8	5,8	5,8	-	21,68
27TNIRCLUV7511	75	6,8	5,8	5,8	-	28,85
27TNIRCLUV9011	90	8,2	5,8	5,8	-	42,98
27TNIRCLUV11011	110	10,0	5,8	5,8	-	65,85
27TNIRCLUV12511	125	11,4	5,8	5,8	-	81,15
27TNIRCLUV16011	160	14,6	5,8	5,8	-	141,97
27TNIRCLUV20011	200	18,2	5,8	5,8	-	221,61
27TNIRCLUV25011	250	22,7	5,8	5,8	-	341,36
27TNIRCLUV31511	315	28,6	5,8	5,8	-	548,47
27TNIRCLUV35511	355	32,2	5,8	5,8	-	665,97
27TNIRCLUV40011	400	36,3	5,8	5,8	-	906,64

* Descripción

- Tubo compuesto PP-RCT RA7050+ FV SDR9/SERIE 4
- Capa externa: Capa PP-RCT aditivado con masterbath resistente a radiación UV color blanco
- Capa interna: PP-RCT RA7050+FV color gris
- Clase 1/8 bar, clase 2/8 bar, clase 4/8 bar, clase 5/6 bar

Suministro:

- En barras de 5,8 metros

Tubería compuesta NIRON CLIMA COOL PRO PP-RCT RA7050 CON PROTECCIÓN UV

Presiones de servicio tubería compuesta PP-RCT SDR11/Serie 5

		NIRON Compuesta PP-RCT SDR11/Serie 5		NIRON Compuesta PP-RCT SDR9/Serie 4	
Clase	1	6		8	
	2	6		8	
	4	6		8	
	5	4		6	
T máxima fluido (°C)	Años en ejercicio continuo	Presión servicio (bar)	Presión servicio (bar)	Presión servicio (bar)	Presión servicio (bar)
		Circuito abierto	Circuito cerrado	Circuito abierto	Circuito cerrado
10	1	19,0	22,8	24,0	28,8
	5	18,4	22,1	23,2	27,9
	10	18,2	21,9	22,9	27,5
	25	17,9	21,5	22,5	27,1
	50	17,7	21,2	22,2	26,7
20	1	16,6	19,9	20,9	25,0
	5	16,0	19,3	20,2	24,2
	10	15,8	19,0	19,9	23,9
	25	15,5	18,6	19,6	23,5
	50	15,3	18,4	19,0	23,1
30	1	14,3	17,2	18,1	21,7
	5	13,9	16,6	17,4	20,9
	10	13,6	16,4	17,2	20,6
	25	13,4	16,1	16,9	20,2
	50	13,2	15,8	16,6	19,9
40	1	12,3	14,8	15,5	18,6
	5	11,9	14,3	15,0	18,0
	10	11,7	14,1	14,7	17,7
	25	11,5	13,8	14,4	17,3
	50	11,3	13,6	14,2	17,1
50	1	10,5	12,6	13,3	15,9
	5	10,1	12,2	12,8	15,3
	10	10,0	12,0	12,6	15,1
	25	9,7	11,7	12,3	14,7
	50	9,6	11,5	12,1	14,5
60	1	8,9	10,7	11,2	13,5
	5	8,6	10,3	10,8	13,0
	10	8,4	10,1	10,6	12,7
	25	8,2	9,9	10,4	12,4
	50	8,1	9,7	10,2	12,2
70	1	7,5	9,0	9,4	11,3
	5	7,2	8,6	9,1	10,9
	10	7,0	8,5	8,9	10,7
	25	6,9	8,3	8,7	10,4
	50	6,8	8,1	8,5	10,2
80	1	6,2	7,5	7,9	9,5
	5	6,0	7,2	7,5	9,5
	10	5,9	7,0	7,4	8,9
	25	5,7	6,9	7,2	8,6
95	1	4,7	5,6	5,9	7,1
	5	4,4	5,3	5,6	6,7

Circuito abierto: Coeficiente de seguridad aplicado del 1,5 según norma UNE-EN ISO 15874

Circuito cerrado: Coeficiente de seguridad aplicado del 1,25 según norma DIN 8077/78

Tubería compuesta NIRON CLIMA COOL PRO PP-RCT RA7050 CON PROTECCIÓN UV

Tubería compuesta PP-RCT RA7050 con protección de dióxido de titanio SDR17/Serie 8



Descripción

- Tubo compuesto PP-RCT RA7050+ FV SDR11/SERIE 5
- Capa externa: Capa PP-RCT aditivado con masterbath resistente a radiación UV color blanco
- Capa interna: PP-RCT RA7050+FV color gris
- Clase 1/4 bar, clase 2/4 bar, clase 4/4 bar

Suministro:

- En barras de 5,8 metros

Aplicaciones



Referencia	Ø	Espesor (mm)	L (m)	Metros/Bolsa	Palet (m)	Precio (€/m)
27TNIRCLUV16017	160	9,5	5,8	5,8	-	109,68
27TNIRCLUV20017	200	11,9	5,8	5,8	-	190,30
27TNIRCLUV25017	250	14,9	5,8	5,8	-	274,23
27TNIRCLUV31517	315	18,7	5,8	5,8	-	409,51
27TNIRCLUV35517	355	21,1	5,8	5,8	-	514,91
27TNIRCLUV40017	400	23,7	5,8	5,8	-	654,78



Tubería compuesta NIRON CLIMA COOL PRO PP-RCT RA7050 CON PROTECCIÓN UV

Presiones de servicio tubería compuesta PP-RCT SDR17/Serie 8

NIRON Compuesto RP SDR17/Serie 8		
Clase		
	1	4
	2	4
	4	4
	5	-
T máxima fluido (°C)	Años en ejer. continuo	Presión servicio (bar)
Circuito cerrado		
10	1	14,4
	5	14,0
	10	13,8
	25	13,5
	50	13,4
20	1	12,5
	5	12,1
	10	12,0
	25	11,7
	50	11,6
30	1	10,8
	5	10,5
	10	10,3
	25	10,1
	50	10,0
40	1	9,3
	5	9,0
	10	8,8
	25	8,7
	50	8,5
50	1	8,0
	5	7,7
	10	7,5
	25	7,4
	50	7,2
60	1	6,7
	5	6,5
	10	6,4
	25	6,2
	50	6,1
70	1	5,7
	5	5,4
	10	5,3
	25	5,2
	50	5,1

Circuito cerrado: Coeficiente de seguridad aplicado del 1,25 según norma DIN 8077/78

Tubería Compuesta PP-RCT RA7050 NIRON OB BARRERA DE OXÍGENO

Tubería compuesta PP-RCT RA7050 con barrera de oxígeno SDR11/Serie 5



Descripción

- Tubo compuesto PP-RCT RA7050+FV SDR11/Serie 5
- Capa externa: Capa EVOH color azul
- Capa interna: PP-RCT RA7050+FV color gris
- Clase 1/6 bar, clase 2/6 bar, clase 4/6 bar, clase 5/4 bar

Suministro:

- En barras de 4 metros

Aplicaciones



Referencia	Ø	Espesor (mm)	L (m)	Metros/Bolsa	Palet (m)	Precio (€/m)
27TNIRROBFG259*	25 mm	3,5	4	100	2000	3,87
27TNIRROBFG329*	32 mm	3,6	4	60	1320	6,93
27TNIRROBFG4011	40 mm	3,7	4	40	800	7,89
27TNIRROBFG5011	50 mm	4,6	4	20	560	11,30
27TNIRROBFG6311	63 mm	5,8	4	16	352	18,68
27TNIRROBFG7511	75 mm	6,8	4	12	240	24,07
27TNIRROBFG9011	90 mm	8,2	4	8	160	34,02
27TNIRROBFG11011	110 mm	10,0	4	8	112	52,18

* Descripción

- Tubo compuesto PP-RCT RA7050+FV SDR9/Serie 4
- Capa externa: Capa EVOH color azul
- Capa interna: PP-RCT RA7050+FV color gris
- Clase 1/8 bar, clase 2/8 bar, clase 4/8 bar, clase 5/6 bar

Suministro:

- En barras de 4 metros

Herramienta pelador para tubería OB

Referencia	Ø	Uds. Caja	Precio (€/ud.)
RATOR25125	25÷125 mm	1	Consultar

Herramienta obligatoria

La formación sobre el uso de cualquier herramienta para el decapado de la capa de EVOH de NIRON OB es obligatoria para la garantía del producto.

Es imprescindible, antes de empezar la instalación de esta gama, solicitar formación y asistencia gratuita en atencionalcliente@italsan.com o al delegado técnico de Italsan de su zona.

Herramienta pelador turbo para tubería OB

Referencia	Ø	Uds. Caja	Precio (€/ud.)
RATURBO25	25 mm	1	Consultar
RATURBO32	32 mm	1	Consultar
RATURBO40	40 mm	1	Consultar
RATURBO50	50 mm	1	Consultar
RATURBO63	63 mm	1	Consultar

Referencia	Ø	Uds. Caja	Precio (€/ud.)
RAT1AOB	75÷180 mm	1	Consultar



Tubería Compuesta PP-RCT RA7050 NIRON OB BARRERA DE OXÍGENO

Presiones de servicio tubería compuesta PP-RCT RA7050 SDR11/Serie 5

		NIRON Compuesta PP-RCT SDR11/Serie 5		NIRON Compuesta PP-RCT SDR9/Serie 4	
Clase	1	6		8	
	2	6		8	
	4	6		8	
	5	4		6	
T máxima fluido (°C)	Años en ejercicio continuo	Presión servicio (bar)	Presión servicio (bar)	Presión servicio (bar)	Presión servicio (bar)
		Circuito abierto	Circuito cerrado	Circuito abierto	Circuito cerrado
10	1	19,0	22,8	24,0	28,8
	5	18,4	22,1	23,2	27,9
	10	18,2	21,9	22,9	27,5
	25	17,9	21,5	22,5	27,1
	50	17,7	21,2	22,2	26,7
20	1	16,6	19,9	20,9	25,0
	5	16,0	19,3	20,2	24,2
	10	15,8	19,0	19,9	23,9
	25	15,5	18,6	19,6	23,5
	50	15,3	18,4	19,0	23,1
30	1	14,3	17,2	18,1	21,7
	5	13,9	16,6	17,4	20,9
	10	13,6	16,4	17,2	20,6
	25	13,4	16,1	16,9	20,2
	50	13,2	15,8	16,6	19,9
40	1	12,3	14,8	15,5	18,6
	5	11,9	14,3	15,0	18,0
	10	11,7	14,1	14,7	17,7
	25	11,5	13,8	14,4	17,3
	50	11,3	13,6	14,2	17,1
50	1	10,5	12,6	13,3	15,9
	5	10,1	12,2	12,8	15,3
	10	10,0	12,0	12,6	15,1
	25	9,7	11,7	12,3	14,7
	50	9,6	11,5	12,1	14,5
60	1	8,9	10,7	11,2	13,5
	5	8,6	10,3	10,8	13,0
	10	8,4	10,1	10,6	12,7
	25	8,2	9,9	10,4	12,4
	50	8,1	9,7	10,2	12,2
70	1	7,5	9,0	9,4	11,3
	5	7,2	8,6	9,1	10,9
	10	7,0	8,5	8,9	10,7
	25	6,9	8,3	8,7	10,4
	50	6,8	8,1	8,5	10,2
80	1	6,2	7,5	7,9	9,5
	5	6,0	7,2	7,5	9,5
	10	5,9	7,0	7,4	8,9
	25	5,7	6,9	7,2	8,6
95	1	4,7	5,6	5,9	7,1
	5	4,4	5,3	5,6	6,7

Circuito abierto: Coeficiente de seguridad aplicado del 1,5 según norma UNE-EN ISO 15874

Circuito cerrado: Coeficiente de seguridad aplicado del 1,25 según norma DIN 8077/78

Tubería Monocapa PP-R NIRON PURPLE para aguas recicladas / recuperadas

Tubería monocapa SDR11/Serie 5



Descripción

-Tubo monocapa SDR11/SERIE 5
-Clase 1/6 bar, clase 2/4 bar,
clase 4/6 bar

Suministro:

-En barras de 4 metros

Aplicaciones



Referencia	Ø	Espesor (mm)	L (m)	Metros/Bolsa	Palet (m)	Precio (€/m)
TNIRV20 *	20 mm	2,8	4	100	3000	1,67
TNIRV25 *	25 mm	3,5	4	100	2000	2,64
TNIRV32	32 mm	2,9	4	60	1320	3,71
TNIRV40	40 mm	3,7	4	40	800	5,66
TNIRV50	50 mm	4,6	4	20	560	8,94
TNIRV63	63 mm	5,8	4	16	352	14,00
TNIRV75	75 mm	6,8	4	12	240	19,49
TNIRV90	90 mm	8,2	4	8	160	27,18
TNIRV110	110 mm	10,0	4	8	112	40,18
TNIRV125	125 mm	11,4	4	8	80	52,19
TNIRV160	160 mm	14,6	4	4	48	87,00

*** Descripción**

-Tubo monocapa SDR7,4/SERIE 3,2
-Clase 1/8 bar, clase 2/6 bar,
clase 4/10 bar, clase 5/6 bar

Suministro:

-En barras de 4 metros



Tubería Monocapa PP-R NIRON PURPLE para aguas recicladas / recuperadas

Presiones de servicio tubería monocapa SDR11/SERIE 5

		NIRON Monocapa SDR11/Serie 5		NIRON Monocapa SDR7,4/Serie 3,2	
Clase	1	6		8	
	2	4		6	
	4	6		10	
	5	-		6	
T máxima fluido (°C)	Años en ejercicio continuo	Presión servicio (bar)	Presión servicio (bar)	Presión servicio (bar)	Presión servicio (bar)
		Circuito abierto	Circuito cerrado	Cir. abierto	Cir. cerrado
10	1	17,6	21,1	27,8	33,4
	5	16,6	19,9	26,4	31,7
	10	16,1	19,3	25,5	30,6
	25	15,6	18,7	24,7	29,6
	50	15,2	18,2	24,0	28,8
20	1	15,0	18,0	23,8	28,6
	5	14,1	16,9	22,3	26,8
	10	13,7	16,4	21,7	26,0
	25	13,3	16,0	21,1	25,3
	50	12,9	15,5	20,4	24,5
30	1	12,8	15,4	20,2	24,2
	5	12,0	14,4	19,0	22,8
	10	11,6	13,9	18,3	22,0
	25	11,2	13,4	17,7	21,2
	50	10,9	13,1	17,3	20,8
40	1	10,8	13,0	17,1	20,5
	5	10,1	12,1	16,0	19,2
	10	9,8	11,8	15,6	18,7
	25	9,4	11,3	15,0	18,0
	50	9,2	11,0	14,5	17,4
50	1	9,2	11,0	14,5	17,4
	5	8,5	10,2	13,5	16,2
	10	8,2	9,8	13,1	15,7
	25	8,0	9,6	12,6	15,1
	50	7,7	9,2	12,2	14,6
60	1	7,7	9,2	12,2	14,6
	5	7,2	8,6	11,6	13,9
	10	6,9	8,3	11,0	13,2
	25	6,7	8,0	10,5	12,6
	50	6,4	7,7	10,1	12,1
70	1	6,5	7,8	10,3	12,4
	5	6,0	7,2	9,5	11,4
	10	5,9	7,1	9,3	11,2
	25	5,1	6,1	8,0	9,6
	50	4,3	5,2	6,7	8,0

Circuito abierto: Coeficiente de seguridad aplicado del 1,5 según norma UNE-EN ISO 15874

Circuito cerrado: Coeficiente de seguridad aplicado del 1,25 según norma DIN 8077/78



Accesorios electrosoldables

Accesorios PP-R Electrosoldables

Codo 90° SDR11 soldadura eléctrica (clase 1/6, clase 2/4, clase 2/6, clase 4/6 según diámetro -ver tabla-)

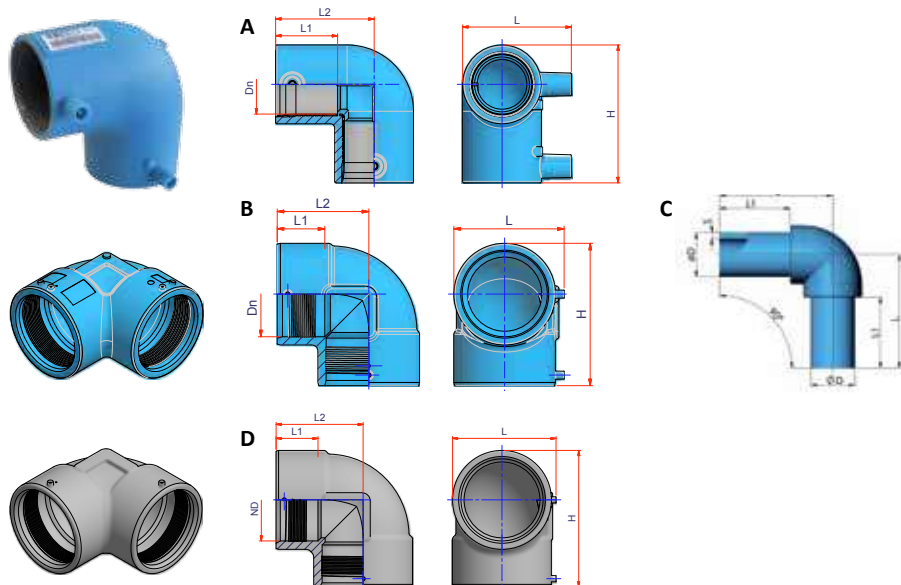

Referencia	Tipo	Ø	Clase	Uds. Caja	Dn (mm)	L1 (mm)	L2 (mm)	L (mm)	H (mm)	Precio (€/ud.)
NGEM40	A	40 mm	1/6, 2/6, 4/6	40	40,0	41,0	65,0	73,0	91,5	50,24
NGEM50	A	50 mm	1/6, 2/6, 4/6	25	50,0	48,0	77,0	84,0	109,5	52,94
NGEM63	A	63 mm	1/6, 2/6, 4/6	15	63,0	53,0	88,0	100,0	126,0	65,34
NGEM75	A	75 mm	1/6, 2/6, 4/6	12	75,0	58,0	97,0	110,0	142,0	86,14
NGEM90	A	90 mm	1/6, 2/6, 4/6	14	90,0	78,0	119,0	133,0	176,0	99,89
NGEM110	A	110 mm	1/6, 2/6, 4/6	10	110,0	83,0	144,0	164,0	214,0	157,04
NGE125MAN*	C	125 mm	1/6, 2/4, 4/6	1	125,0	200,0	-	320,5	-	105,59
NGE160	B	160 mm	1/6, 2/4, 4/6	1	160,0	90,0	173,0	208,5	269,0	345,33
27NGEM200**	D	200 mm	1/6, 2/4, 4/6	1	200,0	100,0	213,0	253,5	334,0	A consultar

* Accesorio manipulado para soldar con manguito eléctrico. Accesorio en azul o gris en funcion de existencias.

** NGEM200 TIPO B en color azul hasta finalizar existencias.

Accesorios PP-R Electrosoldables

Codo 45° SDR11 soldadura eléctrica (clase 1/6, clase 2/4, clase 2/6, clase 4/6 según diámetro -ver tabla-)

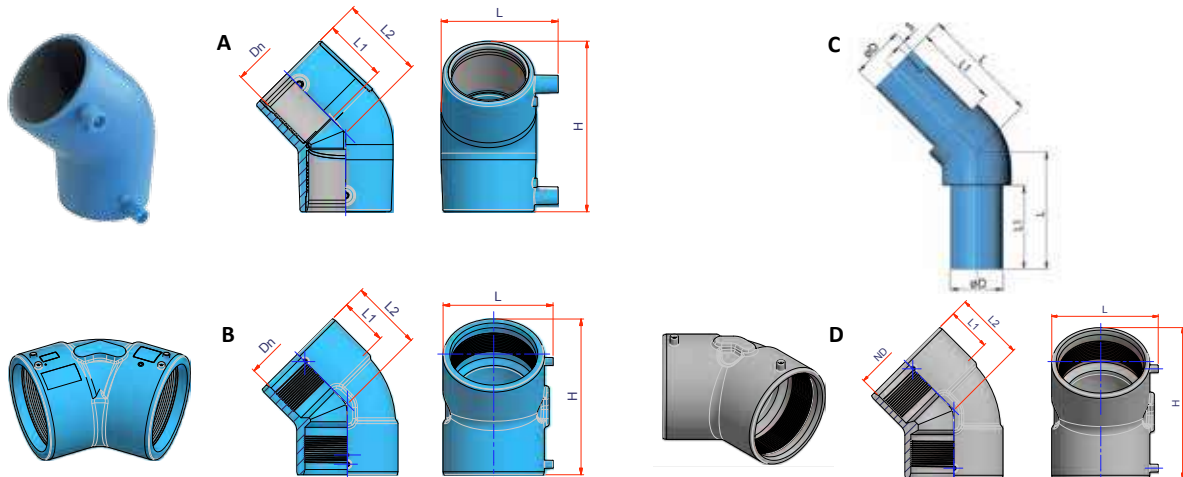

Referencia	Tipo	∅	Clase	Uds. Caja	Dn (mm)	L1 (mm)	L2 (mm)	L (mm)	H (mm)	Precio (€/ud.)
NCEM40	A	40 mm	1/6, 2/6, 4/6	40	40,0	42,0	52,0	74,5	109,0	42,27
NCEM50	A	50 mm	1/6, 2/6, 4/6	30	50,0	47,0	63,0	85,0	126,0	47,39
NCEM63	A	63 mm	1/6, 2/6, 4/6	20	63,0	54,0	68,0	100,0	146,0	59,48
NCEM75	A	75 mm	1/6, 2/6, 4/6	14	75,0	60,0	81,0	112,5	169,0	75,47
NCEM90	A	90 mm	1/6, 2/6, 4/6	15	90,0	67,0	97,0	132,0	219,0	99,89
NCEM110	A	110 mm	1/6, 2/6, 4/6	12	110,0	81,0	107,0	152,0	249,0	184,96
NCE125MAN*	C	125 mm	1/6, 2/4, 4/6	1	125,0	200,0	-	280,0	-	119,12
NCE160	B	160 mm	1/6, 2/4, 4/6	1	160,0	90,0	134,0	208,5	296,0	345,33
27NCEM200**	D	200 mm	1/6, 2/4, 4/6	1	200,0	97,5	167,0	250,5	368,0	A consultar

* Accesorio manipulado para soldar con manguito eléctrico. Accesorio en azul o gris en función de existencias.

** NCEM200 TIPO B en color azul hasta finalizar existencias.

Accesorios PP-R Electrosoldables

Te bocas hembra SDR11 soldadura eléctrica (clase 1/6, clase 2/4, clase 4/6)

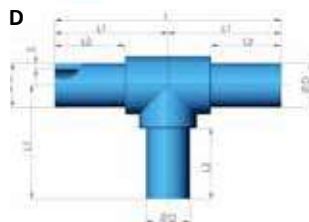
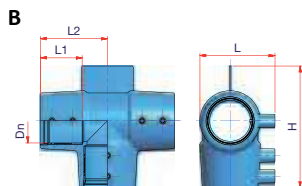
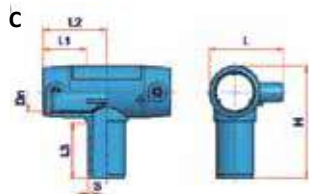
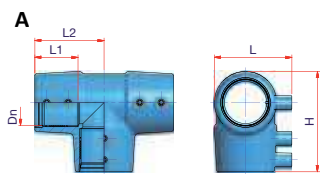

HASTA FIN
de existencias

Referencia	Tipo	Ø	Uds. Caja	Dn (mm)	L1 (mm)	L2 (mm)	L3 (mm)	L (mm)	H (mm)	Precio (€/ud.)
NTE40	A	40 mm	25	40,0	44,0	70,0	-	75,0	99,0	53,18

Accesorio en azul o gris en funcion de existencias.

Accesorios PP-R Electrosoldables

Te hembra/macho/hembra SDR11 soldadura eléctrica (clase 1/6, clase 2/4, clase 2/6, clase 4/6 según diámetro -ver tabla-)

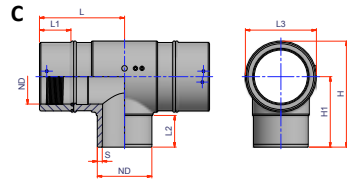
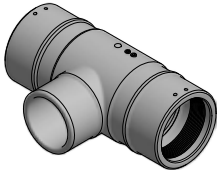
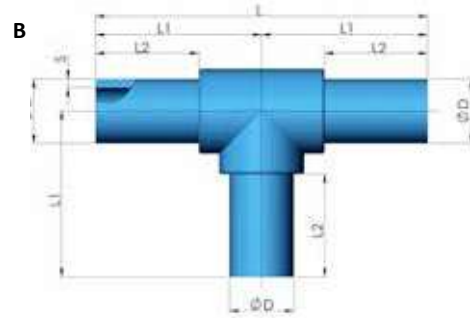
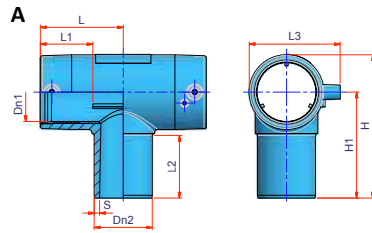
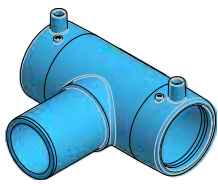

Referencia	Tipo	Ø	Clase	Uds. Caja	Dn1-Dn2 (mm)	S (mm)	L1 (mm)	L2 (mm)	L3 (mm)	L (mm)	H1 (mm)	H (mm)	Precio (€/ud.)
NTCE040	A	40 mm	1/6, 2/6, 4/6	12	40,0	3,7	44,0	54,0	74,0	66,5	84,0	111,0	58,49
NTCE050	A	50 mm	1/6, 2/6, 4/6	15	50,0	4,6	46,5	61,0	85,0	76,5	100,0	133,5	78,21
NTCE063	A	63 mm	1/6, 2/6, 4/6	10	63,0	5,8	57,0	68,0	99,0	90,0	115,0	156,0	84,96
NTCE075	A	75 mm	1/6, 2/6, 4/6	6	75,0	6,8	58,0	72,0	112,0	98,0	130,0	178,0	93,14
NTCE090	A	90 mm	1/6, 2/6, 4/6	10	90,0	8,2	70,0	84,0	139,5	122,0	150,0	209,0	195,26
NTCE110	A	110 mm	1/6, 2/6, 4/6	1	110,0	10,0	83,0	88,5	156,5	144,0	177,0	247,0	253,62
NTE125MAN*	B	125 mm	1/6, 2/4, 4/6	7	125,0	-	320,5	200,0	-	641,0	-	-	212,93
NTCE160	A	160 mm	1/6, 2/4, 4/6	1	160,0	14,6	87,0	105,0	201,5	151,0	208,0	303,0	381,92
27NTCE200	C	200 mm	1/6, 2/4, 4/6	1	200,0	18,3	114,8	116,0	260,0	311,5	258,0	337,8	A consultar

* Accesorio manipulado para soldar con manguito eléctrico. Accesorio en azul o gris en funcion de existencias.

Accesorios PP-R Electrosoldables

Manguito SDR11 soldadura eléctrica (clase 1/6, clase 2/4, clase 2/6, clase 4/6 según diámetro -ver tabla-)

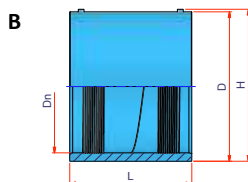
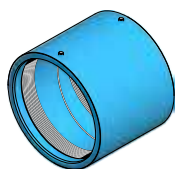
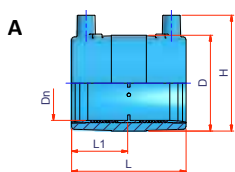

Referencia	Tipo	Ø	Clase	Uds. Caja	Dn (mm)	L1 (mm)	L (mm)	H (mm)	D (mm)	Precio (€/ud.)
NME20	A	20 mm	1/6, 2/6, 4/6	100	20,0	34,0	70,0	52,0	33,0	11,29
NME25	A	25 mm	1/6, 2/6, 4/6	30	25,0	34,0	70,0	58,0	38,5	11,76
NME32	A	32 mm	1/6, 2/6, 4/6	80	32,0	34,0	70,0	65,0	45,5	13,54
NME40	A	40 mm	1/6, 2/6, 4/6	30	40,0	41,0	85,0	75,0	55,0	15,21
NME50	A	50 mm	1/6, 2/6, 4/6	40	50,0	42,5	88,0	87,0	68,0	16,52
NME63	A	63 mm	1/6, 2/6, 4/6	30	63,0	47,5	98,0	100,0	82,0	19,56
NME75	A	75 mm	1/6, 2/6, 4/6	24	75,0	61,0	125,0	114,0	98,0	34,52
NME90	A	90 mm	1/6, 2/6, 4/6	30	90,0	72,0	146,0	130,0	113,0	38,64
NME110	A	110 mm	1/6, 2/6, 4/6	22	110,0	77,0	155,0	144,0	136,0	41,26
NME125	A	125 mm	1/6, 2/6, 4/6	16	125,0	82,0	166,0	167,0	156,5	76,41
NME160	A	160 mm	1/6, 2/4, 4/6	1	160,0	86,5	175,0	201,5	190,0	106,47
NME200	A	200 mm	1/6, 2/4, 4/6	1	200,0	91,5	185,0	243,0	232,0	187,51
NME250	A	250 mm	1/6, 2/4, 4/6	1	250,0	106,0	212,0	300,0	296,0	326,57
NME315	B	315 mm	1/6, 2/4, 4/6	1	315,0	-	300,0	398,0	396,0	541,50

Color del interior del manguito en azul/gris según fabricación.



Accesorios PP-R Electrosoldables

Portabridas macho manipulado unión socket o accesorio eléctrico

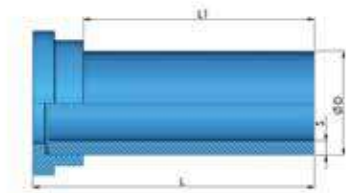

Referencia	∅	Uds. Caja	Dn (mm)	L (mm)	L1 (mm)	S (mm)	Precio (€/ud.)
NCOSA40MAN	40 mm	1	40,0	230,0	200,0	5,5	23,17
NCOSA50MAN	50 mm	1	50,0	234,0	200,0	6,9	24,41
NCOSA63MAN	63 mm	1	63,0	238,0	200,0	8,7	29,19
NCOSA75MAN	75 mm	1	75,0	242,0	200,0	10,4	33,19
NCOSA90MAN	90 mm	1	90,0	246,0	200,0	12,5	45,09
NCOSA110MAN	110 mm	1	110,0	257,0	200,0	15,2	62,54
NCOSA125MAN	125 mm	1	125,0	262,5	200,0	17,1	94,18

Enlace macho rosca hembra manipulado unión socket o accesorio eléctrico

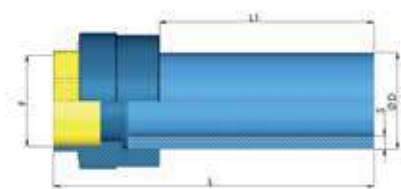

Referencia	∅	Uds. Caja	D (mm)	L2 (mm)	L1 (mm)	S (mm)	F	Precio (€/ud.)
NRFF40114MAN	40 mm	1	40,0	269,0	200,0	5,5	1¼"	43,51
NRFF50112MAN	50 mm	1	50,0	255,0	200,0	6,9	1½"	52,71
NRFF632MAN	63 mm	1	63,0	265,0	200,0	8,7	2"	69,74
NRFF75212MAN	75 mm	1	75,0	289,0	200,0	10,4	2½"	91,73
NRFF903MAN	90 mm	1	90,0	299,0	200,0	12,5	3"	176,71
NRFF1104MAN	110 mm	1	110,0	311,0	200,0	15,2	4"	195,04
NRFF1254MAN	125 mm	1	125,0	315,5	200,0	17,1	4"	204,12

Enlace macho rosca macho manipulado unión socket o accesorio eléctrico

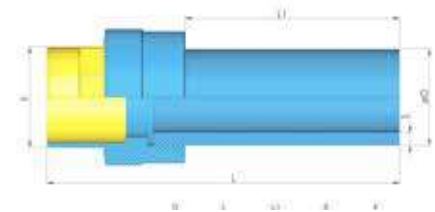

Referencia	∅	Uds. Caja	D (mm)	L2 (mm)	L1 (mm)	S (mm)	F	Precio (€/ud.)
NRFM40114MAN	40 mm	1	40,0	291,0	200,0	5,5	1¼"	49,06
NRFM50112MAN	50 mm	1	50,0	293,0	200,0	6,9	1½"	56,07
NRFM632MAN	63 mm	1	63,0	305,0	200,0	8,7	2"	72,54
NRFM75212MAN	75 mm	1	75,0	312,0	200,0	10,4	2½"	105,03
NRFM903MAN	90 mm	1	90,0	329,0	200,0	12,5	3"	200,52
NRFM1104MAN	110 mm	1	110,0	348,0	200,0	15,2	4"	232,06
NRFM1254MAN	125 mm	1	125,0	352,5	200,0	17,1	4"	275,18



Accesorios termofusión

Accesorios termofusión

Codo 90° unión Socket

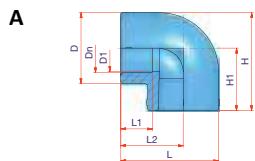

Referencia	Tipo	Ø	Uds. Caja	Dn (mm)	D1 (mm)	D (mm)	L1 (mm)	L2 (mm)	L (mm)	H1 (mm)	H (mm)	Precio (€/ud.)
NG16	A	16 mm	150	16,0	15,0	25,0	13,0	24,0	36,0	24,0	36,0	0,58
NG20	A	20 mm	200	20,0	16,5	29,0	16,0	27,0	41,5	27,0	41,5	0,61
NG25	A	25 mm	100	25,0	23,5	35,5	16,0	31,0	49,0	31,0	49,0	0,77
NG32	A	32 mm	60	32,0	30,0	46,0	20,0	37,0	60,0	37,0	60,0	1,23
NG40	A	40 mm	40	40,0	36,0	56,0	22,0	43,0	71,0	43,0	71,0	2,25
NG50	A	50 mm	24	50,0	46,0	70,0	25,0	51,0	86,0	51,0	86,0	4,82
NG63	A	63 mm	25	63,0	59,0	88,0	29,0	62,0	106,0	62,0	106,0	7,95
NG75	A	75 mm	15	75,0	70,0	101,0	33,0	73,0	123,5	73,0	123,5	14,82
NG90	A	90 mm	10	90,0	86,0	123,0	37,0	85,0	144,0	85,0	144,0	24,97
NG110	A	110 mm	4	110,0	100,0	146,0	43,0	100,0	173,0	100,0	173,0	38,98
NG125	A	125 mm	4	125,0	113,0	165,0	47,5	125,0	207,5	125,0	207,5	61,24

Codo 90° - SDR11 soldadura a testa o accesorio eléctrico

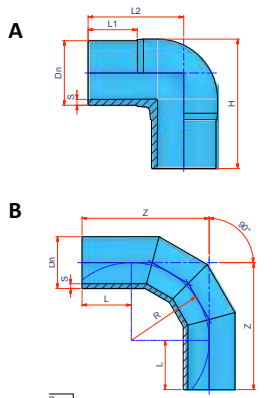

Referencia	Tipo	Ø	Uds. Caja	Dn (mm)	S (mm)	L1 (mm)	L2 (mm)	H (mm)	L (mm)	Z (mm)	R (mm)	Precio (€/ud.)
NG9011160MM	A	160 mm	1	160,0	14,6	101,0	210,0	293,5	-	-	-	93,40
NG9011200MM	A	200 mm	1	200,0	18,2	116,0	250,0	354,0	-	-	-	239,30
NG9011250MM	A	250 mm	1	250,0	22,7	135,0	305,0	435,0	-	-	-	285,04
NG9011315MMB	B	315 mm	1	315,0	28,6	-	-	-	300,0	773,0	473,0	896,52
NG9011355MMB	B	355 mm	1	355,0	32,2	-	-	-	300,0	833,0	533,0	1.259,46
NG9011400MMB	B	400 mm	1	400,0	36,3	-	-	-	300,0	900,0	600,0	1.512,02
NG9011450MMB	B	450 mm	1	450,0	40,9	-	-	-	300,0	975,0	675,0	2.227,23

Accesorios termofusión

Codo 90° - SDR17 soldadura a testa o accesorio eléctrico

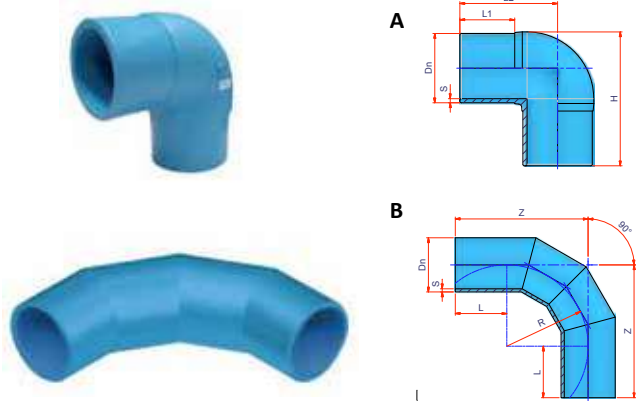

Referencia	Tipo	Ø	Uds. Caja	Dn (mm)	S (mm)	L1 (mm)	L2 (mm)	H (mm)	L (mm)	Z (mm)	R (mm)	Precio (€/ud.)
NG9017160MM	A	160 mm	1	160,0	9,5	101,0	210,0	293,5	-	-	-	68,41
NG9017200MM	A	200 mm	1	200,0	11,9	116,0	250,0	354,0	-	-	-	181,24
NG9017250MM	A	250 mm	1	250,0	14,8	135,0	305,0	435,0	-	-	-	220,91
NG9017315MMB	B	315 mm	1	315,0	18,7	-	-	-	300,0	773,0	473,0	589,95
NG9017355MMB	B	355 mm	1	355,0	21,1	-	-	-	300,0	833,0	533,0	731,70
NG9017400MMB	B	400 mm	1	400,0	23,7	-	-	-	300,0	900,0	600,0	962,52
NG9017450MMB	B	450 mm	1	450,0	26,7	-	-	-	300,0	975,0	675,0	1.261,89
NG9017500MMB	B	500 mm	1	500,0	29,7	-	-	-	350,0	1100,0	750,0	1.779,35
NG9017560MMB	B	560 mm	1	560,0	33,2	-	-	-	350,0	1190,0	840,0	2.393,93
NG9017630MMB	B	630 mm	1	630,0	37,4	-	-	-	350,0	1295,0	945,0	3.640,67

Codo 60° segmentado soldadura a testa o accesorio eléctrico

**Disponible
BAJO PEDIDO**

SDR	Diámetro de tubería (mm)									
	90	110	125	160	200	250	315	355	400	
SDR7,4	✓	✓	✓	✓	-	-	-	-	-	
SDR9	✓	✓	✓	✓	✓	✓	✓	✓	-	
SDR11	✓	✓	✓	✓	✓	✓	✓	✓	✓	
SDR17	-	-	-	✓	✓	✓	✓	✓	✓	

Referencias disponibles bajo pedido.

Codo 30° segmentado soldadura a testa o accesorio eléctrico

**Disponible
BAJO PEDIDO**

SDR	Diámetro de tubería (mm)									
	90	110	125	160	200	250	315	355	400	
SDR7,4	✓	✓	✓	✓	-	-	-	-	-	
SDR9	✓	✓	✓	✓	✓	✓	✓	✓	-	
SDR11	✓	✓	✓	✓	✓	✓	✓	✓	✓	
SDR17	-	-	-	✓	✓	✓	✓	✓	✓	

Referencias disponibles bajo pedido.

Accesorios termofusión

Codo 45° unión socket

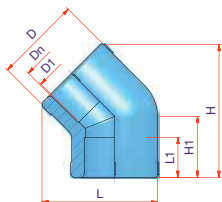

Referencia	∅	Uds. Caja	Dn (mm)	D1 (mm)	D (mm)	L1 (mm)	L (mm)	H1 (mm)	H (mm)	Precio (€/ud.)
NC4516	16 mm	150	16,0	15,0	25,0	13,0	33,0	16,5	37,0	0,70
NC4520	20 mm	200	20,0	16,5	29,0	16,0	33,0	21,5	46,0	0,71
NC4525	25 mm	150	25,0	23,5	34,0	16,0	46,0	24,5	53,5	0,92
NC4532	32 mm	40	32,0	30,0	42,0	20,0	56,0	29,0	64,0	1,38
NC4540	40 mm	30	40,0	36,0	53,0	22,0	67,0	32,0	72,5	3,08
NC4550	50 mm	30	50,0	47,5	66,0	25,0	83,5	39,5	90,0	5,75
NC4563	63 mm	35	63,0	60,0	83,0	29,0	102,0	45,0	105,0	7,76
NC4575	75 mm	16	75,0	70,0	99,0	33,0	129,5	65,0	145,0	12,55
NC4590	90 mm	12	90,0	86,0	123,5	37,0	145,0	57,0	140,0	23,52
NC45110	110 mm	6	110,0	100,0	146,0	43,0	172,5	70,0	169,5	39,17
NC45125	125 mm	4	125,0	113,0	165,0	47,5	194,0	78,0	189,5	54,55

Codo 45° - SDR11 soldadura a testa o accesorio eléctrico

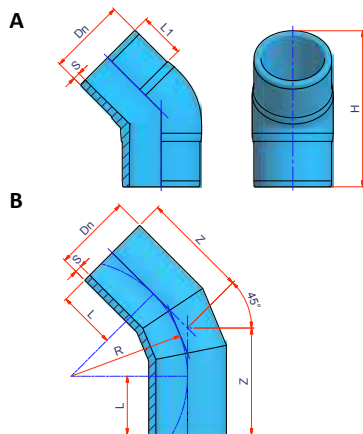

Referencia	Tipo	∅	Uds. Caja	Dn (mm)	S (mm)	L1 (mm)	H (mm)	L (mm)	Z (mm)	R (mm)	Precio (€/ud.)
NC4511160MM	A	160 mm	1	160,0	14,6	103,0	311,0	-	-	-	74,63
NC4511200MM	A	200 mm	1	200,0	18,2	117,0	402,0	-	-	-	235,02
NC4511250MMB	B	250 mm	1	250,0	22,7	250,0	462,0	-	-	-	416,93
NC4511315MMB	B	315 mm	1	315,0	28,6	-	-	300,0	498,0	473,0	628,85
NC4511355MMB	B	355 mm	1	355,0	32,5	-	-	300,0	520,0	533,0	832,94
NC4511400MMB	B	400 mm	1	400,0	36,3	-	-	300,0	548,0	600,0	998,42
NC4511450MMB	B	450 mm	1	450,0	40,9	-	-	300,0	580,0	675,0	1.483,85

Accesorios termofusión

Codo 45° - SDR17 soldadura a testa o accesorio eléctrico

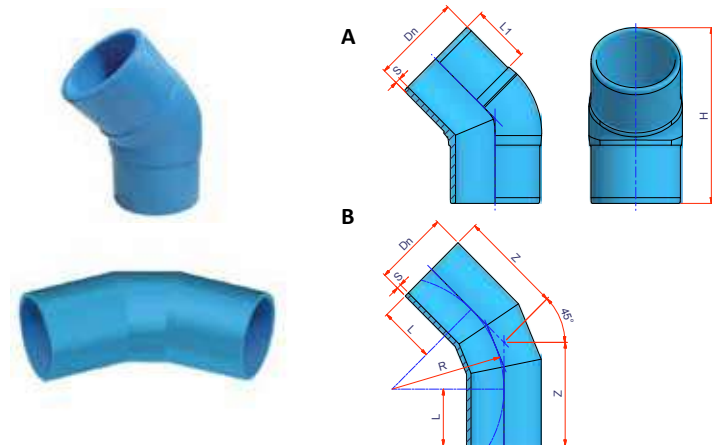

Referencia	Tipo	Ø	Uds. Caja	Dn (mm)	S (mm)	L1 (mm)	H (mm)	L (mm)	Z (mm)	R (mm)	Precio (€/ud.)
NC4517160MM	A	160 mm	1	160,0	9,5	103,0	311,0	-	-	-	63,81
NC4517200MM	A	200 mm	1	200,0	11,9	117,0	402,0	-	-	-	232,92
NC4517250MM	A	250 mm	1	250,0	14,8	135,0	462,0	-	-	-	377,48
NC4517315MMB	B	315 mm	1	315,0	18,7	-	-	300,0	498,0	473,0	485,20
NC4517355MMB	B	355 mm	1	355,0	21,1	-	-	300,0	520,0	533,0	606,54
NC4517400MMB	B	400 mm	1	400,0	23,7	-	-	300,0	548,0	600,0	727,85
NC4517450MMB	B	450 mm	1	450,0	26,7	-	-	300,0	580,0	675,0	961,99
NC4517500MMB	B	500 mm	1	500,0	29,7	-	-	350,0	665,0	750,0	1.178,94
NC4517560MMB	B	560 mm	1	560,0	33,2	-	-	350,0	698,0	840,0	1.603,34
NC4517630MMB	B	630 mm	1	630,0	37,4	-	-	350,0	741,0	945,0	2.280,29

Manguito unión socket



Referencia	Ø	Uds. Caja	Dn (mm)	D1 (mm)	D (mm)	L1 (mm)	L (mm)	Precio (€/ud.)
NMAN16	16 mm	150	16,0	15,0	24,5	16,0	34,0	0,50
NMAN20	20 mm	300	20,0	18,0	29,0	17,0	35,0	0,52
NMAN25	25 mm	150	25,0	20,0	35,0	18,0	39,0	0,62
NMAN32	32 mm	40	32,0	30,0	46,0	20,0	43,0	0,97
NMAN40	40 mm	50	40,0	37,0	56,0	22,0	48,0	1,73
NMAN50	50 mm	20	50,0	47,0	70,0	25,0	54,0	2,95
NMAN63	63 mm	15	63,0	60,0	88,0	29,0	62,0	4,80
NMAN75	75 mm	35	75,0	70,0	101,0	33,0	71,0	7,42
NMAN90	90 mm	24	90,0	87,5	114,5	37,0	77,0	13,54
NMAN110	110 mm	12	110,0	106,0	151,0	43,0	92,0	20,79
NMAN125	125 mm	4	125,0	117,0	160,0	47,5	102,0	30,50

Accesorios termofusión

Te unión socket

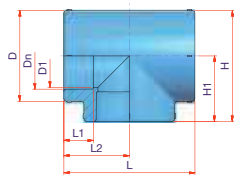

Referencia	Ø	Uds. Caja	Dn (mm)	D1 (mm)	D (mm)	L1 (mm)	L2 (mm)	L (mm)	H1 (mm)	H (mm)	Precio (€/ud.)
NT16	16 mm	100	16,0	13,0	24,0	14,5	23,5	47,0	23,5	35,5	0,73
NT20	20 mm	150	20,0	18,0	33,0	16,0	27,0	54,0	27,0	43,5	0,77
NT25	25 mm	80	25,0	21,0	35,0	17,0	31,5	63,0	31,5	49,0	1,03
NT32	32 mm	40	32,0	30,0	46,0	20,0	37,0	74,0	37,0	60,0	1,62
NT40	40 mm	30	40,0	36,0	56,0	22,0	43,0	86,0	43,0	71,0	3,02
NT50	50 mm	16	50,0	46,0	70,0	25,0	51,0	102,0	51,0	86,0	6,61
NT63	63 mm	24	63,0	59,0	88,0	29,0	62,0	124,0	62,0	106,0	10,70
NT75	75 mm	16	75,0	70,0	101,0	33,0	73,0	146,0	73,0	123,5	16,72
NT90	90 mm	8	90,0	88,0	123,0	37,0	85,0	170,0	85,0	144,0	28,54
NT110	110 mm	4	110,0	100,0	146,0	43,0	100,0	200,0	100,0	173,0	48,72
NT125	125 mm	3	125,0	113,0	165,0	47,5	125,0	250,0	125,0	207,5	68,48

Te - SDR11 soldadura a testa o accesorio eléctrico

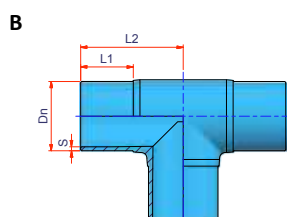
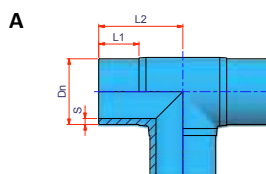

Referencia	Tipo	Ø	Uds. Caja	Dn (mm)	S (mm)	L1 (mm)	L2 (mm)	L (mm)	Z (mm)	Precio (€/ud.)
NT11160MM	A	160 mm	1	160,0	14,6	103,0	210,0	-	-	104,11
NT11200MM	A	200 mm	1	200,0	18,2	117,0	250,0	-	-	292,54
NT11250MMB	B	250 mm	1	250,0	22,7	-	-	250,0	375,0	487,80
NT11315MMB	B	315 mm	1	315,0	28,6	-	-	300,0	460,0	802,11
NT11355MMB	B	355 mm	1	355,0	32,2	-	-	300,0	480,0	969,22
NT11400MMB	B	400 mm	1	400,0	36,3	-	-	300,0	500,0	1.389,57
NT11450MMB	B	450 mm	1	450,0	40,9	-	-	300,0	525,0	1.838,18



Accesorios termofusión

Te - SDR17 soldadura a testa o accesorio eléctrico/unión socket

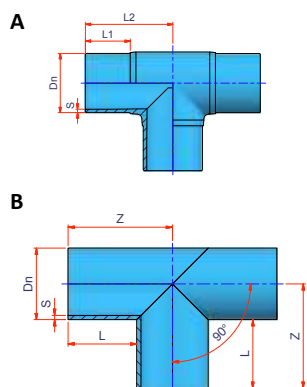

Referencia	Tipo	Ø	Uds, Caja	Dn (mm)	S (mm)	L1 (mm)	L2 (mm)	L (mm)	Z (mm)	Precio (€/ud,)
NT17160MM	A	160 mm	1	160,0	9,5	103,0	210,0	-	-	71,92
NT17200MM	A	200 mm	1	200,0	11,9	117,0	250,0	-	-	255,73
NT17250MM	A	250 mm	1	250,0	14,8	135,0	305,0	-	-	355,94
NT17315MMB	B	315 mm	1	315,0	18,7	-	-	300,0	460,0	578,19
NT17355MMB	B	355 mm	1	355,0	21,1	-	-	300,0	480,0	712,61
NT17400MMB	B	400 mm	1	400,0	23,7	-	-	300,0	500,0	890,76
NT17450MMB	B	450 mm	1	450,0	26,7	-	-	300,0	525,0	1.147,47
NT17500MMB	B	500 mm	1	500,0	29,7	-	-	350,0	600,0	1.603,34
NT17560MMB	B	560 mm	1	560,0	33,2	-	-	350,0	630,0	2.103,33
NT17630MMB	B	630 mm	1	630,0	37,4	-	-	350,0	665,0	2.757,27

Accesorios termofusión

Reducción macho/hembra unión socket



A

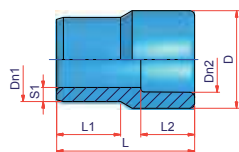

Sugerencia instalación

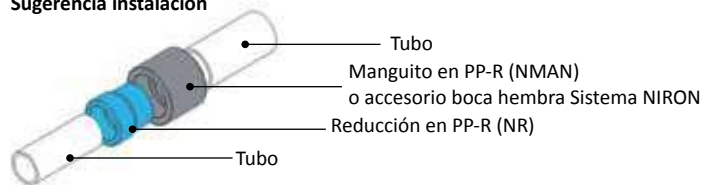

Referencia	Tipo	∅	Uds. Caja	Dn1 (mm)	S1 (mm)	Dn2 (mm)	D (mm)	L1 (mm)	L2 (mm)	L (mm)	Precio (€/ud.)
NR2016	A	20/16 mm	150	20,0	3,4	16,0	24,0	16,0	18,0	37,0	0,55
NR2516	A	25/16 mm	100	25,0	4,2	16,0	26,0	19,0	18,0	39,0	0,66
NR2520	A	25/20 mm	100	25,0	4,2	20,0	29,0	19,0	16,0	41,0	0,66
NR3225	A	32/25 mm	80	32,0	5,4	25,0	35,0	22,0	17,0	44,0	0,80
NR4032	A	40/32 mm	40	40,0	6,7	32,0	46,0	25,0	20,0	50,0	1,58
NR5040	A	50/40 mm	40	50,0	8,3	40,0	56,0	28,0	22,0	55,0	2,82
NR6350	A	63/50 mm	20	63,0	10,5	50,0	70,0	32,0	25,0	54,0	4,58
NR7563	A	75/63 mm	12	75,0	12,5	63,0	83,0	36,0	29,0	74,0	8,00
NR9075	A	90/75 mm	18	90,0	15,0	75,0	96,0	37,0	34,0	80,0	16,07
NR11090	A	110/90 mm	6	110,0	18,3	90,0	130,0	55,0	35,0	110,0	26,07
NR125110	A	125/110 mm	4	125,0	20,8	110,0	139,0	50,0	43,0	114,0	33,62



B

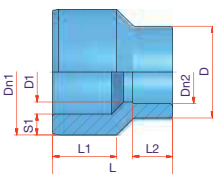

Sugerencia instalación

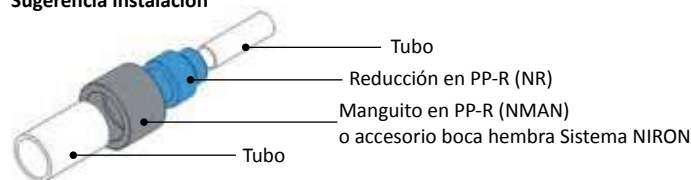

Referencia	Tipo	∅	Uds. Caja	Dn1 (mm)	S1 (mm)	Dn2 (mm)	D1 (mm)	D (mm)	L1 (mm)	L2 (mm)	L (mm)	Precio (€/ud.)
NR3220	B	32/20 mm	80	32,0	5,4	20,0	16,0	29,0	20,0	16,0	45,0	0,80
NR4020	B	40/20 mm	60	40,0	6,7	20,0	16,0	29,0	25,0	16,0	45,0	1,58
NR4025	B	40/25 mm	60	40,0	6,7	25,0	21,0	35,0	25,0	17,0	45,0	1,58
NR5020	B	50/20 mm	50	50,0	8,3	20,0	16,0	29,0	28,0	16,0	53,0	2,82
NR5025	B	50/25 mm	40	50,0	8,3	25,0	21,0	35,0	28,0	17,0	53,0	2,82
NR5032	B	50/32 mm	30	63,0	8,3	32,0	30,0	46,0	28,0	20,0	53,0	2,82
NR6325	B	63/25 mm	30	63,0	10,5	25,0	21,0	35,0	32,0	17,0	60,0	4,58
NR6332	B	63/32 mm	20	63,0	10,5	32,0	30,0	46,0	32,0	20,0	60,0	4,58
NR6340	B	63/40 mm	25	63,0	10,5	40,0	37,0	56,0	32,0	22,0	60,0	4,58
NR7520	B	75/20 mm	16	75,0	12,5	20,0	20,0	26,5	35,0	5,0	62,0	8,00
NR7525	B	75/25 mm	20	75,0	12,5	25,0	25,0	33,0	34,0	9,0	62,0	8,00
NR7532	B	75/32 mm	20	75,0	12,5	32,0	32,0	43,0	35,0	12,0	62,0	8,00
NR7540	B	75/40 mm	18	75,0	12,5	40,0	40,0	43,0	35,0	25,0	62,0	8,00
NR7550	B	75/50 mm	20	75,0	12,5	50,0	50,0	66,0	34,0	20,0	59,0	8,00
NR11063	B	110/63 mm	25	110,0	18,3	63,0	59,0	88,0	46,0	29,0	80,0	23,91



C

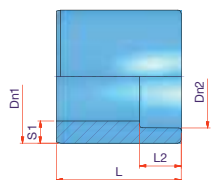

Sugerencia instalación

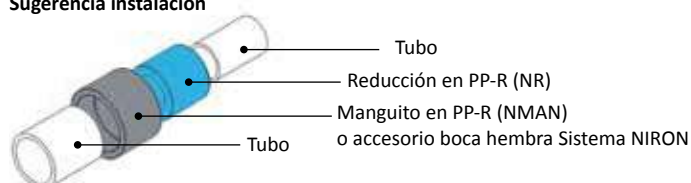

Referencia	Tipo	∅	Uds. Caja	Dn1 (mm)	S1 (mm)	Dn2 (mm)	L2 (mm)	L (mm)	Precio (€/ud.)
NR9063	C	90/63 mm	6	90,0	15,0	63,0	29,0	81,0	14,35
NR11075	C	110/75 mm	25	110,0	20,8	75,0	32,0	80,0	23,91
NR12590	C	125/90 mm	8	125,0	20,8	90,0	37,0	104,0	33,62
NR160110	C	160/110 mm	1	160,0	26,6	110,0	43,0	143,0	35,53
NR160125	C	160/125 mm	1	160,0	26,6	125,0	50,0	150,0	38,27

Accesorios termofusión

Reducciones NIRON

Reducción Macho/Hembra unión socket TIPO A

Reducción	Lado macho		Lado hembra	
NR2016	20 mm	ESTRECHO	16 mm	ANCHO
NR2516	25 mm	ESTRECHO	16 mm	ANCHO
NR2520	25 mm	ESTRECHO	20 mm	ANCHO
NR3225	32 mm	ESTRECHO	25 mm	ANCHO
NR4032	40 mm	ESTRECHO	32 mm	ANCHO
NR5040	50 mm	ESTRECHO	40 mm	ANCHO
NR6350	63 mm	ESTRECHO	50 mm	ANCHO
NR7563	75 mm	ESTRECHO	63 mm	ANCHO
NR9075	90 mm	ESTRECHO	75 mm	ANCHO
NR11090	110 mm	ESTRECHO	90 mm	ANCHO
NR125110	125 mm	ESTRECHO	110 mm	ANCHO

Reducción Macho/Hembra unión socket TIPO B

Reducción	Lado macho		Lado hembra	
NR3220	32 mm	ANCHO	20 mm	ESTRECHO
NR4020	40 mm	ANCHO	20 mm	ESTRECHO
NR4025	40 mm	ANCHO	25 mm	ESTRECHO
NR5020	50 mm	ANCHO	20 mm	ESTRECHO
NR5025	50 mm	ANCHO	25 mm	ESTRECHO
NR5032	50 mm	ANCHO	32 mm	ESTRECHO
NR6325	63 mm	ANCHO	25 mm	ESTRECHO
NR6332	63 mm	ANCHO	32 mm	ESTRECHO
NR6340	63 mm	ANCHO	40 mm	ESTRECHO
NR7520	75 mm	ANCHO	20 mm	ESTRECHO
NR7525	75 mm	ANCHO	25 mm	ESTRECHO
NR7532	75 mm	ANCHO	32 mm	ESTRECHO
NR7540	75 mm	ANCHO	40 mm	ESTRECHO
NR7550	75 mm	ANCHO	50 mm	ESTRECHO
NR11063	110 mm	ANCHO	63 mm	ESTRECHO

Reducción TIPO C

Reducción	Lado macho		Lado hembra	
NR9063	90 mm	ANCHO	63 mm	ESTRECHO
NR11075	110 mm	ANCHO	75 mm	ESTRECHO
NR12590	125 mm	ANCHO	90 mm	ESTRECHO
NR160110	160 mm	ANCHO	110 mm	ESTRECHO
NR160125	160 mm	ANCHO	160 mm	ESTRECHO

Accesorios termofusión

Reducción SDR11 macho/macho soldadura a testa o con accesorio eléctrico

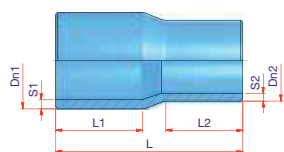

Sugerencia instalación

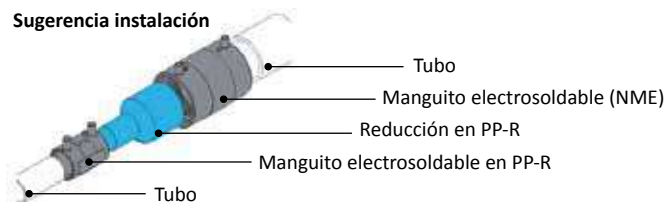

Referencia	∅	Uds. Caja	Dn1 (mm)	S1 (mm)	Dn2 (mm)	S2 (mm)	L1 (mm)	L2 (mm)	L (mm)	Precio (€/ud.)
NR754011MM	75/40 mm	16	75,0	6,8	40,0	3,7	65,0	48,0	143,0	14,46
NR755011MM	75/50 mm	16	75,0	6,8	50,0	4,6	65,0	48,0	141,0	14,46
NR756311MM	75/63 mm	12	75,0	6,8	63,0	5,8	71,0	64,0	150,0	14,46
NR905011MM	90/50 mm	12	90,0	8,2	50,0	4,6	73,0	57,0	152,0	24,87
NR906311MM	90/63 mm	12	90,0	8,2	63,0	5,8	71,0	57,0	150,0	24,87
NR907511MM	90/75 mm	8	90,0	8,2	75,0	6,8	81,0	72,0	175,0	24,87
NR1106311MM	110/63 mm	6	110,0	10,0	63,0	5,8	85,0	70,0	175,0	32,53
NR1107511MM	110/75 mm	6	110,0	10,0	75,0	6,8	88,0	58,0	185,0	32,53
NR1109011MM	110/90 mm	6	110,0	10,0	90,0	8,2	78,0	70,0	175,0	32,53
NR1257511MM	125/75 mm	3	125,0	11,4	75,0	6,8	92,0	60,0	199,0	43,98
NR1259011MM	125/90 mm	4	125,0	11,4	90,0	8,2	86,0	70,0	186,0	43,98
NR12511011MM	125/110 mm	20	125,0	11,4	110,0	10,0	89,0	77,0	187,0	43,98
NR1609011MM	160/90 mm	12	160,0	14,6	90,0	8,2	108,0	90,0	230,0	104,23
NR16011011MM	160/110 mm	1	160,0	14,6	110,0	10,0	103,0	88,0	315,0	123,09
NR16012511MM	160/125 mm	1	160,0	14,6	125,0	11,4	102,0	91,0	214,0	133,93
NR20016011MM	200/160 mm	1	200,0	18,2	160,0	14,5	118,0	101,0	240,0	141,66

Reducción SDR11 macho/macho soldadura a testa



Referencia	∅	Uds. Caja	Dn1 (mm)	S1 (mm)	Dn2 (mm)	S2 (mm)	L1 (mm)	L2 (mm)	L (mm)	Precio (€/ud.)
27NRCC25016011MM	250/160 mm	1	250,0	14,9	160,0	9,5	51,5	17,0	80,0	249,42
27NRCC25020011MM	250/200 mm	1	250,0	14,9	200,0	11,9	52,5	15,0	80,0	249,42
27NRCC31516011MM	315/160 mm	1	315,0	18,7	160,0	9,5	52,0	18,0	80,0	302,86
27NRCC31520011MM	315/200 mm	1	315,0	18,7	200,0	11,9	55,0	15,0	80,0	302,86
27NRCC31525011MM	315/250 mm	1	315,0	18,7	250,0	14,8	50,0	20,0	80,0	302,86
27NRCC35520011MM	355/200 mm	1	355,0	21,1	200,0	11,9	-	-	-	356,30
27NRCC35525011MM	355/250 mm	1	355,0	21,1	250,0	14,8	50,0	20,0	80,0	356,30
27NRCC35531511MM	355/315 mm	1	355,0	21,1	315,0	18,7	50,0	20,0	80,0	360,09
27NRCC40025011MM	400/250 mm	1	400,0	23,7	250,0	14,8	55,0	15,0	80,0	1.102,13
27NRCC40031511MM	400/315 mm	1	400,0	23,7	315,0	18,7	55,0	15,0	80,0	1.125,82
27NRCC40035511MM	400/355 mm	1	400,0	23,7	355,0	21,1	52,5	17,5	80,0	1.302,06
27NRCC45031511MM	450/315 mm	1	450,0	26,7	315,0	18,7	-	-	-	1.877,66
27NRCC45035511MM	450/355 mm	1	450,0	26,7	355,0	21,1	-	-	-	1.887,59
27NRCC45040011MM	450/400 mm	1	450,0	26,7	400,0	23,7	-	-	-	1.897,63
27NRCC50035511MM	500/355 mm	1	500,0	29,6	355,0	21,1	68,0	22,0	100,0	A consultar
27NRCC50040011MM	500/400 mm	1	500,0	29,6	400,0	23,7	68,0	22,0	100,0	A consultar
27NRCC50045011MM	500/450 mm	1	500,0	29,6	450,0	26,7	-	-	-	A consultar



Accesorios termofusión

Reducción SDR17 macho/macho soldadura a testa o con accesorio eléctrico

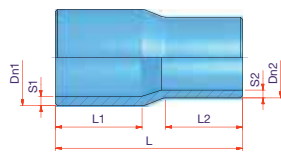

Sugerencia instalación

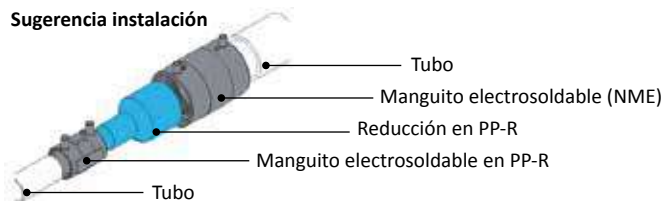

Referencia	∅	Uds. Caja	Dn1 (mm)	S1 (mm)	Dn2 (mm)	S2 (mm)	L1 (mm)	L2 (mm)	L (mm)	Precio (€/ud.)
NR16011017MM	160/110 mm	1	160,0	9,5	110,0	6,6	103,0	88,0	215,0	104,63
NR16012517MM	160/152 mm	1	160,0	9,5	152,0	7,4	120,0	91,0	214,0	113,84
NR20016017MM	200/160 mm	1	200,0	11,9	160,0	9,5	118,0	101,0	240,0	119,52

Reducción Corta SDR17 macho/macho soldadura a testa



Referencia	∅	Uds. Caja	Dn1 (mm)	S1 (mm)	Dn2 (mm)	S2 (mm)	L1 (mm)	L2 (mm)	L (mm)	Precio (€/ud.)
27NRCC40025017MM	400/250 mm	1	400,0	23,7	250,0	14,8	55,0	15,0	80,0	1.024,98
27NRCC40031517MM	400/315 mm	1	400,0	23,7	315,0	18,7	55,0	15,0	80,0	1.047,01
27NRCC40035517MM	400/355 mm	1	400,0	23,7	355,0	21,1	52,5	17,5	80,0	1.210,92
27NRCC45031517MM	450/315 mm	1	450,0	26,7	315,0	18,7	-	-	-	1.528,75
27NRCC45035517MM	450/355 mm	1	450,0	26,7	355,0	21,1	-	-	-	1.640,58
27NRCC45040017MM	450/400 mm	1	450,0	26,7	400,0	23,7	-	-	-	1.765,72
27NRCC50035517MM	500/355 mm	1	500,0	29,6	355,0	21,1	68,0	22,0	100,0	1.959,64
27NRCC50040017MM	500/400 mm	1	500,0	29,6	400,0	23,7	68,0	22,0	100,0	1.970,01
27NRCC50045017MM	500/450 mm	1	500,0	29,6	450,0	26,7	-	-	-	1.980,49
27NRCC56040017MM	560/400 mm	1	560,0	33,2	400,0	23,7	-	-	-	A consultar
27NRCC56045017MM	560/450 mm	1	560,0	33,2	450,0	26,7	-	-	-	A consultar
27NRCC56050017MM	560/500 mm	1	560,0	33,2	500,0	29,6	70,0	20,0	100,0	A consultar
27NRCC63045017MM	630/450 mm	1	630,0	37,4	450,0	26,7	-	-	-	A consultar
27NRCC63050017MM	630/500 mm	1	630,0	37,4	500,0	29,6	83,0	27,0	120,0	A consultar
27NRCC63056017MM	630/560 mm	1	630,0	37,4	560,0	33,2	-	-	-	A consultar

Accesorios termofusión

Te Reducida unión socket

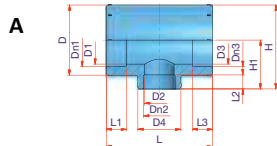

Referencia	Tipo	Ø	Uds. Caja	Dn1 (mm)	Dn2 (mm)	Dn3 (mm)	D1 (mm)	D2 (mm)	D3 (mm)	D4 (mm)	D (mm)	L1 (mm)	L2 (mm)	L3 (mm)	L (mm)	H1 (mm)	H (mm)	Precio (€/ud.)
NTR162016	A	16 x 20 x 16 mm	150	16,0	20,0	16,0	13,5	14,0	13,5	29,0	29,0	14,0	16,0	14,0	53,0	27,0	42,0	0,90
NTR201620	A	20 x 16 x 20 mm	150	20,0	16,0	20,0	16,5	13,5	16,5	29,0	29,0	16,0	14,0	16,0	53,0	27,0	42,0	0,93
NTR251625	A	25 x 16 x 25 mm	80	25,0	16,0	25,0	21,0	13,5	21,0	29,0	35,0	17,0	14,0	17,0	62,0	30,0	47,5	1,24
NTR252025	A	25 x 20 x 25 mm	80	25,0	20,0	25,0	21,0	16,5	21,0	29,0	35,0	17,0	16,0	17,0	62,0	30,0	47,5	1,24
NTR322032	A	32 x 20 x 32 mm	40	32,0	20,0	32,0	30,0	16,5	30,0	29,0	46,0	20,0	16,0	20,0	75,0	35,0	58,0	1,87
NTR322532	A	32 x 25 x 32 mm	40	32,0	25,0	32,0	30,0	21,0	30,0	35,0	46,0	20,0	17,0	20,0	75,0	35,0	58,0	1,87
NTR402040	A	40 x 20 x 40 mm	20	40,0	20,0	40,0	36,0	16,5	36,0	33,0	53,0	24,0	16,0	24,0	74,0	39,0	66,0	3,67
NTR402540	A	40 x 25 x 40 mm	25	40,0	25,0	40,0	36,0	21,0	36,0	33,0	53,0	24,0	20,0	24,0	74,0	39,0	66,0	3,67
NTR403240	A	40 x 32 x 40 mm	18	40,0	32,0	40,0	35,0	30,0	35,0	54,0	54,0	22,0	20,0	22,0	87,0	43,0	70,0	3,67
NTR502050	A	50 x 20 x 50 mm	12	50,0	20,0	50,0	47,0	16,5	47,0	43,0	66,0	26,0	16,0	26,0	87,0	47,0	80,0	6,83
NTR502550	A	50 x 25 x 50 mm	16	50,0	25,0	50,0	47,0	21,0	47,0	43,0	66,0	26,0	20,0	26,0	87,0	47,0	80,0	6,83
NTR503250	A	50 x 32 x 50 mm	16	50,0	32,0	50,0	47,0	30,0	47,0	43,0	66,0	26,0	20,0	26,0	87,0	47,0	80,0	6,83
NTR504050	A	50 x 40 x 50 mm	10	50,0	40,0	50,0	43,0	36,0	43,0	66,0	66,0	23,0	22,0	23,0	102,0	50,0	83,0	6,83
NTR632563	A	63 x 25 x 63 mm	10	63,0	25,0	63,0	60,0	21,0	60,0	53,0	83,0	30,0	21,0	30,0	102,0	54,0	96,0	9,44
NTR633263	A	63 x 32 x 63 mm	6	63,0	32,0	63,0	60,0	30,0	60,0	53,0	83,0	30,0	21,0	30,0	102,0	54,0	96,0	9,44
NTR634063	A	63 x 40 x 63 mm	6	63,0	40,0	63,0	60,0	36,0	60,0	53,0	83,0	30,0	23,0	30,0	102,0	54,0	96,0	9,44
NTR635063	A	63 x 50 x 63 mm	6	63,0	50,0	63,0	50,0	46,0	50,0	80,0	80,0	25,0	26,0	25,0	122,0	64,0	104,0	9,44
NTR753275	A	75 x 32 x 75 mm	16	75,0	32,0	75,0	60,0	22,0	60,0	43,0	98,0	30,0	18,0	30,0	139,0	67,0	116,0	19,70
NTR754075	A	75 x 40 x 75 mm	14	75,0	40,0	75,0	60,0	36,0	60,0	65,0	98,0	30,0	23,0	30,0	139,0	69,0	118,0	19,70
NTR755075	A	75 x 50 x 75 mm	14	75,0	50,0	75,0	70,0	46,0	70,0	70,0	101,0	33,0	25,0	33,0	146,0	73,0	123,5	19,70
NTR756375	A	75 x 63 x 75 mm	14	75,0	63,0	75,0	70,0	59,0	70,0	86,0	101,0	33,0	29,0	33,0	146,0	73,0	123,5	19,70
NTR906390	A	90 x 63 x 90 mm	8	90,0	63,0	90,0	78,0	50,0	78,0	85,0	120,0	33,0	27,0	33,0	160,0	73,0	133,0	31,80
NTR907590	A	90 x 75 x 90 mm	10	90,0	75,0	90,0	87,0	71,0	87,0	114,0	114,0	37,0	33,0	37,0	167,0	83,0	140,0	31,80
NTR11063110	A	110 x 63 x 110 mm	5	110,0	63,0	110,0	100,0	59,0	100,0	86,0	146,0	43,0	33,0	43,0	200,0	100,0	173,0	51,36
NTR11075110	A	110 x 75 x 110 mm	5	110,0	75,0	110,0	100,0	69,0	100,0	101,0	146,0	43,0	33,0	43,0	200,0	100,0	173,0	51,36
NTR11090110	A	110 x 90 x 110 mm	4	110,0	90,0	110,0	100,0	85,0	100,0	119,0	146,0	43,0	37,0	43,0	200,0	100,0	173,0	51,36
NTR12575125	A	125 x 75 x 125 mm	20	125,0	75,0	125,0	113,0	69,0	113,0	101,0	165,0	47,5	33,0	47,5	250,0	115,0	197,5	67,07
NTR12590125	A	125 x 90 x 125 mm	3	125,0	90,0	125,0	113,0	85,0	113,0	122,0	135,0	47,5	37,0	47,5	250,0	115,0	197,5	67,07
NTR125110125	A	125 x 110 x 125 mm	20	125,0	110,0	125,0	113,0	100,0	113,0	146,0	165,0	47,5	250,0	120,0	250,0	120,0	202,5	67,07

Te Reducida unión socket

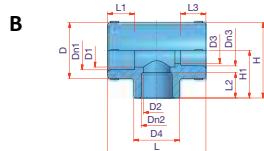

Referencia	Tipo	Ø	Uds. Caja	Dn1 (mm)	Dn2 (mm)	Dn3 (mm)	D1 (mm)	D2 (mm)	D3 (mm)	D4 (mm)	D (mm)	L1 (mm)	L2 (mm)	L3 (mm)	L (mm)	H1 (mm)	H (mm)	Precio (€/ud.)
NTR201616	B	20 x 16 x 16 mm	150	20,0	16,0	16,0	14,0	13,5	13,5	29,0	29,0	16,0	14,0	14,0	53,0	27,0	42,0	0,93
NTR252020	B	25 x 20 x 20 mm	80	25,0	20,0	20,0	21,0	16,5	16,5	29,0	35,0	17,0	16,0	16,0	62,0	30,0	47,5	1,24
NTR322525	B	32 x 25 x 25 mm	40	32,0	25,0	25,0	30,0	21,0	21,0	35,0	46,0	20,0	17,0	17,0	75,0	35,0	58,0	1,87



Accesorios termofusión

Te Reducida unión socket

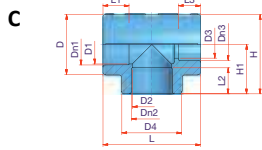

Referencia	Tipo	Ø	Uds. Caja	Dn1 (mm)	Dn2 (mm)	Dn3 (mm)	D1 (mm)	D2 (mm)	D3 (mm)	D4 (mm)	D (mm)	L1 (mm)	L2 (mm)	L3 (mm)	L (mm)	H1 (mm)	H (mm)	Precio (€/ud.)
NTR202016	C	20 x 20 x 16 mm	150	20,0	20,0	16,0	14,0	14,0	13,5	29,0	29,0	16,0	16,0	14,0	53,0	27,0	42,0	0,93
NTR252520	C	25 x 25 x 20 mm	90	25,0	25,0	20,0	21,0	21,0	16,5	35,0	35,0	17,0	17,0	16,0	62,0	30,0	47,5	1,24
NTR323225	C	32 x 32 x 25 mm	40	32,0	32,0	25,0	30,0	30,0	21,0	46,0	46,0	20,0	20,0	17,0	75,0	38,0	61,0	1,87

Te Reducida unión socket

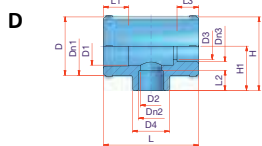

Referencia	Tipo	Ø	Uds. Caja	Dn1 (mm)	Dn2 (mm)	Dn3 (mm)	D1 (mm)	D2 (mm)	D3 (mm)	D4 (mm)	D (mm)	L1 (mm)	L2 (mm)	L3 (mm)	L (mm)	H1 (mm)	H (mm)	Precio (€/ud.)
NTR322020	D	32 x 20 x 20 mm	50	32,0	20,0	20,0	30,0	16,5	16,5	29,0	46,0	20,0	16,0	16,0	75,0	35,0	58,0	1,87
NTR322025	D	32 x 20 x 25 mm	40	32,0	20,0	25,0	30,0	16,5	21,0	29,0	46,0	20,0	16,0	17,0	75,0	35,0	58,0	1,87

Accesorios termofusión

Te reducida - SDR11 macho/macho/macho soldadura a testa o accesorio eléctrico

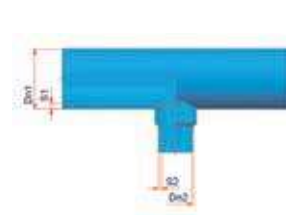
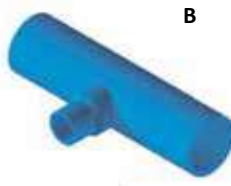
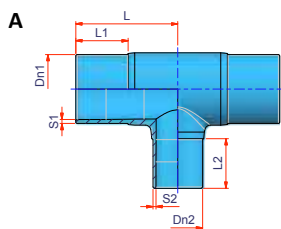
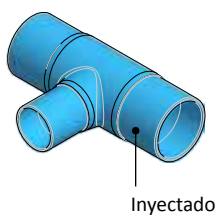

Referencia	Tipo	Ø	Uds. Caja	Dn1 (mm)	Dn2 (mm)	S1 (mm)	S2 (mm)	L1 (mm)	L2 (mm)	L (mm)	Precio (€/ud.)
NTRS1116063MM	A	160 x 63 x 160 mm	1	160,0	63,0	14,6	5,8	103,0	70,0	190,0	197,48
NTRS1116075MM	A	160 x 75 x 160 mm	1	160,0	75,0	14,6	6,8	103,0	75,0	190,0	197,48
NTRS1116090MM	A	160 x 90 x 160 mm	1	160,0	90,0	14,6	8,2	103,0	90,0	190,0	201,02
NTRS11160110MM	A	160 x 110 x 160 mm	1	160,0	110,0	14,6	10,0	103,0	87,0	190,0	201,72
NTRS11160125MM	A	160 x 125 x 160 mm	1	160,0	125,0	14,6	11,4	103,0	95,0	190,0	203,65
NTRS1120063MM	A	200 x 63 x 200 mm	1	200,0	63,0	18,2	5,8	117,0	70,0	230,0	249,42
NTRS1120075MM	A	200 x 75 x 200 mm	1	200,0	75,0	18,2	6,8	117,0	75,0	230,0	249,42
NTRS1120090MM	A	200 x 90 x 200 mm	1	200,0	90,0	18,2	8,2	117,0	90,0	230,0	249,42
NTRS11200110MM	A	200 x 110 x 200 mm	1	200,0	110,0	18,2	10,0	117,0	87,0	230,0	294,40
NTRS11200125MM	A	200 x 125 x 200 mm	1	200,0	125,0	18,2	11,4	117,0	95,0	230,0	304,20
NTRS11200160MM	A	200 x 160 x 200 mm	1	200,0	160,0	18,2	14,6	117,0	103,0	230,0	369,83
NTRS1125090MM	A	250 x 90 x 250 mm	1	250,0	90,0	22,7	8,2	134,0	90,0	255,0	365,11
NTRS11250110MM	A	250 x 110 x 250 mm	1	250,0	110,0	22,7	10,0	134,0	116,0	255,0	358,55
NTRS11250125MM	A	250 x 125 x 250 mm	1	250,0	125,0	22,7	11,4	134,0	95,0	255,0	375,32
NTRS11250160MM	A	250 x 160 x 250 mm	1	250,0	160,0	22,7	14,6	134,0	105,0	255,0	539,72
NTRS11250200MM	A	250 x 200 x 250 mm	1	250,0	200,0	22,7	18,2	134,0	116,0	255,0	518,52
NTR11315125M315	B	315 x 125 x 315 mm	1	315,0	125,0	28,6	11,4	-	-	-	534,46
NTR11315160M315	B	315 x 160 x 315 mm	1	315,0	160,0	28,6	14,6	-	-	-	628,97
NTR11315200M315	B	315 x 200 x 315 mm	1	315,0	200,0	28,6	18,2	-	-	-	926,04
NTR11315250M315	B	315 x 250 x 315 mm	1	315,0	250,0	28,6	22,7	-	-	-	933,03
NTR11355125M355	B	355 x 125 x 355 mm	1	355,0	125,0	32,3	11,4	-	-	-	733,97
NTR11355160M355	B	355 x 160 x 355 mm	1	355,0	160,0	32,3	14,6	-	-	-	733,97
NTR11355200M355	B	355 x 200 x 355 mm	1	355,0	200,0	32,3	18,2	-	-	-	783,84
NTR11400125M400	B	400 x 125 x 400 mm	1	400,0	125,0	36,3	11,4	-	-	-	914,58
NTR11400160M400	B	400 x 160 x 400 mm	1	400,0	160,0	36,3	14,6	-	-	-	1.068,88
NTR11400200M400	B	400 x 200 x 400 mm	1	400,0	200,0	36,3	18,2	-	-	-	1.068,88
NTR11400250M400	B	400 x 250 x 400 mm	1	400,0	250,0	36,3	22,7	-	-	-	1.247,06
NTR11450125M450	B	450 x 125 x 450 mm	1	450,0	125,0	40,9	11,4	-	-	-	1.247,06
NTR11450160M450	B	450 x 160 x 450 mm	1	450,0	160,0	40,9	14,6	-	-	-	1.263,46
NTR11450200M450	B	450 x 200 x 450 mm	1	450,0	200,0	40,9	18,2	-	-	-	1.389,57
NTR11450250M450	B	450 x 250 x 450 mm	1	450,0	250,0	40,9	22,7	-	-	-	1.389,57
NTR11450315M450	B	450 x 315 x 450 mm	1	450,0	315,0	40,9	28,6	-	-	-	1.389,57

En función del stock disponible, los accesorios tipo A pueden ser inyectados o manipulados (Te + Reducción).

La empresa fabricante se reserva el derecho a proveer el accesorio tipo A inyectado o manipulado en función de las necesidades.



Accesorios termofusión

Te reducida - SDR17 macho/macho/macho soldadura a testa o accesorio eléctrico

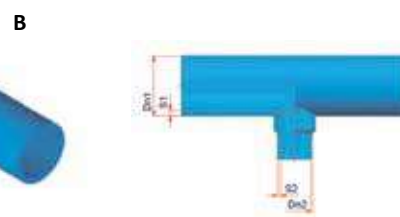
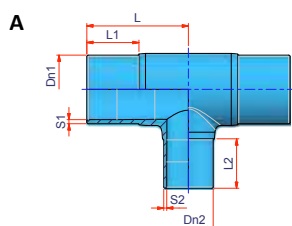
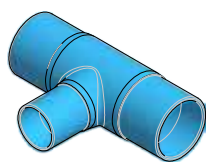

Referencia	Tipo	Ø	Uds. Caja	Dn1 (mm)	Dn2 (mm)	S1 min. (mm)	S2 min. (mm)	L1 (mm)	L2 (mm)	L (mm)	Precio (€/ud.)
NTRS1716075MM	A	160 x 75 x 160 mm	1	160,0	75,0	9,5	4,5	103,0	75,0	190,0	177,73
NTRS1716090MM	A	160 x 90 x 160 mm	1	160,0	90,0	9,5	5,4	103,0	90,0	190,0	180,93
NTRS17160110MM	A	160 x 110 x 160 mm	1	160,0	110,0	9,5	6,6	103,0	87,0	190,0	181,54
NTRS17160125MM	A	160 x 125 x 160 mm	1	160,0	125,0	9,5	7,4	103,0	95,0	190,0	183,29
NTRS1720075MM	A	200 x 75 x 200 mm	1	200,0	75,0	11,9	4,5	117,0	75,0	230,0	214,05
NTRS1720090MM	A	200 x 90 x 200 mm	1	200,0	90,0	11,9	5,4	117,0	90,0	230,0	214,17
NTRS17200110MM	A	200 x 110 x 200 mm	1	200,0	110,0	11,9	6,6	117,0	87,0	230,0	264,96
NTRS17200125MM	A	200 x 125 x 200 mm	1	200,0	125,0	11,9	7,4	117,0	95,0	230,0	273,79
NTRS17200160MM	A	200 x 160 x 200 mm	1	200,0	160,0	11,9	9,5	117,0	103,0	230,0	388,88
NTRS1725090MM	A	250 x 90 x 250 mm	1	250,0	90,0	14,8	5,4	134,0	90,0	255,0	328,60
NTRS17250110MM	A	250 x 110 x 250 mm	1	250,0	110,0	14,8	6,6	134,0	116,0	255,0	329,67
NTRS17250125MM	A	250 x 125 x 250 mm	1	250,0	125,0	14,8	7,4	134,0	95,0	255,0	337,78
NTRS17250160MM	A	250 x 160 x 250 mm	1	250,0	160,0	14,8	9,5	134,0	105,0	255,0	489,35
NTRS17250200MM	A	250 x 200 x 250 mm	1	250,0	200,0	14,8	11,9	134,0	116,0	255,0	492,03
NTR17315125M315	B	315 x 125 x 315 mm	1	315,0	125,0	18,7	0,29	-	-	-	534,46
NTR17315160M315	B	315 x 160 x 315 mm	1	315,0	160,0	18,7	0,37	-	-	-	618,41
NTR17315200M315	B	315 x 200 x 315 mm	1	315,0	200,0	18,7	0,47	-	-	-	830,69
NTR17315250M315	B	315 x 250 x 315 mm	1	315,0	250,0	18,7	0,15	-	-	-	832,00
NTR17355160M355	B	355 x 160 x 355 mm	1	355,0	160,0	21,1	0,18	-	-	-	675,56
NTR17355200M355	B	355 x 200 x 355 mm	1	355,0	200,0	21,1	0,21	-	-	-	864,70
NTR17400160M400	B	400 x 160 x 400 mm	1	400,0	160,0	23,7	0,29	-	-	-	712,61
NTR17400200M400	B	400 x 200 x 400 mm	1	400,0	200,0	23,7	0,29	-	-	-	712,61
NTR17400250M400	B	400 x 250 x 400 mm	1	400,0	250,0	23,7	0,29	-	-	-	712,61
NTR17450160M450	B	450 x 160 x 450 mm	1	450,0	160,0	26,7	0,29	-	-	-	859,79
NTR17450200M450	B	450 x 200 x 450 mm	1	450,0	200,0	26,7	0,29	-	-	-	859,79
NTR17450250M450	B	450 x 250 x 450 mm	1	450,0	250,0	26,7	0,29	-	-	-	859,79
NTR17450315M450	B	450 x 315 x 450 mm	1	450,0	315,0	26,7	0,29	-	-	-	1.163,55
NTR17500160M500	B	500 x 160 x 500 mm	1	500,0	160,0	29,7	0,29	-	-	-	1.169,64
NTR17500200M500	B	500 x 200 x 500 mm	1	500,0	200,0	29,7	0,29	-	-	-	1.175,80
NTR17500250M500	B	500 x 250 x 500 mm	1	500,0	250,0	29,7	0,29	-	-	-	1.182,02
NTR17500315M500	B	500 x 315 x 500 mm	1	500,0	315,0	29,7	0,29	-	-	-	1.192,80
NTR17500355M500	B	500 x 355 x 500 mm	1	500,0	355,0	29,7	0,29	-	-	-	3.408,66
NTR17500400M500	B	500 x 400 x 500 mm	1	500,0	400,0	29,7	0,29	-	-	-	3.545,48
NTR17500450M500	B	500 x 450 x 500 mm	1	500,0	450,0	29,7	0,29	-	-	-	3.677,25
NTR17560160M560	B	560 x 160 x 560 mm	1	560,0	160,0	33,2	0,29	-	-	-	1.461,62
NTR17560200M560	B	560 x 200 x 560 mm	1	560,0	200,0	33,2	0,29	-	-	-	1.463,40
NTR17560250M560	B	560 x 250 x 560 mm	1	560,0	250,0	33,2	0,29	-	-	-	1.464,54
NTR17560315M560	B	560 x 315 x 560 mm	1	560,0	315,0	33,2	0,29	-	-	-	1.511,00
NTR17560355M560	B	560 x 355 x 560 mm	1	560,0	355,0	33,2	0,29	-	-	-	4.538,93
NTR17560400M560	B	560 x 400 x 560 mm	1	560,0	400,0	33,2	0,37	-	-	-	5.157,61

En función del stock disponible, los accesorios tipo A pueden ser inyectados o manipulados (Te + Reducción).

La empresa fabricante se reserva el derecho a proveer el accesorio tipo A inyectado o manipulado en función de las necesidades.

Accesorios termofusión

Tapón unión socket

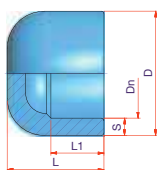

Referencia	∅	Uds. Caja	Dn (mm)	D (mm)	L1 (mm)	L (mm)	Precio (€/ud.)
NCC16	16 mm	250	16,0	23,5	13,5	24,0	0,78
NCC20	20 mm	100	20,0	30,0	17,0	29,0	0,78
NCC25	25 mm	100	25,0	35,5	18,0	34,0	0,97
NCC32	32 mm	50	32,0	45,0	20,0	40,0	1,30
NCC40	40 mm	40	40,0	54,0	22,0	42,0	2,45
NCC50	50 mm	35	50,0	66,0	25,5	48,0	3,91
NCC63	63 mm	30	63,0	83,0	34,0	56,0	6,69
NCC75	75 mm	12	75,0	99,0	43,0	61,0	9,20
NCC90	90 mm	30	90,0	120,0	37,0	62,0	20,11
NCC110	110 mm	20	110,0	148,0	28,0	68,0	26,05
NCC125	125 mm	12	125,0	168,0	47,5	80,5	35,08

Tapón SDR11 Largo soldadura a testa o accesorio eléctrico

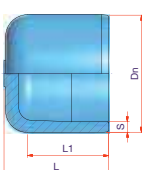

Referencia	∅	Uds. Caja	Dn (mm)	S (mm)	L1 (mm)	L (mm)	Precio (€/ud.)
NCC16011M	160 mm	1	160,0	14,6	108,0	142,0	59,40
NCC20011M	200 mm	1	200,0	18,2	133,0	172,0	73,38

Tapón SDR11 Corto Soldadura a testa

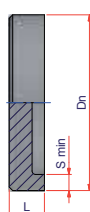

Referencia	∅	Uds. Caja	Dn (mm)	S (mm)	L (mm)	Precio (€/ud.)
27NCC25011MS	250 mm	1	250,0	22,7	50,0	239,42
27NCC31511MS	315 mm	1	315,0	28,6	118,0	425,04
27NCC35511MS	355 mm	1	355,0	32,2	80,0	638,09
27NCC40011MS	400 mm	1	400,0	36,3	80,0	988,26
27NCC45011MS	450 mm	1	450,0	40,9	80,0	1.332,16

Accesorios termofusión

Tapón SDR17 corto soldadura a testa

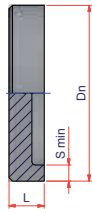

Referencia	∅	Uds. Caja	Dn (mm)	S min. (mm)	L (mm)	Precio (€/ud.)
27NCC31517MS	315 mm	1	315,0	18,7	50,0	413,66
27NCC35517MS	355 mm	1	355,0	21,1	50,0	579,09
27NCC40017MS	400 mm	1	400,0	23,7	80,0	839,10
27NCC45017MS	450 mm	1	450,0	26,7	80,0	1.116,80
27NCC50017MS	500 mm	1	500,0	29,7	80,0	1.524,57
27NCC56017MS	560 mm	1	560,0	33,1	80,0	2.137,79
27NCC63017MS	630 mm	1	630,0	37,2	100,0	2.672,25

Accesorios termofusión

Curva 90° hembra/hembra unión socket



Referencia	∅	Uds. Caja	Dn (mm)	D (mm)	L1 (mm)	L (mm)	H (mm)	Precio (€/ud.)
NCLR20	20 mm	70	20,0	28,0	16,0	55,0	55,0	2,17
NCLR25	25 mm	50	25,0	34,0	16,0	65,0	65,0	2,82

Curva 90° macho/hembra unión socket

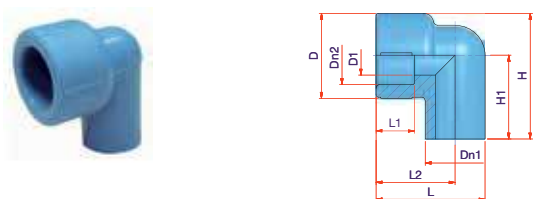

Referencia	∅	Uds. Caja	Dn1 (mm)	Dn2 (mm)	D1 (mm)	D (mm)	L1 (mm)	L2 (mm)	L (mm)	H1 (mm)	H (mm)	Precio (€/ud.)
NGMF20	20 mm	100	20,0	20,0	13,2	30,0	16,0	29,0	39,0	28,5	43,5	0,93
NGMF25	25 mm	60	25,0	25,0	16,6	35,0	16,0	33,0	45,5	35,0	52,5	1,18
NGMF32	32 mm	30	32,0	32,0	24,0	43,0	20,0	34,0	50,0	47,5	68,5	2,39
NGMF40	40 mm	20	40,0	40,0	24,0	43,0	20,0	34,0	50,0	47,5	68,5	3,34

Curva 45° macho/hembra unión socket

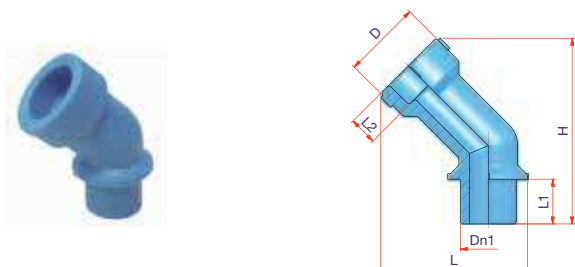

Referencia	∅	Uds. Caja	Dn1 (mm)	D (mm)	L1 (mm)	L2 (mm)	L (mm)	H (mm)	Precio (€/ud.)
NCMF4520	20 mm	100	20,0	28,0	16,0	10,0	53,0	66,0	1,00
NCMF4525	25 mm	1	25,0	35,0	17,0	12,0	56,5	72,0	1,21



Accesorios termofusión

Desviación salvatubo macho unión socket

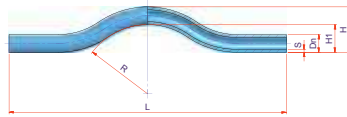

Referencia	∅	Uds. Caja	Dn (mm)	S (mm)	R (mm)	L (mm)	H1 (mm)	H (mm)	Precio (€/ud.)
NSOR20	20 mm	50	20,0	3,4	100,0	390,0	39,0	59,0	2,72
NSOR25	25 mm	35	25,0	4,2	97,5	390,0	39,0	64,0	3,28
NSOR32	32 mm	20	32,0	5,4	94,0	390,0	39,0	71,0	4,10

Desviación salvatubo compacto hembra/hembra unión socket

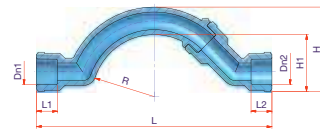

Referencia	∅	Uds. Caja	Dn1 (mm)	Dn2 (mm)	R (mm)	L1 (mm)	L2 (mm)	L (mm)	H1 (mm)	H (mm)	Precio (€/ud.)
NSOFF20	20 mm	60	20,0	20,0	47,5	16,0	16,0	180,0	43,0	64,0	3,10
NSOFF25	25 mm	30	25,0	25,0	45,5	17,0	17,0	182,0	41,0	66,0	4,53

Desviación salvatubo compacto macho/hembra unión socket

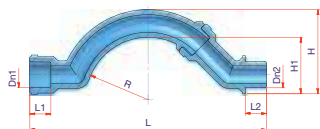

Referencia	∅	Uds. Caja	Dn1 (mm)	Dn2 (mm)	R (mm)	L1 (mm)	L2 (mm)	L (mm)	H1 (mm)	H (mm)	Precio (€/ud.)
NSOFM20	20 mm	60	20,0	20,0	47,5	16,0	16,0	180,0	43,0	64,0	3,10
NSOFM25	25 mm	30	25,0	25,0	45,5	17,0	17,0	182,0	41,0	66,0	4,60

Accesorios termofusión

Cruz reducida unión socket

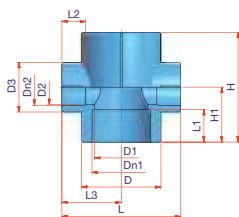

Referencia	∅	Uds. Caja	Dn1 (mm)	Dn2 (mm)	D1 (mm)	D2 (mm)	D3 (mm)	D (mm)	L1 (mm)	L2 (mm)	L3 (mm)	L (mm)	H1 (mm)	H (mm)	Precio (€/ud.)
NCR402020	40-20-20-40 mm	16	40,0	20,0	36,0	16,5	33,0	53,0	22,0	16,0	37,0	74,0	40,0	80,0	8,17
NCR402525	40-25-25-40 mm	20	40,0	25,0	36,0	23,5	33,0	53,0	22,0	16,0	37,0	74,0	40,0	80,0	8,17

Codo 3 vías unión socket

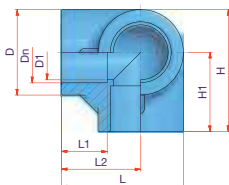

Referencia	∅	Uds. Caja	Dn1 (mm)	Dn2 (mm)	R (mm)	L1 (mm)	L2 (mm)	L (mm)	H1 (mm)	H (mm)	Precio (€/ud.)
NCTV20	20 mm	150	20,0	18,0	28,0	15,0	26,0	40,0	26,0	40,0	1,82



Accesorios termofusión

Derivación en asiento / Injertos unión socket

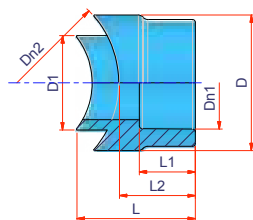

Referencia	Ø tubo	Ø salida	Uds. Caja	Dn1 (mm)	Dn2 (mm)	D1 (mm)	D (mm)	L1 (mm)	L2 (mm)	L (mm)	Precio (€/ud.)
NGS2040	40 mm	20	1	20,0	40	25,0	35,0	15,0	20,0	36,7	2,52
NGS2050	50 mm	20	1	20,0	50	25,0	35,0	15,0	20,0	32,4	2,41
NGS206375	63-75 mm	20	1	20,0	63-75	25,0	35,0	15,0	20,0	30,5	2,41
NGS2090110125	90-110-125 mm	20	1	20,0	90-110-125	25,0	35,0	15,0	20,0	29,5	2,41
NGS20160200	160-200 mm	20	1	20,0	160-200	25,0	35,0	15,0	20,0	28,5	5,53
NGS20250315	250-315 mm	20	1	20,0	250-315	25,0	35,0	15,0	20,0	28,0	5,53
NGS20355630	355-630 mm	20	1	20,0	355-630	25,0	35,0	15,0	20,0	28,0	12,88
NGS2540	40 mm	25	1	25,0	40	25,0	35,0	16,5	21,5	38,0	2,52
NGS2550	50 mm	25	1	25,0	50	25,0	35,0	16,5	21,5	33,9	2,41
NGS256375	63-75 mm	25	1	25,0	63-75	25,0	35,0	16,5	21,5	32,0	2,41
NGS2590110125	90-110-125 mm	25	1	25,0	90-110-125	25,0	35,0	16,5	21,5	30,5	2,41
NGS25160200	160-200 mm	25	1	25,0	160-200	25,0	35,0	16,5	21,5	30,0	5,53
NGS25250315	250-315 mm	25	1	25,0	250-315	25,0	35,0	16,5	21,5	29,5	5,53
NGS25355630	355-630 mm	25	1	25,0	355-630	25,0	35,0	16,5	21,5	29,5	12,88
NGS326375	63-75 mm	32	1	32,0	63-75	32,0	46,0	19,0	26,0	40,0	2,41
NGS3290110125	90-110-125 mm	32	1	32,0	90-110-125	32,0	46,0	19,0	26,0	38,0	2,41
NGS32160200	160-200 mm	32	1	32,0	160-200	32,0	46,0	19,0	26,0	36,5	5,88
NGS32250315	250-315 mm	32	1	32,0	250-315	32,0	46,0	19,0	26,0	36,0	5,88
NGS32355630	355-630 mm	32	1	32,0	355-630	32,0	46,0	19,0	26,0	36,0	12,96
NGS4090	90 mm	40	1	40,0	90	40,0	58,0	21,0	28,0	42,8	2,86
NGS40110	110 mm	40	1	40,0	110	40,0	58,0	21,0	28,0	41,8	2,86
NGS40125	125 mm	40	1	40,0	125	40,0	58,0	21,0	28,0	40,7	2,86
NGS40160200	160-200 mm	40	1	40,0	160-200	40,0	58,0	21,0	28,0	39,0	5,88
NGS40250315	250-315 mm	40	1	40,0	250-315	40,0	58,0	21,0	28,0	38,5	10,02
NGS40355630	355-630 mm	40	1	40,0	355-630	25,0	35,0	16,5	21,5	29,5	24,96
NGS5090	90 mm	50	1	50,0	90	50,0	72,0	25,0	36,0	59,0	3,70
NGS50110	110 mm	50	1	50,0	110	50,0	72,0	25,0	36,0	56,0	3,70
NGS50125	125 mm	50	1	50,0	125	50,0	72,0	25,0	36,0	54,0	3,70
NGS50160	160 mm	50	1	50,0	160	50,0	72,0	25,0	36,0	53,0	8,67
NGS50200	200 mm	50	1	50,0	200	50,0	72,0	25,0	36,0	51,5	9,57
NGS50250	250 mm	50	1	50,0	250	50,0	72,0	25,0	36,0	51,0	8,01
NGS50315	315 mm	50	1	50,0	315	50,0	72,0	25,0	36,0	50,0	20,72
NGS50355450	355-450 mm	50	1	50,0	355-450	50,0	72,0	25,0	36,0	50,0	25,75
NGS50500630	500-630 mm	50	1	50,0	500-630	50,0	72,0	25,0	36,0	50,0	42,92
NGS63110	110 mm	63	1	63,0	110	63,0	90,0	29,0	40,0	65,0	5,04
NGS63125	125 mm	63	1	63,0	125	63,0	90,0	29,0	40,0	63,0	5,04
NGS63160	160 mm	63	1	63,0	160	63,0	90,0	29,0	40,0	59,5	7,23
NGS63200	200 mm	63	1	63,0	200	63,0	90,0	29,0	40,0	58,0	9,80
NGS63250	250 mm	63	1	63,0	250	63,0	90,0	29,0	40,0	56,0	9,57
NGS63315	315 mm	63	1	63,0	315	63,0	90,0	29,0	40,0	55,0	31,79
NGS63355450	355-450 mm	63	1	63,0	355-450	63,0	90,0	29,0	40,0	54,5	42,92
NGS63500630	500-630 mm	63	1	63,0	500-630	63,0	90,0	29,0	40,0	54,0	64,38

Procedimiento de soldadura Unión socket hasta diámetro 125mm Según norma DVS 2207

Ø Tubería	Calentamiento (segundos)	Ensamblaje (segundos)	Prueba a los minutos	Inserción tubo (mm)
16 mm	5	4	2	13
20 mm	5	4	2	14
25 mm	7	4	3	15
32 mm	8	6	4	17
40 mm	12	6	4	18
50 mm	18	6	4	20
63 mm	24	8	6	26
75 mm	30	8	6	29
90 mm	40	8	6	32
110 mm	50	10	8	35
125 mm	60	10	8	40

Injerto	Calentamiento (segundos)	Ensamblaje (segundos)	Prueba a los minutos
25 mm	7	4	10
32 mm	8	6	10

El tiempo de calentamiento se inicia cuando la tubería y el accesorio alcanzan la profundidad de inserción de la tabla adjunta. No se deben superar las profundidades de inserción debido que puede derivar en un problema de obturación de la tubería en diámetros pequeños.





Accesorios termofusión roscados

Accesorios termofusión roscados

Enlace rosca hembra unión socket

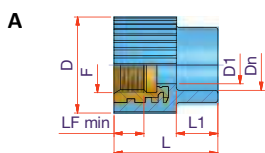

Referencia	Tipo	∅	Uds. Caja	Dn (mm)	F	LFmin (mm)	D1 (mm)	D (mm)	L1 (mm)	L (mm)	Precio (€/ud.)
NRFF1612	A	16 mm	70	16,0	1/2"	11,5	14,1	37,0	15,0	40,0	5,66
NRFF2012	A	20 mm	70	20,0	1/2"	11,5	14,1	37,0	16,0	40,0	5,46
NRFF2034	A	20 mm	60	20,0	3/4"	13,2	18,0	43,0	20,5	46,0	6,23
NRFF2512	A	25 mm	70	25,0	1/2"	11,5	14,1	37,0	17,0	41,0	5,77
NRFF2534	A	25 mm	60	25,0	3/4"	13,2	18,0	42,0	18,0	46,0	6,30
NRFF3234	A	32 mm	40	32,0	3/4"	13,2	18,0	45,5	21,5	51,5	10,82
NRFF321	A	32 mm	40	32,0	1"	18,0	24,0	54,0	20,0	52,0	17,20

Enlace rosca hembra hexagonal unión socket

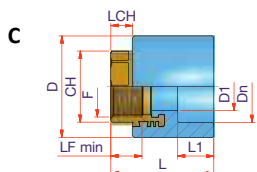
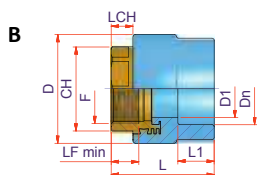

Referencia	Tipo	∅	Uds. Caja	Dn (mm)	F	LFmin (mm)	D1 (mm)	D (mm)	L1 (mm)	L (mm)	CH (mm)	LCH (mm)	Precio (€/ud.)
NRFF401	C	40 mm	30	40,0	1"	18,0	24,0	56,0	22,0	67,0	38,0	15,0	18,64
NRFF40114	B	40 mm	25	40,0	1¼"	21,4	33,0	66,0	22,0	69,0	46,0	15,0	30,53
NRFF50114	C	50 mm	25	50,0	1¼"	21,4	33,0	70,0	25,0	71,0	46,0	15,0	31,82
NRFF50112	B	50 mm	14	50,0	1½"	19,0	39,5	75,0	25,0	72,0	55,0	15,0	36,66
NRFF63112	C	63 mm	15	63,0	1½"	19,0	39,5	88,0	29,0	71,0	55,0	15,0	39,55
NRFF632	B	63 mm	12	63,0	2"	23,7	50,0	92,0	29,0	80,0	65,0	20,0	57,22
NRFF752	C	75 mm	8	75,0	2"	23,7	50,0	103,0	33,0	84,0	65,0	20,0	55,54
NRFF75212	B	75 mm	6	75,0	2½"	30,2	63,5	110,0	33,0	89,0	80,0	20,0	72,59
NRFF903	B	90 mm	4	90,0	3"	33,3	75,0	129,0	37,0	99,0	95,0	23,0	143,06
NRFF1104	B	110 mm	2	110,0	4"	39,3	99,5	160,0	43,0	111,0	120,0	30,0	147,27
NRFF1254	C	125 mm	1	125,0	4"	39,3	99,5	160,0	47,5	115,5	120,0	30,0	169,82



Accesorios termofusión roscados

Enlace rosca macho unión socket

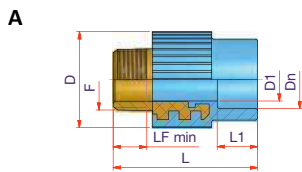

Referencia	Tipo	∅	Uds. Caja	Dn (mm)	F	LFmin (mm)	D1 (mm)	D (mm)	L1 (mm)	L (mm)	Precio (€/ud.)
NRFM1612	A	16 mm	70	16,0	1/2"	13,2	14,1	37,0	15,0	55,0	5,93
NRFM2012	A	20 mm	70	20,0	1/2"	13,2	14,1	37,0	16,0	55,0	5,93
NRFM2034	A	20 mm	50	20,0	3/4"	14,5	18,0	43,0	20,5	63,0	6,83
NRFM2512	A	25 mm	70	25,0	1/2"	13,2	14,1	37,0	17,0	56,0	6,63
NRFM2534	A	25 mm	50	25,0	3/4"	14,5	18,0	42,0	17,5	62,0	7,04
NRFM3234	A	32 mm	40	32,0	3/4"	14,5	18,0	45,5	20,0	68,5	12,26
NRFM321	A	32 mm	30	32,0	1"	16,8	24,0	54,0	20,0	71,0	15,98

Enlace rosca macho hexagonal unión socket

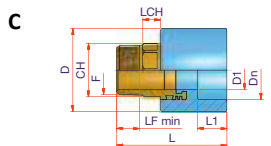
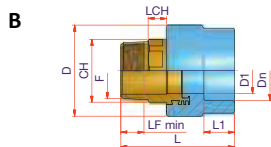

Referencia	Tipo	∅	Uds. Caja	Dn (mm)	F	LFmin (mm)	D1 (mm)	D (mm)	L1 (mm)	L (mm)	CH (mm)	LCH (mm)	Precio (€/ud.)
NRFM401	C	40 mm	25	40,0	1"	16,8	24,0	56,0	22,0	86,0	34,0	13,0	22,36
NRFM40114	B	40 mm	20	40,0	1¼"	19,1	33,0	65,0	22,0	91,0	42,0	15,0	30,93
NRFM50114	C	50 mm	20	50,0	1¼"	19,1	33,0	70,0	25,0	93,0	42,0	15,0	30,64
NRFM50112	B	50 mm	15	50,0	1½"	19,1	33,0	70,0	25,0	93,0	42,0	15,0	39,96
NRFM63112	C	63 mm	10	63,0	1½"	19,1	38,0	88,0	29,0	97,5	50,0	15,0	42,44
NRFM632	B	63 mm	10	63,0	2"	23,4	49,5	92,0	29,0	105,0	60,0	18,0	55,11
NRFM752	C	75 mm	6	75,0	2"	23,4	49,5	103,0	33,0	109,0	60,0	18,0	59,91
NRFM75212	B	75 mm	4	75,0	2½"	26,7	63,5	110,0	33,0	112,0	80,0	20,0	80,00
NRFM903	B	90 mm	2	90,0	3"	29,8	75,0	129,0	37,0	129,0	90,0	23,0	145,10
NRFM1104	B	110 mm	1	110,0	4"	35,8	99,5	160,0	43,0	148,0	115,0	30,0	200,94
NRFM1254	C	125 mm	1	125,0	4"	35,8	99,5	160,0	47,5	152,5	115,0	30,0	233,43

Accesorios termofusión roscados

Rácor loco unión socket

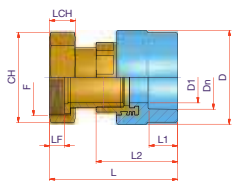

Referencia	∅	Uds. Caja	Dn (mm)	F	LF (mm)	D1 (mm)	D (mm)	L1 (mm)	L2 (mm)	L (mm)	CH (mm)	LCH (mm)	Precio (€/ud.)
NBD2034	20 mm	10	20,0	3/4"	10,8	14,1	37,0	16,0	40,0	62,0	30,0	14,0	11,70
NBD2534	25 mm	20	25,0	3/4"	10,8	14,1	37,0	17,0	41,0	62,0	30,0	14,0	13,10
NBD251	25 mm	10	25,0	1"	11,5	18,0	42,0	18,0	46,0	70,5	37,0	15,0	14,64
NBD321	32 mm	15	32,0	1"	11,5	18,0	45,5	21,5	51,0	76,0	37,0	15,0	25,29
NBD32114	32 mm	30	32,0	1 1/4"	14,0	24,0	54,5	20,0	53,0	81,0	46,0	18,0	30,86
NBD40114	40 mm	20	40,0	1 1/4"	14,0	24,0	56,0	22,0	67,0	93,0	46,0	18,0	38,46
NBD40112	40 mm	24	40,0	1 1/2"	14,0	33,0	66,0	22,0	69,0	98,0	52,0	18,0	45,09
NBD50112	50 mm	16	50,0	1 1/2"	14,0	33,0	70,0	25,0	56,0	101,0	52,0	18,0	86,25
NBD502FP	50 mm	10	50,0	2"	14,0	39,5	75,0	25,0	72,0	114,0	64,0	23,0	100,14
NBD632FP	63 mm	10	63,0	2"	15,0	39,5	88,0	29,0	75,0	212,0	64,0	23,0	111,41
NBD63212	63 mm	8	63,0	2 1/2"	21,0	50,0	93,0	29,0	81,0	135,5	81,5	25,5	141,71

Codo 90° rosca hembra unión socket

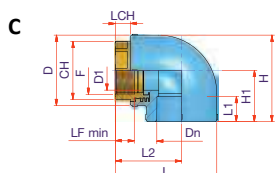
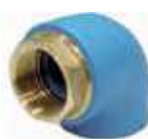
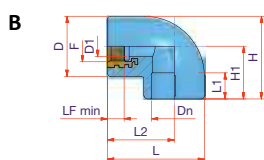
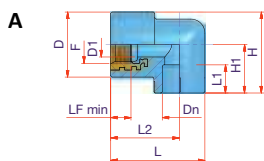

Referencia	Tipo	∅	Uds. Caja	Dn (mm)	D1 (mm)	D (mm)	F	LF min (mm)	L1 (mm)	L2 (mm)	L (mm)	H1 (mm)	H (mm)	CH (mm)	LCH (mm)	Precio (€/ud.)
NGF1612	A	16 mm	60	16,0	14,0	37,0	1/2"	11,5	13,0	39,0	53,5	27,5	46,0	-	-	5,17
NGF2012	A	20 mm	60	20,0	14,0	37,0	1/2"	11,5	16,0	39,0	53,5	27,5	46,0	-	-	4,73
NGF2512	A	25 mm	50	25,0	14,0	37,0	1/2"	11,5	17,0	39,0	56,5	30,5	49,0	-	-	7,53
NGF2534	A	25 mm	40	25,0	18,5	42,0	3/4"	13,2	17,0	39,0	56,5	30,5	51,5	-	-	8,09
NGF3212	B	32 mm	30	32,0	14,0	42,0	1/2"	11,5	18,0	46,0	67,0	36,0	57,0	-	-	9,34
NGF3234	B	32 mm	35	32,0	18,5	42,0	3/4"	13,2	18,0	46,0	67,0	36,0	57,0	-	-	9,83
NGF321	B	32 mm	30	32,0	24,0	54,0	1"	18,0	20,0	46,0	67,0	47,0	74,0	-	-	16,82
NGF401	B	40 mm	20	40,0	24,0	57,0	1"	18,0	20,0	52,0	79,0	43,0	72,0	46,0	15,0	19,76
NGF50114	C	50 mm	10	50,0	33,0	70,0	1 1/4"	21,4	25,0	66,0	101,0	51,0	86,0	55,0	15,0	44,54
NGF50112	C	50 mm	10	50,0	39,5	70,0	1 1/2"	19,0	25,0	66,0	101,0	51,0	86,0	55,0	15,0	32,42
NGF63112	C	63 mm	4	63,0	39,5	88,0	1 1/2"	19,0	29,0	77,0	121,0	62,0	106,0	65,0	20,0	56,28
NGF632	C	63 mm	4	63,0	50,0	88,0	2"	23,7	29,0	82,0	126,0	62,0	106,0	65,0	20,0	62,55



Accesorios termofusión roscados

Codo 90° rosca macho unión socket

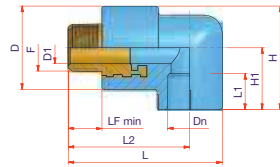

Referencia	∅	Uds. Caja	Dn (mm)	D1 (mm)	D (mm)	F	LF min (mm)	L1 (mm)	L2 (mm)	L (mm)	H1 (mm)	H (mm)	Precio (€/ud.)
NGM1612	16 mm	50	16,0	14,0	37,0	1/2"	13,2	13,0	54,0	68,5	27,5	46,0	7,69
NGM2012	20 mm	60	20,0	14,0	37,0	1/2"	13,2	16,0	54,0	68,5	27,5	46,0	7,14
NGM2512	25 mm	50	25,0	14,0	37,0	1/2"	13,2	17,0	54,0	71,5	30,5	49,0	8,47
NGM2534	25 mm	40	25,0	18,5	42,0	3/4"	14,5	17,0	54,0	73,5	30,5	51,5	8,65
NGM3212	32 mm	30	32,0	14,0	42,0	1/2"	13,2	18,0	61,0	82,0	36,0	57,0	10,56
NGM3234	32 mm	30	32,0	18,5	42,0	3/4"	14,5	18,0	61,0	84,0	36,0	57,0	10,67
NGM321	32 mm	25	32,0	24,0	54,0	1"	16,8	20,0	65,0	86,5	47,0	74,0	21,49

Codo 90° rácor loco unión socket

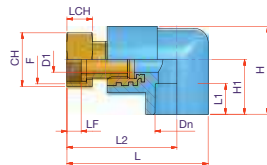

Referencia	∅	Uds. Caja	Dn (mm)	D1 (mm)	F	LF (mm)	L1 (mm)	L2 (mm)	L (mm)	CH (mm)	LCH (mm)	Precio (€/ud.)
NBC2034	20 mm	10	20,0	14,1	3/4"	10,5	16,0	59,0	73,5	30,0	14,0	11,22
NBC251	25 mm	10	25,0	18,0	1"	11,5	17,0	63,0	80,5	37,0	15,0	14,36
NBC32114	32 mm	5	32,0	24,0	1 1/4"	14,0	20,0	74,0	95,0	46,0	18,0	30,32

Codo 90° macho-hembra rosca hembra unión socket

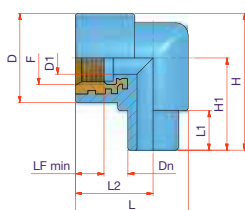

Referencia	∅	Uds. Caja	Dn (mm)	D1 (mm)	D (mm)	F	LF min. (mm)	L1 (mm)	L2 (mm)	L (mm)	H1 (mm)	H (mm)	Precio (€/ud.)
NGMFF2012	20 mm	70	20,0	13,2	36,0	1/2"	11,5	16,0	31,0	45,0	37,0	55,0	6,38

Accesorios termofusión roscados

Te rosca hembra unión socket

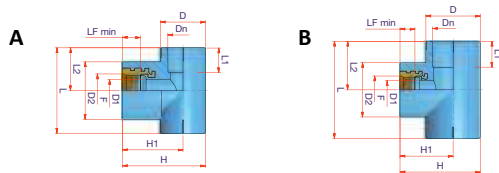

Referencia	Tipo	Ø	Uds. Caja	Dn (mm)	D1 (mm)	D2 (mm)	D (mm)	F	LF min (mm)	L1 (mm)	L2 (mm)	L (mm)	H1 (mm)	H (mm)	Precio (€/ud.)
NTF1612	A	16 mm	50	16,0	14,1	37,0	29,0	1/2"	11,5	14,0	26,5	53,0	33,0	53,0	6,32
NTF2012	A	20 mm	50	20,0	14,1	37,0	29,0	1/2"	11,5	16,0	27,5	55,0	39,0	53,5	6,30
NTF2512	A	25 mm	40	25,0	14,1	37,0	35,0	1/2"	11,5	17,0	30,5	61,0	39,0	56,5	6,71
NTF2534	A	25 mm	35	25,0	18,5	42,0	35,0	3/4"	13,2	17,0	30,5	61,0	39,0	56,5	8,53
NTF3212	B	32 mm	30	32,0	14,1	42,0	42,0	1/2"	11,5	20,0	37,5	75,0	41,0	62,0	8,79
NTF3234	B	32 mm	35	32,0	18,5	42,0	42,0	3/4"	13,2	20,0	37,5	75,0	41,0	62,0	11,85
NTF321	B	32 mm	16	32,0	24,0	54,0	42,0	1"	17,8	20,0	47,0	95,0	39,0	66,0	18,96

Te rosca macho unión socket

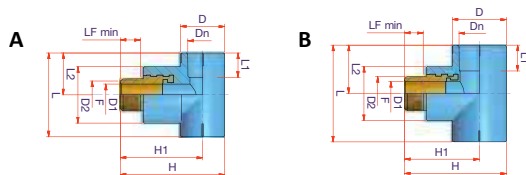

Referencia	Tipo	Ø	Uds. Caja	Dn (mm)	D1 (mm)	D2 (mm)	D (mm)	F	LF min (mm)	L1 (mm)	L2 (mm)	L (mm)	H1 (mm)	H (mm)	Precio (€/ud.)
NTM1612	A	16 mm	50	16,0	14,1	37,0	29,0	1/2"	13,2	14,0	26,5	53,0	48,0	62,5	7,71
NTM2012	A	20 mm	50	20,0	14,1	37,0	29,0	1/2"	13,2	16,0	27,5	55,0	54,0	68,5	7,78
NTM2512	A	25 mm	40	25,0	14,1	37,0	35,0	1/2"	13,2	17,0	30,5	61,0	54,0	71,5	9,29
NTM2534	A	25 mm	30	25,0	18,5	42,0	35,0	3/4"	14,5	17,0	30,5	61,0	56,0	73,5	10,56
NTM3212	B	32 mm	25	32,0	14,1	42,0	42,0	1/2"	13,2	20,0	37,5	75,0	56,0	77,0	13,29
NTM3234	B	32 mm	24	32,0	18,5	42,0	42,0	3/4"	14,5	20,0	37,5	75,0	58,0	79,0	13,93
NTM321	B	32 mm	14	32,0	24,0	54,0	42,0	1"	16,8	20,0	47,0	95,0	63,5	85,0	20,73

Codo placa 90° rosca hembra unión socket

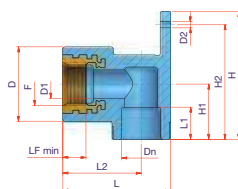

Referencia	Ø	Uds. Caja	Dn (mm)	D1 (mm)	D2 (mm)	D (mm)	F	LF min (mm)	L1 (mm)	L2 (mm)	L (mm)	H1 (mm)	H2 (mm)	H (mm)	Precio (€/ud.)
NTER1612	16 mm	40	16,0	14,0	3,0	37,0	1/2"	11,5	13,0	39,0	53,5	27,5	57,0	63,5	6,36
NTER2012	20 mm	40	20,0	14,0	3,0	37,0	1/2"	11,5	16,0	39,0	53,5	27,5	57,0	63,5	6,36



Accesorios termofusión roscados

Codo 90° rosca hembra con soporte unión socket

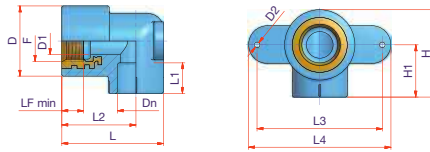

Referencia	∅	Uds. Caja	Dn (mm)	D1 (mm)	D2 (mm)	D (mm)	F	LF min (mm)	L1 (mm)	L2 (mm)	L3 (mm)	L4 (mm)	L (mm)	H1 (mm)	H (mm)	Precio (€/ud.)
NGTF2038	20 mm	40	20,0	13,0	3,0	37,0	3/8"	14,0	16,0	39,0	66,0	75,0	53,5	27,5	46,0	6,32
NGTF2012	20 mm	40	20,0	14,0	3,0	37,0	1/2"	11,5	16,0	39,0	66,0	75,0	53,5	27,5	46,0	6,38

Codo 90° rosca macho con soporte unión socket

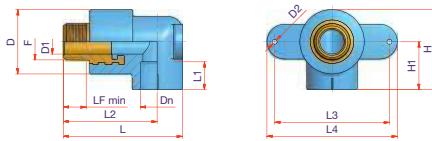

Referencia	∅	Uds. Caja	Dn (mm)	D1 (mm)	D2 (mm)	D (mm)	F	LF min (mm)	L1 (mm)	L2 (mm)	L3 (mm)	L4 (mm)	L (mm)	H1 (mm)	H (mm)	Precio (€/ud.)
NGTM2038	20 mm	40	20,0	11,0	3,0	37,0	3/8"	11,0	16,0	50,0	66,0	75,0	64,5	27,5	46,0	7,62
NGTM2012	20 mm	40	20,0	14,0	3,0	37,0	1/2"	13,2	16,0	54,0	66,0	75,0	68,5	27,5	46,0	7,62

Codo 90° rosca hembra para grupo de baño unión socket

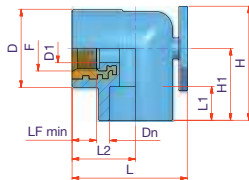

Referencia	∅	Uds. Caja	Dn (mm)	D1 (mm)	D (mm)	F	LF min (mm)	L1 (mm)	L2 (mm)	L (mm)	H1 (mm)	H (mm)	Precio (€/ud.)
NGOF2012	20 mm	50	20,0	14,0	37,0	1/2"	11,5	16,0	30,0	54,5	28,5	48,5	7,17
NGOF2512	25 mm	40	25,0	14,0	37,0	1/2"	11,5	16,0	30,0	54,5	34,0	54,0	7,75

Codo 90° rosca macho para grupo de baño unión socket

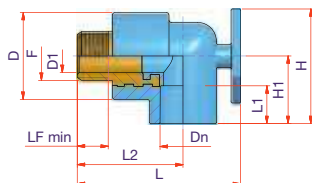

Referencia	∅	Uds. Caja	Dn (mm)	D1 (mm)	D (mm)	F	LF min (mm)	L1 (mm)	L2 (mm)	L (mm)	H1 (mm)	H (mm)	Precio (€/ud.)
NGOM2012	20 mm	40	20,0	14,0	37,0	1/2"	13,2	16,0	45,0	69,5	28,5	48,5	8,12

Accesorios termofusión roscados

Soporte DIMA con dos codos 90° rosca hembra con soporte unión socket (para instalaciones registrables)

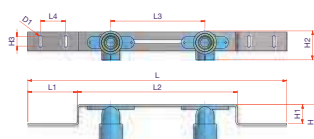

Referencia	∅	Uds. Caja	Dn (mm)	D1 (mm)	L1 (mm)	L2 (mm)	L3 (mm)	L4 (mm)	L (mm)	H1 (mm)	H2 (mm)	H3 (mm)	H (mm)	Precio (€/ud.)
NGVRF2012	20 mm	12	20,0	5,0	77,5	255,0	150,0	40,0	410,0	30,0	46,0	15,0	56,0	19,82

Soporte para instalaciones registrables

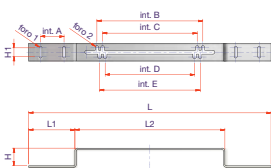

Referencia	Uds. Caja	L (mm)	L1 (mm)	L2 (mm)	H (mm)	H1 (mm)	Agujero 1 (mm)	Int. A (mm)	Agujero 2 (mm)	Int. B (mm)	Int. C (mm)	Int. D (mm)	Int. E (mm)	Precio (€/ud.)
DIMA	28	410,0	77,5	255,0	30,0	15,0	5,0	40,0	6,5	170,0	150,0	160,0	180,0	6,89

Placa de montaje DIMARL con dos codos 90° rosca hembra para grupo de baño unión socket

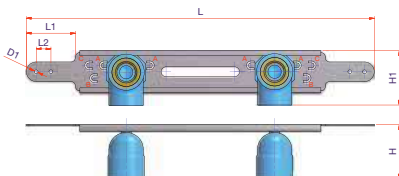

Referencia	∅	Uds. Caja	Dn (mm)	L1 (mm)	L2 (mm)	L (mm)	H1 (mm)	H (mm)	D1 (mm)	A-A (mm)	B-A (mm)	B-B (mm)	C-C (mm)	Precio (€/ud.)
NGVF2012	20 mm	12	20,0	50,0	15,0	354,0	50,5	55,5	4,0	150,0	160,0	170,0	180,0	16,45
NGVF2512	25 mm	12	25,0	50,0	15,0	354,0	56,0	55,5	4,0	150,0	160,0	170,0	180,0	17,85

Placa de montaje

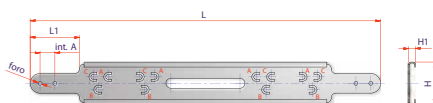

Referencia	Uds. Caja	L (mm)	L1 (mm)	H (mm)	H1 (mm)	Agujero (mm)	Int. A (mm)	A-A (mm)	B-A (mm)	B-B (mm)	C-C (mm)	Precio (€/ud.)
DIMARL	10	354,0	50,0	42,5	6,5	4,0	15,0	150,0	160,0	170,0	180,0	4,29

Accesorios termofusión roscados

Unión tres piezas todo PP-R unión socket - Válido solamente para agua fría

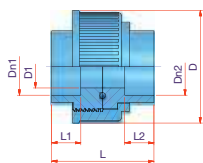

Referencia	Ø (mm)	Uds. Caja	Dn1 (mm)	Dn2 (mm)	D1 (mm)	D (mm)	L1 (mm)	L2 (mm)	L (mm)	Precio (€/ud.)
NBRF20	20 mm	30	20,0	20,0	14,0	53,0	20,0	20,0	73,0	7,74
NBRF25	25 mm	26	25,0	25,0	18,0	57,0	20,0	20,0	70,0	9,95
NBRF32	32 mm	20	32,0	32,0	24,0	67,0	20,0	20,0	70,0	11,28
NBRF40	40 mm	18	40,0	40,0	29,0	77,0	20,0	20,0	70,0	11,94

Unión tres piezas unión socket - Válido solamente para agua fría

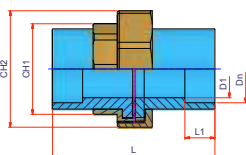

Referencia	Ø (mm)	Uds. Caja	Dn (mm)	D1 (mm)	L1 (mm)	L (mm)	CH1 (mm)	CH2 (mm)	Precio (€/ud.)
NCSJ20	20 mm	50	20-20	15,0	14,0	79,0	30,0	46,0	44,10
NCSJ25	25 mm	25	25-25	19,0	16,0	85,0	38,0	52,0	48,36
NCSJ32	32 mm	10	32-32	26,0	18,0	106,0	50,0	68,0	66,23
NCSJ40	40 mm	9	40-40	33,0	22,0	120,0	54,0	80,0	108,73
NCSJ50	50 mm	5	50-50	43,0	24,0	130,0	71,0	97,0	124,73
NCSJ63	63 mm	4	63-63	52,0	28,0	153,0	80,0	109,0	174,70

Unión tres piezas macho rosca macho unión socket - Válido solamente para agua fría

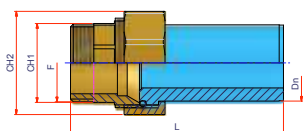

Referencia	Ø (mm)	Uds. Caja	Dn (mm)	F	L (mm)	CH1 (mm)	CH2 (mm)	Precio (€/ud.)
NTCMT2012	20 mm	100	20,0	1/2"	90,0	22,0	29,0	19,32
NTCMT2534	25 mm	60	25,0	3/4"	98,0	26,0	38,0	27,09
NTCMT321	32 mm	35	32,0	1"	107,0	34,0	47,0	34,27
NTCMT40114	40 mm	20	40,0	1 1/4"	113,0	42,0	55,0	64,51
NTCMT50112	50 mm	13	50,0	1 1/2"	145,0	52,0	65,0	79,97
NTCMT632	63 mm	6	63,0	2"	146,0	64,0	81,0	132,07

Unión tres piezas macho rosca hembra unión socket - Válido solamente para agua fría

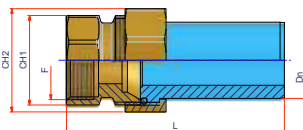

Referencia	Ø (mm)	Uds. Caja	Dn (mm)	F	L (mm)	CH1 (mm)	CH2 (mm)	Precio (€/ud.)
NTCFT2012	20 mm	100	20,0	1/2"	89	24	30	18,44
NTCFT2534	25 mm	50	25,0	3/4"	89	32	38	26,52
NTCFT321	32 x 1"	30	32,0	1"	108	39	46	33,08
NTCFT40114	40 x 1 1/4"	20	40,0	1 1/4"	116	48	55	71,59
NTCFT50112	50 x 1 1/2"	13	50,0	1 1/2"	143	56	64	86,43
NTCFT632	63 x 2"	6	63,0	2"	146	70	82	124,87

Accesorios termofusión roscados

Injerto rosca hembra unión socket

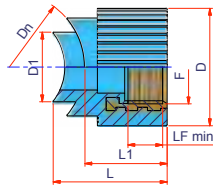

Referencia	Dn tubo (mm)	Dn agujero (mm)	Uds. Caja	F	LF min (mm)	D1 (mm)	D (mm)	L1 (mm)	L (mm)	Precio (€/ud.)
NGSF124050	40-50	25,0	70	1/2"	11,5	25,0	37,0	31,5	45,0	9,41
NGSF126375	63-75	25,0	70	1/2"	11,5	25,0	37,0	31,5	42,0	9,41
NGSF1290110125	90-110-125	25,0	70	1/2"	11,5	25,0	37,0	31,5	41,0	9,75
NGSF12160200	160-200	25,0	70	1/2"	11,5	25,0	37,0	31,5	40,0	9,95
NGSF12250315	250-315	25,0	1	1/2"	11,5	25,0	37,0	31,5	-	15,55
NGSF12355630	355-630	25,0	1	1/2"	11,5	25,0	37,0	31,5	-	17,96
NGSF344050	40-50	25,0	70	3/4"	13,2	25,0	42,0	33,5	47,0	12,29
NGSF346375	63-75	25,0	70	3/4"	13,2	25,0	42,0	33,5	44,0	11,16
NGSF3490110125	90-110-125	25,0	70	3/4"	13,2	25,0	42,0	33,5	43,0	11,16
NGSF34160200	160-200	25,0	70	3/4"	13,2	25,0	42,0	33,5	42,0	11,17
NGSF34250315	250-315	25,0	1	3/4"	13,2	25,0	42,0	33,5	42,0	20,35
NGSF34355630	355-630	25,0	1	3/4"	13,2	25,0	42,0	33,5	42,0	21,51
NGSF16375	63-75	32,0	40	1"	18,0	32,0	54,0	38,0	52,0	15,48
NGSF190110125	90-110-125	32,0	40	1"	18,0	32,0	54,0	38,0	50,0	15,48
NGSF1160200	160-200	32,0	1	1"	18,0	32,0	54,0	38,0	48,5	16,76
NGSF1250315	250-315	32,0	1	1"	18,0	32,0	54,0	38,0	48,0	24,60
NGSF1355630	355-630	32,0	1	1"	18,0	32,0	54,0	38,0	48,0	31,72





Llaves y válvulas

Llaves

Llave de paso de esfera extraíble completa NRS unión socket

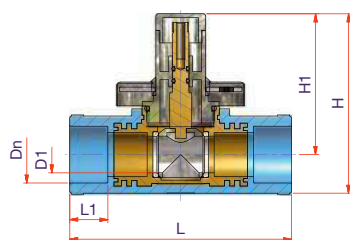

Referencia	∅	Uds. Caja	Dn (mm)	D1 (mm)	L1 (mm)	L (mm)	H1 (mm)	H (mm)	Precio (€/ud.)
NRS20	20 mm	10	20,0	15,0	16,0	100,5	73,0	92,0	33,39
NRS25	25 mm	10	25,0	15,0	17,0	100,5	73,0	92,0	36,22
NRS32	32 mm	10	32,0	20,0	20,0	121,0	77,0	98,0	39,79

Recambio embellecedor para ref. NRS



Referencia	∅	Uds. Caja	Precio (€/ud.)
NRSRC	20-25-32 mm	1	11,01

Recambio montura esfera para ref. NRS



Referencia	∅	Uds. Caja	Precio (€/ud.)
NRSRS2025	20-25 mm	1	24,11
NRSRS32	32 mm	1	28,00

Recambio alargador para ref. NRS



Referencia	∅	Uds. Caja	Precio (€/ud.)
NPROSF	20-25-32 mm	1	15,14

Mando para ref. NRS



Referencia	∅	Uds. Caja	Precio (€/ud.)
NMAS	20-25-32 mm	1	17,82

Leva para ref. NRS



Referencia	∅	Uds. Caja	Precio (€/ud.)
NLRS	20-25-32 mm	1	17,79

Llaves

Llave de cierre en asiento completa NRA unión socket

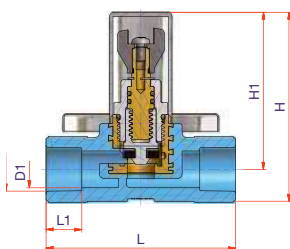

Referencia	Ø	Uds. Caja	Dn	D1 (mm)	L1 (mm)	L (mm)	H1 (mm)	H (mm)	Precio (€/ud.)
NRA20	20 mm	10	20,0	16,5	16,0	85,0	70,5	85,0	26,31
NRA25	25 mm	10	25,0	23,5	20,0	100,0	79,0	97,0	28,20

Recambio cuerpo para ref. NRA



Referencia	Ø	Uds. Caja	Precio (€/ud.)
NCRA20	20 mm	20	15,03
NCRA25	25 mm	30	15,87

Recambio montura para ref. NRA

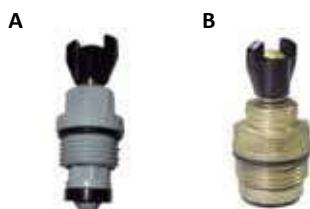

Referencia	Tipo	Ø	Material	Uds. Caja	Precio (€/ud.)
NVIT20	A	20 mm	PPSU	1	10,50
NVIT25	B	25 mm	Latón	1	13,61

Recambio embellecedor para ref. NRA



Referencia	Ø	Uds. Caja	Precio (€/ud.)
NRARC	20-25 mm	1	15,14

Recambio alargador para ref. NRA



Referencia	Ø	Uds. Caja	Precio (€/ud.)
NPROVI	20-25 mm	10	12,45

Llaves

Llave de cierre en asiento con prolongación completa NRAPRO unión socket

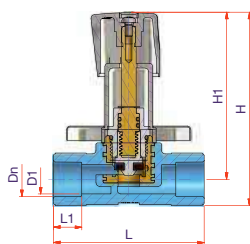

Referencia	∅	Uds. Caja	Dn (mm)	D1 (mm)	L1 (mm)	L (mm)	H1 (mm)	H (mm)	Precio (€/ud.)
NRAPRO20	20 mm	10	20,0	16,5	16,0	85,0	94,0	109,0	39,15
NRAPRO25	25 mm	10	25,0	23,5	20,0	100,0	94,0	112,0	41,15

Mando para ref. NRA



Referencia	∅	Uds. Caja	Precio (€/ud.)
NMAVI	para NRA 20-25 mm	10	13,17

Llave de paso asiento oblicuo completa NRAIN



Referencia	∅	Uds. Caja	Dn (mm)	D1 (mm)	L1 (mm)	L2 (mm)	L (mm)	H1 (mm)	H (mm)	Precio (€/ud.)
NRAIN20	20 mm	20	20,0	16,5	16,0	78,0	116,0	78,0	110,0	28,86
NRAIN25	25 mm	16	25,0	23,5	17,0	93,0	135,0	92,0	122,0	31,55
NRAIN32	32 mm	9	32,0	28,0	20,0	115,0	165,0	114,0	150,0	44,55



Válvulas

Válvula de paso de esfera. Cuerpo en PP-R y esfera latón níquel OT unión socket



Referencia	∅	Uds. Caja	Dn (mm)	Precio (€/ud.)
NRSPP20	20 mm	30	20,0	19,44
NRSPP25	25 mm	25	25,0	25,60
NRSPP32	32 mm	15	32,0	35,14
NRSPP40	40 mm	10	40,0	74,27
NRSPP50	50 mm	6	50,0	107,02



Portabridas

EN CASO DE USO CON VALVULA TIPO WAFER, CONSULTAR LA COMPATIBILIDAD para plena abertura de la lenteja según el modelo de válvula escogido.

Para cualquier consulta contactar con atencionalcliente@italsan.com

Indice



Portabridas

Portabridas

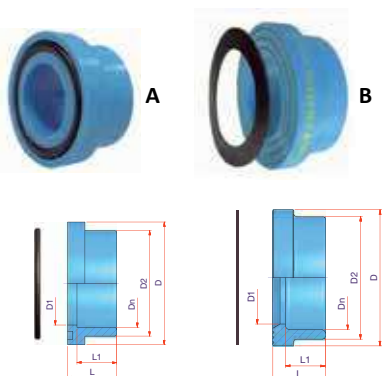

Referencia	Tipo	Ø	Uds. Caja	Dn (mm)	D (mm)	D1 (mm)	D2 (mm)	L1 (mm)	L (mm)	Precio (€/ud.)
PORTABRIDAS CON JUNTA TÓRICA UNIÓN SOCKET										
NCOSA32	A	32 mm	100	32,0	51,0	28,0	40,6	18,0	26,0	4,13
NCOSA40	A	40 mm	50	40,0	64,0	36,0	49,4	20,5	30,0	4,72
NCOSA50	A	50 mm	36	50,0	73,2	45,5	61,0	23,5	34,0	5,17
NCOSA63	A	63 mm	20	63,0	90,5	56,5	76,0	27,5	38,0	9,05
NCOSA75	A	75 mm	12	75,0	104,5	71,0	90,0	30,0	42,0	11,40
PORTABRIDAS CON JUNTA PLANA UNIÓN SOCKET										
NCOSA90	B	90 mm	8	90,0	138,0	84,0	107,0	37,0	46,0	20,02
NCOSA110	B	110 mm	10	110,0	158,0	102,0	131,0	43,0	57,0	27,93
NCOSA125	B	125 mm	8	125,0	170,0	116,0	146,0	47,5	62,5	55,85

Portabridas largo SDR11 soldadura a testa o accesorio eléctrico

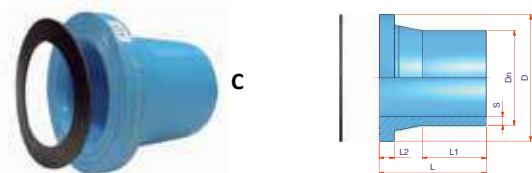

Referencia	Tipo	Ø	Uds. Caja	Dn (mm)	S (mm)	D (mm)	L1 (mm)	L2 (mm)	L (mm)	Precio (€/ud.)
NCRT16011	C	160 mm	1	160,0	14,6	212,0	105,0	25,0	180,0	95,35
NCRT20011	C	200 mm	1	200,0	18,2	268,0	125,0	32,0	200,0	246,80
NCRT25011	C	250 mm	1	250,0	22,7	320,0	132,0	35,0	207,0	298,41
NCRT31511*	C	315 mm	1	315,0	28,6	370,0	132,0	35,0	228,0	511,82

* Junta plana no incluida en este artículo.

Portabridas corto SDR11 soldadura a testa



Referencia	Ø	Uds. Caja	Dn (mm)	S (mm)	D (mm)	D1 (mm)	L1 (mm)	L2 (mm)	L (mm)	Precio (€/ud.)
27NCART35511S	355 mm	1	355,0	32,2	430,0	373,0	35,0	40,0	115,0	A consultar
27NCART40011S	400 mm	1	400,0	36,3	485,0	427,0	29,0	46,0	120,0	A consultar
27NCART45011S	450 mm	1	450,0	40,9	585,0	514,0	15,0	60,0	135,0	A consultar

Portabridas

Portabridas largo SDR17 soldadura a testa o accesorio eléctrico

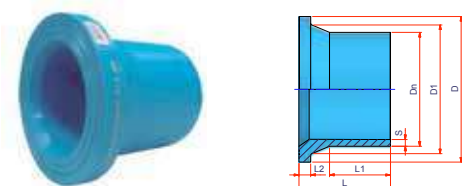

Referencia	∅	Uds. Caja	Dn (mm)	S (mm)	D (mm)	D1 (mm)	L1 (mm)	L2 (mm)	L (mm)	Precio (€/ud.)
NCRT16017	160 mm	1	160,0	9,5	212,0	175,0	105,0	18,0	180,0	83,90
NCRT20017	200 mm	1	200,0	11,9	268,0	232,0	120,0	24,0	200,0	155,31
NCRT25017	250 mm	1	250,0	14,8	320,0	285,0	142,0	25,0	207,0	231,12
NCRT31517	315 mm	1	315,0	18,7	370,0	335,0	152,0	25,0	217,0	571,98

Portabridas corto SDR17 soldadura a testa



Referencia	∅	Uds. Caja	Dn (mm)	S (mm)	D (mm)	D1 (mm)	L1 (mm)	L2 (mm)	L (mm)	Precio (€/ud.)
27NCART35517S	355 mm	1	355,0	21,1	430,0	373,0	45,0	30,0	115,0	A consultar
27NCART40017S	400 mm	1	400,0	23,7	485,0	427,0	40,0	33,0	118,0	A consultar
27NCART45017S	450 mm	1	450,0	26,7	585,0	514,0	24,0	46,0	130,0	A consultar
27NCART50017S	500 mm	1	500,0	29,7	585,0	530,0	57,0	46,0	153,0	A consultar
27NCART56017S	560 mm	1	560,0	33,2	658,0	615,0	15,0	50,0	125,0	A consultar
27NCART63017S	630 mm	1	630,0	37,4	658,0	642,0	35,0	50,0	125,0	A consultar

Junta plana EPDM para portabridas

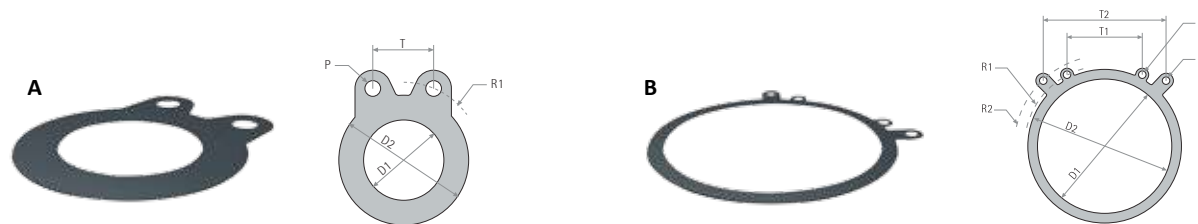

Referencia	Tipo	∅	Uds. Caja	Dn	D1 (mm)	D2 (mm)	E (mm)	P (mm)	R1 (mm)	R2 (mm)	T (mm)	T2 (mm)	Precio (€/ud.)
EGR90	A	90 mm	1	90,0	80,0	130,0	3,0	16,0	78,0	-	61,0	-	A consultar
EGR110	A	110 mm	1	110,0	100,0	154,0	3,0	16,0	88,0	-	68,0	-	A consultar
EGR125	A	125 mm	1	125,0	125,0	183,0	3,0	16,0	107,0	-	81,0	-	A consultar
EGR160	A	160 mm	1	160,0	150,0	208,0	3,0	20,0	118,0	-	91,0	-	A consultar
EGR200	A	200 mm	1	200,0	200,0	263,0	3,0	20,0	146,0	-	75,0	-	A consultar
EGR250	A	250 mm	1	250,0	250,0	316,0	4,0	24,0	176,0	-	91,0	-	A consultar
EGR315	A	315 mm	1	315,0	300,0	367,0	4,0	24,0	203,0	-	105,0	-	A consultar
EGR355	A	355 mm	1	355,0	350,0	425,0	4,0	24,0	233,0	-	91,0	-	A consultar
EGR400	A	400 mm	1	400,0	400,0	477,0	4,0	24,0	261,0	-	102,0	-	A consultar
EGR450	A	450 mm	1	450,0	450,0	542,0	4,0	29,0	289,0	-	264,0	-	A consultar
EGR500	B	500 mm	1	500,0	500,0	576,0	5,0	32,0	305,0	325,0	282,0	463,0	A consultar
EGR630	B	630 mm	1	630,0	600,0	675,0	5,0	35,0	360,0	375,0	320,0	536,0	A consultar

SISTEMA
NIRON PREMIUM

La solución en salas de producción de ACS

Las condiciones de servicio y mantenimiento más exigentes se dan en el circuito secundario de la instalación de ACS. Particularmente, en las tuberías, accesorios y otros componentes en la zona de acumulación y recirculación, donde se realizan los distintos tratamientos de desinfección muchas veces con desinfectantes con cloro. La naturaleza oxidante de estos tratamientos crea medios totalmente adversos en tuberías tanto metálicas como poliméricas.

La gama de tuberías y accesorios Sistema NIRON PREMIUM ha sido diseñada y desarrollada para dar respuesta a la degradación termo-oxidativa agravada por el hipoclorito de sodio.

Producción de ACS con dos acumuladores e intercambiador exterior

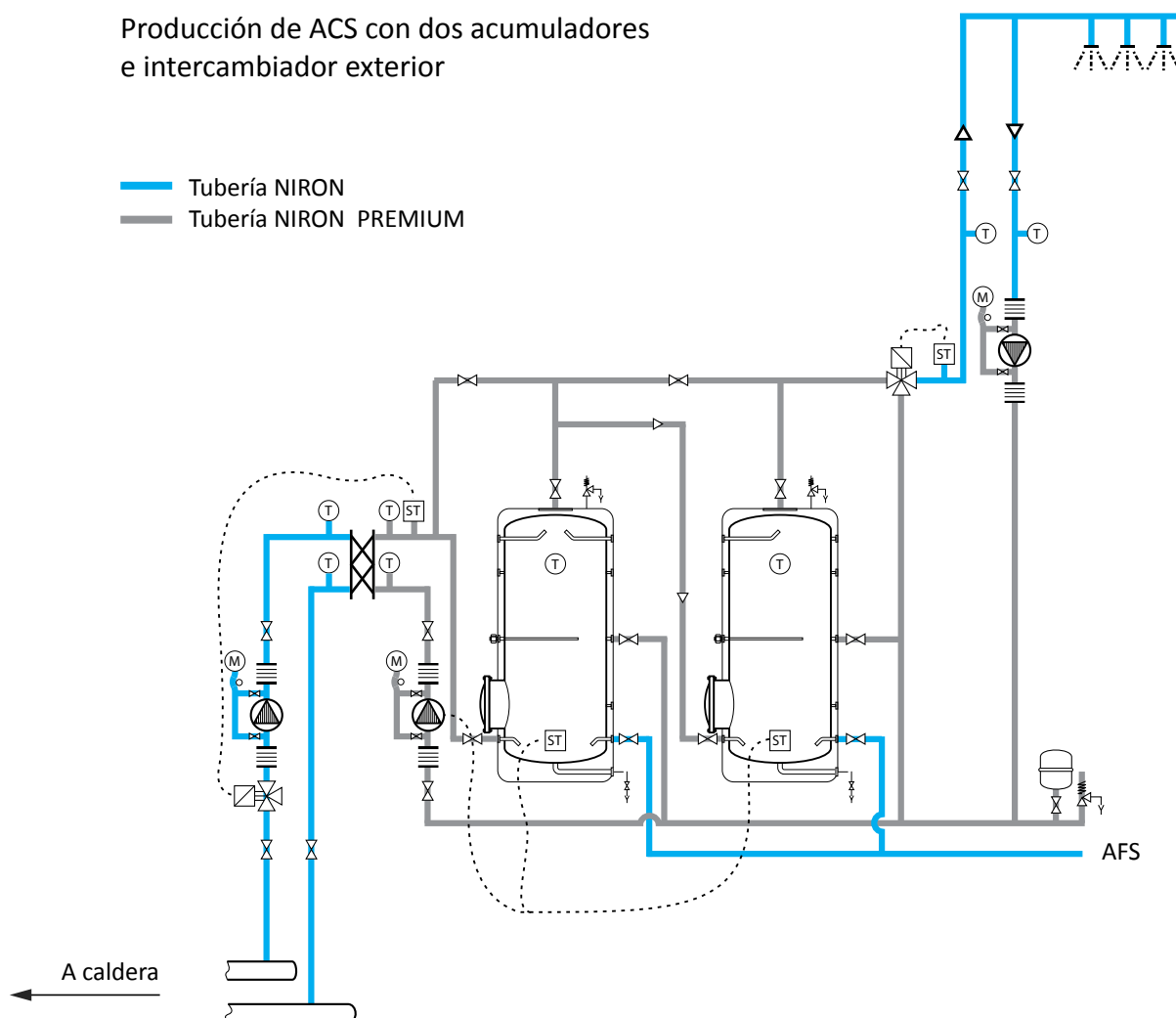

Especificaciones técnicas



Materia prima

- Sistema 100%: Tuberías y accesorios con idéntica materia prima.
- Materia prima BOREALIS RA7050, color gris, pigmentada en origen.
- Antimicrobiano.



Resistencia química

- Paquete de aditivos antioxidantes mejorados.
- Alta resistencia frente a soluciones de hipoclorito sódico (NaClO).
- Alta resistencia en condiciones muy oxidantes: ensayado y certificado según ASTM F2023, asegurando el trasiego de 4,3 ppm de NaClO a 60 °C y 5,5 bar (80 psi) de presión durante 30 años en ejercicio continuo.

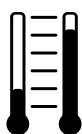

Resistencia mecánica

- Tecnología β -nucleación.
- Mejores prestaciones a alta temperatura.
- Mayor resistencia termomecánica expresada en una curva de regresión más horizontal, garantizándose la vida útil de las instalaciones.

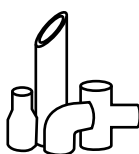

Gama

- Roscas de latón libre de plomo "lead free", con rosca ISO o NPT y contenido de plomo menor al de los estándares ambientales internacionales $Pb < 0,2\%$.

Calidad certificada

- **AENOR RP 01.78:** Certificado para gama de Tubería según Reglamento Particular RP 01.78, España.
- **ASTM F 2389-2010:** Pressure rated Polypropylene (pp) Piping System, Estados Unidos. Especificaciones para sistemas a presión de tuberías Polipropileno, Estados Unidos.
- **ASTM F2023:** Standard Test Method for Evaluating the Oxidative Resistance of Tubing and Systems to Hot Chlorinated Water, Estados Unidos. Método de ensayo para la evaluación de la resistencia oxidativa del sistema de tuberías al agua caliente clorada, Estados Unidos.
- **NSF/ANSI Standar 14-2014:** Plastic Piping System components and related Materials, Estados Unidos. Cumplimiento con los requisitos para sistemas de tuberías de plástico, Estados Unidos.
- **NSF/ANSI Standard 61-2014:** Drinking Water System Components-Health Effects, Estados Unidos. Sistemas y componentes para agua potable-Efectos en la salud, Estados Unidos.
- **CSA B137.11-2009:** Polypropylene (PP-R) pipe and fitting for pressure applications, Canadá. Polipropileno (PP-R) tubería y accesorios para aplicaciones de presión, Canadá.
- **ICC-ES LC1004:** PMG Listing Criteria for PP, PEX, PEX-AL-PEX and PP-AL-PP Piping. Tube and Fittings used in radiant heating. Listado criterios para tuberías de PP, PEX, PEX-AL-PEX and PP-AL-PP. Tubo y accesorios utilizados en los sistemas de calefacción y de agua radiantes. Estados Unidos y Canadá.





Tubería

Tubería Compuesta PP-RCT RA7050

Tubería compuesta NIRON PREMIUM SDR7,3/Serie 3,2

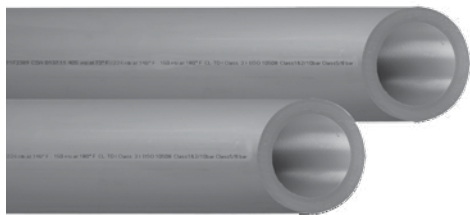

Descripción

Tubería compuesto PP-RCT RA7050+FV SDR7,3/SERIE 3,2
Color gris
Clase 1/10 bar, clase 2/10 bar,
clase 4/10 bar, clase 5/8 bar

Suministro

En barras de 4 o 6,1 metros

Certificados

AENOR RP 01.78, ASTM F2689, ASTM F2023, NSF14,
ICC-ES LC 1004 PMG, CSA B137.11-2009, EN ISO 15874

Referencia	Ø Exterior (mm)	Espesor (mm)	Ø Interior (mm)	Peso por metro -tubería vacía- (kg/m)	Contenido de agua (l/m)	Embalaje (m x paquete)	Embalaje (m x palet)	Precio (€/m)
27TNIRCL2073B4	20	2,8	14,4	0,14	0,16	100	3000	3,05
27TNIRCL2573B4	25	3,5	18,0	0,21	0,25	100	2000	4,32
27TNIRCL3273B4	32	4,4	23,2	0,35	0,42	60	1320	7,26
27TNIRCL4073B4	40	5,5	29,0	0,54	0,66	40	800	12,14
27TNIRCL5073B4	50	6,9	36,2	0,85	1,03	20	560	17,55
27TNIRCL6373B4	63	8,6	45,8	1,33	1,65	16	352	24,29
27TNIRCL7573B4	75	10,4	54,2	1,91	2,31	12	240	37,34
27TNIRCL9073B4	90	12,3	65,4	2,72	3,36	8	160	54,15
27TNIRCL11073B4	110	15,1	79,8	4,07	5,00	8	112	74,46
27TNIRCL12573B4	125	17,1	90,8	5,25	6,48	4	80	92,50
27TNIRCL16073B4	160	21,9	116,2	8,60	10,60	4	48	166,64
27TNIRCL20073	200	27,4	145,2	13,45	16,56	6,1	32	320,88
27TNIRCL25073	250	34,3	181,4	21,04	25,84	6,1	20	498,36

Tubería Compuesta PP-RCT RA7050

Presiones de servicio tubería compuesta NIRON PREMIUM SDR7,3/SERIE 3,2

NIRON PREMIUM Compuesto SDR7,3/ Serie 3,2

Clase	1	10
	2	10
	4	10
	5	8

PARA CIRCUITOS ABIERTOS

T máxima fluido (°C)	Años en ejercicio continuo	Presión servicio (bar)
10	1	30,2
	5	29,3
	10	28,9
	25	28,4
	50	28,0
20	1	26,3
	5	25,4
	10	25,1
	25	24,6
	50	24,3
30	1	22,7
	5	22,0
	10	21,7
	25	21,2
	50	20,9
40	1	19,6
	5	18,9
	10	18,6
	25	18,2
	50	17,9
50	1	16,7
	5	16,1
	10	15,8
	25	15,5
	50	15,2
60	1	14,2
	5	13,6
	10	13,4
	25	13,1
	50	12,8
70	1	11,9
	5	11,4
	10	11,2
	25	10,9
	50	10,7
80	1	9,9
	5	9,5
	10	9,3
	25	9,1
	95	1
5		7,1

Coefficiente de seguridad aplicado del 1,5 según norma EN ISO 15874

PARA CIRCUITOS CERRADOS

T máxima fluido (°C)	Años en ejercicio continuo	Presión servicio (bar)
10	1	36,2
	5	25,1
	10	34,7
	25	34,1
	50	33,6
20	1	31,5
	5	30,5
	10	30,1
	25	29,6
	50	29,2
30	1	27,3
	5	26,4
	10	26,0
	25	25,5
	50	25,1
40	1	23,5
	5	22,6
	10	22,3
	25	21,8
	50	21,5
50	1	20,1
	5	19,3
	10	19,0
	25	18,6
	50	18,3
60	1	17,0
	5	16,3
	10	16,0
	25	15,7
	50	15,4
70	1	14,3
	5	13,7
	10	13,5
	25	13,1
	50	12,9
80	1	11,9
	5	11,4
	10	11,2
	25	10,9
	95	1
5		8,5

Coefficiente de seguridad aplicado del 1,25 según norma DIN 8077/78



Manguitos electrosoldables

Manguitos PP-RCT electrosoldables

Manguito SDR7,3 soldadura eléctrica (Clase 1/10, 2/10, 4/10, 5/8)

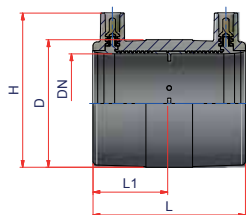

Características

Material: PP-RCT RA7050 color gris
Sistema de unión: Soldadura eléctrica

Certificados

AENOR RP 01.78, ASTM F2689, ASTM F2023, NSF14, NSF61, ICC-ES LC 1004 PMG, CSA B137.11-2009, EN ISO 15874

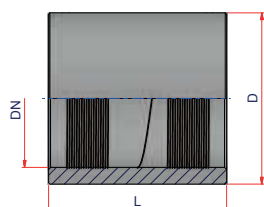
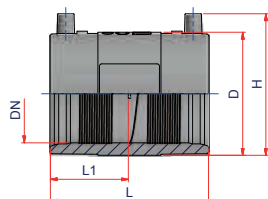

Referencia	Tipo	Dn	Uds. Caja	L1 (mm)	L (mm)	H (mm)	D (mm)	Precio (€/ud.)
27NME2073	A	20 mm	100	34,04	70,10	52,07	33,02	12,31
27NME2573	A	25 mm	120	34,04	70,10	57,91	38,61	12,83
27NME3273	A	32 mm	60	34,04	70,10	65,02	45,47	14,77
27NME4073	A	40 mm	50	40,89	85,09	74,93	55,12	16,59
27NME5073	A	50 mm	40	42,42	88,14	87,12	68,07	18,03
27NME6373	A	63 mm	30	47,50	98,04	100,08	82,04	21,33
27NME7573	A	75 mm	24	60,96	124,97	114,05	98,04	37,65
27NME9073	B	90 mm	30	72,14	146,05	130,05	113,03	69,12
27NME11073	B	110 mm	22	76,96	154,94	144,02	135,89	88,34
27NME12573	B	125 mm	16	82,04	166,12	167,13	156,46	105,86
27NME16073	C	160 mm	90	-	240,03	-	204,98	206,01
27NME20073	C	200 mm	42	-	260,10	-	249,94	267,77
27NME25073	C	250 mm	18	-	320,04	-	314,96	409,23



Accesorios termofusión

Accesorios termofusión

Codo 90° unión socket

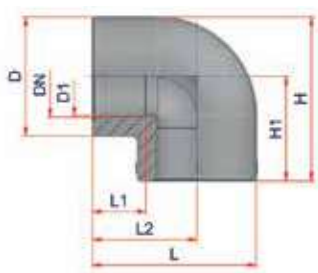

Características

Material: PP-RCT RA7050 color gris
Sistema de unión: Termofusión socket

Certificados

ASTM F2689, ASTM F2023, NSF14, NSF61, ICC-ES LC 1004 PMG, CSA B137.11-2009, EN ISO 15874

Referencia	Dn	Uds. Caja	D1 (mm)	D (mm)	L1 (mm)	L2 (mm)	L (mm)	H1 (mm)	H (mm)	Precio (€/ud.)
27NG20	20 mm	200	16,51	28,96	16,00	26,92	41,66	26,92	41,40	0,74
27NG25	25 mm	100	23,62	35,56	16,00	30,99	49,02	30,99	49,02	0,92
27NG32	32 mm	50	29,97	45,97	20,07	37,08	59,94	37,08	59,94	1,46
27NG40	40 mm	40	36,07	56,13	22,10	42,93	71,12	42,93	70,87	2,80
27NG50	50 mm	20	45,97	70,10	24,89	51,05	86,11	51,05	86,11	5,77
27NG63	63 mm	25	58,93	88,14	28,96	61,98	105,92	61,98	105,92	9,53
27NG75	75 mm	15	70,10	101,09	33,02	65,28	123,44	72,90	123,44	17,76
27NG90	90 mm	10	82,55	138,94	37,08	82,55	138,94	85,09	147,07	29,92
27NG110	110 mm	4	100,08	146,05	42,93	100,08	172,97	100,08	172,97	46,71
27NG125	125 mm	4	113,03	165,10	47,50	124,97	207,52	124,97	207,52	73,38

Codo 90° SDR7,3 soldadura a testa o accesorio eléctrico

(A)

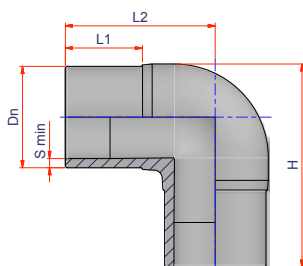
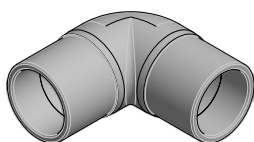

Características

Material: PP-RCT RA7050 color gris
Sistema de unión: Soldadura a testa o manguito eléctrico

Certificados

ASTM F2689, ASTM F2023, NSF14, NSF61, ICC-ES LC 1004 PMG, CSA B137.11-2009, EN ISO 15874

(B)

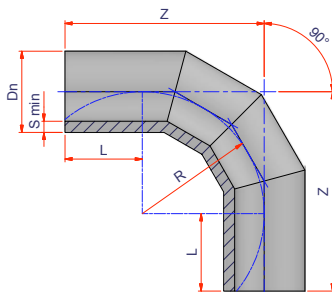
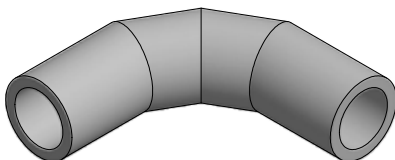

Referencia	Tipo	Dn	Uds. Caja	S min. (mm)	L1 (mm)	L2 (mm)	H (mm)	Precio (€/ud.)
27NG9073160MM	A	160 mm	1	21,90	110,00	217,00	303,00	114,00
27NG9073200MMB	B	200 mm	1	27,40	150,00	450,00	300,00	292,05
27NG9073250MMB	B	250 mm	1	34,20	250,00	625,00	375,00	333,96

Accesorios termofusión

Codo 45° unión socket

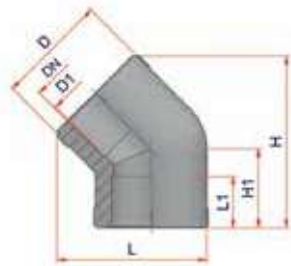

Características

Material: PP-RCT RA7050 color gris
Sistema de unión: Termofusión socket

Certificados

ASTM F2689, ASTM F2023, NSF14, NSF61, ICC-ES LC 1004
PMG, CSA B137.11-2009, EN ISO 15874

Referencia	Dn	Uds. Caja	D1 (mm)	D (mm)	L1 (mm)	L (mm)	H1 (mm)	H (mm)	Precio (€/ud.)
27NC4520	20 mm	200	16,51	28,96	16,00	33,02	21,59	45,97	0,84
27NC4525	25 mm	150	23,62	34,04	16,00	45,97	24,64	53,59	1,10
27NC4532	32 mm	40	29,97	41,91	20,07	56,13	28,96	64,01	1,66
27NC4540	40 mm	24	36,07	53,09	22,10	67,06	32,00	72,39	3,69
27NC4550	50 mm	26	47,50	66,04	24,89	83,57	39,62	89,92	6,89
27NC4563	63 mm	35	59,94	83,06	28,96	102,11	44,96	104,90	9,29
27NC4575	75 mm	16	70,10	99,06	33,02	129,54	65,02	145,03	15,05
27NC4590	90 mm	12	86,11	123,44	37,08	145,03	56,90	139,95	28,19
27NC45110	110 mm	6	100,08	146,05	42,93	172,47	70,10	169,42	46,93
27NC45125	125 mm	4	113,03	165,10	45,97	194,06	77,98	189,48	65,36

Codo 45° SDR7,3 soldadura a testa o accesorio eléctrico

(A)

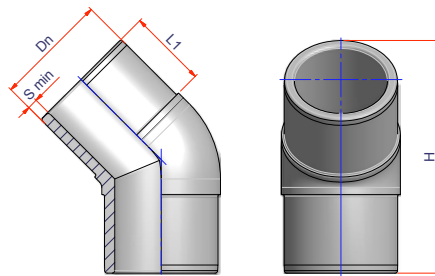
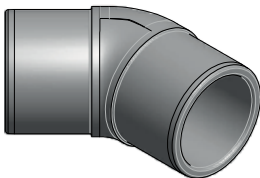

Características

Material: PP-RCT RA7050 color gris
Sistema de unión: Soldadura a testa o manguito eléctrico

Certificados

ASTM F2689, ASTM F2023, NSF14, NSF61, ICC-ES LC 1004
PMG, CSA B137.11-2009, EN ISO 15874

(B)

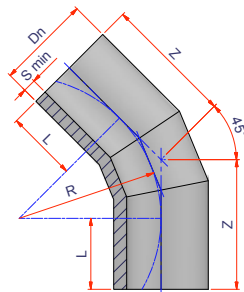
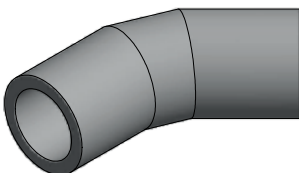

Referencia	Tipo	Dn	Uds. Caja	S min. (mm)	L1 (mm)	L (mm)	H (mm)	Z (mm)	Z (mm)	Precio (€/ud.)
27NC4573160MM	A	160 mm	1	14,60	103,00	-	311,00	-	-	155,22
27NC4573200MMB	B	200 mm	1	18,20	-	150,00	-	274,00	300,00	502,27
27NC4573250MMB	B	250 mm	1	22,70	-	250,00	-	412,00	375,00	870,26

Accesorios termofusión

Manguito unión socket

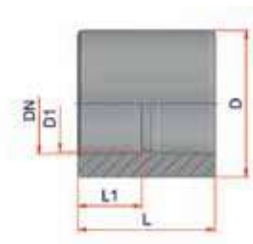

Características

Material: PP-RCT RA7050 color gris
Sistema de unión: Termofusión socket

Certificados

ASTM F2689, ASTM F2023, NSF14, NSF61, ICC-ES LC 1004
PMG, CSA B137.11-2009, EN ISO 15874

Referencia	Dn	Uds. Caja	D1 (mm)	D (mm)	L1 (mm)	L (mm)	Precio (€/ud.)
27NMAN20	20 mm	200	18,03	28,96	17,02	35,05	0,62
27NMAN25	25 mm	150	20,07	35,05	18,03	39,12	0,75
27NMAN32	32 mm	50	29,97	45,97	20,07	42,93	1,15
27NMAN40	40 mm	50	37,08	56,13	22,10	48,01	2,07
27NMAN50	50 mm	20	46,99	70,10	24,89	54,10	3,54
27NMAN63	63 mm	50	59,94	88,14	28,96	61,98	5,75
27NMAN75	75 mm	12	70,10	101,09	33,02	71,12	8,89
27NMAN90	90 mm	8	84,07	124,97	34,04	73,91	16,23
27NMAN110	110 mm	4	106,43	160,02	38,10	82,04	24,91
27NMAN125	125 mm	4	116,08	160,02	41,91	90,93	36,55

Accesorios termofusión

Te unión socket

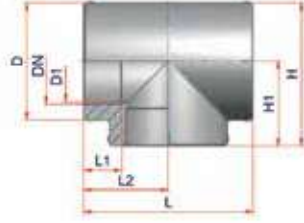

Características

Material: PP-RCT RA7050 color gris
Sistema de unión: Termofusión socket

Certificados

ASTM F2689, ASTM F2023, NSF14, NSF61, ICC-ES LC 1004
PMG, CSA B137.11-2009, EN ISO 15874

Referencia	Dn	Uds. Caja	D1 (mm)	D (mm)	L1 (mm)	L (mm)	H1 (mm)	H (mm)	Precio (€/ud.)
27NT20	20 mm	150	18,03	33,02	16,00	54,10	26,92	43,43	0,92
27NT25	25 mm	80	21,08	35,05	17,02	62,99	31,50	49,02	1,23
27NT32	32 mm	40	29,97	45,97	20,07	73,91	37,08	59,94	1,94
27NT40	40 mm	30	36,07	56,13	22,10	86,11	42,93	71,12	3,62
27NT50	50 mm	16	45,97	70,10	24,89	102,11	51,05	86,11	7,93
27NT63	63 mm	24	58,93	88,14	28,96	123,95	61,98	105,92	12,82
27NT75	75 mm	16	70,10	101,09	33,02	146,05	72,90	123,44	20,04
27NT90	90 mm	8	88,14	113,03	37,08	169,93	85,09	140,46	34,19
27NT110	110 mm	4	100,08	146,05	42,93	199,90	100,08	172,97	58,38
27NT125	125 mm	20	113,03	165,10	47,50	249,94	124,97	207,52	82,06

Te SDR7,3 soldadura a testa o accesorio eléctrico

(A)

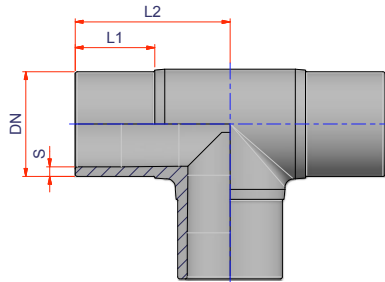

Características

Material: PP-RCT RA7050 color gris
Sistema de unión: Soldadura a testa o accesorio eléctrico

Certificados

ASTM F2689, ASTM F2023, NSF14, NSF61, ICC-ES LC 1004
PMG, CSA B137.11-2009, EN ISO 15874

(B)

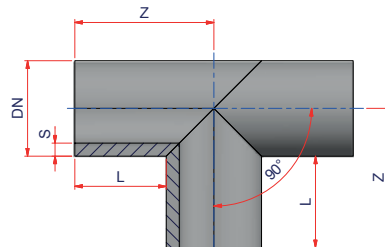

Referencia	Tipo	Dn	Uds. Caja	S (mm)	L1 (mm)	L (mm)	Precio (€/ud.)
27NT73160MM	A	160 mm	1	21,84	103,12	210,06	124,75
27NT73200MMB	B	200 mm	1	27,43	150,11	249,94	350,53
27NT73250MMB	B	250 mm	1	34,29	249,94	374,90	584,50

Accesorios termofusión

Te reducida unión socket

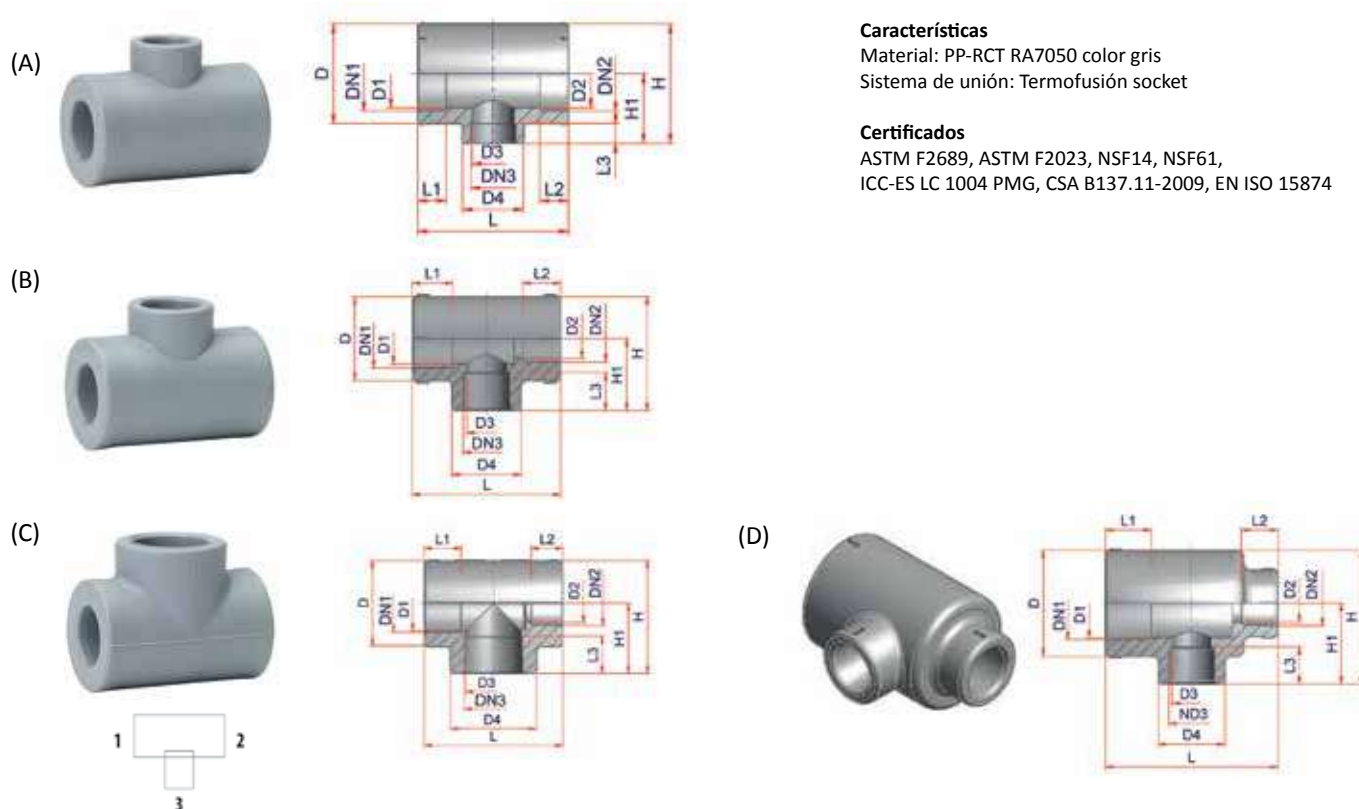

Características
Material: PP-RCT RA7050 color gris
Sistema de unión: Termofusión socket

Certificados
ASTM F2689, ASTM F2023, NSF14, NSF61,
ICC-ES LC 1004 PMG, CSA B137.11-2009, EN ISO 15874

Referencia	Tipo	Ø (mm) (1 x 2 x 3)	Uds. Caja	D1 (mm)	D2 (mm)	D3 (mm)	D4 (mm)	D (mm)	L1 (mm)	L2 (mm)	L3 (mm)	L (mm)	H1 (mm)	H (mm)	Precio (€/ud.)
27NTR252025	A	25 x 25 x 20	80	21,08	21,08	16,51	28,96	35,05	17,02	17,02	16,00	61,98	29,97	47,50	1,48
27NTR322032	A	32 x 32 x 20	40	29,97	29,97	16,51	28,96	45,97	20,07	20,07	16,00	74,93	35,05	57,91	2,24
27NTR322532	A	32 x 32 x 25	40	29,97	29,97	21,08	35,05	45,97	20,07	20,07	17,02	74,93	35,05	57,91	2,24
27NTR402040	A	40 x 40 x 20	20	36,07	36,07	16,51	33,02	53,09	24,13	24,13	16,00	73,91	39,12	66,04	4,39
27NTR402540	A	40 x 40 x 25	20	36,07	36,07	21,08	33,02	53,09	24,13	24,13	20,07	73,91	39,12	66,04	4,39
27NTR403240	A	40 x 40 x 32	18	35,05	35,05	29,97	54,10	54,10	22,10	22,10	20,07	87,12	42,93	70,10	4,39
27NTR502050	A	50 x 50 x 20	12	46,99	46,99	16,51	42,93	66,04	25,91	25,91	16,00	87,12	46,99	80,01	8,19
27NTR502550	A	50 x 50 x 25	10	46,99	46,99	21,08	42,93	66,04	25,91	25,91	20,07	87,12	46,99	80,01	8,19
27NTR503250	A	50 x 50 x 32	14	46,99	46,99	29,97	42,93	66,04	25,91	25,91	20,07	87,12	46,99	80,01	8,19
27NTR504050	A	50 x 50 x 40	8	42,93	42,93	36,07	66,04	66,04	23,11	23,11	22,10	102,11	50,04	83,06	8,19
27NTR632563	A	60 x 63 x 25	6	59,94	59,94	21,08	53,09	83,06	29,97	29,97	17,53	102,11	54,10	96,01	11,31
27NTR633263	A	63 x 63 x 32	10	59,94	59,94	29,97	53,09	83,06	29,97	29,97	21,08	102,11	54,10	96,01	11,31
27NTR634063	A	63 x 63 x 40	10	59,94	59,94	36,07	53,09	83,06	29,97	29,97	23,11	102,11	54,10	96,01	11,31
27NTR635063	A	63 x 63 x 50	6	50,04	50,04	45,97	80,01	80,01	24,89	24,89	25,91	121,92	64,01	103,89	11,31
27NTR753275	A	75 x 75 x 32	16	59,94	59,94	22,10	42,93	98,04	29,97	29,97	18,03	138,94	67,06	116,08	23,60
27NTR754075	A	75 x 75 x 40	16	59,94	59,94	36,07	65,02	98,04	29,97	29,97	23,11	138,94	69,09	118,11	23,60
27NTR755075	A	75 x 75 x 50	14	70,10	70,10	45,97	70,10	101,09	33,02	33,02	24,89	146,05	72,90	123,44	23,60
27NTR756375	A	75 x 75 x 63	16	70,10	70,10	58,93	86,11	101,09	33,02	33,02	28,96	146,05	72,90	123,44	23,60
27NTR906390	A	90 x 90 x 63	12	77,98	77,98	50,04	85,09	119,89	33,02	33,02	26,92	160,02	72,90	133,10	38,10
27NTR907590	A	90 x 90 x 75	10	87,12	87,12	71,12	114,05	114,05	37,08	37,08	33,02	166,88	83,57	139,95	51,27
27NTR11063110	A	110 x 110 x 63	5	100,08	100,08	58,93	86,11	146,05	42,93	42,93	33,02	199,90	100,08	172,97	61,53
27NTR11075110	A	110 x 110 x 75	5	100,08	100,08	69,09	101,09	146,05	42,93	42,93	33,02	199,90	100,08	172,97	61,53
27NTR11090110	A	110 x 110 x 90	4	100,08	100,08	85,09	121,92	146,05	42,93	42,93	37,08	199,90	100,08	172,97	61,53
27NTR12575125	A	125 x 125 x 75	20	113,03	113,03	69,09	101,09	165,10	47,50	47,50	33,02	249,94	115,06	197,10	80,36
27NTR12590125	A	125 x 125 x 90	20	113,03	113,03	85,09	121,92	165,10	47,50	47,50	37,08	249,94	115,06	197,10	80,36
27NTR125110125	A	125 x 125 x 110	20	113,03	113,03	100,08	146,05	165,10	47,50	47,50	42,93	249,94	119,89	202,44	80,36
27NTR252020	B	25 x 20 x 20	90	21,08	16,51	16,51	28,96	35,05	17,02	16,00	16,00	61,98	29,97	47,50	1,48
27NTR322525	B	32 x 25 x 25	40	29,97	21,08	21,08	35,05	45,97	20,07	17,02	17,02	74,93	35,05	57,91	2,24
27NTR252520	C	25 x 20 x 25	80	21,08	16,51	21,08	35,05	35,05	17,02	16,00	17,02	61,98	29,97	47,50	1,48
27NTR323225	C	32 x 25 x 32	40	29,97	21,08	29,97	45,97	45,97	20,07	17,02	20,07	74,93	38,10	60,96	2,24
27NTR322020	D	32 x 20 x 20	70	29,97	16,51	16,51	28,96	45,97	20,07	16,00	16,00	74,93	35,05	57,91	2,24
27NTR322025	D	32 x 25 x 20	50	29,97	21,08	16,51	28,96	45,97	20,07	17,02	16,00	74,93	35,05	57,91	2,24

Accesorios termofusión

Reducción Macho/Hembra unión socket

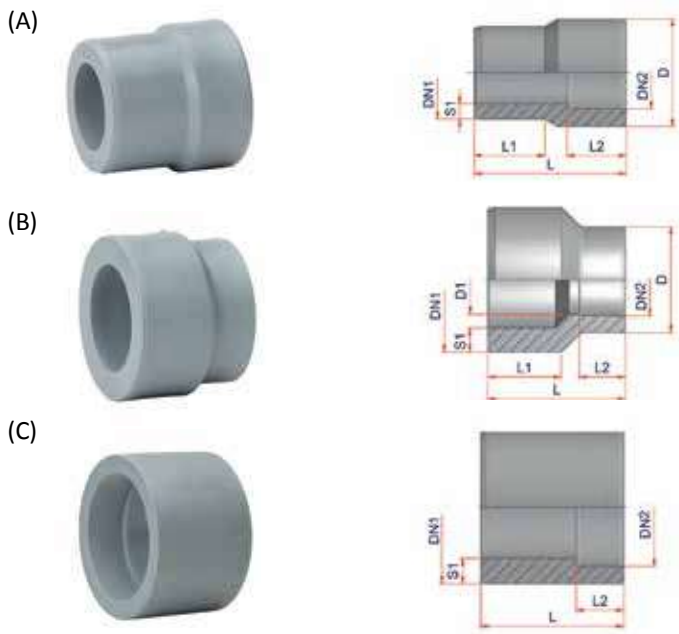

Características

Material: PP-RCT RA7050 color gris
Sistema de unión: Termofusión socket

Certificados

ASTM F2689, ASTM F2023, NSF14, NSF61,
ICC-ES LC 1004 PMG, CSA B137.11-2009, EN ISO 15874

Referencia	Tipo	Dn1	Dn2	Uds. Caja	S1 (mm)	D1 (mm)	D (mm)	L1 (mm)	L2 (mm)	L (mm)	Precio (€/ud.)
27NR2520	A	25 mm	20 mm	100	4,32	-	28,96	19,05	16,00	40,89	0,79
27NR3220	B	32 mm	20 mm	80	5,33	16,00	26,92	22,10	16,00	38,61	0,96
27NR3225	A	32 mm	25 mm	80	5,33	-	35,05	22,10	17,02	43,94	0,96
27NR4032	A	40 mm	32 mm	40	5,84	-	45,97	24,89	20,07	50,04	1,89
27NR5040	A	50 mm	40 mm	40	8,38	-	56,13	27,94	22,10	55,12	3,38
27NR6350	A	63 mm	50 mm	20	10,41	-	70,10	32,00	24,89	54,10	5,48
27NR7563	A	75 mm	63 mm	12	12,45	-	83,06	36,07	28,96	73,91	9,58
27NR9075	A	90 mm	75 mm	18	14,99	-	96,01	37,08	34,04	80,01	19,26
27NR11090	A	110 mm	90 mm	5	18,29	-	130,05	55,12	35,05	109,98	31,25
27NR125110	A	125 mm	110 mm	24	20,83	-	138,94	50,04	42,93	114,05	40,29
27NR4020	B	40 mm	20 mm	80	6,60	16,00	28,96	24,89	16,00	44,96	1,89
27NR4025	B	40 mm	25 mm	70	6,60	21,08	35,05	24,89	17,02	44,96	1,89
27NR5020	B	50 mm	20 mm	40	6,86	16,00	28,96	27,94	16,00	53,09	3,38
27NR5025	B	50 mm	25 mm	40	6,86	21,08	35,05	27,94	17,02	53,09	3,38
27NR5032	B	50 mm	32 mm	35	6,86	29,97	45,97	27,94	20,07	53,09	3,38
27NR6325	B	63 mm	25 mm	30	10,41	21,08	35,05	32,00	17,02	85,34	5,48
27NR6332	B	63 mm	32 mm	30	10,41	29,97	45,97	32,00	20,07	85,34	5,48
27NR6340	B	63 mm	40 mm	30	10,41	37,08	56,13	32,00	22,10	85,34	5,48
27NR7520	B	75 mm	20 mm	20	12,45	19,30	26,42	35,05	16,00	62,99	9,58
27NR7525	B	75 mm	25 mm	20	12,45	24,89	33,02	34,04	8,89	61,98	9,58
27NR7532	B	75 mm	32 mm	20	12,45	27,94	42,93	34,29	20,57	62,99	9,58
27NR7540	B	75 mm	40 mm	18	12,45	37,08	53,34	34,54	23,11	62,99	9,58
27NR7550	B	75 mm	50 mm	18	12,45	50,04	66,04	34,04	20,07	58,93	9,58
27NR11063	B	110 mm	63 mm	28	18,29	58,93	87,88	45,97	28,96	80,01	28,65
27NR9063	C	90 mm	63 mm	10	14,99	-	-	-	27,94	71,88	17,20
27NR11075	C	110 mm	75 mm	12	18,29	-	-	-	32,00	80,01	28,65
27NR12590	C	125 mm	90 mm	4	20,83	-	-	-	34,04	100,08	40,29
27NR160110	C	160 mm	110 mm	1	26,67	-	-	-	38,10	104,90	42,57
27NR160125	C	160 mm	125 mm	1	26,67	-	-	-	41,91	104,90	45,85

Accesorios termofusión

Reducción SDR7,3 Macho/Macho soldadura a testa o con accesorio eléctrico

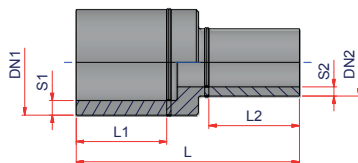
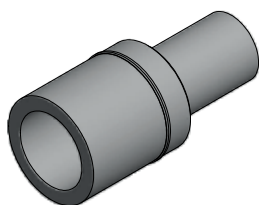

Características

Material: PP-RCT RA7050 color gris
Sistema de unión: Soldadura a testa o accesorio eléctrico

Certificados

ASTM F2689, ASTM F2023, NSF14, NSF61,
ICC-ES LC 1004 PMG, CSA B137.11-2009, EN ISO 15874

Referencia	Dn1	Dn2	Uds. Caja	S1 (mm)	S2 (mm)	L1 (mm)	L2 (mm)	L (mm)	Precio (€/ud.)
27NR1609073MMB	160 mm	90 mm	1	21,84	12,19	175,01	145,03	409,96	340,00
27NR16011073MMB	160 mm	110 mm	1	21,84	14,99	175,01	154,94	420,12	350,00
27NR16012573MMB	160 mm	125 mm	1	21,84	17,02	175,01	165,1	430,02	375,00
27NR20012573MMB	200 mm	125 mm	1	27,43	17,02	184,91	165,1	442,72	430,00
27NR20016073MMB	200 mm	160 mm	1	27,43	21,84	184,91	175,01	450,09	489,00
27NR25016073MMB	250 mm	160 mm	1	34,29	21,84	212,09	175,01	487,17	1.250,00

Reducción Corta SDR7,3 Macho/Macho soldadura a testa

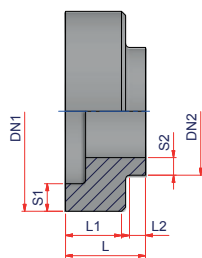

Características

Material: PP-RCT RA7050 color gris
Sistema de unión: Soldadura a testa

Certificados

ASTM F2689, ASTM F2023, NSF14, NSF61,
ICC-ES LC 1004 PMG, CSA B137.11-2009, EN ISO 15874

Referencia	Dn1	Dn2	Uds. Caja	S1 (mm)	S2 (mm)	L1 (mm)	L2 (mm)	L (mm)	Precio (€/ud.)
27NRCC1609073MM	160 mm	90 mm	1	22,10	12,45	50,04	19,81	80,01	198,00
27NRCC16011073MM	160 mm	110 mm	1	22,10	15,24	50,04	19,81	80,01	198,00
27NRCC16012573MM	160 mm	125 mm	1	22,10	17,27	50,04	19,81	80,01	198,00
27NRCC20012573MM	200 mm	125 mm	1	27,43	17,27	53,09	17,02	80,01	232,00
27NRCC20016073MM	200 mm	160 mm	1	27,43	21,84	53,09	17,02	80,01	232,00
27NRCC25016073MM	250 mm	160 mm	1	34,29	21,84	70,10	20,07	80,01	395,00
27NRCC25020073MM	250 mm	200 mm	1	34,29	27,43	70,10	20,07	80,01	395,00

Accesorios termofusión

Tapón unión socket

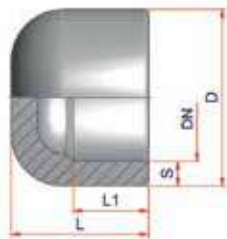

Características

Material: PP-RCT RA7050 color gris
Sistema de unión: Termofusión socket

Certificados

ASTM F2689, ASTM F2023, NSF14, NSF61,
ICC-ES LC 1004 PMG, CSA B137.11-2009, EN ISO 15874

Referencia	Dn	Uds. Caja	S (mm)	D (mm)	L1 (mm)	L (mm)	Precio (€/ud.)
27NCC20	20 mm	200	3,30	29,97	17,02	28,96	0,93
27NCC25	25 mm	130	4,32	35,56	18,03	34,04	1,15
27NCC32	32 mm	80	5,33	44,96	20,07	40,13	1,56
27NCC40	40 mm	50	6,60	54,10	22,10	41,91	2,94
27NCC50	50 mm	35	8,38	66,04	25,40	48,01	4,69
27NCC63	63 mm	30	10,41	83,06	34,04	56,13	8,01
27NCC75	75 mm	10	12,45	99,06	42,93	60,96	11,03
27NCC90	90 mm	30	14,99	119,89	37,08	61,98	24,11
27NCC110	110 mm	15	18,29	148,08	27,94	68,07	31,22
27NCC125	125 mm	14	20,83	167,89	47,50	80,52	42,03

Tapón SDR7,3 corto soldadura a testa

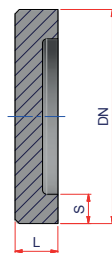
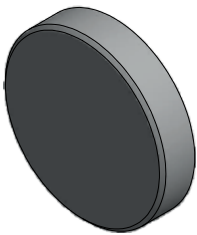

Características

Material: PP-RCT RA7050 color gris
Sistema de unión: Soldadura a testa

Certificados

ASTM F2689, ASTM F2023, NSF14, NSF61,
ICC-ES LC 1004 PMG, CSA B137.11-2009, EN ISO 15874

Referencia	Dn	Uds. Caja	S (mm)	L (mm)	Precio (€/ud.)
27NCC16073MS	160 mm	1	-	-	64,75
27NCC20073MS	200 mm	1	-	-	150,00
27NCC25073MS	250 mm	1	-	-	216,00

Opción de tapones manipulados largos para accesorio eléctrico.

Accesorios termofusión

Injerto unión socket

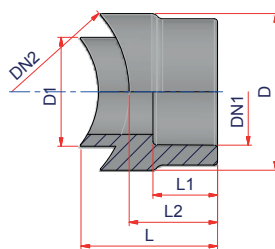

Características

Material: PP-RCT RA7050 color gris
Sistema de unión: Termofusión socket

Certificados

ASTM F2689, ASTM F2023, NSF14, NSF61,
ICC-ES LC 1004 PMG, CSA B137.11-2009, EN ISO 15874

Referencia	Dn1	Dn2	Uds. Caja	D1 (mm)	D (mm)	L1 (mm)	L2 (mm)	L (mm)	Precio (€/ud.)
27NGS2040	20 mm	40 mm	200	24,89	35,05	14,99	20,07	36,58	3,02
27NGS2050	20 mm	50 mm	200	24,89	35,05	14,99	20,07	32,51	2,89
27NGS206375	20 mm	63/75 mm	100	24,89	35,05	14,99	20,07	30,48	2,89
27NGS2090110125	20 mm	90/110/125 mm	200	24,89	35,05	14,99	20,07	29,46	2,89
27NGS20160200	20 mm	160/200 mm	200	24,89	35,05	14,99	20,07	28,45	6,64
27NGS20250315	20 mm	250/315 mm	200	24,89	35,05	14,99	20,07	27,94	6,64
27NGS2540	25 mm	40 mm	130	24,89	35,05	14,99	21,59	38,10	3,02
27NGS2550	25 mm	50 mm	120	24,89	35,05	14,99	21,59	33,78	2,89
27NGS256375	25 mm	63/75 mm	100	24,89	35,05	16,51	21,59	32,00	2,89
27NGS2590110125	25 mm	90/110/125 mm	130	24,89	35,05	16,51	21,59	29,97	2,89
27NGS25160200	25 mm	160/200 mm	230	24,89	35,05	16,51	21,59	29,97	6,64
27NGS25250315	25 mm	250/315 mm	230	24,89	35,05	16,51	21,59	29,46	6,64
27NGS326375	32 mm	63/75 mm	60	32,00	45,97	19,05	25,91	39,88	2,89
27NGS3290110125	32 mm	90/110/125 mm	70	32,00	45,97	19,05	25,91	38,10	2,89
27NGS32160200	32 mm	160/200 mm	80	32,00	45,97	19,05	25,91	36,58	7,04
27NGS32250315	32 mm	250/315 mm	60	32,00	45,97	19,05	25,91	36,07	7,04
27NGS4090	40 mm	90 mm	50	39,88	57,91	21,08	27,94	42,93	2,90
27NGS40110	40 mm	110 mm	50	39,88	57,91	21,08	27,94	41,40	2,90
27NGS40125	40 mm	125 mm	50	39,88	57,91	21,08	27,94	40,64	2,90
27NGS40160200	40 mm	160/200 mm	60	39,88	57,91	21,08	27,94	39,12	7,04
27NGS40250315	40 mm	250/315 mm	60	39,88	57,91	21,08	27,94	38,61	12,00
27NGS5090	50 mm	90 mm	50	50,04	71,88	24,89	36,07	58,93	4,43
27NGS50110	50 mm	110 mm	50	50,04	71,88	24,89	36,07	55,88	4,43
27NGS50125	50 mm	125 mm	50	50,04	71,88	24,89	36,07	54,10	4,43
27NGS50160	50 mm	150 mm	50	50,04	71,88	24,89	36,07	53,09	10,39
27NGS50200	50 mm	200 mm	50	50,04	71,88	24,89	36,07	51,56	11,47
27NGS50250	50 mm	250 mm	50	50,04	71,88	24,89	36,07	50,80	9,59
27NGS63110	63 mm	110 mm	50	62,99	89,92	28,96	39,88	65,02	6,04
27NGS63125	63 mm	125 mm	50	62,99	89,92	28,96	39,88	62,99	6,04
27NGS63160	63 mm	160 mm	60	62,99	89,92	28,96	39,88	59,44	8,66
27NGS63200	63 mm	200 mm	60	62,99	89,92	28,96	39,88	57,91	11,74
27NGS63250	63 mm	250 mm	60	62,99	89,92	28,96	39,88	55,88	11,47



Accesorios roscados

Accesorios termofusión roscados

Enlace rosca hembra unión socket

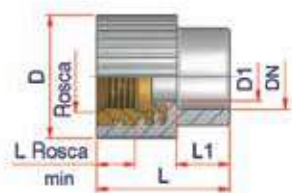

Características

Material: PP-RCT RA7050 color gris
Sistema de unión: Termofusión socket

Certificados

ASTM F2689, ASTM F2023, NSF14, NSF61,
ICC-ES LC 1004 PMG, CSA B137.11-2009, EN ISO 15874

Referencia	Tipo	Dn	Uds. Caja	D1 (mm)	D (mm)	Rosca	L1 (mm)	L (mm)	L Rosca mín. (mm)	Precio (€/ud.)
27NRFF2012L	A	20 mm	70	14,22	37,08	1/2"	16,00	40,13	11,50	6,19
27NRFF2034L	A	20 mm	-	18,00	43,00	3/4"	20,50	46,00	13,20	7,05
27NRFF2512L	A	25 mm	-	14,20	37,00	1/2"	17,00	41,00	11,50	6,53
27NRFF2534L	A	25 mm	60	18,03	41,91	3/4"	18,03	45,97	13,20	7,13
27NRFF3234L	A	32 mm	40	18,03	45,47	3/4"	21,59	51,56	13,20	12,24
27NRFF321L	A	32 mm	30	24,13	54,10	1"	20,07	52,07	18,00	19,48

Enlace rosca hembra unión socket

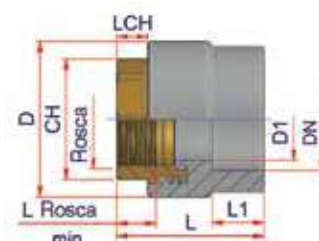
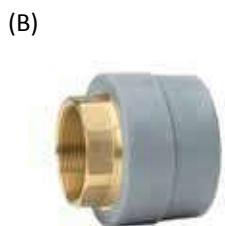

Características

Material: PP-RCT RA7050 color gris
Sistema de unión: Termofusión socket

Certificados

ASTM F2689, ASTM F2023, NSF14, NSF61,
ICC-ES LC 1004 PMG, CSA B137.11-2009, EN ISO 15874

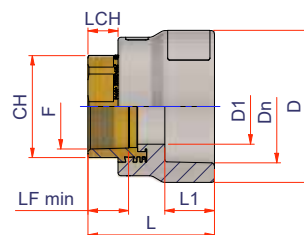
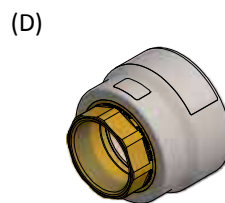
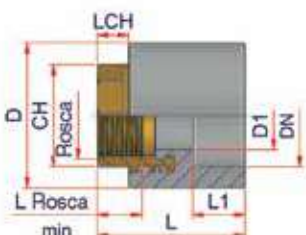

Referencia	Tipo	Dn	Uds. Caja	D1 (mm)	D (mm)	Rosca	L1 (mm)	L (mm)	CH (mm)	LCH (mm)	L Rosca mín. (mm)	Precio (€/ud.)
27NRFF401L	C	40 mm	-	24,0	56,0	1"	22,00	67,00	-	-	18,00	21,10
27NRFF40114L	B	40 mm	25	33,02	65,02	1 1/4"	22,10	69,09	45,97	14,99	21,40	34,56
27NRFF50112L	B	50 mm	18	39,62	74,93	1 1/2"	24,89	72,14	55,12	14,99	19,00	41,49
27NRFF50114L	D	50 mm	-	33,0	70,0	1" 1/4	25,00	71,00	-	-	21,40	36,01
27NRFF632L	B	63 mm	12	50,04	91,95	2"	28,96	80,01	65,02	20,07	23,70	64,76
27NRFF63112L	D	63 mm	-	39,5	88,0	1" 1/2	29,00	75,00	-	-	19,00	44,76
27NRFF752L	D	75 mm	-	50,0	103,0	2"	33,00	84,00	-	-	23,70	62,88
27NRFF75212L	B	75 mm	4	63,50	109,98	2 1/2"	33,02	88,90	80,01	20,07	30,20	82,16
27NRFF903L	B	90 mm	4	74,93	129,03	3"	37,08	99,06	95,00	23,11	33,30	161,92
27NRFF1104L	B	110 mm	2	99,57	160,02	4"	42,93	111,00	119,89	29,97	39,30	166,69
27NRFF1254L	C	125 mm	2	99,57	160,02	4"	47,50	115,57	119,89	29,97	39,30	192,21

Accesorios termofusión roscados

Enlace rosca macho unión socket

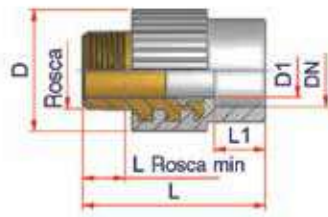

Características

Material: PP-RCT RA7050 color gris
Sistema de unión: Termofusión socket

Certificados

ASTM F2689, ASTM F2023, NSF14, NSF61,
ICC-ES LC 1004 PMG, CSA B137.11-2009, EN ISO 15874

Referencia	Tipo	Dn	Uds. Caja	D1 (mm)	D (mm)	Rosca	L1 (mm)	L (mm)	L Rosca mín. (mm)	Precio (€/ud.)
27NRFM2012L	A	20 mm	70	14,22	37,08	1/2"	16,00	55,12	13,20	6,71
27NRFM2034L	A	20 mm	-	14,10	37,00	1/2"	16,00	55,00	13,20	7,73
27NRFM2512L	A	25 mm	60	14,22	37,08	1/2"	17,02	56,13	13,20	7,51
27NRFM2534L	A	25 mm	60	18,03	41,91	3/4"	17,53	61,98	14,50	7,97
27NRFM3234L	A	32 mm	40	18,03	45,47	3/4"	20,07	68,58	14,50	13,88
27NRFM321L	A	32 mm	26	24,13	54,10	1"	20,07	71,12	16,80	18,09

Enlace rosca macho hexagonal unión socket

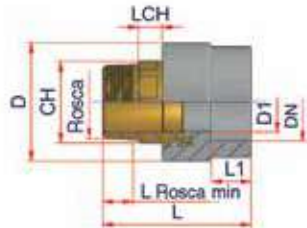

Características

Material: PP-RCT RA7050 color gris
Sistema de unión: Termofusión socket

Certificados

ASTM F2689, ASTM F2023, NSF14, NSF61,
ICC-ES LC 1004 PMG, CSA B137.11-2009, EN ISO 15874

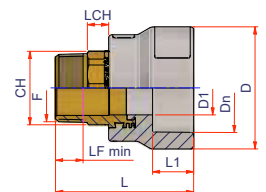
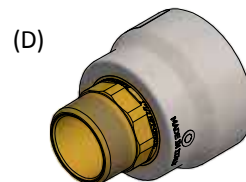
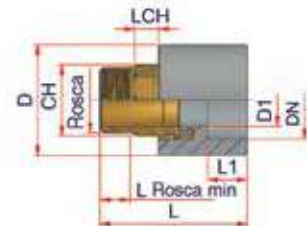

Referencia	Tipo	Dn	Uds. Caja	D1 (mm)	D (mm)	Rosca	L1 (mm)	L (mm)	CH (mm)	LCH (mm)	L Rosca mín. (mm)	Precio (€/ud.)
27NRFM401L	C	40 mm	-	24,00	56,00	1"	22,00	86,00	-	-	16,80	25,31
27NRFM40114L	B	40 mm	20	33,02	65,02	1 1/4"	22,10	90,93	41,91	14,99	19,10	35,02
27NRFM50112L	B	50 mm	15	38,10	74,93	1 1/2"	24,89	93,47	50,04	14,99	19,10	45,23
27NRFM50114L	D	50 mm	-	33,00	70,00	1" 1/4	25,00	93,00	-	-	19,10	34,68
27NRFM632L	B	63 mm	6	49,53	91,95	2"	28,96	104,90	59,94	18,03	23,40	62,38
27NRFM63112L	D	63 mm	-	38,00	88,00	1" 1/2	29,00	97,50	-	-	19,10	48,04
27NRFM752L	D	75 mm	-	49,50	103,00	2"	33,00	109,00	-	-	23,40	67,81
27NRFM75212L	B	75 mm	4	63,50	109,98	2 1/2"	33,02	112,01	80,01	20,07	26,70	90,54
27NRFM903L	B	90 mm	2	74,93	129,03	3"	37,08	129,03	89,92	23,11	29,80	164,23
27NRFM1104L	B	110 mm	2	99,57	160,02	4"	42,93	148,08	115,06	29,97	35,80	227,45
27NRFM1254L	C	125 mm	1	99,57	160,02	4"	47,50	152,40	115,06	29,97	35,80	264,22

Accesorios termofusión roscados

Codo roscado hembra unión socket



Características

Material: PP-RCT RA7050 color gris
Sistema de unión: Termofusión socket

Certificados

ASTM F2689, ASTM F2023, NSF14, NSF61,
ICC-ES LC 1004 PMG, CSA B137.11-2009, EN ISO 15874



Referencia	Tipo	Dn	Uds. Caja	D1 (mm)	D (mm)	Rosca	L1 (mm)	L2 (mm)	L (mm)	H1 (mm)	H (mm)	L Rosca mín. (mm)	CH (mm)	LCH (mm)	Precio (€/ud.)
27NGF2012L	A	20 mm	60	13,97	37,08	1/2"	16,00	39,12	53,59	27,43	45,97	11,50	-	-	5,35
27NGF2512L	A	25 mm	50	13,97	37,08	1/2"	17,02	39,12	56,39	30,48	49,02	11,50	-	-	8,52
27NGF2534L	A	25 mm	50	18,54	41,91	3/4"	17,02	39,12	56,39	30,48	51,56	13,20	-	-	9,16
27NGF3212L	B	32 mm	35	13,97	41,91	1/2"	18,03	45,97	67,06	36,07	56,90	11,50	-	-	10,57
27NGF3234L	B	32 mm	35	18,54	41,91	3/4"	18,03	45,97	67,06	36,07	56,90	13,20	-	-	11,12
27NGF321L	B	32 mm	30	24,13	54,10	1"	20,07	45,97	67,06	46,99	73,91	18,00	-	-	19,03
27NGF401L	B	40 mm	-	24,00	57,00	1"	20,00	52,00	79,00	43,00	72,00	19,00	-	-	22,37
27NGF50114L	B	50 mm	-	33,00	70,00	1" 1/4	25,00	66,00	101,00	51,00	86,00	21,40	46,00	15,00	34,98
27NGF50112L	B	50 mm	-	39,50	70,00	1" 1/2	25,00	66,00	101,00	51,00	86,00	19,00	55,00	15,00	50,41
27NGF63112L	B	63 mm	-	39,50	88,00	1" 1/2	29,00	77,00	121,00	62,00	106,00	19,00	55,00	15,00	63,70
27NGF632L	B	63 mm	-	50,00	88,00	2"	29,00	82,00	126,00	62,00	106,00	23,70	65,00	20,00	70,80

Codo roscado macho unión socket

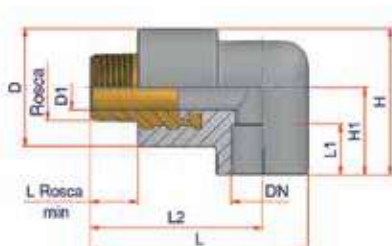

Características

Material: PP-RCT RA7050 color gris
Sistema de unión: Termofusión socket

Certificados

ASTM F2689, ASTM F2023, NSF14, NSF61,
ICC-ES LC 1004 PMG, CSA B137.11-2009, EN ISO 15874

Referencia	Dn	Uds. Caja	D1 (mm)	D (mm)	Rosca	L1 (mm)	L2 (mm)	L (mm)	H1 (mm)	H (mm)	L Rosca mín. (mm)	Precio (€/ud.)
27NGM2012L	20 mm	60	13,97	37,08	1/2"	16,00	54,10	68,58	27,43	45,97	13,20	8,08
27NGM2512L	25 mm	50	13,97	37,08	1/2"	17,02	54,10	71,63	30,48	49,02	13,20	9,59
27NGM2534L	25 mm	40	18,54	41,91	3/4"	17,02	54,10	73,41	30,48	51,56	14,50	9,80
27NGM3212L	32 mm	30	13,97	41,91	1/2"	18,03	60,96	82,04	36,07	56,90	13,20	11,96
27NGM3234L	32 mm	30	18,54	41,91	3/4"	18,03	60,96	84,07	36,07	56,90	14,50	12,07
27NGM321L	32 mm	25	24,13	54,10	1"	20,07	65,02	86,61	46,99	73,91	16,80	24,33

Accesorios termofusión roscados

Rácor loco unión socket

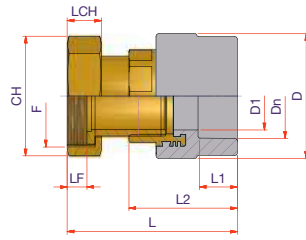

Características

Material: PP-RCT RA7050 color gris
Sistema de unión: Termofusión socket

Certificados

ASTM F2689, ASTM F2023, NSF14, NSF61,
ICC-ES LC 1004 PMG, CSA B137.11-2009, EN ISO 15874

Referencia	Ø	Uds. Caja	Dn (mm)	Rosca	LF (mm)	D1 (mm)	D (mm)	L1 (mm)	L2 (mm)	L (mm)	CH (mm)	LCH (mm)	Precio (€/ud.)
27NBD2034L	20 mm	-	20,00	3/4"	10,80	14,10	37,00	16,00	40,00	62,00	30,00	14,00	19,20
27NBD251L	25 mm	-	25,00	1"	11,50	18,00	42,00	18,00	46,00	70,50	37,00	15,00	21,50
27NBD2534L	25 mm	20	25,00	3/4"	10,80	14,10	37,00	17,00	41,00	62,00	30,00	14,00	24,03
27NBD321L	32 mm	15	32,00	1"	11,50	18,00	45,50	21,50	51,00	76,00	37,00	15,00	28,63
27NBD32114L	32 mm	-	32,00	1"½	14,00	24,00	54,50	20,00	53,00	81,00	46,00	18,00	34,92
27NBD40112L	40 mm	-	40,00	1"½	14,00	33,00	66,00	22,00	69,00	98,00	52,00	18,00	43,53
27NBD40114L	40 mm	20	40,00	1"½	14,00	24,00	56,00	22,00	67,00	93,00	46,00	18,00	51,04
27NBD502L	50 mm	-	50,00	2"	17,50	39,50	76,50	25,00	72,00	107,00	64,50	24,00	97,63
27NBD50112L	50 mm	16	50,00	1"½	14,00	33,00	70,00	25,00	56,00	101,00	52,00	18,00	113,34
27NBD632L	63 mm	10	63,00	2"	17,50	39,50	88,00	29,00	75,00	110,00	64,50	24,00	126,10
27NBD63212L	63 mm	-	63,00	2"½	21,00	50,00	92,00	29,00	80,00	135,50	81,50	25,50	160,40

Injerto rosca hembra unión socket

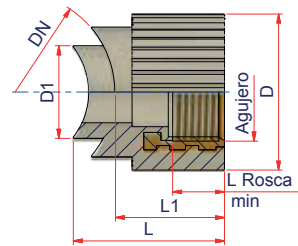

Características

Material: PP-RCT RA7050 color gris
Sistema de unión: Termofusión socket

Certificados

ASTM F2689, ASTM F2023, NSF14, NSF61,
ICC-ES LC 1004 PMG, CSA B137.11-2009, EN ISO 15874

Referencia	Dn	Uds. Caja	D1 (mm)	D (mm)	L1 (mm)	L (mm)	L Rosca mín. (mm)	Precio (€/ud.)
27NGSF124050L	40/50 mm	70	24,89	37,08	31,50	44,96	11,50	10,65
27NGSF126375L	63/75 mm	70	24,89	37,08	31,50	41,91	11,50	10,65
27NGSF1290110125L	90/110/125 mm	70	24,89	37,08	31,50	40,89	11,50	11,04
27NGSF12160200L	160/200 mm	-	24,89	37,08	31,50	39,88	11,50	11,26
27NGSF12250315L	250/315 mm	-	24,89	37,08	31,50	39,88	11,50	17,61
27NGSF344050L	40/50 mm	60	24,89	41,91	33,53	46,99	13,20	13,92
27NGSF346375L	63/75 mm	60	24,89	41,91	33,53	43,94	13,20	12,62
27NGSF3490110125L	90/110/125 mm	60	24,89	41,91	33,53	42,93	13,20	12,62
27NGSF34160200L	160/200 mm	60	24,89	41,91	33,53	41,91	13,20	12,64
27NGSF34250315L	250/315 mm	-	24,89	41,91	33,53	41,91	13,20	23,03
27NGSF016375L	63/75 mm	40	32,00	54,10	38,10	52,07	18,00	17,51
27NGSF0190110125L	90/110/125 mm	40	32,00	54,10	38,10	50,04	18,00	17,51
27NGSF01160200L	160/200 mm	-	32,00	54,10	38,10	48,51	18,00	18,97
27NGSF01250315L	250/315 mm	-	32,00	54,10	38,10	48,01	18,00	27,85

Accesorios termofusión roscados

Te roscada hembra unión socket

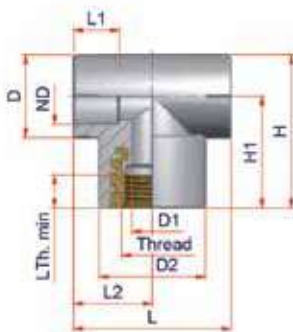

Características

Material: PP-RCT RA7050 color gris
Sistema de unión: Termofusión socket

Certificados

ASTM F2689, ASTM F2023, NSF14, NSF61,
ICC-ES LC 1004 PMG, CSA B137.11-2009, EN ISO 15874

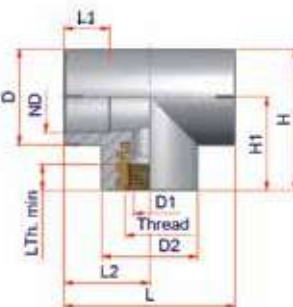

Referencia	Tipo	Ø	Uds. Caja	Rosca	LF (mm)	D1 (mm)	D2 (mm)	D (mm)	L1 (mm)	L2 (mm)	L (mm)	H1 (mm)	H (mm)	Precio (€/ud.)
27NTF2012L	A	20 mm	-	1/2"	11,50	14,10	37,00	29,00	16,00	27,50	55,00	39,00	53,50	7,13
27NTF2512L	A	25 mm	-	1/2"	11,50	14,10	37,00	35,00	17,00	30,50	61,00	39,00	56,50	7,59
27NTF2534L	A	25 mm	-	3/4"	13,20	18,50	42,00	35,00	17,00	30,50	61,00	39,00	56,50	9,65
27NTF3212L	B	32 mm	-	1/2"	11,50	14,10	42,00	42,00	20,00	37,50	75,00	41,00	62,00	9,95
27NTF3234L	B	32 mm	-	3/4"	13,20	18,50	42,00	42,00	20,00	37,50	75,00	41,00	62,00	13,41
27NTF321L	B	32 mm	-	1"	17,80	24,00	54,00	42,00	20,00	47,00	95,00	39,00	66,00	21,46

Te roscada macho unión socket

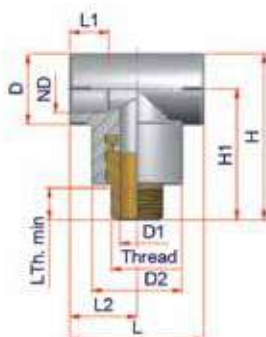

Características

Material: PP-RCT RA7050 color gris
Sistema de unión: Termofusión socket

Certificados

ASTM F2689, ASTM F2023, NSF14, NSF61,
ICC-ES LC 1004 PMG, CSA B137.11-2009, EN ISO 15874

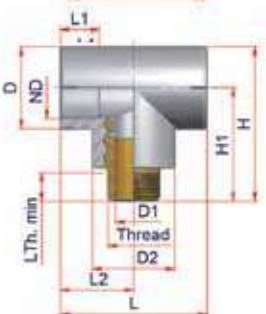

Referencia	Tipo	Dn	Uds. Caja	Rosca	LF (mm)	D1 (mm)	D2 (mm)	D (mm)	L1 (mm)	L2 (mm)	L (mm)	H1 (mm)	H1 (mm)	Precio (€/ud.)
27NTM2012L	A	20 mm	-	1/2"	13,20	14,10	37,00	28,00	16,00	27,50	55,00	54,00	68,50	8,80
27NTM2512L	A	25 mm	-	1/2"	13,20	14,10	37,00	35,00	17,00	30,50	61,00	54,00	71,50	10,52
27NTM2534L	A	25 mm	-	3/4"	14,50	18,50	42,00	35,00	17,00	30,50	61,00	56,00	73,50	11,96
27NTM3212L	B	32 mm	-	1/2"	13,20	14,10	42,00	42,00	20,00	37,50	75,00	56,00	77,00	15,04
27NTM3234L	B	32 mm	-	3/4"	14,50	18,50	42,00	42,00	20,00	37,50	75,00	58,00	79,00	15,77
27NTM321L	B	32 mm	-	1"	16,80	24,00	54,00	42,00	20,00	47,50	95,00	63,50	85,00	23,45



Llaves

Llaves

Llave de paso de esfera extraíble completa NRS unión socket

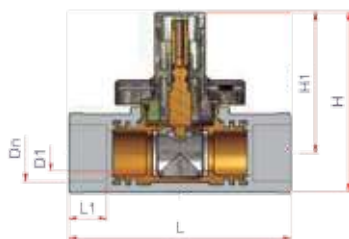

Referencia	Dn	Uds. Caja	Dn (mm)	D1 (mm)	L1 (mm)	L (mm)	H1 (mm)	H (mm)	Precio (€/ud.)
27NRS20	20 mm	10	20,00	15,00	16,00	100,50	73,00	92,00	35,90
27NRS25	25 mm	10	25,00	15,00	17,00	100,50	73,00	92,00	37,80
27NRS32	32 mm	10	32,00	20,00	20,00	121,00	77,00	98,00	41,01

Llave de paso de asiento completa

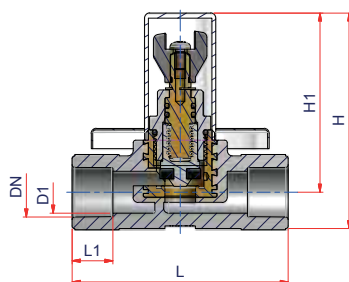

Referencia	Dn	Uds. Caja	D1 (mm)	L1 (mm)	L (mm)	H1 (mm)	H (mm)	Precio (€/ud.)
27NRA20	20 mm	10	16,51	16,00	85,09	70,61	85,09	29,78
27NRA25	25 mm	10	23,62	20,07	100,08	78,99	97,03	31,92

Válvula de paso de esfera. Cuerpo en PP-R RA7050 y bola latón níquel unión socket

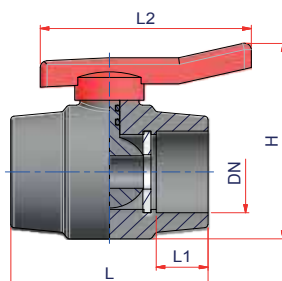

Referencia	Dn	Uds. Caja	Precio (€/ud.)
27NRSPP20	20 mm	1	22,00
27NRSPP25	25 mm	1	28,97
27NRSPP32	32 mm	1	39,78
27NRSPP40	40 mm	1	84,07
27NRSPP50	50 mm	1	121,13



Portabridas

Portabridas

Portabridas con junta tórica unión socket



Características

Material: PPR CT RA 7050 color gris
Sistema de unión: Termofusión socket

Certificados

ASTM F2689, ASTM F2023, NSF14, NSF61,
ICC-ES LC 1004 PMG, CSA B137.11-2009, EN ISO 15874

Referencia	Tipo	Dn	Uds. Caja	D1 (mm)	D2 (mm)	D (mm)	L1 (mm)	L (mm)	Precio (€/ud.)
27NCOSA32	A	32 mm	100	27,94	40,64	51,05	18,03	25,91	4,95
27NCOSA40	A	40 mm	50	36,07	49,53	64,01	20,57	29,97	5,66
27NCOSA50	A	50 mm	36	46,48	60,96	73,15	23,62	34,04	6,19
27NCOSA63	A	63 mm	25	56,90	75,95	102,11	27,94	36,07	10,85
27NCOSA75	A	75 mm	12	71,12	89,92	104,39	29,97	41,91	13,66

Portabridas sin junta unión socket



Características

Material: PPR CT RA 7050 color gris
Sistema de unión: Termofusión socket

Certificados

ASTM F2689, ASTM F2023, NSF14, NSF61,
ICC-ES LC 1004 PMG, CSA B137.11-2009, EN ISO 15874

Referencia	Tipo	Dn	Uds. Caja	D1 (mm)	D2 (mm)	D (mm)	L1 (mm)	L2 (mm)	Precio (€/ud.)
27NCOSA90	B	90 mm	8	84,07	107,95	137,92	37,08	45,97	23,99
27NCOSA110	B	110 mm	10	103,89	131,06	157,99	38,10	52,07	33,48
27NCOSA125	B	125 mm	8	119,89	146,05	160,02	39,88	55,12	66,91

Portabridas largo SDR7,3 sin junta soldadura a testa o accesorio eléctrico

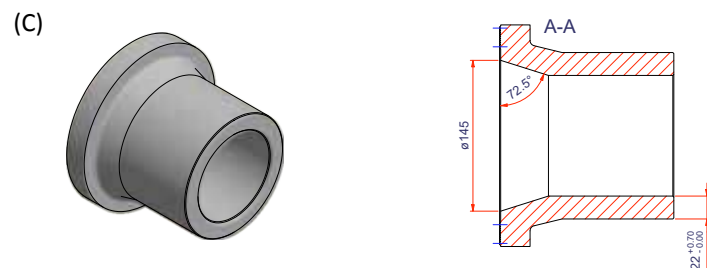

Características

Material: PPR CT RA 7050 color gris
Sistema de unión: Soldadura a tope o con manguito eléctrico

Certificados

ASTM F2689, ASTM F2023, NSF14, NSF61,
ICC-ES LC 1004 PMG, CSA B137.11-2009, EN ISO 15874

Referencia	Tipo	Dn	Uds. Caja	S (mm)	D (mm)	D1 (mm)	L1 (mm)	L2 (mm)	L (mm)	B (mm)	Precio (€/ud.)
27NCRT16073	C	160 mm	1	21,84	214,88	174,50	175,01	32,00	294,89	154,94	199,25
27NCRT20073MB	C	200 mm	1	27,43	270,00	229,62	184,91	36,07	304,80	196,09	365,00
27NCRT25073MB	C	250 mm	1	34,29	320,04	281,43	212,09	45,97	331,98	240,03	900,00



Válvulas

Válvulas

Válvula de paso de esfera PN10. Cuerpo y esfera en PP-RCT RA7050, unión socket (60 °/4 bar, 80 °/2 bar)

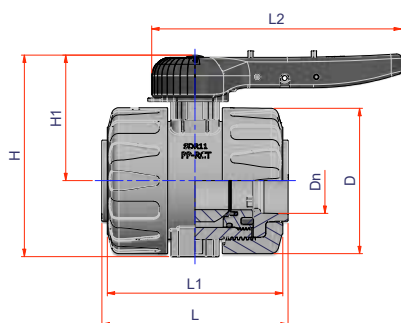
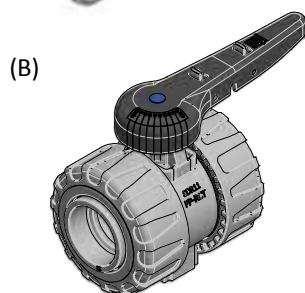
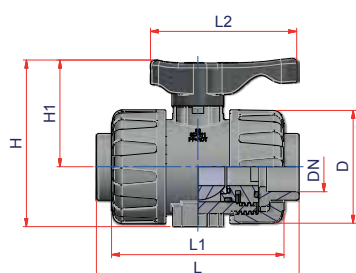

Referencia	Tipo	Dn	Uds, Caja	L2 (mm)	L1 (mm)	L (mm)	D (mm)	H1 (mm)	H (mm)	Precio (€/ud,)
27NRSPPRCT20	A	20 mm	1	91,95	108,71	124,46	71,63	68,33	105,92	66,32
27NRSPPRCT25	A	25 mm	1	91,95	108,71	125,98	71,63	68,33	105,92	76,66
27NRSPPRCT32	A	32 mm	1	91,95	108,71	127,76	71,63	68,33	105,92	92,65
27NRSPPRCT40	A	40 mm	1	134,00	153,50	176,50	122,00	110,00	173,00	114,90
27NRSPPRCT50	A	50 mm	1	134,00	153,50	184,50	122,00	110,00	173,00	149,73
27NRSPPRCT63	A	63 mm	1	134,00	153,50	197,00	122,00	110,00	173,00	191,69
27NRSPPRCT75	B	75 mm	1	339,00	238,00	244,00	198,00	176,00	279,00	337,73
27NRSPPRCT90	B	90 mm	1	339,00	238,00	244,00	198,00	176,00	279,00	416,73

Válvulas

Válvula de paso de esfera. Cuerpo y esfera en PP-RCT RA7050, embocadura de conexión macho (60 °/4 bar, 80 °/2 bar)

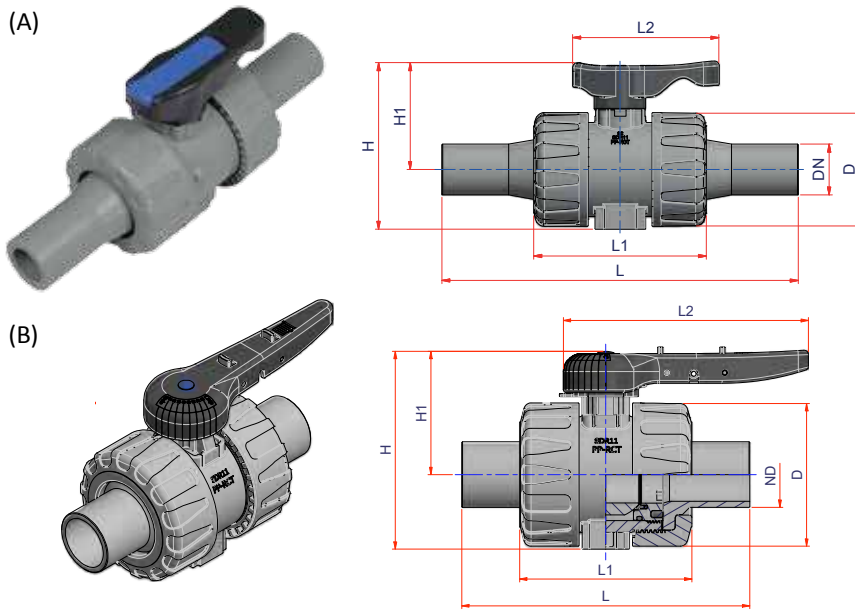

Referencia	Tipo	Dn	Uds. Caja	L2 (mm)	L1 (mm)	L (mm)	D (mm)	H1 (mm)	H (mm)	Precio (€/ud.)
27NRSPPRCTS25	A	25 mm	1	91,95	108,71	234,70	71,63	68,33	105,92	A consultar
27NRSPPRCTS32	A	32 mm	1	91,95	108,71	232,66	71,63	68,33	105,92	A consultar
27NRSPPRCTS40	A	40 mm	1	91,95	108,71	270,76	71,63	68,33	105,92	A consultar
27NRSPPRCTS50	A	50 mm	1	134,00	153,50	305,00	122,00	110,00	173,00	A consultar
27NRSPPRCTS63	A	63 mm	1	134,00	153,50	345,00	122,00	110,00	173,00	A consultar
27NRSPPRCTS75	A	75 mm	1	134,00	153,50	344,00	122,00	110,00	173,00	A consultar
27NRSPPRCTS90	B	90 mm	1	339,00	238,00	398,00	198,00	176,00	279,00	A consultar
27NRSPPRCTS110	B	110 mm	1	339,00	238,00	412,00	198,00	176,00	279,00	612,66

Válvula de mariposa PN10. Cuerpo en PP Unión embridada (60°C/10 bar, 80°C/6 bar)



Referencia	Ø	Uds. Caja	Precio (€/ud.)
EPDM63BM	63 mm	1	352,52
EPDM75BM	75 mm	1	357,21
EPDM90BM	90 mm	1	392,27
EPDM110BM	110 mm	1	484,54
EPDM125BM	125 mm	1	599,23
EPDM160BM	160 mm	1	639,93
EPDM200BM	200 mm	1	1.127,79

Válvulas

Recomendaciones básicas de instalación para válvulas de paso de esfera

“Un funcionamiento seguro y estanco de las válvulas presupone que éstas se instalen, manipulen, unan, mantengan y reparen por personal cualificado y siguiendo las recomendaciones del fabricante”

Preparación de la válvula

Se deberá proceder al accionamiento de apertura y cerrado de la válvula en repetidas ocasiones previamente a la soldadura.

Procedimiento de unión

Válvulas modelo NRSP

La unión mediante termo fusión debe ser realizada con la maneta en modo abierto y no cerrarla hasta que la temperatura superficial de la válvula sea la ambiental.

En caso de realizar la soldadura con la maneta cerrada, se podrán generar sobrecalentamientos en el cuerpo de la válvula por disipación de calor que podrían afectar a la juntas internas provocando la no estanquidad.

Válvulas modelo 27NSRPPRCT

- Previamente al procedimiento de termofusión, se debe desentascar las tuercas de unión hembras y colocar la esfera en posición abierta.
- Colocar la tuerca de unión en la tubería a soldar con la válvula.
- Soldar el conector socket hembra mediante termofusión.
- Respetar el tiempo de enfriamiento.
- Ensamblar la válvula sin olvidar la Oring.
- Puede asegurarse el apriete de las tuercas de unión mediante las **pestañas de fijación** diseñadas para tal fin, localizados en la zona central del cuerpo de la válvula.
- De forma opcional, puede cambiarse el color de las **pestañas de fijación** y de la **placa de apertura** de la válvula. El modelo dispone de ambas partes tanto en azul como en rojo.

* Se aplicarán dichas recomendaciones sin perjuicio de las indicaciones y recomendaciones garantizadas por el fabricante.

Manipulación de las válvulas

No se recomienda manipular ni aflojar las partes internas del cuerpo de las válvulas de modelo 27NSRPPRCT, a no ser que se requiera un cambio de la esfera interna.



Suportación de las válvulas

Todas las válvulas o cualquier elemento con volante o palanca manual deben de ser instalados como puntos fijos en la instalación.

El objetivo es aislar los fenómenos de dilatación sobre el elemento y reducir o minimizar los momentos transmitidos a la tubería durante su manipulación.



Bridas

Bridas

Brida de aluminio PN16 para portabridas soldadura socket o con accesorio eléctrico. Sistema métrico EN 1092



Referencia	Ø Tubería NIRON	Ø Interior brida (mm)	Ø Exterior brida (mm)	Uds, Caja	Nº agujeros	Distancia agujeros (mm)	Ø agujeros (mm)	Para conexión con válvula	PN	Precio (€/ud.)
SOCKET										
NFLA32	32 mm	45,0	115,0	1	4	85,0	14,0	DN25 1"	10/16	17,89
NFLA40	40 mm	51,0	140,0	1	4	100,0	18,0	DN32 1 1/4"	10/16	31,23
NFLA50	50 mm	62,0	150,0	1	4	110,0	18,0	DN40 1 1/2"	10/16	33,75
NFLA63	63 mm	78,0	165,0	1	4	125,0	18,0	DN50 2"	10/16	38,03
NFLA75	75 mm	92,0	185,0	1	4	145,0	18,0	DN65 2 1/2"	10/16	51,27
NFLA90	90 mm	110,0	200,0	1	8	160,0	18,0	DN80 3"	10/16	58,20
NFLA110	110 mm	133,0	220,0	1	8	180,0	18,0	DN100 4"	10/16	65,31
NFLA125B	125 mm	149,0	250,0	1	8	210,0	18,0	DN125 5"	10/16	79,84
SOLDADURA A TESTA										
NFLA160	160 mm	178,0	285,0	1	8	240,0	22,0	DN150 6"	10/16	101,19
NFLA20016	200 mm	238,0	340,0	1	12	295,0	22,0	DN200 8"	16	160,44

Brida de aluminio PN10 para portabridas soldadura a testa o con accesorio eléctrico. Sistema métrico EN 1092



Referencia	Ø Tubería NIRON	Ø Interior brida (mm)	Ø Exterior brida (mm)	Uds. Caja	Nº agujeros	Distancia agujeros (mm)	Ø agujeros (mm)	Para conexión con válvula	PN	Precio (€/ud.)
NFLA20010	200 mm	238,0	340,0	1	8	295,0	22,0	DN200 8"	10	160,44
NFLA250	250 mm	288,0	395,0	1	12	350,0	22,0	DN250 10"	10	212,84
NFLA315	315 mm	338,0	445,0	1	12	400,0	22,0	DN300 12"	10	353,33
NFLA355	355 mm	376,0	505,0	1	16	460,0	22,0	DN350 14"	10	571,77
NFLA400	400 mm	430,0	565,0	1	16	515,0	25,0	DN400 16"	10	593,35
NFLA450	450 mm	517,0	670,0	1	20	620,0	26,0	DN500 20"	10	815,46
NFLA500	500 mm	533,0	670,0	1	20	620,0	25,0	DN500 20"	10	815,25

Bridas

Brida de acero con revestimiento de PP para portabridas soldadura socket. Sistema métrico EN 1092



Referencia	Ø Tubería NIRON	Ø Interior brida (mm)	Ø Exterior brida (mm)	Uds. Caja	Nº agujeros	Distancia agujeros (mm)	Ø agujeros (mm)	Para conexión con válvula	PN	Precio (€/ud.)
NFLA32PP	32 mm	42,0	115,0	1	4	85,0	14,0	DN25 1"	10/16	18,89
NFLA40PP	40 mm	51,0	140,0	1	4	100,0	18,0	DN32 1 1/4"	10/16	25,76
NFLA50PP	50 mm	62,0	150,0	1	4	110,0	18,0	DN40 1 1/2"	10/16	29,59
NFLA63PP	63 mm	78,0	165,0	1	4	125,0	18,0	DN50 2"	10/16	35,33
NFLA75PP	75 mm	92,0	186,0	1	4	145,0	18,0	DN65 2 1/2"	10/16	41,66
NFLA90PP	90 mm	108,0	202,0	1	8	160,0	18,0	DN80 3"	10/16	53,92
NFLA110PP	110 mm	135,0	220,0	1	8	180,0	18,0	DN100 4"	10/16	73,26

La empresa fabricante se reserva el derecho de cambio de color del revestimiento de PP.

Brida de acero con revestimiento de PP para portabridas soldadura a testa o con accesorio eléctrico. Sistema métrico EN 1092



Referencia	Ø Tubería NIRON	Ø Interior brida (mm)	Ø Exterior brida (mm)	Uds. Caja	Nº agujeros	Distancia agujeros (mm)	Ø agujeros (mm)	Para conexión con válvula	PN	Precio (€/ud.)
NFLA160PP	160 mm	178,0	285,0	1	8	240,0	22,0	DN150 6"	10-16	117,66
NFLA200PP	200 mm	235,0	340,0	1	8	295,0	22,0	DN200 8"	10	173,80
NFLA200PP16	200 mm	235,0	340,0	1	12	295,0	22,0	DN200 8"	16	165,90
NFLA250PP	250 mm	288,0	409,0	1	12	350,0	22,0	DN250 10"	10	225,54
NFLA250PP16	250 mm	288,0	418,0	1	12	355,0	26,0	DN250 10"	16	260,54
NFLA315PP	315 mm	338,0	463,0	1	12	400,0	23,0	DN300 12"	10	312,53
NFLA315PP16	315 mm	338,0	478,0	1	12	410,0	26,0	DN300 12"	16	330,31
NFLA355PP	355 mm	376,0	515,0	1	16	460,0	22,5	DN350 14"	10	524,06
NFLA355PP16	355 mm	376,0	530,0	1	16	470,0	26,0	DN350 14"	16	601,12
NFLA400PP	400 mm	430,0	574,0	1	16	515,0	26,0	DN400 16"	10	546,15
NFLA400PP16	400 mm	430,0	599,0	1	16	525,0	30,0	DN400 16"	16	664,35
NFLA450PP	450 mm	517,0	678,0	1	20	620,0	26,0	DN500 20"	10	742,36
NFLA500PP	500 mm	533,0	678,0	1	20	620,0	26,0	DN500 20"	10	757,87
NFLA560PP	560 mm	618,0	789,0	1	20	725,0	26,0	DN600 24"	10	938,93
NFLA630PP	630 mm	645,0	789,0	1	20	725,0	26,0	DN600 24"	10	938,93

La empresa fabricante se reserva el derecho de cambio de color del revestimiento de PP.



Abrazaderas

Abrazaderas NIRON

Abrazaderas NIRON con goma lisa



Descripción

- Abrazadera isofónica con goma lisa EPDM azul RAL 5012 **lisa**
- Para realización de punto fijo y punto deslizable
- Aislamiento al ruido según DIN 4109
- Doble rosca
- Dispone de arandelas espaciadoras extraíbles
- Tornillos seguridad con arandela anti-pérdida
- Material: Acero zincado
- Reacción al fuego de la goma. B2 según DIN 4102

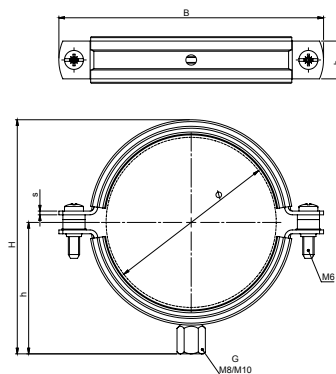

Referencia	Para tubería Ø (mm)	Uds. Caja	G	b x S (mm)	Espaciador por cada rosca			B (mm)	H (mm)	h (mm)	Precio (€/ud.)
					Amarillo 5 mm (0,2")	Crema 4 mm (0,16")	Verde 2,5 mm (0,1")				
AB115022AZ	20 mm	50	M8/M10	20 x 1,25	2	2		66,0	49,0	32,2	1,31
AB115028AZ	25 mm	50	M8/M10	20 x 1,25	2	2		71,0	54,0	34,7	1,45
AB115035AZ	32 mm	50	M8/M10	20 x 1,25	2	2		79,0	61,0	38,2	1,57
AB115040AZ	40 mm	25	M8/M10	20 x 1,25	2	2	2	87,0	73,3	44,0	1,88
AB115048AZ	50 mm	25	M8/M10	20 x 1,25	2	2	2	93,0	84,3	49,5	2,87
AB115060AZ	63 mm	25	M8/M10	20 x 1,25	2	2		105,0	98,8	56,7	3,38
AB115075AZ	75 mm	25	M8/M10	20 x 1,50	4			127,0	108,0	61,5	4,18
AB115090AZ	90 mm	25	M8/M10	20 x 2,00	4	2		140,0	123,8	69,5	4,94
AB115110AZ	110 mm	25	M8/M10	23 x 2,00	6	2		161,0	145,8	80,5	6,28
AB115125AZ	125 mm	25	M8/M10	23 x 2,00	6		2	180,0	158,8	86,8	7,98
AB115160AZ	160 mm	25	M8/M10	25 x 2,00	6	2		228,0	199,0	107,0	9,88
AB115200AZ	200 mm	25	M8/M10	25 x 2,00	4	4		263,0	237,0	128,0	16,46

- Abrazaderas isofónicas NIRON según DIN 4109
- Recomendadas para instalación con tuberías de PP-R NIRON
- Aptas para realización de puntos fijos y puntos deslizantes

Mejoras Abrazaderas NIRON

La parte interior del revestimiento de la gama con goma lisa, mejora el deslizamiento de la tubería en caso de proponer la instalación deslizable.

La propia abrazadera dispone de unas arandelas espaciadoras extraíbles y tornillos seguridad con arandela anti-pérdida.

Las arandelas espaciadoras tienen por objetivo permitir el deslizamiento de la tubería debido a la dilatación por efecto de la temperatura o, en el caso de extraerlas, permitir realizar un punto fijo.

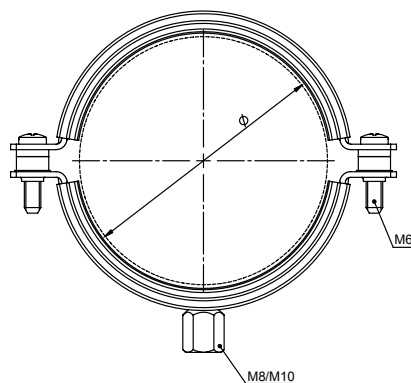

Mecanismo de arandela anti-pérdida

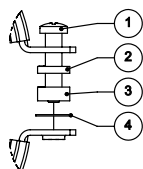

1. Tornillo métrica M6
2. Arandela plástica espaciadora *
3. Arandela plástica espaciadora *
4. Arandela anti-pérdida

(*) configuración del nº de arandelas espaciadoras, espesores y colores en función del diámetro adjunto en tabla superior.



Abrazaderas NIRON

Abrazadera Isofónica de carga pesada para grandes diámetros (M16)

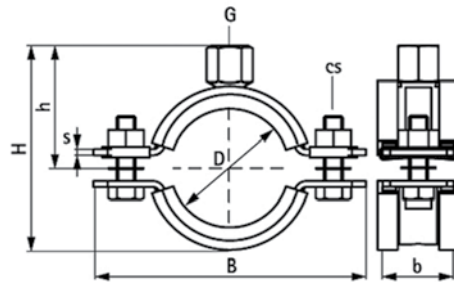

Referencia	∅	Uds. Caja	D (")	Dn (mm)	G (mm)	B (mm)	H (mm)	h (mm)	b x s (mm)	Precio (€/ud.)
AB33168250	240/250 mm	2	-	-	M16	345,0	302,0	163,0	38 x 4,0	50,73
AB33168325	315/325 mm	2	12,0	300,0	M16	414,0	374,0	198,0	48 x 5,0	54,36
AB33168364	354/364 mm	2	14,0	350,0	M16	453,0	412,0	217,0	48 x 5,0	74,75
AB33168408	398/408 mm	2	16,0	400,0	M16	497,0	456,0	239,0	48 x 5,0	79,43
33168458	448/458 mm	2	18,0	450,0	M16	548,0	506,0	264,0	48 x 5,0	93,88

Recomendaciones de instalación



Programa de cálculo de abrazaderas y dimensionado de liras y brazos de dilatación para tubería NIRON

La herramienta provee de manera rápida y sencilla el número de abrazaderas así como el dimensionado de liras y brazos en función de la medición de su instalación, diámetro de tubería NIRON y temperatura del fluido trasegado.

Consultar en el manual técnico SISTEMA NIRON la tabla de distancias entre abrazaderas según cada tipo de tubería o descargar el programa **Italsupport** de la página www.italсан.com



Collares de derivación

Collarines de derivación electrosoldables

Una solución diferencial en el sistema de PP-R NIRON



El constante desarrollo e innovación en productos y la especialización como productores de accesorios electrosoldables ha hecho realidad la nueva gama de collarines de derivación electrosoldables SDR11 en Polipropileno.

Una vez más, aportamos a la instalación una solución versátil y adaptable a cualquier instalación existente.

Collar de derivación salida macho SDR11 soldadura eléctrica (clase 1/6, clase 2/4, clase 4/6)

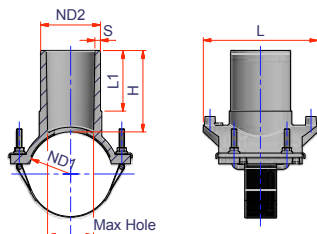

Referencia	Dn1 (mm)	Dn2 (mm)	Uds. Caja	S (mm)	L1 (mm)	L (mm)	H (mm)	Agujero máx. (mm)	Precio (€/ud.)
27NCOL11090	110,0	90,0	1	8,1	89,9	169,9	119,9	70,1	117,62
27NCOL12575	125,0	75,0	1	6,9	89,9	169,9	119,9	58,9	136,28
27NCOL12590	125,0	90,0	1	8,1	89,9	169,9	119,9	70,1	117,62
27NCOL16075	160,0	75,0	1	6,9	89,9	169,9	119,9	58,9	141,15
27NCOL16090	160,0	90,0	1	8,1	89,9	169,9	119,9	70,1	158,09
27NCOL20075	200,0	75,0	1	6,9	89,9	169,9	119,9	58,9	151,86
27NCOL20090	200,0	90,0	1	8,1	89,9	169,9	119,9	70,1	170,08
27NCOL200110	200,0	110,0	1	9,9	98,0	199,9	130,1	87,1	189,71
27NCOL200125	200,0	125,0	1	11,4	98,0	199,9	130,1	100,1	201,70
27NCOL25090	250,0	90,0	1	8,1	98,0	199,9	130,1	70,1	213,69
27NCOL250110	250,0	110,0	1	22,9	98,0	199,9	130,1	87,1	222,41
27NCOL250125	250,0	125,0	1	11,4	98,0	199,9	130,1	100,1	234,41
27NCOL31590	315,0	90,0	1	8,1	98,0	199,9	130,1	70,1	258,40
27NCOL315110	315,0	110,0	1	9,9	98,0	199,9	130,1	100,1	270,38
27NCOL315125	315,0	125,0	1	11,4	98,0	199,9	130,1	100,1	286,73

Procedimiento de instalación



1 Mida la longitud del accesorio y marque el área de soldadura con un marcador. Raspe la superficie de la tubería cuidadosamente con un raspador.



2 Después de raspar, elimine la suciedad y la grasa del área de soldadura de la tubería y el interior del asiento del collarín, usando un agente de limpieza apropiado. Espere hasta que las partes limpias estén completamente secas.



3 Coloque el asiento del collarín sobre la tubería y tenga cuidado de no ensuciar las superficies previamente limpiadas.

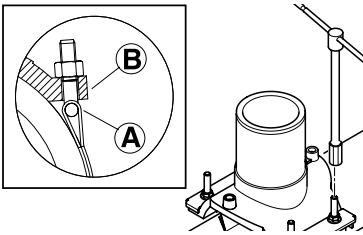

4 Sujete el asiento del collar de derivación a la tubería con la cincha flexible. Use una llave para apretar las cuatro tuercas hasta que el perno en U (A) y la parte superior del collarín (B) estén en contacto perfecto.



5 Conecte los dos cables de la máquina de electrofusión a los conectores del collar electrosoldable y siga el procedimiento de soldadura habitual para accesorios electrosoldables. Los parámetros de tiempo y voltaje siempre vienen definidos en el código de barras del collar. (Ver Manual Técnico Niron).



6 Al final del tiempo de enfriamiento, es posible iniciar la prueba de presión. En la tabla adjunta encontrará el tiempo de espera recomendado en MINUTOS antes de comenzar la prueba.



7 Proceda a realizar la perforación de la tubería con una broca o elemento perforador adecuado, comprobando que el diámetro de la broca y longitud es compatible con el interior de la tubería principal y de la derivación. **NUNCA PERFORAR EL TUBO PREVIAMENTE A LA SOLDADURA O ANTES DE COMPLETAR EL PROCESO DE SOLDADURA.**

Tiempo de espera para test de presión tras soldadura

Ø Tubería primaria (mm)	Prueba de presión < 6bar	Prueba de presión > 6bar
63- 315	Tiempo de enfriamiento del collar (cooling time) + 20 minutos	Tiempo de enfriamiento del collar (cooling time) + 60 minutos

Collarines de derivación electrosoldables

Una solución diferencial en el sistema de PP-R NIRON

Los nuevos collarines de derivación electrosoldables Sistema NIRON en SDR 11 con salida macho son una solución versátil y adaptable a cualquier instalación existente.

Ejemplos:

- Para colocar un ramal en una tubería principal.
- Cuando no es posible cortar un tramo e intercalar una TE.
- La colocación de este accesorio permite un ahorro en el número de soldaduras a realizar y en los tiempos de trabajo.





Herramientas

Herramientas

Matrices para accesorios unión socket



Referencia	∅	Uds. Caja	Precio (€/ud.)
NMATRICE16A	16 mm	1	63,06
NMATRICE20A	20 mm	1	63,42
NMATRICE25A	25 mm	1	66,49
NMATRICE32A	32 mm	1	75,41
NMATRICE40A	40 mm	1	96,65
NMATRICE50A	50 mm	1	115,51
NMATRICE63A	63 mm	1	132,98
NMATRICE75A	75 mm	1	174,80
NMATRICE90A	90 mm	1	236,50
NMATRICE110A	110 mm	1	313,09
NMATRICE125A	125 mm	1	387,30

Matrices para injertos NGS y NGSF



Referencia	Para el injerto	∅	Uds. Caja	Precio (€/ud.)
NMATGS4025	NGS2040 - NGS2540	40/25 mm	1	179,03
NMATGS5025	NGS2050 - NGS2550 - NGSF124050 - NGSF344050	50/25 mm	1	179,03
NMATGS637525	NGS206375 - NGS256375 - NGSF126375 - NGSF346375	63-75/25 mm	1	179,03
NMATGS9011012525	NGS2090110125 - NGS2590110125 - NGSF1290110125 - NGSF3490110125	90-110-125/25 mm	1	179,03
NMATGS16020025	NGS20160200 - NGS25160200 - NGSF12160200 - NGSF34160200	160-200/25 mm	1	179,03
NMATGS637532	NGS326375 - NGSF16375	63-75/32 mm	1	197,91
NMATGS9011012532	NGS3290110125 - NGSF190110125	90-110-125/32 mm	1	197,91
NMATGS16020032	NGS32160200	160-200/32 mm	1	197,91
NMATGS9040	NGS4090	90/40 mm	1	206,30
NMATGS11040	NGS40110	110/40 mm	1	206,30
NMATGS12540	NGS40125	125/40 mm	1	206,30
NMATGS16020040	NGS40160200	160-200/40 mm	1	284,23
NMATGS25040	NGS40250315	250/40 mm	1	A consultar
NMATGS9050	NGS5090	90/50mm	1	322,05
NMATGS11050	NGS50110	110/50 mm	1	322,05
NMATGS12550	NGS50125	125/50 mm	1	322,05
NMATGS16050	NGS50160	160/50 mm	1	322,05
NMATGS20050	NGS50200	200/50 mm	1	322,05
NMATGS25050	NGS50250	250/50 mm	1	322,05
NMATGS31563050	NGS50315 - NGS50355450 - NGS50500630	315-355-450-500-630/50 mm	1	A consultar
NMATGS11063	NGS63110	110/63 mm	1	342,68
NMATGS12563	NGS63125	125/63 mm	1	342,68
NMATGS16063	NGS63160	160/63 mm	1	342,68
NMATGS20063	NGS63200	200/63 mm	1	342,68
NMATGS25063	NGS63250	250/63 mm	1	342,68
NMATGS31563063	NGS63315 - NGS63355450 - NGS63500630	315-355-450-500-630/63 mm	1	A consultar



Herramientas

Fresa para injerto NGS y NGSF



Referencia	Tipo	Ø	Uds. Caja	Precio (€/ud.)
NFGS25	A	25 (agujero Ø 23 mm)	1	131,80
NFGS32	A	32 (agujero Ø 30 mm)	1	148,99
NFGS40	B	40 (agujero Ø 38,5 mm)	1	230,36
NFGS50	B	50 (agujero Ø 48,5 mm)	1	256,72
NFGS63	B	63 (agujero Ø 61,5 mm)	1	285,37

Matriz reparadora



Referencia	Ø	Uds. Caja	Precio (€/ud.)
NMAP7	6 mm (agujero Ø 6 mm)	1	123,59
NMAP11	10 mm (agujero Ø 10 mm)	1	123,59

Tapón de reparación



Referencia	Tipo	Ø	Uds. Caja	D1 (mm)	D2 (mm)	L1 (mm)	L2 (mm)	L (mm)	Precio (€/ud.)
NCAR711	A	7/11 mm	150	7,0	11,0	35,0	35,0	84,0	1,12
27NCAR711	B	7/11 mm							1,31

Tapón para nivel



Referencia	Ø	Uds. Caja	D1 (mm)	D2 (mm)	L (mm)	Precio (€/ud.)
NTUN	1/2" - 3/4"	60	1/2"	3/4"	88,0	1,07

Tapón de prueba



Referencia	Ø	Uds. Caja	F (mm)	LF (mm)	L (mm)	D (mm)	Precio (€/ud.)
NTC12	1/2" gas	100	1/2"	18,70	48,0	29,0	1,47
NTC34	3/4" gas	100	3/4"	18,87	48,0	29,0	1,80

Rascador



Referencia	Uds. Caja	Precio (€/ud.)
NRAM1	1	34,83

Herramientas

Rascador giratorio



Referencia	Ø SDR6 – SDR7,4- SDR9 - SDR11	Ø SDR17	Peso (kg)	Uds. Caja	Precio (€/ud.)
RAT1A *	75-200 mm	75-180 mm	2,8	1	A consultar
RAT2A **	200-400 mm	200-400 mm	5,5	1	A consultar

* Rascador con bolsa para transporte (RAT1A)

** Rascador con caja metálica (RAT2A)

Alineador para accesorios electrosoldables



Referencia	Tipo	Ø	Peso (kg)	Uds. Caja	Precio (€/ud.)
99500010	A	20/63 mm	3,0	1	A consultar
99220003	B	63/180 mm	7,5	1	A consultar
99220001	C	125/500 mm	7,5	1	A consultar

Tijeras para tubos

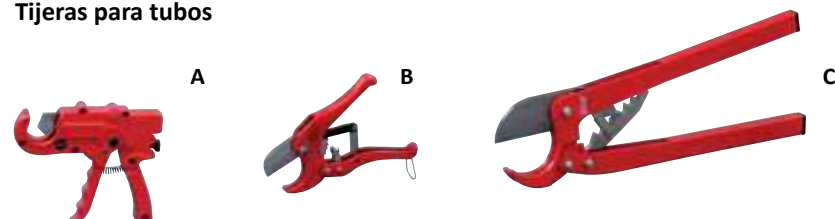

Referencia	Tipo	Ø	Uds. Caja	Precio (€/ud.)
NTTTP	A	16/32 mm	1	76,56
NTTT1	B	16/40 mm	1	58,50
NTTT2	C	16/75 mm	1	293,10
NRLP (Hoja para NTTTP)			1	43,50

Cortatubos telescópico



Referencia	Ø	Uds. Caja	Precio (€/ud.)
70031	6/63 mm	1	A consultar
70032	50/125 mm	1	A consultar
70033	110/160 mm	1	A consultar
055074D (Recambio)	-	1	A consultar

Nivel



Referencia	Uds. Caja	Precio (€/ud.)
NDA	1	39,26



Máquinas

Soldadura termofusión

Soldadura eléctrica

Soldadura a tope

S.A.T. Oficial:



Indice



Máquinas de soldadura por termofusión

Polifusor con maletín y con matrices



Referencia	Voltaje	Ø	Matrices (mm)	Uds. Caja	Precio (€/ud.)
NSBEP	220V	Hasta 63mm	20/25/32	1	633,80
NSBEP63	220V	Hasta 63mm	20/25/32/40/50/63	1	796,52
NSBEP125	220V	Hasta 125mm	75/90/110/125	1	1.589,60

Polifusor con caballete diámetro máximo 63 mm (sin matrices)



Referencia	Voltaje	Ø	Uds. Caja	Precio (€/ud.)
NPCCE	220V	Hasta 63mm	1	422,78

Polifusor con caballete diámetro máximo 125 mm (sin matrices)



Referencia	Voltaje	Ø	Uds. Caja	Precio (€/ud.)
NPCCE125	220V	Hasta 125mm	1	859,54

Soldador polifusor con matrices diámetro máximo 125 mm (matrices incluidas)



Referencia	Voltaje	Ø	Ø Matrices	Uds. Caja	Precio (€/ud.)
NSTL125	220V	25-125 mm	23/32/40/50/63/75/90/110/125	1	A consultar

Indice



Máquinas de soldadura por termofusión

Aproximador



Precio especial Polifusor Ø 125 mm más matrices de 75, 90 y 110 mm con su bolsa de transporte. Solicite precio para el KITNIRON APROXIMADOR.

Referencia	Ø	Uds. Caja	Precio (€/ud.)
94650001	63-125 mm	1	A consultar

Escanea el siguiente código QR y visualiza en el canal YouTube de **italsan** los videos demostrativos de soldadura socket con el aproximador.



Aproximador universal "SPIDER"



Características

- Accionado a mano
- Mecanismo de engranajes no reversibles con auto bloqueo
- Palanca de soporte de dos posiciones
- Liviana y compacta
- Autocentrabre

Referencia	Ø	Recorrido máximo (mm)	Peso máquina completa (kg)	Uds. Caja	Precio (€/ud.)
A467601	63-125 mm	193,0	6,8	1	A consultar

Escanea el siguiente código QR y visualiza en el canal YouTube de **italsan** los videos demostrativos de soldadura socket con el aproximador universal "SPIDER".



Máquinas de soldadura por electrofusión

Máquina de soldar automática polivalente con escáner óptico y sistema Bluetooth integrado



Peso	25,2 kg
Dimensiones	340 x 450 x 220 mm
Potencia máxima absorbida	4.000 VA
Alimentación	230V
Corriente pico	100 A
Corriente soldadura 60% Duty Cycle	73 A
Frecuencia	50 - 60Hz
Temperatura de uso	De -18°C a +55°C
Pantalla	Visor retroiluminado dispuesto en 4 líneas de 20 dígitos
Protección IP	54
Tensión de soldadura	5-42V
Memoria	10.000 ciclos
Diámetros con los que puede trabajar	20 ÷ 630 mm

Referencia	Ø	Uds. Caja	Precio (€/ud.)
E9001E	20-630 mm	1	A consultar

Máquina de soldar automática "ELEKTRA LIGHT"



Peso	7 kg
Dimensiones	200 x 250 x 210 mm
Potencia máxima absorbida	1.300 W
Alimentación	110V o 230V
Corriente pico	60 A
Corriente soldadura 60% Duty Cycle	23 A
Frecuencia	50 - 60Hz
Temperatura de uso	De -10°C a +40°C
Precisión del termómetro	1°C
Protección IP	54
Tensión de soldadura	8-48V
Memoria	325 ciclos
Diámetros con los que puede trabajar	20 ÷ 125/160 * mm

Referencia	Ø	Uds. Caja	Precio (€/ud.)
96906063	20-125/160* mm	1	A consultar

* Es posible soldar el diámetro 160 mm tomando la precaución de esperar el enfriamiento de la máquina, después de cada soldadura.

Máquina de soldar con scanner "ELEKTRA 315"



Peso	16 kg
Dimensiones	263 x 240 x 300 mm
Potencia máxima absorbida	2.600 W
Alimentación	110V o 230V
Corriente pico	100 A
Corriente soldadura 60% Duty Cycle	60 A
Frecuencia	50 - 60Hz
Temperatura de uso	De -10°C a +50°C
Protección IP	54
Tensión de soldadura	8-48V
Memoria	500 ciclos
Diámetros con los que puede trabajar	20 ÷ 315 mm

Referencia	Ø	Uds. Caja	Precio (€/ud.)
96906129	20-315 mm	1	A consultar

Máquinas de soldadura a tope

Máquina de soldar a tope Acrobat 160



Referencia	Voltaje	Ø (mm)	Uds. Caja	Precio (€/ud.)
A714502	240V	63 mm -160 mm	1	A consultar

Máquina de soldar a tope Acrobat 250



Referencia	Voltaje	Ø (mm)	Uds. Caja	Precio (€/ud.)
A2500102	240V	63 mm -250 mm	1	A consultar





Sede Madrid

Coto de Doñana, 21
28320 Pinto - Madrid
Tel: 91 806 07 23

Sede Barcelona

C/ Progrés, 29
Pl. Les Massotes
08850 Gavá - Barcelona
Tel: 93 630 30 40

Atención al cliente:

900 921 957

www.italsan.com



Italsan Customer Service
atencionalcliente@italsan.com

ITALSAN no se responsabiliza de posibles errores que aparezcan en la presente tarifa, y se reserva el derecho de modificar sin previo aviso las características y precios* de los productos.

Para cualquier consulta dirigirse a atencionalcliente@italsan.com

*Precios sin IVA.

Distribuido por:

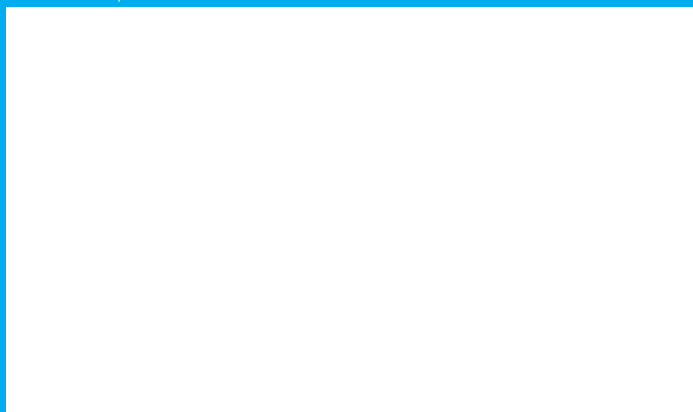

TAR/NIRON/2022/01