

solerbath.

2024

solerbath.

El arte de fluir
The art of flow



Jordi Soler Fornt, CEO

Nuestro padre, Ramón Soler Roger, nos enseñó a mis hermanos y a mí a pensar en el diseño como la herramienta con la que hacer realidad productos que generen experiencias sensoriales y mejoren la calidad de vida de las personas. Por eso, **solerbath** tiene alma industrial, pero también humana. Un saber hacer enfocado en integrar la sostenibilidad, la innovación y la alta tecnología tanto en la ingeniería de procesos como en el producto final.

Fruto de la ilusión y dedicación de los años hemos hecho evidente nuestro empeño y decidida aportación a la sociedad a través de innovaciones que solucionan problemáticas reales. Desde la medalla de Oro en la Exposición Universal de Barcelona en 1929 hasta los German Design Awards, Red Dot e IF Design Award, 7 reconocimientos internacionales en los últimos 4 años.

“Según Leonardo Da Vinci la belleza reside en la simetría y las proporciones perfectas, como las que se encuentran en la naturaleza. Siguiendo el mismo propósito que Da Vinci, conseguimos encontrar la perfecta armonía en nuestros productos”.

Jordi Soler Fornt, CEO

Our father, Ramón Soler Roger, taught my siblings and I to think of design as a tool with which to make real products that generate sensory experiences and improve the quality of life of people.

For that reason, **solerbath** has an industrial, but also a human soul. Know-how that is focused on integrating sustainability, innovation and high technology in both process engineering and in the finished product.

As the result of the illusion and dedication of many years, we have shown our enterprise and firm contribution to society through innovation that solves real problems. From the Gold Medal of the Barcelona Universal Exhibition in 1929 until the German Design Awards, Red Dot, and IF Design, 7 awards in the last 4 years. “According to Leonardo Da Vinci, beauty lies in symmetry and perfect proportions, such as those found in nature. True to the same purpose as Da Vinci, we have managed to find perfect aesthetic harmony in our products.”



COLLECTIONS

INODOROS & BIDÉS TOILETS & BIDETS	Aquitania	8
	Alma	18
	Doria	30

LAVABOS WASHBASINS	Kendra	42
	Kaiser	52

INNOVTECH

Breamers	64
Sistemas de instalación Installation systems	66
Recambios Spare parts	74



INODOROS & BIDÉS
TOILETS & BIDETS







AQUITANIA

Es para quienes buscan diseños en armonía, una combinación de volúmenes en formas redondeadas ideales para combinar con el resto de los elementos del baño. AQUITANIA representa la fusión perfecta entre diseño moderno y funcionalidad excepcional. Abarca inodoros y bidés que no solo cumplen con las necesidades esenciales del cuarto de baño, sino que también añaden un toque estético contemporáneo.

It is for those who are looking for harmonious designs, a combination of volumes in rounded shapes ideal for combining with the rest of the bathroom elements. Aquitania represents the perfect fusion of modern design and exceptional functionality. It encompasses toilets and bidets that not only meet the essential needs of the bathroom, but also add a contemporary aesthetic touch.



Con líneas limpias y estilizadas, AQUITANIA se integra armoniosamente en cualquier tipo de baño. Esta colección se ofrece en tres inodoros fundamentales: inodoro de tanque bajo, inodoro suspendido e inodoro empotrable. Todos ellos destacan por ser compactos, rimless y por su tapa amortiguada con clip off. Además, el inodoro a suelo presenta una salida dual. Todos ellos creados con materiales de calidad e innovadores sistemas funcionales para una mejor experiencia de usuario.

With its clean, streamlined lines, AQUITANIA blends harmoniously into any type of bathroom. This collection is available in three basic types of toilet: complete WC, wall-hung toilet and back-to-wall toilet. All of them stand out for their compact, rimless design and their cushioned lid with clip off. In addition, the floor-standing toilet has a dual outlet. All of them created with quality materials and innovative functional systems for a better user experience.

AQUITANIA



Inodoros Toilets



Inodoro completo de tanque bajo

Adosado a la pared y alimentación inferior/superior. Rimless, doble descarga 3/4,5 litros, tapa caída amortiguada y Clip Off.

460 mm de longitud.

Incluye: taza, tanque, asiento y tapa.

WC complete with down/up water inlet

Back to wall cistern. Rimless, double discharge 3/4,5 liters, soft-closing & Clip Off sit and cover.

460 mm length.

Including: WC bowl, cistern, sit and cover.

**Alimentación inferior
Down water inlet**

S27A308745



**Alimentación superior
Up water inlet**

S27A309389



Rimless



3/4,5 l



Clip Off



Softclose



Confort
Comfort



Antibacteriano
Antibacterial



Dual



Fijaciones
Fixings



Bilateral cisterna
Bilateral cistern

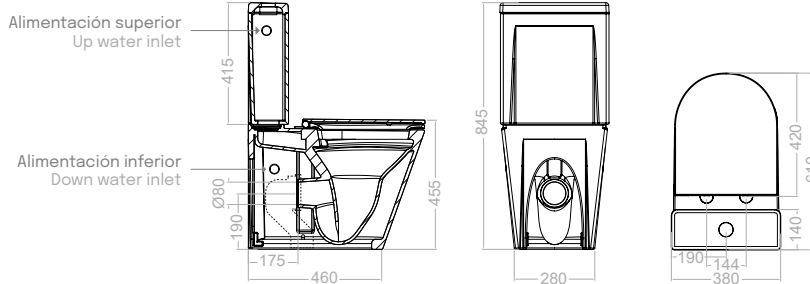

Compuesto por Including

Taza salida dual con juego de fijación, codo de evacuación y sistema Rimless.	S27R308711
WC-bowl with dual outlet and fixation kit, connection elbow and Rimless system.	
Tanque de alimentación inferior completo para la referencia S27A308745.	S27R308709
WC cistern with down water inlet for reference S27A308745.	
Tanque de alimentación superior completo para la referencia S27A309389.	S27R309388
WC cistern with up water inlet for reference S27A309389.	
Asiento y tapa amortiguada, bisagras y sistema Clip Off.	S27R308710
Soft-closing sit and cover, with hinges and Clip Off system.	

**Inodoro suspendido****S27A308746**

Salida horizontal, Rimless, tapa amortiguada y sistema Clip Off.

402 mm de longitud.

Incluye: taza, asiento y tapa.**Wall-hung WC**

Wall outlet, Rimless, soft-closing & Clip Off sit and cover.

402 mm length.

Including: WC bowl, sit and cover.

Rimless



Clip Off

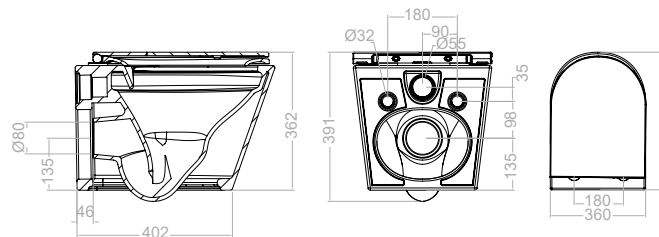

Softclose

Confort
ComfortAntibacteriano
Antibacterial

Compuesto por Including

Taza con juego de fijación y sistema Rimless.

S27R308712

WC-bowl with fixation kit and Rimless system.

Asiento y tapa amortiguada, bisagras y sistema Clip Off.

S27R308722

Soft-closing sit and cover with hinges and Clip Off system.



Inodoro adosado a pared

S27A308742

Tanque empotrable con tapa amortiguada y Clip Off. Sistema Rimless.

415 mm de longitud.

Incluye: taza, asiento y tapa.

Back to wall WC

Soft-closing & and Clip Off sit and cover. Rimless.

415 mm length.

Including: WC bowl, sit and cover.

- Rimless 

- Clip Off 

- Softclose 

- Confort Comfort 

- Antibacteriano Antibacterial 

- Fijaciones Fixings 

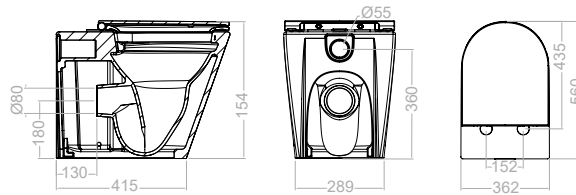

Compuesto por Including

Taza con juego de fijación y sistema Rimless.

S27R308713

WC-bowl with fixation kit and Rimless system.

Asiento y tapa amortiguada, bisagras de acero inoxidable y sistema Clip Off.

S27R308723

Soft-closing sit and cover, with hinges and Clip Off system.

**Bidé adosado a pared****S27B307898**

Con un orificio para grifería y con juego de fijación oculta.

425 mm de longitud.

Wall to back bidet

With mixer hole and fixation kit.

425 mm length.

Antibacteriano
Antibacterial

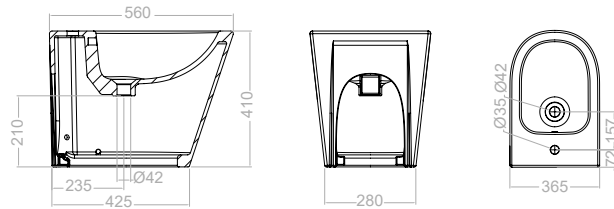

Fijaciones
Fixings

**Bidé suspendido****S27B307915**

Con un orificio para grifería y con juego de fijación oculta.

350 mm de longitud.

Wall-hung bidet

With mixer hole and fixation kit.

350 mm length.

Antibacteriano
Antibacterial



Fijaciones
Fixings

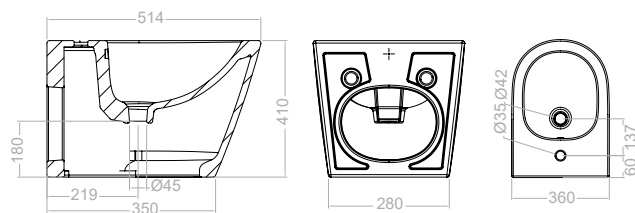









ALMA

Los baños más vanguardistas se visten con ALMA, una colección de geometría depurada, que da lugar a líneas equilibradas que transforman los baños en espacios elegantes y armoniosos. Esta colección de Solerbath es la elección perfecta para aquellos que desean convertir su baño en un oasis de bienestar y confort, donde el arte del diseño se encuentra con la funcionalidad y la vanguardia.

The most avant-garde bathrooms are dressed up with ALMA, a collection of refined geometry, which gives rise to balanced lines that transform bathrooms into elegant and harmonious spaces. This Solerbath collection is the perfect choice for those who wish to turn their bathroom into an oasis of well-being and comfort, where the art of design meets functionality and avant-garde.

Esta colección exclusiva ofrece una variedad de opciones para satisfacer todas las necesidades y preferencias, con tres inodoros compactos excepcionales: el inodoro de tanque bajo, el inodoro suspendido y el inodoro empotrable. Todos ellos cuentan con una tapa amortiguada con sistema clip off, brindando la comodidad de una apertura y cierre suave y seguro. Además, destacamos la presencia del mecanismo de doble descarga en los productos de la colección ALMA. Esta característica asegura un uso eficiente del agua sin sacrificar funcionalidad.

This exclusive collection offers a variety of options to suit all needs and preferences, with three exceptional compact toilets: complete WC, wall-hung toilet and back-to-wall toilet. All of them feature a cushioned lid with clip off system, providing the convenience of smooth and safe opening and closing. In addition, we highlight the presence of the dual flush mechanism in the products of the ALMA collection. This feature ensures efficient water use without sacrificing functionality.



A L M A





A L M A



En la actualidad, la preocupación por la higiene y la salud se erige como un factor primordial. En este contexto, los inodoros ALMA destacan al ser fabricados mediante cerámica antibacteriana. Este atributo no solamente garantiza una durabilidad y resistencia superiores, sino que además actúa como barrera contra la proliferación de gérmenes y bacterias, creando así un entorno más saludable y seguro para todos los miembros de la familia.

In today's world, hygiene and health concerns are of paramount importance. In this context, ALMA toilets stand out because they are made of antibacterial ceramic. This attribute not only guarantees superior durability and resistance, but also acts as a barrier against the proliferation of germs and bacteria, thus creating a healthier and safer environment for all members of the family.

Inodoros Toilets



Inodoro completo de tanque bajo

Adosado a la pared y alimentación inferior/superior. Rimless, doble descarga 3/4,5 litros, tapa caída amortiguada y Clip Off.

535 mm de longitud.

Incluye: taza, tanque, asiento y tapa.

WC complete with down/up water inlet

Back to wall cistern. Rimless, double discharge 3/4,5 liters, soft-closing & Clip Off sit and cover.

535 mm length.

Including: WC bowl, cistern, sit and cover.

**Alimentación inferior
Down water inlet**

S28A308743



**Alimentación superior
Up water inlet**

S28A309503



Rimless



3/4,5 l



Clip Off



Softclose



Confort
Comfort



Antibacteriano
Antibacterial



Dual



Fijaciones
Fixings



Bilateral cisterna
Bilateral cistern

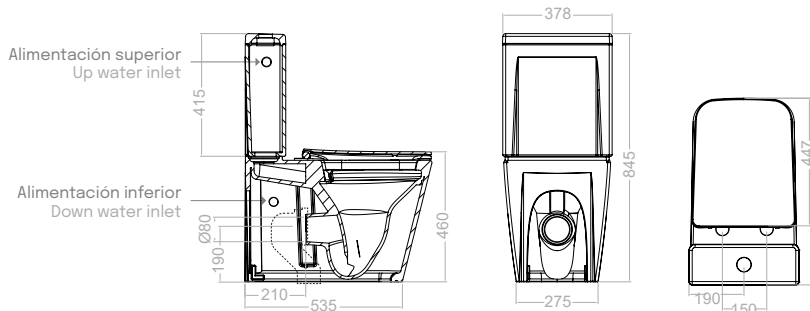

Compuesto por Including

Taza salida dual con juego de fijación, codo de evacuación y sistema Rimless.	S28R308716
WC-bowl with dual outlet and fixation kit, connection elbow and Rimless system.	
Tanque de alimentación inferior completo para la referencia S28A308743.	S27R308709
WC cistern with down water inlet for reference S28A308743.	
Tanque de alimentación superior completo para la referencia S28A309503.	S27R309388
WC cistern with up water inlet for reference S28A309503.	
Asiento y tapa amortiguada, bisagras y sistema Clip Off.	S28R308715
Soft-closing sit and cover, with hinges and Clip Off system.	

**Inodoro suspendido****S28A308744**

Salida horizontal, Rimless, tapa amortiguada y sistema Clip Off.

445 mm de longitud.

Incluye: taza, asiento y tapa.

Wall-hung WC

Wall outlet, Rimless, soft-closing & Clip Off sit and cover.

445 mm length.

Including: WC bowl, sit and cover.

Rimless



Clip Off

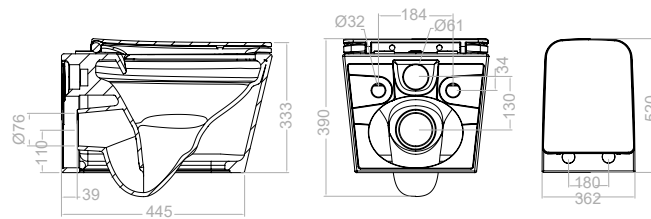

Softclose

Confort
ComfortAntibacteriano
Antibacterial

Compuesto por Including

Taza con juego de fijación y sistema Rimless.

S28R308717

WC-bowl with fixation kit and Rimless system.

Asiento y tapa amortiguada, bisagras y sistema Clip Off.

S28R308724

Soft-closing sit and cover with hinges and Clip Off system.

Inodoros Toilets

**Inodoro adosado a pared****S28A308747**

Tanque empotrable con tapa amortiguada y Clip Off. Sistema Rimless.

430 mm de longitud.

Incluye: taza, asiento y tapa.

Back to wall WC

Soft-closing & and Clip Off sit and cover. Rimless.

430 mm length.

Including: WC bowl, sit and cover.

Rimless



Clip Off

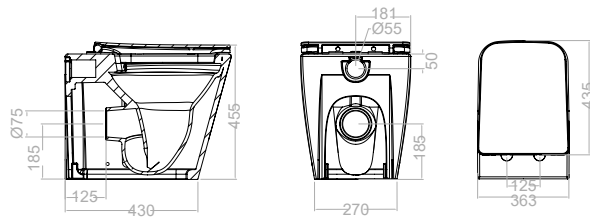

Softclose

Confort
ComfortAntibacteriano
AntibacterialFijaciones
Fixings

Compuesto por Including

Taza con juego de fijación y sistema Rimless.

S28R308718

WC-bowl with fixation kit and Rimless system.

Asiento y tapa amortiguada, bisagras de acero inoxidable y sistema Clip Off.

S28R308715

Soft-closing sit and cover, with hinges and Clip Off system.

Bidés Bidets

**Bidé adosado a pared****S28B307920**

Con un orificio para grifería y con juego de fijación oculta.

430 mm de longitud.

Wall to back bidet

With mixer hole and fixation kit.

430 mm length.

Antibacteriano
Antibacterial

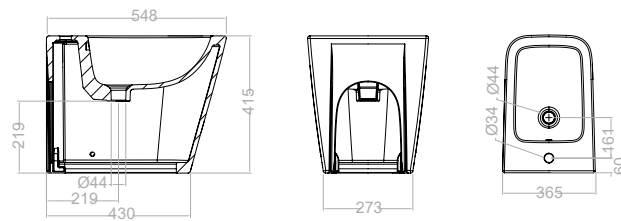

Fijaciones
Fixings

**Bidé suspendido****S28B307922**

Con un orificio para grifería y con juego de fijación oculta.

440 mm de longitud.

Wall-hung bidet

With mixer hole and fixation kit.

440 mm length.

Antibacteriano
Antibacterial



Fijaciones
Fixings

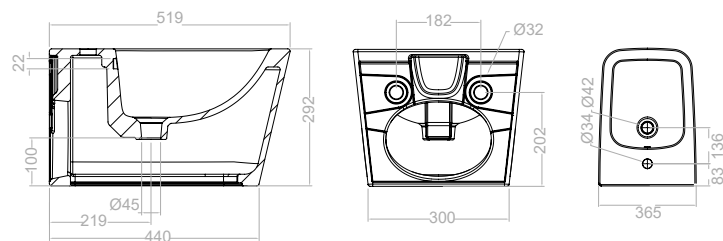



S28A308743



S28B307920



S28A308744







DORIA

Encarna la excelencia en diseño funcional y comodidad para el usuario contemporáneo. Diseñada con un enfoque claro en brindar una experiencia óptima en el baño, esta serie ofrece inodoros y bidés modernos que fusionan un estilo elegante con funcionalidades innovadoras. Están diseñados para ser fácilmente accesibles y de uso intuitivo, atendiendo a las necesidades de los usuarios más exigentes.

DORIA embodies excellence in functional design and comfort for the contemporary user. Designed with a clear focus on providing an optimal bathroom experience, this series offers modern toilets and bidets that fuse elegant styling with innovative functionalities. They are designed to be easily accessible and intuitive to use, catering to the needs of the most demanding users.

El estilo refinado de Doria se manifiesta en líneas suaves y formas armoniosas que añaden un toque de sofisticación a cualquier espacio de baño. Además, su enfoque innovador hacia la funcionalidad no solo satisface las expectativas estéticas, sino que también ofrece una comodidad diaria, gracias a sistemas de descarga eficientes, tecnología anti-salpicaduras y asientos ergonómicos que elevan la funcionalidad de estos elementos a un nuevo nivel.

Doria's refined style manifests itself in smooth lines and harmonious shapes that add a touch of sophistication to any bathroom space. Moreover, its innovative approach to functionality not only meets aesthetic expectations, but also offers everyday comfort, thanks to efficient flushing systems, anti-splash technology and ergonomic seats that take the functionality of these elements to a new level.



D O R I A



Inodoros Toilets

**Inodoro completo de tanque bajo****S29A307917**

Adosado a la pared y alimentación inferior. Rimless, doble descarga 3/4,5 litros, tapa caída amortiguada y Clip Off.

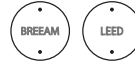

628 mm de longitud.

Incluye: taza, tanque, asiento y tapa.

WC complete with down water inlet

Back to wall cistern. Rimless, double discharge 3/4,5 liters, soft-closing & Clip Off sit and cover.

628 mm length.

Including: WC bowl, cistern, sit and cover.

Rimless



3/4,5 l



Clip Off



Softclose

Confort
ComfortAntibacteriano
Antibacterial

Dual

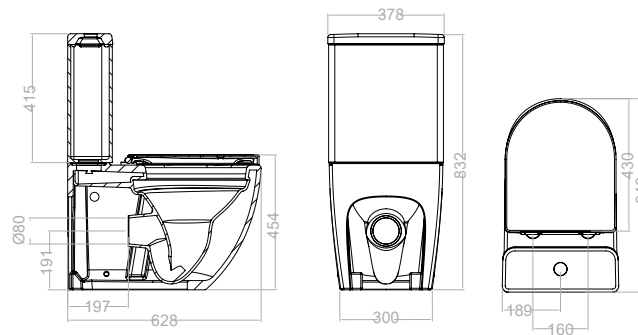
Fijaciones
FixingsBilateral cisterna
Bilateral cistern

Compuesto por Including

Taza salida dual con juego de fijación, codo de evacuación y sistema Rimless.

S29R308813

WC-bowl with dual outlet and fixation kit, connection elbow and Rimless system.

Tanque de alimentación inferior completo con juego de mecanismos de doble descarga 3/4,5 litros.

S29R308811

WC cistern with down water inlet with double discharge kit 3/4,5 liters.

Asiento y tapa amortiguada, bisagras y sistema Clip Off.

S29R308812

Soft-closing sit and cover, with hinges and Clip Off system.

**Inodoro suspendido****S29A307918**

Salida horizontal, Rimless, tapa amortiguada y sistema Clip Off.

335 mm de longitud.

Incluye: taza, asiento y tapa.

Wall-hung WC

Wall outlet, Rimless, soft-closing & Clip Off sit and cover.

335 mm length.

Including: WC bowl, sit and cover.

Rimless



Clip Off

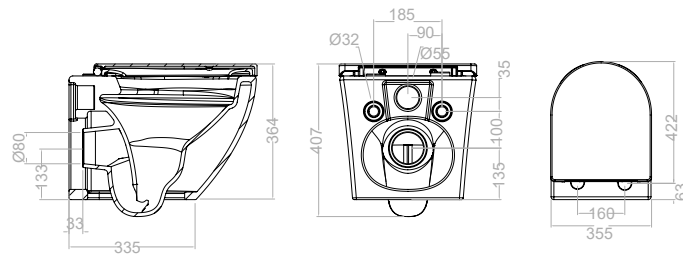

Softclose

Confort
ComfortAntibacteriano
Antibacterial

Compuesto por Including

Taza con juego de fijación y sistema Rimless.

S29R308814

WC-bowl with fixation kit and Rimless system.

Asiento y tapa amortiguada, bisagras y sistema Clip Off.

S29R308812

Soft-closing sit and cover with hinges and Clip Off system.

Inodoros Toilets

**Inodoro adosado a pared****S29A308815**

Tanque empotrable con tapa amortiguada y Clip Off. Sistema Rimless.

374 mm de longitud.

Incluye: taza, asiento y tapa.

Back to wall WC

Soft-closing & and Clip Off sit and cover. Rimless.

374 mm length.

Including: WC bowl, sit and cover.

Rimless



Clip Off

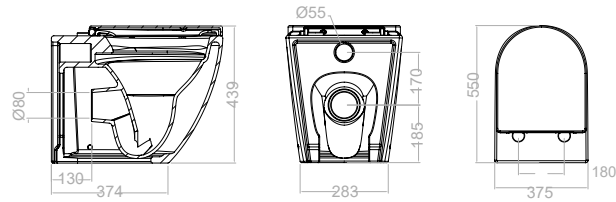

Softclose

Confort
ComfortAntibacteriano
AntibacterialFijaciones
Fixings

Compuesto por Including

Taza con juego de fijación y sistema Rimless.

S29R308816

WC-bowl with fixation kit and Rimless system.

Asiento y tapa amortiguada, bisagras de acero inoxidable y sistema Clip Off.

S29R309455

Soft-closing sit and cover, with hinges and Clip Off system.

Bidés Bidets

**Bidé adosado a pared****S29B308817**

Con un orificio para grifería y con juego de fijación oculta.

376 mm de longitud.

Wall to back bidet

With mixer hole and fixation kit.

376 mm length.

Antibacteriano
Antibacterial

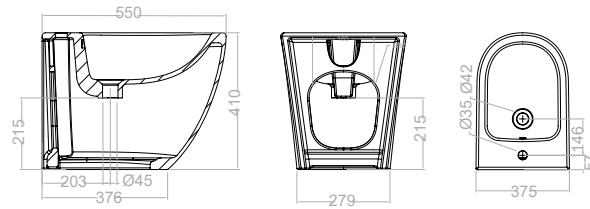

Fijaciones
Fixings

**Bidé suspendido****S29B307919**

Con un orificio para grifería y con juego de fijación oculta.

350 mm de longitud.

Wall-hung bidet

With mixer hole and fixation kit.

350 mm length.

Antibacteriano
Antibacterial



Fijaciones
Fixings

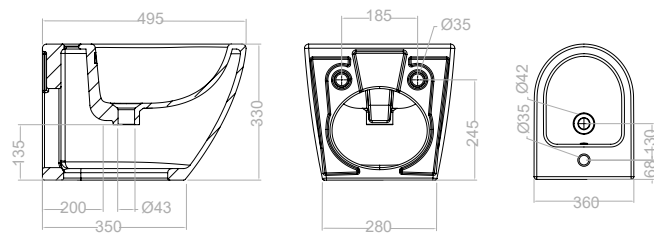



S29B307919



S29B308817



S29A307917





LAVABOS WASHBASINS







K E N D R A

Despliega toda su elegancia natural en los espacios de baño, con un diseño sinuoso de líneas depuradas y formas orgánicas. Los lavabos kendra están formados por una sola pieza de líneas curvas. Esta serie ofrece cuatro tipos de lavabos: uno de ellos es circular, el otro es ovalado y los otros dos lavabos tienen una combinación de líneas curvas y rectas, e incluyen un agujero para instalar el grifo.

It unfolds all its natural elegance in bathroom spaces, with a sinuous design of refined lines and organic shapes. The Kendra washbasins are made up of a single piece with curved lines. This series offers four types of washbasins: one of them is circular, the other is oval and the other two washbasins have a combination of curved and straight lines, and include a hole to install the tap.

En la línea de las virtudes que caracterizan los productos Solerbath, los lavabos de la colección KENDRA funcionan a la perfección en proyectos de interiorismo, por su diseño moderno y actual y sus especificaciones técnicas. La durabilidad, la facilidad de limpieza y de mantenimiento, así como la versatilidad en el diseño y la estética, son características indispensables para proyectos Contract y hoteleros.

In line with the virtues that characterise Solerbath products, the washbasins of the KENDRA collection work perfectly in interior design projects, thanks to their modern and contemporary design and technical specifications. Durability, ease of cleaning and maintenance, as well as versatility in design and aesthetics, are indispensable features for contract and hotel projects.

K E N D R A





K E N D R A

S31L307900



Lavabo sin orificio Washbasin without mixer hole

**Lavabo blanco redondo****S31L307925**Antibacteriano
Antibacterial

De sobre encimera. Sin rebosadero y sin orificio de grifería.

282 mm de longitud

White round washbasin

Over countertop. Without overflow and without mixer hole.

282 mm length

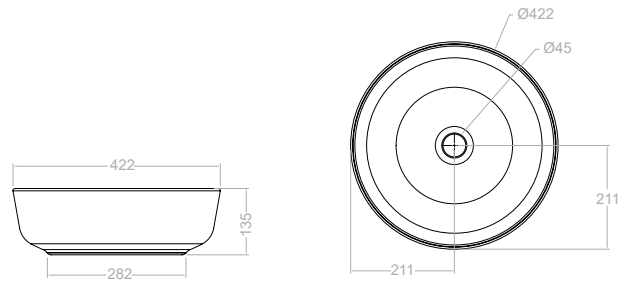
**Lavabo blanco ovalado****S31L307900**Antibacteriano
Antibacterial

De sobre encimera. Sin rebosadero y sin orificio de grifería.

480 mm de longitud

White oval washbasin

Over countertop. Without overflow and without mixer hole.

480 mm length

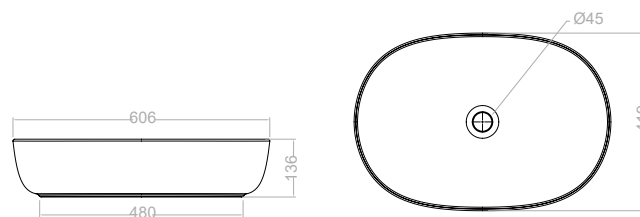

Lavabo con orificio Washbasin with mixer hole

**Lavabo blanco ovalado****S31L307928**

De sobre encimera. Sin rebosadero y con orificio de grifería.

363 mm de longitud

White oval washbasin

Over countertop. Without overflow and with mixer hole.

363 mm length

Antibacteriano
Antibacterial

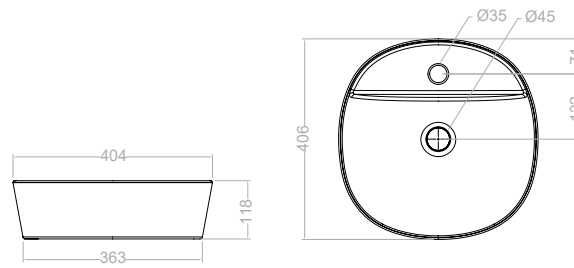
**Lavabo blanco ovalado alargado****S31L307929**

De sobre encimera. Sin rebosadero y con orificio de grifería.

464 mm de longitud

White long oval washbasin

Over countertop. Without overflow and with mixer hole.

464 mm length

Antibacteriano
Antibacterial

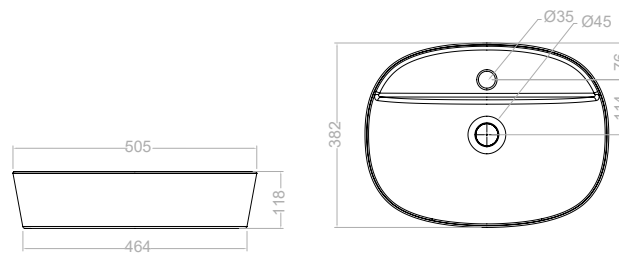



S31L307900



S31L307900



S31L307900







K A I S E R

Con diferentes modelos de lavabos de sobre encimera, KAISER se caracteriza por su estética elegante, adaptable a cualquier estilo. Sus dimensiones y características son idóneas para combinar con los muebles de lavabo más actuales y las últimas tendencias en espacios de baño, desde la más minimalista hasta la más sofisticada.

With different washbasin models over countertop, KAISER is characterised by its elegant aesthetics, adaptable to any style. Its dimensions and characteristics are ideal for combining with the most up-to-date washbasin furniture and the latest trends in bathroom spaces, from the most minimalist to the most baroque.

La colección de lavabos KAISER presenta un diseño de líneas rectas, perfectamente unidas por esquinas de ángulos redondeados. Una sola pieza, que presenta suavidad y continuidad en sus formas. Cada curva y ángulo ha sido meticulosamente concebido para crear una sensación de unidad en el diseño. Los bordes suaves y redondeados no solo añaden elegancia, sino que también contribuyen a la seguridad y la comodidad del usuario.

The KAISER washbasin collection presents a design of straight lines, perfectly joined by rounded corners. A single piece, which presents smoothness and continuity in its forms. Every curve and angle have been meticulously conceived to create a sense of unity in the design. The soft, rounded edges not only add elegance, but also contribute to the safety and comfort of the user.







Además de su exquisito diseño, los lavabos de la colección KAISER también incorporan funcionalidades avanzadas que se alinean con las expectativas contemporáneas. La ergonomía se ha tenido en cuenta para garantizar la comodidad en cada uso, y la selección de materiales de alta calidad garantiza la durabilidad y la resistencia a lo largo del tiempo. Cuenta, además, con dos modos de instalación para lavabos con alojamiento de grifo. El montaje del lavabo es posible sobre encimera o suspendido, con sujeción a la pared.

In addition to their exquisite design, the washbasins in the KAISER collection also incorporate advanced functionalities that are in line with contemporary expectations. Ergonomics have been taken into account to ensure comfort in every use, and the selection of high-quality materials guarantees durability and resistance over time. It also has two installation modes for washbasins with tap housing. The washbasin can be mounted on a countertop or wall-hung.

Lavabo sin orificio Washbasin without mixer hole

**Lavabo blanco cuadrado****S30L307926**

De sobre encimera. Sin rebosadero y sin orificio de grifería.

369 mm de longitud

White square washbasin

Over countertop. Without overflow and without mixer hole.

369 mm length

Antibacteriano
Antibacterial

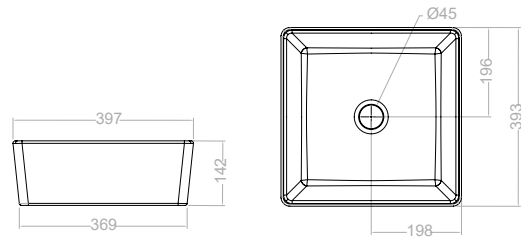
**Lavabo blanco rectangular****S30L307927**

De sobre encimera. Sin rebosadero y sin orificio de grifería.

601 mm de longitud

White rectangular washbasin

Over countertop. Without overflow and without mixer hole.

601 mm length

Antibacteriano
Antibacterial

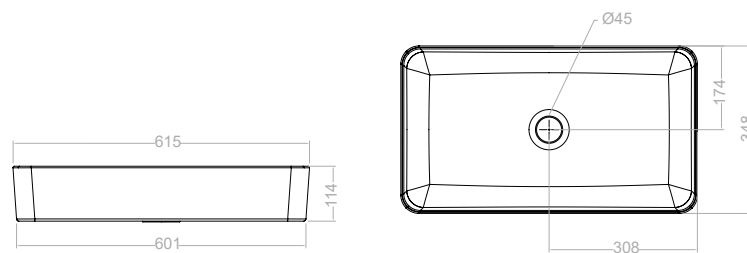

Lavabo con orificio Washbasin with mixer hole

**Lavabo blanco cuadrado****S30L307896**

Con dos posibles instalaciones: Mural y Sobre encimera. Con rebosadero y con orificio de grifería.

420 mm de longitud

White square washbasin

2 possible installations: over counter top or wall-hung. With overflow and mixer hole.

420 mm length

Antibacteriano
Antibacterial

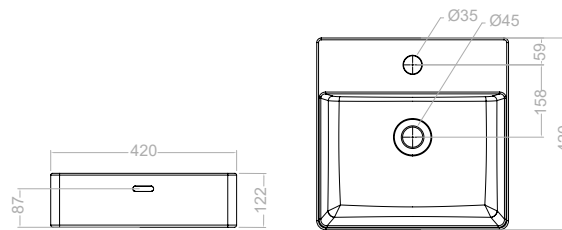

Dual

**Lavabo blanco rectangular****S30L307895**

Con dos posibles instalaciones: Mural y Sobre encimera. Sin rebosadero y con orificio de grifería.

614 mm de longitud

White rectangular washbasin

2 possible installations: over countertop or wall-hung. With overflow and mixer hole

614 mm length

Antibacteriano
Antibacterial



Dual

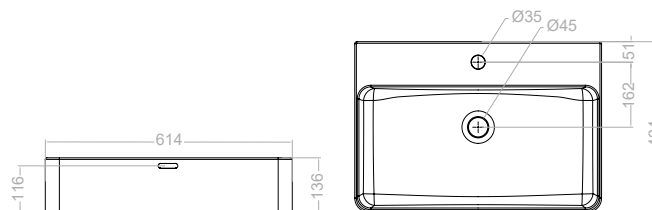



S30L307896



S30L307926



S30L307926





INNOVTECH

INNOVATION & TECHNOLOGY





BREEAMers



Nuestros productos para el cuidado sanitario han sido concebidos para cumplir con las certificaciones ambientales de edificios BREEAM y LEED. Enfocados en el manejo eficiente del agua, estos productos aportan un valor sostenible a las edificaciones actuales.

En particular, nuestros inodoros integran tecnología avanzada que nos permite regular los mecanismos de descarga para adecuarlos al ahorro de agua necesario, ofreciendo opciones de diferentes litros, y así poder adecuarlos al nivel de exigencia requerido por el proyecto.

De manera estandarizada todos nuestros mecanismos están configurados a 3/4,5 litros, caudal suficiente para disponer de un confort adecuado, y a la vez cumpliendo con el nivel 4 sobre 5 que Breeam marca, al igual que las exigencias LEED. Sin embargo, si se requiere el 5° nivel Excelence de BREEAM nuestra descarga puede regularse a 2'5/4 litros.

Esta innovación representa nuestro firme compromiso con la sostenibilidad y la eficiencia en el uso del agua en el diseño de nuestros productos.

Our sanitary care products are designed to meet BREEAM and LEED environmental building certifications.

With a focus on efficient water management, these products bring sustainable value to today's buildings.

In particular, our toilets integrate advanced technology that allows us to regulate the flushing mechanisms to suit the water savings required, offering different litre options to suit the level of demand required by the project.

As standard, all our mechanisms are set at 3/4.5 litres, which is sufficient flow to provide adequate comfort, and at the same time comply with Breeam's level 4 out of 5, as well as LEED requirements.

However, if BREEAM Excelence level is required, our discharge can be adjusted to 2.5/4 litres. This innovation represents our strong commitment to sustainability and water efficiency in the design of our products.

SISTEMA RIMLESS RIMLESS SYSTEM



El sistema que facilita la limpieza de la taza y maximiza su higiene. Inodoros con sistema higiénico de descarga de agua. Su diseño sin bordes, depurado y uniforme, facilita la limpieza y evita la proliferación de bacterias. Gracias a la eliminación de formas y ángulos en el interior de la taza, el agua circula de forma homogénea, permitiendo una limpieza y desinfección por toda la superficie del interior del inodoro, de forma completa y controlada, sin salpicaduras.

The system that facilitates bowl cleaning and maximizes hygiene. Toilets with hygienic flushing system. Its rimless, purified and uniform design facilitates cleaning and prevents the proliferation of bacteria. Thanks to the elimination of shapes and angles inside the bowl, the water circulates homogeneously, allowing cleaning and disinfection over the entire surface of the inside of the toilet, in a complete and controlled manner, without splashing.

CERÁMICA ANTIBACTERIANO ANTIBACTERIAL CERAMIC



La cerámica es el material higiénico por excelencia, gracias a su duradero esmalte superficial que evita la absorción de agua y la proliferación de humedad y bacterias. Su precisa fórmula a base de minerales como arcilla, caolín, feldespato y cuarzo dan como resultado una increíble consistencia que confirma su durabilidad en el tiempo. Además, el exclusivo acabado cerámico asegura la resistencia a los productos de limpieza abrasivos, las altas temperaturas y la luz ultravioleta, manteniendo su brillo original ofreciendo un alto rendimiento en todo momento.

Ceramic is the hygienic material par excellence, thanks to its durable surface glaze that prevents water absorption and the proliferation of moisture and bacteria. Its precise formula based on minerals such as clay, kaolin, feldspar and quartz results in an incredible consistency that confirms its durability over time. In addition, the exclusive ceramic finishing ensures resistance to abrasive cleaning products, high temperatures and ultraviolet light, maintaining its original shine and offering high performance at all times.

3/4,5 L MECANISMO DESCARGA 3/4,5 L DISCHARGE MECHANISM



Los inodoros ofrecen una avanzada tecnología que incorpora un dispositivo de ahorro de agua configurados para elegir entre 3 litros de descarga pequeña, o 4,5 litros de descarga grande. Igualmente, el usuario puede regular estos mecanismos de descarga para adecuarlos al ahorro de agua necesario, ofreciendo diferentes opciones de litros. Esta característica innovadora representa un compromiso con la sostenibilidad y la eficiencia hídrica en el diseño de los inodoros. El dispositivo de doble descarga proporciona la flexibilidad de elegir la cantidad de agua utilizada en función de las necesidades, permitiendo un uso más responsable de este recurso vital.

The toilets offer advanced technology that incorporates a water-saving device configured to choose between 3 litres of small flush, or 4.5 litres of large flush. Similarly, the user can regulate these flush mechanisms to suit the water savings required, offering different litre options. This innovative feature represents a commitment to sustainability and water efficiency in toilet design. The dual flush device provides the flexibility to choose the amount of water used according to need, allowing for a more responsible use of this vital resource.

BREEAM/LEED



Nuestros productos sanitarios cumplen con certificaciones BREEAM y LEED. Centrados en el ahorro de agua, los inodoros cuentan con tecnología avanzada para ajustar los litros de descarga según el usuario o proyecto. Están configurados de manera estándar a 3/4,5 litros, que cumple el nivel 4 sobre 5 de BREEAM y LEED. Aunque la descarga también se puede regular a 2'5/4 litros para obtener el 5° nivel Excellence BREEAM. Es nuestra apuesta por la sostenibilidad y eficiencia en el uso del agua.

Our sanitary products comply with BREEAM and LEED certifications. With a focus on water savings, the toilets feature advanced technology to adjust flush litres according to the user or project. They are set as standard at 3/4.5 litres, which meets BREEAM and LEED level 4 out of 5. However, the flush can also be adjusted to 2.5/4 litres to achieve BREEAM Excellence level. This is our commitment to sustainability and water efficiency.



solerbath.

SISTEMA CLIP OFF CLIP OFF SYSTEM



Cómoda limpieza e higiene gracias al sistema Clip Off, con el que es posible desmontar la tapa y asiento del inodoro fácilmente, sin necesidad de usar herramientas. El sistema Clip Off, permite una completa limpieza y desinfección de ambos elementos del inodoro. Con la incorporación de bisagras de acero inoxidable, el sistema aporta un mecanismo confiable para un montaje y desmontaje sin complicaciones. Las bisagras de acero inoxidable brindan una mayor vida útil al inodoro, minimizando el desgaste y asegurando una experiencia de uso más duradera y de calidad.

Convenient cleaning and hygiene thanks to the Clip Off system, which makes it possible to remove the toilet seat and lid easily, without the need for tools. The Clip Off system allows complete cleaning and disinfection of both elements of the toilet. With the incorporation of stainless steel hinges, the system provides a reliable mechanism for hassle-free assembly and disassembly. The stainless steel hinges give the toilet a longer service life, minimising wear and tear and ensuring a longer lasting, quality user experience.

CIERRE AMORTIGUADO/SOFTCLOSE CLOSING SYSTEM/SOFTCLOSE



El sistema de cierre amortiguado garantiza una caída y cierre de la tapa del inodoro suave y sin ruidos. Su diseño incorpora bisagras de máxima resistencia con amortiguación, para un cierre controlado, evitando molestos golpes, roturas y accidentes.

The cushioned closing system ensures that the toilet lid falls and closes smoothly and quietly. Its design incorporates maximum resistance hinges with cushioning, for a controlled closing, avoiding annoying knocks, breakages and accidents.

ASIENTO CONFORT CONFORT SEAT



El asiento se distingue por proporcionar una superficie de apoyo amplia y sumamente confortable. Este diseño específico se enfoca en maximizar la comodidad del usuario al ofrecer una superficie ancha que se adapta ergonómicamente a la morfología corporal. Asegura resistencia y facilidad de limpieza, cumpliendo con los estándares de higiene y funcionalidad requeridos para una experiencia óptima en el uso diario del inodoro.

The seat distinguishes itself by providing a wide and extremely comfortable support surface. This specific design focuses on maximizing user comfort by offering a wide surface that ergonomically adapts to body morphology. It ensures resistance and ease of cleaning, meeting the hygiene and functionality standards required for an optimal daily toilet experience.



FIJACIONES OCULTAS HIDDEN FIXING SYSTEMS



El sistema de fijación oculta para inodoros y bidés es una solución innovadora que combina funcionalidad, estabilidad y estética en el diseño de los baños. Esta tecnología de montaje permite instalar de manera discreta y segura los inodoros y bidés, sin tornillos visibles ni elementos que interrumpen la superficie exterior. No solo mejora la presentación visual del baño, sino que también responde a la búsqueda de un diseño limpio, práctico y elegante en el hogar.

The fixing system for toilets and bidets is an innovative solution that combines functionality, stability and aesthetics in bathroom design. This mounting technology allows toilets and bidets to be installed discreetly and securely, without visible screws or elements that interrupt the external surface. It not only improves the visual presentation of the bathroom, but also responds to the search for a clean, practical and elegant design in the home.

CISTERNA BILATERAL BILATERAL INLET CISTERN



Fácil y óptima instalación. Cisterna con entrada bilateral inferior. La entrada del agua se produce desde el inferior del inodoro y puede instalarse a la derecha o a la izquierda, según las necesidades de cada instalación.

Easy and optimal installation. Cistern with bilateral bottom inlet. The water inlet is from the bottom of the toilet and can be installed on the right or on the left, depending on the needs of each installation.

INSTALACIÓN SALIDA DUAL DUAL OUTPUT INSTALLATION



Fácil y óptima instalación. Salida universal para conexión dual (horizontal y vertical). Enlace incluido. La instalación del inodoro es posible de forma dual, para una descarga del agua en ambos modos: Horizontal, con sifón recto interior para la dispersión del agua hacia la pared. Vertical, con sifón interior en forma de codo, para la dispersión del agua con orientación hacia el suelo.

Easy and optimal installation. Universal outlet for dual connection (horizontal and vertical). Elbow included. Dual installation of the toilet is possible, for flushing in both modes: Horizontal, with straight inner siphon for water dispersal towards the wall. Vertical, with inner siphon in the form of an elbow, for the dispersion of water towards the floor.



LAVABOS INSTALACIÓN DUAL:
SOBRE ENCIMERA + MURAL

DUAL INSTALLATION WASHBASIN:
OVER COUNTERTOP OR WALL-HUNG



Lavabos que se adaptan a todas las necesidades, gracias a su instalación dual. Dos modos de instalación para lavabos con alojamiento de grifo. El montaje del lavabo es posible sobre encimera o instalación mural, con sujeción a la pared.

Washbasins that adapt to all needs, thanks to their dual installation. Two installation modes for washbasins with mixer hole. The assembly of the washbasin is possible on countertop or wall-hung installation.





MODELO MODEL		VÁLVULA DESCARGA DISCHARGE MECHANISM	VÁLVULA ALIMENTACIÓN WATER INLET	PULSADOR PUSH BUTTON	CODO ELBOW
		REF.	REF.	REF.	REF.
Aquitania	S27A308745	SAAZ309345	SAAZ309344	SAAZ309347	SAAZ309351
	S27A309389		SAAZ309505		
Aquitania	S27A308746				
Aquitania	S27A308742				
Aquitania	S27B307898				
Aquitania	S27B307915				
Alma	S28A308743	SAAZ309345	SAAZ309344	SAAZ309347	SAAZ309351
	S28A309503		SAAZ309505		
Alma	S28A308744				
Alma	S28A308747				
Alma	S28B307920				
Alma	S28B307922				
Doria	S29A307917	SAAZ309345	SAAZ309344	SAAZ309347	SAAZ309351
Doria	S29A307918				
Doria	S29A308815				
Doria	S29B308817				
Doria	S29B307919				
Kendra	S31L307925				
Kendra	S31L307900				
Kendra	S30L307926				
Kendra	S30L307927				
Kaiser	S31L307928				
Kaiser	S31L307929				
Kaiser	S30L307896				
Kaiser	S30L307895				

RECAMBIOS

Los recambios son las piezas fundamentales que garantizan la durabilidad, el rendimiento óptimo y la funcionalidad continua de los sistemas sanitarios. Diseñados específicamente para adaptarse a la perfección a los productos de la marca, ofrecen una solución confiable para mantener la eficiencia y la continuidad en el rendimiento de los inodoros y bidés. La gama de recambios de ramonsoler abarca desde piezas claves, como válvulas de descarga, hasta componentes más específicos. Todos ellos aseguran el repuesto necesario para cualquier reparación o mantenimiento periódico.

SPARE PARTS

Spare parts are the critical parts that ensure the durability, optimum performance and continued functionality of sanitary systems. Specifically designed to fit perfectly with the brand's products, these parts offer a reliable solution to maintain efficiency and continuity in the performance of toilets and bidets. The ramonsoler range of spare parts ranges from key parts, such as flush valves, to more specific components, such as internal mechanisms. All of them ensure the necessary spare part for any repair or periodic maintenance.

MODELO MODEL		FIJACIONES CISTERNA CISTERN FIXATION SYSTEM	FIJACIONES SUELO PARED WALL AND FLOOR FIXATIONS	EMBELLECEDOR HOLE COVER
		REF.	REF.	REF.
Aquitania	S27A308745	SAAZ309348	SAAZ309349	
	S27A309389			
Aquitania	S27A308746			
Aquitania	S27A308742		SAAZ309349	
Aquitania	S27B307898		SAAZ309349	SAAZ309353
Aquitania	S27B307915		SAAZ309350	SAAZ309353
Alma	S28A308743	SAAZ309348	SAAZ309349	
	S28A309503			
Alma	S28A308744			
Alma	S28A308747		SAAZ309349	
Alma	S28B307920		SAAZ309349	SAAZ309353
Alma	S28B307922		SAAZ309350	SAAZ309353
Doria	S29A307917	SAAZ309509	SAAZ309510	
Doria	S29A307918			
Doria	S29A308815		SAAZ309510	
Doria	S29B308817		SAAZ309510	SAAZ309353
Doria	S29B307919		SAAZ309511	SAAZ309353
Kendra	S31L307925			
Kendra	S31L307900			
Kendra	S30L307926			
Kendra	S30L307927			
Kaiser	S31L307928			
Kaiser	S31L307929			
Kaiser	S30L307896		SAAZ309354	SAAZ309352
Kaiser	S30L307895		SAAZ309354	SAAZ309352

solerbath.com

ramonsoler.group

solerbath.

Industrias Ramon Soler, S.A. | Vallespir, 26. Pol. | Ind. Font Santa | 08970 Sant Joan Despi (Barcelona) | Spain | 933 73 80 01