

Revisión A

21/09



TARIFA DE PRECIOS

Batsur S.L.

FORMATO DIGITAL



Revisión A



Revisión A

21/09

MOD.BS TP 01.09.21(A)

BATERÍAS

Revisión A

21/09

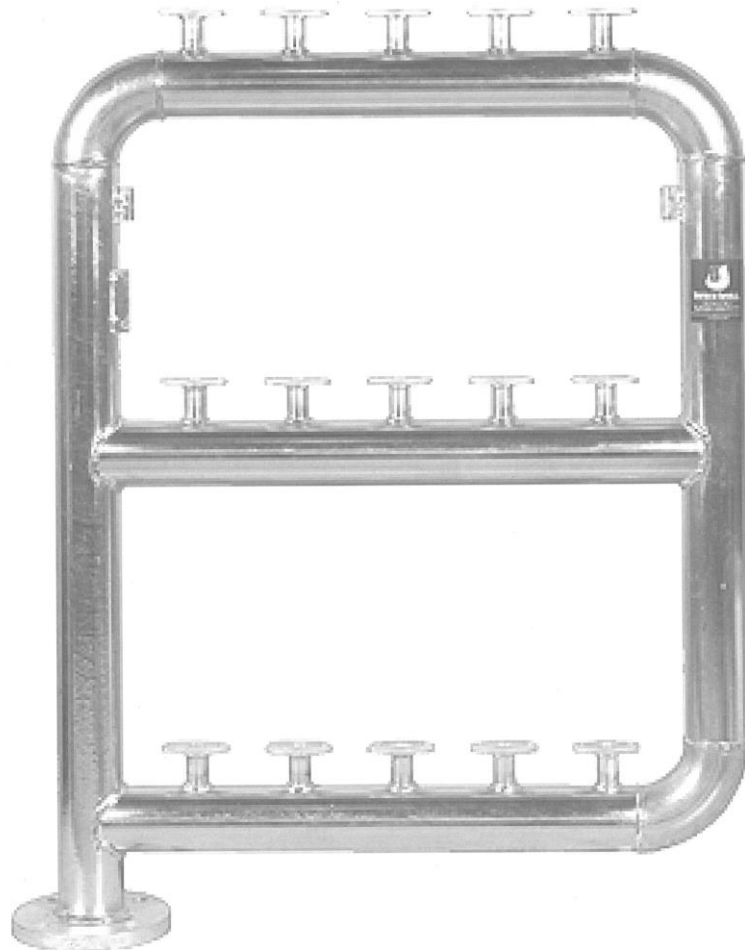

Revisión A

ÍNDICE

PAG. 5-17..... BATERÍAS PARA CENTRALIZACIÓN DE CONTADORES

PAG. 18-24..... ACCESORIOS PARA CENTRALIZACIÓN DE CONTADORES

PAG. 25..... ACCESORIOS PARA GRUPOS DE PRESIÓN

PAG. 26..... TORNILLERÍA

Revisión A

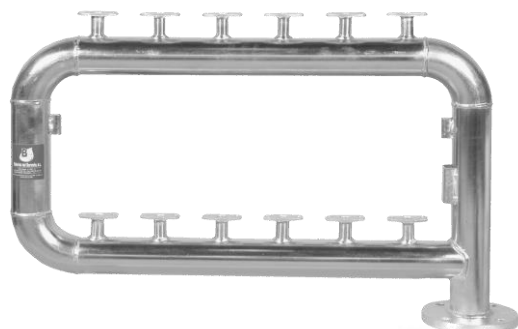

**BATERÍAS ACERO GALVANIZADO
 MODELO CUADRO CIRCUITO CERRADO 2 FILAS**

N° CONTADORES	FILAS	PULGADAS	REF.	EUROS	PESO UNID.
4	2	2"	20042	143,82	12,000
6	2	2"	20062	163,38	13,500
8	2	2 1/2"	20082	238,36	18,000
10	2	2 1/2"	20102	261,55	20,000
12	2	2 1/2"	20122	283,18	21,500
14	2	2 1/2"	20142	305,66	23,000
16	2	2 1/2"	20162	328,04	24,500
18	2	2 1/2"	20182	351,32	26,000
20	2	2 1/2"	20202	372,13	27,500
22	2	2 1/2"	20222	393,59	29,000
24	2	2 1/2"	20242	413,99	30,500
26	2	2 1/2"	20262	439,43	32,000
28	2	2 1/2"	20282	463,19	33,500
30	2	2 1/2"	20302	483,28	35,000

INCLUIDO KIT DE MONTAJE

**BATERÍAS ACERO GALVANIZADO
 MODELO CUADRO CIRCUITO CERRADO 3 FILAS**

N° CONTADORES	FILAS	PULGADAS	REF.	EUROS	PESO UNID.
6	3	2"	30063	203,11	16,500
9	3	2 1/2"	30093	297,54	24,000
12	3	2 1/2"	30123	328,24	26,000
15	3	2 1/2"	30153	361,98	28,500
18	3	2 1/2"	30183	397,42	31,000
21	3	2 1/2"	30213	430,52	33,000
24	3	2 1/2"	30243	463,58	35,000
27	3	2 1/2"	30273	498,26	37,000
30	3	2 1/2"	30303	529,77	39,500
33	3	3"	30333	632,68	55,000
36	3	3"	30363	673,65	58,000
39	3	3"	30393	716,86	62,000
42	3	3"	30423	755,16	65,500
45	3	3"	30453	794,35	69,000

INCLUIDO KIT DE MONTAJE

Revisión A

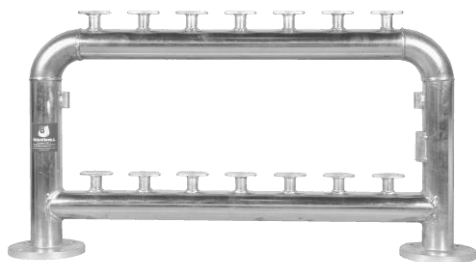
**BATERÍAS ACERO GALVANIZADO
 MODELO CUADRO CIRCUITO CERRADO 2 FILAS CON DOBLE ALIMENTACIÓN**

Nº CONTADORES	FILAS	PULGADAS	REF.	EUROS	PESO UNID.
18	2	2 1/2"	40182	393,67	33,000
20	2	2 1/2"	40202	413,93	34,500
22	2	2 1/2"	40222	434,82	36,000
24	2	2 1/2"	40242	454,69	37,500
26	2	2 1/2"	40262	474,44	39,000
28	2	2 1/2"	40282	502,60	40,500
30	2	2 1/2"	40302	522,16	42,000

INCLUIDO KIT DE MONTAJE

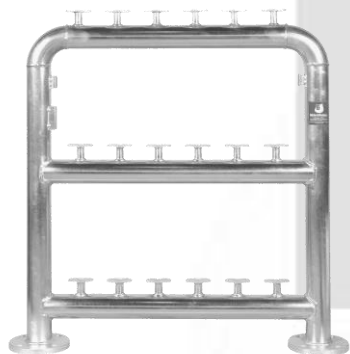
**BATERÍAS ACERO GALVANIZADO
 MODELO CUADRO CIRCUITO CERRADO 3 FILAS CON DOBLE ALIMENTACIÓN**

Nº CONTADORES	FILAS	PULGADAS	REF.	EUROS	PESO UNID.
18	3	2 1/2"	50183	438,33	38,000
21	3	2 1/2"	50213	470,56	40,000
24	3	2 1/2"	50243	502,74	42,000
27	3	2 1/2"	50273	536,52	44,000
30	3	2 1/2"	50303	567,20	46,000
33	3	3"	50333	689,65	63,000
36	3	3"	50363	729,70	66,500
39	3	3"	50393	772,12	70,500
42	3	3"	50423	810,20	74,000
45	3	3"	50453	854,29	77,500

INCLUIDO KIT DE MONTAJE

Revisión A

BATERÍAS VERSIÓN ACERO GALVANIZADO 1 FILA



Nº CONTADORES	FILAS	REF.	EUROS	PESO UNID.
1	1	10011	17,54	1,000
2	1	10021	84,90	5,500
3	1	10031	98,97	7,000
4	1	10041	122,61	10,500
5	1	10051	133,58	11,500
6	1	10061	138,77	12,500

INCLUIDO KIT DE MONTAJE

BATERÍAS VERSIÓN ACERO GALVANIZADO 2 FILAS



Nº CONTADORES	FILAS	REF.	EUROS	PESO UNID.
2	2	10022	86,63	5,000
4	2	10042	113,90	8,500
6	2	10062	143,71	10,000
8	2	10082	177,95	13,000
10	2	10102	199,52	14,500

INCLUIDO KIT DE MONTAJE

BATERÍAS VERSIÓN ACERO GALVANIZADO HORIZONTAL



Nº CONTADORES	REF.	EUROS	PESO UNID.
2	12002	83,46	5,000
3	12003	98,43	6,000

INCLUIDO KIT DE MONTAJE

BATERÍAS VERSIÓN ACERO GALVANIZADO HORIZONTAL CON CODO



Nº CONTADORES	REF.	EUROS	PESO UNID.
2	11002	92,53	5,500
3	11003	107,88	6,500

INCLUIDO KIT DE MONTAJE

Revisión A

BATERÍAS POLIPROPILENO CIRCUITO CERRADO 2 FILAS

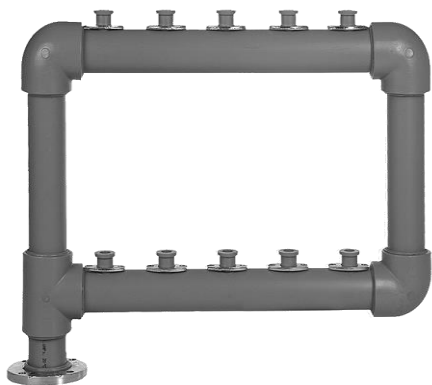

Nº CONTADORES	FILAS	Ø	PULGADAS	REF.	EUROS	PESO UNID.
4	2	63	2"	PPR71042	120,20	7,800
6	2	63	2"	PPR71062	129,37	8,600
8	2	75	2 1/2"	PPR71082	171,49	13,900
10	2	75	2 1/2"	PPR71102	181,77	14,900
12	2	75	2 1/2"	PPR71122	202,70	15,900
14	2	75	2 1/2"	PPR71142	220,40	16,900
16	2	75	2 1/2"	PPR71162	225,61	18,300
18	2	75	2 1/2"	PPR71182	231,55	18,900
20	2	75	2 1/2"	PPR71202	260,30	19,900
22	2	75	2 1/2"	PPR71222	278,27	20,900
24	2	75	2 1/2"	PPR71242	292,67	21,900
26	2	75	2 1/2"	PPR71262	304,31	22,900
28	2	75	2 1/2"	PPR71282	319,84	23,900
30	2	75	2 1/2"	PPR71302	337,97	24,900

INCLUIDO KIT DE MONTAJE

BATERÍAS POLIPROPILENO CIRCUITO CERRADO 3 FILAS

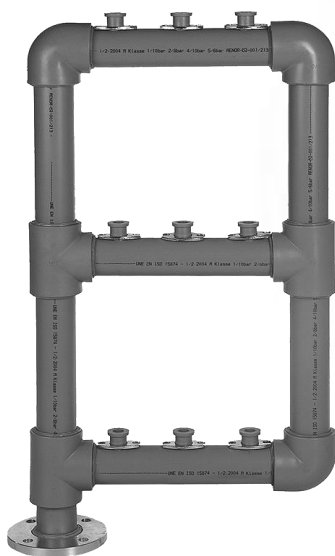

Nº CONTADORES	FILAS	Ø	PULGADAS	REF.	EUROS	PESO UNID.
6	3	63	2"	PPR72063	163,06	16,400
9	3	75	2 1/2"	PPR72093	226,10	17,600
12	3	75	2 1/2"	PPR72123	242,38	18,800
15	3	75	2 1/2"	PPR72153	260,01	20,000
18	3	75	2 1/2"	PPR72183	281,47	21,200
21	3	75	2 1/2"	PPR72213	304,10	22,400
24	3	75	2 1/2"	PPR72243	325,79	23,600
27	3	75	2 1/2"	PPR72273	344,56	24,800
30	3	75	2 1/2"	PPR72303	365,29	25,000
33	3	90	3"	PPR72333	496,30	28,100
36	3	90	3"	PPR72363	516,06	29,000
39	3	90	3"	PPR72393	535,83	29,900
42	3	90	3"	PPR72423	555,59	30,800
45	3	90	3"	PPR72453	575,36	31,700

INCLUIDO KIT DE MONTAJE

Revisión A

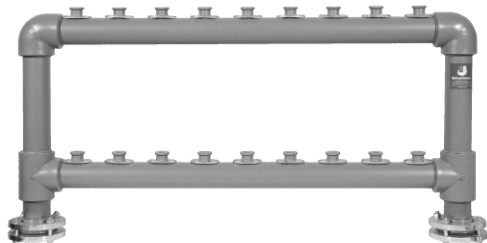
BATERÍAS POLIPROPILENO
MODELO CIRCUITO CERRADO 2 FILAS CON DOBLE ALIMENTACIÓN

N° CONTADORES	FILAS	Ø	PULGADAS	REF.	EUROS	PESO UNID.
18	2	75	2 1/2"	PPR91182	271,76	18,400
20	2	75	2 1/2"	PPR91202	282,61	19,300
22	2	75	2 1/2"	PPR91222	300,69	20,200
24	2	75	2 1/2"	PPR91242	311,54	21,100
26	2	75	2 1/2"	PPR91262	322,39	22,000
28	2	75	2 1/2"	PPR91282	333,24	22,900
30	2	75	2 1/2"	PPR91302	345,31	23,800

INCLUIDO KIT DE MONTAJE

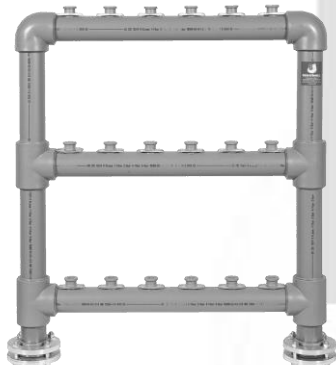
BATERÍAS POLIPROPILENO
MODELO CIRCUITO CERRADO 3 FILAS CON DOBLE ALIMENTACIÓN

N° CONTADORES	FILAS	Ø	PULGADAS	REF.	EUROS	PESO UNID.
18	3	75	2 1/2"	PPR92183	314,62	21,400
21	3	75	2 1/2"	PPR92213	330,90	22,300
24	3	75	2 1/2"	PPR92243	347,17	23,200
27	3	75	2 1/2"	PPR92273	363,45	24,100
30	3	75	2 1/2"	PPR92303	379,73	25,000
33	3	90	3"	PPR92333	549,01	27,900
36	3	90	3"	PPR92363	569,72	28,800
39	3	90	3"	PPR92393	591,64	29,700
42	3	90	3"	PPR92423	610,47	30,600
45	3	90	3"	PPR92453	633,06	31,500

INCLUIDO KIT DE MONTAJE

Revisión A

BATERÍAS VERSIÓN POLIPROPILENO 1 FILA



Nº CONTADORES	FILAS	REF.	EUROS	PESO UNID.
1	1	PPR10011	13,57	3,000
2	1	PPR10021	84,62	3,800
3	1	PPR10031	99,29	4,500
4	1	PPR10041	114,82	5,300
5	1	PPR10051	130,77	6,000
6	1	PPR10061	152,33	6,800

INCLUIDO KIT DE MONTAJE

BATERÍAS VERSIÓN POLIPROPILENO 2 FILAS



Nº CONTADORES	FILAS	REF.	EUROS	PESO UNID.
2	2	PPR10022	87,61	3,500
4	2	PPR10042	113,99	4,200
6	2	PPR10062	141,65	5,000
8	2	PPR10082	179,90	7,500
10	2	PPR10102	206,61	8,500
12	2	PPR10122	233,96	9,500

INCLUIDO KIT DE MONTAJE

Revisión A

BATERÍAS POLIPROPILENO CIRCUITO CERRADO SERIE ROSCADA 2 FILAS

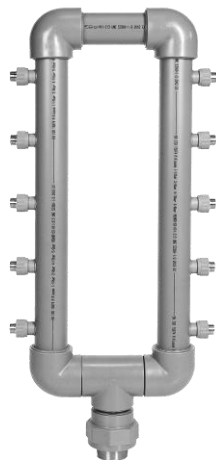

Nº CONTADORES	FILAS	Ø	R. ENTRADA	R. SALIDA	REF.	EUROS	PESO UNID.
6	2	63	2" H	3/4" M	PPR74062	172,07	3,900
8	2	63	2" H	3/4" M	PPR74082	189,92	4,800
10	2	75	2 1/2" H	3/4" M	PPR74102	250,82	9,000
12	2	75	2 1/2" H	3/4" M	PPR74122	270,83	9,800
14	2	75	2 1/2" H	3/4" M	PPR74142	290,83	10,600
16	2	75	2 1/2" H	3/4" M	PPR74162	311,76	11,400
18	2	75	2 1/2" H	3/4" M	PPR74182	331,77	12,200
20	2	75	2 1/2" H	3/4" M	PPR74202	351,78	13,000
22	2	75	2 1/2" H	3/4" M	PPR74222	372,71	13,800
24	2	75	2 1/2" H	3/4" M	PPR74242	393,96	14,600
26	2	75	2 1/2" H	3/4" M	PPR74262	413,97	15,400
28	2	75	2 1/2" H	3/4" M	PPR74282	434,90	16,200
30	2	75	2 1/2" H	3/4" M	PPR74302	462,32	17,000

INCLUIDO SOPORTE SUJECCIÓN

BATERÍAS VERSIÓN POLIPROPILENO ROSCADA 1 FILA



Nº CONTADORES	FILAS	Ø	R. ENTRADA	R. SALIDA	REF.	EUROS	PESO UNID.
3	1	63	2" H	3/4" M	PPR61031	77,13	1,800
4	1	63	2" H	3/4" M	PPR61041	84,35	2,200
5	1	63	2" H	3/4" M	PPR61051	91,70	3,000
6	1	63	2" H	3/4" M	PPR61061	100,63	3,900
7	1	63	2" H	3/4" M	PPR61071	107,70	4,300
8	1	75	2 1/2" H	3/4" M	PPR61081	142,42	5,100
9	1	75	2 1/2" H	3/4" M	PPR61091	150,10	6,700
10	1	75	2 1/2" H	3/4" M	PPR61101	158,72	7,500

PARA BATERÍAS CON OTRAS MEDIDAS CONSULTAR

BATERÍAS VERSIÓN POLIPROPILENO ROSCADA 2 FILAS



Nº CONTADORES	FILAS	Ø	R. ENTRADA	R. SALIDA	REF.	EUROS	PESO UNID.
4	2	63	2" H	3/4" M	PPR61042	83,22	2,600
6	2	63	2" H	3/4" M	PPR61062	94,87	3,400
8	2	75	2 1/2" H	3/4" M	PPR61082	131,03	5,900
10	2	75	2 1/2" H	3/4" M	PPR61102	145,27	8,300
12	2	75	2 1/2" H	3/4" M	PPR61122	159,80	9,100
14	2	75	2 1/2" H	3/4" M	PPR61142	171,68	9,900
16	2	75	2 1/2" H	3/4" M	PPR61162	182,37	10,700
18	2	75	2 1/2" H	3/4" M	PPR61182	194,62	11,500
20	2	75	2 1/2" H	3/4" M	PPR61202	207,34	12,300

PARA BATERÍAS CON OTRAS MEDIDAS CONSULTAR

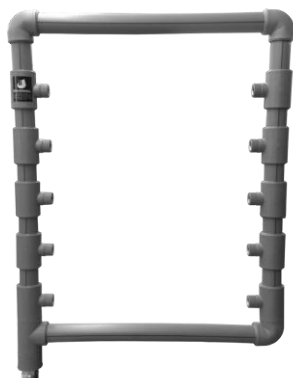
BATERÍAS POLIPROPILENO CIRCUITO CERRADO 2 FILAS SERIE ROSCADA

Nº CONTADORES	FILAS	Ø	R.ENTRADA	R.SALIDA	REF.	EUROS	PESO UNID.
6	2	63	2" M	3/4" H	PPRE75062E	235,67	10,000
8	2	63	2" M	3/4" H	PPRE75082E	273,81	12,000
10	2	63	2" M	3/4" H	PPRE75102E	306,29	14,000
12	2	63	2" M	3/4" H	PPRE75122E	338,43	16,000
14	2	63	2" M	3/4" H	PPRE75142E	375,92	18,000
16	2	63	2" M	3/4" H	PPRE75162E	412,33	20,000

SOPORTES NO INCLUIDOS

Revisión A



BATERÍAS POLIPROPILENO 2 FILAS SERIE ROSCADA



Nº CONTADORES	FILAS	Ø	R.ENTRADA	R.SALIDA	REF.	EUROS	PESO UNID.
2	2	50	1 1/2" M	3/4" H	PPRE74022	157,23	9,000
4	2	50	1 1/2" M	3/4" H	PPRE74042	184,72	10,500
6	2	50	1 1/2" M	3/4" H	PPRE74062	212,23	12,000

SOPORTES NO INCLUIDOS

BATERÍAS POLIPROPILENO VERSIÓN 1 FILA SERIE ROSCADA



Nº CONTADORES	FILAS	Ø	R.ENTRADA	R.SALIDA	REF.	EUROS	PESO UNID.
2	1	40	1" M	3/4" H	PPRE63021	77,28	3,000
3	1	40	1" M	3/4" H	PPRE63031	91,59	4,000
4	1	40	1" M	3/4" H	PPRE63041	106,23	5,000

SOPORTES NO INCLUIDOS

Revisión A

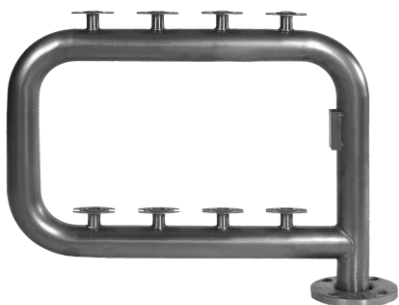
**BATERÍAS ACERO INOXIDABLE
 MODELO CUADRO CIRCUITO CERRADO 2 FILAS**

N° CONTADORES	Ø TUBO	FILAS	BRIDAS	REF.	EUROS	PESO UNID.
4	63	2	2"	INOX20042	260,51	4,700
6	63	2	2"	INOX20062	283,72	5,200
8	63	2	2 1/2"	INOX20082	316,23	5,900
10	63	2	2 1/2"	INOX20102	350,78	6,700
12	63	2	2 1/2"	INOX20122	377,40	7,700
14	63	2	2 1/2"	INOX20142	404,07	8,100
16	63	2	2 1/2"	INOX20162	430,73	9,200
18	63	2	2 1/2"	INOX20182	447,36	9,700
20	63	2	2 1/2"	INOX20202	484,07	10,800
22	63	2	2 1/2"	INOX20222	510,73	11,500
24	63	2	2 1/2"	INOX20242	538,72	12,000
26	63	2	2 1/2"	INOX20262	565,39	12,700
28	63	2	2 1/2"	INOX20282	592,05	13,800
30	63	2	2 1/2"	INOX20302	618,72	14,300

INCLUIDO KIT DE MONTAJE

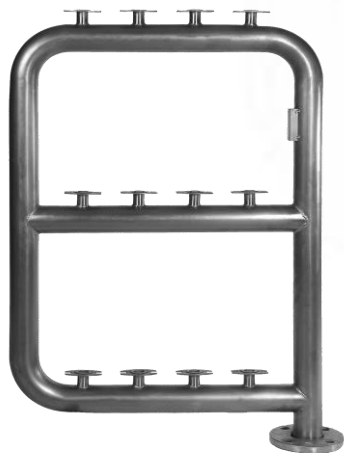
**BATERÍAS ACERO INOXIDABLE
 MODELO CUADRO CIRCUITO CERRADO 3 FILAS**

N° CONTADORES	Ø TUBO	FILAS	BRIDAS	REF.	EUROS	PESO UNID.
6	63	3	2"	INOX30063	371,70	7,500
9	63	3	2 1/2"	INOX30093	407,35	8,200
12	63	3	2 1/2"	INOX30123	443,00	9,500
15	63	3	2 1/2"	INOX30153	478,75	10,500
18	63	3	2 1/2"	INOX30183	516,63	11,500
21	63	3	2 1/2"	INOX30213	553,69	12,800
24	63	3	2 1/2"	INOX30243	590,01	13,900
27	63	3	2 1/2"	INOX30273	626,23	15,000
30	63	3	2 1/2"	INOX30303	663,68	16,100
33	75	3	2 1/2"	INOX30333	824,20	21,300
36	75	3	2 1/2"	INOX30363	869,21	23,200
39	75	3	2 1/2"	INOX30393	937,78	25,100
42	75	3	2 1/2"	INOX30423	982,79	27,000
45	75	3	2 1/2"	INOX30453	1.051,36	28,800

OPCIONAL: En baterías con tubo Ø75 se pueden suministrar con brida roscada de 3"

INCLUIDO KIT DE MONTAJE

Revisión A

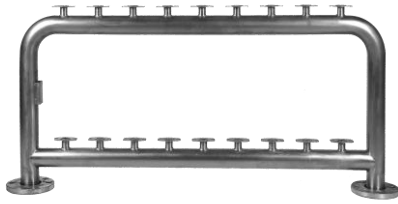
**BATERÍAS ACERO INOXIDABLE
 MODELO CUADRO CIRCUITO CERRADO 2 FILAS CON DOBLE ALIMENTACIÓN**

Nº CONTADORES	Ø TUBO	FILAS	BRIDAS	REF.	EUROS	PESO UNID.
18	63	2	2 1/2"	INOX40182	503,17	10,500
20	63	2	2 1/2"	INOX40202	529,90	11,200
22	63	2	2 1/2"	INOX40222	556,50	11,900
24	63	2	2 1/2"	INOX40242	583,06	12,700
26	63	2	2 1/2"	INOX40262	609,74	13,400
28	63	2	2 1/2"	INOX40282	636,34	14,100
30	63	2	2 1/2"	INOX40302	663,00	14,800

INCLUIDO KIT DE MONTAJE

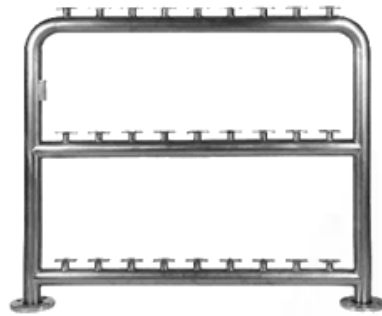
**BATERÍAS ACERO INOXIDABLE
 MODELO CUADRO CIRCUITO CERRADO 3 FILAS CON DOBLE ALIMENTACIÓN**

Nº CONTADORES	Ø TUBO	FILAS	BRIDAS	REF.	EUROS	PESO UNID.
18	63	3	2 1/2"	INOX50183	584,04	12,900
21	63	3	2 1/2"	INOX50213	619,46	13,900
24	63	3	2 1/2"	INOX50243	655,57	14,920
27	63	3	2 1/2"	INOX50273	708,25	15,930
30	63	3	2 1/2"	INOX50303	749,82	16,940
33	75	3	2 1/2"	INOX50333	852,11	22,100
36	75	3	2 1/2"	INOX50363	897,15	23,900
39	75	3	2 1/2"	INOX50393	965,72	25,700
42	75	3	2 1/2"	INOX50423	1.010,76	26,900
45	75	3	2 1/2"	INOX50453	1.080,44	28,400

OPCIONAL: En baterías con tubo Ø75 se pueden suministrar con brida roscada de 3"

INCLUIDO KIT DE MONTAJE

Revisión A

BATERÍAS VERSIÓN ACERO INOXIDABLE 1 FILA



Nº CONTADORES	FILAS	REF.	EUROS	PESO UNID.
1	1	INOX10011	31,98	0,350
2	1	INOX10021	130,71	1,300
3	1	INOX10031	154,80	1,750
4	1	INOX10041	178,33	2,200
5	1	INOX10051	215,44	2,650

INCLUIDO KIT DE MONTAJE

BATERÍAS VERSIÓN ACERO INOXIDABLE 2 FILAS



Nº CONTADORES	FILAS	REF.	EUROS	PESO UNID.
2	2	INOX10022	144,71	0,900
4	2	INOX10042	178,74	1,750
6	2	INOX10062	221,57	2,600
8	2	INOX10082	275,68	4,450
10	2	INOX10102	351,11	4,750

INCLUIDO KIT DE MONTAJE

BATERÍAS VERSIÓN ACERO INOXIDABLE HORIZONTAL



Nº CONTADORES	REF.	EUROS	PESO UNID.
2	INOX12002	114,52	1,200
3	INOX12003	126,63	1,650

INCLUIDO KIT DE MONTAJE

BATERÍAS VERSIÓN ACERO INOXIDABLE HORIZONTAL CON CODO



Nº CONTADORES	REF.	EUROS	PESO UNID.
2	INOX11002	125,94	1,400
3	INOX11003	138,01	1,800

INCLUIDO KIT DE MONTAJE

Revisión A

BATERÍAS POLIETILENO VERSIÓN

(COLECTOR DE UNA SOLA PIEZA)



Nº CONTADORES	FILAS	Ø	R. ENTRADA	R. SALIDA	REF.	EUROS	PESO UNID.
3	1	63	2" M	3/4" M	PE61031	46,42	0,150
4	1	63	2" M	3/4" M	PE61041	51,37	0,182
5	1	63	2" M	3/4" M	PE61051	53,87	0,212
6	1	63	2" M	3/4" M	PE61061	57,38	0,244
7	1	63	2" M	3/4" M	PE61071	63,37	0,276
8	1	63	2" M	3/4" M	PE61081	67,23	0,308
9	1	63	2" M	3/4" M	PE61091	73,38	0,340
10	1	63	2" M	3/4" M	PE61101	77,04	0,372

PARA BATERÍAS CON OTRAS MEDIDAS CONSULTAR

BATERÍAS POLIETILENO ROSCADAS MOD. TREVI

(TUBO VERTICAL Y SALIDAS DE UNA SOLA PIEZA)



Nº CONTADORES	FILAS	Ø	R. ENTRADA	R. SALIDA	REF.	EUROS	PESO UNID.
6	2	63	2" M	3/4" M	PE74062	102,14	0,201
8	2	63	2" M	3/4" M	PE74082	117,04	0,224
10	2	63	2" M	3/4" M	PE74102	117,04	0,256
12	2	63	2" M	3/4" M	PE74122	124,05	0,288
14	2	63	2" M	3/4" M	PE74142	136,04	0,320
16	2	63	2" M	3/4" M	PE74162	151,61	0,352
18	2	63	2" M	3/4" M	PE74182	162,61	0,382

PARA BATERÍAS CON OTRAS MEDIDAS CONSULTAR

Revisión A

AMPLIACIÓN DE BATERÍA

AMPLIACIÓN DE BATERÍA A/G

REF.	EUROS	UNID. DE EMBALAJE	PESO UNID.
1010001	44,75	1	1,000

AMPLIACIÓN DE BATERÍA PPR

REF.	EUROS	UNID. DE EMBALAJE	PESO UNID.
1010010	36,60	1	0,350

AMPLIACIÓN DE BATERÍA A/INOX

REF.	EUROS	UNID. DE EMBALAJE	PESO UNID.
1010020	74,19	1	0,450

CAÑO LIBRE COMPROBACIÓN EN PPR

3/4" x 3/4" PPR LONG. 110

REF.	EUROS	UNID. DE EMBALAJE	PESO UNID.
1010107	3,11	10	0,020

7/8" x 3/4" PPR LONG. 115

REF.	EUROS	UNID. DE EMBALAJE	PESO UNID.
1010109	4,77	10	0,025

1" x 1" PPR LONG. 130

REF.	EUROS	UNID. DE EMBALAJE	PESO UNID.
1010108	4,05	10	0,030

CAÑO SUPLETORIO CIEGO

3/4" x 3/4" LONG. 115 COLOR AZUL

REF.	EUROS	UNID. DE EMBALAJE	PESO UNID.
1010110	8,81	10	0,068

1" x 1" LONG. 190 COLOR ROJO

REF.	EUROS	UNID. DE EMBALAJE	PESO UNID.
1010111	11,72	10	0,160

Revisión A

BRIDA CIEGA ZINCADA CON TORNILLOS Y JUNTA

	REF.	EUROS	UNID. DE EMBALAJE	PESO UNID.
	1010201	3,44	10	0,216

BRIDA CIEGA A/INOX CON TORNILLOS Y JUNTA

	REF.	EUROS	UNID. DE EMBALAJE	PESO UNID.
	1010204	4,00	10	0,144

BRIDA CIEGA ANTIFRAUDE

SISTEMA PATENTADO

	REF.	EUROS	UNID. DE EMBALAJE	PESO UNID.
	1010209	21,48	10	0,526

TAPONES ANTIFRAUDE NO INCLUIDOS

CONTRABRIDA MACHO CON TORNILLOS Y JUNTA

	REF.	EUROS	UNID. DE EMBALAJE	PESO UNID.
	1010211	4,96	10	0,236

Revisión A

ABRAZADERAS DE REPARACIÓN ACERO INOXIDABLE CON TOMA



ABRAZADERA DE REPARACIÓN ACERO INOX. Ø63 CON TOMA

REF.	EUROS	UNID. DE EMBALAJE	PESO UNID.
380001	55,77	1	0,450

ABRAZADERA DE REPARACIÓN ACERO INOX. Ø75 CON TOMA

REF.	EUROS	UNID. DE EMBALAJE	PESO UNID.
380002	55,85	1	0,550

ABRAZADERA DE REPARACIÓN ACERO INOX. Ø90 CON TOMA

REF.	EUROS	UNID. DE EMBALAJE	PESO UNID.
380003	57,33	1	0,650



Revisión A

SOPORTE BATERÍA ACERO ZINCADO
SOPORTE BATERÍA A/G Ø10

REF.	EUROS	UNID. DE EMBALAJE	PESO UNID.
1010011	2,17	2	0,150

SOPORTE BATERÍA A/G Ø12

REF.	EUROS	UNID. DE EMBALAJE	PESO UNID.
1010012	2,89	2	0,200

SOPORTE BATERÍA ACERO ZINCADO
SOPORTE BATERÍA PPR-PE Ø DE TUBO 63

REF.	EUROS	UNID. DE EMBALAJE	PESO UNID.
1010014	2,17	2	0,185

SOPORTE BATERÍA PPR-PE Ø DE TUBO 75

REF.	EUROS	UNID. DE EMBALAJE	PESO UNID.
1010015	2,38	2	0,210

SOPORTE BATERÍA PPR-PE Ø DE TUBO 90

REF.	EUROS	UNID. DE EMBALAJE	PESO UNID.
1010016	2,95	2	0,210

SOPORTE BATERÍA A/INOX. AISI-304
SOPORTE BATERÍA A/INOX PARA Ø DE TUBO 63

REF.	EUROS	UNID. DE EMBALAJE	PESO UNID.
1010017	6,95	2	0,140

SOPORTE BATERÍA A/INOX PARA Ø DE TUBO 75

REF.	EUROS	UNID. DE EMBALAJE	PESO UNID.
1010018	6,62	2	0,153

PLACAS DE CLASIFICACIÓN



4x2 a 30x2	REF.	EUROS	6x3 a 60x3	REF.	EUROS	UNID.
4x2	01011042	4,74	6x3	01011063	5,53	1
6x2	01011062	5,15	9x3	01011093	6,06	1
8x2	01011082	5,57	12x3	01011123	6,60	1
10x2	01011102	5,99	15x3	01011153	7,13	1
12x2	01011122	6,41	18x3	01011183	7,66	1
14x2	01011142	6,83	21x3	01011213	9,23	1
16x2	01011162	7,25	24x3	01011243	9,72	1
18x2	01011182	7,66	27x3	01011273	10,26	1
20x2	01011202	8,34	30x3	01011303	11,29	1
22x2	01011222	8,76	33x3	01011333	12,44	1
24x2	01011242	9,18	36x3	01011363	13,32	1
26x2	01011262	10,09	39x3	01011393	13,89	1
28x2	01011282	10,51	42x3	01011423	14,80	1
30x2	01011302	11,12	45x3	01011453	15,76	1
			48x3	01011483	18,14	1
			51x3	01011513	19,36	1
			54x3	01011543	19,78	1
			57x3	01011573	21,06	1
			60x3	01011603	20,53	1

CONEXIONES FLEXIBLES

MEDIDA	LONGITUD	ROSCA	MATERIAL	REF.	EUROS	UNID. EMBALAJE	PESO UNID.
3/4"	300	M-H	GALVANIZADO(*)	1010330	7,04	10	0,250
3/4"	400	M-H	GALVANIZADO(*)	1010340	7,25	10	0,300
1"	300	M-H	GALVANIZADO(*)	1010430	11,70	10	0,300
1"	500	M-H	GALVANIZADO(*)	1010450	13,95	10	0,400
3/4"	300	M-H	INOXIDABLE	1010530	7,56	10	0,250
3/4"	400	M-H	INOXIDABLE	1010540	8,14	10	0,300
3/4"	500	M-H	INOXIDABLE	1010550	8,90	10	0,350
3/4"	600	M-H	INOXIDABLE	1010560	9,57	10	0,400
1"	300	M-H	INOXIDABLE	1010630	12,74	10	0,300
1"	400	M-H	INOXIDABLE	1010640	13,12	10	0,350
1"	500	M-H	INOXIDABLE	1010650	14,52	10	0,400
1"	600	M-H	INOXIDABLE	1010660	15,48	10	0,450
1"	800	M-H	INOXIDABLE	1010680	17,43	10	0,550

(*) Hasta fin de existencias en conexiones flexibles en acero galvanizado.

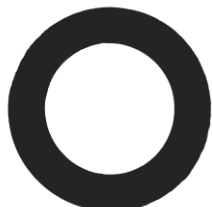
JUNTAS PLANAS EPDM PARA BRIDAS PN6 – PN10



JUNTA PLANA BRIDA PN 10 1 1/4" AG-INOX 80x44x3

REF.	EUROS	UNID. DE EMBALAJE	PESO UNID.
1010940	0,65	5	0,018

JUNTA PLANA BRIDA PN 10 1 1/2" AG-INOX 93x49x3

REF.	EUROS	UNID. DE EMBALAJE	PESO UNID.
1010941	0,78	5	0,024

JUNTA PLANA BRIDA PN 10 2" AG-INOX 104x65x3

REF.	EUROS	UNID. DE EMBALAJE	PESO UNID.
1010942	0,89	5	0,031

JUNTA PLANA BRIDA PN 10 2 1/2" AG-INOX 127x76x3

REF.	EUROS	UNID. DE EMBALAJE	PESO UNID.
1010943	1,03	5	0,037

JUNTA PLANA BRIDA PN 10 3" AG-INOX 143x90x3

REF.	EUROS	UNID. DE EMBALAJE	PESO UNID.
1010944	1,33	5	0,043



JUNTA PLANA BRIDA PN 6 2" PPR-PE 93x49x3

REF.	EUROS	UNID. DE EMBALAJE	PESO UNID.
1010941	0,78	5	0,031

JUNTA PLANA BRIDA PN 6 2 1/2" PPR-PE 104x65x3

REF.	EUROS	UNID. DE EMBALAJE	PESO UNID.
1010942	0,89	5	0,037

JUNTA PLANA BRIDA PN 6 3" PPR-PE 127x76x3

REF.	EUROS	UNID. DE EMBALAJE	PESO UNID.
1010943	1,03	5	0,043

Revisión A



JUNTA PLANA BRIDA CIEGA 44x3

REF.	EUROS	UNID. DE EMBALAJE	PESO UNID.
1036001	0,32	5	0,006



JUNTA PLANA CONTRABRIDA 43x20x3

REF.	EUROS	UNID. DE EMBALAJE	PESO UNID.
1035110	0,27	5	0,009



JUNTA PLANA 3/4" PARA CONEXIÓN FLEXIBLE

REF.	EUROS	UNID. DE EMBALAJE	PESO UNID.
1035111	0,18	20	0,006

JUNTA PLANA 1" PARA CONEXIÓN FLEXIBLE

REF.	EUROS	UNID. DE EMBALAJE	PESO UNID.
1035161	0,24	20	0,006

Revisión A

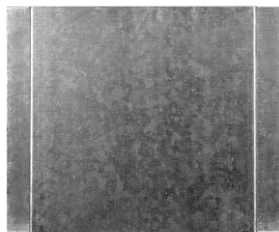
BANCADAS PARA GRUPOS DE PRESIÓN

MEDIDAS	REF.	EUROS	UNID. EMBALAJE	PESO UNID.
40x38	160001	37,63	1	5,100
70x38	160006	86,27	1	8,900
80x70	160011	122,69	1	11,700
80x38	160013	99,09	1	10,800
90x38	160007	106,15	1	12,900
90x50	160008	122,69	1	14,600
90x70	160012	139,19	1	17,300
95x65	160019	156,33	1	20,200

COLECTOR SIN SALIDA DE MANÓMETRO ZINCADOS

PULGADAS	REF.	EUROS	UNID. EMBALAJE	PESO UNID.
1 ½" 1 ¼"	161001	75,41	1	1,600
2" 1 ½"	161002	80,75	1	2,100
2 ½" 2"	161003	97,47	1	4,500
3" 2 ½"	161004	115,75	1	5,200

COLECTOR CON SALIDA DE MANÓMETRO ZINCADOS

PULGADAS	REF.	EUROS	UNID. EMBALAJE	PESO UNID.
1 ½" 1 ¼"	162001	74,85	1	1,650
2" 1 ½"	162002	80,71	1	2,500
2 ½" 2"	162003	95,87	1	4,800
3" 2 ½"	162004	112,06	1	5,450

COLECTOR 3 VÍAS PARA BATERÍA DE CONTADORES

BRIDA	ROSCA MACHO	REF.	EUROS	PESO UNID.
1 1/2"	1 1/2"	165002	54,99	2,700
2"	2"	165003	59,64	3,700
2 1/2"	2 1/2"	165004	67,01	5,300
3"	3"	165005	80,99	6,600

INCLUIDO KIT DE MONTAJE

Revisión A

TORNILLERÍA
TORNILLO M-12x65 ZINCADO C/T

REF.	EUROS	UNID. DE EMBALAJE	PESO UNID.
202007	0,73	5	0,054

TORNILLO M-12x80 ZINCADO C/T

REF.	EUROS	UNID. DE EMBALAJE	PESO UNID.
202018	0,89	5	0,058

TORNILLO M-16x55 ZINCADO C/T

REF.	EUROS	UNID. DE EMBALAJE	PESO UNID.
202008	1,14	5	0,087

TORNILLO M-16x60 ZINCADO C/T

REF.	EUROS	UNID. DE EMBALAJE	PESO UNID.
202009	1,15	5	0,098

TORNILLO M-16x70 ZINCADO C/T

REF.	EUROS	UNID. DE EMBALAJE	PESO UNID.
202010	1,50	5	0,116

TORNILLO M-16x80 ZINCADO C/T

REF.	EUROS	UNID. DE EMBALAJE	PESO UNID.
202011	1,49	5	0,128

TORNILLO M-20x70 ZINCADO C/T

REF.	EUROS	UNID. DE EMBALAJE	PESO UNID.
202015	2,05	10	0,115

TORNILLO M-20x80 ZINCADO C/T

REF.	EUROS	UNID. DE EMBALAJE	PESO UNID.
202017	3,53	10	0,124

ESPÁRRAGO M-16x60 ZINCADO C/T

REF.	EUROS	UNID. DE EMBALAJE	PESO UNID.
01611107	0,80	10	0,080

ESPÁRRAGO M-16x70 ZINCADO C/T

REF.	EUROS	UNID. DE EMBALAJE	PESO UNID.
01611101	0,89	10	0,094

ESPÁRRAGO M-16x80 ZINCADO C/T

REF.	EUROS	UNID. DE EMBALAJE	PESO UNID.
01611108	0,99	10	0,100

ESPÁRRAGO M-16x90 ZINCADO C/T

REF.	EUROS	UNID. DE EMBALAJE	PESO UNID.
01611109	1,08	10	0,110

Revisión A

VÁLVULAS ASIEN TO

SERIE BS BS

Revisión A
21/09



Revisión A

ÍNDICE

PAG. 29-33.....VÁLVULAS SERIE BS

PAG. 34-37..... ACCESORIOS VÁLVULAS SERIE BS

PAG. 38..... TORNILLERIA VÁLVULAS EMBRIDADAS



Revisión A

VÁLVULAS ENTRADA SERIE BS PARA CONTADORES Ø 13, 15 Y 20



ENTRADA FIJA DN 13-15

DISPOSITIVO ANTIRRETORNO	SI	NO	REF.	EUROS	UNID. DE EMBALAJE	PESO UNID.
	<input checked="" type="checkbox"/>	<input type="checkbox"/>	100001	13,96	30	0,400

ENTRADA FIJA DN 20

DISPOSITIVO ANTIRRETORNO	SI	NO	REF.	EUROS	UNID. DE EMBALAJE	PESO UNID.
	<input checked="" type="checkbox"/>	<input type="checkbox"/>	100011	17,50	30	0,600

OPCIÓN DE MANETA DE LATÓN. CONSULTAR.



ENTRADA ORIENTABLE DN 13-15

DISPOSITIVO ANTIRRETORNO	SI	NO	REF.	EUROS	UNID. DE EMBALAJE	PESO UNID.
	<input checked="" type="checkbox"/>	<input type="checkbox"/>	101001	15,37	30	0,500

ENTRADA ORIENTABLE DN 20

DISPOSITIVO ANTIRRETORNO	SI	NO	REF.	EUROS	UNID. DE EMBALAJE	PESO UNID.
	<input checked="" type="checkbox"/>	<input type="checkbox"/>	101011	22,14	30	0,700

OPCIÓN DE MANETA DE LATÓN. CONSULTAR.



ENTRADA FIJA Y ANTIFRAUDE DN 13-15

DISPOSITIVO ANTIRRETORNO	SI	NO	REF.	EUROS	UNID. DE EMBALAJE	PESO UNID.
	<input checked="" type="checkbox"/>	<input type="checkbox"/>	100002	17,46	30	0,400

ENTRADA FIJA Y ANTIFRAUDE DN 20

DISPOSITIVO ANTIRRETORNO	SI	NO	REF.	EUROS	UNID. DE EMBALAJE	PESO UNID.
	<input checked="" type="checkbox"/>	<input type="checkbox"/>	100022	18,69	30	0,450



ENTRADA ORIENTABLE Y ANTIFRAUDE DN 13-15

DISPOSITIVO ANTIRRETORNO	SI	NO	REF.	EUROS	UNID. DE EMBALAJE	PESO UNID.
	<input checked="" type="checkbox"/>	<input type="checkbox"/>	101002	20,94	30	0,400

ENTRADA ORIENTABLE Y ANTIFRAUDE DN 20

DISPOSITIVO ANTIRRETORNO	SI	NO	REF.	EUROS	UNID. DE EMBALAJE	PESO UNID.
	<input checked="" type="checkbox"/>	<input type="checkbox"/>	101012	26,49	30	0,450

INCLUIDO EL MANGUITO DE CONEXIÓN AL CONTADOR
FILTROS PARA VÁLVULAS BS PÁG. 36

Revisión A

VÁLVULAS ENTRADA SERIE BS PARA CONTADORES Ø 13, 15 Y 20



ENTRADA DN 13-15

DISPOSITIVO ANTIRRETORNO	SI	NO	REF.	EUROS	UNID. DE EMBALAJE	PESO UNID.
	<input checked="" type="checkbox"/>	<input type="checkbox"/>	102001	11,80	50	0,350

ENTRADA DN 20

DISPOSITIVO ANTIRRETORNO	SI	NO	REF.	EUROS	UNID. DE EMBALAJE	PESO UNID.
	<input checked="" type="checkbox"/>	<input type="checkbox"/>	102011	18,04	30	0,400

OPCIÓN DE MANETA DE LATÓN. CONSULTAR.



ENTRADA ANTIFRAUDE DN 13-15

DISPOSITIVO ANTIRRETORNO	SI	NO	REF.	EUROS	UNID. DE EMBALAJE	PESO UNID.
	<input checked="" type="checkbox"/>	<input type="checkbox"/>	102002	13,50	30	0,350

ENTRADA ANTIFRAUDE DN 20

DISPOSITIVO ANTIRRETORNO	SI	NO	REF.	EUROS	UNID. DE EMBALAJE	PESO UNID.
	<input checked="" type="checkbox"/>	<input type="checkbox"/>	102012	19,23	30	0,400

Revisión A



ENTRADA CON CONEXIÓN A P.E. EXT 25 DN 13-15

DISPOSITIVO ANTIRRETORNO	SI	NO	REF.	EUROS	UNID. DE EMBALAJE	PESO UNID.
	<input checked="" type="checkbox"/>	<input type="checkbox"/>	102003	16,12	50	0,500

ENTRADA CON CONEXIÓN A P.E. EXT 32 DN 20

DISPOSITIVO ANTIRRETORNO	SI	NO	REF.	EUROS	UNID. DE EMBALAJE	PESO UNID.
	<input checked="" type="checkbox"/>	<input type="checkbox"/>	102013	23,20	30	0,700

OPCIÓN DE MANETA DE LATÓN. CONSULTAR.



ENTRADA ANTIFRAUDE Y CONEXIÓN A P.E. EXT 25 DN 13-15

DISPOSITIVO ANTIRRETORNO	SI	NO	REF.	EUROS	UNID. DE EMBALAJE	PESO UNID.
	<input checked="" type="checkbox"/>	<input type="checkbox"/>	102004	18,50	50	0,350

ENTRADA ANTIFRAUDE Y CONEXIÓN A P.E. EXT 32 DN 20

DISPOSITIVO ANTIRRETORNO	SI	NO	REF.	EUROS	UNID. DE EMBALAJE	PESO UNID.
	<input checked="" type="checkbox"/>	<input type="checkbox"/>	102014	24,54	30	0,600

INCLUIDO EL MANGUITO DE CONEXIÓN AL CONTADOR
FILTROS PARA VÁLVULAS BS PÁG. 36

VÁLVULAS SALIDA SERIE BS PARA CONTADORES Ø 13, 15 Y 20



SALIDA DN 13-15

DISPOSITIVO ANTIRRETORNO	SI	NO	REF.	EUROS	UNID. DE EMBALAJE	PESO UNID.
	<input checked="" type="checkbox"/>	<input type="checkbox"/>	103001	10,90	50	0,300

SALIDA DN 20

DISPOSITIVO ANTIRRETORNO	SI	NO	REF.	EUROS	UNID. DE EMBALAJE	PESO UNID.
	<input checked="" type="checkbox"/>	<input type="checkbox"/>	103011	16,08	40	0,550

OPCIÓN DE MANETA DE LATÓN. CONSULTAR.



SALIDA DN 13-15

DISPOSITIVO ANTIRRETORNO	SI	NO	REF.	EUROS	UNID. DE EMBALAJE	PESO UNID.
	<input checked="" type="checkbox"/>	<input type="checkbox"/>	104001	12,42	50	0,350

SALIDA DN 20

DISPOSITIVO ANTIRRETORNO	SI	NO	REF.	EUROS	UNID. DE EMBALAJE	PESO UNID.
	<input checked="" type="checkbox"/>	<input type="checkbox"/>	104011	18,43	40	0,400

OPCIÓN DE MANETA DE LATÓN. CONSULTAR.



SALIDA CON PURGA DN 13-15

DISPOSITIVO ANTIRRETORNO	SI	NO	REF.	EUROS	UNID. DE EMBALAJE	PESO UNID.
	<input checked="" type="checkbox"/>	<input type="checkbox"/>	103006	18,50	40	0,550

SALIDA CON PURGA DN 20

DISPOSITIVO ANTIRRETORNO	SI	NO	REF.	EUROS	UNID. DE EMBALAJE	PESO UNID.
	<input checked="" type="checkbox"/>	<input type="checkbox"/>	103016	24,20	25	0,800

OPCIÓN DE MANETA DE LATÓN. CONSULTAR.



SALIDA ANTIFRAUDE DN 13-15

DISPOSITIVO ANTIRRETORNO	SI	NO	REF.	EUROS	UNID. DE EMBALAJE	PESO UNID.
	<input checked="" type="checkbox"/>	<input type="checkbox"/>	104002	12,53	50	0,300

SALIDA ANTIFRAUDE DN 20

DISPOSITIVO ANTIRRETORNO	SI	NO	REF.	EUROS	UNID. DE EMBALAJE	PESO UNID.
	<input checked="" type="checkbox"/>	<input type="checkbox"/>	104012	18,30	40	0,550

INCLUIDO EL MANGUITO DE CONEXIÓN AL CONTADOR

Revisión A

VÁLVULAS SALIDA SERIE BS PARA CONTADORES Ø 13, 15 Y 20



SALIDA AUTOMÁTICA DN 13-15

	REF.	EUROS	UNID. DE EMBALAJE	PESO UNID.
DISPOSITIVO ANTIRRETORNO <input checked="" type="checkbox"/> SI <input type="checkbox"/> NO	104022	8,49	50	0,300



SALIDA CON CONEXIÓN A P-E Ø EXT 25 DN 13-15

	REF.	EUROS	UNID. DE EMBALAJE	PESO UNID.
DISPOSITIVO ANTIRRETORNO <input checked="" type="checkbox"/> SI <input type="checkbox"/> NO	104003	17,99	50	0,500

SALIDA CON CONEXIÓN A P-E Ø EXT 32 DN 20

	REF.	EUROS	UNID. DE EMBALAJE	PESO UNID.
DISPOSITIVO ANTIRRETORNO <input checked="" type="checkbox"/> SI <input type="checkbox"/> NO	104013	24,78	30	0,700

OPCIÓN DE MANETA DE LATÓN. CONSULTAR.



SALIDA CON PURGA Y CONEXIÓN A P-E Ø EXT 25 DN 13-15

	REF.	EUROS	UNID. DE EMBALAJE	PESO UNID.
DISPOSITIVO ANTIRRETORNO <input checked="" type="checkbox"/> SI <input type="checkbox"/> NO	103005	20,00	25	0,600

SALIDA CON PURGA CONEXIÓN A P-E Ø EXT 32 DN 20

	REF.	EUROS	UNID. DE EMBALAJE	PESO UNID.
DISPOSITIVO ANTIRRETORNO <input checked="" type="checkbox"/> SI <input type="checkbox"/> NO	103015	24,45	15	0,800

OPCIÓN DE MANETA DE LATÓN. CONSULTAR.



SALIDA CON PURGA Y CONEXIÓN A P-E Ø EXT 25 DN 13-15

	REF.	EUROS	UNID. DE EMBALAJE	PESO UNID.
DISPOSITIVO ANTIRRETORNO <input checked="" type="checkbox"/> SI <input type="checkbox"/> NO	104005	26,50	25	0,500

SALIDA CON PURGA CONEXIÓN A P-E Ø EXT 32 DN 20

	REF.	EUROS	UNID. DE EMBALAJE	PESO UNID.
DISPOSITIVO ANTIRRETORNO <input checked="" type="checkbox"/> SI <input type="checkbox"/> NO	104015	35,36	12	0,800

OPCIÓN DE MANETA DE LATÓN. CONSULTAR.
INCLUIDO EL MANGUITO DE CONEXIÓN AL CONTADOR

Revisión A

VÁLVULAS SALIDA SERIE BS PARA CONTADORES Ø 13, 15 Y 20



SALIDA CON PURGA DN 15

DISPOSITIVO ANTIRRETORNO	SI	NO	REF.	EUROS	UNID. DE EMBALAJE	PESO UNID.
	<input checked="" type="checkbox"/>	<input type="checkbox"/>	104006	20,45	40	0,450

SALIDA CON PURGA DN 20

DISPOSITIVO ANTIRRETORNO	SI	NO	REF.	EUROS	UNID. DE EMBALAJE	PESO UNID.
	<input checked="" type="checkbox"/>	<input type="checkbox"/>	104016	27,01	20	0,850

OPCIÓN DE MANETA DE LATÓN. CONSULTAR.



SALIDA CON PURGA DN 20

DISPOSITIVO ANTIRRETORNO	SI	NO	REF.	EUROS	UNID. DE EMBALAJE	PESO UNID.
	<input checked="" type="checkbox"/>	<input type="checkbox"/>	104026	24,87	20	0,600

OPCIÓN DE MANETA DE LATÓN. CONSULTAR.
INCLUIDO EL MANGUITO DE CONEXIÓN AL CONTADOR

Revisión A

ACCESORIOS VÁLVULAS BS



MONTURA CON PISTONCILLO EPDM DN 13-15

REF.	EUROS	UNID. DE EMBALAJE	PESO UNID.
1029001	6,38	10	0,140

MONTURA CON PISTONCILLO EPDM DN 20

REF.	EUROS	UNID. DE EMBALAJE	PESO UNID.
1029003	9,49	10	0,225

OPCIÓN DE MANETA DE LATÓN. CONSULTAR.



MONTURA FIJA CON PORTASOLETA DN 13-15

REF.	EUROS	UNID. DE EMBALAJE	PESO UNID.
1029002	7,32	10	0,150

MONTURA FIJA CON PORTASOLETA DN 20

REF.	EUROS	UNID. DE EMBALAJE	PESO UNID.
1029005	10,15	10	0,235

OPCIÓN DE MANETA DE LATÓN. CONSULTAR.



PISTONCILLO NBR DN 13-15

REF.	EUROS	UNID. DE EMBALAJE	PESO UNID.
1025004	0,51	25	0,003

PISTONCILLO LATÓN CAUCHO DN 13-15

REF.	EUROS	UNID. DE EMBALAJE	PESO UNID.
1025053	2,35	25	0,012

PISTONCILLO LATÓN CAUCHO DN 20

REF.	EUROS	UNID. DE EMBALAJE	PESO UNID.
1025054	3,01	10	0,016



CUERPO PURGA PARA VÁLVULA SALIDA BATERÍA DN 20

REF.	EUROS	UNID. DE EMBALAJE	PESO UNID.
1020005	9,65	10	0,325



CUERPO PURGA PARA VÁLVULA SALIDA ACOMETIDA DN 13-15

REF.	EUROS	UNID. DE EMBALAJE	PESO UNID.
1020002	9,80	10	0,200

CUERPO PURGA PARA VÁLVULA SALIDA ACOMETIDA DN 20

REF.	EUROS	UNID. DE EMBALAJE	PESO UNID.
1020006	13,48	10	0,300

Revisión A

ACCESORIOS VÁLVULAS BS

MANGUITOS PARA VÁLVULAS DN-13-15 SERIE BS

CONEXIÓN A VÁLVULA 21,8 IZQUIERDAS



DN 15 - 1/2" (LL13)

REF.	EUROS	UNID. DE EMBALAJE	PESO UNID.
1021012	1,88	10	0,050

DN 15 - 3/4"

REF.	EUROS	UNID. DE EMBALAJE	PESO UNID.
1021034	1,90	10	0,060

DN 15 - 7/8"

REF.	EUROS	UNID. DE EMBALAJE	PESO UNID.
1021078	2,34	10	0,080

DN 15 - 1"

REF.	EUROS	UNID. DE EMBALAJE	PESO UNID.
1021100	2,64	10	0,080

INCLUIDA JUNTA EPDM

MANGUITOS PARA VÁLVULAS DN 20 SERIE BS

CONEXIÓN A VÁLVULA 7/8" IZQUIERDAS



DN 20 - 3/4"

REF.	EUROS	UNID. DE EMBALAJE	PESO UNID.
1022034	2,98	10	0,098

DN 20 - 7/8"

REF.	EUROS	UNID. DE EMBALAJE	PESO UNID.
1022078	3,08	10	0,095

DN 20 - 1"

REF.	EUROS	UNID. DE EMBALAJE	PESO UNID.
1022100	2,43	10	0,090

INCLUIDA JUNTA EPDM

MANGUITOS PARA VÁLVULAS DN 20 SERIE BT

CONEXIÓN A VÁLVULA 3/4" IZQUIERDAS

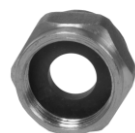

DN 20 - 3/4"

REF.	EUROS	UNID. DE EMBALAJE	PESO UNID.
1022118	1,90	10	0,090

DN 20 - 7/8"

REF.	EUROS	UNID. DE EMBALAJE	PESO UNID.
1022119	2,73	10	0,090

DN 20 - 1"

REF.	EUROS	UNID. DE EMBALAJE	PESO UNID.
1022120	2,64	10	0,090

INCLUIDA JUNTA EPDM

MANGUITOS PARA VÁLVULAS DN 20 SERIE BS

CONEXIÓN A VÁLVULA 1" IZQUIERDAS



DN 20 - 3/4"

REF.	EUROS	UNID. DE EMBALAJE	PESO UNID.
1022116	2,64	10	0,095

DN 20 - 7/8"

REF.	EUROS	UNID. DE EMBALAJE	PESO UNID.
1022117	2,64	10	0,085

DN 20 - 1"

REF.	EUROS	UNID. DE EMBALAJE	PESO UNID.
1022115	2,31	10	0,085

INCLUIDA JUNTA EPDM

ACCESORIOS VÁLVULAS SERIE BS



FILTRO PARA VÁLVULA DE ENTRADA DN 13-15

REF.	EUROS	UNID. DE EMBALAJE	PESO UNID.
01790001	10,28	10	0,200

FILTRO PARA VÁLVULA ENTRADA DN 20

REF.	EUROS	UNID. DE EMBALAJE	PESO UNID.
01790002	13,38	10	0,250



FILTRO PARA VÁLVULA DE ENTRADA DN 13-15 SALIDA ROSCA H 1/2"

REF.	EUROS	UNID. DE EMBALAJE	PESO UNID.
11790001	8,12	10	0,175

FILTRO PARA VÁLVULA ENTRADA DN 20 SALIDA ROSCA H 3/4"

REF.	EUROS	UNID. DE EMBALAJE	PESO UNID.
11790002	11,34	10	0,300

Revisión A

ACCESORIOS VÁLVULAS SERIE BS



JUNTA PLANA EPDM PARA VÁLVULA ENTRADA FIJA DN 15 BS

REF.	EUROS	UNID. DE EMBALAJE	PESO UNID.
1026110	0,50	25	0,012

JUNTA PLANA EPDM PARA VÁLVULA ENTRADA FIJA DN 20 BS

REF.	EUROS	UNID. DE EMBALAJE	PESO UNID.
1026111	0,53	25	0,014

JUNTA PLANA EPDM PARA VÁLVULA ENTRADA ORIENTABLE DN 15 BS

REF.	EUROS	UNID. DE EMBALAJE	PESO UNID.
1035110	0,27	25	0,014

JUNTA PLANA EPDM PARA VÁLVULA ENTRADA ORIENTABLE DN 20 BS

REF.	EUROS	UNID. DE EMBALAJE	PESO UNID.
1025110	0,35	25	0,014



JUNTA PLANA EPDM PARA MANGUITO DN 15-1/2" BS

REF.	EUROS	UNID. DE EMBALAJE	PESO UNID.
1025114	0,14	10	0,005

JUNTA PLANA EPDM PARA MANGUITO DN 15-3/4" BS

REF.	EUROS	UNID. DE EMBALAJE	PESO UNID.
1025111	0,17	10	0,007

JUNTA PLANA EPDM PARA MANGUITO DN 15-7/8" BS

REF.	EUROS	UNID. DE EMBALAJE	PESO UNID.
1025112	0,20	10	0,008

JUNTA PLANA EPDM PARA MANGUITO DN 15-1" BS

REF.	EUROS	UNID. DE EMBALAJE	PESO UNID.
1025113	0,27	10	0,008



JUNTA PLANA EPDM PARA MANGUITO DN 20-3/4" BS

REF.	EUROS	UNID. DE EMBALAJE	PESO UNID.
1025161	0,20	10	0,009

JUNTA PLANA EPDM PARA MANGUITO DN 20-7/8" BS

REF.	EUROS	UNID. DE EMBALAJE	PESO UNID.
1025162	0,20	10	0,011

JUNTA PLANA EPDM PARA MANGUITO DN 20-1" BS

REF.	EUROS	UNID. DE EMBALAJE	PESO UNID.
1025163	0,23	10	0,011

Revisión A

TORNILLERÍA

TORNILLO M-10x30 INOX C/T

REF.	EUROS	UNID. DE EMBALAJE	PESO UNID.
202019	0,79	10	0,020

TORNILLO M-10x20 ZINCADO

REF.	EUROS	UNID. DE EMBALAJE	PESO UNID.
202001	0,18	10	0,015

TORNILLO M-10x30 ZINCADO

REF.	EUROS	UNID. DE EMBALAJE	PESO UNID.
202003	0,19	10	0,020

TORNILLO M-10x35 ZINCADO C/T

REF.	EUROS	UNID. DE EMBALAJE	PESO UNID.
202005	0,27	10	0,025



TORNILLO M-10x20 ZINCADO C/BASE

REF.	EUROS	UNID. DE EMBALAJE	PESO UNID.
202021	0,50	10	0,010

TORNILLO M-10x25 ZINCADO C/BASE

REF.	EUROS	UNID. DE EMBALAJE	PESO UNID.
202020	0,54	10	0,010

TORNILLO M-12x20 ZINCADO C/BASE

REF.	EUROS	UNID. DE EMBALAJE	PESO UNID.
202050	0,59	10	0,015

TORNILLO M-12x25 ZINCADO C/BASE

REF.	EUROS	UNID. DE EMBALAJE	PESO UNID.
202075	0,60	10	0,015

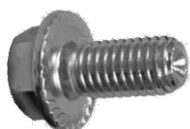

Revisión A

VÁLVULAS ESFERA

SERIE BT

Revisión A
21/09



Revisión A

ÍNDICE

PAG. 41-43..... VÁLVULAS SERIE BT

PAG. 44-45..... VÁLVULAS LINEALES CON SISTEMA ANTIFRAUDE MAGNÉTICO

PAG. 46..... VÁLVULAS H-H PN25 EQUIPADAS CON DISPOSITIVO ANTIFRAUDE

PAG. 47..... VÁLVULAS H-H PN40 EQUIPADAS CON DISPOSITIVO ANTIFRAUDE

PAG. 48..... ADAPTADORES PARA SISTEMA DE BLOQUEO MAGNÉTICO

PAG. 49-52..... ESPECIFICACIONES TÉCNICAS DE TAPÓN Y LLAVE ANTIFRAUDE

Revisión A

VÁLVULAS ENTRADA SERIE BT CON SISTEMA ANTIFRAUDE MAGNÉTICO
PARA CONTADORES DN 13, 15 Y 20mm.



ENTRADA ORIENTABLE DN 20 MANGUITO 3/4" – 7/8" – 1"

DISPOSITIVO ANTIRRETORNO	SI	NO	REF.	EUROS	UNID. DE EMBALAJE	PESO UNID.
	<input type="checkbox"/>	<input checked="" type="checkbox"/>	BT101011	21,50	32	0,550

OPCIÓN DE MANETA DE LATÓN. CONSULTAR



ENTRADA ORIENTABLE CON TAPÓN ANTIFRAUDE PARA CONTADOR DN 20 MANGUITO 3/4" – 7/8" – 1"

DISPOSITIVO ANTIRRETORNO	SI	NO	REF.	EUROS	UNID. DE EMBALAJE	PESO UNID.
	<input type="checkbox"/>	<input checked="" type="checkbox"/>	BT101111	22,60	32	0,500



ENTRADA ROSCADA 3/4" DN 13-15 RACOR 7/8"-3/4"

DISPOSITIVO ANTIRRETORNO	SI	NO	REF.	EUROS	UNID. DE EMBALAJE	PESO UNID.
	<input type="checkbox"/>	<input checked="" type="checkbox"/>	BT104113	18,47	32	0,450

ENTRADA ROSCADA 1" DN 20 RACOR 1"

DISPOSITIVO ANTIRRETORNO	SI	NO	REF.	EUROS	UNID. DE EMBALAJE	PESO UNID.
	<input type="checkbox"/>	<input checked="" type="checkbox"/>	BT104112	19,50	32	0,550

OPCIÓN DE MANETA DE LATÓN. CONSULTAR



ENTRADA ROSCADA 3/4" CON TAPÓN ANTIFRAUDE PARA CONTADOR DN 13-15 RACOR 7/8"-3/4"

DISPOSITIVO ANTIRRETORNO	SI	NO	REF.	EUROS	UNID. DE EMBALAJE	PESO UNID.
	<input type="checkbox"/>	<input checked="" type="checkbox"/>	BT104123	19,34	32	0,350

ENTRADA ROSCADA 1" CON TAPÓN ANTIFRAUDE PARA CONTADOR DN 20 RACOR 1"

DISPOSITIVO ANTIRRETORNO	SI	NO	REF.	EUROS	UNID. DE EMBALAJE	PESO UNID.
	<input type="checkbox"/>	<input checked="" type="checkbox"/>	BT104122	19,76	32	0,508

DISPUESTAS CON BLOQUEO DE VOLANTE PARA POSICIÓN DE MÍNIMO VITAL CON SISTEMA DE SEGURIDAD

INCLUIDOS MANGUITOS Y RACORES DE CONEXIÓN AL CONTADOR

Revisión A

VÁLVULAS ENTRADA SERIE BT CON SISTEMA ANTIFRAUDE MAGNÉTICO PARA CONTADORES DN 13, 15 Y 20 mm.



ENTRADA ROSCADA 1" PARA CONTADOR DN 13-15 RACOR 7/8"-3/4"

DISPOSITIVO ANTIRRETORNO	SI	NO	REF.	EUROS	UNID. DE EMBALAJE	PESO UNID.
	<input type="checkbox"/>	<input checked="" type="checkbox"/>	BT104011	20,89	32	0,460

OPCIÓN DE MANETA DE LATÓN. CONSULTAR



ENTRADA ROSCADA 1" CON TAPÓN ANTIFRAUDE PARA CONTADOR DN 13-15 RACOR 7/8"-3/4"

DISPOSITIVO ANTIRRETORNO	SI	NO	REF.	EUROS	UNID. DE EMBALAJE	PESO UNID.
	<input type="checkbox"/>	<input checked="" type="checkbox"/>	BT104015	21,29	32	0,360



ENTRADA CON CONEXIÓN A P.E. ØEXT 25 PARA CONTADOR DN 13-15

DISPOSITIVO ANTIRRETORNO	SI	NO	REF.	EUROS	UNID. DE EMBALAJE	PESO UNID.
	<input type="checkbox"/>	<input checked="" type="checkbox"/>	BT104813	23,75	32	0,628

ENTRADA CON CONEXIÓN A P.E. ØEXT 32 PARA CONTADOR DN 20

DISPOSITIVO ANTIRRETORNO	SI	NO	REF.	EUROS	UNID. DE EMBALAJE	PESO UNID.
	<input type="checkbox"/>	<input checked="" type="checkbox"/>	BT104811	26,79	32	0,754

OPCIÓN DE MANETA DE LATÓN. CONSULTAR



ENTRADA CON CONEXIÓN A P.E. ØEXT 25 CON TAPÓN ANTIFRAUDE PARA CONTADOR DN 13-15 RACOR 7/8"-3/4"

DISPOSITIVO ANTIRRETORNO	SI	NO	REF.	EUROS	UNID. DE EMBALAJE	PESO UNID.
	<input type="checkbox"/>	<input checked="" type="checkbox"/>	BT104814	23,71	32	0,581

ENTRADA CON CONEXIÓN A P.E. ØEXT 32 CON TAPÓN ANTIFRAUDE PARA CONTADOR DN 20 RACOR 1"

DISPOSITIVO ANTIRRETORNO	SI	NO	REF.	EUROS	UNID. DE EMBALAJE	PESO UNID.
	<input type="checkbox"/>	<input checked="" type="checkbox"/>	BT104812	28,44	32	0,707

DISPUESTAS CON BLOQUEO DE VOLANTE PARA POSICIÓN DE MÍNIMO VITAL CON SISTEMA DE SEGURIDAD

INCLUIDOS RACORES DE CONEXIÓN AL CONTADOR

Revisión A

VÁLVULAS SALIDA SERIE BT PARA CONTADORES DN 13, 15 Y 20 mm.
CON ANTIRRETORNO Y PURGA INCORPORADA



SALIDA BATERÍA PARA CONTADOR DN 20 MANGUITO 3/4" - 1"

DISPOSITIVO ANTIRRETORNO	SI	NO	REF.	EUROS	UNID. DE EMBALAJE	PESO UNID.
	<input checked="" type="checkbox"/>	<input type="checkbox"/>	BT102011	19,24	32	0,500

OPCIÓN DE MANETA DE LATÓN. CONSULTAR



SALIDA ROSCADA 3/4" PARA CONTADOR DN 13-15 RACOR 3/4"

DISPOSITIVO ANTIRRETORNO	SI	NO	REF.	EUROS	UNID. DE EMBALAJE	PESO UNID.
	<input checked="" type="checkbox"/>	<input type="checkbox"/>	BT105001	20,29	32	0,450

SALIDA ROSCADA 1" PARA CONTADOR DN 20 RACOR 1"

DISPOSITIVO ANTIRRETORNO	SI	NO	REF.	EUROS	UNID. DE EMBALAJE	PESO UNID.
	<input checked="" type="checkbox"/>	<input type="checkbox"/>	BT105101	20,90	32	0,595

OPCIÓN DE MANETA DE LATÓN. CONSULTAR



SALIDA ROSCADA 1" PARA CONTADOR DN 13-15 RACOR 3/4"

DISPOSITIVO ANTIRRETORNO	SI	NO	REF.	EUROS	UNID. DE EMBALAJE	PESO UNID.
	<input checked="" type="checkbox"/>	<input type="checkbox"/>	BT105501	23,46	32	0,350

OPCIÓN DE MANETA DE LATÓN. CONSULTAR



SALIDA CON CONEXIÓN A P.E. ØEXT 25 PARA CONTADOR DN 13-15

DISPOSITIVO ANTIRRETORNO	SI	NO	REF.	EUROS	UNID. DE EMBALAJE	PESO UNID.
	<input checked="" type="checkbox"/>	<input type="checkbox"/>	BT105801	25,27	32	0,663

SALIDA CON CONEXIÓN A P.E. ØEXT 32 PARA CONTADOR DN 20

DISPOSITIVO ANTIRRETORNO	SI	NO	REF.	EUROS	UNID. DE EMBALAJE	PESO UNID.
	<input checked="" type="checkbox"/>	<input type="checkbox"/>	BT105811	30,09	32	0,794

DISPUESTAS CON BLOQUEO DE VOLANTE PARA POSICIÓN DE MÍNIMO VITAL CON SISTEMA DE SEGURIDAD

OPCIÓN DE MANETA DE LATÓN. CONSULTAR
INCLUIDOS MANGUITOS Y RACORES DE CONEXIÓN AL CONTADOR

Revisión A

VÁLVULAS LINEALES H SERIE BT PN25 CON SISTEMA ANTIFRAUDE MAGNÉTICO

VÁLVULA H-H 1/2" DN15

REF.	EUROS	UNID. DE EMBALAJE	PESO UNID.
BT106001	7,43	50	0,233

VÁLVULA H-H 3/4" DN20

REF.	EUROS	UNID. DE EMBALAJE	PESO UNID.
BT106201	8,88	50	0,319

VÁLVULA H-H 1" DN25

REF.	EUROS	UNID. DE EMBALAJE	PESO UNID.
BT106401	14,71	50	0,454

VÁLVULA H-H 1/2" DN15 CON TAPÓN DE BLOQUEO MAGNÉTICO

REF.	EUROS	UNID. DE EMBALAJE	PESO UNID.
BT106101	8,46	50	0,232

VÁLVULA H-H 3/4" DN20 CON TAPÓN DE BLOQUEO MAGNÉTICO BLOQUEO

REF.	EUROS	UNID. DE EMBALAJE	PESO UNID.
BT106301	9,93	50	0,316

VÁLVULA H-H 1" DN25 CON TAPÓN DE BLOQUEO MAGNÉTICO

REF.	EUROS	UNID. DE EMBALAJE	PESO UNID.
BT106501	15,76	50	0,408

VÁLVULA H 1/2" DN15 CON RACOR DE CONEXIÓN 3/4"-7/8"

REF.	EUROS	UNID. DE EMBALAJE	PESO UNID.
BT106002	11,42	50	0,285

VÁLVULA H 3/4" DN20 CON RACOR DE CONEXIÓN 3/4"-7/8"-1"

REF.	EUROS	UNID. DE EMBALAJE	PESO UNID.
BT106202	13,31	50	0,420

VÁLVULA H 1" DN25 CON RACOR DE CONEXIÓN 1 1/4"

REF.	EUROS	UNID. DE EMBALAJE	PESO UNID.
BT106402	22,95	50	0,650

VÁLVULA H 1/2" DN15 RACOR DE CONEXIÓN 3/4"-7/8" Y TAPÓN DE BLOQUEO MAGNÉTICO

REF.	EUROS	UNID. DE EMBALAJE	PESO UNID.
BT106102	11,02	50	0,245

VÁLVULA H 3/4" DN20 RACOR DE CONEXIÓN 3/4"-7/8"-1" Y TAPÓN DE BLOQUEO MAGNÉTICO

REF.	EUROS	UNID. DE EMBALAJE	PESO UNID.
BT106302	14,73	50	0,416

VÁLVULA H 1" DN25 RACOR DE CONEXIÓN 1 1/4" Y TAPÓN DE BLOQUEO MAGNÉTICO

REF.	EUROS	UNID. DE EMBALAJE	PESO UNID.
BT106502	23,90	50	0,646

DISPUESTAS CON BLOQUEO DE VOLANTE PARA POSICIÓN DE MÍNIMO VITAL CON SISTEMA DE SEGURIDAD

VÁLVULAS LINEALES SERIE BT PN25 CON CUADRADILLO 30x30 Y SISTEMA ANTIFRAUDE MAGNÉTICO



VÁLVULA H-H 1/2" DN15

REF.	EUROS	UNID. DE EMBALAJE	PESO UNID.
BT107401	11,70	50	0,300

VÁLVULA H-H 3/4" DN20

REF.	EUROS	UNID. DE EMBALAJE	PESO UNID.
BT107402	13,02	50	0,380

VÁLVULA H-H 1" DN25

REF.	EUROS	UNID. DE EMBALAJE	PESO UNID.
BT107403	19,08	50	0,505

VÁLVULAS LINEALES PN25 CON SISTEMA DE CORTE ANTIFRAUDE MAGNÉTICO



VÁLVULA H-H 1/2" DN15

REF.	EUROS	UNID. DE EMBALAJE	PESO UNID.
BTM106401	7,79	50	0,167

VÁLVULA H-H 3/4" DN20

REF.	EUROS	UNID. DE EMBALAJE	PESO UNID.
BTM106402	11,18	50	0,239

VÁLVULA H-H 1" DN25

REF.	EUROS	UNID. DE EMBALAJE	PESO UNID.
BTM106403	15,25	50	0,324

VÁLVULA H-H 1 1/4" DN30

REF.	EUROS	UNID. DE EMBALAJE	PESO UNID.
BTM106404	25,97	50	0,510

VÁLVULA H-H 1 1/2" DN40

REF.	EUROS	UNID. DE EMBALAJE	PESO UNID.
BTM106405	39,65	50	0,758

VÁLVULA H-H 2" DN50

REF.	EUROS	UNID. DE EMBALAJE	PESO UNID.
BTM106406	60,30	50	1,227

Revisión A

VÁLVULAS LINEALES PN25 H ADAPTABLES AL SISTEMA ANTIFRAUDE MAGNÉTICO



* Hasta fin de existencias

VÁLVULA H-H 1" PN25

DISPOSITIVO ANTIRRETORNO	SI	NO	REF.	EUROS	UNID. DE EMBALAJE	PESO UNID.
	<input type="checkbox"/>	<input checked="" type="checkbox"/>	118300-1" (*)	12,84	30	0,368

VÁLVULA H-H 1 1/4" PN25

DISPOSITIVO ANTIRRETORNO	SI	NO	REF.	EUROS	UNID. DE EMBALAJE	PESO UNID.
	<input type="checkbox"/>	<input checked="" type="checkbox"/>	118300-11/4" (*)	19,68	30	0,575

VÁLVULA H-H 1 1/2" PN25

DISPOSITIVO ANTIRRETORNO	SI	NO	REF.	EUROS	UNID. DE EMBALAJE	PESO UNID.
	<input type="checkbox"/>	<input checked="" type="checkbox"/>	118300-11/2" (*)	28,41	20	0,781

VÁLVULA H-H 2" PN25

DISPOSITIVO ANTIRRETORNO	SI	NO	REF.	EUROS	UNID. DE EMBALAJE	PESO UNID.
	<input type="checkbox"/>	<input checked="" type="checkbox"/>	118300-2" (*)	45,03	10	1,323



LLAVE PARA DESBLOQUEO TORNILLO ANTIFRAUDE

REF.	EUROS	UNID. DE EMBALAJE	PESO UNID.
BTR101092	3,05	1	0,021



TAPÓN ANTIFRAUDE

REF.	EUROS	UNID. DE EMBALAJE	PESO UNID.
BTR101090	2,41	1	0,033



LLAVE PARA DESBLOQUEO EXCLUSIVA PARA COMPAÑÍAS DE AGUA

REF.	EUROS	UNID. DE EMBALAJE	PESO UNID.
BTR101091	5,00	1	0,023



TORNILLO ANTIFRAUDE

MODELO	REF.	EUROS	UNID. DE EMBALAJE	PESO UNID.
M4x16	BTR101098	0,51	100	0,002
M5x16	BTR101099	0,74	100	0,002

Revisión A

SISTEMA ADAPTABLE A TODOS LOS MODELOS DE VÁLVULAS DEL MERCADO

**VÁLVULA ESTANDAR CON
DISPOSITIVO DE CIERRE MANUAL**



**VÁLVULA CON ADAPTADOR
PARA TAPÓN ANTIFRAUDE**



SISTEMA PATENTADO

**LLAVE PARA DESBLOQUEO EXCLUSIVO
PARA COMPAÑÍAS DE AGUAS**



**VÁLVULA CON TAPÓN ANTIFRAUDE
Y LLAVE MAGNÉTICA PARA EL
DESBLOQUEO DEL TAPÓN ANTIFRAUDE**

**VÁLVULA CON TAPÓN
ANTIFRAUDE**



**VÁLVULAS DE BOLA CON SISTEMA ANTIFRAUDE, CON BLOQUEO DE LA VÁLVULA
MEDIANTE SISTEMA MAGNÉTICO**

EL ÚNICO SISTEMA ANTIFRAUDE A NIVEL MUNDIAL QUE SE PUEDE ADAPTAR A CUALQUIER MODELO DE VÁLVULA DEL MERCADO, MEDIANTE ADAPTADORES PARA CADA MODELO.

LLAVE PARA DESBLOQUEO
EXCLUSIVO PARA COMPAÑÍAS DE AGUAS



SISTEMA PATENTADO

TAPÓN ANTIFRAUDE



VÁLVULA CON DISPOSITIVO DE TRANSFORMACIÓN DISPONIBLE PARA TODOS LOS MODELOS DE VÁLVULAS DE CUALQUIER FABRICANTE

VÁLVULA CON EL ADAPTADOR INCORPORADO

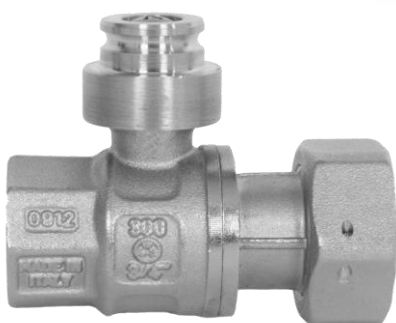

Revisión A

LLAVE DE DESBLOQUEO EXCLUSIVO PARA COMPAÑÍAS DE AGUAS

**VÁLVULA ESTANDAR
MONTADA CON VOLANTE**



**VÁLVULA SIN DISPOSITIVO
DE TRANSFORMACIÓN**



SISTEMA PATENTADO

**VÁLVULA CON DISPOSITIVO DE
TRANSFORMACIÓN INSTALADO**



**DETALLE DE POSICIONAMIENTO
DEL DISPOSITIVO DE TRANSFORMACIÓN**

**LLAVE DE DESBLOQUEO EXCLUSIVO
PARA COMPAÑÍAS DE AGUAS**



**DETALLE DE POSICIONAMIENTO
DEL TAPÓN ANTIFRAUDE**



**VÁLVULA MONTADA CON TAPÓN
ANTIFRAUDE Y LLAVE MAGNETICA PARA
EL DESBLOQUEO DEL TAPÓN ANTIFRAUDE**



Revisión A

INSTRUCCIONES PARA EL BLOQUEO Y DESBLOQUEO DE LA VÁLVULA DE ESFERA ANTIFRAUDE DN20 REF. BT101011 Y BT102011**BLOQUEO DEL TAPÓN ANTIFRAUDE REF. BTR101090.**

1. Desmontar el volante de la válvula aflojando el tornillo de cabeza en cruz situado encima de este.
2. Introducir el tapón Antifraude en la parte superior de la válvula hasta que este quede bloqueado.
3. Si el tapón Antifraude se bloquea manualmente fuera de la válvula, habrá que desbloquearlo mediante la llave de condensa **REF. BTR101091** y se procede de la siguiente forma; se sitúa la letra **B** del tapón Antifraude **REF. BTR101090** y la letra **B** de la llave de condensa de manera que coincidan las dos, a continuación se oprime hacia dentro el sistema de bloqueo y al soltar debe quedar desbloqueado el tapón Antifraude.

**Llave de condensa
Ref. BTR101091****DESBLOQUEO DEL TAPÓN ANTIFRAUDE REF. BTR101090.**

1. Se posiciona la llave de condensa **REF. BTR101091** encima del tapón Antifraude **REF. BTR101090** de manera que coincida la letra **B** de la llave de condensa con la letra **B** del tapón Antifraude, a continuación presionar hacia abajo y el tapón Antifraude quedará desbloqueado.

**Tapón Antifraude
Ref. BTR101090****INFORMACIÓN TÉCNICA:**

El desbloqueo del tapón Antifraude se consigue a través del campo magnético que genera la llave de condensa, la cual dispone de unos imanes situados estratégicamente en el interior de la llave de condensa, que activa el sistema de bloqueo del tapón para conseguir el desbloqueo de este, siendo imposible poder abrir el sistema de bloqueo de otra forma.

SISTEMA PATENTADO

Revisión A

VÁLVULAS ESFERA

SERIE BS

Revisión A
21/09



Revisión A

ÍNDICE

PAG. 55-60..... VÁLVULAS SERIE ESFERA

PAG. 51-62..... ACCESORIOS VÁLVULAS SERIE ESFERA

PAG. 63-64..... VÁLVULAS DE BOLA RECTAS EN PVC



Revisión A

VÁLVULAS ENTRADA PARA CONTADORES Ø 13, 15 Y 20

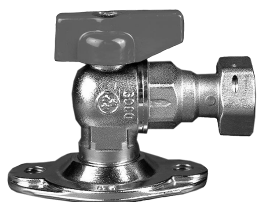

ENTRADA ORIENTABLE DN 15 RACOR 3/4"-7/8"

DISPOSITIVO ANTIRRETORNO	SI	NO	REF.	EUROS	UNID. DE EMBALAJE	PESO UNID.
	<input type="checkbox"/>	<input checked="" type="checkbox"/>	111001	16,55	50	0,400



ENTRADA ORIENTABLE Y ANTIFRAUDE DN 15 RACOR 3/4"-7/8"

DISPOSITIVO ANTIRRETORNO	SI	NO	REF.	EUROS	UNID. DE EMBALAJE	PESO UNID.
	<input type="checkbox"/>	<input checked="" type="checkbox"/>	111122	24,52	40	0,425



ENTRADA ORIENTABLE DN 15 RACOR 3/4"-7/8"

DISPOSITIVO ANTIRRETORNO	SI	NO	REF.	EUROS	UNID. DE EMBALAJE	PESO UNID.
	<input type="checkbox"/>	<input checked="" type="checkbox"/>	111004	19,88	50	0,375

ENTRADA ORIENTABLE Y ANTIFRAUDE DN 20 RACOR 1"

DISPOSITIVO ANTIRRETORNO	SI	NO	REF.	EUROS	UNID. DE EMBALAJE	PESO UNID.
	<input type="checkbox"/>	<input checked="" type="checkbox"/>	111044	20,01	40	0,500

Revisión A

VÁLVULAS ENTRADA PARA CONTADORES Ø 13, 15 Y 20



ENTRADA DN 15 M-3/4\"

DISPOSITIVO ANTIRRETORNO	SI	NO	REF.	EUROS	UNID. DE EMBALAJE	PESO UNID.
	<input type="checkbox"/>	<input checked="" type="checkbox"/>	112001	11,97	50	0,230



ENTRADA DN 15 M-3/4\"

DISPOSITIVO ANTIRRETORNO	SI	NO	REF.	EUROS	UNID. DE EMBALAJE	PESO UNID.
	<input type="checkbox"/>	<input checked="" type="checkbox"/>	112002	12,64	50	0,235



ENTRADA CON DISPOSITIVO ANTIFRAUDE DN 15 M-3/4\"

DISPOSITIVO ANTIRRETORNO	SI	NO	REF.	EUROS	UNID. DE EMBALAJE	PESO UNID.
	<input type="checkbox"/>	<input checked="" type="checkbox"/>	111200	18,07	50	0,235



MACHO 3/4\"

DISPOSITIVO ANTIRRETORNO	SI	NO	REF.	EUROS	UNID. DE EMBALAJE	PESO UNID.
	<input type="checkbox"/>	<input checked="" type="checkbox"/>	115001	5,93	50	0,200

RACORES INCLUIDOS EXCEPTO REF.115001

FILTROS PARA VÁLVULAS ESFERA PÁG. 59

Revisión A

VÁLVULAS ENTRADA PARA CONTADORES Ø 13, 15 Y 20



ENTRADA DN 15 CON CONEXIÓN A P-E Ø EXT 25 RACOR 3/4"

DISPOSITIVO ANTIRRETORNO	SI	NO	REF.	EUROS	UNID. DE EMBALAJE	PESO UNID.
	<input type="checkbox"/>	<input checked="" type="checkbox"/>	112003	12,88	50	0,375

* Hasta fin de existencias



ENTRADA DN 15 CON DISPOSITIVO ANTIFRAUDE Y CONEXIÓN A P-E Ø EXT 25 RACOR 3/4"

DISPOSITIVO ANTIRRETORNO	SI	NO	REF.	EUROS	UNID. DE EMBALAJE	PESO UNID.
	<input type="checkbox"/>	<input checked="" type="checkbox"/>	112020	24,65	40	0,235

* Hasta fin de existencias



ENTRADA DN 15 H 1/2" RACOR 3/4"

DISPOSITIVO ANTIRRETORNO	SI	NO	REF.	EUROS	UNID. DE EMBALAJE	PESO UNID.
	<input type="checkbox"/>	<input checked="" type="checkbox"/>	115201	8,99	50	0,150

ENTRADA DN 20 H 3/4" RACOR 3/4"

DISPOSITIVO ANTIRRETORNO	SI	NO	REF.	EUROS	UNID. DE EMBALAJE	PESO UNID.
	<input type="checkbox"/>	<input checked="" type="checkbox"/>	115202-3/4"	12,63	50	0,260

ENTRADA DN 20 H 3/4" RACOR 7/8"

DISPOSITIVO ANTIRRETORNO	SI	NO	REF.	EUROS	UNID. DE EMBALAJE	PESO UNID.
	<input type="checkbox"/>	<input checked="" type="checkbox"/>	115202-7/8"	13,93	50	0,260

ENTRADA DN 20 H 3/4" RACOR 1"

DISPOSITIVO ANTIRRETORNO	SI	NO	REF.	EUROS	UNID. DE EMBALAJE	PESO UNID.
	<input type="checkbox"/>	<input checked="" type="checkbox"/>	115203	13,38	50	0,275

INCLUIDOS RACORES DE CONEXIÓN AL CONTADOR

FILTROS PARA VÁLVULAS ESFERA PÁG. 59

Revisión A

VÁLVULAS ENTRADA PARA CONTADORES Ø 13, 15 Y 20

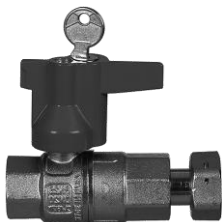

ENTRADA DN 15 CON DISPOSITIVO ANTIFRAUDE H 1/2" RACOR 3/4"-7/8"

DISPOSITIVO ANTIRRETORNO	SI	NO	REF.	EUROS	UNID. DE EMBALAJE	PESO UNID.
	<input checked="" type="checkbox"/>	<input type="checkbox"/>	114020	25,61	50	0,155

ENTRADA DN 20 CON DISPOSITIVO ANTIFRAUDE H 3/4" RACOR 1"

DISPOSITIVO ANTIRRETORNO	SI	NO	REF.	EUROS	UNID. DE EMBALAJE	PESO UNID.
	<input checked="" type="checkbox"/>	<input type="checkbox"/>	114040	31,64	50	0,280



ENTRADA DN 15 H 1/2" RACOR 3/4"

DISPOSITIVO ANTIRRETORNO	SI	NO	REF.	EUROS	UNID. DE EMBALAJE	PESO UNID.
	<input checked="" type="checkbox"/>	<input type="checkbox"/>	116001-3/4"	13,33	50	0,225

ENTRADA DN 15 H 1/2" RACOR 7/8"

DISPOSITIVO ANTIRRETORNO	SI	NO	REF.	EUROS	UNID. DE EMBALAJE	PESO UNID.
	<input checked="" type="checkbox"/>	<input type="checkbox"/>	116001-7/8"	14,09	50	0,225

ENTRADA DN 20 H 3/4" RACOR 1"

DISPOSITIVO ANTIRRETORNO	SI	NO	REF.	EUROS	UNID. DE EMBALAJE	PESO UNID.
	<input checked="" type="checkbox"/>	<input type="checkbox"/>	116011	19,68	50	0,425



ENTRADA DN 15 CON RACOR TELESCÓPICO H-1/2" RACOR 3/4"

DISPOSITIVO ANTIRRETORNO	SI	NO	REF.	EUROS	UNID. DE EMBALAJE	PESO UNID.
	<input type="checkbox"/>	<input checked="" type="checkbox"/>	115301	14,12	50	0,260

ENTRADA DN 20 CON RACOR TELESCÓPICO H-3/4" RACOR 1"

DISPOSITIVO ANTIRRETORNO	SI	NO	REF.	EUROS	UNID. DE EMBALAJE	PESO UNID.
	<input type="checkbox"/>	<input checked="" type="checkbox"/>	115302	17,46	30	0,400

*Hasta fin de existencias

INCLUIDOS RACORES DE CONEXIÓN AL CONTADOR

FILTROS PARA VÁLVULAS ESFERA PÁG. 59

Revisión A

VÁLVULAS SALIDA PARA CONTADORES Ø 13, 15 Y 20



SALIDA DN 15 CON PURGA Y RACOR 3/4"

	REF.	EUROS	UNID. DE EMBALAJE	PESO UNID.
DISPOSITIVO ANTIRRETORNO <input checked="" type="checkbox"/> SI <input type="checkbox"/> NO	113009	13,35	50	0,240



SALIDA DN 15 CON PURGA Y CONEXIÓN A P-E Ø EXT 25 RACOR 3/4"

	REF.	EUROS	UNID. DE EMBALAJE	PESO UNID.
DISPOSITIVO ANTIRRETORNO <input checked="" type="checkbox"/> SI <input type="checkbox"/> NO	113007	16,69	50	0,375

INCLUIDOS RACORES DE CONEXIÓN AL CONTADOR

FILTROS PARA VÁLVULAS ESFERA PÁG. 59

VÁLVULAS SALIDA PARA CONTADORES Ø 13, 15 Y 20



SALIDA DN 15 H-1/2" RACOR 3/4"

DISPOSITIVO ANTIRRETORNO	SI	NO	REF.	EUROS	UNID. DE EMBALAJE	PESO UNID.
	<input checked="" type="checkbox"/>	<input type="checkbox"/>	117001	10,05	50	0,225

SALIDA DN 20 H-3/4" RACOR 3/4"

DISPOSITIVO ANTIRRETORNO	SI	NO	REF.	EUROS	UNID. DE EMBALAJE	PESO UNID.
	<input checked="" type="checkbox"/>	<input type="checkbox"/>	117111	15,35	50	0,415

SALIDA DN 20 H-3/4" RACOR 1" (*)

DISPOSITIVO ANTIRRETORNO	SI	NO	REF.	EUROS	UNID. DE EMBALAJE	PESO UNID.
	<input checked="" type="checkbox"/>	<input type="checkbox"/>	117011	19,84	50	0,425

*Hasta fin de existencias

INCLUIDOS RACORES DE CONEXIÓN AL CONTADOR

FILTROS PARA VÁLVULAS ESFERA PÁG. 59

Revisión A



ACCESORIOS VÁLVULAS ESFERA

TUERCA RACOR 3/4" CON JUNTA

REF.	EUROS	UNID. DE EMBALAJE	PESO UNID.
1031034	1,90	10	0,033

TUERCA RACOR 7/8" CON JUNTA

REF.	EUROS	UNID. DE EMBALAJE	PESO UNID.
1031078	2,02	10	0,042

FILTRO PARA VÁLVULA DE ESFERA DN 15 M-3/4" RACOR 3/4"-7/8"

REF.	EUROS	UNID. DE EMBALAJE	PESO UNID.
02790001	12,65	15	0,210

FILTRO PARA VÁLVULA DE ESFERA DN 20 M-1" RACOR 1"

REF.	EUROS	UNID. DE EMBALAJE	PESO UNID.
02790002	14,40	6	0,250

ACCESORIOS VÁLVULAS ESFERA



JUNTA PLANA EPDM 3/4" PARA RACOR VÁLVULA ESFERA DN 15

REF.	EUROS	UNID. DE EMBALAJE	PESO UNID.
1035111	0,18	25	0,012

JUNTA PLANA EPDM 7/8" PARA RACOR VÁLVULA ESFERA DN 15

REF.	EUROS	UNID. DE EMBALAJE	PESO UNID.
1035112	0,21	25	0,014

JUNTA PLANA EPDM 1" PARA RACOR VÁLVULA ESFERA DN 20

REF.	EUROS	UNID. DE EMBALAJE	PESO UNID.
1035161	0,24	25	0,015



JUNTA PLANA EPDM PARA BRIDA ORIENTABLE DN 15

REF.	EUROS	UNID. DE EMBALAJE	PESO UNID.
1035110	0,27	25	0,018



CONJUNTO DE ACCESORIOS PARA MONTAJE VÁLVULA ORIENTABLE DN 15 3/4" ESFERA

REF.	EUROS	UNID. DE EMBALAJE	PESO UNID.
1039996	1,50	10	0,090

CONJUNTO DE ACCESORIOS PARA MONTAJE VÁLVULA ORIENTABLE DN 15 7/8" ESFERA

REF.	EUROS	UNID. DE EMBALAJE	PESO UNID.
1039995	1,50	10	0,100

Revisión A

VÁLVULAS DE BOLA RECTAS EN PVC PN10 CON SISTEMA ANTIFRAUDE MAGNÉTICO



H-H 1/2" DN15

REF.	EUROS	UNID. DE EMBALAJE	PESO UNID.
PVC10001	4,61	100	0,126

Opcional con tornillo antifraude



H-H 1/2" DN15 CON TAPÓN DE BLOQUEO MAGNÉTICO

REF.	EUROS	UNID. DE EMBALAJE	PESO UNID.
PVC10101	6,70	100	0,126



M-H 1/2"

REF.	EUROS	UNID. DE EMBALAJE	PESO UNID.
PVC10002	6,36	80	0,168

Opcional con tornillo antifraude



H 1/2" RACOR DE NYLON 3/4" – 7/8"

REF.	EUROS	UNID. DE EMBALAJE	PESO UNID.
PVC10003	5,54	80	0,150

Opcional con tornillo antifraude



H 1/2" RACOR DE NYLON 3/4" – 7/8" CON TAPÓN DE BLOQUEO MAGNÉTICO

REF.	EUROS	UNID. DE EMBALAJE	PESO UNID.
PVC10103	7,63	80	0,150

DISPUESTAS CON BLOQUEO DE VOLANTE PARA POSICIÓN DE MÍNIMO VITAL CON SISTEMA DE SEGURIDAD

TODAS LAS VÁLVULAS DISPONEN DE ROSCA CON INSERTO METÁLICO

PARA VÁLVULAS CON TORNILLO ANTIFRAUDE SUMAR LA REF. BTR101098 DE LA PÁGINA 43

Revisión A

VÁLVULAS DE BOLA RECTAS EN PVC PN10 CON SISTEMA ANTIFRAUDE MAGNÉTICO



H 1/2" RACOR TELESCÓPICO 3/4" DN15

REF.	EUROS	UNID. DE EMBALAJE	PESO UNID.
PVC10006	4,54	80	0,152

Opcional con tornillo antifraude



H 1/2" RACOR TELESCÓPICO 3/4" DN15 CON TAPÓN DE BLOQUEO MAGNÉTICO

REF.	EUROS	UNID. DE EMBALAJE	PESO UNID.
PVC10106	6,63	80	0,152



M 1/2" P.E. DN16-20

REF.	EUROS	UNID. DE EMBALAJE	PESO UNID.
PVC10004	6,25	80	0,194

Opcional con tornillo antifraude



H 1/2" P.E. DN16-20

REF.	EUROS	UNID. DE EMBALAJE	PESO UNID.
PVC10005	4,43	80	0,150

Opcional con tornillo antifraude



H 1/2" P.E. DN16-20 RACOR DE NYLON 3/4" - 7/8"

REF.	EUROS	UNID. DE EMBALAJE	PESO UNID.
PVC10007	6,24	80	0,174

Opcional con tornillo antifraude

PARA VÁLVULAS CON TORNILLO ANTIFRAUDE SUMAR LA REF. BTR101098 DE LA PÁGINA 43

Revisión A

ALOJAMIENTO CONTADORES

Revisión A

21/09



Revisión A

ÍNDICE

PAG. 65.....	ARMARIOS PARA CONTADORES DOMICILIARIOS
PAG. 66-67.....	ARMARIOS MONTADOS CON VÁLVULAS
PAG. 68.....	ARMARIOS ESPECIALES PARA CONTADORES
PAG. 69.....	ALOJAMIENTO PARA CONTADORES DE AGUA PPR
PAG. 70.....	KIT DE CONEXIÓN PARA CAJA DE SUELO
PAG. 71.....	SISTEMAS DE CORTE A DISTANCIA DE SUMINISTROS DE AGUA
PAG. 72.....	TAPÓN ANTIFRAUDE
PAG. 73.....	PUERTAS Y REGISTROS ALUMINIO
PAG. 74-76.....	ACCESORIOS ARMARIOS
PAG. 77-79.....	RACORES LATÓN PARA P.E.
PAG. 80.....	REDUCTORES DE PRESIÓN
PAG. 81.....	FILTROS
PAG. 82.....	MANÓMETROS

ALOJAMIENTO PARA CONTADORES AGUA



PUERTA CON MARCO DE POLIÉSTER SIN MIRILLA 292x390

REF.	EUROS	UNID. DE EMBALAJE	PESO UNID.
530013 (*)	33,55	1	0,615

PUERTA CON MARCO DE POLIÉSTER CON MIRILLA 292x390

REF.	EUROS	UNID. DE EMBALAJE	PESO UNID.
530014 (*)	36,08	1	0,615

*Hasta fin de existencias



PUERTA CON MARCO DE POLIÉSTER SIN MIRILLA 346x450

REF.	EUROS	UNID. DE EMBALAJE	PESO UNID.
530001	41,67	4	1,300

PUERTA CON MARCO DE POLIÉSTER CON MIRILLA 346x450

REF.	EUROS	UNID. DE EMBALAJE	PESO UNID.
530002	44,46	4	1,300



ARMARIO DE POLIÉSTER PARA CONTADOR 312x428x190 SIN MIRILLA

REF.	EUROS	UNID. DE EMBALAJE	PESO UNID.
530101	52,25	1	3,000

ARMARIO DE POLIÉSTER PARA CONTADOR 312x428x190 CON MIRILLA

REF.	EUROS	UNID. DE EMBALAJE	PESO UNID.
530103	53,96	1	3,000

ARMARIO DE POLIÉSTER 312x428x190 SIN MIRILLA Y CON CERRADURA METALICA

REF.	EUROS	UNID. DE EMBALAJE	PESO UNID.
530116	54,16	1	3,000



ARMARIO DE POLIÉSTER PARA CONTADOR 312x428x120 SIN MIRILLA

REF.	EUROS	UNID. DE EMBALAJE	PESO UNID.
530211	49,60	1	2,400

ARMARIO DE POLIÉSTER PARA CONTADOR 312x428x120 CON MIRILLA

REF.	EUROS	UNID. DE EMBALAJE	PESO UNID.
530207	51,32	1	2,400

PARA ARMARIOS CON CERRADURA METALICA CONSULTAR PRECIOS

CON SISTEMA CANDADO



ARMARIO DE POLIÉSTER PARA CONTADOR 312x428x120 CON MIRILLA

REF.	EUROS	UNID. DE EMBALAJE	PESO UNID.
530206	51,56	1	2,400

ARMARIO DE POLIÉSTER PARA CONTADOR 312x428x120 SIN MIRILLA

REF.	EUROS	UNID. DE EMBALAJE	PESO UNID.
530213	46,09	1	2,400

Revisión A

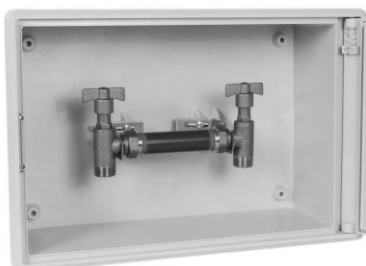
ARMARIOS POLIÉSTER EQUIPADOS CON VÁLVULAS BS

ARMARIO POLIÉSTER 312x428x120 S/M MONTADO CON ANCLAJES A/INOX.
VÁLVULA ENTRADA-SALIDA DN 13-15 BS Y CAÑO LIBRE

REF.	EUROS	UNID. DE EMBALAJE	PESO UNID.
535154	76,16	1	3,700

ARMARIO POLIÉSTER 312x428x120 S/M MONTADO CON ANCLAJES A/INOX.
VÁLVULA ENTRADA-SALIDA DN 20 BS Y CAÑO LIBRE

REF.	EUROS	UNID. DE EMBALAJE	PESO UNID.
535155	92,70	1	3,900

ARMARIO POLIÉSTER 312x428x120 S/M MONTADO CON ANCLAJES A/INOX.
VÁLVULA ENTRADA-SALIDA DN 13-15 P-E BS Y CAÑO LIBRE

REF.	EUROS	UNID. DE EMBALAJE	PESO UNID.
535156	82,81	1	4,000

ARMARIO POLIÉSTER 312x428x120 S/M MONTADO CON ANCLAJES A/INOX.
VÁLVULA ENTRADA-SALIDA DN 20 P-E BS Y CAÑO LIBRE

REF.	EUROS	UNID. DE EMBALAJE	PESO UNID.
535157	104,06	1	4,100

PARA OTRAS COMBINACIONES CONSULTAR

Revisión A

ARMARIOS POLIÉSTER EQUIPADOS CON VÁLVULAS ESFERA

ARMARIO POLIÉSTER 312x428x120 S/M MONTADO CON ANCLAJES A/INOX.
VÁLVULA ENTRADA-SALIDA DN 13-15 ESFERA Y CAÑO LIBRE

REF.	EUROS	UNID. DE EMBALAJE	PESO UNID.
535150	71,98	1	3,600

ARMARIO POLIÉSTER 312x428x120 S/M MONTADO CON ANCLAJES A/INOX.
VÁLVULA ENTRADA-SALIDA DN 20 ESFERA Y CAÑO LIBRE

REF.	EUROS	UNID. DE EMBALAJE	PESO UNID.
535151	91,47	1	3,900

ARMARIO POLIÉSTER 312x428x120 S/M MONTADO CON ANCLAJES A/INOX.
VÁLVULA ENTRADA-SALIDA DN 13-15 P-E ESFERA Y CAÑO LIBRE

REF.	EUROS	UNID. DE EMBALAJE	PESO UNID.
535152	87,19	1	4,000

ARMARIO POLIÉSTER 312x428x120 S/M MONTADO CON ANCLAJES A/INOX.
VÁLVULA ENTRADA-SALIDA DN 20 P-E ESFERA Y CAÑO LIBRE

REF.	EUROS	UNID. DE EMBALAJE	PESO UNID.
535153	105,01	1	4,150

PARA OTRAS COMBINACIONES CONSULTAR

Revisión A

ALOJAMIENTO PARA CONTADORES DE AGUA

**ARMARIO DE HORMIGÓN PARA ACOMETIDA INDIVIDUAL
CON PUERTA DE ALUMINIO 250x350**

REF.	EUROS	UNID. DE EMBALAJE	PESO UNID.
520002	162,31	1	50,000

**ARMARIO DE HORMIGÓN PARA ACOMETIDA INDIVIDUAL
CON PUERTA DE ALUMINIO 290x390**

REF.	EUROS	UNID. DE EMBALAJE	PESO UNID.
520003	164,91	1	50,000

**ARMARIO DE HORMIGÓN PARA ACOMETIDA INDIVIDUAL
CON PUERTA DE POLIÉSTER 292x390**

REF.	EUROS	UNID. DE EMBALAJE	PESO UNID.
520004	178,61	1	50,000

**ARMARIO DE HORMIGÓN PARA ACOMETIDA INDIVIDUAL
CON PUERTA DE POLIÉSTER 292x390 CON MIRILLA**

REF.	EUROS	UNID. DE EMBALAJE	PESO UNID.
520015	181,93	1	50,000

EQUIPAMIENTO INTERIOR NO INCLUIDO

Revisión A

**ARMARIO DE HORMIGÓN PARA BATERÍA DE CONTADORES
DE 2 SERVICIOS CON PUERTA DE ALUMINIO 400x420**

REF.	EUROS	UNID. DE EMBALAJE	PESO UNID.
520101	203,68	1	49,000

**ARMARIO DE HORMIGÓN PARA BATERÍA DE CONTADORES
DE 3 SERVICIOS CON PUERTA DE ALUMINIO 520x300**

REF.	EUROS	UNID. DE EMBALAJE	PESO UNID.
520102	457,20	1	47,000

EQUIPAMIENTO INTERIOR NO INCLUIDO

ARMARIO DE POLIÉSTER 530x530X230

REF.	EUROS	UNID. DE EMBALAJE	PESO UNID.
530102	85,49	1	4,800

ARMARIO DE POLIÉSTER 530x700X230

REF.	EUROS	UNID. DE EMBALAJE	PESO UNID.
530109	104,19	1	14,300

ARMARIO DE POLIÉSTER 750x750X300

REF.	EUROS	UNID. DE EMBALAJE	PESO UNID.
530106	461,65	1	18,600

ARMARIO DE POLIÉSTER 1000x750X300

REF.	EUROS	UNID. DE EMBALAJE	PESO UNID.
530110	513,37	1	21,200

ALOJAMIENTO PARA CONTADORES DE AGUA



CAJA DE SUELO EN PPR 329x162x160

REF.	EUROS	UNID. DE EMBALAJE	PESO UNID.
APM542003	28,49	1	0,800

CONTADOR Y KIT DE CONEXIÓN NO INCLUIDOS. ANCLAJES INCLUIDOS



CAJA DE SUELO EN PPR CON DOS COMPARTIMENTOS 372x224x175 TAPAS FUNDICIÓN SIN MIRILLA

REF.	EUROS	UNID. DE EMBALAJE	PESO UNID.
APM542001	151,58	1	6,400

CAJA DE SUELO EN PPR CON DOS COMPARTIMENTOS 372x224x175 TAPAS POLIPROPILENO CON MIRILLA

REF.	EUROS	UNID. DE EMBALAJE	PESO UNID.
APM542002	36,27	1	1,000

PARA LLAVE DE APERTURA VER PÁGINA 73

CONTADOR Y KIT DE CONEXIÓN NO INCLUIDOS



CAJA DE SUELO DE FUNDICIÓN DÚCTIL CON KIT DE CONEXIÓN DE ENTRADA Y SALIDA PARA CONTADOR DE 110 LONG.

REF.	EUROS	UNID. DE EMBALAJE	PESO UNID.
CTR00110	64,75	1	6,888

CAJA DE SUELO DE FUNDICIÓN DÚCTIL CON KIT DE CONEXIÓN DE ENTRADA Y SALIDA PARA CONTADOR DE 115 LONG.

REF.	EUROS	UNID. DE EMBALAJE	PESO UNID.
CTR00115	75,59	1	6,920

ARQUETA DE FUNDICIÓN VACÍA

REF.	EUROS	UNID. DE EMBALAJE	PESO UNID.
CTR00001	34,75	1	6,040

*Hasta fin de existencias

Revisión A

KIT DE CONEXIÓN PARA CAJA DE SUELO



KIT DE CONEXIÓN ENTRADA Y SALIDA CON VÁLVULAS DE PVC 1/2"

REF.	CONEXIÓN	EUROS	UNID. DE EMBALAJE	PESO UNID.
PVC10003-K	PPR	10,22	1	0,150
LAT10003-K	LATÓN	19,13	1	0,227

KIT DE CONEXIÓN PARA REF.APM542003 – APM542002



KIT DE CONEXIÓN ENTRADA Y SALIDA CON VÁLVULAS DE LATÓN 1/2"

REF.	CONEXIÓN	EUROS	UNID. DE EMBALAJE	PESO UNID.
PVC10006-K	PPR	29,81	1	0,152
LAT10006-K	LATÓN	39,44	1	0,279

KIT DE CONEXIÓN PARA REF.APM542003 – APM542002
VÁLVULA ENTRADA CON SISTEMA ANTIFRAUDE MAGNÉTICO



KIT DE CONEXIÓN ENTRADA CON CUADRADILLO 30x30 Y SALIDA CON VÁLVULAS DE LATÓN 1/2"

REF.	CONEXIÓN	EUROS	UNID. DE EMBALAJE	PESO UNID.
LAT10007-K	LATÓN	32,55	1	0,289

KIT DE CONEXIÓN PARA REF.APM542001
VÁLVULA ENTRADA CON SISTEMA ANTIFRAUDE MAGNÉTICO



KIT DE CONEXIÓN ENTRADA Y SALIDA DN 15 3/4"

REF.	EUROS	UNID. DE EMBALAJE	PESO UNID.
CTRKIT01	35,50	2	0,310

*Hasta fin de existencias

KIT VÁLVULAS PARA REF.CTR00001

Revisión A

SISTEMA INALÁMBRICO DE CORTE A DISTANCIA DE SUMINISTRO DE AGUA

	REF.	EUROS	UNID. EMBALAJE	PESO UNID.
	APM552001	770,98	1	4,800

MANDO A DISTANCIA DEL SISTEMA INALÁMBRICO

	REF.	EUROS	UNID. EMBALAJE	PESO UNID.
	APM552002	901,80	1	0,756

SISTEMA DE CORTE ANTIFRAUDE MAGNÉTICO

	MEDIDA	REF.	EUROS	UNID. DE EMBALAJE	PESO UNID.
	1/2"	APM552003	47,78	1	1,074
	3/4"	APM552013	52,05	1	1,178
	1"	APM552023	66,99	1	1,421
	1 1/4"	APM552033	81,77	1	1,764
	1 1/2"	APM552043	104,00	1	2,437
	2"	APM552053	128,35	1	3,263

LLAVE DE ALLEN 8mm LONG.188x43

	MEDIDA	REF.	EUROS	UNID. DE EMBALAJE	PESO UNID.
	8mm	10034360	7,54	1	0.096

LLAVE DEL SISTEMA DE CORTE ANTIFRAUDE MAGNÉTICO

	MEDIDA	REF.	EUROS	UNID. DE EMBALAJE	PESO UNID.
	1/2"	APM552103	62,59	1	0,613
	3/4" – 1" – 1 1/4"	APM552113	64,68	1	0,643
	1 1/2" – 2"	APM552143	72,41	1	0,683

ALARGADERA LLAVE DEL SISTEMA DE CORTE ANTIFRAUDE MAGNÉTICO

	REF.	EUROS	UNID. DE EMBALAJE	PESO UNID.
	APM552203	49,22	1	0,542

Revisión A

TAPÓN ANTIFRAUDE HEMBRA CON FUNDA GIRATORIA ROSCA IZQUIERDA



MEDIDA	REF.	EUROS	UNID. DE EMBALAJE	PESO UNID.
21,8	SAAB0001	5,99	1	0,147
3/4"	SAAB0002	6,03	1	0,151
1"	SAAB0003	9,23	1	0,248

COMPLETAR PIDIENDO TAPÓN GIRATORIO. VEASE PÁGINA 45 REF. BTR101090

TAPÓN ANTIFRAUDE MACHO ROSCA DERECHA



MEDIDA	REF.	EUROS	UNID. DE EMBALAJE	PESO UNID.
1/2"	AV000017	3,43	1	0,081
3/4"	AV000016	3,82	1	0,098
7/8"	AV000018	4,17	1	0,112
1"	AV000019	5,13	1	0,143

COMPLETAR PIDIENDO TAPÓN GIRATORIO. VEASE PÁGINA 45 REF. BTR101090

Revisión A

PUERTAS Y REGISTROS DE ALUMINIO

	PUERTA CON MARCO	REF.	EUROS	UNID. EMBALAJE	PESO UNID.
	ALUMINIIO				
	150x200	500001	13,82	10	0,850
	200x320	500002	16,26	10	1,300
	250x350	500003	19,21	10	1,500
	250x500	500004	32,02	10	2,100
	300x500	500009	31,98	10	1,700
	290x390	500005	21,19	10	1,800
	220x350	500006	16,06	10	1,400
	400x420	500007	52,67	5	3,500
	285x385	500010	29,25	10	1,400

MOD. CÓRDOBA

	REGISTRO DE ALUMINIO	REF.	EUROS	UNID. EMBALAJE	PESO UNID.
	200x200	801020	11,47	10	1,700
	300x300	801030	28,51	10	1,900
	400x400	801040	46,75	10	3,200

	REGISTRO DE ALUMINIO PARA LLAVE DE CORTE	REF.	EUROS	UNID. EMBALAJE	PESO UNID.
	200x200	502002	9,17	10	0,800

	SUMIDERO ALUMINIIO	REF.	EUROS	UNID. EMBALAJE	PESO UNID.
	150x150	800015	8,41	10	0,600
	200x200	800020	12,62	10	0,750
	250x250	800025	17,61	10	1,050
	300x300	800030	24,47	10	2,030
	400x400	800040	44,90	10	2,800

Revisión A

ACCESORIOS PARA ARMARIOS

CERRADURA METÁLICA PARA PUERTA DE ALUMINIO

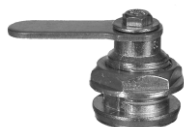

MODELO	REF.	EUROS	UNID. DE EMBALAJE	PESO UNID.
CUADRADILLO HEMBRA	500204	2,61	1	0,030
CUADRADILLO MACHO	500214	2,61	1	0,030
TRIANGULAR MACHO	500205	2,61	1	0,030
TRIANGULAR HEMBRA	500226	2,61	1	0,030
ALLEN	500220	2,61	1	0,030

LLAVE METÁLICA PARA PUERTA DE ALUMINIO

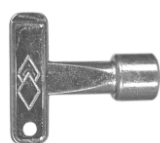

MODELO	REF.	EUROS	UNID. DE EMBALAJE	PESO UNID.
CUADRADILLO MACHO	500199	1,28	1	0,012
CUADRADILLO HEMBRA	500227	1,28	1	0,012
TRIANGULAR MACHO	500200	1,30	1	0,012
TRIANGULAR HEMBRA	500228	1,30	1	0,012
ALLEN	500223	1,28	1	0,012

CERRADURA TRIANGULAR

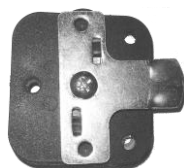

REF.	EUROS	UNID. DE EMBALAJE	PESO UNID.
502015	4,21	1	0,025

CERRADURA DE CUADRADILLO

REF.	EUROS	UNID. DE EMBALAJE	PESO UNID.
502012	4,21	1	0,025

LLAVE TRIANGULAR



REF.	EUROS	UNID. DE EMBALAJE	PESO UNID.
500201	1,24	1	0,008

LLAVE METÁLICA PARA ARQUETAS REF.APM542003-APM542001-APM542002



REF.	EUROS	UNID. DE EMBALAJE	PESO UNID.
00502113	2,85	1	0,056

Revisión A

ACCESORIOS PARA ARMARIOS

HASTA FIN DE EXISTENCIAS

CERRADURA METÁLICA TRIANGULAR 8mm

REF.	EUROS	UNID. DE EMBALAJE	PESO UNID.
502019	9,94	1	0,155

CERRADURA METÁLICA DE CUADRADILLO 8mm

REF.	EUROS	UNID. DE EMBALAJE	PESO UNID.
502018	9,94	1	0,155

JUEGO ANCLAJES ACERO INOXIDABLE PARA ARMARIO DE POLIÉSTER

REF.	EUROS	UNID. DE EMBALAJE	PESO UNID.
539903	4,61	1	0,26

 AISLAMIENTO TÉRMICO PARA PUERTA DE POLIÉSTER 312x428

REF.	EUROS	UNID. DE EMBALAJE	PESO UNID.
997000	5,57	1	0,010

 AISLAMIENTO TÉRMICO PARA CUBA 312x428x190

REF.	EUROS	UNID. DE EMBALAJE	PESO UNID.
997020	5,57	1	0,030

Revisión A

ACCESORIOS PARA ARMARIOS

COLECTOR ROSCADO DE 1" CON 2 SALIDAS PARA ARMARIO DE HORMIGÓN

REF.	EUROS	UNID. DE EMBALAJE	PESO UNID.
180001	42,80	1	1,300

COLECTOR ROSCADO DE 1" CON 3 SALIDAS PARA ARMARIO DE HORMIGÓN

REF.	EUROS	UNID. DE EMBALAJE	PESO UNID.
180002	48,78	1	1,700

CODO EMBRIDADO DOBLE BRIDA 2" GALVANIZADO

REF.	EUROS	UNID. DE EMBALAJE	PESO UNID.
180003	64,36	1	6,000

CODO EMBRIDADO DOBLE BRIDA 2 1/2" GALVANIZADO

REF.	EUROS	UNID. DE EMBALAJE	PESO UNID.
180004	78,25	1	7,200

CODO EMBRIDADO DOBLE BRIDA 3" GALVANIZADO

REF.	EUROS	UNID. DE EMBALAJE	PESO UNID.
180005	89,03	1	9,300

CODO EMBRIDADO DOBLE BRIDA 4" GALVANIZADO

REF.	EUROS	UNID. DE EMBALAJE	PESO UNID.
180006	106,13	1	11,000

Revisión A

RACORES DE LATÓN PARA P-E

MANGUITO



MEDIDAS	REF.	EUROS	UNID. EMBALAJE	PESO UNID.
20x20	770001	9,63	10	0,150
25x25	770002	11,58	10	0,200
32x32	770003	17,63	10	0,320
40x40	770004	34,25	10	0,450
50x50	770005	50,58	10	0,630
63x63	770006	71,27	5	0,920
75x75	770007	113,61	1	2,350

RACOR ROSCA MACHO



MEDIDAS	REF.	EUROS	UNID. EMBALAJE	PESO UNID.
20x1/2"	770008	5,79	10	0,090
25x3/4"	770009	7,32	10	0,130
32x1"	770010	10,47	10	0,200
40x1 1/4"	770011	20,43	10	0,300
50x1 1/2"	770012	27,03	10	0,400
63x2"	770013	40,04	5	0,540

RACOR ROSCA HEMBRA



MEDIDAS	REF.	EUROS	UNID. EMBALAJE	PESO UNID.
20x1/2"	770015	5,66	10	0,090
25x3/4"	770016	7,16	10	0,130
32x1"	770017	10,67	10	0,190
40x1 1/4"	770018	18,64	10	0,295
50x1 1/2"	770019	28,04	10	0,390
63x2"	770020	39,46	5	0,530

RACORES DE LATÓN PARA P-E

CODO DOS BOCAS IGUALES



MEDIDAS	REF.	EUROS	UNID. EMBALAJE	PESO UNID.
20x20	770022	12,33	10	0,170
25x25	770023	14,12	10	0,260
32x32	770024	22,28	10	0,360
40x40	770025	41,31	10	0,630
50x50	770026	57,32	10	0,850
63x63	770027	80,93	5	1,300

"T" MIXTA



MEDIDAS	REF.	EUROS	UNID. EMBALAJE	PESO UNID.
20x1/2"	770047	12,98	10	0,180
25x3/4"	770048	15,94	10	0,260
32x1"	770049	24,62	10	0,390
40x1 1/4"	770050	46,78	10	0,670
50x1 1/2"	770051	68,54	5	0,980
63x2"	770052	89,81	5	1,300
75x2 1/2"	770053	129,51	1	3,400

RACOR CODO MACHO



MEDIDAS	REF.	EUROS	UNID. EMBALAJE	PESO UNID.
20x1/2"	770028	9,56	10	0,110
25x3/4"	770029	11,19	10	0,150
32x1"	770030	16,82	10	0,255
40x1 1/4"	770031	30,74	10	0,430
50x1 1/2"	770032	44,57	10	0,540
63x2"	770033	65,16	5	0,985

Revisión A

RACORES DE LATÓN PARA P-E

RACOR CODO HEMBRA



MEDIDAS	REF.	EUROS	UNID. EMBALAJE	PESO UNID.
20x1/2"	770034	9,43	10	0,120
25x3/4"	770035	11,16	10	0,170
32x1"	770036	16,95	10	0,230
40x1 1/4"	770037	31,03	10	0,360
50x1 1/2"	770038	42,00	10	0,640
63x2"	770039	69,29	5	1,050

"T" TRES BOCAS IGUALES



MEDIDAS	REF.	EUROS	UNID. EMBALAJE	PESO UNID.
20x20x20	770040	17,21	10	0,220
25x25x25	770041	19,91	10	0,305
32x32x32	770042	29,60	10	0,487
40x40x40	770043	55,56	10	0,850
50x50x50	770044	80,93	10	1,050
63x63x63	770045	120,13	5	1,530
75x75x75	770046	173,85	1	4,900

CODO PLACA



MEDIDAS	REF.	EUROS	UNID. EMBALAJE	PESO UNID.
1/2"x20	770060	12,07	10	0,180
3/4"x25	770061	13,89	10	0,260

MANGUITO REPARACIÓN



MEDIDAS	REF.	EUROS	UNID. EMBALAJE	PESO UNID.
20x20	770062	16,98	10	0,290
25x25	770063	20,43	10	0,400
32x32	770064	29,60	10	0,580
40x40	770065	47,17	10	0,765

REDUCTORES DE PRESIÓN

REDUCTOR DE PRESIÓN SERIE R3



PN	PULGADAS	REF.	EUROS	UNID. EMBALAJE	PESO UNID.
PN 15	1/2"	780116	16,30	50	0,350
PN 15	3/4"	780117	16,88	50	0,390

REDUCTOR DE PRESIÓN A PISTÓN PN25 ASIENTO A/INOX Y TOMA DE MANÓMETRO



PN	PULGADAS	REF.	EUROS	UNID. EMBALAJE	PESO UNID.
PN 25	1/2"	780001	28,05	1	1,360
PN 25	3/4"	780002	40,58	1	2,255
PN 25	1"	780003	48,44	1	3,265
PN 25	1 1/4"	780004	89,34	1	5,090
PN 25	1 1/2"	780005	104,76	1	9,120
PN 25	2"	780006	160,05	1	1,170

REDUCTOR DE PRESIÓN PN40 CON CÁMARA DE COMPENSACIÓN Y TOMA DE MANÓMETRO



PN	PULGADAS	REF.	EUROS	UNID. EMBALAJE	PESO UNID.
PN 40	2"	780012	614,15	1	11,000
PN 40	2 1/2"	780013	1.409,53	1	13,000
PN 40	3"	780014	1.867,47	1	17,000
PN 40	4"	780015	4.532,67	1	25,000

Revisión A

FILTROS DE LATÓN Y MANÓMETROS
FILTRO PARA RECOGIDA DE IMPUREZAS

PN	PULGADAS	REF.	EUROS	UNID. EMBALAJE	PESO UNID.
PN 16 Precintable	1/2"	790001	4,66	10	0,115
PN 16	3/4"	790002	6,82	10	0,126
PN 16	1"	790003	9,29	10	0,320
PN 16	1 1/4"	790004	18,95	5	0,515
PN 16	1 1/2"	790005	24,68	5	0,665
PN 16	2"	790006	52,53	2	1,195

FILTRO AUTOLIMPIANTE PARA AGUA MALLA ACERO INOX. 100 MICRAS

PN	PULGADAS	REF.	EUROS	UNID. EMBALAJE	PESO UNID.
PN 25	3/4"	790010	78,00	15	1,475
PN 25	1"	790011	93,96	10	1,779
PN 25	1 1/4"	790012	89,10	10	1,779
PN 25	1 1/2"	790013	114,68	5	2,941
PN 25	2"	790014	114,68	5	2,941

Revisión A

MANÓMETROS

MANÓMETRO 0-16 BAR Ø 63

PULGADAS	REF.	EUROS	UNID. DE EMBALAJE	PESO UNID.
1/4"	790015	4,51	1	0,063

MANÓMETRO 0-25 BAR Ø 63

PULGADAS	REF.	EUROS	UNID. DE EMBALAJE	PESO UNID.
1/4"	790016	4,51	1	0,063

MANÓMETRO DE GLICERINA 0-6

PULGADAS	REF.	EUROS	UNID. DE EMBALAJE	PESO UNID.
1/4"	790018	9,60	1	0,213

MANÓMETRO DE GLICERINA 0-10

PULGADAS	REF.	EUROS	UNID. DE EMBALAJE	PESO UNID.
1/4"	790019	9,60	1	0,220

Revisión A

CONTADORES

Revisión A

21/09



REVISION A

ÍNDICE

PAG. 85-87..... CONTADORES USO DOMÉSTICO

PAG. 88..... CONJUNTOS MONTADOS

PAG. 89-90..... CONTADORES DE CHORRO MULTIPLE Y VOLUMÉTRICOS

PAG. 91..... CONTADORES WOLTMAN

PAG. 92-96..... ACCESORIOS PARA CONTADOR

Revisión A



MOD. SJ-SDC PLUS DN15-20 CONTADOR CHORRO ÚNICO R100 CUERPO LATÓN CON PREDISPOSICIÓN HOMOLOGADO



MODELO	30°C/90°C	DIÁMETRO	LONGITUD	REF.	EUROS	UD. EMBALAJE	PESO UNID.
SJ-SDC-PLUS	A/F	1/2" 13mm	115 mm	NW680111	26,49	20	0,460
SJ-SDC-PLUS	A/F	1/2" 15mm	115 mm	NW680110	25,08	20	0,430
SJ-SDC-PLUS	A/C	1/2" 15mm	115 mm	NW640007	26,17	20	0,430
SJ-SDC-PLUS	A/F	3/4" 20mm	130 mm	NW680112	31,79	20	0,540
SJ-SDC-PLUS	A/C	3/4" 20mm	130 mm	NW640006	33,19	20	0,540

VERIFICACIÓN DE FÁBRICA Y RACORES INCLUIDOS

MOD. SJ-SDC-PLUS DN15-20 CONTADOR CHORRO ÚNICO R160 CUERPO LATÓN CON PRE-DISPOSICIÓN HOMOLOGADO



MODELO	30°C	DIÁMETRO	LONGITUD	REF.	EUROS	UD. EMBALAJE	PESO UNID.
SJ-SDC-PLUS	A/F	1/2" 15mm	115 mm	NW680008	24,56	20	0.430
SJ-SDC-PLUS	A/F	1/2" 13mm	115 mm	NW680115	25,85	20	0.460
SJ-SDC-PLUS	A/F	3/4" 20mm	130 mm	NW680309	31,12	20	0.540

VERIFICACIÓN DE FÁBRICA Y RACORES INCLUIDOS

Revisión A

MOD. SJ-SDC-D3 DN15 CONTADOR CHORRO ÚNICO R100 CUERPO COMPOSITE CON PREDISPOSICIÓN HOMOLOGADO



MODELO	30°C	DIÁMETRO	LONGITUD	REF.	EUROS	UD. EMBALAJE	PESO UNID.
SJ-SDC	A/F	1/2" 15mm	115 mm	NW680101	23,63	20	0,425

VERIFICACIÓN DE FÁBRICA Y RACORES INCLUIDOS

MOD. SJ-SDC-PLUS DN15 CONTADOR CHORRO ÚNICO R160 CUERPO COMPOSITE CON PRE-DISPOSICIÓN HOMOLOGADO



MODELO	30°C	DIÁMETRO	LONGITUD	REF.	EUROS	UD. EMBALAJE	PESO UNID.
SJ-SDC-PLUS	A/F	1/2" 15mm	115 mm	NW680003	23,63	20	0,475

VERIFICACIÓN DE FÁBRICA Y RACORES INCLUIDOS

Revisión A

MOD. LEXUS-LXSG CONTADOR 8 RODILLOS ESFERA SECA R80 NO HOMOLOGADO



MODELO	30°C / 90°C	DIÁMETRO	LONGITUD	REF.	EUROS	UNID. EMBALAJE	PESO UNID.
LXSG8R	A/F	1/2" 15mm	110 mm	660055	18,91	40	0,458

VERIFICACIÓN Y RACORES INCLUIDOS

MOD. SJSDC R100 DN15/20 A/F-A/C

CONTADOR 8 RODILLOS ESFERA SECA CON EMISOR DE IMPULSOS

HOMOLOGADO



MODELO	30°C / 90°C	DIÁMETRO	LONGITUD	REF.	EUROS	UD. EMBALAJE	PESO UNID.
SJ-SDC-PLUS	A/F	1/2" 13mm	115 mm	NW621107	34,39	20	0,480
SJ-SDC-PLUS	A/F	1/2" 15mm	115 mm	NW621103	32,97	20	0,450
SJ-SDC-PLUS	A/C	1/2" 15mm	115 mm	NW621104	34,06	20	0,450
SJ-SDC-PLUS	A/F	3/4" 20mm	130 mm	NW621105	39,69	20	0,510
SJ-SDC-PLUS	A/C	3/4" 20mm	130 mm	NW621106	41,08	20	0,510

VALOR DE IMPULSOS 1P-1-1P-10

VERIFICACIÓN Y RACORES INCLUIDOS

MOD. SJSDC PLUS R160 DN 15 A/F

CONTADOR 8 RODILLOS ESFERA SECA CON EMISOR DE IMPULSOS

HOMOLOGADO



MODELO	30°C	DIÁMETRO	LONGITUD	REF.	EUROS	UD. EMBALAJE	PESO UNID.
SJ-SDC PLUS	A/F	1/2" 15mm	115 mm	NW641103	32,46	20	0,460
SJ-SDC PLUS	A/F	1/2" 13mm	115 mm	NW641104	33,75	20	0,480
SJ-SDC PLUS	A/F	3/4" 20mm	130 mm	NW641105	39,02	20	0,530

VALOR DE IMPULSOS 1P-1-1P-10

VERIFICACIÓN Y RACORES INCLUIDOS

Revisión A

CONJUNTOS MONTADOS PARA LECTURA DE AGUA CALIENTE SANITARIA



CONJUNTO CON VÁLVULAS ESFERA 1/2" – H RACOR 3/4" Y CONTADOR A/C DN 15			
REF.	EUROS	UNID. DE EMBALAJE	PESO UNID.
990205	44,05	10	1,000
CONJUNTO CON VÁLVULAS ESFERA 3/4" – H RACOR 3/4" Y CONTADOR A/C DN 15			
REF.	EUROS	UNID. DE EMBALAJE	PESO UNID.
990207	56,80	10	1,220
CONJUNTO CON VÁLVULAS ESFERA 3/4" – H RACOR 1" Y CONTADOR A/C DN 20			
REF.	EUROS	UNID. DE EMBALAJE	PESO UNID.
990208	68,70	10	1,470



CONJUNTO CON VÁLVULAS ESFERA 1/2" – H RACOR 3/4" Y CONTADOR IMPULSOS A/C DN 15			
REF.	EUROS	UNID. DE EMBALAJE	PESO UNID.
990209	51,95	10	1,016
CONJUNTO CON VÁLVULAS ESFERA 3/4" – H RACOR 3/4" Y CONTADOR IMPULSOS A/C DN 15			
REF.	EUROS	UNID. DE EMBALAJE	PESO UNID.
990214	65,08	10	1,236
CONJUNTO CON VÁLVULAS ESFERA 3/4" – H RACOR 1" Y CONTADOR IMPULSOS A/C DN 20			
REF.	EUROS	UNID. DE EMBALAJE	PESO UNID.
990217	77,67	10	1,486

CONJUNTOS MONTADOS CON SOPORTE DE FIJACIÓN PARA LECTURA DE AGUA FRIA Y CALIENTE SANITARIA



CONJUNTO CON VÁLVULAS ESFERA 3/4" M – RACOR 3/4" Y CONTADOR A/F Y A/C DN 15			
REF.	EUROS	UNID. DE EMBALAJE	PESO UNID.
990201	139,82	1	2,000
CONJUNTO CON VÁLVULAS ESFERA 3/4" M – RACOR 1" Y CONTADOR A/F Y A/C DN 20			
REF.	EUROS	UNID. DE EMBALAJE	PESO UNID.
990211	155,84	1	2,250

PARA OTRAS COMBINACIONES CONSULTAR MONTAJE ESTANDAR CON CONEXIÓN DE ENTRADA POR LA IZQUIERDA

Revisión A

CONTADORES CHORRO MÚLTIPLE R80

MOD. KVS

CONTADOR CHORRO MÚLTIPLE CUADRANTE SECO A/F

HOMOLOGADO



MODELO	A/F 30°C	DIÁMETRO	LONGITUD	REF.	EUROS	UNID. EMBALAJE	PESO UNID.
KVS	3 M3	1/2" 15mm	165 mm	660029	35,59	20	1,900
KVS	5 M3	3/4" 20mm	190 mm	660030	48,77	20	2,500
KVS	7 M3	1" 25mm	260 mm	660031	67,15	10	2,700
KVS	12 M3	1 1/4" 30mm	260 mm	660032	85,82	10	2,800
KVS	20 M3	1 1/2" 40mm	300 mm	660033	139,47	5	5,100
KVS	30 M3	2" 50mm	300 mm	660034	161,16	4	7,400

RACORES INCLUIDOS

VERIFICACIÓN NO INCLUIDA

MOD. MJ-SDC

CONTADOR CHORRO MÚLTIPLE CUADRANTE SECO A/C

HOMOLOGADO



MODELO	A/C 90°C	DIÁMETRO	LONGITUD	REF.	EUROS	UNID. EMBALAJE	PESO UNID.
MJ-SDC	3 M3	1/2" 15mm	165 mm	660398	71,64	20	1,900
MJ-SDC	5 M3	3/4" 20mm	190 mm	660399	79,36	20	2,500
MJ-SDC	7 M3	1" 25mm	260 mm	660400	125,50	10	2,700
MJ-SDC	12 M3	1 1/4" 30mm	260 mm	660401	150,94	10	2,800
MJ-SDC	20 M3	1 1/2" 40mm	300 mm	660402	230,02	5	5,100
MJ-SDC	30 M3	2" 50mm	300 mm	660403	289,97	4	7,400

RACORES INCLUIDOS

MOD. KVS

CONTADOR CHORRO MÚLTIPLE CON EMISOR DE IMPULSOS A/F

HOMOLOGADO



MODELO	A/F 30°C	DIÁMETRO	LONGITUD	REF.	EUROS	UNID. EMBALAJE	PESO UNID.
KVS	3 M3	1/2" 15mm	165 mm	661129	45,87	20	1,900
KVS	5 M3	3/4" 20mm	190 mm	661130	56,29	20	2,500
KVS	7 M3	1" 25mm	260 mm	661131	80,64	10	2,700
KVS	12 M3	1 1/4" 30mm	260 mm	661132	95,89	10	2,800
KVS	20 M3	1 1/2" 40mm	300 mm	661133	158,96	5	5,100
KVS	30 M3	2" 50mm	300 mm	661134	177,23	4	7,400

RACORES INCLUIDOS

VERIFICACIÓN NO INCLUIDA

MOD. MJ-SDC

CONTADOR CHORRO MÚLTIPLE CON EMISOR DE IMPULSOS A/C

HOMOLOGADO



MODELO	A/C 90°C	DIÁMETRO	LONGITUD	REF.	EUROS	UNID. EMBALAJE	PESO UNID.
MJ-SDC	3 M3	1/2" 15mm	165 mm	661398	114,96	20	1,900
MJ-SDC	5 M3	3/4" 20mm	190 mm	661399	131,07	20	2,500
MJ-SDC	7 M3	1" 25mm	260 mm	661400	145,55	10	2,700
MJ-SDC	12 M3	1 1/4" 30mm	260 mm	661401	171,51	10	2,800
MJ-SDC	20 M3	1 1/2" 40mm	300 mm	661402	250,60	5	5,100
MJ-SDC	30 M3	2" 50mm	300 mm	661403	309,87	4	7,400

RACORES INCLUIDOS

Revisión A

MOD. KVS R160/R200 CONTADOR VOLUMÉTRICO ESFERA SECA A/F

HOMOLOGADO



MODELO	A/F 30°C	DIÁMETRO	LONGITUD	REF.	EUROS	UD. EMBALAJE	PESO UNID.
KVS-3V R160	Q3:2,5 M ³ /h	1/2" 15mm	165 mm	KV670010	41,71	10	0,905
KVS-1V R160	Q3:2,5 M ³ /h	3/4" 20mm	190 mm	KV670012	45,15	10	1,650
MODELO	A/F 30°C	DIÁMETRO	LONGITUD	REF.	PESOS	UD. EMBALAJE	PESO UNID.
KVS-2V R200	Q3:2,5 M ³ /h	1/2" 15mm	165 mm	660237	41,71	10	0,905
KVS-2V R200	Q3:2,5 M ³ /h	3/4" 20mm	190 mm	660236	45,15	10	1,650

VERIFICACIÓN DE FÁBRICA Y RACORES INCLUIDOS

MOD. NWM PD-SDC E8 DN15 CONTADOR VOLUMÉTRICO DE PISTÓN ROTATIVO R200 CUERPO COMPOSITE ESFERA SECA CON PRE-DISPOSICIÓN

HOMOLOGADO



MODELO	A/F 30°C	DIÁMETRO	LONGITUD	REF.	EUROS	UNID. EMBALAJE	PESO UNID.
NWM PD-SDC E8	Q3:2,5 M ³ /h	1/2" 15mm	115 mm	NW710101	35,55	20	0,750
NWM PD-SDC E8(*)	Q3:2,5 M ³ /h	1/2" 15mm	115 mm	NW710107	35,84	20	0,750

(*) Rosca diferencial 7/8" entrada - 3/4" salida

VERIFICACIÓN DE FÁBRICA Y RACORES INCLUIDOS

Revisión A

MOD. ASTRAL RTK

CONTADOR VOLUMÉTRICO CLASE R160 CON PISTÓN ROTATORIO R160 EN CUALQUIER POSICIÓN HOMOLOGADO



MODELO	50°C	DIÁMETRO	LONGITUD	REF.	EUROS	UNID. EMBALAJE	PESO UNID.
RTK	A/F	1/2" 15mm	110 mm	660065	57,49	10	0,370
RTK	A/F	3/4" 20mm	190 mm	660066	63,57	10	0,480

*Hasta fin de existencias

VERIFICACIÓN Y RACORES INCLUIDOS

MOD. PDLFC DN15-20

CONTADOR VOLUMÉTRICO R160/200 CUERPO COMPOSITE Y A.INOX CON PRE-DISPOSICIÓN

HOMOLOGADO



MODELO	A/F 30°C	DIÁMETRO	LONGITUD	REF.	EUROS	UD. EMBALAJE	PESO UNID.
PDLFC R160	Q3:2,5 M ³ /h	1/2" 15mm	115 mm	PDLFC1003	27,23	20	0,450
PDLFC R200	Q3:2,5 M ³ /h	1/2" 15mm	115 mm	PDLFC1007	29,93	20	0,450

VERIFICACIÓN Y RACORES INCLUIDOS

**CONTADOR WOLTMAN DE TURBINA R80 AGUA FRÍA 30°
CON PREEQUIPO PARA EMISOR DE IMPULSOS MOD. WPH K30**

HOMOLOGADO



CAUDAL MAX. M ³ -HORA	DIÁMETRO	LONGITUD	REF.	EUROS	UNID. EMBALAJE	PESO UNID.
30 M ³	2" 50mm	200 mm	660046	254,21	1	12,000
50 M ³	2 1/2" 65mm	200 mm	660047	282,31	1	13,000
80 M ³	3" 80mm	225 mm	660048	320,53	1	15,000
120 M ³	4" 100mm	250 mm	660049	358,66	1	17,000
200 M ³	5" 125mm	250 mm	660050	428,86	1	19,000
300 M ³	6" 150mm	300 mm	660051	680,59	1	40,000
500 M ³	8" 200mm	350 mm	660052	911,10	1	55,000

VERIFICACIÓN NO INCLUIDA

PARA EQUIPAMIENTO CON EMISOR IMPULSOS SUMAR REF. 1060103 – PAG. 89

**CONTADOR WOLTMAN DE TURBINA R80 AGUA CALIENTE 120°
CON PREEQUIPO PARA EMISOR DE IMPULSOS MOD. WPH K30**

NO HOMOLOGADO



CAUDAL MAX. M ³ -HORA	DIÁMETRO	LONGITUD	REF.	EUROS	UNID. EMBALAJE	PESO UNID.
30 M ³	2" 50mm	200 mm	660077	436,40	1	9,900
50 M ³	2 1/2" 65mm	200 mm	660078	443,14	1	10,600
80 M ³	3" 80mm	225 mm	660079	464,71	1	13,300
120 M ³	4" 100mm	250 mm	660080	489,85	1	15,600

PARA EQUIPAMIENTO CON EMISOR IMPULSOS SUMAR REF. 1060103 – PAG. 89

Revisión A

VERIFICACIÓN PRIMITIVA WOLTMAN

MODELO	PULGADAS	REF.	PRECIO NETO
WPH K30	2"	1060007	15,03
WPH K30	2 1/2"	1060008	15,03
WPH K30	3"	1060009	15,03
WPH K30	4"	1060010	15,03
WPH K30	5"	1060011	15,03
WPH K30	6"	1060012	15,03
WPH K30	8"	1060013	15,03

VERIFICACIÓN PRIMITIVA CHORRO MÚLTIPLE

MODELO	DIAMETRO	REF.	PRECIO NETO
KVS	DN15	1060001	1,50
KVS	DN20	1060002	1,50
KVS	DN25	1060003	2,78
KVS	DN30	1060004	3,76
KVS	DN40	1060005	6,80
KVS	DN50	1060006	6,80

ACCESORIOS CONTADOR
RACOR CONTADOR

Ø CONTADOR	REF.	EUROS	UNID. EMBALAJE	PESO UNID.
13mm 7/8" 1/2"	1040002	3,15	25	0,096
15mm 3/4" 1/2"	1040001	2,36	25	0,070
20mm 1" 3/4"	1040003	3,15	20	0,140
25mm 1 1/4" 1"	1040004	7,72	10	0,220
30mm 1 1/2" 1 1/4"	1040005	8,44	10	0,340
40mm 2" 1 1/2"	1040006	12,33	5	0,425
50mm 2 1/2" 2"	1040007	35,14	3	0,850

JUNTA RACOR CONTADOR

Ø RACOR	REF.	EUROS	UNID. DE EMBALAJE	PESO UNID.
7/8" 1/2"	1045001	0,18	25	0,006
3/4" 1/2"	1045002	0,10	25	0,005
1" 3/4"	1045003	0,17	25	0,010
1 1/4" 1"	1045004	0,22	25	0,020
1 1/2" 1 1/4"	1045005	0,33	25	0,030
2" 1 1/2"	1045006	0,34	25	0,030
2 1/2" 2"	1045007	0,59	25	0,070

ALARGADERA LATÓN M-H 3/4"

LONGITUD	REF.	EUROS	UNID. EMBALAJE	PESO UNID.
83 mm	99000118	12,68	10	0,167
63 mm	99000094	5,66	10	0,108

VENTA BAJO PEDIDO MÍNIMO DE 500 UNIDADES

CAJA ANTIFRAUDE ESTANDAR MULTIDIÁMETRO

Ø CONTADOR	REF.	EUROS	UNID. EMBALAJE	PESO UNID.
13-15-20mm	1040704	1,11	25	0,002

ACCESORIOS CONTADOR

PRECINTO MANUAL

NO PRECISA HERRAMIENTAS



REF.	EUROS	UNID. EMBALAJE	PESO UNID.
1040709	0,55	50	0,002

TENAZA PARA PRECINTO DE PLOMO



Ø	REF.	EUROS	UNID. EMBALAJE	PESO UNID.
11 mm	1040502	50,62	1	0,300
13 mm	1040503	53,62	1	0,400

PLOMO PARA PRECINTO



Ø PLOMO	REF.	EUROS	UNID. EMBALAJE	PESO UNID.
8 mm	1040701	0,063	410 (1kg.Aprox.)	0,002

ROLLO ALAMBRE INOXIDABLE PARA PRECINTO



ROLLO	REF.	EUROS	UNID. EMBALAJE	PESO UNID.
400 mts	1040801	63,90	1	1,22

Revisión A

ACCESORIOS CONTADOR
EMISOR IMPULSOS S20-130 VALOR IMPULSOS 1P-1L-1P-10L ADAPTABLE A LOS MODELOS PFU C, SFU Y SCU DN20

	REF.	EUROS	UNID. EMBALAJE	PESO UNID.
	1060120	16,63	1	0,050

EMISOR IMPULSOS K-10 PARA CONTADOR WOLTMAN Ø50 A 200 VALOR IMPULSOS 1P-100

	REF.	EUROS	UNID. EMBALAJE	PESO UNID.
	NW1060103	18,64	1	0,053

EMISOR IMPULSOS KVS Y MJ-SDC VALOR IMPULSOS 1P-10L-1P-100L

	REF.	EUROS	UNID. EMBALAJE	PESO UNID.
	NW1060101	16,22	1	0,050

EMISOR IMPULSOS SJ-SDC VALOR IMPULSOS 1P-1L-1P-10L

	REF.	EUROS	UNID. EMBALAJE	PESO UNID.
	NW1060100	14,33	1	0,050

Revisión A

ACCESORIOS CONTADOR

CONTADOR PROGRAMABLE CDI-10 220V SALIDA 24V-AC

	REF.	EUROS	UNID. EMBALAJE	PESO UNID.
	1060102	499,41	1	1,300

CONTADOR DE IMPULSOS H7 E C-N 24V-CA MOD. BLM CON SISTEMA PUESTA A CERO

	REF.	EUROS	UNID. EMBALAJE	PESO UNID.
	1060101	204,34	1	0,130

KIT CONTADOR S-110 DN15 DN20 + ELECTROVÁLVULA + CAJA ESTANCA PARA INSTALAR CON CONTADOR PROGRAMABLE CDI-10

	DN	REF.	EUROS	UNID. EMBALAJE	PESO UNID.
	15	1060115	225,63	1	1,100
	20	1060116	262,29	1	1,300

Revisión A

ACCESORIOS CONTADOR
ELECTROVÁLVULA AGUA N.C. 230V AC 50 HC – 24V 50-60 HC

DN	REF.	EUROS	UNID. EMBALAJE	PESO UNID.
15-1/2"	990172	67,27	1	0,450
20-3/4"	990173	86,69	1	0,622
25-1"	990174	104,93	1	1,200
32-1 1/2"	990175	219,69	1	2,900
40-1 1/2"	990176	230,20	1	3,300
50-2"	990177	290,27	1	3,900

ELECTROVÁLVULA AGUA N.A. 230V AC 50 HC – 24V 50-60 HC

DN	REF.	EUROS	UNID. EMBALAJE	PESO UNID.
15-1/2"	990181	82,28	1	0,450
20-3/4"	990182	95,37	1	0,622
25-1"	990183	114,42	1	1,200
32-1 1/2"	990184	259,42	1	2,900
40-1 1/2"	990185	264,79	1	3,300
50-2"	990186	337,00	1	3,900

Revisión A

CALEFACCIÓN

Revisión A

21/09



Revisión A

ÍNDICE

PAG. 99..... CONTADORES DE ENERGIA PARA USO DOMÉSTICO

PAG. 100-101..... MÓDULOS PARA CONTABILIZACIÓN

PAG. 102-104..... ACCESORIOS PARA CALEFACCIÓN

PAG. 105..... CONVERTIDORES DE SEÑAL

PAG. 106..... CENTRALITAS M-BUS Y MÓDEM



Revisión A

CONTADOR DE ENERGÍA TÉRMICA SENSOSTAR 2 ESH

CONTADOR DE ENERGÍA MODELO ESH



MODELO	DN mm	LONGITUD mm	CAUDAL MÁX. m ³ /h	CAUDAL NOM. m ³ /h	CAUDAL MÍN. l/h	TEMP. MÁX. °C	REF.	EUROS	UNID. EMBALAJE	PESO UNID.
ESH	15	110	3	1,5	30	90	660056	182,43	20	0,800
ESH	20	130	5	2,5	50	90	660057	191,23	20	0,950

RACORES INCLUIDOS

CONTADOR DE ENERGÍA MODELO ESH EQUIPADO CON M-BUS



MODELO	DN mm	LONGITUD mm	CAUDAL MÁX. m ³ /h	CAUDAL NOM. m ³ /h	CAUDAL MÍN. l/h	TEMP. MÁX. °C	REF.	EUROS	UNID. EMBALAJE	PESO UNID.
ESH	15	110	3	1,5	30	90	660058	209,80	20	0,800
ESH	20	130	5	2,5	50	90	660059	217,20	20	0,950

RACORES INCLUIDOS

CONTADOR DE ENERGÍA MODELO ESH EQUIPADO CON M-BUS Y ENTRADA DE IMPULSOS



MODELO	DN mm	LONGITUD mm	CAUDAL MÁX. m ³ /h	CAUDAL NOM. m ³ /h	CAUDAL MÍN. l/h	TEMP. MÁX. °C	REF.	EUROS	UNID. EMBALAJE	PESO UNID.
ESH	15	110	3	1,5	30	90	660053	228,18	20	0,800
ESH	20	130	5	2,5	50	90	660054	236,98	20	0,950

RACORES INCLUIDOS

SENSOSTAR 2C BÁSICO CON SONDAS DE TEMPERATURA



VALOR IMPULSOS	TEMP. MÁX. °C	REF.	EUROS	UNID. EMBALAJE	PESO UNID.
VARIABLE	150	660060	286,73	1	0,310

SENSOSTAR 2C CON M-BUS Y SONDAS DE TEMPERATURA



VALOR IMPULSOS	TEMP. MÁX. °C	REF.	EUROS	UNID. EMBALAJE	PESO UNID.
VARIABLE	150	660095	314,55	1	0,310

Revisión A

MÓDULOS COMPACTOS PARA LA CONTABILIZACIÓN DE LOS CONSUMOS TERMOSANITARIOS EQUIPADOS CON M-BUS Y ENTRADA DE IMPULSOS



**KIT CALEFACCIÓN SERIE BS-K80 CON ANCLAJES DE SUJECCIÓN
DN15 2 VÍAS CONEXIÓN 3/4" R/M**

REF.	EUROS	UNID. DE EMBALAJE	PESO UNID.
560080	513,52	1	2,900

**KIT CALEFACCIÓN SERIE BS-K80 CON ANCLAJES DE SUJECCIÓN
DN20 2 VÍAS CONEXIÓN 3/4" R/M**

REF.	EUROS	UNID. DE EMBALAJE	PESO UNID.
560081	540,61	1	3,000

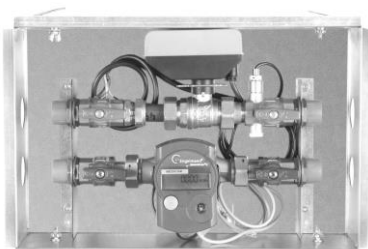

**KIT CALEFACCIÓN SERIE BS-K80 CON ARMARIO METÁLICO
DN 15 2 VÍAS CONEXIÓN 3/4" R/M**

REF.	EUROS	UNID. DE EMBALAJE	PESO UNID.
540080	611,45	1	5,000

**KIT CALEFACCIÓN SERIE BS-K80 CON ARMARIO METÁLICO
DN 20 2 VÍAS CONEXIÓN 3/4" R/M**

REF.	EUROS	UNID. DE EMBALAJE	PESO UNID.
540081	620,23	1	5,300

Revisión A

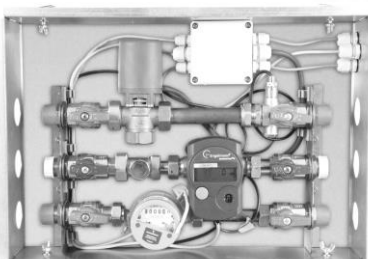

**MÓDULO DE USUARIO SERIE BS-K100VZ - 2 VIAS DN 15
CONEXIÓN 3/4" R/M**

REF.	EUROS	UNID. DE EMBALAJE	PESO UNID.
540100	749,89	1	17,500

**MÓDULO DE USUARIO SERIE BS-K100VZ - 2 VIAS DN 20
CONEXIÓN 3/4" R/M**

REF.	EUROS	UNID. DE EMBALAJE	PESO UNID.
540101	763,07	1	17,500

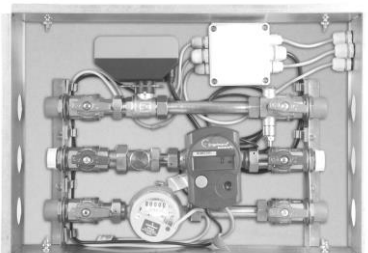

**MÓDULO DE USUARIO SERIE BS-K120SV - 2 VIAS DN 15
CONEXIÓN 3/4" R/M**

REF.	EUROS	UNID. DE EMBALAJE	PESO UNID.
540120	840,08	1	17,500

**MÓDULO DE USUARIO SERIE BS-K120SV - 2 VIAS DN 20
CONEXIÓN 3/4" R/M**

REF.	EUROS	UNID. DE EMBALAJE	PESO UNID.
540121	858,70	1	18,000

PARA INFORMACIÓN MÁS DETALLADA CONSULTAR EL CATALOGO TÉCNICO
MONTAJE ESTANDAR CON CONEXIÓN DE ENTRADA POR LA IZQUIERDA

MÓDULOS COMPACTOS PARA LA CONTABILIZACIÓN DE LOS CONSUMOS TERMOSANITARIOS EQUIPADOS CON M-BUS, ENTRADA DE IMPULSOS

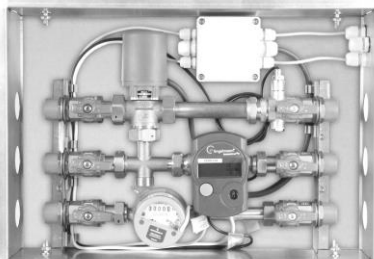

**MÓDULO DE USUARIO SERIE BS-K220VZ – 3 VIAS SIN REGULACIÓN
DN15 CONEXIÓN ¾" R/M**

REF.	EUROS	UNID. DE EMBALAJE	PESO UNID.
540220	746,72	1	18,000

**MÓDULO DE USUARIO SERIE BS-K220VZ – 3 VIAS SIN REGULACIÓN
DN20 CONEXIÓN ¾" R/M**

REF.	EUROS	UNID. DE EMBALAJE	PESO UNID.
540221	767,38	1	18,100

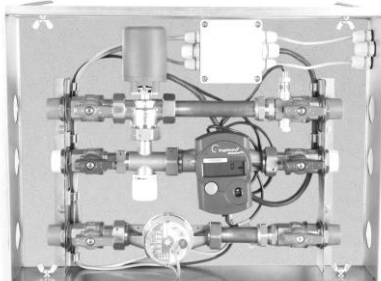

**MÓDULO DE USUARIO SERIE BS-K240VZ – 3 VIAS CON REGULACIÓN
DN15 CONEXIÓN ¾" R/M**

REF.	EUROS	UNID. DE EMBALAJE	PESO UNID.
540240	760,23	1	18,700

**MÓDULO DE USUARIO SERIE BS-K240VZ – 3 VIAS CON REGULACIÓN
DN20 CONEXIÓN ¾" R/M**

REF.	EUROS	UNID. DE EMBALAJE	PESO UNID.
540241	770,52	1	19,000

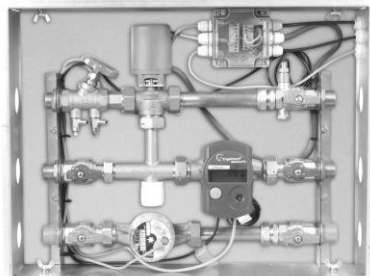

**MÓDULO DE USUARIO SERIE BS-K260VZ – 3 VIAS CON VÁLVULA DE
EQUILIBRADO Y BY-PASS REGULABLE DN15 CONEXIÓN ¾" R/M**

REF.	EUROS	UNID. DE EMBALAJE	PESO UNID.
540260	777,79	1	18,700

**MÓDULO DE USUARIO SERIE BS-K260VZ – 3 VIAS CON VÁLVULA DE
EQUILIBRADO Y BY-PASS REGULABLE DN20 CONEXIÓN ¾" R/M**

REF.	EUROS	UNID. DE EMBALAJE	PESO UNID.
540261	786,43	1	19,100

PARA INFORMACIÓN MÁS DETALLADA CONSULTAR EL CATALOGO TÉCNICO
MONTAJE ESTANDAR CON CONEXIÓN DE ENTRADA POR LA IZQUIERDA

Revisión A

**VÁLVULA TERMOSTÁTICA CAMPO DE REGULACIÓN: 30°-55°C PRECISIÓN ±2°
PRESIÓN DE EJERCICIO 10 BAR. MÁX. ESTÁTICA 5 BAR. DINÁMICA TEMPERATURA MÁX. DE ENTRADA
85° CAUDAL CON 3 BAR. 3000 L/H A 40°**



ROSCA GAS	REF.	EUROS	UNID. EMBALAJE	PESO UNID.
3/4" MACHO	990187	90,66	1	0,343
1" MACHO	990188	174,67	1	0,432

*Hasta fin de existencias

VÁLVULA DE ZONA 2 VIAS CONEXIÓN H-H 220 VS/24VS C.A.



ROSCA GAS	REF.	EUROS	UNID. EMBALAJE	PESO UNID.
1/2"	SF15-2BS	101,17	1	0,810
3/4"	SF20-2BS	102,42	1	0,980
1"	SF25-2BS	107,00	1	1,282

*Hasta fin de existencias

VÁLVULA DE ZONA 3 VIAS CONEXIÓN MACHO 220 VS



ROSCA GAS	REF.	EUROS	UNID. EMBALAJE	PESO UNID.
3/4"	SF20E2BS	104,52	1	1,100
1"	SF25E2BS	108,35	1	1,310

*Hasta fin de existencias

COLECTOR ABIERTO COMPONIBLE M-H CONEXIONES 1/2" M-Ø 12-14-15 y 16



COLECTOR/N° SALIDAS	REF.	EUROS	UNID. EMBALAJE	PESO UNID.
3/4" - 2	170025	6,19	10	0,150
3/4" - 3	170026	11,79	10	0,226
1" - 2	170028	9,67	10	0,235
1" - 3	170029	13,24	10	0,353
1" - 4	170030	16,11	10	0,416
1" - 5	170031	17,84	10	0,519

*Hasta fin de existencias

COLECTOR COMPONIBLE PARA A.C.S. CON VÁLVULAS 3/4" M-H CONEXIONES 1/2" M-Ø 12-14-15 y 16



N° SALIDAS	COLOR VOLANTE	REF.	EUROS	UNID. EMBALAJE	PESO UNID.
2	AZUL	170032	30,82	5	0,311
2	ROJO	170033	25,60	5	0,311
3	AZUL	170034	30,86	5	0,446
3	ROJO	170035	30,86	5	0,446
4	AZUL	170036	46,05	5	0,620
4	ROJO	170037	46,05	5	0,620

*Hasta fin de existencias

Revisión A

CONJUNTO RACOR Y BICONO

MEDIDA	REF.	EUROS	UNID. EMBALAJE	PESO UNID.
1/2" x 10	1040012	1,21	50	0,038
1/2" x 12	1040013	1,15	50	0,042
1/2" x 14	1040014	1,15	50	0,046
1/2" x 15	1040015	0,95	50	0,051
1/2" x 16	1040016	0,89	50	0,056

*Hasta fin de existencias

RACOR PARA TUBO MULTICAPA Y PLÁSTICO

MEDIDA	REF.	EUROS	UNID. EMBALAJE	PESO UNID.
1/2" x 14 x 10	1040017	1,79	50	0,039
1/2" x 16 x 12	1040018	1,71	50	0,045

*Hasta fin de existencias

CAJA DE PLÁSTICO PARA COLECTOR

MEDIDA	REF.	EUROS	UNID. EMBALAJE	PESO UNID.
32 x 26 x 9,5	530121	30,41	1	1,320
40 x 26 x 9,5	530122	33,78	1	1,410
50 x 26 x 9,5	530123	36,72	1	1,630

*Hasta fin de existencias

CAJA METÁLICA PARA EMPOTRAR

MEDIDA	REF.	EUROS	UNID. EMBALAJE	PESO UNID.
450 x 400	530124	111,04	1	3,500
450 x 600	530125	132,08	1	4,700
450 x 800	530126	158,65	1	6,500
450 x 1000	530127	253,97	1	8,400

*Hasta fin de existencias

SOPORTE METÁLICO MULTIDIÁMETRO PARA COLECTORES



MEDIDA	REF.	EUROS	UNID. EMBALAJE	PESO UNID.
3/4"-1"-1 1/4"	539904	7,84	2	0,310

*Hasta fin de existencias

Revisión A

ACCESORIOS

CONJUNTO SENSOR DE TEMPERATURA

	Ø SENSOR	LONG. SENSOR	REF.	EUROS	UNID. EMBALAJE	PESO UNID.
	5,0 mm	45 mm	SS3-106	68,54	2	0,064
	5,2 mm	105 mm	SM3-107	75,16	2	0,088
HASTA FIN DE EXISTENCIAS	6,0 mm	140 mm	SL3-108	114,89	2	0,104

PORTASONDAS PARA CONTADOR DN15 Y DN20

	ROSCA GAS	LONGITUD	REF.	EUROS	UNID. EMBALAJE	PESO UNID.
	G-1/2" x M-10	40 mm	EGM1520	5,57	2	0,070

PORTASONDAS PARA SENSOR DE TEMPERATURA

	ROSCA GAS	LONGITUD	REF.	EUROS	UNID. EMBALAJE	PESO UNID.
	G-1/2"	120 mm	PL-111	81,48	2	0,034
	G-1/2"	85 mm	PM-110	67,93	2	0,113
	G-1/4"	35 mm	PS-109	20,32	2	0,117

VÁLVULA PORTASONDAS

	ROSCA GAS	REF.	EUROS	UNID. EMBALAJE	PESO UNID.
	3/4" x M10	99000037	11,30	50	0,270

VÁLVULA DE EQUILIBRADO REGULACIÓN MICROMÉTRICA

	ROSCA GAS	REF.	EUROS	UNID. EMBALAJE	PESO UNID.
	3/4" H-H	990189	13,98	5	0,316
	1" H-H	990190	20,40	5	0,457

*Hasta fin de existencias

LLAVE DE TARADO REGULACIÓN MICROMÉTRICA

	REF.	EUROS	UNID. EMBALAJE	PESO UNID.
	990191	40,27	1	0,130

*Hasta fin de existencias

Revisión A

**CONVERTIDORES DE SEÑAL
ENTRADA IMPULSOS SALIDA M-BUS**

PAD PULS M 1

	REF.	EUROS	UNID. EMBALAJE	PESO UNID.
	IM001G	129,49	1	0,050

PAD PULS M 2

	REF.	EUROS	UNID. EMBALAJE	PESO UNID.
	IM002G	240,86	1	0,065

PAD PULS M 4

	REF.	EUROS	UNID. EMBALAJE	PESO UNID.
	IM004G	264,28	1	0,150

M-BUS MICRO-MASTER MÓDULO DE CONFIGURACIÓN

	REF.	EUROS	UNID. EMBALAJE	PESO UNID.
	MR003USB	439,41	1	0,098

Revisión A

CENTRALITAS

M-BUS MASTER FAMILY C20



REF.	EUROS	UNID. EMBALAJE	PESO UNID.
20MR006DL	1.108,19	1	0,220

M-BUS MASTER FAMILY W60



REF.	EUROS	UNID. EMBALAJE	PESO UNID.
60MR004DL	1.432,43	1	0,310

M-BUS CENTRAL UNIT 120/250



REF.	EUROS	UNID. EMBALAJE	PESO UNID.
250DR001	3.046,00	1	1,200
120DR002	2.798,48	1	1,380

Revisión A

MODEM GSM PARA CENTRALITA M-BUS

(SE SUMINISTRA CONFIGURADO)



REF.	EUROS	UNID. EMBALAJE	PESO UNID.
MOD00001	324,66	1	0,216

MODEM TERMINAL GSM SINTEON MC52IT+ANTENA



REF.	EUROS	UNID. EMBALAJE	PESO UNID.
MOD00005	671,14	1	0,294

ACCESORIOS PARA OBRA CIVIL Y RIEGO

Revisión A

21/09



Revisión A

ÍNDICE

PAG. 109-110.....	VÁLVULAS COMPUERTA Y FILTROS
PAG. 111.....	VÁLVULAS RETENCIÓN PORTABRIDAS PVC Y BRIDAS PARA PORTABRIDAS
PAG. 112.....	BRIDAS PLANAS SOLDAR Y ROSCADAS
PAG. 113.....	BRIDAS DOBLE CÁMARA Y UNIÓN UNIVERSAL CON BRIDA
PAG. 114.....	BRIDAS REDUCTORAS
PAG. 115-116.....	UNIONES GIBault – MULTIMEDIDA
PAG. 117.....	BRIDAS MULTIMEDIDA - ANTITRACCIÓN
PAG. 118-119.....	COLLARINES
PAG. 120.....	CABEZAL ROSCADO Y BANDA DE ACERO INOXIDABLE
PAG. 121-125.....	CABEZAL BRIDA Y UNIÓN ARPOL EN ACERO INOXIDABLE
PAG. 126-127.....	ABRAZADERAS DE REPARACIÓN
PAG. 128.....	VENTOSAS

Revisión A

ACCESORIOS PARA OBRA CIVIL Y RIEGO
VÁLVULA DE COMPUERTA DE CIERRE ELÁSTICO TIPO BRIDA (GGG-40)

DN	REF.	EUROS	UNID. EMBALAJE	PESO UNID.
50	200401	113,12	1	10,000
60	200402	141,08	1	13,000
80	200403	177,41	1	21,000
100	200404	216,90	1	23,000
125	200405	305,58	1	31,000
150	200406	279,93	1	42,000
200	200407	445,48	1	67,000

LAS VÁLVULAS DE COMPUERTA SE SIRVEN CON VOLANTE. PARA VÁLVULAS CON CUADRADILLO ESPECIFICAR EN PEDIDO

VÁLVULA COMPUERTA CIERRE ELÁSTICO CONEXIÓN PARA PVC CON VOLANTE (GGG-40)

DN	REF.	EUROS	UNID. EMBALAJE	PESO UNID.
50	200201	111,37	1	9,500
65	200202	144,48	1	12,000
80	200203	174,58	1	15,000
100	200204	228,76	1	19,000
125	200205	355,18	1	25,000
150	200206	391,30	1	34,000
200	200207	541,80	1	55,000
250	200208	827,75	1	86,000
300	200209	1.249,15	1	120,000

LAS VÁLVULAS DE COMPUERTA SE SIRVEN CON VOLANTE. PARA VÁLVULAS CON CUADRADILLO ESPECIFICAR EN PEDIDO

VÁLVULA DE REGISTRO ROSCA HEMBRA (GGG-40)

DN	REF.	EUROS	UNID. EMBALAJE	PESO UNID.
20	200561	82,78	1	3,000
25	200562	82,78	1	3,000
32	200563	93,31	1	4,000
40	200564	114,38	1	5,000
50	200565	147,49	1	6,000

Revisión A

ACCESORIOS PARA OBRA CIVIL Y RIEGO

VÁLVULA DE MARIPOSA EN ACERO INOXIDABLE TIPO WAFER



DN	REF.	EUROS	UNID. EMBALAJE	PESO UNID.
50	200361	46,96	1	4,000
65	200362	57,37	1	5,000
80	200363	63,42	1	6,000
100	200364	84,07	1	7,300
125	200365	117,63	1	11,000
150	200366	147,37	1	12,000
200	200367	231,62	1	13,000
250	200368	390,28	1	34,000
300	200369	577,44	1	46,000

VÁLVULA DE MARIPOSA TIPO WAFER



DN	REF.	EUROS	UNID. EMBALAJE	PESO UNID.
50 - 2"	200461	42,07	1	4,000
65 - 2 1/2"	200462	49,16	1	5,000
80 - 3"	200463	53,58	1	6,000
100 - 4"	200464	70,10	1	7,300
125 - 5"	200465	96,57	1	11,000
150 - 6"	200466	107,28	1	12,000
200 - 8"	200467	173,43	1	13,000

FILTRO DE FUNDICIÓN CON BRIDAS (GGG-40)



DN	REF.	EUROS	UNID. EMBALAJE	PESO UNID.
50	220104	77,90	1	8,500
65	220105	101,14	1	12,000
80	220106	131,09	1	15,000
100	220107	155,14	1	22,000
125	220108	250,64	1	34,000
150	220109	348,53	1	45,000
200	220110	554,44	1	75,000

Revisión A

ACCESORIOS PARA OBRA CIVIL Y RIEGO

VÁLVULA RETENCIÓN DOBLE CLAPETA



DN	REF.	EUROS	UNID. EMBALAJE	PESO UNID.
50	210401	38,56	1	1,600
65	210402	43,09	1	2,200
80	210403	58,94	1	3,500
100	210404	85,39	1	4,700
125	210405	117,47	1	6,500
150	210406	162,03	1	8,000
200	210407	274,69	1	14,000

MANGUITO PORTABRIDAS PVC



DN	REF.	EUROS	UNID. EMBALAJE	PESO UNID.
50	2000001	0,99	1	0,140
63	2000002	1,47	1	0,165
75	2000003	2,41	1	0,205
90	2000004	3,43	1	0,298
110	2000005	5,96	1	0,387
125	2000006	7,01	1	0,416
140	2000007	9,30	1	0,596
160	2000008	14,06	1	0,832
200	2000009	22,91	1	1,310
250	2000010	33,68	1	1,600

Revisión A

BRIDA PLANA PORTABRIDAS PN10-16



DN	REF.	EUROS	UNID. EMBALAJE	PESO UNID.
63	2100001	10,78	1	2,000
75	2100002	13,15	1	2,000
90	2100003	14,93	1	2,270
110	2100004	19,57	1	2,410
125	2100005	19,57	1	2,970
160	2100007	24,23	1	3,580
200	2100008	35,70	1	5,430

BRIDAS PN10/16

BRIDA PLANA PARA SOLDAR PN-10/16 – DIN-2576



DN	PN	PULGADAS	REF.	EUROS	UNID. EMBALAJE	PESO UNID.
32	10	1 1/4"	1010701	10,91	1	1,870
40	10	1 1/2"	1010702	11,94	1	2,200
50	10	2"	1010703	13,79	1	2,820
65	10	2 1/2"	1010704	14,83	1	3,450
80	10	3"	1010705	17,39	1	4,210
100	16	4"	1010706	24,68	1	4,650
125	16	5"	1010707	28,56	1	5,970
150	16	6"	1010708	39,98	1	6,980

BRIDA PLANA ROSCADA PN-10/16 – DIN-2576 ZINCADA



DN	PN	PULGADAS	REF.	EUROS	UNID. EMBALAJE	PESO UNID.
32	10	1 1/4"	1010801	11,94	1	1,870
40	10	1 1/2"	1010802	13,64	1	2,200
50	10	2"	1010803	17,73	1	2,820
65	10	2 1/2"	1010804	23,53	1	3,450
80	10	3"	1010805	28,99	1	4,210
100	16	4"	1010806	31,71	1	4,650

BRIDAS PN6

BRIDA PLANA PARA PORTABRIDAS PN-6 – DIN-2573 ZINCADA



DN	PN	PULGADAS	REF.	EUROS	UNID. EMBALAJE	PESO UNID.
50	6	2"	10040815	9,23	1	1,221
65	6	2 1/2"	10040813	11,16	1	1,477
80	6	3"	10040814	18,26	1	2,534

CONSULTAR DISPONIBILIDAD

BRIDA PLANA ROSCADA PN-6 – DIN-2573 ZINCADA



DN	PN	PULGADAS	REF.	EUROS	UNID. EMBALAJE	PESO UNID.
50	6	2"	10031113	12,28	1	1,509
65	6	2 1/2"	10031114	15,60	1	1,965
80	6	3"	10031115	23,02	1	3,047

CONSULTAR DISPONIBILIDAD

Revisión A

ACCESORIOS PARA OBRA CIVIL Y RIEGO

BRIDA DOBLE CÁMARA P-E CON CIERRE DE METAL



TUBO Ø	BRIDA DN	REF.	EUROS	UNID. EMBALAJE	PESO UNID.
63	50 - 2"	1011101	28,60	1	2,800
75	65 - 2 1/2"	1011102	31,91	1	2,950
90	80 - 3"	1011103	35,52	1	3,600
110	100 - 4"	1011104	45,93	1	4,300
125	125 - 5"	1011105	55,38	1	5,500
160	150 - 6"	1011107	80,25	1	7,300
200	200 - 8"	1011109	177,06	1	12,000

BRIDA DOBLE CÁMARA PVC



TUBO Ø	BRIDA DN	REF.	EUROS	UNID. EMBALAJE	PESO UNID.
63	65 - 2 1/2"	1011001	27,49	1	2,800
75	65 - 2 1/2"	1011002	31,64	1	2,950
90	80 - 3"	1011003	36,54	1	3,600
110	100 - 4"	1011004	43,28	1	4,300
125	125 - 5"	1011005	39,19	1	5,500
140	125 - 5"	1011006	42,29	1	5,500
160	150 - 6"	1011007	55,53	1	7,300
200	200 - 8"	1011009	124,58	1	12,000

UNIÓN UNIVERSAL CON BRIDA



TUBO Ø	MÍN.	MÁX.	REF.	EUROS	UNID. EMBALAJE	PESO UNID.
65	72	85	290101	56,65	1	4,500
80	88	103	290102	64,98	1	4,900
100	108	128	290103	66,22	1	5,500
125	132	154	290104	104,42	1	7,800
150	159	182	290105	112,49	1	8,300
200	218	238	290107	167,38	1	11,300

Revisión A

ACCESORIOS PARA OBRA CIVIL Y RIEGO

BRIDA REDUCTORA



DN	REF.	EUROS	UNID. EMBALAJE	PESO UNID.
080-050	1010901	49,85	1	3,790
080-060	1010902	51,02	1	3,500
100-050	1010903	55,62	1	4,330
100-060	1010904	57,67	1	4,000
100-080	1010905	75,64	1	4,500
125-060	1010907	61,98	1	5,460
125-080	1010908	75,46	1	5,700
125-100	1010909	74,53	1	5,800
150-060	1010911	71,40	1	6,570
150-080	1010912	86,60	1	6,500
150-100	1010913	87,41	1	6,500
200-100	1010916	113,99	1	9,600
200-150	1010918	113,12	1	9,650
250-100	1010921	204,53	1	12,600
250-150	1010923	178,46	1	12,900
250-200	1010924	198,06	1	13,100

Revisión A

ACCESORIOS PARA OBRA CIVIL Y RIEGO

UNIÓN GIBALT PARA PVC CON TORNILLO ACERO ZINCADO



DN	LONGITUD	REF.	EUROS	UNID. EMBALAJE	PESO UNID.
63	105	340001	12,49	1	1,250
75	104	340002	14,56	1	2,000
90	116	340003	17,49	1	2,900
110	109	340004	24,33	1	4,000
125	114	340005	28,08	1	4,800
140	135	340006	30,92	1	5,000
160	156	340007	38,07	1	6,000
180	158	340008	49,53	1	8,000
200	158	340009	69,88	1	10,000

UNIÓN MULTIMEDIDA PN16 CON TOLERANCIA



DN	TOLERANCIA Mín. - Máx.	REF.	EUROS	UNID. EMBALAJE	PESO UNID.
65	68-85	360001	53,90	1	4,500
80	84-106	360002	69,44	1	5,000
100	109-133	360003	84,61	1	5,700
125	132-157	360004	116,68	1	7,500
150	157-183	360005	120,58	1	8,900
175	193-215	360006	144,12	1	9,700
200	218-242	360007	167,75	1	10,000

UNION DE TRANSICIÓN AUTOBLOCANTE UNIVERSAL



TOLERANCIA	REF.	EUROS	UNID. EMBALAJE	PESO UNID.
57-74/63	310001	183,01	1	4,980
68-85/75	310002	191,44	1	5,730
84-106/90	310003	219,13	1	7,380
99-119/90	310004	261,27	1	8,050
99-119/110	310005	276,92	1	8,620
109-133/110	310006	288,96	1	9,690
109-133/125	310007	315,45	1	9,750
132-157/125	310008	341,94	1	11,490
132-157/140	310009	356,38	1	11,560
157-183/160	310010	397,32	1	13,690
193-215/200	310011	516,52	1	17,890
218-242/200	310012	549,02	1	20,250

Revisión A

ACCESORIOS PARA OBRA CIVIL Y RIEGO

UNIÓN MULTIMEDIA PN16



Ø	REF.	EUROS	UNID. EMBALAJE	PESO UNID.
61-94	370001	181,08	1	11,000
81-114	370002	223,52	1	14,300
106-164	370003	241,91	1	15,590
131-164	370004	306,99	1	20,000
156-194	370005	348,02	1	23,480
191-229	370006	390,46	1	27,420
216-257	370007	461,19	1	31,560
241-279	370008	520,61	1	35,090
236-274	370009	536,17	1	35,500
271-309	370010	540,57	1	38,960
311-351	370011	622,47	1	42,340
349-389	370012	647,93	1	44,630
396-434	370013	888,43	1	48,440
436-469	370014	1.007,27	1	53,600
471-504	370015	1.106,30	1	59,080
506-539	370016	1.447,24	1	64,200

Revisión A

UNIÓN MULTIMEDIA GRAN TOLERANCIA PN16



Ø	REF.	EUROS	UNID. EMBALAJE	PESO UNID.
156-194	390001	379,26	1	22,200
191-229	390002	470,76	1	28,800
216-257	390003	517,72	1	32,900
311-349	390004	642,94	1	37,600
351-389	390005	863,27	1	42,000
396-434	390006	866,88	1	45,300
396-434	390007	900,59	1	49,500
396-434	390008	1.059,52	1	56,200
471-504	390009	1.066,74	1	58,000
471-504	390010	1.135,37	1	63,000
506-539	390011	1.225,67	1	65,600
576-609	390012	1.356,91	1	71,000

ACCESORIOS PARA OBRA CIVIL Y RIEGO
BRIDA MULTIMEDIDA

DN	REF.	EUROS	UNID. EMBALAJE	PESO UNID.
300	350001	762,52	1	36,000
300	350002	834,67	1	36,000
350	350003	864,38	1	39,000
400	350004	1.062,44	1	54,000
400	350005	1.157,22	1	57,000
500	350006	1.409,04	1	75,000
500	350007	1.509,48	1	73,000
500	350008	1.762,72	1	83,500

UNIÓN ANTITRACCIÓN PARA PVC Y PE

DN	REF.	EUROS	UNID. EMBALAJE	PESO UNID.
50	330001	57,19	1	2,500
63	330002	63,21	1	2,900
75	330003	69,23	1	3,400
90	330004	75,25	1	4,000
110	330005	96,32	1	5,400
125	330006	130,94	1	6,850
140	330007	150,50	1	8,000
160	330008	165,55	1	8,600
200	330009	240,80	1	12,700
250	330010	466,55	1	24,800
315	330011	677,25	1	32,000
400	330012	1.173,90	1	40,000

Revisión A

BRIDA ANTITRACCIÓN PARA PVC Y PE

DN	REF.	EUROS	UNID. EMBALAJE	PESO UNID.
50/63	320001	60,20	1	3,760
65/75	320002	66,22	1	4,120
80/90	320003	72,24	1	4,420
100/110	320004	87,29	1	6,000
125/125	320005	120,40	1	7,200
125/140	320006	126,42	1	7,940
150/160	320007	144,48	1	8,900
200/200 PN10	320008	192,64	1	12,300
200/200 PN16	320009	192,64	1	12,300
250	320010	379,26	1	24,500
315	320011	475,58	1	29,000
400/400	320012	737,45	1	45,000

ACCESORIOS PARA OBRA CIVIL Y RIEGO

COLLARÍN DE TOMA TIPO ABRAZADERA PARA TUBO P-E Y PVC



Revisión A

DN	ROSCA GAS.	REF.	EUROS	UNID. EMBALAJE	PESO UNID.
50	3/4"	290001-3/4"	18,72	1	1,710
50	1"	290001-1"	18,72	1	1,710
63	3/4"	290002-3/4"	20,80	1	2,300
63	1"	290002-1"	20,80	1	2,300
75	3/4"	290003-3/4"	23,00	1	2,900
75	1"	290003-1"	23,00	1	2,900
75	1 1/4"	290003-1 1/4"	23,84	1	2,900
90	3/4"	290004-3/4"	26,37	1	4,250
90	1"	290004-1"	26,37	1	4,250
90	1 1/4"	290004-1 1/4"	27,15	1	4,250
90	1 1/2"	290004-1 1/2"	27,36	1	4,250
90	2"	290004-2"	27,90	1	4,250
110	3/4"	290005-3/4"	32,66	1	5,100
110	1"	290005-1"	32,66	1	5,100
110	1 1/4"	290005-1 1/4"	33,38	1	5,100
110	1 1/2"	290005-1 1/2"	33,56	1	5,100
110	2"	290005-2"	34,13	1	5,100
125	3/4"	290006-3/4"	42,83	1	6,200
125	1"	290006-1"	42,83	1	6,200
125	1 1/4"	290006-1 1/4"	43,80	1	6,200
125	1 1/2"	290006-1 1/2"	43,98	1	6,200
125	2"	290006-2"	44,58	1	6,200
140	1"	290007-1"	57,01	1	7,050
140	1 1/4"	290007-1 1/4"	57,88	1	7,050
140	1 1/2"	290007-1 1/2"	58,09	1	7,050
140	2"	290007-2"	58,57	1	7,050
160	1"	290008-1"	73,62	1	8,150
160	1 1/4"	290008-1 1/4"	74,50	1	8,150
160	1 1/2"	290008-1 1/2"	74,65	1	8,150
160	2"	290008-2"	75,19	1	8,150

ACCESORIOS PARA OBRA CIVIL Y RIEGO

COLLARÍN FUNDICIÓN SALIDA BRIDA



MEDIDA	REF.	EUROS	UNID. EMBALAJE	PESO UNID.
110/50-65	270001	98,31	1	3,600
110/80	270002	118,83	1	4,300
125/50-65	270003	124,58	1	4,900
125/80	270004	146,71	1	6,300
140/50-65	270005	139,97	1	6,800
140/80-100	270006	151,01	1	7,600
160/50-65	270007	148,90	1	7,400
160/80-100	270008	155,14	1	8,800
200/50-65	270009	171,90	1	8,800
200/80-100	270010	183,61	1	10,000
200/125-150	270011	255,25	1	13,500
250/50-65	270012	236,41	1	11,500
250/80-100	270013	258,41	1	12,800
250/125-150	270014	341,00	1	17,500
315/50-65	270015	418,12	1	22,500
315/80-100	270016	433,11	1	23,500
315/125-150	270017	565,52	1	31,500
355/80-100	270018	437,17	1	21,000
355/125-150	270019	609,62	1	26,000
355/200 PN16	270020	663,25	1	27,000
400/80-100	270021	501,10	1	26,500
400/125-150	270022	674,51	1	36,200
400/200 PN16	270023	732,97	1	40,000
500/80-100	270024	657,56	1	39,000
500/125-150	270025	889,85	1	40,000
500/200 PN16	270026	945,65	1	42,000

Revisión A

ACCESORIOS PARA OBRA CIVIL Y RIEGO
CABEZAL ROSCADO UNIVERSAL

TUBERÍA	REF.	EUROS	UNID. EMBALAJE	PESO UNID.
3/4"	300001	19,26	1	1,250
1"	300002	19,26	1	1,250
1 1/4"	300003	25,59	1	1,820
1 1/2"	300004	25,59	1	1,810
2"	300005	25,59	1	1,810
2 1/2"	300006	83,44	1	2,000
3"	300007	102,40	1	2,300

BANDA DE ACERO INOXIDABLE PARA CABEZAL ROSCADO UNIVERSAL

Ø	REF.	EUROS	UNID. EMBALAJE	PESO UNID.
55-89	300201	29,95	1	0,600
89-119	300202	31,61	1	0,650
106-134	300203	32,36	1	0,680
134-160	300204	34,62	1	0,700
157-187	300205	36,12	1	0,720
187-217	300206	39,13	1	0,750
211-245	300207	40,64	1	0,800
241-271	300208	42,14	1	0,850
266-299	300209	45,15	1	0,900
300-331	300210	47,41	1	0,950
316-346	300211	48,91	1	1,000
326-360	300212	54,18	1	1,000
399-435	300213	72,24	1	1,350
451-485	300214	81,27	1	1,440
499-535	300215	85,79	1	1,550
561-595	300216	94,82	1	1,670
621-655	300217	96,08	1	1,750
676-710	300218	99,87	1	1,860

Revisión A

ACCESORIOS PARA OBRA CIVIL Y RIEGO
CABEZAL BRIDA

DN	REF.	EUROS	UNID. EMBALAJE	PESO UNID.
50	300101	69,23	1	5,200
60-65	300102	87,29	1	6,500
80	300103	117,39	1	8,500
100	300104	150,50	1	11,300
125	300105	234,78	1	16,300
150	300106	647,15	1	18,400
200 PN10	300107	752,50	1	35,000
200 PN16	300108	752,50	1	35,000

UNION ARPOL EN ACERO INOXIDABLE PARA CONEXIONES A POLIETILENO

DN	REF.	EUROS	UNID. EMBALAJE	PESO UNID.
63	290201	230,27	1	0,900
75	290202	255,85	1	1,400
90	290203	275,42	1	1,600
110	290204	301,00	1	1,700
125	290205	347,66	1	2,500
140	290206	409,36	1	2,650
160	290207	437,96	1	2,900
180	290208	779,59	1	7,700
200	290209	842,80	1	8,200
250	290210	951,16	1	9,400
315	290211	1.142,30	1	12,500
400	290212	1.480,92	1	18,700

Revisión A

ACCESORIOS PARA OBRA CIVIL Y RIEGO

UNIÓN ARPOL EN ACERO INOXIDABLE
PARA TUBERÍAS DE VARIOS MATERIALES

ANCHO DE UNIÓN 75 mm



Ø	REF.	EUROS	UNID. EMBALAJE	PESO UNID.
47-49	290301	189,63	1	1,590
53-55	290302	189,63	1	1,590
56-58	290303	189,63	1	1,590
60-64	290304	192,64	1	1,590

UNIÓN ARPOL EN ACERO INOXIDABLE
PARA TUBERÍAS DE VARIOS MATERIALES

ANCHO DE UNIÓN 90 mm



Ø	REF.	EUROS	UNID. EMBALAJE	PESO UNID.
74-78	290401	192,64	1	1,590
80-86	290402	198,66	1	1,640
87-93	290403	201,67	1	1,680
98-106	290404	207,69	1	1,810
107-111	290405	209,20	1	1,840
110-116	290406	213,71	1	1,890
118-125	290407	218,23	1	1,970
125-131	290408	218,23	1	1,970
131-136	290409	221,24	1	2,010
137-144	290410	224,25	1	2,050
147-156	290411	230,27	1	2,180
156-162	290412	231,77	1	2,200

Revisión A

ACCESORIOS PARA OBRA CIVIL Y RIEGO

UNIÓN ARPOL EN ACERO INOXIDABLE
PARA TUBERÍAS DE VARIOS MATERIALES

ANCHO DE UNIÓN 140 mm



Ø	REF.	EUROS	UNID. EMBALAJE	PESO UNID.
166-178	290501	338,63	1	7,660
173-185	290502	338,63	1	7,660
186-198	290503	338,63	1	7,660
194-206	290504	338,63	1	7,660
202-214	290505	367,22	1	8,350
217-229	290506	367,22	1	8,350
231-243	290507	367,22	1	8,350
248-260	290508	367,22	1	8,350
271-283	290509	395,82	1	9,050
279-291	290510	395,82	1	9,050
292-304	290511	395,82	1	9,050
310-322	290512	424,41	1	9,740
320-332	290513	424,41	1	9,740
320-341	290514	424,41	1	9,740
338-350	290515	424,41	1	9,740
349-361	290516	424,41	1	9,740
359-371	290517	440,97	1	10,440
372-384	290518	440,97	1	10,440
379-391	290519	440,97	1	10,440
394-406	290520	440,97	1	10,440
403-415	290521	614,04	1	11,130
410-422	290522	614,04	1	11,130
419-431	290523	614,04	1	11,130
425-437	290524	614,04	1	17,260
433-445	290525	614,04	1	17,260
450-462	290526	648,65	1	18,430
467-479	290527	648,65	1	18,430
477-489	290528	648,65	1	18,430
487-499	290529	648,65	1	18,430
493-505	290530	648,65	1	23,180
504-520	290531	740,46	1	23,180
525-541	290532	740,46	1	23,180
539-555	290533	740,46	1	23,180
557-573	290534	779,59	1	23,180
583-599	290535	779,59	1	23,180
599-615	290536	779,59	1	23,180
614-630	290537	1.092,63	1	22,650
630-646	290538	1.092,63	1	22,650
650-666	290539	827,75	1	22,650
676-692	290540	827,75	1	22,650
706-722	290541	1.160,36	1	22,650
719-735	290542	1.160,36	1	22,650

Revisión A

ACCESORIOS PARA OBRA CIVIL Y RIEGO

UNIÓN ARPOL EN ACERO INOXIDABLE
PARA TUBERÍAS DE VARIOS MATERIALES

ANCHO DE UNIÓN 200 mm

Revisión A



Ø	REF.	EUROS	UNID. EMBALAJE	PESO UNID.
88-98	290601	320,56	1	4,250
94-104	290602	323,58	1	4,250
108-118	290603	329,60	1	5,000
120-130	290604	338,63	1	5,250
130-140	290605	353,68	1	6,000
139-149	290606	418,39	1	6,650
150-160	290607	446,99	1	7,660
166-178	290608	463,54	1	7,660
173-185	290609	463,54	1	7,660
186-198	290610	463,54	1	7,660
194-206	290611	463,54	1	7,660
202-214	290612	498,16	1	8,350
217-229	290613	498,16	1	8,350
231-243	290614	498,16	1	8,350
242-254	290615	498,16	1	8,350
248-260	290616	498,16	1	8,350
271-283	290617	532,77	1	9,050
279-291	290618	532,77	1	9,050
292-304	290619	532,77	1	9,050
310-322	290620	565,88	1	9,740
320-332	290621	565,88	1	9,740
329-341	290622	565,88	1	9,740
338-350	290623	565,88	1	9,740
349-361	290624	565,88	1	9,740
359-371	290625	600,50	1	13,210
372-384	290626	600,50	1	13,210
379-391	290627	600,50	1	13,210
394-406	290628	600,50	1	13,210
403-415	290629	635,11	1	14,080
410-422	290630	815,71	1	14,080
419-431	290631	815,71	1	14,080
425-437	290632	815,71	1	14,080
433-445	290633	815,71	1	14,080
450-462	290634	912,03	1	15,970
467-479	290635	912,03	1	15,970
477-489	290636	912,03	1	15,970
487-499	290637	912,03	1	15,970
493-505	290638	912,03	1	15,970
504-520	290639	1.005,34	1	16,100
525-541	290640	1.005,34	1	16,100
539-555	290641	1.005,34	1	16,100

ACCESORIOS PARA OBRA CIVIL Y RIEGO

UNIÓN ARPOL EN ACERO INOXIDABLE
PARA TUBERÍAS DE VARIOS MATERIALES

ANCHO DE UNIÓN 200 mm



Ø	REF.	EUROS	UNID. EMBALAJE	PESO UNID.
548-564	290642	1.005,34	1	16,890
557-573	290643	1.053,50	1	21,470
583-599	290644	1.053,50	1	21,470
599-615	290645	1.053,50	1	21,470
614-630	290646	1.101,66	1	21,470
630-646	290647	1.101,66	1	27,720
650-666	290648	1.148,32	1	27,720
676-692	290649	1.148,32	1	27,720
706-722	290650	1.196,48	1	27,720
719-735	290651	1.196,48	1	40,740
734-750	290652	1.196,48	1	40,740
744-760	290653	1.196,48	1	40,740
757-773	290654	1.745,80	1	40,740
767-783	290655	1.745,80	1	40,740
788-804	290656	1.745,80	1	40,740
808-824	290657	1.812,02	1	44,380
820-836	290658	1.812,02	1	44,380
837-853	290659	1.812,02	1	44,380
851-867	290660	1.878,24	1	44,380
866-882	290661	1.878,24	1	44,380
877-893	290662	1.878,24	1	44,380
900-916	290663	1.942,95	1	46,200
908-924	290664	1.942,95	1	46,200
921-937	290665	1.942,95	1	46,200
938-954	290666	1.942,95	1	46,200
957-973	290667	2.009,18	1	46,200
976-992	290668	2.009,18	1	46,200
987-1003	290669	2.009,18	1	46,200
1010-1026	290670	2.067,87	1	51,660
1042-1058	290671	2.067,87	1	51,660
1055-1071	290672	2.149,14	1	51,660
1078-1094	290673	2.149,14	1	51,660
1084-1100	290674	2.149,14	1	51,660
1097-1113	290675	2.149,14	1	51,660
1112-1128	290676	2.231,92	1	55,310
1124-1140	290677	2.231,92	1	55,310
1148-1164	290678	2.344,79	1	55,310
1172-1188	290679	2.344,79	1	55,310
1193-1209	290680	2.344,79	1	55,310
1208-1224	290681	2.408,00	1	55,310

Revisión A

ACCESORIOS PARA OBRA CIVIL Y RIEGO

ABRAZADERA DE REPARACIÓN 2 CIERRES



Ø	REF.	EUROS	UNID. EMBALAJE	PESO UNID.
140-160	380201	179,10	1	3,500
159-180	380202	183,61	1	3,600
165-185	380203	186,62	1	3,600
168-189	380204	187,37	1	3,650
170-190	380205	191,14	1	3,650
176-196	380206	201,67	1	3,700
190-210	380207	204,68	1	3,760
195-217	380208	210,70	1	3,760
210-230	380209	213,71	1	4,000
216-238	380210	219,73	1	4,000
225-246	380211	234,78	1	4,300
230-250	380212	237,79	1	4,350
240-260	380213	240,80	1	4,400
250-270	380214	243,81	1	4,550
269-289	380215	255,85	1	4,650
273-293	380216	264,88	1	4,650
282-302	380217	270,90	1	4,800
295-315	380218	273,91	1	4,800
299-330	380219	279,93	1	4,800
315-335	380220	285,95	1	4,950
322-344	380221	291,97	1	5,000
337-358	380222	302,14	1	5,200
347-367	380223	301,00	1	5,300
365-385	380224	307,02	1	5,400
382-402	380225	316,05	1	5,000
396-420	380226	319,06	1	5,500
410-430	380227	325,08	1	5,850
420-440	380228	331,10	1	5,900
435-455	380229	335,01	1	5,950

Revisión A

ACCESORIOS PARA OBRA CIVIL Y RIEGO

ABRAZADERA DE REPARACIÓN 1 CIERRE



Ø	REF.	EUROS	UNID. EMBALAJE	PESO UNID.
48-52	380101	75,25	1	1,000
54-58	380102	79,01	1	1,300
60-67	380103	80,52	1	1,350
67-74	380104	82,78	1	1,400
70-77	380105	84,28	1	1,450
73-80	380106	85,03	1	1,500
76-83	380107	85,78	1	1,500
82-89	380108	87,29	1	1,500
87-94	380109	88,79	1	1,500
91-98	380110	91,80	1	1,500
95-102	380111	92,56	1	1,500
98-108	380112	94,06	1	1,650
102-112	380113	94,81	1	1,650
106-116	380114	95,57	1	1,700
108-118	380115	96,32	1	1,700
113-123	380116	97,07	1	1,900
118-128	380117	98,58	1	1,900
120-131	380118	99,33	1	1,950
125-135	380119	100,08	1	1,950
132-142	380120	101,59	1	2,000
135-145	380121	102,34	1	2,000
145-155	380122	103,85	1	2,100
151-161	380123	105,35	1	2,100

Revisión A

ACCESORIOS PARA OBRA CIVIL Y RIEGO

VENTOSA AUTOMÁTICA FUNDICIÓN DOBLE EFECTO GGG40

DN	REF.	EUROS	UNID. EMBALAJE	PESO UNID.
50	670003	263,41	1	8,000
65	670008	322,95	1	10,000
80	670004	433,01	1	13,000
100	670005	640,49	1	23,000
150	670006	1.809,61	1	48,000
200	670007	2.661,20	1	74,000



VENTOSA AUTOMÁTICA FUNDICIÓN TRIPLE EFECTO GGG40

DN	REF.	EUROS	UNID. EMBALAJE	PESO UNID.
50	670103	409,55	1	9,000
65	670108	460,07	1	10,000
80	670104	595,39	1	15,000
100	670105	808,28	1	25,000
150	670106	2.157,82	1	52,000
200	670107	3.009,41	1	78,000

Revisión A

VENTOSA AUTOMÁTICA DE POLIAMIDA DOBLE EFECTO

DN	REF.	EUROS	UNID. EMBALAJE	PESO UNID.
32-1"	670009	18,04	1	0,300
60-2"	670010	32,48	1	0,800



VENTOSA AUTOMÁTICA DE POLIAMIDA TRIPLE EFECTO

DN	REF.	EUROS	UNID. EMBALAJE	PESO UNID.
32-1"	670011	48,71	1	0,400
60-2"	670012	93,82	1	0,900

CONDICIONES GENERALES DE VENTA

PRECIOS

El presente CATÁLOGO/TARIFA anula y sustituye cualquier otro anterior. Así mismo, anula cualquier oferta personalizada anterior.

Las entregas de los pedidos se facturarán al precio en vigor en el momento del pedido.

Con el fin de evitar errores y poder tramitar correctamente, es importante que cada artículo esté acompañado de su correspondiente código identificativo. El cual está referenciado en este mismo catálogo

ÁMBITO

Las presentes condiciones de venta se aplicarán a todos los pedidos. Cualquier variación deberá haber sido expresamente aceptada por **BATERÍAS DEL SURESTE, S.L.U.**, vía fax, correo electrónico o carta.

I.V.A.

No incluido. Se aplicará el tipo vigente.

ENTREGA

La cumplimentación de los pedidos se realizará dentro de los tres días hábiles siguientes a la recepción del pedido, siempre y cuando los artículos sean los incluidos en el siguiente catálogo.

El plazo de entrega se considera hasta el momento de entrega de la mercancía a la agencia de transporte.

Todo artículo especial tiene un plazo de entrega máximo de 21 días tras la confirmación por escrito del pedido, mediante plano acotado y detallado, sellado o firmado.

TRANSPORTE

Portes pagados a partir de 600 € netos de pedido. Para Península y Baleares.

Portes pagados a partir de 1.500 € netos de pedido. Para Canarias, Ceuta y Melilla.

Portes pagados a partir de 1.000 € netos de pedido. Para Portugal.

Las portes correspondientes a los envíos que soliciten URGENTES y que deban ser expedidos por otra Agencia de Transporte distinta a la que **BATERÍAS DEL SURESTE, S.L.U.** tiene contratada, correrán a cargo del consignatario.

Los pedidos por importe inferior al mínimo, se cargará el transporte en factura, descontando la parte proporcional al importe pedido en factura.

CONDICIONES DE PAGO

Todo impuesto aplicable en el momento de facturación del pedido será por parte del comprador.

El plazo máximo de pago será de 60 días fecha factura.

El descuento aplicable para operaciones de contado o recibo domiciliado hasta 30 días es del 2%.

Así mismo, el comprador reembolsará al vendedor, en concepto de daños y perjuicios, las cargas bancarias y judiciales, devengadas a causa del impago de efectos.

RECLAMACIONES Y DEVOLUCIONES

No se admitirán devoluciones ni reclamaciones transcurridos 15 días desde la fecha de recepción de la mercancía. En cualquier caso, las devoluciones de material deberán efectuarse en base a las siguientes normas:

- 1.- Toda devolución de mercancía deberá ser notificada previamente.
- 2.- Toda devolución aceptada deberá haber sido confirmada por escrito por parte de **BATERÍAS DEL SURESTE, S.L.U.**
- 3.- Toda devolución de material deberá ir acompañada de albarán del Sr. Cliente con especificación del material devuelto.
- 4.- En el albarán que acompaña la mercancía deberá reflejar claramente el Número de referencia de la aceptación por parte de **BATERÍAS DEL SURESTE, S.L.U.**
- 5.- En ningún caso se admitirán devoluciones de trabajos especiales que se ajusten a las características y planos solicitados por nuestros clientes.
- 6.- Toda mercancía devuelta debe venir a PORTES PAGADOS.
- 7.- En cualquier caso, no se admitirá mercancía que no se encuentre en perfecto estado. Se procederá a la devolución al cliente de dichos artículos.
- 8.- En caso de devolución por causas ajenas a **BATERÍAS DEL SURESTE, S.L.U.**, se realizará un cargo adicional del 2% en concepto de gastos de manipulación y gestión.
- 9.- Los abonos emitidos serán compensados con facturas posteriores.

En ningún caso **BATERÍAS DEL SURESTE, S.L.U.** se hará cargo de las devoluciones que no cumplan estas normas.

GARANTÍA

La garantía de nuestros productos está limitada a 2 años, fecha de factura o documento de entrega, según Real Decreto Legislativo 1/2007 de 16 de noviembre, por el que se aprueba el texto refundido de la Ley General para la Defensa de los Consumidores y Usuarios y otras leyes complementarias (BOE núm. 287, de 30-11-2007, pp. 49181-49215), salvo que se exprese de forma explícita, lo contrario.

Esta garantía puede sufrir variación, condicionada a futuras leyes o decretos.

BATERÍAS DEL SURESTE, S.L.U. garantiza todos los artículos de cualquier defecto de fabricación. Quedando limitada nuestra responsabilidad a la sustitución de la pieza defectuosa. Una vez que nuestro Departamento Técnico haya analizado y confirmado dicho defecto.

BATERÍAS DEL SURESTE, S.L.U. y el Cliente se someten para cualquier litigio a los Juzgados y Tribunales de Murcia.

DATOS GPS



Formato Decimal: 37.998479, -1.088079

Formato Grados: 37° 59' 54.5244" Latitud

-1° 5' 17.0844" Longitud

MOD.BS TP 01.09.21(A)



Revisión A



Revisión A

21/09



C/ Mayor, 250 - 30006 PUENTE TOCINOS - Murcia (Spain)

Tel's. 968 30 02 13 - 968 30 31 37 / Fax: 968 30 24 74

Web: www.batsur.es / E-mail: batsur@batsur.es



**BUREAU
VERITAS**