

Service Manual

Air Conditioner

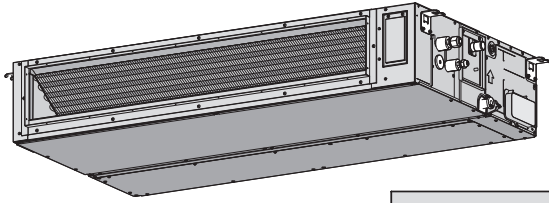

Indoor Unit
WH-ADF0309J3E5CM
S-71WF3E

Outdoor Unit
CU-2WZ71YBE5

Destination
Europe

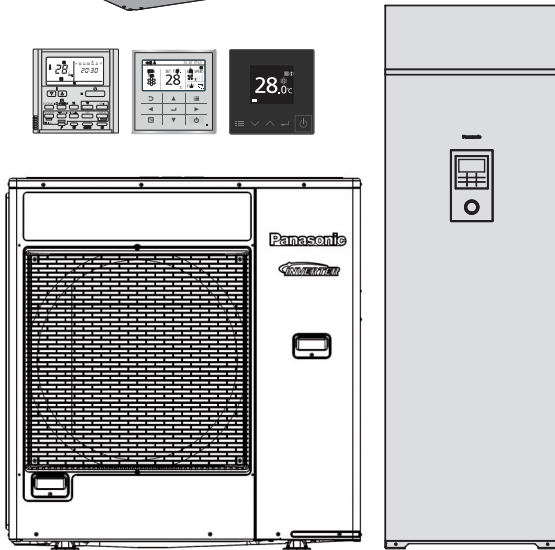

WARNING

This service information is designed for experienced repair technicians only and is not designed for use by the general public. It does not contain warnings or cautions to advise non-technical individuals of potential dangers in attempting to service a product. Products powered by electricity should be serviced or repaired only by experienced professional technicians. Any attempt to service or repair the products dealt with in this service information by anyone else could result in serious injury or death.

IMPORTANT SAFETY NOTICE

There are special components used in this equipment which are important for safety. These parts are marked by  in the Schematic Diagrams, Circuit Board Diagrams, Exploded Views and Replacement Parts List. It is essential that these critical parts should be replaced with manufacturer's specified parts to prevent shock, fire or other hazards. Do not modify the original design without permission of manufacturer.

PRECAUTION OF LOW TEMPERATURE

In order to avoid frostbite, be assured of no refrigerant leakage during the installation or repairing of refrigerant circuit.

CAUTION

R32 REFRIGERANT – This Air Conditioner contains and operates with refrigerant R32.
THIS PRODUCT MUST ONLY BE INSTALLED OR SERVICED BY QUALIFIED PERSONNEL.
 Refer to National, State, Territory and local legislation, regulations, codes, installation & operation manuals, before the installation, maintenance and/or service of this product.

Panasonic®

TABLE OF CONTENTS



	PAGE		PAGE
1. Safety Precautions	4	13.6 Connect The Cable To The Outdoor Unit	173
2. Precaution for Using R32 Refrigerant	8	13.7 Heat Insulation.....	174
3. Specifications	13	14. Operation Control (WH-ADF0309J3E5CM)	176
4. Location of Controls and Components	19	14.1 Basic Function	176
4.1 Tank Unit	19	14.2 Water Pump.....	184
5. Dimensions	38	14.3 Indoor Unit Safety	187
5.1 WH-ADF0309J3E5CM	38	14.4 Auto Restart Control	187
5.2 S-71WF3E	39	14.5 Indication Panel	187
5.3 CU-2WZ71YBE5	40	14.6 Indoor Back-Up Heater Control	188
6. Refrigeration Cycle Diagram	41	14.7 Tank Heater Control	190
6.1 WH-ADF0309J3E5CM	41	14.8 Force Heater Mode.....	191
6.2 S-71WF3E	42	14.9 Quiet Operation	192
6.3 CU-2WZ71YBE5	43	14.10 Sterilization Mode	192
7. Block Diagram	44	14.11 Outdoor Ambient Thermo OFF Control ...	193
7.1 WH-ADF0309J3E5CM	44	14.12 Force DHW mode.....	193
7.2 S-71WF3E	45	14.13 SMART DHW mode	194
7.3 CU-2WZ71YBE5	46	14.14 DHW Capacity Setting.....	194
8. Wiring Connection Diagram	47	14.15 Anti Freeze Control.....	195
8.1 WH-ADF0309J3E5CM	47	14.16 Solar Operation (Optional)	196
8.2 S-71WF3E	48	14.17 Boiler Bivalent Control.....	197
8.3 CU-2WZ71YBE5	49	14.18 External Room Thermostat Control (Optional)	199
9. Electronic Circuit Diagram	50	14.19 Three Ways Valve Control	200
9.1 WH-ADF0309J3E5CM	50	14.20 External OFF/ON Control	201
9.2 S-71WF3E	51	14.21 External Compressor Switch (Optional PCB).	202
9.3 CU-2WZ71YBE5	52	14.22 SG Ready Control (Optional PCB).....	203
10. Printed Circuit Board	53	14.23 Holiday Mode.....	204
10.1 WH-ADF0309J3E5CM	53	14.24 Dry Concrete	205
10.2 S-71WF3E	55	14.25 Flow Sensor.....	205
10.3 CU-2WZ71YBE5	57	14.26 DHW Defrost Operation.....	205
11. Installation Instruction (WH-ADF0309J3E5CM)	59	15. Operation Control (S-71WF3E)	206
11.1 Indoor Floor Area Requirement.....	59	15.1 Cooling Operation.....	206
11.2 Indoor Unit	62	15.2 Dry Mode Operation	206
11.3 Appendix.....	73	15.3 Fan Operation.....	207
11.4 Service and Maintenance.....	96	15.4 Thermostat Control.....	207
12. Installation Instruction (S-71WF3E)	97	15.5 nanoe™X Operation	208
12.1 Indoor Unit Installation.....	97	16. Operation Control (CU-2WZ71YBE5)	209
12.2 Wired Remote Control Installation (Optional	146	16.1 Cooling Operation.....	209
Part).....	146	16.2 Heating Operation (Room Heating / Tank	211
12.3 Operation Instructions	165	Heating)	211
13. Installation Instruction (CU-2WZ71YBE5)	167	17. Simultaneous Operation Control	212
13.1 Installation Information	167	17.1 Simultaneous Operation (Multiple Indoor	212
13.2 Select The Best Location	168	Units)	212
13.3 Install The Outdoor Unit	169	17.2 Simultaneous Operation (Indoor Unit + Tank	213
13.4 Connect The Piping.....	169	Unit)	213
13.5 Air Tightness Test on the Refrigerating	171	18. Protection Control (WH-ADF0309J3E5CM)	214
System.....	171	18.1 Protection Control for Heating Operation	214
			214
		19. Protection Control (CU-2WZ71YBE5)	215
		19.1 Freeze Prevention control (Cool)	215
		19.2 Dew Prevention control (Cool)	215

19.3	Electronic Parts Temperature Rise Protection 1 (Cool)	215	26.2	To Remove Pressure Gauge	293
19.4	Cooling overload control (Cool).....	216	26.3	To Remove Remote Control	293
19.5	Heating overload control (Heat)	216	26.4	To Remove RCCB.....	294
19.6	Extreme Low Temperature Compressor low pressure protection control (Heat).....	216	26.5	To Remove Electronic Controller	294
19.7	Deice Control.....	217	26.6	To Remove Flow Switch and Air Purge Valve	295
19.8	Time Delay Safety Control (Restart Control) .	217	26.7	To Remove Water Pump.....	295
19.9	30 seconds Force Operation.....	217	26.8	To Remove Bottle Complete	296
19.10	Total Current Control.....	217	26.9	To Remove Water Filter	296
19.11	IPM (power transistor) Protection Control	218	27. Disassembly and Assembly Instructions (S-71WF3E)	297	
19.12	Compressor Protection Control (Gas leak detection control 1).....	218	27.1	Indoor Electronic Controller Removal Procedures	297
19.13	Compressor Protection Control (Gas leak detection control 2).....	218	28. Disassembly and Assembly Instructions (CU-2WZ71YBE5).....	298	
19.14	Valve close detection control	218	28.1	Outdoor Unit Removal Procedure	298
19.15	Compressor discharge high pressure protection control.....	219	29. Technical Data (WH-ADF0309J3E5CM).....	301	
19.16	Compressor discharge high temperature protection control.....	219	29.1	Operation Characteristics.....	301
19.17	Cooling Outdoor Air Temperature Control (Cool).....	219	29.2	Heating Capacity Table	301
19.18	Heating Outdoor Air Temperature Control (Heat)	219	30. Technical Data (S-71WF3E).....	302	
20. Servicing Mode.....	220		30.1	Fan Performance.....	302
21. Servicing Guide (WH-ADC0309J3E5CM)	222		30.2	Indoor Fan Performance	303
21.1	How to Take out Front Plate	222	31. Technical Data (CU-2WZ71YBE5).....	304	
21.2	Test Run	222	31.1	Air Cool Mode Performance Data	304
21.3	Expansion Vessel (11) Pre Pressure Checking	222	31.2	Air Heat Mode Performance Data	304
21.4	How To Adjust Pump Speed	223	32. Exploded View and Replacement Parts List	305	
21.5	EEPROM Factory Default Data Setup Procedure.....	224	32.1	WH-ADF0309J3E5CM	305
21.6	Dry Concrete Setup.....	225	32.2	S-71WF3E.....	310
22. Maintenance Guide	227		32.3	CU-2WZ71YBE5	313
22.1	Maintenance for Magnetic Water Filter Set....	230			
23. Breakdown Self Diagnosis Function (WH-ADF0309J3E5CM)	232				
23.1	Self Diagnosis Function (Three Digits Alphanumeric Code).....	232			
23.2	Error Codes Table	234			
24. Troubleshooting Guide (S-71WF3E).....	236				
24.1	Self-Diagnosis Error Code Table	236			
24.2	Self-Diagnostics Method (S-71WF3E).....	241			
25. Troubleshooting Guide (CU-2WZ71YBE5).....	246				
25.1	Self Diagnosis Function (Outdoor LED Diagnosis Table)	246			
25.2	Self-diagnosis Method.....	249			
26. Disassembly and Assembly Instructions (WH-ADF0309J3E5CM)	292				
26.1	To Remove Front Plate and Top Plate.....	292			



• Specifications, designs and contents in this Service Manual are subject to change without notice.

1. Safety Precautions





















- Read the following “SAFETY PRECAUTIONS” carefully before installation.
- Electrical work must be installed by a licensed electrician. Be sure to use the correct rating of the power plug and main circuit for the model to be installed.
- The caution items stated here must be followed because these important contents are related to safety. The meaning of each indication used is as below. Incorrect installation due to ignoring of the instruction will cause harm or damage, and the seriousness is classified by the following indications.















 WARNING	This indication shows the possibility of causing death or serious injury.
 CAUTION	This indication shows the possibility of causing injury or damage to properties only.











- The items to be followed are classified by the symbols:

	Symbol with white background denotes item that is PROHIBITED.
 	Symbol with dark background denotes item that must be carried out.

- Carry out test running to confirm that no abnormality occurs after the installation. Then, explain to user the operation, care and maintenance as stated in instructions. Please remind the customer to keep the operating instructions for future reference.

 WARNING	
1. Do not use means to accelerate the defrosting process or to clean, other than those recommended by the manufacturer. Any unfit method or using incompatible material may cause product damage, burst and serious injury.	
2. Do not install outdoor unit near handrail of veranda. When installing air-conditioner unit on veranda of a high rise building, child may climb up to outdoor unit and cross over the handrail causing an accident.	
3. Do not use unspecified cord, modified cord, joint cord or extension cord for power supply cord. Do not share the single outlet with other electrical appliances. Poor contact, poor insulation or over current will cause electrical shock or fire.	
4. Do not tie up the power supply cord into a bundle by band. Abnormal temperature rise on power supply cord may happen.	
5. Do not insert your fingers or other objects into the unit, high speed rotating fan may cause injury. 	
6. Do not sit or step on the unit, you may fall down accidentally. 	
7. Keep plastic bag (packaging material) away from small children, it may cling to nose and mouth and prevent breathing.  	
8. When installing or relocating air conditioner, do not let any substance other than the specified refrigerant, eg. air etc mix into refrigeration cycle (piping). Mixing of air etc. will cause abnormal high pressure in refrigeration cycle and result in explosion, injury etc.	
9. Auxiliary devices which may be a potential ignition source shall not be installed in the duct work. Examples of such potential ignition sources are hot surfaces with a temperature exceeding 700°C and electric switching devices.	
10. For appliances connected via an air duct system to one or more rooms, only auxiliary devices approved by the appliance manufacturer or declared suitable with the refrigerant shall be installed in connecting ductwork.	
11. Do not pierce or burn as the appliance is pressurized. Do not expose the appliance to heat, flame, sparks, or other sources of ignition. Else, it may explode and cause injury or death.	
12. Do not add or replace refrigerant other than specified type. It may cause product damage, burst and injury etc.	
<ul style="list-style-type: none"> • For R32/R410A model, use piping, flare nut and tools which is specified for R32/R410A refrigerant. Using of existing (R22) piping, flare nut and tools may cause abnormally high pressure in the refrigerant cycle (piping), and possibly result in explosion and injury. • For R32 and R410A, the same flare nut on the outdoor unit side and pipe can be used. 	
13. <ul style="list-style-type: none"> • Since the working pressure for R32/R410A is higher than that of refrigerant R22 model, replacing conventional piping and flare nuts on the outdoor unit side are recommended. • If reuse piping is unavoidable, refer to instruction “IN CASE OF REUSING EXISTING REFRIGERANT PIPING” • Thickness of copper pipes used with R32/R410A must be more than 0.8 mm. Never use copper pipes thinner than 0.8 mm. • It is desirable that the amount of residual oil less than 40 mg/10 m. 	
14. Engage authorized dealer or specialist for installation. If installation done by the user is incorrect, it will cause water leakage, electrical shock or fire.	
15. For refrigeration system work, install according to this installation instructions strictly. If installation is defective, it will cause water leakage, electrical shock or fire.	

 WARNING	
16.	Use the attached accessories parts and specified parts for installation. Otherwise, it will cause the set to fall, water leakage, fire or electrical shock. 
17.	Install at a strong and firm location which is able to withstand weight of the set. If the strength is not enough or installation is not properly done, the set will drop and cause injury. 
18.	For electrical work, follow the national regulation, legislation and this installation instructions. An independent circuit and single outlet must be used. If electrical circuit capacity is not enough or defect found in the electrical work, it will cause electrical shock or fire. 
19.	Do not use joint cable for indoor / outdoor connection cable. Use the specified indoor/outdoor connection cable, refer to instruction ⑤ CONNECT THE CABLE TO THE OUTDOOR UNIT and connect tightly for indoor/outdoor connection. Clamp the cable so that no external force will have impact on the terminal. If connection or fixing is not perfect, it will cause heat up or fire at the connection. 
20.	Wire routing must be properly arranged so that control board cover is fixed properly. If control board cover is not fixed perfectly, it will cause fire or electrical shock. 
21.	This equipment is strongly recommended to be installed with Earth Leakage Circuit Breaker (ELCB) or Residual Current Device (RCD), with sensitivity of 30 mA at 0.1 sec or less. Otherwise, it may cause electrical shock and fire in case of equipment breakdown or insulation breakdown. 
22.	During installation, install the refrigerant piping properly before running the compressor. Operation of compressor without fixing refrigeration piping and valves at opened position will cause suck-in of air, abnormal high pressure in refrigeration cycle and result in explosion, injury etc. 
23.	During pump down operation, stop the compressor before removing the refrigeration piping. Removal of refrigeration piping while compressor is operating and valves are opened will cause suck-in of air, abnormal high pressure in refrigeration cycle and result in explosion, injury etc. 
24.	Tighten the flare nut with torque wrench according to specified method. If the flare nut is over-tightened, after a long period, the flare may break and cause refrigerant gas leakage. 
25.	After completion of installation, confirm there is no leakage of refrigerant gas. It may generate toxic gas when the refrigerant contacts with fire. 
26.	The following checks shall be applied to installations using flammable refrigerants. Appliance shall be installed, operated and stored in a room with a floor area larger than [Amin] m ² . As for [Amin], see the section "INDOOR FLOOR AREA REQUIREMENT". 
27.	Ventilate if there is refrigerant gas leakage during operation. It may cause toxic gas when the refrigerant contacts with fire. 
28.	Be aware that refrigerants may not contain an odour. 
29.	This equipment must be properly earthed. Earth line must not be connected to gas pipe, water pipe, earth of lightning rod and telephone. Otherwise, it may cause electrical shock in case of equipment breakdown or insulation breakdown. 

 CAUTION	
1.	Do not install the unit at place where leakage of flammable gas may occur. In case gas leaks and accumulates at surrounding of the unit, it may cause fire. 
2.	Prevent liquid or vapor from entering sumps or sewers since vapor is heavier than air and may form suffocating atmospheres. 
3.	Do not release refrigerant during piping work for installation, re-installation and during repairing refrigeration parts. Take care of the liquid refrigerant, it may cause frostbite. 
4.	Do not install this appliance in a laundry room or other location where water may drip from the ceiling, etc. 
5.	Do not touch the sharp aluminium fin, sharp parts may cause injury.  
6.	Carry out drainage piping as mentioned in installation instructions. If drainage is not perfect, water may enter the room and damage the furniture. 
7.	Select an installation location which is easy for maintenance. Incorrect installation, service or repair of this air conditioner may increase the risk of rupture and this may result in loss damage or injury and/or property. 
8.	Installation work. It may need two people to carry out the installation work. 
9.	Keep any required ventilation openings clear of obstruction. 

 **WARNING** When Wiring



ELECTRICAL SHOCK CAN CAUSE SEVERE PERSONAL INJURY OR DEATH. ONLY A QUALIFIED, EXPERIENCED ELECTRICIAN SHOULD ATTEMPT TO WIRE THIS SYSTEM.

- Do not supply power to the unit until all wiring and tubing are completed or reconnected and checked.
- Highly dangerous electrical voltages are used in this system. Carefully refer to the wiring diagram and these instructions when wiring. Improper connections and inadequate grounding can cause **accidental injury or death**.
- Connect all wiring tightly. Loose wiring may cause overheating at connection points and a possible fire hazard.
- Provide a power outlet to be used exclusively for each unit.
- Provide a power outlet exclusively for each unit, and full disconnection means having a contact separation by 3 mm in all poles must be incorporated in the fixed wiring in accordance with the wiring rules.
- To prevent possible hazards from insulation failure, the unit must be grounded. 
- Check that cabling will not be subject to wear, corrosion, excessive pressure, vibration, sharp edges or any other adverse environmental effects.
The check shall also take into account the effects of aging or continual vibration from sources such as compressors or fans.
- This equipment is strongly recommended to be installed with Earth Leakage Circuit Breaker (ELCB) or Residual Current Device (RCD). Otherwise, it may cause electrical shock and fire in case of equipment breakdown or insulation breakdown.

When Transporting

- It may need two or more people to carry out the installation work.
- Be careful when picking up and moving the indoor and outdoor units. Get a partner to help, and bend your knees when lifting to reduce strain on your back. Sharp edges or thin aluminum fins on the air conditioner can cut your fingers.

When Storing...

 **WARNING**

- The appliance shall be stored in a well-ventilated area where the room size corresponds to the room area as specified for operation.
- The appliance shall be stored in a room without continuously operating open flames (for example: an operating gas appliance) and ignition sources (for example: an operating electric heater).
- The appliance shall be stored so as to prevent mechanical damage from occurring.

When Installing...

- Select an installation location which is rigid and strong enough to support or hold the unit, and select a location for easy maintenance.
- In cases that require mechanical ventilation, ventilation openings shall be kept clear of obstruction.
- An unventilated area where the appliance using flammable refrigerants is installed shall be so constructed that should any refrigerant leak, it will not stagnate so as to create a fire or explosion hazard.
- Ducts connected to an appliance shall not contain a **potential ignition source**;
- For appliances connected via an air duct system to one or more rooms, the supply and return air shall be directly ducted to the space.

...In a Room

Properly insulate any tubing run inside a room to prevent “sweating” that can cause dripping and water damage to walls and floors.

 **CAUTION** Keep the fire alarm and the air outlet at least 1.5 m away from the unit.

...In Moist or Uneven Locations

Use a raised concrete pad or concrete blocks to provide a solid, level foundation for the outdoor unit. This prevents water damage and abnormal vibration.

...In an Area with High Winds

Securely anchor the outdoor unit down with bolts and a metal frame. Provide a suitable air baffle.

...In a Snowy Area (for Heat Pump-type Systems)

Install the outdoor unit on a raised platform that is higher than drifting snow. Provide snow vents.

...At least 1.8 m (horizontal installation)

Installation height for indoor unit shall be at least 1.8 m.

...In laundry rooms

Do not install in laundry rooms. Indoor unit is not drip proof.

When Connecting Refrigerant Tubing

Pay particular attention to refrigerant leakages.

WARNING

- When performing piping work, do not mix air except for specified refrigerant in refrigeration cycle. It causes capacity down, and risk of explosion and injury due to high tension inside the refrigerant cycle.
- If the refrigerant comes in contact with a flame, it produces a toxic gas.
- Do not add or replace refrigerant other than specified type. It may cause product damage, burst and injury, etc.
- Ventilate the room immediately in the event of a refrigerant gas leakage during installation. Be careful not to allow contact of the refrigerant gas with a flame as this will cause the generation of toxic gas.
- Keep all tubing runs as short as possible.
- Use the flare method for connecting tubing.
- Apply refrigerant lubricant to the matching surfaces of the flare and union tubes before connecting them, then tighten the nut with a torque wrench for a leak-free connection.
- Check carefully for leaks before starting the test run.
- Do not leak refrigerant while piping work for an installation or re-installation, and while repairing refrigeration parts. Handle liquid refrigerant carefully as it may cause frostbite.
- Under no circumstances shall potential sources of ignition be used in the searching or detection of refrigerant leaks.
- A halide torch (or any other detector using a naked flame) shall not be used.
- Electronic leak detectors may be used to detect refrigerant leaks but, the sensitivity may not be adequate, or may need re-calibration. (Detection equipment shall be calibrated in a refrigerant-free area.)
- Ensure that the detector is not a potential source of ignition and is suitable for the refrigerant used.
- Leak detection equipment shall be set at a percentage of the lower flammable limit (LFL) of the refrigerant and shall be calibrated to the refrigerant employed and the appropriate percentage of gas (25 % maximum) is confirmed.
- Leak detection fluids are suitable for use with most refrigerants but the use of detergents containing chlorine shall be avoided as the chlorine may react with the refrigerant and corrode the copper pipe-work.
- If a leak is suspected, all naked flames shall be removed/extinguished.
- If a leakage of refrigerant is found which requires brazing, all of the refrigerant shall be recovered from the system, or isolated (by means of shut off valves) in a part of the system remote from the leak. Oxygen free nitrogen (OFN) shall then be purged through the system both before and during the brazing process.

When Servicing

- Contact the sales dealer or service dealer for a repair.
- Be sure to turn off the power before servicing.
- Turn the power OFF at the main power box (mains), wait at least 5 minutes until it is discharged, then open the unit to check or repair electrical parts and wiring. 
- Keep your fingers and clothing away from any moving parts.
- Clean up the site after you finish, remembering to check that no metal scraps or bits of wiring have been left inside the unit.

WARNING

- This product must not be modified or disassembled under any circumstances. Modified or disassembled unit may cause fire, electric shock or injury.
- Do not clean inside the indoor and outdoor units by users. Engage authorized dealer or specialist for cleaning.
- In case of malfunction of this appliance, do not repair by yourself. Contact the sales dealer or service dealer for a repair and disposal.

CAUTION

- Ventilate any enclosed areas when installing or testing the refrigeration system. Leaked refrigerant gas, on contact with fire or heat, can produce dangerously toxic gas.
- Confirm after installation that no refrigerant gas is leaking. If the gas comes in contact with a burning stove, gas water heater, electric room heater or other heat source, it can cause the generation of toxic gas.

2. Precaution for Using R32 Refrigerant

- Pay careful attention to the following precaution points and the installation work procedures.

 WARNING	
1.	The appliance shall be stored, installed and operated in a well ventilated room with indoor floor area larger than A_{\min} (m ²) [refer Table A] and without any continuously operating ignition source. Keep away from open flames, any operating gas appliances or any operating electric heater. Else, it may explode and cause injury or death. 
2.	The mixing of different refrigerants within a system is prohibited. Models that use refrigerant R32 and R410A have a different charging port thread diameter to prevent erroneous charging with refrigerant R22 and for safety. Therefore, check beforehand. [The charging port thread diameter for R32 and R410A is 12.7 mm (1/2 inch).] 
3.	Ensure that foreign matter (oil, water, etc.) does not enter the piping. Also, when storing the piping, securely seal the opening by pinching, taping, etc. (Handling of R32 is similar to R410A.) 
4.	Operation, maintenance, repairing and refrigerant recovery should be carried out by trained and certified personnel in the use of flammable refrigerants and as recommended by the manufacturer. Any personnel conducting an operation, servicing or maintenance on a system or associated parts of the equipment should be trained and certified. 
5.	Any part of refrigerating circuit (evaporators, air coolers, AHU, condensers or liquid receivers) or piping should not be located in the proximity of heat sources, open flames, operating gas appliance or an operating electric heater. 
6.	The user/owner or their authorized representative shall regularly check the alarms, mechanical ventilation and detectors, at least once a year, where as required by national regulations, to ensure their correct functioning. 
7.	A logbook shall be maintained. The results of these checks shall be recorded in the logbook. 
8.	In case of ventilations in occupied spaces shall be checked to confirm no obstruction. 
9.	Before a new refrigerating system is put into service, the person responsible for placing the system in operation should ensure that trained and certified operating personnel are instructed on the basis of the instruction manual about the construction, supervision, operation and maintenance of the refrigerating system, as well as the safety measures to be observed, and the properties and handling of the refrigerant used. 
10.	The general requirement of trained and certified personnel are indicated as below: a) Knowledge of legislation, regulations and standards relating to flammable refrigerants; and, b) Detailed knowledge of and skills in handling flammable refrigerants, personal protective equipment, refrigerant leakage prevention, handling of cylinders, charging, leak detection, recovery and disposal; and, c) Able to understand and to apply in practice the requirements in the national legislation, regulations and Standards; and, d) Continuously undergo regular and further training to maintain this expertise. 
11.	Air-conditioner piping in the occupied space shall be installed in such a way to protect against accidental damage in operation and service. 
12.	Precautions shall be taken to avoid excessive vibration or pulsation to refrigerating piping. 
13.	Ensure protection devices, refrigerating piping and fittings are well protected against adverse environmental effects (such as the danger of water collecting and freezing in relief pipes or the accumulation of dirt and debris). 
14.	Expansion and contraction of long runs piping in refrigerating systems shall be designed and installed securely (mounted and guarded) to minimize the likelihood hydraulic shock damaging the system. 
15.	Protect the refrigerating system from accidental rupture due to moving furniture or reconstruction activities. 
16.	To ensure no leaking, field-made refrigerant joints indoors shall be tightness tested. The test method shall have a sensitivity of 5 grams per year of refrigerant or better under a pressure of at least 0,25 times the maximum allowable pressure (>1.04 MPa, max 4.15 MPa). No leak shall be detected. 

 CAUTION

General

- Must ensure the installation of pipe-work shall be kept to a minimum. Avoid use dented pipe and do not allow acute bending.
 - Must ensure that pipe-work shall be protected from physical damage.
 - Must comply with national gas regulations, state municipal rules and legislation. Notify relevant authorities in accordance with all applicable regulations.
 - Must ensure mechanical connections be accessible for maintenance purposes.
 - In cases that require mechanical ventilation, ventilation openings shall be kept clear of obstruction.
- 1.
- When disposal of the product, do follow to the precautions in #11 and comply with national regulations.
 - In case of field charge, the effect on refrigerant charge caused by the different pipe length has to be quantified, measured and labelled.
Always contact to local municipal offices for proper handling.
 - Ensure the actual refrigerant charge is in accordance with the room size within which the refrigerant containing parts are installed.
 - Ensure refrigerant charge not to leak.
 - Wear appropriate protective equipment, including respiratory protection, as conditions warrant.
 - Keep all sources of ignition and hot metal surfaces away.



Servicing

2-1. Qualification of workers

- Any qualified person who is involved with working on or breaking into a refrigerant circuit should hold a current valid certificate from an industry-accredited assessment authority, which authorizes their competence to handle refrigerants safely in accordance with an industry recognized assessment specification.
- Servicing shall only be performed as recommended by the equipment manufacturer. Maintenance and repair requiring the assistance of other skilled personnel shall be carried out under the supervision of the person competent in the use of flammable refrigerants.
- Servicing shall be performed only as recommended by the manufacturer.
- The system is inspected, regularly supervised and maintained by a trained and certified service personnel who is employed by the person user or party responsible.

2-2. Checks to the area

- Prior to beginning work on systems containing flammable refrigerants, safety checks are necessary to ensure that the risk of ignition is minimised.
For repair to the refrigerating system, the precautions in #2-3 to #2-7 must be followed before conducting work on the system.

2-3. Work procedure

- Work shall be undertaken under a controlled procedure so as to minimize the risk of a flammable gas or vapour being present while the work is being performed.

2-4. General work area

- All maintenance staff and others working in the local area shall be instructed and supervised on the nature of work being carried out.
- Avoid working in confined spaces. Always ensure away from source, at least 2 meter of safety distance, or zoning of free space area of at least 2 meter in radius.
- The area around the workspace shall be sectioned off. Ensure that the conditions within the area have been made safe by control of flammable material.

2.

2-5. Checking for presence of refrigerant

- The area shall be checked with an appropriate refrigerant detector prior to and during work, to ensure the technician is aware of potentially flammable atmospheres.
- Ensure that the leak detection equipment being used is suitable for use with flammable refrigerants, i.e. non sparking, adequately sealed or intrinsically safe.
- In case of leakage/spillage happened, immediately ventilate area and stay upwind and away from spill/release.
- In case of leakage/spillage happened, do notify persons down wind of the leaking/spill, isolate immediate hazard area and keep unauthorized personnel out.

2-6. Presence of fire extinguisher

- If any hot work is to be conducted on the refrigerating equipment or any associated parts, appropriate fire extinguishing equipment shall be available at hand.
- Have a dry powder or CO₂ fire extinguisher adjacent to the charging area.

2-7. No ignition sources

- No person carrying out work in relation to a refrigerating system which involves exposing any pipe work that contains or has contained flammable refrigerant shall use any sources of ignition in such a manner that it may lead to the risk of fire or explosion. He/She must not be smoking when carrying out such work.
- All possible ignition sources, including cigarette smoking, should be kept sufficiently far away from the site of installation, repairing, removing and disposal, during which flammable refrigerant can possibly be released to the surrounding space.
- Prior to work taking place, the area around the equipment is to be surveyed to make sure that there are no flammable hazards or ignition risks.
- "No Smoking" signs shall be displayed.

2-8. Ventilated area

- Ensure that the area is in the open or that it is adequately ventilated before breaking into the system or conducting any hot work.
- A degree of ventilation shall continue during the period that the work is carried out.
- The ventilation should safely disperse any released refrigerant and preferably expel it externally into the atmosphere.



 CAUTION

2-9. Checks to the refrigerating equipment

- Where electrical components are being changed, they shall be fit for the purpose and to the correct specification.
- At all times the manufacturer's maintenance and service guidelines shall be followed.
- If in doubt consult the manufacturer's technical department for assistance.
- The following checks shall be applied to installations using flammable refrigerants.
 - The actual refrigerant charge is in accordance with the room size within which the refrigerant containing parts are installed.
 - The ventilation machinery and outlets are operating adequately and are not obstructed.
 - If an indirect refrigerating circuit is being used, the secondary circuit shall be checked for the presence of refrigerant.
 - Marking to the equipment continues to be visible and legible. Markings and signs that are illegible shall be corrected.
- Refrigerating pipe or components are installed in a position where they are unlikely to be exposed to any substance which may corrode refrigerant containing components, unless the components are constructed of materials which are inherently resistant to being corroded or are properly protected against being so corroded.

2-10. Checks to electrical devices

- Repair and maintenance to electrical components shall include initial safety checks and component inspection procedures.
2. Initial safety checks shall include but not limit to:-
- That capacitors are discharged: this shall be done in a safe manner to avoid possibility of sparking.
 - That there is no live electrical components and wiring are exposed while charging, recovering or purging the system.
 - That there is continuity of earth bonding.
- At all times the manufacturer's maintenance and service guidelines shall be followed.
 - If in doubt consult the manufacturer's technical department for assistance.
 - If a fault exists that could compromise safety, then no electrical supply shall be connected to the circuit until it is satisfactorily dealt with.
 - If the fault cannot be corrected immediately but it is necessary to continue operation, an adequate temporary solution shall be used.
 - The owner of the equipment must be informed or reported so all parties are advised thereafter.
 - This shall be reported to the owner of the equipment so all parties are advised. Initial safety checks shall include:
 - That capacitors are discharged. This shall be done in a safe manner to avoid possibility of sparking.
 - That no live electrical components and wiring are exposed while charging, recovering or purging the system.
 - That there is continuity of earth bonding.



Repairs to sealed components

- During repairs to sealed components, all electrical supplies shall be disconnected from the equipment being worked upon prior to any removal of sealed covers, etc.
 - If it is absolutely necessary to have an electrical supply to equipment during servicing, then a permanently operating form of leak detection shall be located at the most critical point to warn of a potentially hazardous situation.
 - Particular attention shall be paid to the following to ensure that by working on electrical components, the casing is not altered in such a way that the level of protection is affected. This shall include damage to cables, excessive number of connections, terminals not made to original specification, damage to seals, incorrect fitting of glands, etc.
- 3.
- Ensure that apparatus is mounted securely.
 - Ensure that seals or sealing materials have not degraded such that they no longer serve the purpose of preventing the ingress of flammable atmospheres.
 - Replacement parts shall be in accordance with the manufacturer's specifications.



NOTE:

- The use of silicon sealant may inhibit the effectiveness of some types of leak detection equipment.
- Intrinsically safe components do not have to be isolated prior to working on them.

Repair to intrinsically safe components

- Do not apply any permanent inductive or capacitance loads to the circuit without ensuring that this will not exceed the permissible voltage and current permitted for the equipment in use.
- 4.
- Intrinsically safe components are the only types that can be worked on while live in the presence of a flammable atmosphere.
 - The test apparatus shall be at the correct rating.
 - Replace components only with parts specified by the manufacturer. Unspecified parts by manufacturer may result ignition of refrigerant in the atmosphere from a leak.



Cabling

- 5.
- Check that cabling will not be subject to wear, corrosion, excessive pressure, vibration, sharp edges or any other adverse environmental effects.
 - The check shall also take into account the effects of aging or continual vibration from sources such as compressors or fans.



 CAUTION

Detection of flammable refrigerants

- Under no circumstances shall potential sources of ignition be used in the searching or detection of refrigerant leaks.
 - A halide torch (or any other detector using a naked flame) shall not be used.
 - The following leak detection methods are deemed acceptable for all refrigerant systems.
 - No leaks shall be detected when using detection equipment with a sensitivity of 5 grams per year of refrigerant or better under a pressure of at least 0,25 times the maximum allowable pressure (>1.04 MPa, max 4.15 MPa) for example, a universal sniffer.
 - Electronic leak detectors may be used to detect flammable refrigerants, but the sensitivity may not be adequate, or may need re-calibration.
(Detection equipment shall be calibrated in a refrigerant-free area.)
- 6.
- Ensure that the detector is not a potential source of ignition and is suitable for the refrigerant used.
 - Leak detection equipment shall be set at a percentage of the LFL of the refrigerant and shall be calibrated to the refrigerant employed and the appropriate percentage of gas (25 % maximum) is confirmed.
 - Leak detection fluids are also suitable for use with most refrigerants, for example, bubble method and fluorescent method agents. The use of detergents containing chlorine shall be avoided as the chlorine may react with the refrigerant and corrode the copper pipe-work.
 - If a leak is suspected, all naked flames shall be removed/extinguished.
 - If a leakage of refrigerant is found which requires brazing, all of the refrigerant shall be recovered from the system, or isolated (by means of shut off valves) in a part of the system remote from the leak. The precautions in #7 must be followed to remove the refrigerant.



Removal and evacuation

- When breaking into the refrigerant circuit to make repairs – or for any other purpose – conventional procedures shall be used. However, it is important that best practice is followed since flammability is a consideration. The following procedure shall be adhered to:

- remove refrigerant ->
- purge the circuit with inert gas ->
- evacuate ->
- purge with inert gas ->
- open the circuit by cutting or brazing

- 7.
- The refrigerant charge shall be recovered into the correct recovery cylinders.
 - The system shall be purged with OFN to render the appliance safe. (remark: OFN = oxygen free nitrogen, type of inert gas)
 - This process may need to be repeated several times.
 - Compressed air or oxygen shall not be used for this task.
 - Purging shall be achieved by breaking the vacuum in the system with OFN and continuing to fill until the working pressure is achieved, then venting to atmosphere, and finally pulling down to a vacuum.
 - This process shall be repeated until no refrigerant is within the system.
 - When the final OFN charge is used, the system shall be vented down to atmospheric pressure to enable work to take place.
 - This operation is absolutely vital if brazing operations on the pipe work are to take place.
 - Ensure that the outlet for the vacuum pump is not close to any potential ignition sources and there is ventilation available.



Charging procedures

- In addition to conventional charging procedures, the following requirements shall be followed.
 - Ensure that contamination of different refrigerants does not occur when using charging equipment.
 - Hoses or lines shall be as short as possible to minimize the amount of refrigerant contained in them.
 - Cylinders shall be kept in an appropriate position according to the instructions.
 - Ensure that the refrigerating system is earthed prior to charging the system with refrigerant.
- 8.
- Label the system when charging is complete (if not already).
 - Extreme care shall be taken not to over fill the refrigerating system.
 - Prior to recharging the system it shall be pressure tested with OFN (refer to #7).
 - The system shall be leak tested on completion of charging but prior to commissioning.
 - A follow up leak test shall be carried out prior to leaving the site.
 - Electrostatic charge may accumulate and create a hazardous condition when charging and discharging the refrigerant. To avoid fire or explosion, dissipate static electricity during transfer by grounding and bonding containers and equipment before charging/discharging.



 CAUTION

Decommissioning

- Before carrying out this procedure, it is essential that the technician is completely familiar with the equipment and all its details.
- It is recommended good practice that all refrigerants are recovered safely.
- Prior to the task being carried out, an oil and refrigerant sample shall be taken in case analysis is required prior to re-use of recovered refrigerant.
- It is essential that electrical power is available before the task is commenced.
 - a) Become familiar with the equipment and its operation.
 - b) Isolate system electrically.
 - c) Before attempting the procedure ensure that:

- mechanical handling equipment is available, if required, for handling refrigerant cylinders;
- all personal protective equipment is available and being used correctly;
- the recovery process is supervised at all times by a competent person;
- recovery equipment and cylinders conform to the appropriate standards.

9.



- d) Pump down refrigerant system, if possible.
 - e) If a vacuum is not possible, make a manifold so that refrigerant can be removed from various parts of the system.
 - f) Make sure that cylinder is situated on the scales before recovery takes place.
 - g) Start the recovery machine and operate in accordance with instructions.
 - h) Do not over fill cylinders. (No more than 80 % volume liquid charge).
 - i) Do not exceed the maximum working pressure of the cylinder, even temporarily.
 - j) When the cylinders have been filled correctly and the process completed, make sure that the cylinders and the equipment are removed from site promptly and all isolation valves on the equipment are closed off.
 - k) Recovered refrigerant shall not be charged into another refrigerating system unless it has been cleaned and checked.
- Electrostatic charge may accumulate and create a hazardous condition when charging or discharging the refrigerant. To avoid fire or explosion, dissipate static electricity during transfer by grounding and bonding containers and equipment before charging/discharging.

Labelling

10.
 - Equipment shall be labelled stating that it has been de-commissioned and emptied of refrigerant.
 - The label shall be dated and signed.
 - Ensure that there are labels on the equipment stating the equipment contains flammable refrigerant.



Recovery

11.
 - When removing refrigerant from a system, either for servicing or decommissioning, it is recommended good practice that all refrigerants are removed safely.
 - When transferring refrigerant into cylinders, ensure that only appropriate refrigerant recovery cylinders are employed.
 - Ensure that the correct number of cylinders for holding the total system charge are available.
 - All cylinders to be used are designated for the recovered refrigerant and labelled for that refrigerant (i.e. special cylinders for the recovery of refrigerant).
 - Cylinders shall be complete with pressure relief valve and associated shut-off valves in good working order.
 - Recovery cylinders are evacuated and, if possible, cooled before recovery occurs.
 - The recovery equipment shall be in good working order with a set of instructions concerning the equipment that is at hand and shall be suitable for the recovery of concerning the equipment that is at hand and shall be suitable for the recovery of flammable refrigerants.
11.
 - In addition, a set of calibrated weighing scales shall be available and in good working order.
 - Hoses shall be complete with leak-free disconnect couplings and in good condition.
 - Before using the recovery machine, check that it is in satisfactory working order, has been properly maintained and that any associated electrical components are sealed to prevent ignition in the event of a refrigerant release. Consult manufacturer if in doubt.
 - The recovered refrigerant shall be returned to the refrigerant supplier in the correct recovery cylinder, and the relevant Waste Transfer Note arranged.
 - Do not mix refrigerants in recovery units and especially not in cylinders.
 - If compressors or compressor oils are to be removed, ensure that they have been evacuated to an acceptable level to make certain that flammable refrigerant does not remain within the lubricant.
 - The evacuation process shall be carried out prior to returning the compressor to the suppliers.
 - Only electric heating to the compressor body shall be employed to accelerate this process.
 - When oil is drained from a system, it shall be carried out safely.



3. Specifications

Item		Unit	WH-ADC0309J3E5CM	
Performance Test Condition		EN 16147		
		EN 14825		
Power Supply 1 : Phase (Ø) / Max. Current (A) / Max. Input Power (W)		1 / 21.6 / 4.9k		
Power Supply 2 : Phase (Ø) / Max. Current (A) / Max. Input Power (W)		1 / 13.0 / 3.00k		
Heating Capacity	Condition (Ambient/Water)	A7W35	A2W35	
	kW	8.00	6.70	
	BTU/h	27300	22800	
Heating COP		W/W	4.21	3.25
Current		A	9.0	9.9
Input Power		kW	1.90	2.06
Power Factor		%	92	90
Operation Range	Outdoor Ambient	°C (min./max.)	-15 / 35 (Heating) -15 / 46 (Heat recovery)	
	Water Outlet	°C (min./max.)	Heating (Tank): - / 65*, Heating (Circuit): 20 / 55 (Ambient below -5 °C)	
Internal Pressure Differential		kPa	Cooling: 19.0 Heating: 20.0	
Noise Level	Condition (Ambient/Water)	A7W35	A2W35	
	Pressure Level dB (A) H/L	28 / -	28 / -	
	Power Level dB H / L	41 / -	41 / -	
Dimension	Depth	mm	600	
	Width	mm	598	
	Height	mm	1880	
Net Weight		kg (lbs)	108 (238)	
Refrigerant Pipe Diameter	Liquid	mm (inch)	6.35 (1/4)	
	Gas	mm (inch)	12.70 (1/2)	
Water Pipe Diameter	Room	inch	1-1/4	
	Shower	mm (inch)	3/4	
Water Drain Hose Inner Diameter		mm (inch)	12.00 (17/36)	
Pump	Motor Type		DC Motor	
	Input Power	W	35	
Hot Water Coil	Type		Brazed Plate	
	No. of Plates		38	
	Size (W x H x L)	mm	71.4 x 333 x 121	
	Water Flow Rate	l/min (m³/h)	Heating: 22.90 (1.4)	
Pressure Relief Valve Water Circuit		kPa	Open: 300, Close: 266 and below	
Flow Switch	Type		V VX20 [Electronic pulse]	
	Measuring range	l/min	5 ~ 60	
Pressure Release Valve		kPa	Open: 800, Close: 640 and below	

Item		Unit	WH-ADC0309J3E5CM
Protection Device		A	Earth Leakage Circuit Breaker (30 ~ 40)
Expansion Vessel	Volume	l	10
	MWP	bar	3
Capacity of Integrated Electric Heater / OLP TEMP		kW / °C	3.00 / 80
Tank Volume (Spec / Nett)		L	200 / 185
Max. Tank Water Set Temperature		°C	65
Tank Coil Surface		m ²	1.8
Maximum Working Pressure	Space Heat	Bar	3.0
	Tank Circuit	Bar	8.0
Operating Pressure	Tank Unit	Bar	3.5
	Expansion Relief Valve	Bar	8.0
Expansion Vessel Pre-charge Pressure (DHW Circuit)		Bar	3.5
Pressure Reducing Valve Set Pressure (DHW Circuit)		Bar	3.5

Item		Unit	Indoor Unit
Pressure Vessel	Material		En-1.4521
	Volume	L	185
	Design Pressure	Bar	10
Heat Exchanger	Material		EN-1.4521
	Diameter	mm	22
	Thickness	mm	0.8
	Surface Area	m ²	1.8
	Total Length	m	25

Note:

- In case it is necessary to indicate the air flow volume in (l/s), the value in (m³/min.) shall be multiplied by 16.7 and rounded down the decimal point.
- If the EUROVENT Certified models can be operated under the “extra-low” temperature condition, -7°C DB and -8°C WB temperature with rated voltage 230V shall be used.
- Capacity is measured at outdoor temperature 7°C DB and 6°C WB with controlled water inlet 30°C and water outlet 35°C (EN 14511-2)
- Flowrate indicated are based on nominal capacity adjustment of leaving water temperature (LWT) 35°C and $\Delta T=5^{\circ}\text{C}$.
- EER and COP classification is at 230V only in accordance with EU directive 2003/32/EC.
- * Above 55°C, only possible with backup heater operation.
- ** Between outdoor ambient -10°C and -15°C, the water outlet temperature gradually decreases from 60°C to 55°C.
- *** The sound pressure and sound power level is measured with distance 1.0m from the unit and height at 1.5m. (Test carry out for cooling at ambient 35°C DB and Water Out 7°C, heating at ambient 7°C DB / 6°C WB and water out 55°C)
- **** The sound power level is measured with accordance to EN12102 under conditions of the EN14825.

ITEM			Unit	S-71WF3E	
Performance Test Condition				EN 14511	
				EN 14825	
			Remote Control	*CZ-RTC4, *CZ-RTC5B, *CZ-RTC6 Series (Wired) (Optional part)	
Cooling Capacity (min. ~max.)			kW	7.10 (1.20 ~ 8.10)	
			BTU/h	24200 (4090 ~ 27600)	
Cooling EER			W/W	3.40 (2.55 ~ 2.47)	
Heating Capacity (min. ~max.)			kW	7.10 (2.00 ~ 10.20)	
			BTU/h	24200 (6820 ~ 34800)	
Heating COP			W/W	3.90 (4.65 ~ 3.00)	
Condition				Cooling	Heating
Current			A	10.1	8.7
Input Power			W	2.09k (470 ~ 3.28k)	1.82k (430 ~ 3.40k)
Standard Air Volume			m ³ /min	Cooling: 22.7 Heating: 22.7	
			ft ³ /min	Cooling: 800 Heating (800)	
Outside Dimension (H x W X D)			mm	250 x 1000 x 730	
			inch	9-27/32 x 39-3/8 x 28-3/4	
Net Weight			kg (lbs)	30 (66)	
Piping Connection	Refrigerant	Gas	mm (inch)	O.D. Ø 12.70 (1/2) Flared Type	
		Liquid	mm (inch)	O.D. Ø 6.35 (1/4) Flared Type	
Fan	Type, Number of Set			Sirocco fan-2	
	Motor	Type		10-pole DC motor	
		Rated Output	kW	0.165	
Fan Speed		Hi	rpm	Cooling: 960 Heating: 960	
		Me	rpm	Cooling: 800 Heating: 800	
		Lo	rpm	Cooling: 640 Heating: 640	
Air-heat Exchanger (Row x Stage x FPI)				Slit fin type (2 x 16 x 19)	
Running Adjustment	Control Switch			Wired Remote Control	
	Room Temperature			Thermistor	
Safety Devices				PCB current & temp. protector control for compressor	
Condition				Cooling	Heating
Noise Level			Pressure Level dB (A) H/L/QLo	34 / 26 / -	34 / 26 / -
			Power Level dB (A) H/L/Qlo	57 / - / -	57 / - / -
Moisture Removal			L/h	2.7	

Item		Unit	CU-2WZ71YBE5		
Performance Test Condition		EN14511			
		EN14825			
Cooling Capacity		kW	7.10		
		BTU/h	24200		
Cooling EER		W/W	3.40		
ERP (Average Climate)	Pdesign	kW	7.10		
	SEER	W/W	5.60		
	Annual Consumption	kWh	444		
	Class		A+		
Heating Capacity		kW	7.10		
		BTU/h	24200		
Heating COP		W/W	3.90		
ERP (Average Climate)	Pdesign	kW	4.80		
	Tbivalent	°C	-10		
	SCOP	W/W	3.90		
	Annual Consumption	kWh	1723.00		
	Class		A		
Heating Erp	Low Temperature Application (W35)		Warmer	Average	Colder
	Application	Climate			
	Pdesign	kW	7.0	7.0	6.0
	Tbivalent/TOL	°C	2 / 2	-10 / -10	-15 / -15
	SCOP/ns	(W/W)%	5.69 / 224	4.00 / 157	3.61 / 141
	Annual Consumption	kWh	1644	3614	4101
	Class		A+++	A++	A+
	Medium Temperature Application (W55)		Warmer	Average	Colder
	Application	Climate			
	Pdesign	kW	6.0	7.0	6.0
	Tbivalent/TOL	°C	2 / 2	-7 / -10	-15 / -15
	SCOP/ns	(W/W)%	3.69 / 145	3.20 / 125	2.80 / 109
	Annual Consumption	kWh	2170	4524	5289
	Class		A++	A++	A+
	DHW		Warmer	Average	Colder
	Application	Climate			
	COP/nwh	(W/W)%	3.35 / 134	2.60 / 104	2.30 / 92
	AEC	kWh	760	957	1074
	Class		A+	A	A
	Heat Recovery Capacity		Total	kW	
A2A / A2W			kW		
Heat Recovery COP		W/W	5.11		

Item	Unit	CU-2WZ71YBE5		
Noise Level	Condition	Cooling	Heating	Heat Recovery
	Pressure Level dB (A) H/L	49 / -	49 / -	51 / -
	Power Level dB	68 / -	67 / -	69 / -
Air Flow	m ³ /min (ft ³ /min)	Cooling: 61.8 (2180) Heating: 55.6 (1960)		

Item	Unit	Outdoor Unit	
Refrigeration Control Device		Expansion Valve	
Refrigeration Oil	cm ³	FW50S (900)	
Refrigerant	kg (oz)	R32, 2.40 (84.7) (Pre-charged) R32, 3.20 (112.9) (Maximum)	
F-GAS	GWP	675	
	CO ₂ eq (ton) (Precharged/Maximum)	1.62 / 2.16	
Dimension	Height	mm	999
	Width	mm	940
	Depth	mm	340
Net Weight	kg (lbs)	82 (181)	
Pipe Diameter	Liquid	mm (inch)	6.35 (1/4)
	Gas	mm (inch)	12.70 (1/2)
Standard Length	m (ft)	5 (16)	
Pipe Length Range [1 room]	m (ft)	3 (9.8) ~ 35 (115)	
Pipe Length Range [Max. Total Room]	m (ft)	70 (230)	
I/D & O/D Height Difference	m (ft)	30 (98.4)	
Additional Gas Amount	g/m	20	
Refrigeration Charge Less	m (ft)	30 (98.4)	
Compressor	Type	Hermetic Motor	
	Motor Type	Brushless (4-poles)	
	Rated Output	kW	1.70
Fan	Type	Propeller Fan	
	Material	PP	
	Motor Type	DC (8-poles)	
	Input Power	W	-
	Output Power	W	90
	Fan Speed	rpm	S-71WF3E Cooling: 660 Heating: 600
Heat Exchanger	Fin material	Aluminium (Pre Coat)	
	Fin Type	Corrugated Fin	
	Row × Stage × FPI	2 × 46 × 19	
	Size (W × H × L)	mm	36.4 × 966 × 905:876.5

Item		Unit	Outdoor Unit		
Power Source (Phase, Voltage, Cycle)		Ø	Single		
		V	230		
		Hz	50		
Input Power		Condition	Cooling	Heating	Heat Recovery
		kW	2.09	1.82	3.15
Maximum Input Power For Heatpump System		kW	4.90		
Starting Current		A	10.1		
Running Current		Condition	Cooling	Heating	Heat Recovery
		A	10.1	8.7	15.0
Maximum Current For Heatpump System		A	21.6		
Power Factor Power factor means total figure of compressor and outdoor fan motor.		Condition	Cooling	Heating	Heat Recovery
		%	90	91	91
Power Cord	Number of core		-		
	Length	m (ft)	-		
Thermostat			Electronic Control		
Protection Device			Electronic Control		

4. Location of Controls and Components

4.1 Tank Unit

4.1.1 Remote Controller buttons and display

Buttons / Indicator

- ① **Quick Menu button**
(For more details, refer to the separate Quick Menu Guide.)

- ② **Back button**
Returns to the previous screen

- ③ **LCD Display**

- ④ **Main Menu button**
For function setup

- ⑤ **ON/OFF button**
Starts/Stops operation

- ⑥ **Operation indicator**
Illuminates during operation, blinks during alarm.

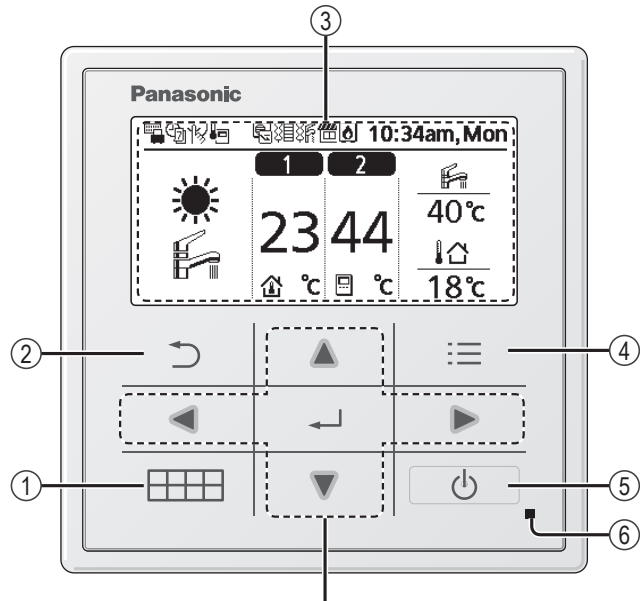

Cross key buttons

Selects an item.

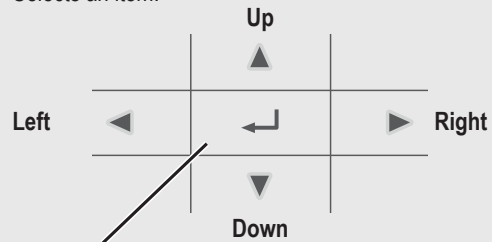

Enter button

Fixes the selected content.

 Press centre

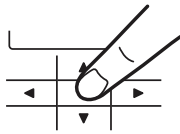

 No glove

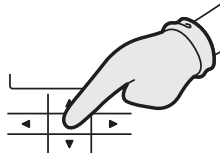

 No pen

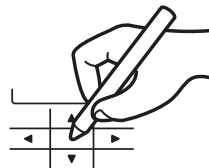

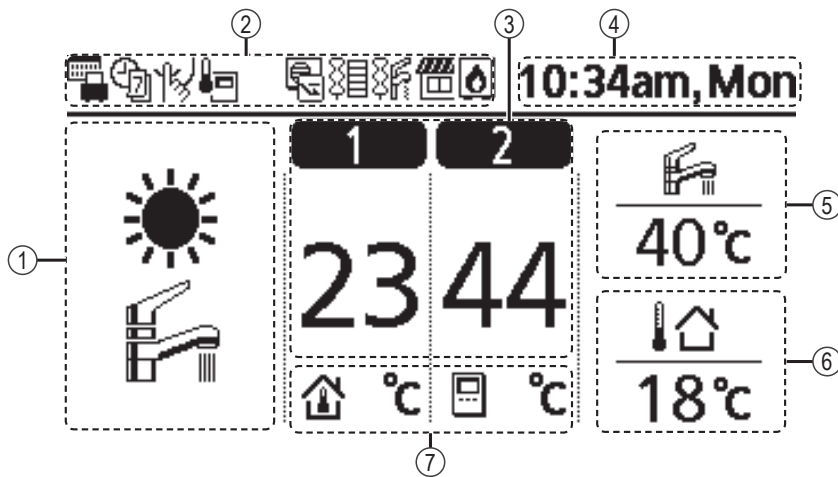

Display

① Mode selection

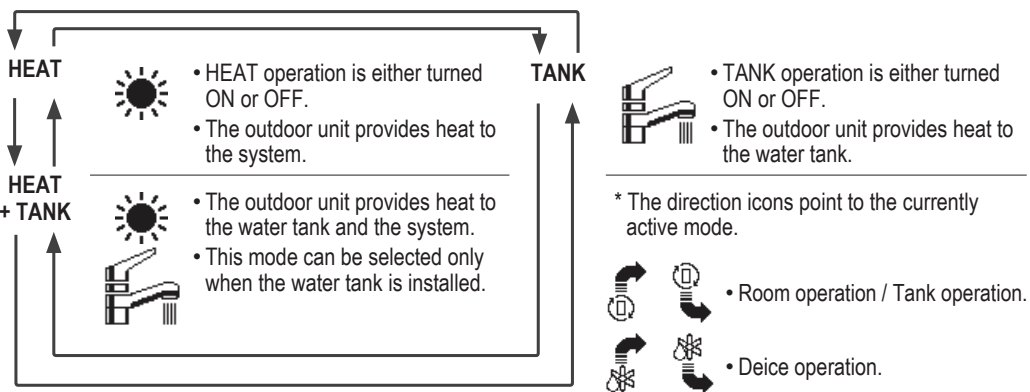

② Operation icons

The status of operation is displayed. Icon will not display (under operation OFF screen) whenever operation is OFF except weekly timer.

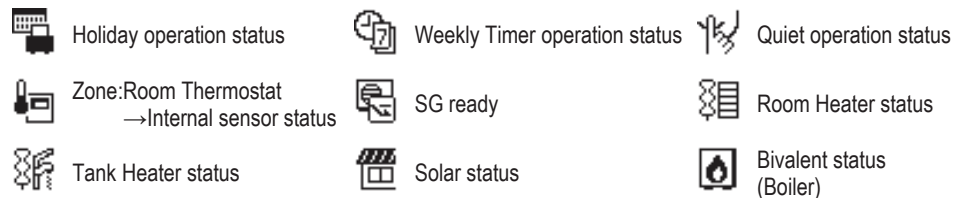

③ Temperature of each zone

④ Time and day

⑤ Water Tank temperature

⑥ Outdoor temperature

⑦ Sensor type/Set temperature type icons

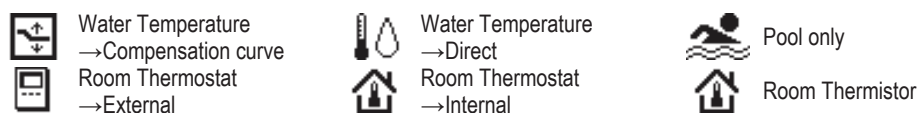

4.1.2 Initialization

Before starting to install the various menu settings, please initiate the Remote Controller by selecting the language of operation and installing the date and time correctly.
When power is turned on for the first time, it becomes the setting screen automatically. It can also be set from personal setting of the menu.

Selecting the language

Wait while the display is initializing.
When initializing screen ends, it turns to normal screen.
When any button is pressed, language setting screen appears.

- ① Scroll with ▼ and ▲ to select the language.
- ② Press ↵ to confirm the selection.

Setting the clock

- ① Select with ▼ or ▲ how to display the time, either 24h or am/pm format (for example, 15:00 or 3:00 pm).
- ② Press ↵ to confirm the selection.
- ③ Use ▼ and ▲ to select year, month, day, hour and minutes. (Select and move with ► and press ↵ to confirm.)
- ④ Once the time is set, time and day will appear on the display even if the Remote Controller is turned OFF.

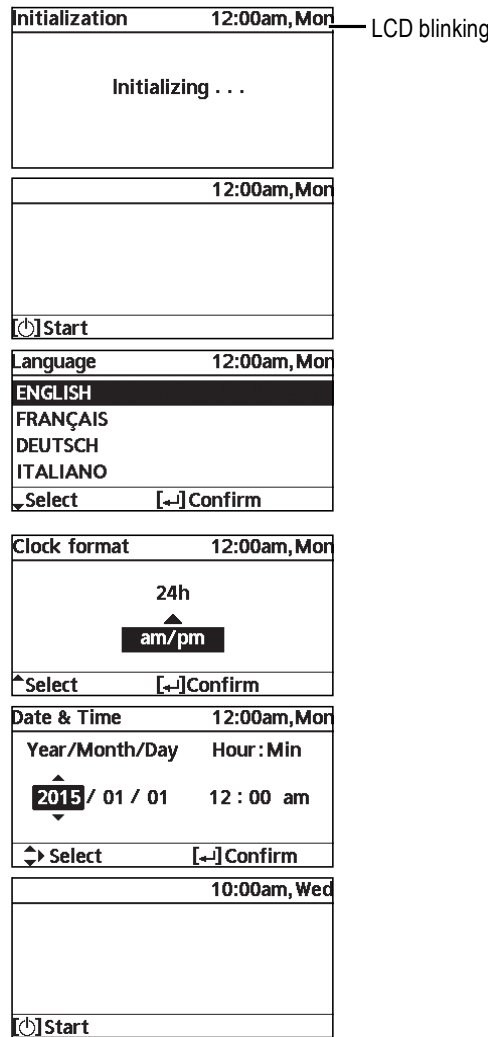

4.1.3 Quick Menu

After the initial settings have been completed, you can select a quick menu from the following options and edit the setting.

① Press  to display the quick menu.

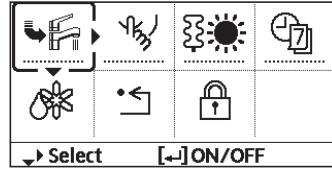

Force DHW



Quiet



Force Heater



Weekly Timer



Force Defrost



Error Reset



R/C Lock

② Use     to select menu.

③ Press  to turn on/off the select menu.

4.1.4 Menus (For user)

Select menus and determine settings according to the system available in the household. All initial settings must be done by an authorised dealer or a specialist. It is recommended that all alterations of the initial settings are also done by an authorised dealer or a specialist.

- After initial installation, you may manually adjust the settings.
- The initial setting remains active until the user changes it.
- The Remote Controller can be used for multiple installations.
- Ensure the operation indicator is OFF before setting.
- The system may not work properly if set wrongly. Please consult an authorised dealer.

To display <Main Menu>: 



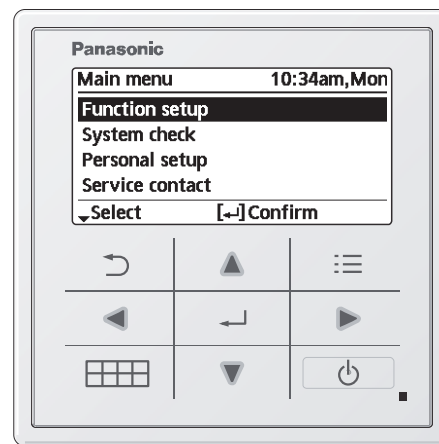

To select menu:    



To confirm the selected content: 

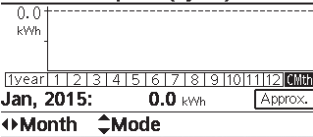

Menu	Default Setting	Setting Options / Display
1 Function setup		
1.1 > Weekly timer		
Once the weekly timer is set up, User can edit from Quick Menu. To set up to 6 patterns of operation on a daily basis. • Disabled if Force Heater is on.	Timer setup Select day of the week and set the patterns needed (Time / Operation ON/OFF / Mode)	Weekly timer 10:34am, Mon Sun Mon Tue Wed Thu Fri Sat 1. 8:00am ON 40°C 2. 12:00pm ON 24/28°C 40°C 3. 1:00pm ON 12/10°C ↔Day ↓Pattern [←]Edit
	Timer copy Select day of the week	

Menu	Default Setting	Setting Options / Display																		
1.2 > Holiday timer																				
To save energy, a holiday period may be set to either turn OFF the system or lower the temperature during the period.	OFF	<div style="text-align: right;">ON ▲ OFF</div>																		
	> ON	<table border="1"> <tr> <td>Holiday start and end. Date and time</td> <td>Holiday: End</td> <td>10:34am, Mon</td> </tr> <tr> <td>OFF or lowered temperature</td> <td>Year/Month/Day</td> <td>Hour: Min</td> </tr> <tr> <td></td> <td>2015 / 01 / 07</td> <td>10 : 00 am</td> </tr> <tr> <td></td> <td>↔ Select</td> <td>[←] Confirm</td> </tr> </table>	Holiday start and end. Date and time	Holiday: End	10:34am, Mon	OFF or lowered temperature	Year/Month/Day	Hour: Min		2015 / 01 / 07	10 : 00 am		↔ Select	[←] Confirm						
Holiday start and end. Date and time	Holiday: End	10:34am, Mon																		
OFF or lowered temperature	Year/Month/Day	Hour: Min																		
	2015 / 01 / 07	10 : 00 am																		
	↔ Select	[←] Confirm																		
<ul style="list-style-type: none"> Weekly timer setting may be temporarily disabled during Holiday timer setting but it will be restored once the Holiday timer is completed. 																				
1.3 > Quiet timer																				
To operate quietly during the preset period. 6 patterns may be set. Level 0 means the mode is off.	Time to start Quiet : Date and time	<table border="1"> <tr> <td>Quiet</td> <td colspan="2">10:34am, Mon</td> </tr> <tr> <td>Pattern</td> <td>Time</td> <td>Level</td> </tr> <tr> <td>1</td> <td>8:00 am</td> <td>0</td> </tr> <tr> <td>2</td> <td>5:00 pm</td> <td>1</td> </tr> <tr> <td>3</td> <td>11:00 pm</td> <td>3</td> </tr> <tr> <td>↙ Select</td> <td colspan="2">[←] Edit</td> </tr> </table>	Quiet	10:34am, Mon		Pattern	Time	Level	1	8:00 am	0	2	5:00 pm	1	3	11:00 pm	3	↙ Select	[←] Edit	
	Quiet	10:34am, Mon																		
Pattern	Time	Level																		
1	8:00 am	0																		
2	5:00 pm	1																		
3	11:00 pm	3																		
↙ Select	[←] Edit																			
Level of quietness: 0 ~ 3																				
1.4 > Room heater																				
To set the room heater ON or OFF.	OFF	<div style="text-align: right;">ON ▲ OFF</div>																		
1.5 > Tank heater																				
To set the tank heater ON or OFF.	OFF	<div style="text-align: right;">ON ▲ OFF</div>																		
1.6 > Sterilization																				
To set the auto sterilization ON or OFF.	ON	<div style="text-align: right;">ON ▼ OFF</div>																		
<ul style="list-style-type: none"> Do not use the system during sterilization in order to prevent scalding with hot water, or overheating of shower. Ask an authorised dealer to determine the level of sterilization function field settings according to the local laws and regulations. 																				
1.7 > DHW mode (Domestic Hot Water)																				
To set the DHW mode to Standard or Smart. <ul style="list-style-type: none"> Standard mode have faster DHW Tank heat up time. Meanwhile Smart mode take longer time to heat up DHW time with lower energy consumption. 	Standard	<div style="text-align: right;">Standard ▼ Smart</div>																		
	To set the tank sensor to Top or Center. <ul style="list-style-type: none"> Selection of the tank sensor to top slow down the start of boiling up the tank and reduce power consumption. Please change this selection to "Center" when the hot water becomes insufficient. 	Top	<div style="text-align: right;">Top ▼ Center</div>																	

Menu	Default Setting	Setting Options / Display
2 System check		
2.1 > Energy monitor		
Historical chart of energy consumption, generation.	Historical chart Select and retrieve	Total consumption (1year) 
<ul style="list-style-type: none"> For historical chart, the period is selected from 1 day/1 week/1year. Energy consumption (kWh) of total may be retrieved. The total power consumption is an estimated value based on AC 230 V and may differ from value measured by precise equipment. 		
2.2 > System information		
Shows all system information in each area.	Actual system information of 10 items: Inlet / Outlet / Zone 1 / Zone 2 / Tank / Buffer tank / Solar / Pool / COMP frequency / Pump flowrate Select and retrieve	System information 10:34am, Mon 1. Inlet : 0°C 2. Outlet : 0°C 3. Zone 1 : 0°C 4. Zone 2 : 0°C ↓Page
2.3 > Error history		
<ul style="list-style-type: none"> Refer to Troubleshooting for error codes. The most recent error code is displayed at the top. 	Select and retrieve	Error history 10:34am, Mon 1. -- 2. -- 3. -- 4. -- [↔] Clear history
2.4 > Compressor		
Shows the compressor performance.	Select and retrieve	Compressor 10:34am, Mon 1. Current frequency : 0 Hz 2. (OFF-ON) counter : 0 3. Total ON time : 0 h [↩] Back
2.5 > Heater		
Total hours of ON time for Room heater/Tank heater.	Select and retrieve	Heater 10:34am, Mon Total ON time  : 0h  : 0h [↩] Back
3 Personal setup		
3.1 > Touch sound		
Turns the operation sound ON/OFF.	ON	
3.2 > LCD contrast		
Sets the screen contrast.	3	LCD contrast 10:34am, Mon Low  High [↔] Select [↔] Confirm

Menu	Default Setting	Setting Options / Display
3.3 > Backlight		
Sets the duration of screen backlight.	1 min	Backlight 10:34am, Mon OFF 5 mins 15 secs 10 mins 1 min ^ Select [->] Confirm
3.4 > Backlight intensity		
Sets screen backlight brightness.	4	Backlight intensity 10:34am, Mon Dark  Bright ◀ Select [->] Confirm
3.5 > Clock format		
Sets the type of clock display.	24h	Clock format 10:34am, Mon 24h am/pm ▼ Select [->] Confirm
3.6 > Date & Time		
Sets the present date and time.	Year / Month / Day / Hour / Min	Date & Time 10:34am, Mon Year/Month/Day Hour: Min 2015 / 01 / 07 10 : 00 am ↕ Select [->] Confirm
3.7 > Language		
Sets the display language for the top screen. • For Greek, please refer to the English version.	ENGLISH / FRANÇAIS / DEUTSCH / ITALIANO / ESPAÑOL / DANISH / SWEDISH / NORWEGIAN / POLISH / CZECH / NEDERLANDS / TÜRKÇE / SUOMI / MAGYAR / SLOVENŠČINA / HRVATSKI / LIETUVIJA	Language 10:34am, Mon ENGLISH FRANÇAIS DEUTSCH ITALIANO ▼ Select [->] Confirm
3.8 > Unlock password		
4 digit password for all the settings.	0000	Unlock password 10:34am, Mon 0000 ↕ Select [->] Confirm
4 Service contact		
4.1 > Contact 1 / Contact 2		
Preset contact number for installer.	Select and retrieve	Service setup 10:34am, Mon Contact 1 Name : Bryan Adams  : 08812345678 ▼ Select

4.1.5 Menus (For installer)

Menu	Default Setting	Setting Options / Display
5 Installer setup > System setup		
5.1 > Optional PCB connectivity		
To connect to the external PCB required for servicing.	No	<div style="text-align: right;">Yes ▲ No</div>
<p>• If the external PCB is connected (optional), the system will have following additional functions:</p> <ol style="list-style-type: none"> ① Buffer tank connection and control over its function and temperature. ② Control over 2 zones (including the swimming pool and the function to heat water in it). ③ Solar function (the solar thermal panels connected to either the DHW (Domestic Hot Water) Tank or the Buffer Tank. <ul style="list-style-type: none"> • DHW is not applicable for WH-ADC *models. ④ External compressor switch. ⑤ External error signal. ⑥ SG ready control. 		
5.2 > Zone & Sensor		
To select the sensors and to select either 1 zone or 2 zone system.	Zone • After selecting 1 or 2 zone system, proceed to the selection of room or swimming pool. • If the swimming pool is selected, the temperature must be selected for ΔT temperature between 0°C ~ 10 °C.	<div style="text-align: right;">Zone & Sensor 10:34am, Mon</div> Zone <div style="text-align: center;">1 Zone system</div> <div style="text-align: center;">2 Zones system</div> <hr/> <div style="text-align: right;">▼Select [←] Confirm</div>
	Sensor * For room thermostat, there is a further selection of external or internal.	<div style="text-align: right;">Zone & Sensor 10:34am, Mon</div> Sensor <div style="text-align: center;">Water temperature</div> <div style="text-align: center;">Room thermostat</div> <div style="text-align: center;">Room thermistor</div> <hr/> <div style="text-align: right;">▼Select [←] Confirm</div>
5.3 > Heater capacity		
To reduce the heater power if unnecessary.* 3 kW / 6 kW / 9kW		<div style="text-align: right;">Heater capacity 10:34am, Mon</div> <div style="text-align: center;">3 kW</div> <hr/> <div style="text-align: right;">[←] Confirm</div>
* Options of kW vary depending on the model.		
5.4 > Anti freezing		
To activate or deactivate the water freeze prevention when the system is OFF	Yes	<div style="text-align: right;">Yes ▼ No</div>
5.5 > DHW capacity		
To select tank heating capacity to variable or standard. Variable capacity heat up tank with fast mode and keep the tank temperature with efficient mode. While standard capacity heat up tank with rated heating capacity.	Variable	<div style="text-align: right;">Variable ▼ Standard</div>

Menu	Default Setting	Setting Options / Display
5.6 > Buffer tank connection		
<p>To connect tank to the system and if selected YES, to set ΔT temperature.</p> <ul style="list-style-type: none"> The optional PCB connectivity must be selected YES to enable the function. If the optional PCB connectivity is not selected, the function will not appear on the display. 	No	<p style="text-align: center;">Yes ▲ No</p>
	> Yes	
	5 °C	<p>Buffer Tank 10:34am, Mon ΔT for Buffer Tank Range: (0°C~10°C) Steps: $\pm 1^\circ\text{C}$ 5 °C</p> <p>↕Select [↔] Confirm</p>
5.7 > Tank heater		
<p>Set the internal tank heater delay turn ON after heat pump operation.</p> <p>* Heater will turn ON only if Backup heater "enabled" and Tank heater "ON" condition.</p>	Internal	<p>Tank heater 10:34am, Mon Internal</p> <p style="text-align: right;">[↔] Confirm</p>
	1:30	<p>Tank heater 10:34am, Mon Tank heater: ON time Range: (0:20~3:00) Steps: $\pm 0:05$ 1:30</p> <p>↕Select [↔] Confirm</p>
5.8 > Bivalent connection		
<p>To select to enable or disable bivalent connection.</p>	No	<p style="text-align: center;">Yes ▲ No</p>
	> Yes	
<p>To select either auto control pattern or SG ready input control pattern.</p> <p>* This selection only display to select when optional pcb connection set to Yes.</p>	Auto	<p style="text-align: center;">Auto ▼ SG ready</p>

Menu	Default Setting	Setting Options / Display	
<p>To select a bivalent connection to allow an additional heat source such as a boiler to heat-up the buffer tank and domestic hot water tank when heatpump capacity is insufficient at low outdoor temperature. The bivalent feature can be set-up either in alternative mode (heatpump and boiler operate alternately), or in parallel mode (both heatpump and boiler operate simultaneously), or in advance parallel mode (heatpump operates and boiler turns on for buffer-tank and/or domestic hot water depending on the control pattern setting options).</p>	> Yes > Auto		
	-5 °C	<p>Set outdoor temperature for turn ON Bivalent connection.</p> <p>Bivalent connection 10:34am, Mon Turn ON: Outdoor temp. Range: (-15°C~35°C) Steps: ±1°C</p> <p style="text-align: right;">-5 °C</p> <p>↕Select [-+] Confirm</p>	
	Yes > After selecting the outdoor temperature		
	Control pattern		Bivalent connection 10:34am, Mon
	Alternative / Parallel / Advanced parallel		Control pattern
	<ul style="list-style-type: none"> Select advanced parallel for bivalent use of the tanks. 		Alternative Parallel Advanced parallel
			^Select [-+] Confirm
	Control pattern > Alternative		
	OFF	Option to set external pump either ON or OFF during bivalent operation. Set to ON if system is simple bivalent connection.	Bivalent connection 10:34am, Mon External pump ON OFF
			^Select [-+] Confirm
	Control pattern > Advanced parallel		
	Heat	Selection of the tank	Bivalent connection 10:34am, Mon
	<ul style="list-style-type: none"> "Heat" implies Buffer Tank and "DHW" implies Domestic Hot Water Tank. 		Advanced parallel Heat DHW
		↕Select [-+] Confirm	
Control pattern > Advanced parallel > Heat > Yes			
<ul style="list-style-type: none"> Buffer Tank is activated only after selecting "Yes". 		Bivalent connection 10:34am, Mon Advanced parallel: Heat Yes No	
		↕Select [-+] Confirm	
-8 °C	Set the temperature threshold to start the bivalent heat source.	Bivalent connection 10:34am, Mon Heat start: Target temp. Range: (-10°C~0°C) Steps: ±1°C	
		-8 °C	
		↕Select [-+] Confirm	
0:30	Delay timer to start the bivalent heat source (in hour and minutes).	Bivalent connection 10:34am, Mon Heat start: Delay time Range: (0:00~1:30) Steps: ±0:05	
		0:30	
		↕Select [-+] Confirm	
-2 °C	Set the temperature threshold to stop the bivalent heat source.	Bivalent connection 10:34am, Mon Heat stop: Target temp. Range: (-10°C~0°C) Steps: ±1°C	
		-2 °C	
		↕Select [-+] Confirm	

Menu	Default Setting	Setting Options / Display																		
	0:30	Delay timer to stop the bivalent heat source (in hour and minutes). Bivalent connection 10:34am, Mon Heat stop: Delay time Range: (0:00~1:30) Steps: ±0:05 0:30 ↕Select [←] Confirm																		
Control pattern > Advanced parallel > DHW > Yes																				
	• DHW Tank is activated only after selecting "Yes".	Bivalent connection 10:34am, Mon Advanced parallel: DHW Yes No ↓Select [←] Confirm																		
	0:30	Delay timer to start the bivalent heat source (in hour and minutes). Bivalent connection 10:34am, Mon DHW: Delay time Range: (0:30~1:30) Steps: ±0:05 0:30 ↕Select [←] Confirm																		
SG ready input control for bivalent system follow below input condition. <table border="1" style="margin-top: 10px;"> <thead> <tr> <th colspan="2">SG signal</th> <th>Operation pattern</th> </tr> <tr> <th>Vcc-bit1</th> <th>Vcc-bit2</th> <th></th> </tr> </thead> <tbody> <tr> <td>Open</td> <td>Open</td> <td>Heat Pump OFF, Boiler OFF</td> </tr> <tr> <td>Short</td> <td>Open</td> <td>Heat Pump ON, Boiler OFF</td> </tr> <tr> <td>Open</td> <td>Short</td> <td>Heat Pump OFF, Boiler ON</td> </tr> <tr> <td>Short</td> <td>Short</td> <td>Heat Pump ON, Boiler ON</td> </tr> </tbody> </table>	SG signal		Operation pattern	Vcc-bit1	Vcc-bit2		Open	Open	Heat Pump OFF, Boiler OFF	Short	Open	Heat Pump ON, Boiler OFF	Open	Short	Heat Pump OFF, Boiler ON	Short	Short	Heat Pump ON, Boiler ON	> Yes > SG ready	
SG signal		Operation pattern																		
Vcc-bit1	Vcc-bit2																			
Open	Open	Heat Pump OFF, Boiler OFF																		
Short	Open	Heat Pump ON, Boiler OFF																		
Open	Short	Heat Pump OFF, Boiler ON																		
Short	Short	Heat Pump ON, Boiler ON																		
	OFF	Option to set external pump either ON or OFF during bivalent operation. Set to ON if system is simple bivalent connection. Bivalent connection 10:34am, Mon External pump ON OFF ^Select [←] Confirm																		
5.9 > External SW																				
	No	Yes No																		
5.10 > Solar connection																				
<ul style="list-style-type: none"> The optional PCB connectivity must be selected YES to enable the function. If the optional PCB connectivity is not selected, the function will not appear on the display. DHW is not applicable for WH-ADC *models. 	No	Yes No																		
	> Yes																			
	Buffer tank	Selection of the tank Solar connection 10:34am, Mon Buffer tank DHW tank ↓Select [←] Confirm																		
	> Yes > After selecting the tank																			
	10 °C	Set ΔT ON temperature Solar connection 10:34am, Mon ΔT Turn ON Range: (6°C~15°C) Steps: ±1°C 10 °C ↕Select [←] Confirm																		

Menu	Default Setting	Setting Options / Display
		<p>> Yes > After selecting the tank > ΔT ON temperature</p> <p>Solar connection 10:34am, Mon ΔT Turn OFF Range: (2°C~9°C) Steps: ±1°C</p> <p>5 °C Set ΔT OFF temperature</p> <p>5 °C</p> <p>↕Select [←] Confirm</p>
		<p>> Yes > After selecting the tank > ΔT ON temperature > ΔT OFF temperature</p> <p>Solar connection 10:34am, Mon Anti freeze Range: (-20°C~10°C) Steps: ±1°C</p> <p>5 °C Set Antifreeze temperature</p> <p>5 °C</p> <p>↕Select [←] Confirm</p>
		<p>> Yes > After selecting the tank > ΔT ON temperature > ΔT OFF temperature > After setting the antifreeze temperature</p> <p>Solar connection 10:34am, Mon Hi limit Range: (70°C~90°C) Steps: ±5°C</p> <p>80 °C Set Hi limit</p> <p>80 °C</p> <p>↕Select [←] Confirm</p>
5.11	> External error signal	
	No	<p>Yes No</p>
5.12	> SG ready	
	No	<p>Yes No</p>
	> Yes	
	120 %	<p>SG ready 10:34am, Mon Capacity [1-0]: DHW Range: (50%~150%) Steps: ±5%</p> <p>Capacity (1) & (2) of DHW (in %), Heat (in %)</p> <p>120 %</p> <p>↕Select [←] Confirm</p>
5.13	> External compressor SW	
	No	<p>Yes No</p>
5.14	> Circulation liquid	
To select whether to circulate water or glycol in the system.	Water	<p>Circulation liquid 10:34am, Mon</p> <p>Water Glycol</p> <p>↕Select [←] Confirm</p>

Menu	Default Setting	Setting Options / Display
5.15 > Force heater		
<p>To turn on Force heater either manually (by default) or automatically.</p>	Manual	<p>Force heater 10:34am, Mon</p> <p style="text-align: center;">Auto ▲ Manual</p> <hr/> <p>◀ Select [↔] Confirm</p>
5.16 > Defrost signal		
<p>To turn on defrost signal to stop fan coil during defrost operation. (If defrost signal set to yes, bivalent function will not available to use)</p>	No	<p style="text-align: center;">Yes ▲ No</p>
5.17 > Pump flowrate		
<p>To set variable flow pump control or fix pump duty control.</p>	ΔT	<p style="text-align: center;">▲ Max. Duty</p>
5.18 > Force DHW		
<p>To turn on Tank only mode to heat up tank temperature by request priority heating from outdoor unit. * Under force DHW operation, Air to Air unit will stop provide room heating operation.</p>	Manual	<p style="text-align: center;">Auto ▲ Manual</p>
5.19 > DHW Defrost		
<p>Allow system to run defrost by using hot water instead of room unit to provide comfort room heating operation. * Outdoor define the condition to enter DHW defrost only when water is hot.</p>	Yes	<p style="text-align: center;">Yes ▲ No</p>

Menu	Default Setting	Setting Options / Display
6 Installer setup > Operation setup		
To access to the two major functions or modes.	2 main modes Heat / Tank	Operation setup 10:34am, Mon Heat Tank ↓Select [←] Confirm
6.1 > Heat		
To set various water & ambient temperatures for heating.	Water temp. for heating ON / Outdoor temp. for heating OFF / ΔT for heating ON / Heater ON/OFF	Operation setup 10:34am, Mon Heat Water temp. for heating ON Outdoor temp. for heating OFF ΔT for heating ON ↓Select [←] Confirm
> Water temp. for heating ON		
Compensation curve	Heating ON temperatures in compensation curve or direct input.	Operation setup 10:34am, Mon Heat ON: Water temp. Compensation curve Direct ↓Select [←] Confirm
> Water temp. for heating ON > Compensation curve		
X axis: -5 °C, 15 °C Y axis: 55 °C, 35 °C	Input the 4 temperature points (2 on horizontal X axis, 2 on vertical Y axis).	Heat ON: Water temp.:Zone1 55°C 55 35°C 20 -20 -5°C 15°C 15 ↔Select [←] Confirm
<ul style="list-style-type: none"> • Temperature range: X axis: -20 °C ~ 15 °C, Y axis: See below • Temperature range for the Y axis input: CU-2WZ71YBE5 : 20 °C ~ 55 °C • If 2 zone system is selected, the 4 temperature points must also be input for Zone 2. • "Zone 1" and "Zone 2" will not appear on the display if only 1 zone system. 		
> Water temp. for heating ON > Direct		
35 °C	Temperature for heating ON	Operation setup 10:34am, Mon Heat ON: Water temp.:Zone2 Range: (20°C~55°C) Steps: ±1°C 35 °C ↔Select [←] Confirm
<ul style="list-style-type: none"> • Min. ~ Max. range is conditional as follows: CU-2WZ71YBE5 : 20 °C ~ 55 °C • If 2 zone system is selected, temperature set point must input for Zone 2. • "Zone 1" and "Zone 2" will not appear on the display if only 1 zone system. 		

Menu	Default Setting	Setting Options / Display
> Outdoor temp. for heating OFF		
24 °C	Temperature for heating OFF	Operation setup 10:34am, Mon Heat OFF: Outdoor temp. Range: (5°C~35°C) Steps: ±1°C 24 °C ↕Select [↔] Confirm
> ΔT for heating ON		
5 °C	Set ΔT for heating ON. * This setting will not available to set when pump flowrate set to Max. duty.	Operation setup 10:34am, Mon Heat ON: ΔT Range: (1°C~15°C) Steps: ±1°C 5 °C ↕Select [↔] Confirm
> Heater ON/OFF		
> Heater ON/OFF > Outdoor temp. for heater ON		
0 °C	Temperature for heater ON	Operation setup 10:34am, Mon Heater ON: Outdoor temp. Range: (-20°C~15°C) Steps: ±1°C 0 °C ↕Select [↔] Confirm
> Heater ON/OFF > Delay time for heater ON		
0:30 min	Delay time for heater to turn on	Operation setup 10:34am, Mon Heater ON: Delay time Range: (0:10~1:00) Steps: ±0:10 0:30 ↕Select [↔] Confirm
> Heater ON/OFF > Water temperature for heater ON		
-4 °C	Setting of water temperature to turn on from water set temperature.	Operation setup 10:34am, Mon Heater ON: ΔT of target Temp. Range: (-10°C~-2°C) Steps: ±1°C -4 °C ↕Select [↔] Confirm
> Heater ON/OFF > Water temperature for heater OFF		
-2 °C	Setting of water temperature to turn off from water set temperature.	Operation setup 10:34am, Mon Heater OFF: ΔT of target Temp. Range: (-8°C~0°C) Steps: ±1°C -2 °C ↕Select [↔] Confirm

Menu	Default Setting	Setting Options / Display														
6.2	> Tank															
Setting functions for the tank.	Floor operation time (max) / Tank heat up time (max) / Tank re-heat temp. / Sterilization	Operation setup 10:34am, Mon Tank Floor operation time (max) Tank heat up time (max) Tank re-heat temp. ↕Select [←] Confirm														
• The display will show 3 functions at a time.																
> Floor operation time (max)																
8:00	Maximum time for floor operation (in hours and minutes)	Operation setup 10:34am, Mon Tank: Floor op. time (max) Range: (0:30~10:00) Steps: ±0:30 8:00 ↕Select [←] Confirm														
> Tank heat up time (max)																
1:00	Maximum time for heating the tank (in hours and minutes)	Operation setup 10:34am, Mon Tank: Heat up time (max) Range: (0:05~4:00) Steps: ±0:05 1:00 ↕Select [←] Confirm														
> Tank re-heat temp.																
-8 °C	Set temperature to perform reboil of tank water.	Operation setup 10:34am, Mon Tank: Re-heat temp. Range: (-12°C~-2°C) Steps: ±1°C -8 °C ↕Select [←] Confirm														
> Sterilization																
Monday	Sterilization may be set for 1 or more days of the week. Sun / Mon / Tue / Wed / Thu / Fri / Sat	Operation setup 10:34am, Mon Sterilization: Day <table border="1"> <tr> <td>Sun</td> <td>Mon</td> <td>Tue</td> <td>Wed</td> <td>Thu</td> <td>Fri</td> <td>Sat</td> </tr> <tr> <td>—</td> <td>✓</td> <td>—</td> <td>—</td> <td>—</td> <td>—</td> <td>—</td> </tr> </table> ⏪ Day <input checked="" type="checkbox"/> / <input type="checkbox"/> [←] Confirm	Sun	Mon	Tue	Wed	Thu	Fri	Sat	—	✓	—	—	—	—	—
Sun	Mon	Tue	Wed	Thu	Fri	Sat										
—	✓	—	—	—	—	—										
> Sterilization: Time																
12:00	Time of the selected day(s) of the week to sterilize the tank 0:00 ~ 23:59	Operation setup 10:34am, Mon Sterilization: Time 12:00 pm ↕ Select [←] Confirm														
> Sterilization: Boiling temp.																
65 °C	Set boiling temperatures for sterilize the tank.	Operation setup 10:34am, Mon Sterilization: Boiling temp. Range: (55°C~65°C) Steps: ±1°C 65 °C ↕Select [←] Confirm														

Menu	Default Setting	Setting Options / Display
	> Sterilization: Ope. time (max)	
	0:10	Operation setup 10:34am, Mon Sterilization: Ope. time (max) Range: (0:05~1:00) Steps: ±0:05 0:10 ↕Select [-] Confirm
	> Force DHW:Start Temp.	
	35 °C	Operation setup 10:34am, Mon Force DHW:Start Temp. Range: (25°C~40°C) Steps: ±1°C 35 °C ↕Select [-] Confirm

7 Installer setup > Service setup

7.1 > Pump maximum speed		
To set the maximum speed of the pump.	Setting the flow rate, max. duty and operation ON/OFF of the pump. Flow rate: XX:X L/min Max. Duty: 0x40 ~ 0xFE, Pump: ON/OFF/Air Purge	Service setup 10:34am, Mon Flow rate Max. Duty Operation 0.0 L/min 0xCE Air Purge ← Select

7.2 > Dry concrete			
To dry the concrete (floor, walls, etc.) during construction. Do not use this menu for any other purposes and in period other than during construction	Edit to set the temperature of dry concrete. ON / Edit	Service setup 10:34am, Mon Dry concrete ON Edit ↓Select [-] Confirm	
	> Edit Stages: 1 Temperature: 25 °C	Heating temperature for drying the concrete. Select the desired stages: 1 ~ 10, range: 1 ~ 99	Service setup 10:34am, Mon Dry concrete: 1/10 Range: (25°C~55°C) Steps: ±1°C 25 °C ^Select [-] Confirm
	> ON Confirm the setting temperatures of dry concrete for each stage.		Service setup 10:34am, Mon Dry concrete: Status Stage : 1/10 Water set temp. : 25°C Actual water temp. :25°C/25°C [OFF]

Menu	Default Setting	Setting Options / Display
7.3	> Service contact	
To set up to 2 contact names and numbers for the User.	Service engineer's name and contact number. Contact 1 / Contact 2	Service setup 10:34am, Mon Service contact: <div style="border: 1px solid black; padding: 2px;">Contact 1</div> <div style="border: 1px solid black; padding: 2px;">Contact 2</div> ↵Select [↵] Confirm
	> Contact 1 / Contact 2	
	Contact name or number. Name / phone icon	Service contact 10:34am, Mon Contact 1 Name : <div style="border: 1px solid black; padding: 2px;">Bryan Adams</div>  : <div style="border: 1px solid black; padding: 2px;">08812345678</div> ↵Select [↵] Edit
Input name and number Contact name: alphabet a ~ z. Contact number: 1 ~ 9	Contact-1 █ <div style="border: 1px solid black; padding: 2px;">ABC/abc 0-9/Other</div> <div style="border: 1px solid black; padding: 2px;"> ABCDEFGHI JKLMNOPQR Space STUVWXYZ abcdefghi BS jklmnopqrstuvwxyz Conf </div> ↵Select [↵] Enter Number: █ <div style="border: 1px solid black; padding: 2px;"> 1 2 3 (4 5 6) 7 8 9 - BS * 0 # _ Conf </div> ↵Select [↵] Enter	

4.1.6 Main Components

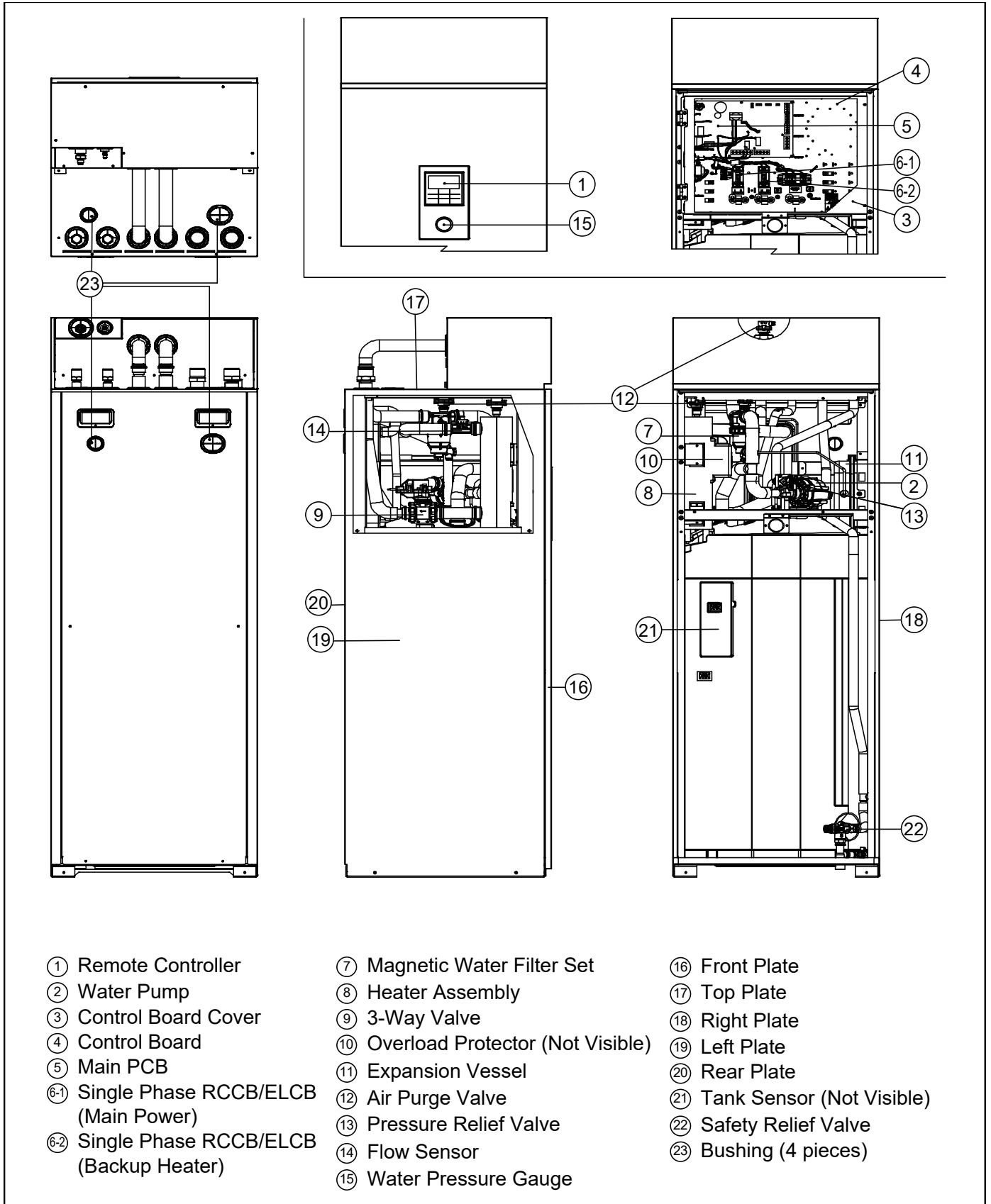

5. Dimensions

5.1 WH-ADF0309J3E5CM

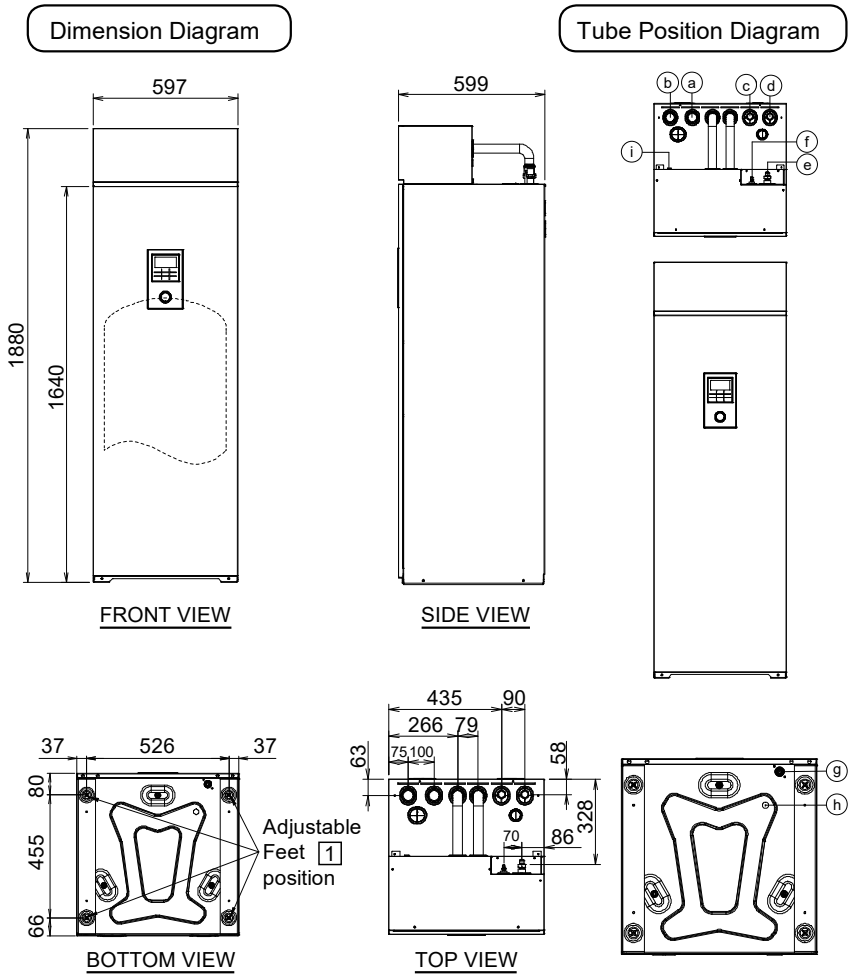

Tube Connector	Function	Connector Size
Ⓐ	Water Inlet (From Space Heating)	R 1 1/4"
Ⓑ	Water Outlet (To Space Heating)	R 1 1/4"
Ⓒ	Cold Water Inlet (Domestic Hot Water Tank)	R 3/4"
Ⓓ	Hot Water Outlet (Domestic Hot Water Tank)	R 3/4"
Ⓔ	Refrigerant Gas	3/4-16UNF
Ⓕ	Refrigerant Liquid	7/16-20UNF
Ⓖ	Domestic Hot Water Tank Discharge (Drain Tap) Type: Ball Valve	Rc 1/2"
Ⓗ	Drain Water Hole	---
Ⓘ	Drain Elbow	---

Model	Capacity (L)	Weight (kg)	
		Empty	Full
WH-ADF0309J3E5CM	185	108	293

5.2 S-71WF3E

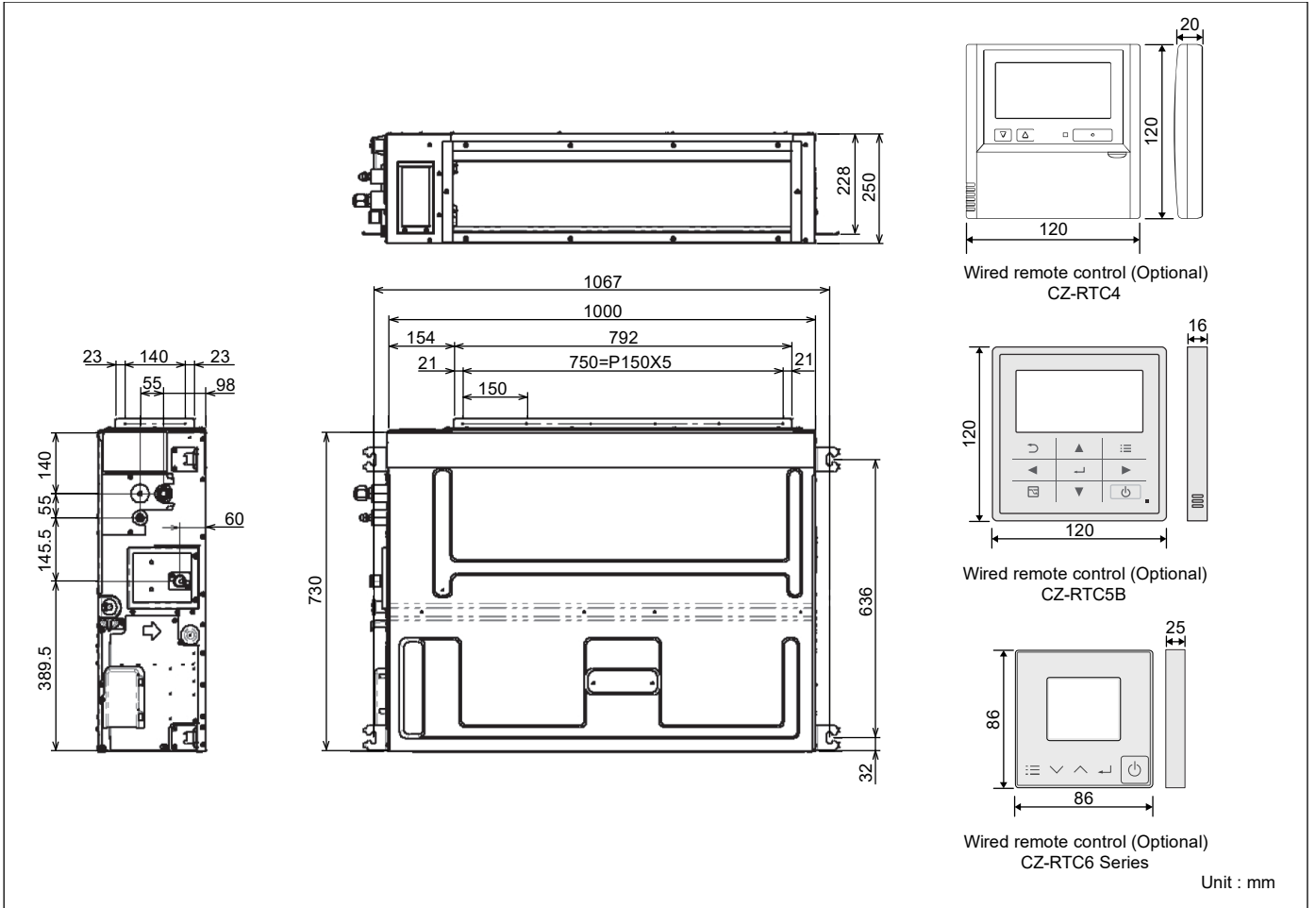

5.3 CU-2WZ71YBE5

Space necessary for installation

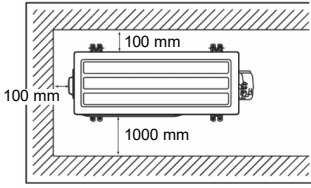

Anchor Bolt Pitch
620 x 380.5

<Top View>

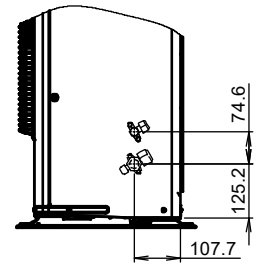
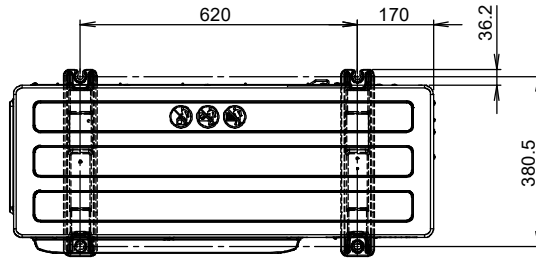

<Side View>

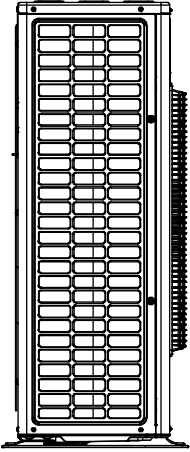

<Front View>

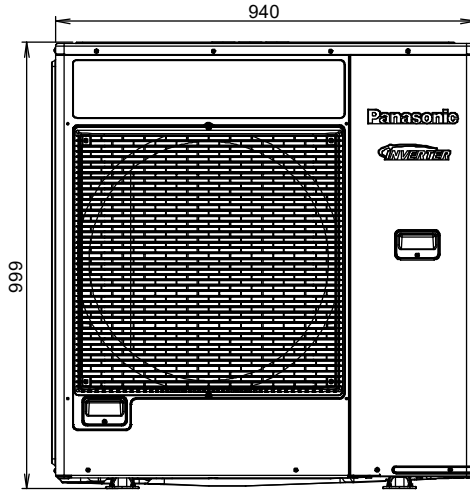

<Side View>

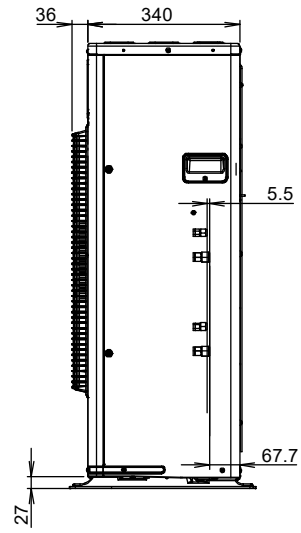

Unit: mm

6. Refrigeration Cycle Diagram

6.1 WH-ADF0309J3E5CM

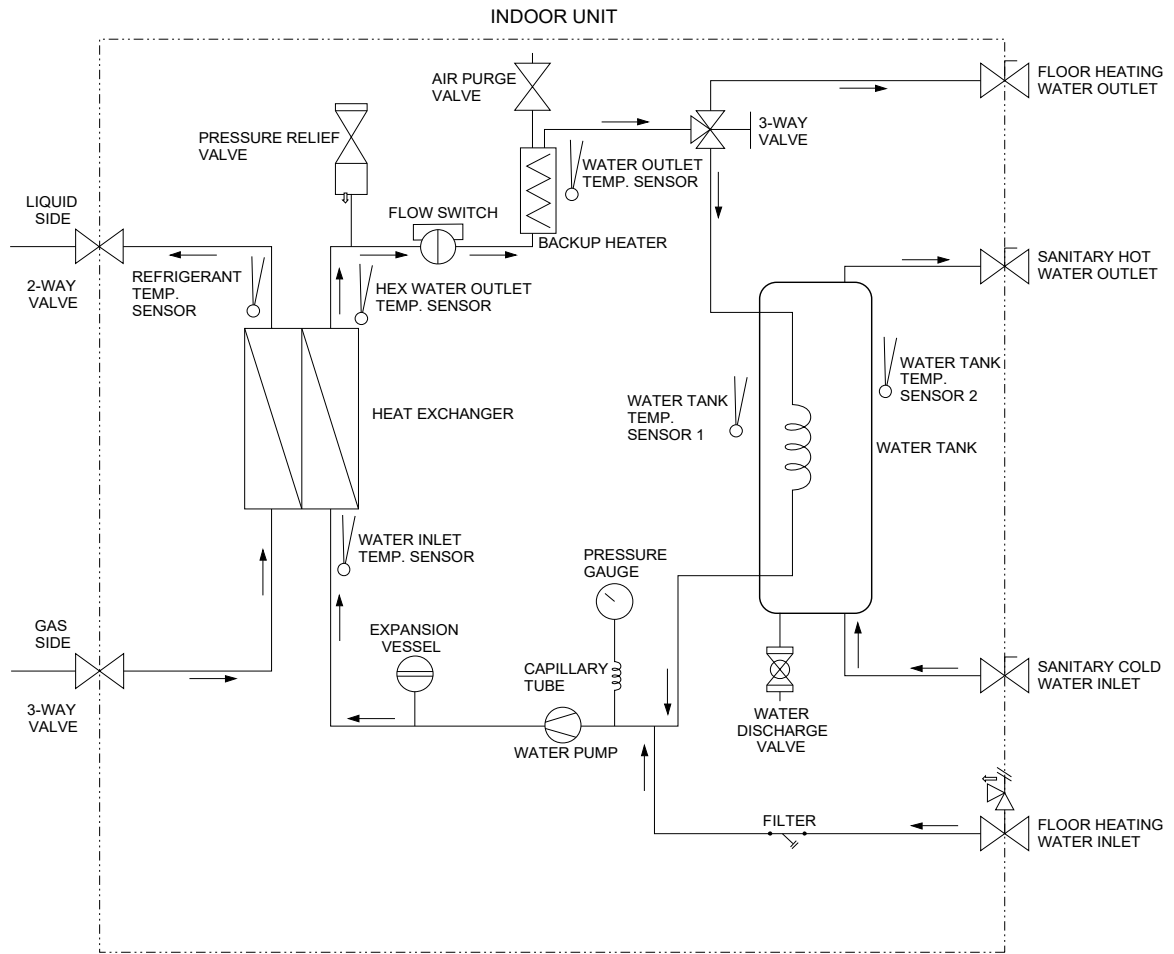

6.2 S-71WF3E

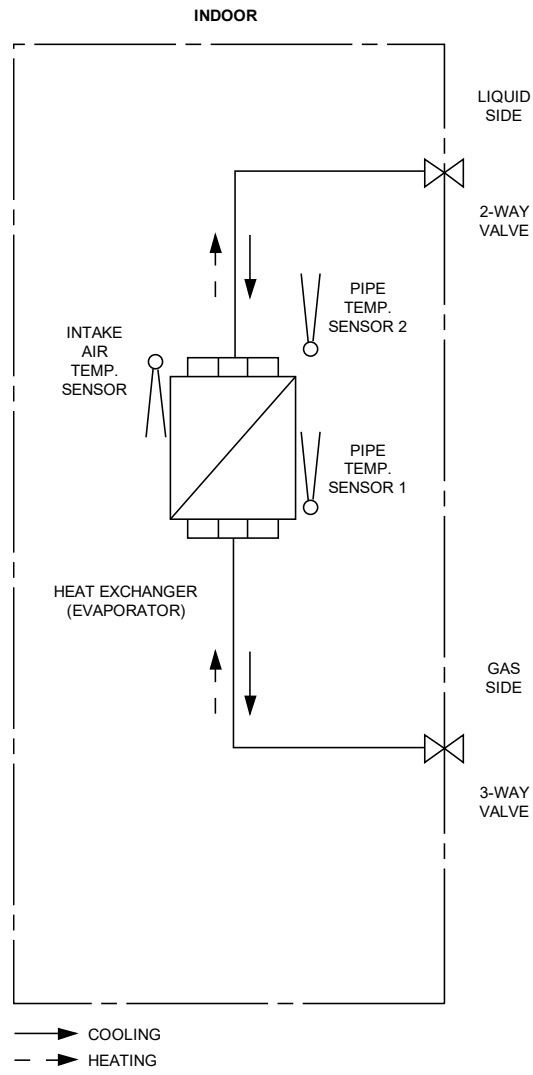

6.3 CU-2WZ71YBE5

OUTDOOR

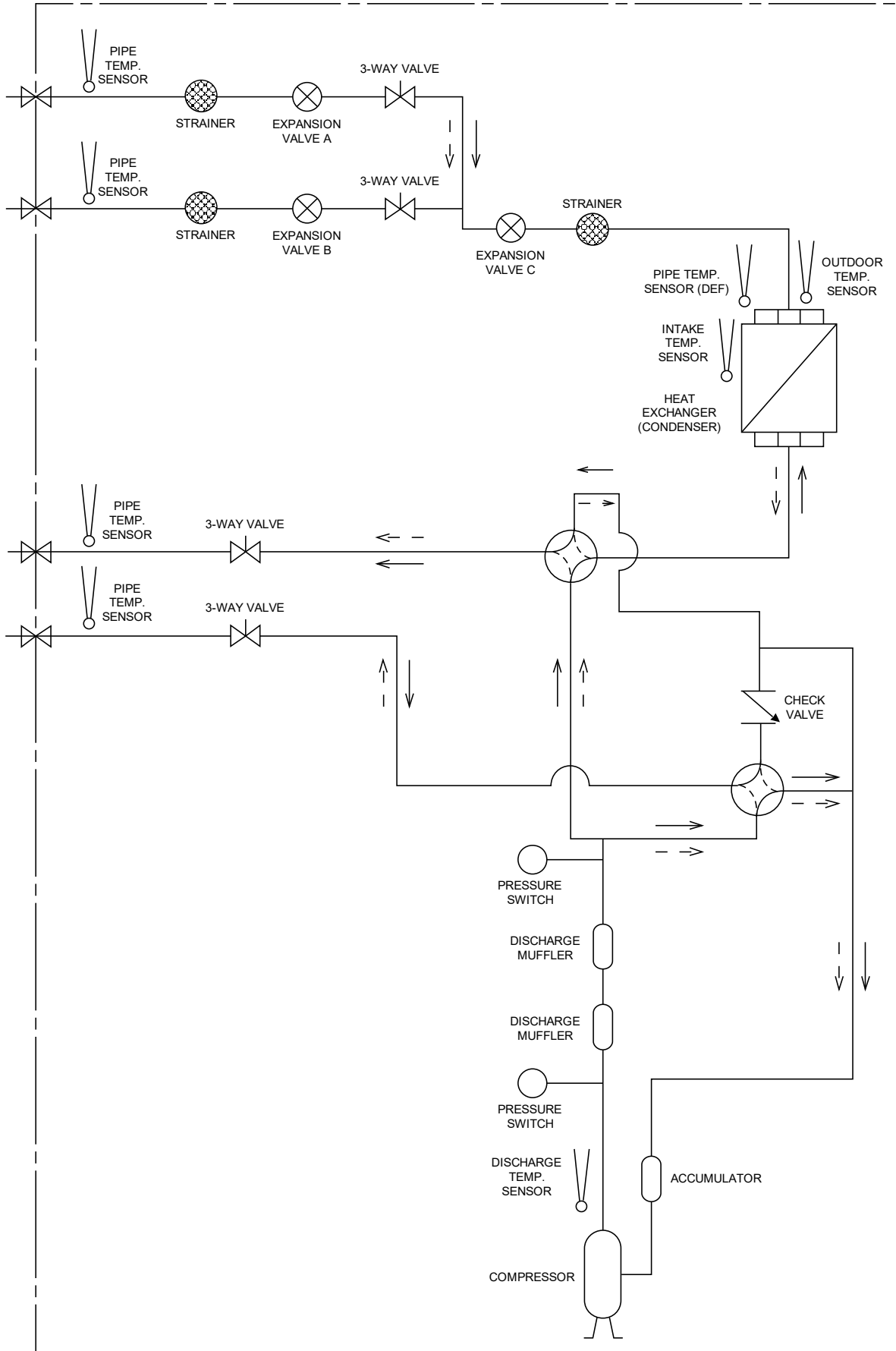

7. Block Diagram

7.1 WH-ADF0309J3E5CM

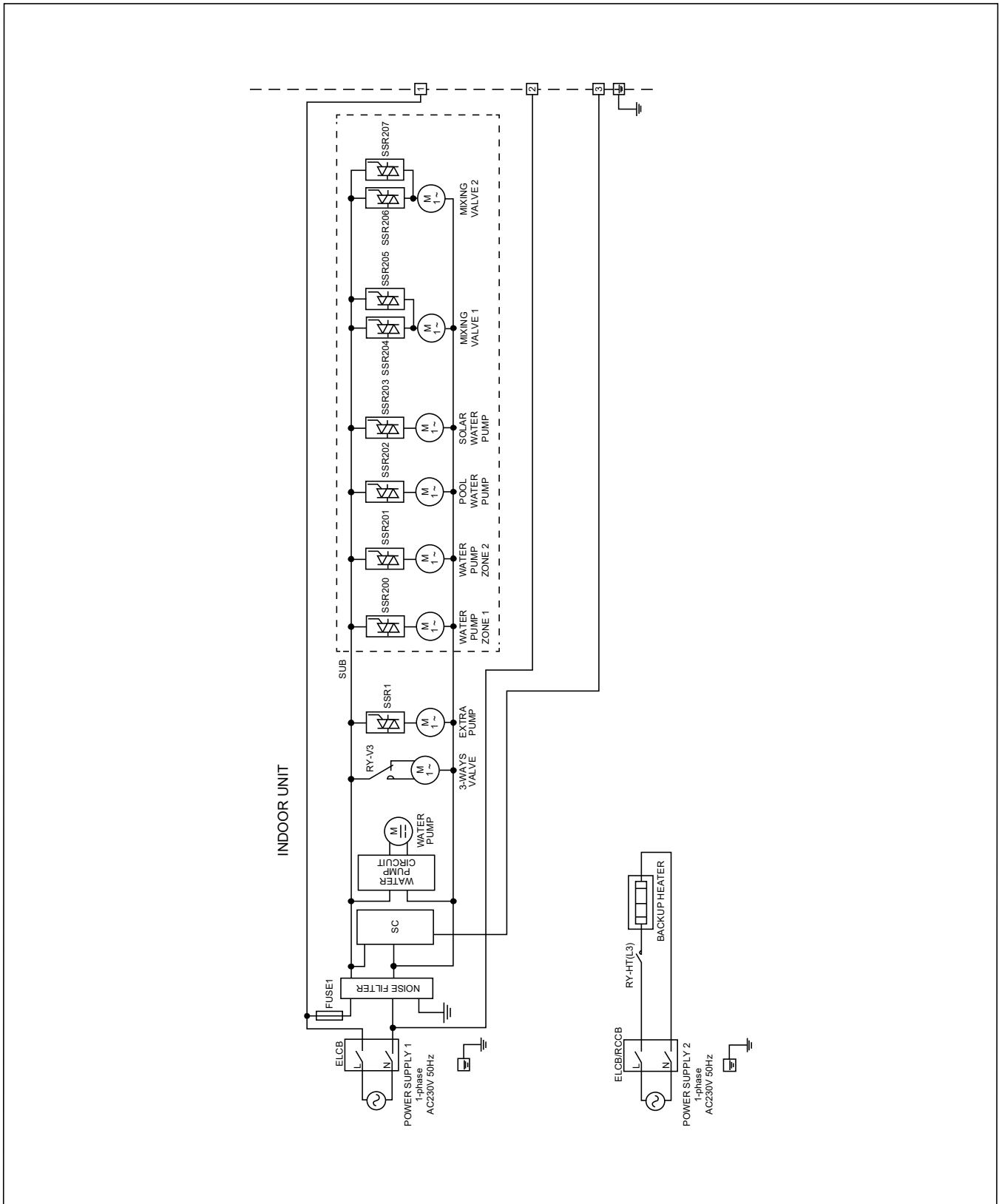

7.2 S-71WF3E

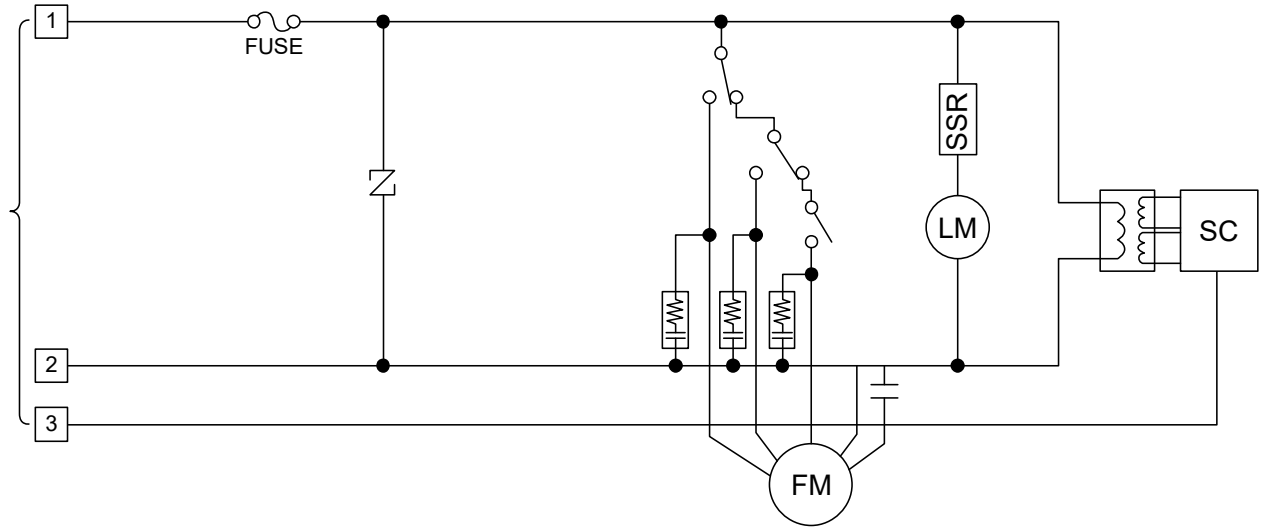

7.3 CU-2WZ71YBE5

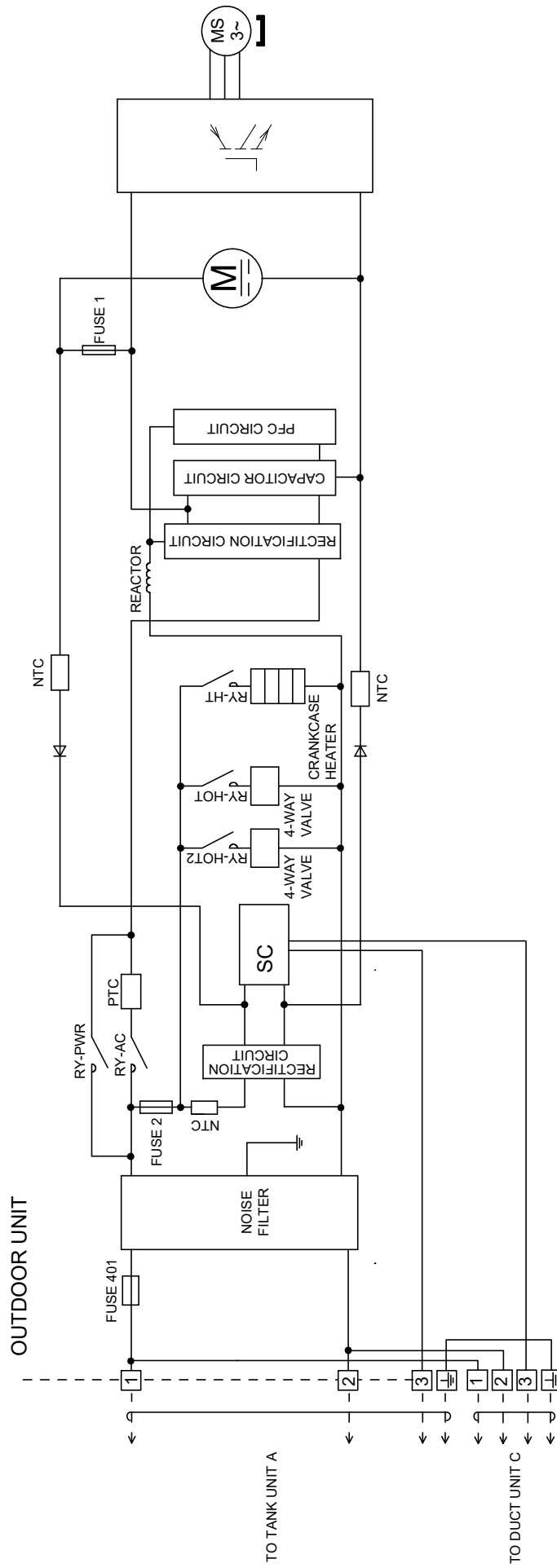

8. Wiring Connection Diagram

8.1 WH-ADF0309J3E5CM

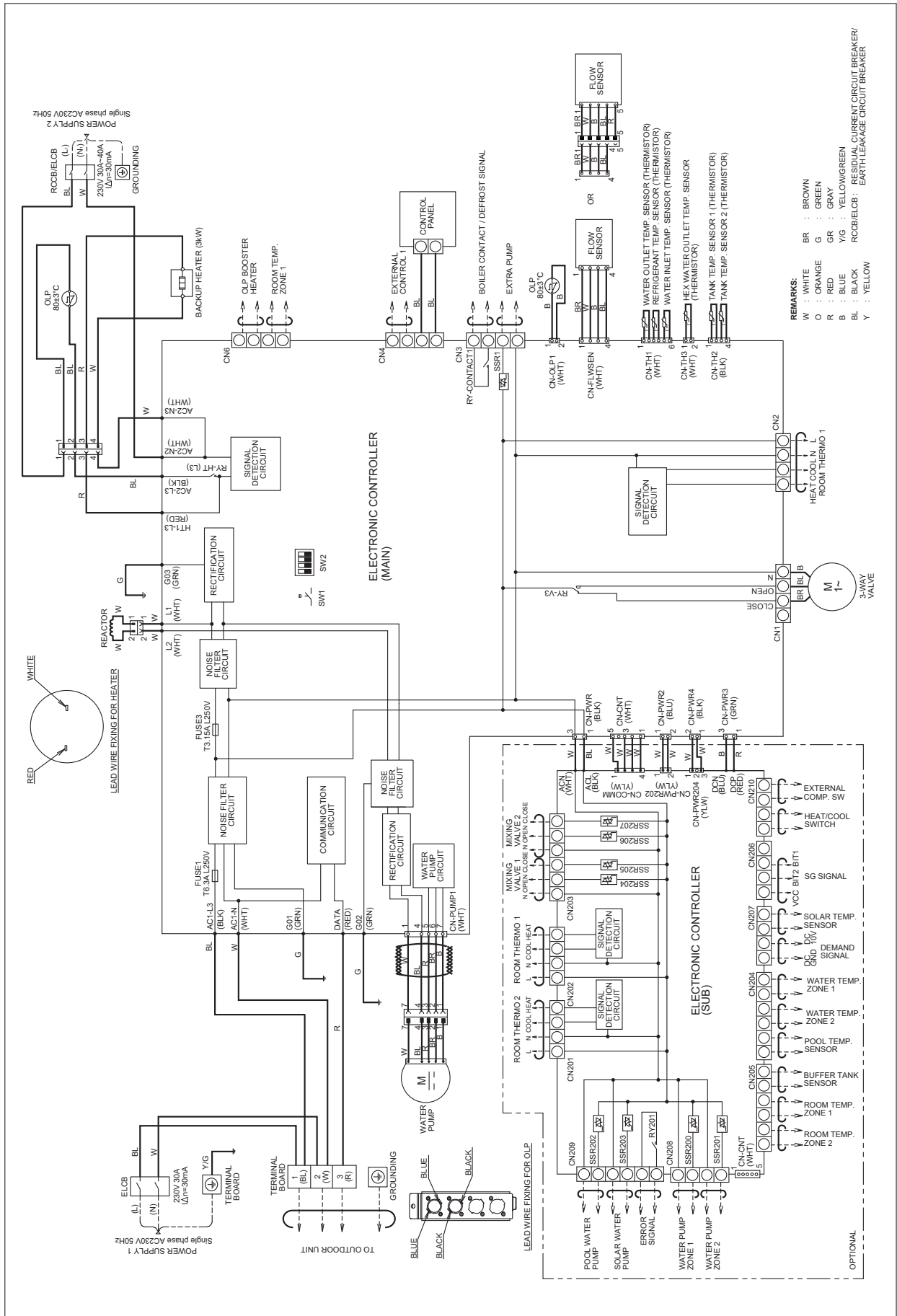

8.2 S-71WF3E

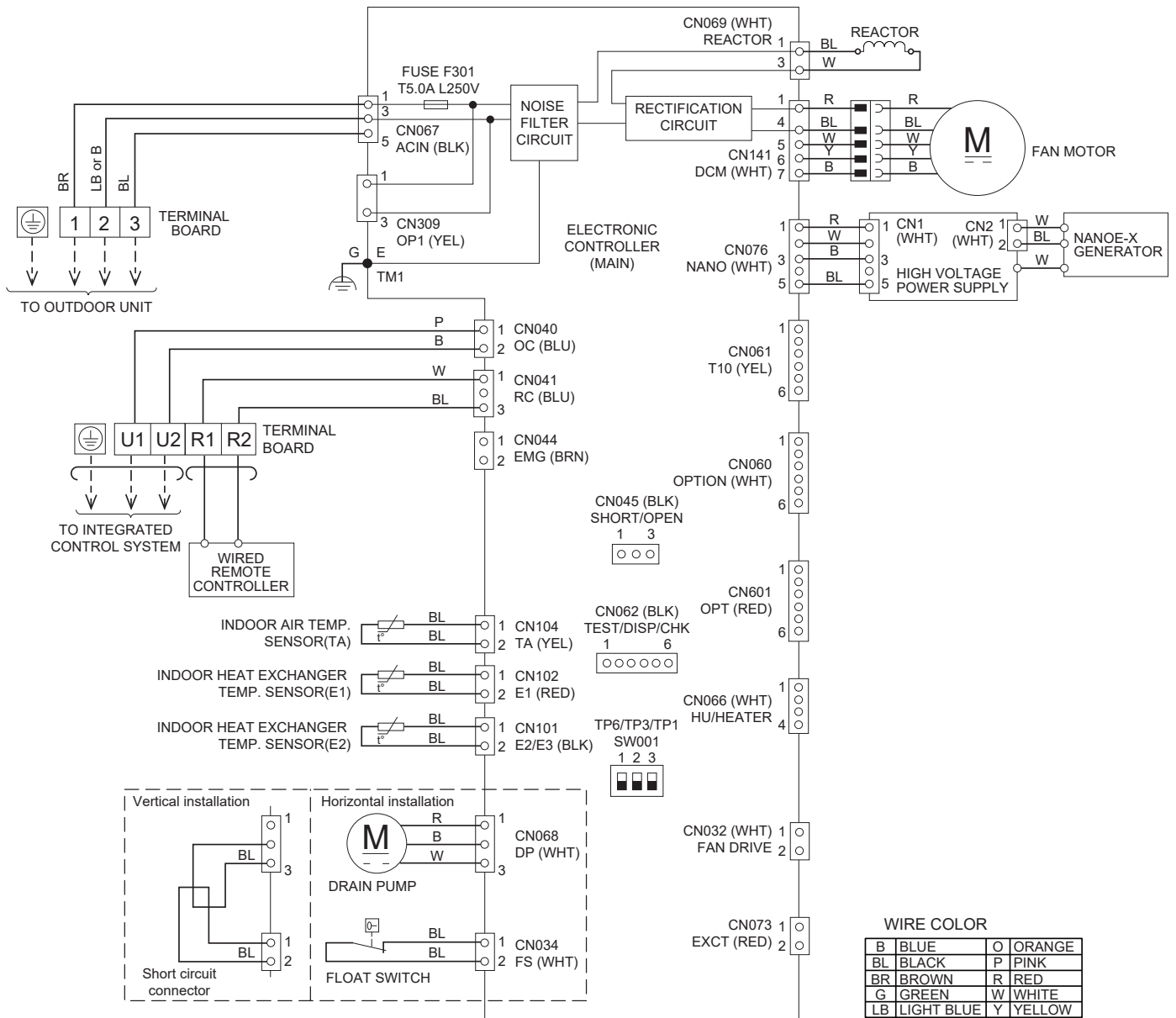

8.3 CU-2WZ71YBE5

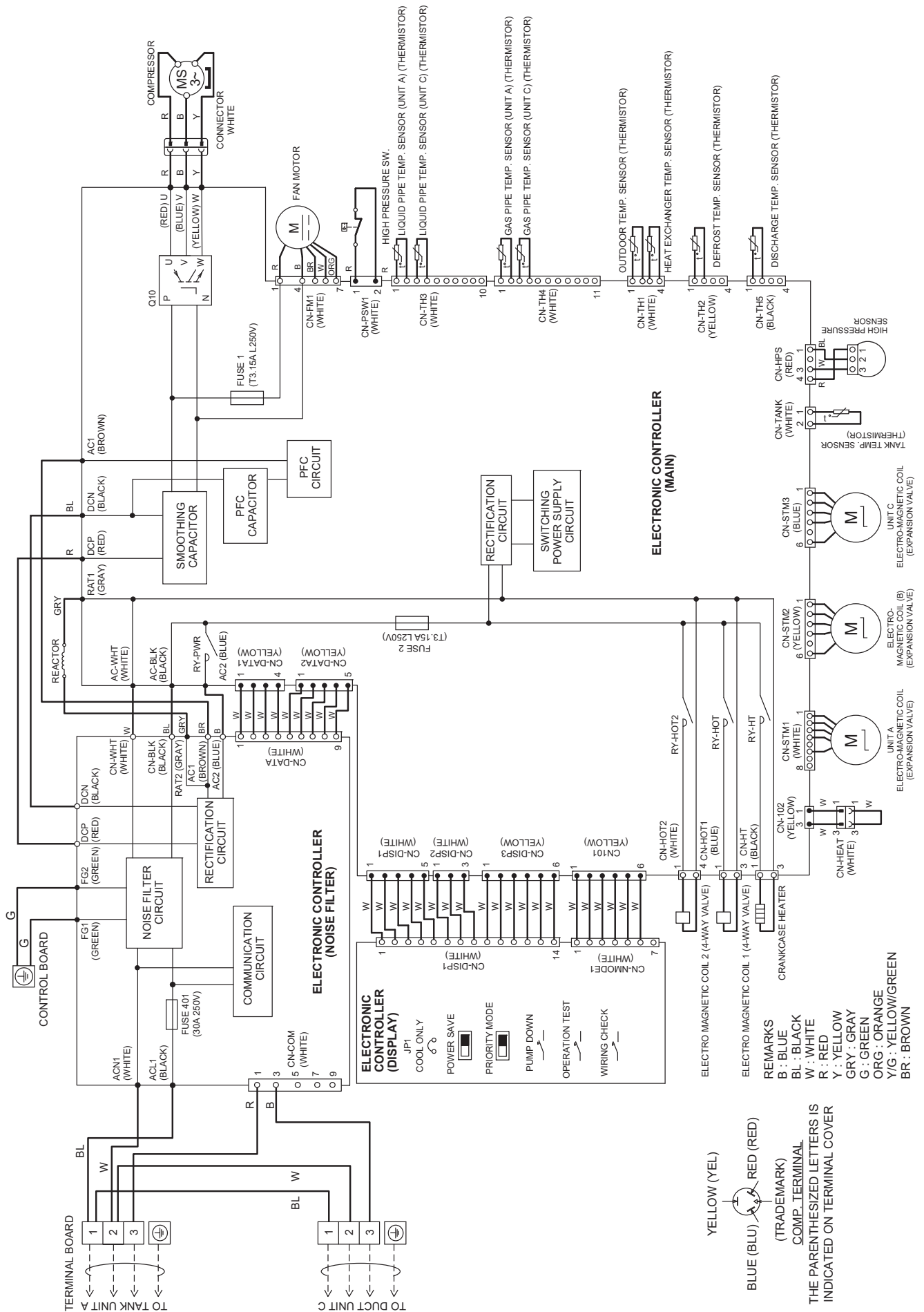

9.2 S-71WF3E

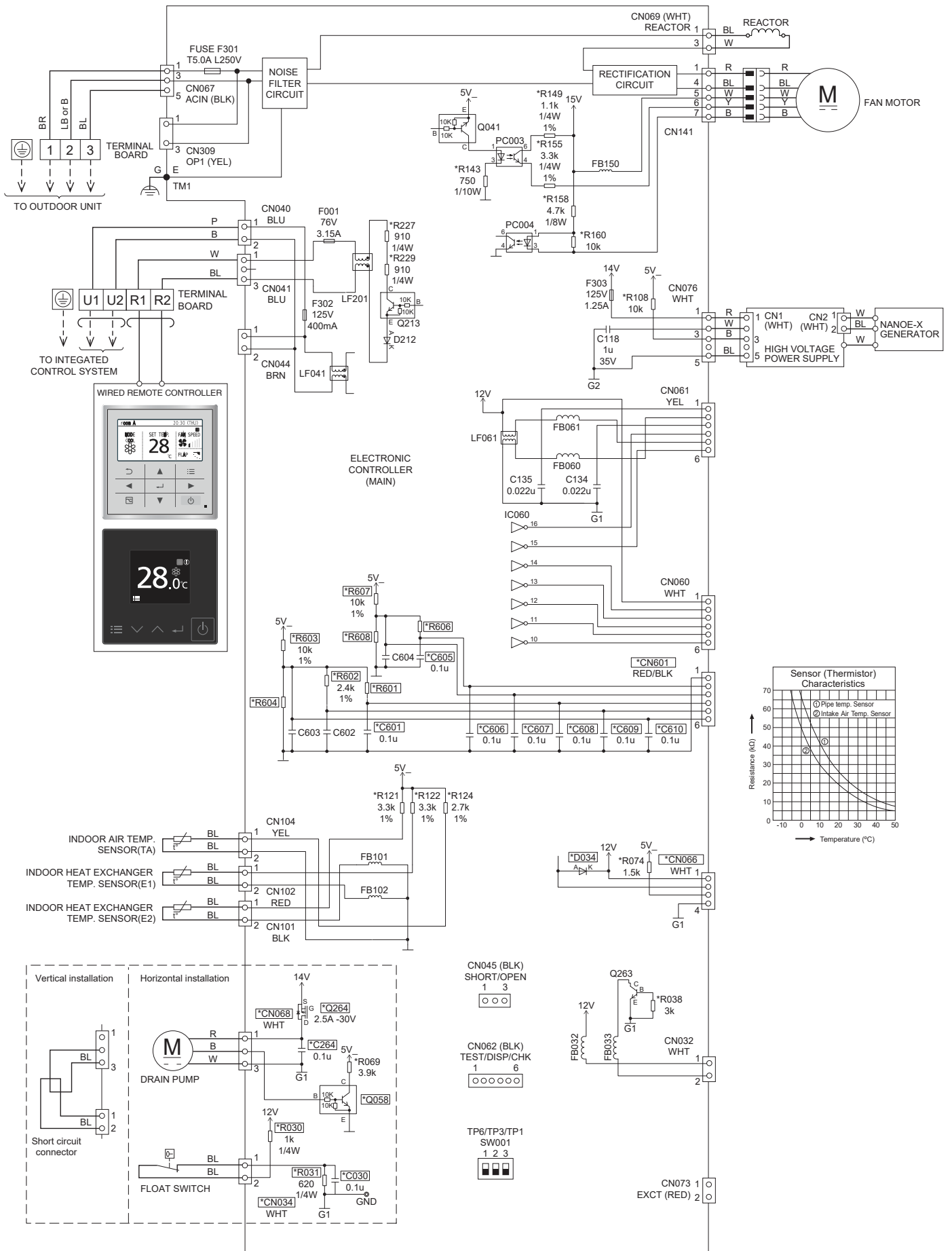

10. Printed Circuit Board

10.1 WH-ADF0309J3E5CM

10.1.1 Main Printed Circuit Board

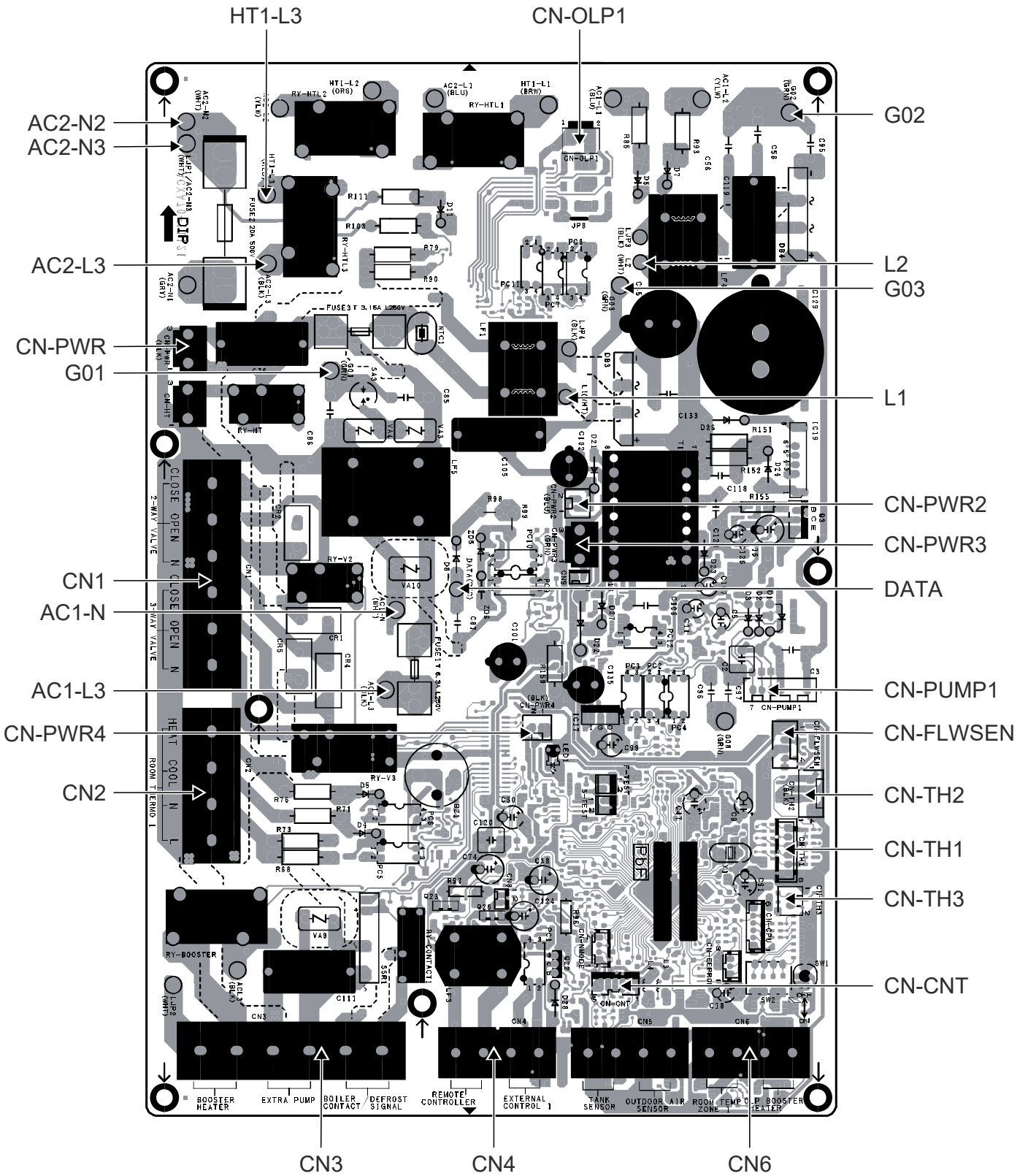

10.2 S-71WF3E

10.2.1 Main Printed Circuit Board

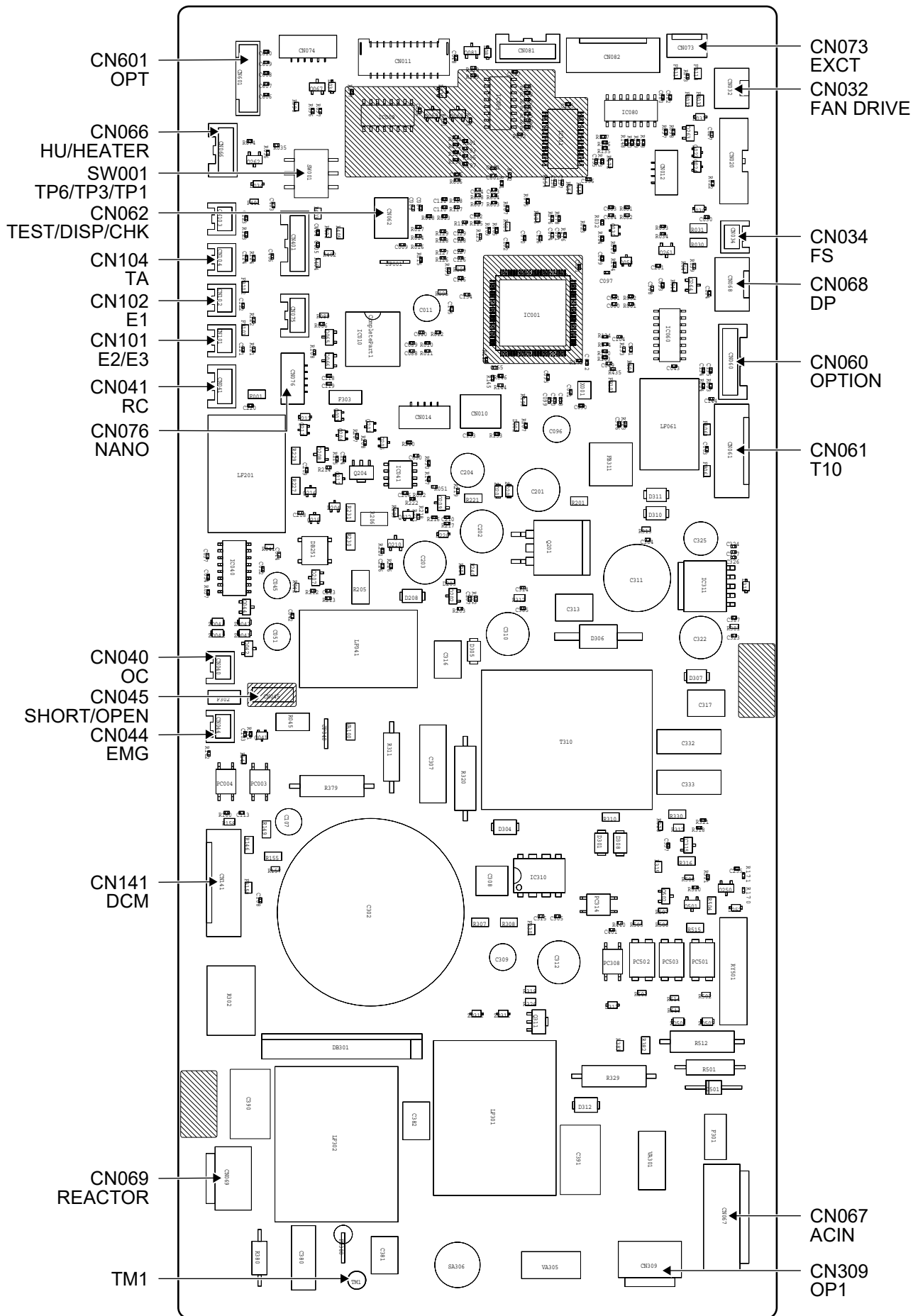

10.2.2 nanoe™X Printed Circuit Board

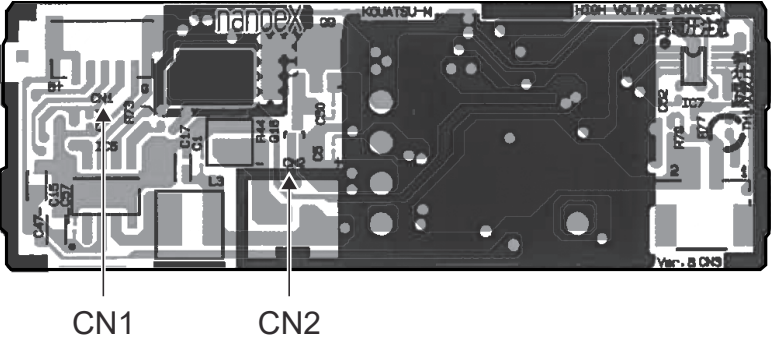

10.3 CU-2WZ71YBE5

10.3.1 Main Printed Circuit Board

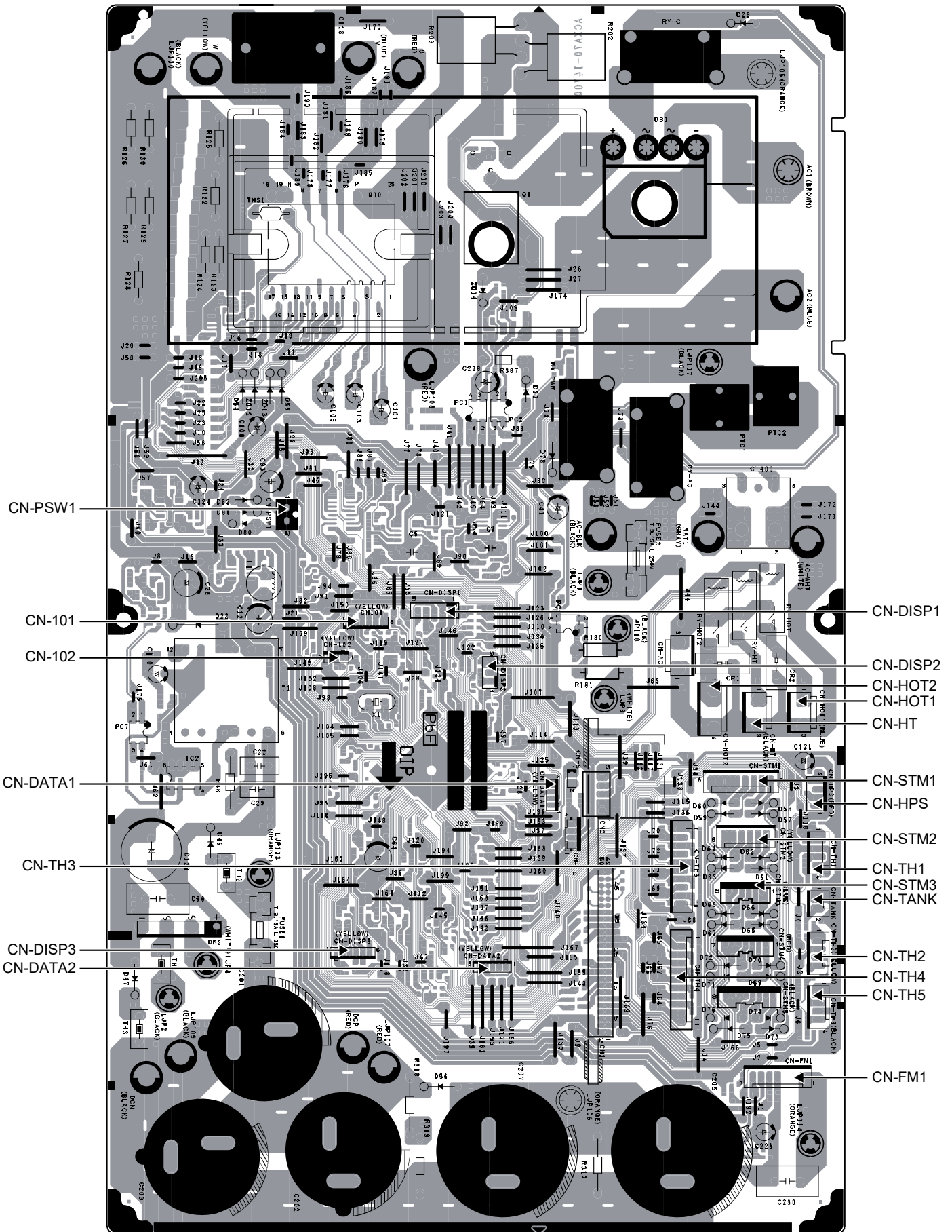

10.3.2 Noise Filter Printed Circuit Board

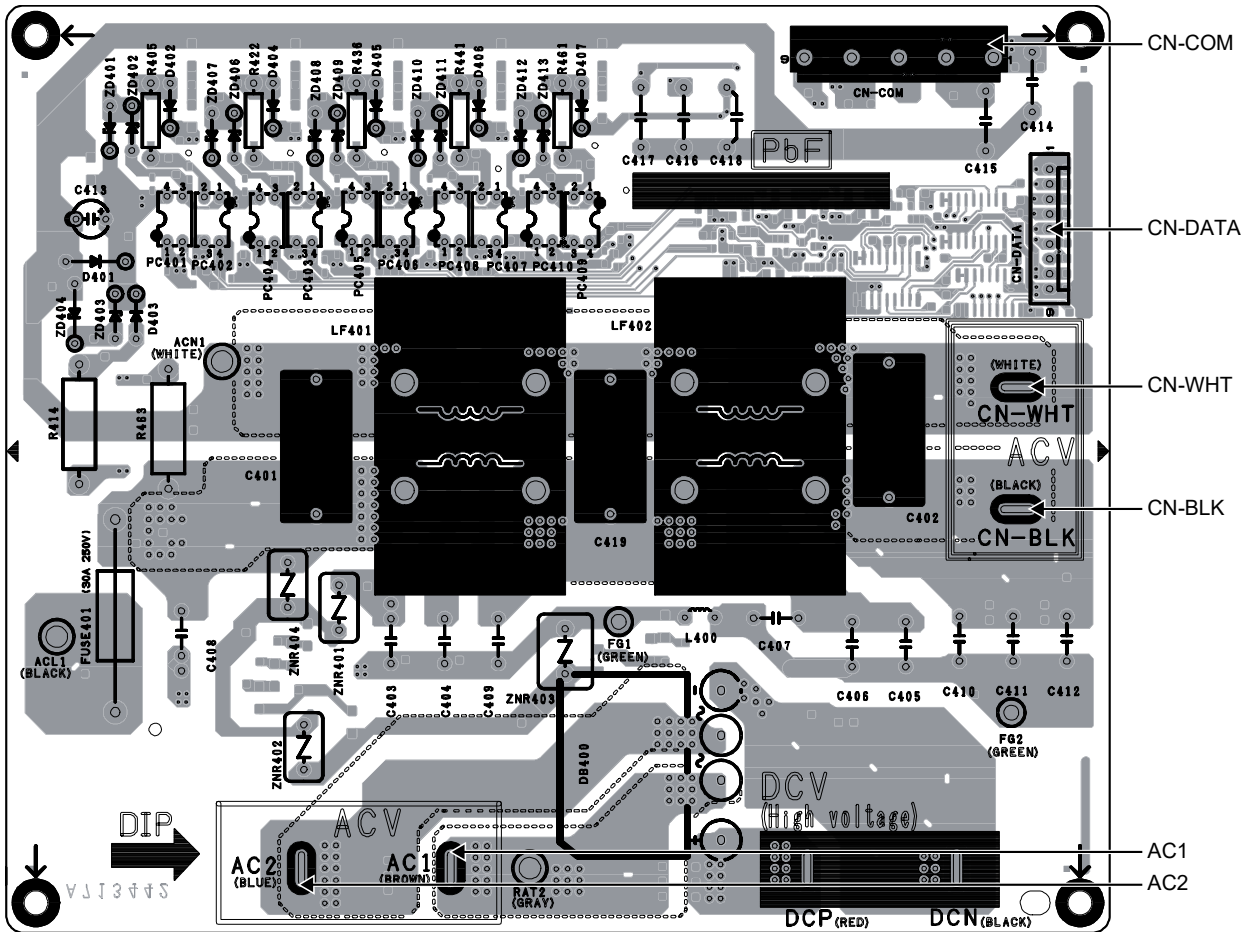

10.3.3 Display Printed Circuit Board

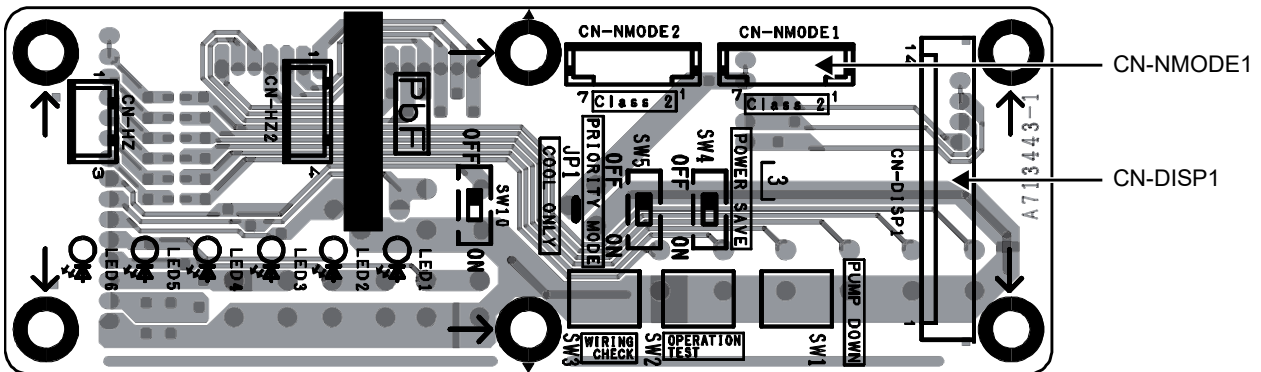

11. Installation Instruction (WH-ADF0309J3E5CM)

11.1 Indoor Floor Area Requirement

- If the total refrigerant charge in the system is <1.84 kg, no additional minimum floor area is required.
- If the total refrigerant charge in the system is ≥ 1.84 kg, additional minimum floor area requirements is complied as described below:

Symbol	Description	Unit
m_c	Total refrigerant charge in system	kg
m_{max}	Maximum refrigerant charge allowed	kg
m_{excess}	$m_c - m_{max}$	kg
H	Installation height	m
VA_{min}	Minimum ventilation opening area	cm ²

Total refrigerant charge in system, m_c (kg)
 = Pre-charged refrigerant amount in unit (kg)
 + Additional refrigerant amount after installation (kg)

- A) Determine **Maximum refrigerant charge allowed, m_{max}**
1. Calculate Installation Room Area, A_{room} .
 2. Based on Table I, select m_{max} which corresponds to the calculated A_{room} value.
 3. If $m_{max} \geq m_c$, the unit can be installed in the installation room with the specified installation height ($H=1640mm$) in Table I and without additional room area or any additional ventilation.
 4. Else, proceed to B) and C).
- B) Determine **Total Floor Area of A_{room} and B_{room} compliance to $A_{min total}$**
1. Calculate the B_{room} area adjacent to the A_{room} .
 2. Determine the $A_{min total}$ based on the Total Refrigerant Charge, m_c from Table II.
 3. The total floor area of both A_{room} and B_{room} must exceed $A_{min total}$.
- C) Determine **Minimum Venting Opening Area, VA_{min} for natural ventilation**
1. From Table III, calculate m_{excess} .
 2. Then determine VA_{min} corresponding to the calculated m_{excess} for natural ventilation between A_{room} and B_{room} .
 3. The unit can be installed at specific room only when the following conditions are fulfilled:
 - Two permanent openings (cannot be closed), one at bottom, another at top, for ventilation purposes are made between A_{room} and B_{room} .
 - **Bottom opening:**
 - Must comply to the minimum area requirement of VA_{min} .
 - Opening must be located $\leq 300mm$ from the floor.
 - At least 50% of required opening area must be $\leq 200mm$ from the floor.
 - The bottom of the opening shall not be higher than the point of release when the unit is installed and must be situated $\leq 100mm$ above the floor.
 - **Top opening:**
 - The total size of the Top opening must be more than 50% of VA_{min} .
 - Opening must be located $\geq 1500mm$ above the floor.
 - The height of the openings must more than 20mm.
 - A direct ventilation opening to outside is **NOT** encouraged for ventilation opening (the user can block the opening when it is cold).
 - The value of H is considered as 0.6m to comply to IEC 60335-2-40:2018 Clause GG2.

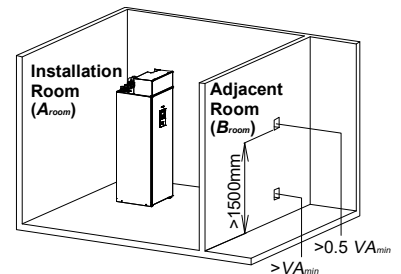

Table I - Maximum refrigerant charge allowed in a room

A_{room} (m ²)	Maximum refrigerant charge in a room (m_{max}) (kg)
	$H=1.64m$
1	0.378
2	0.755
3	1.133
4	1.510
5	1.888
6	2.266
7	2.479
8	2.650
9	2.811
10	2.963
11	3.107
12	3.246

- For intermediate A_{room} values, the value that corresponds to the lower A_{room} value from the table is considered.
Example:
For $A_{room} = 10.5$ m², the value that corresponds to " $A_{room} = 10$ m²" is considered.

Table II - Minimum floor area

m_c (kg)	Minimum floor area ($A_{min total}$) (m ²)	m_c (kg)	Minimum floor area ($A_{min total}$) (m ²)
	$H=1.64m$		$H=1.64m$
1.84	4.87	2.54	7.35
1.86	4.93	2.56	7.47
1.88	4.98	2.58	7.58
1.90	5.03	2.60	7.70
1.92	5.08	2.62	7.82
1.94	5.14	2.64	7.94
1.96	5.19	2.66	8.06
1.98	5.24	2.68	8.18
2.00	5.30	2.70	8.30
2.02	5.35	2.72	8.43
2.04	5.40	2.74	8.55
2.06	5.46	2.76	8.68
2.08	5.51	2.78	8.80
2.10	5.56	2.80	8.93
2.12	5.61	2.82	9.06
2.14	5.67	2.84	9.19
2.16	5.72	2.86	9.32
2.18	5.77	2.88	9.45
2.20	5.83	2.90	9.58
2.22	5.88	2.92	9.71
2.24	5.93	2.94	9.85
2.26	5.99	2.96	9.98
2.28	6.04	2.98	10.12
2.30	6.09	3.00	10.25
2.32	6.14	3.02	10.39
2.34	6.24	3.04	10.53
2.36	6.34	3.06	10.67
2.38	6.45	3.08	10.81
2.40	6.56	3.10	10.95
2.42	6.67	3.12	11.09
2.44	6.78	3.14	11.23
2.46	6.89	3.16	11.38
2.48	7.01	3.18	11.52
2.50	7.12	3.20	11.67
2.52	7.23	-	-





- For intermediate m_c values, the value that corresponds to the higher m_c value from the table is considered.
Example:
If $m_c = 1.85$ kg, the value that corresponds to " $m_c = 1.86$ kg" is considered.
- Charges above 3.20 kg are not allowed in the unit.

Table III - Minimum venting opening area for natural ventilation

m_c (kg)	m_{max} (kg)	m_{excess} (kg) = $m_c - m_{max}$	Minimum venting opening area (VA_{min}) (cm ²)
			$H=1.64m$
3.2	0.1	3.1	759
3.2	0.3	2.9	710
3.2	0.5	2.7	661
3.2	0.7	2.5	612
3.2	0.9	2.3	563
3.2	1.1	2.1	514
3.2	1.3	1.9	465
3.2	1.5	1.7	416
3.2	1.7	1.5	367
3.2	1.9	1.3	318
3.2	2.1	1.1	269
3.2	2.3	0.9	220
3.2	2.5	0.7	178
3.2	2.7	0.5	132
3.2	2.9	0.3	82
3.2	3.1	0.1	28
3.2	3.2	0.0	0

- For intermediate m_{excess} values, the value that corresponds to the higher m_{excess} value from the table is considered.
Example:
 $m_{excess} = 1.45$ kg, the value that corresponds to " $m_{excess} = 1.5$ kg" is considered.

Attached accessories

No.	Accessory part	Qty.	No.	Accessory part	Qty.
1	Adjustable Feet 	4	4	Remote Controller Cover 	1
2	Drain Elbow 	1			
3	Packing 	1	5	Network Adaptor (CZ-TAW1) 	1

Optional Accessories

No.	Accessories part	Qty.
6	Optional PCB (CZ-NS4P)	1
7	Network Adaptor (CZ-TAW1) and Extension Cable (CZ-TAW1-CBL)	1

Field Supply Accessories (Optional)

No.	Part		Model	Specifications	Maker
i	Room thermostat	Wired	PAW-A2W-RTWIRED	AC230V	-
		Wireless	PAW-A2W-RTWIRELESS		
ii	Mixing valve	-	167032	AC230V	Caleffi
iii	Pump	-	Yonos 25/6	AC230V	Wilo
iv	Buffer tank sensor	-	PAW-A2W-TSBU	-	-
v	Zone water sensor	-	PAW-A2W-TSHC	-	-
vi	Zone room sensor	-	PAW-A2W-TSRT	-	-
vii	Solar sensor	-	PAW-A2W-TSSO	-	-

- It is recommended to purchase the field supply accessories listed in above table.

11.2 Indoor Unit

11.2.1 Select the Best Location

Before choosing the installation site, obtain user approval.

- Install the Tank Unit in indoors with frost free weather proof location only.
- Must install on a flat horizontal and solid hard surface.
- There should not be any heat source or steam near the Tank Unit.
- A place where air circulation in the room is good.
- A place where drainage can be easily done (e.g. Utility room).
- A place where Tank Unit's operation noise will not cause discomfort to the user.
- A place where Tank Unit is far from door way.
- A place where accessible for maintenance.
- Ensure to keep minimum distance of spaces as illustrated below from wall, ceiling, or other obstacles.
- A place where flammable gas leaking might not occur.
- Secure the Tank Unit to prevent it being knocked over accidentally or during earthquakes.

Please avoid installations which expose the Tank Unit to any of the following conditions:

- Extraordinary environment conditions; installation in frost or exposure to unfavorable weather conditions.
- Voltage input exceeding the specified voltage.

11.2.1.1 Required Space for Installation

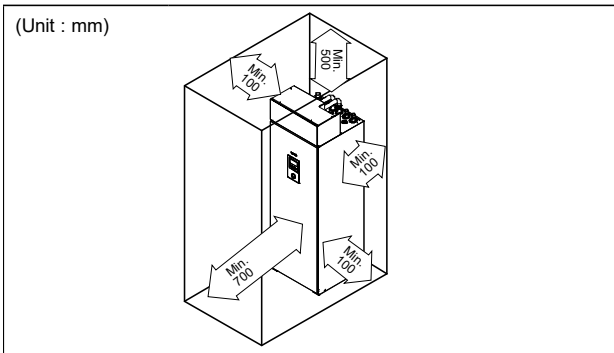

11.2.1.2 Transport and Handling

- Be careful during transporting the unit so that it is not damaged by impact.
- Only remove the packaging material once it has reached its desired installation location.
- It may need three or more people to carry out the installation work. The weight of Tank Unit might cause injury if carried by one person.
- The Tank Unit can be transported either in vertical or horizontal.
 - If transported in horizontal, make sure Front of packaging material (printed with "FRONT") must facing upwards.
 - If transported in vertical, use the hand holes on sides, slide and move to the desired location.
- Fix the Adjustable Feet [1], if the Tank unit installed on a uneven surface.

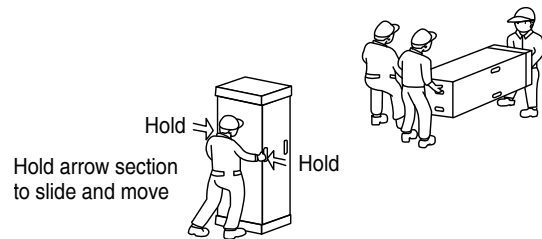

11.2.2 To Drill a Hole in the Wall and Install a Sleeve of Piping

1. Make a $\varnothing 70$ mm through hole.
2. Insert the piping sleeve to the hole.
3. Fix the bushing to the sleeve.
4. Cut the sleeve until it extrudes about 15 mm from the wall.

CAUTION

When the wall is hollow, please be sure to use the sleeve for tube assembly to prevent dangers caused by mice biting the connection cable.

5. Finish by sealing the sleeve with putty or caulking compound at the final stage.

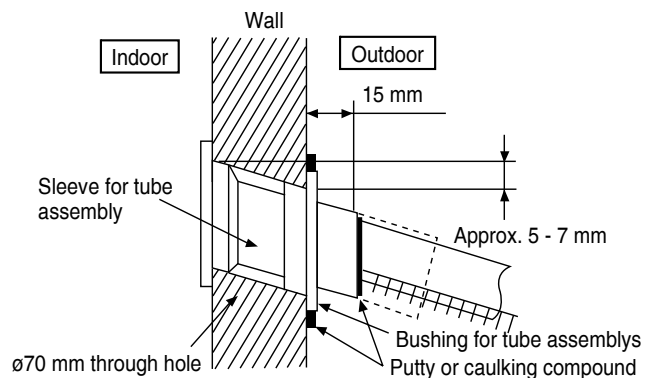

11.2.3 Piping Installation

11.2.3.1 Water Quality Requirement

Must use water that complies with European water quality standard 98/83 EC. The lifespan of the Tank Unit will be shorter if groundwater (include spring water and well water) is used.

The Tank Unit shall not be used with the tap water containing contaminants such as salt, acid, and other impurities which may corrode the tank and its component.

11.2.3.2 Typical Piping Installation

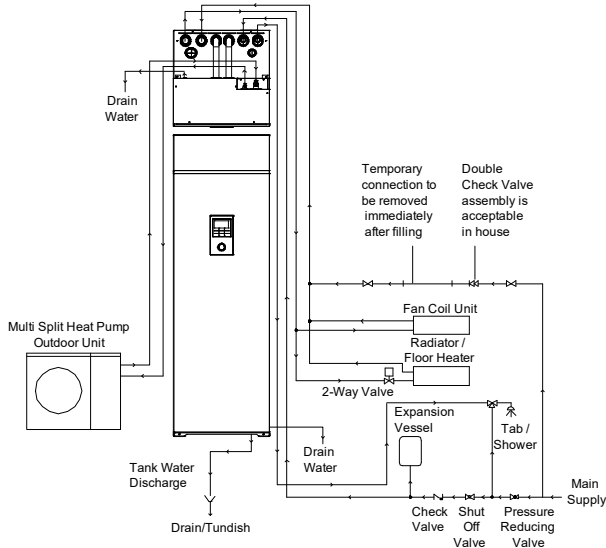

11.2.3.3 Access to Internal Components

⚠ WARNING

This section is for authorized and licensed electrician/water system installer only. Work behind the front plate secured by screws must only be carried out under supervision of qualified contractor, installation engineer or service person.

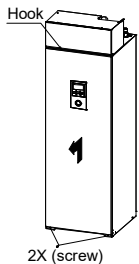

⚠ CAUTION

Open or close the Front Plate carefully. The heavy Front Plate may injure the fingers.

• Open and Close Front Plate ⑯

- 1 Remove the 2 mounting screws of Front Plate ⑯.
- 2 Slide it upwards to unhook the Front Plate ⑯ hook.
- 3 Reverse above steps 1~2 for close it.

11.2.3.4 Refrigerant Piping Installation

This Tank Unit is designed for combination with Panasonic Multi Split Heat Pump Outdoor Unit. If Outdoor Unit from other manufacturer are being used in combination with Panasonic Tank Unit, optimum operation and reliability of the system is not guaranteed. Thus warranty cannot be given in such case.

- 1 Connect Tank Unit to Multi Split Heat Pump Outdoor Unit with correct piping size.

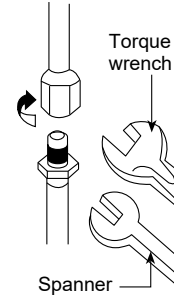

Model		Piping size (Torque)	
Tank Unit	Outdoor Unit	Gas	Liquid
WH-ADF0309J3E5CM	CU-2WZ71YBE5	ø12.7mm (1/2") [55 N•m]	ø6.35mm (1/4") [18 N•m]

⚠ CAUTION

Do not overtighten, overtightening may cause gas leakage.

Do not pull and push refrigerant piping excessively, deformed pipe may cause refrigerant leak.

- 2 Please make flare after inserting flare nut (located at joint portion of tube assembly) onto the copper pipe. (In case of using long piping)
- 3 Do not use pipe wrench to open refrigerant piping. Flare nut may be broken and cause leakage. Use proper spanner or ring wrench.
- 4 Connect the piping:
 - Align the centre of piping and sufficiently tighten the flare nut with fingers.
 - Further tighten the flare nut with torque wrench in specified torque as stated in the table.

Additional Precautions For R32 Models when connecting by flaring at indoor side

⚠ Ensure to do the re-flaring of pipes before connecting to units to avoid leaking.

⚠ Connections made between components of refrigerant system shall be accessible for ease of maintenance.

Seal sufficiently the flare nut (both gas and liquid sides) with neutral cure (Alkoxy type) & ammonia-free silicone sealant and insulation material to avoid the gas leak caused by freezing.

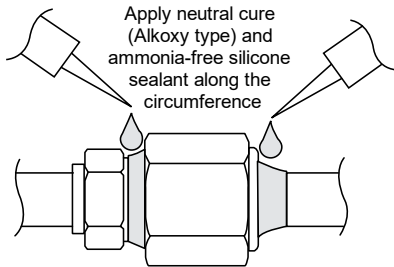

Neutral cure (Alkoxy type) & ammonia-free silicone sealant is only to be applied after pressure testing and cleaning up by following instructions of sealant, only to the outside of the connection. The aim is to prevent moisture from entering the connection joint and possible occurrence of freezing. Curing sealant will take some time. Make sure sealant will not peel off when wrapping the insulation.

11.2.3.4.1 Checking for Gas Leakage

- Check for leakage of gas after air purging.
- See the in the installation manual for the outdoor.

11.2.3.5 Cutting and Flaring the Piping

- 1 Please cut using pipe cutter and then remove the burrs.
- 2 Remove the burrs by using reamer. If burrs is not removed, gas leakage may be caused. Turn the piping end down to avoid the metal powder entering the pipe.
- 3 Please make flare after inserting the flare nut onto the copper pipes.

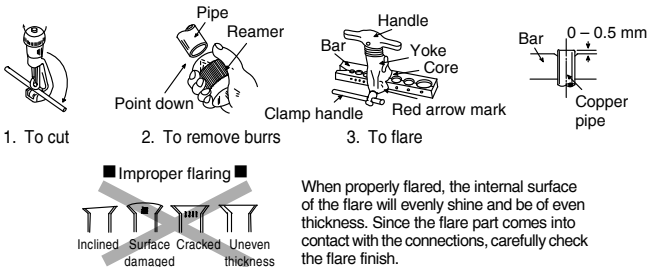

11.2.3.6 Water Piping Installation

- Please engage a licensed water circuit installer to install this water circuit.
- This water circuit must comply with relevant European and national regulations (including EN61770), and local building regulation codes.
- Ensure the components installed in the water circuit could withstand water pressure during operation.
- Do not use worn out tube.
- Do not apply excessive force to pipes that may damage the pipes.
- Choose proper sealer which can withstand the pressures and temperatures of the system.
- Make sure to use two spanners to tighten the connection. Further tighten the nuts with torque wrench in specified torque as stated in the table.
- Cover the pipe end to prevent dirt and dust when inserting it through a wall.

- If non-brass metallic piping is used for installation, make sure to insulate the pipes to prevent galvanic corrosion.
- Do not connect galvanised pipes, this will cause galvanic corrosion.
- Use correct nut for all Tank Unit tube connections and clean all tubes with tap water before installation. See Tube Position Diagram for detail.

Tube Connector	Nut Size	Torque
Ⓐ & Ⓑ	RP 1¼"	117.6 N•m
Ⓒ & Ⓓ	RP ¾"	58.8 N•m

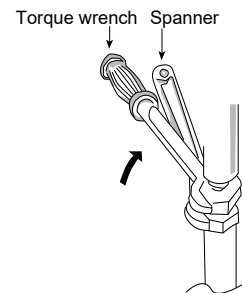

⚠ CAUTION
Do not overtighten, overtightening may cause gas leakage.

- Make sure to insulate the water circuit pipes to prevent reduction of heating capacity.
- After installation, check the water leakage condition in connection area during test run.
- Failure to connect the tube appropriately might cause the Tank Unit malfunction.
- Protection From Frost:
If the Tank Unit is being exposed to frost while power supply failure or pump operating failure, drain the system. When water is idle inside the system, freezing up is very likely to happen which could damage the system. Make sure the power supply is turned off before draining. Heater Assembly ⑧ may be damaged under dry heating.
- Corrosion Resistance:
Duplex stainless steel is naturally corrosion resistant to mains water supply. No specific maintenance is required to maintain this resistance. However, please note that Tank Unit is not guaranteed for use with a private water supply.
- It is recommended to use a tray (field supply) to collect water from the Tank Unit if water leakage occur.

(A) Space Heating Pipework

- Connect Tank Unit Tube Connector Ⓐ to outlet connector of Panel/Floor heater.
- Connect Tank Unit Tube Connector Ⓑ to inlet connector of Panel/Floor heater.
- Failure to connect the tube appropriately might cause the Tank Unit malfunction.
- Refer below table for the rated flow rate.

Model		Rated Flow Rate (l/min)
Tank Unit	Outdoor Unit	Heat
WH-ADF0309J3E5CM	CU-2WZ71YBE5	22.9

(B) Domestic Hot Water Tank Pipework

- It's strongly recommended to install an expansion vessel (field supply) in the Domestic Hot Water Tank circuit. Refer Typical Piping Installation section to locate the expansion vessel.
 - Recommended pre-charge pressure of the expansion vessel (field supply) = 0.35MPa (3.5 bars)
- In high water pressure or water supply is above 500kPa, please install the Pressure Reducing Valve for water supply. If the pressure higher than that, it might damage the Tank Unit.
- A Pressure Reducing Valve (field supply) with below specification is strongly advised to be installed along the line of the tube connector (c) of Tank Unit. Refer Typical Piping Installation section to locate both of these valves. Recommended Pressure Reducing Valve specifications:
 - Set pressure: 0.35 MPa (3.5 bars)
- Must connect a faucet to Tank Unit Tube Connector (d) and main water supply, in order to supply water with appropriate temperature for shower or tap usage. Failure to do so might cause scalding.
- Failure to connect the tube appropriately might causing the Tank Unit malfunction.

(C) Drain Elbow and Hose Installation

- Fix the Drain Elbow (2) and Packing (3) to the bottom of Drain Water Hole (h).

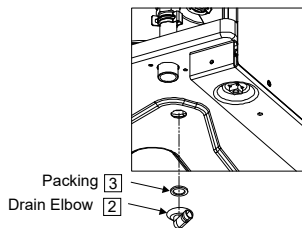

- Use inner diameter 17 mm drain hose in the market, fix to Drain Elbow (2) & Drain Elbow (i).
- This hose must to be installed in a continuously downward direction and in a frost-free environment. Improper drain piping may cause water leakage hence damage the furnitures.
- If drain hose is long, use a metal support fixture along the way to eliminate the wavy pattern of drain tube.
- Guide the drain hose to outdoor as illustrated.

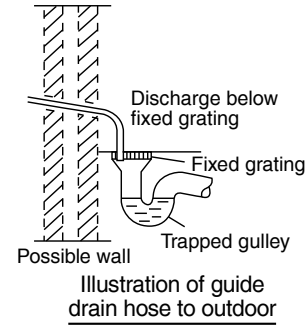

- Do not insert this hose into sewage or drain pipe that may generate ammonia gas, sulphuric gas etc.
- If necessary, use hose clamp to further tighten the hose at drain hose connector to prevent leakage.
- Water will drip from this hose, therefore the outlet of this hose must be installed in an area where the outlet cannot become blocked.

(D) Domestic Hot Water Tank Discharge (Drain Tap) and Safety Relief Valve Pipework

- Safety Relief Valve 0.8MPa (8 bars) incorporated in Domestic Hot Water Tank.
- Drain Tap and Safety Relief Valve discharge fittings share the same drainage outlet.
- Use R $\frac{1}{2}$ " male connector for this drainage outlet connection (Tube connector (g)).
- Piping must always be installed in a continuously downward direction. It must not be longer than 2m, with no more than 2 elbows, and must not allow condensation to build up or freezing to occur.
- The pipe from this drainage outlet fitting must not be shut off. The discharge must be freed.
- The end of this pipework must be in such a way so that the outlet is visible and can not cause any damage. Keep away from electrical components.
- It is recommended to fit a tundish into this (g) pipework. Tundish should be visible and positioned away from frost environment and electrical components.

11.2.4 Connect the Cable to the Tank Unit

⚠ WARNING

This section is for authorized and licensed electrician only. Work behind the Control Board Cover ③ secured by screws must only be carried out under supervision of qualified contractor, installation engineer or service person.

⚠ CAUTION

Please take extra precaution when open the control board cover ③ and control board ④ for unit installation and servicing. Failure to do so may cause injury.



11.2.4.1 Wiring System Diagram

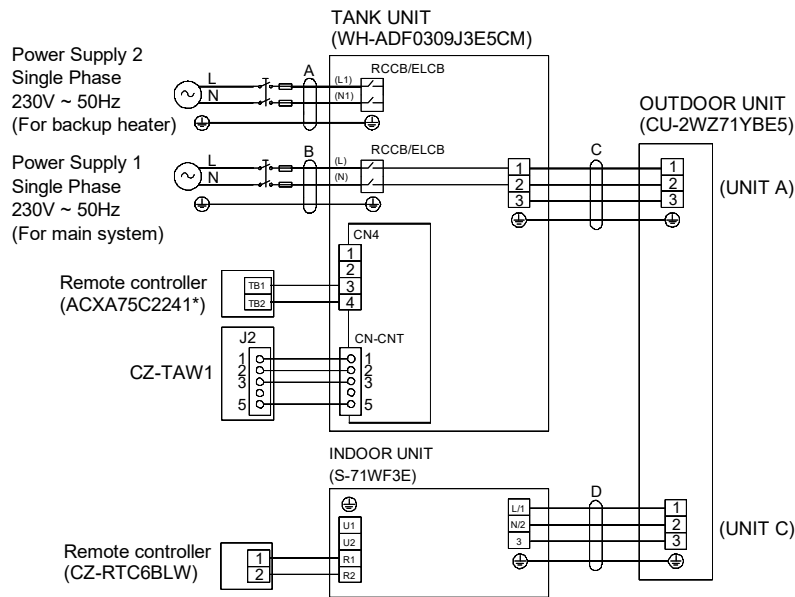

1 See below table for cable size requirements.

Model			Connecting Cable	Min. Cable Size	Max. Cable Length
Tank Unit	Outdoor Unit	Indoor Unit			
WH-ADF0309J3E5CM	CU-2WZ71YBE5	S-71WF3E	A	3 x min 1.5 mm ²	---
			B	3 x min 4.0 mm ²	---
			C	4 x min 4.0 mm ²	40 m
			D	4 x min 1.5 mm ²	40 m

2 Refer to Outdoor Installation Manual for detailed connection between Outdoor Unit & Indoor Unit.

3 For optional accessories refer individual Installation Manuals.

11.2.4.2 Fixing of Power Supply Cable and Connecting Cable

1 Connecting cable between Tank Unit and Outdoor Unit shall be approved polychloroprene sheathed flexible cord, type designation 60245 IEC 57 or heavier cord. See below table for cable size requirement.

Model		Connecting Cable Size
Tank Unit	Outdoor Unit	
WH-ADF0309J3E5CM	CU-2WZ71YBE5	4 x min 4.0 mm ²

- Ensure the colour of wires of Outdoor Unit and the terminal no. are the same to the Tank Unit respectively.
- Earth wire shall be longer than the other wires as shown in the figure for the electrical safety in case of the slipping out of the cord from the Holder (Clamper).

- 2 An isolating device must be connected to the power supply cable.
 - Isolating device (disconnecting means) should have minimum 3.0 mm contact gap.
 - Connect the approved polychloroprene sheathed power supply 1 cord and power supply 2 cord and type designation 60245 IEC 57 or heavier cord to the terminal board, and to the other end of the cord to isolating device (Disconnecting means). See below table for cable size requirement.

Model		Power Supply Cord	Cable Size	Circuit Breaker	Recommended RCD
Tank Unit	Outdoor Unit				
WH-ADF0309J3E5CM	CU-2WZ71YBE5	1	3 x min 4.0 mm ²	30/40A	30mA, 2P, type S
		2	3 x min 1.5 mm ²	16A	30mA, 2P, type AC

- 3 To avoid the cable and cord being damaged by sharp edges, the cable and cord must be passed through a bushing (located at the bottom of Control Board) before terminal board. The bushing must be used and must not be removed.

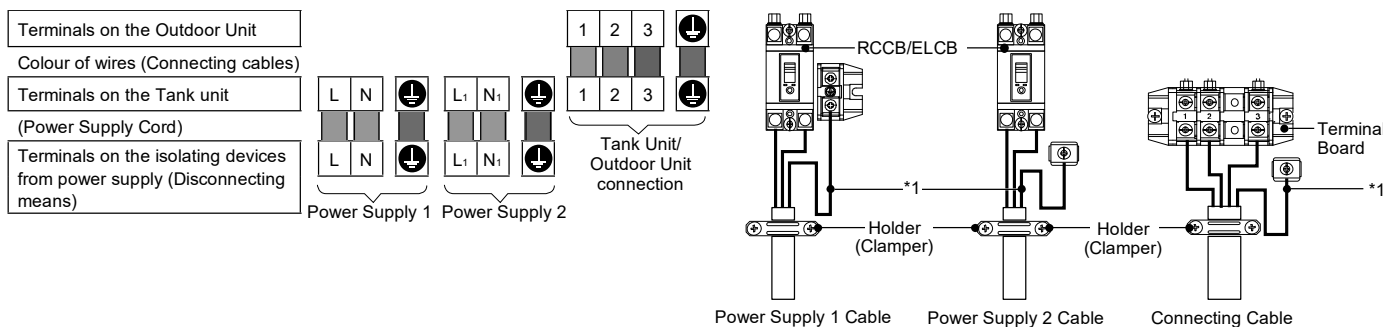

Terminal screw	Tightening torque cN•m {kgf•cm}
M4	157~196 {16~20}
M5	196~245 {20~25}

*1 - Earth wire must be longer than other cables for safety reasons

11.2.4.3 Wire Stripping and Connecting Requirement

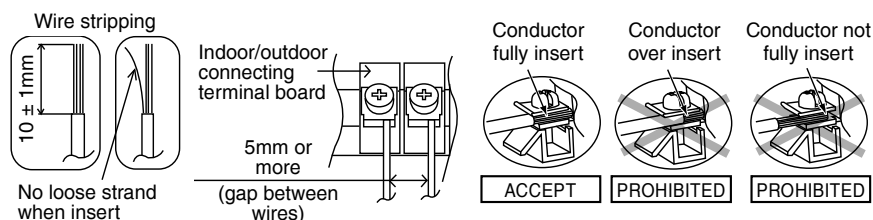

11.2.4.4 Connecting Requirement

- The equipment's Power Supply 1 complies with IEC/EN 61000-3-12 provided that the short circuit power S_{sc} is greater than or equals to 2350kW at the interface point between the user's supply and the public system. It is the responsibility of the installer or user of the equipment to ensure, by consultation with the distribution network operator if necessary, that the equipment is connected only to a supply with a short circuit power S_{sc} greater than or equals to 2350kW.
- The equipment's Power Supply 1 complies with IEC/EN 61000-3-11.
- The equipment's Power Supply 2 complies with IEC/EN 61000-3-2.
- The equipment's Power Supply 2 complies with IEC/EN 61000-3-3 and can be connected to current supply network.

11.2.5 Charging and Discharging the Water

- Make sure all the piping installations are properly done before carry out below steps.

11.2.5.1 Charge the Water

- **For Domestic Hot Water Tank**

- 1 Set the Domestic Hot Water Tank Discharge (Drain Tap) ⑨ to "CLOSE".

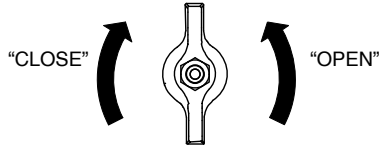

Domestic Hot Water Tank Discharge (Drain Tap) ⑨

- 2 Set all Tap / Shower "OPEN".
 - 3 Start filling water to the Domestic Hot Water Tank via Tube Connector ③.
- After 20~40min, water should flow out from Tap / Shower.
Else, please contact your local authorized dealer.
- 4 Check and make sure no water leaking at the tube connecting points.
 - 5 Set the Domestic Hot Water Tank Discharge (Drain Tap) ⑨ to "OPEN" for 10 seconds to release air from this pipeline. Then set it "CLOSE".
 - 6 Turn the Safety Relief Valve ⑫ knob counterclockwise slightly and hold for 10 seconds to release air from this pipeline. Then recover the knob to original position.
 - 7 Ensure Step 5 & 6 is carried out each time after charging water to Domestic Hot Water Tank.
 - 8 To prevent back pressure from happening to the Safety Relief Valve ⑫, do turn the Safety Relief Valve ⑫ knob counterclockwise.

- **For Space Heating**

- 1 Turn the plug on the Air Purge Valve ⑫ outlet anticlockwise by one complete turn from fully closed position.

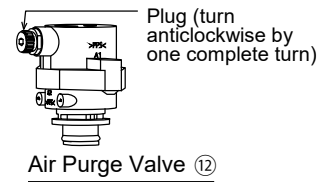

- 2 Set the Pressure Relief Valve ⑬ lever "DOWN".

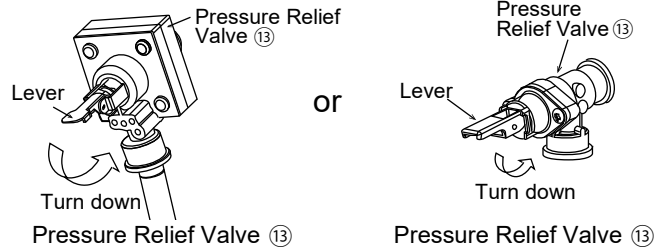

- 3 Start filling water (with pressure more than 0.1 MPa (1 bar)) to the Space Heating circuit via Tube Connector ③. Stop filling water if the free water flow through Pressure Relief Valve ⑬ discharge hose.
- 4 Turn ON the Tank Unit and make sure Water Pump ② is running.
- 5 Check and make sure no water leaking at the tube connecting points.
- 6 The water may drip from this discharge hose. Therefore must guide the hose without close or block the outlet of the hose.

11.2.5.2 Discharge the Water

- **For Domestic Hot Water Tank**

- 1 Turn OFF power supply.
- 2 Set the Domestic Hot Water Tank Discharge (Drain Tap) ⑨ to "OPEN".
- 3 Open Tap / Shower to allow air inlet.
- 4 Turn the Safety Relief Valve ⑫ knob counterclockwise slightly and hold it until all air is released from this pipeline. Then recover the knob to original position after ensured the pipeline is emptied.
- 5 After discharge, set Domestic Hot Water Tank Discharge (Drain Tap) ⑨ to "CLOSE".

11.2.6 Reconfirmation

WARNING

Be sure to switch off all power supply before performing each of the below checkings.

11.2.6.1 Check Water Pressure *(0.1 MPa = 1 bar)

Water pressure should not lower than 0.05 MPa (with inspects the Water Pressure Gauge ⑮). If necessary add water into Tank Unit (via Tube Connector ②).

11.2.6.2 Check Pressure Relief Valve ⑬

- Check for correct operation of Pressure Relief Valve ⑬ by turning on the lever to become horizontal.
- If you do not hear a clacking sound (due to water drainage), contact your local authorized dealer.
- Push down the lever after finish checking.
- In case the water keep on draining out from the Tank Unit, switch off the system, and then contact your local authorized dealer.

11.2.6.3 Expansion Vessel ⑪ Pre Pressure Checking

For Space Heating

- Expansion Vessel ⑪ with 10 L air capacity and initial pressure of 1 bar is installed in this Tank Unit.
- Total amount of water in system should be below 200 L. (Inner volume of Tank Unit's piping is about 5 L)
- If total amount of water is over 200 L, please add another expansion vessel. (field supply)
- Please keep the installation height difference of system water circuit within 10 m.

11.2.6.4 Check RCCB/ELCB

Ensure the RCCB/ELCB set to "ON" condition before check RCCB/ELCB.

Turn on the power supply to the Tank Unit.

This testing could only be done when power is supplied to the Tank Unit.

WARNING

Be careful not to touch parts other than RCCB/ELCB test button when the power is supplied to Tank Unit. Else, electrical shock may happen. Before obtaining access to terminals, all supply circuits must be disconnected.

- Push the "TEST" button on the RCCB/ELCB. The lever would turn down and indicate "0", if it functions normal.
- Contact authorized dealer if the RCCB/ELCB malfunction.
- Turn off the power supply to the Tank Unit.
- If RCCB/ELCB functions normal, set the lever to "ON" again after testing finish.

11.2.7 Installation of Remote Controller as Room Thermostat

- Remote Controller ① mounted to the Tank Unit can be moved to the room and serve as Room Thermostat.

11.2.7.1 Installation Location

- Install at the height of 1 to 1.5 m from the floor (Location where average room temperature can be detected).
- Install vertically against the wall.
- Avoid the following locations for installation.
 - 1 By the window, etc. exposed to direct sunlight or direct air.
 - 2 In the shadow or backside of objects deviated from the room airflow.
 - 3 Location where condensation occurs (The Remote Controller is not moisture proof or drip proof.)
 - 4 Location near heat source.
 - 5 Uneven surface.
- Keep distance of 1 m or more from the TV, radio and PC. (Cause of fuzzy image or noise)

11.2.7.2 Remote Controller Wiring

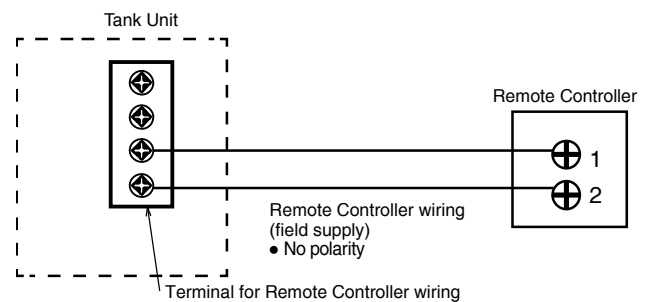

- Remote Controller cable shall be (2 x min 0.3 mm²), of double insulation PVC-sheathed or rubber sheathed cable. Total cable length shall be 50 m or less.
- Be careful not to connect cables to other terminals of Tank Unit (e.g. power source wiring terminal). Malfunction may occur.
- Do not bundle together with the power source wiring or store in the same metal tube. Operation error may occur.

11.2.7.3 Remove The Remote Controller From Tank Unit

- 1 Remove the top case from the bottom case.

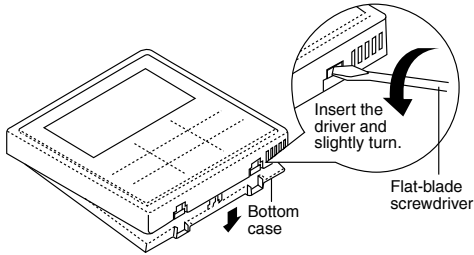

- 2 Remove the wiring between Remote controller and Tank Unit terminal.

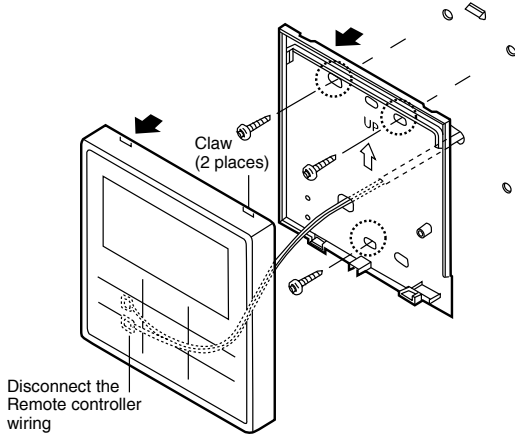

11.2.7.4 Mounting The Remote Controller

For exposed type

Preparation: Make 2 holes for screws using a driver.

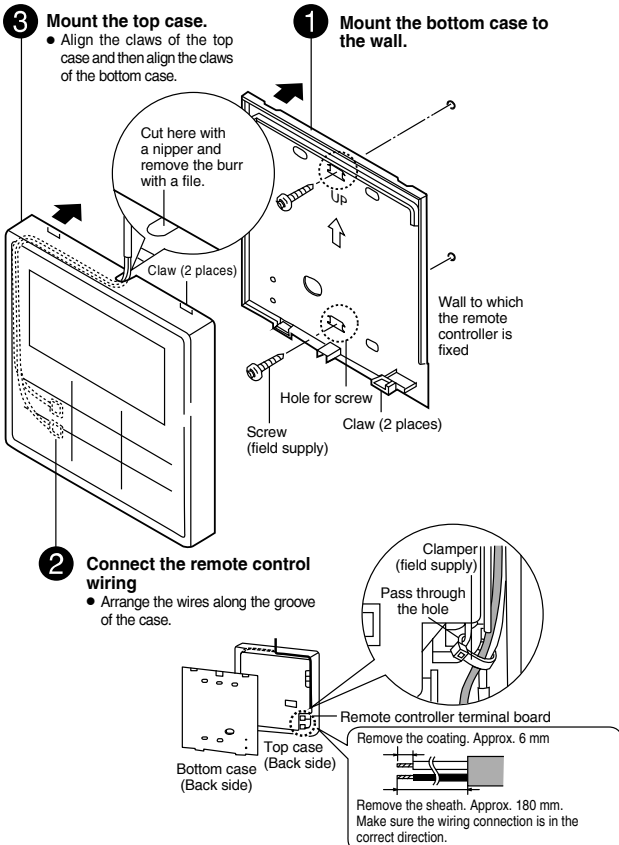

For embedded type

Preparation: Make 2 holes for screws using a driver.

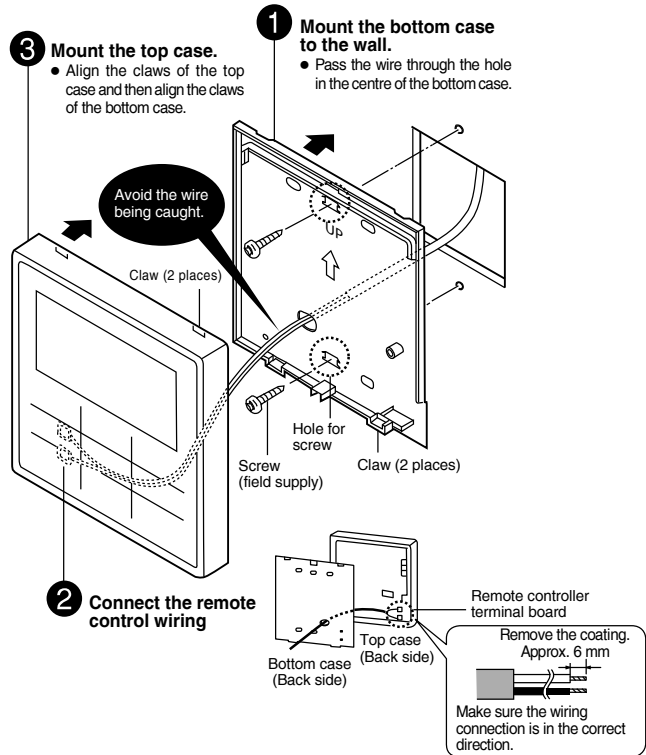

11.2.7.5 Replace The Remote Controller Cover

- Replace the existing Remote controller cover with Remote controller cover 5 to close the hole left after remove the Remote controller.

- 1 Release the Remote controller cover's hooks from behind the Front Plate 16.

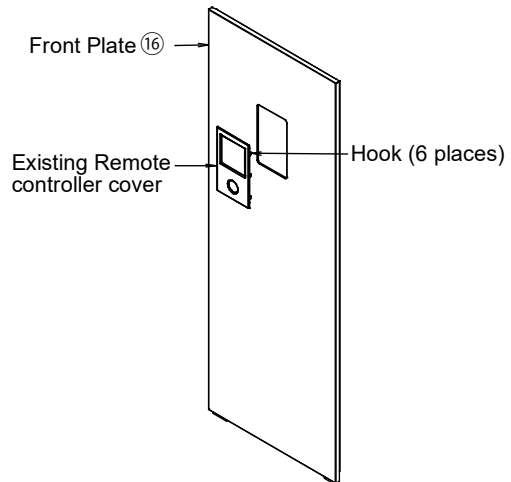

- Press from front to fix the Remote controller cover **5** on the front plate.

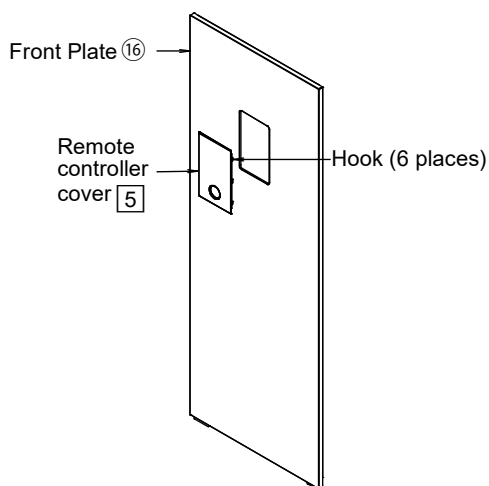

11.2.8 Test Run

- Before test run, make sure below items have been checked:-
 - Pipework are properly done.
 - Electric cable connecting work are properly done.
 - Tank Unit is filled up with water and trapped air is released.
 - Please turn on the power supply after filling the tank until full.
- Switch ON the power supply of the Tank Unit. Set the Tank Unit RCCB /ELCB to "ON" condition. Then, please refer to the Operation Instruction for operation of Remote Controller **1**.

Note:

- During winter, turn on the power supply and standby the unit for at least 15 minutes before test run. Allow sufficient time to warm up refrigerant and prevent wrong error code judgement.

- For normal operation, Water Pressure Gauge **15** reading should be in between 0.05 MPa and 0.3 MPa.
- During test run, use a container to collect high volume of discharge water from Pressure Relief Valve **13** discharge hose.
- After test run, please clean the Magnetic Water Filter Set **7**. Reinstall it after finish cleaning.

11.2.8.1 Check Water Flow of Water Circuit

Confirm the maximum water flow during main pump operation not less than 15 l/min.

*Water flow can be check through service setup (Pump Max Speed) [Heating operation at low water temperature with lower water flow may trigger "H75" during defrost process.]

11.2.8.2 Reset Overload Protector **10**

Overload Protector **10** a serves the safety purpose to prevent the water over heating. When the Overload Protector **10** a trip at high water temperature, take below steps to reset it.

- Take out the cover.
- Use a test pen to push the centre button gently in order to reset the Overload Protector **10**.
- Fix the cover to the original fixing condition.

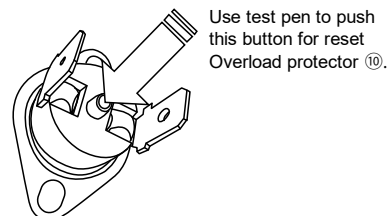

11.2.9 Maintenance

- In order to ensure safety and optimal performance of the Tank Unit, seasonal inspections on the Tank Unit, functional check of RCCB/ELCB, field wiring and piping have to be carried out at regular intervals. This maintenance should be carried out by authorized dealer. Contact dealer for scheduled inspection.

11.2.9.1 Maintenance for Magnetic Water Filter Set **7**

- Turn OFF power supply.
- Place a container below Magnetic Water Filter Set **7**.
- Turn to remove the Magnet Bar at bottom of Magnetic Water Filter Set **7**.
- By using Allen key (8mm), remove the Cap of Discharge Port.
- By using Allen Key (4mm), open the Service Valve to release the dirty water from the Discharge Port into a container. Close the service valve when the container is full to avoid spillage in the tank unit. Dispose the dirty water.
- Reinstall the Cap of Discharge Port and Magnet Bar.
- Re-charging the water to Space Heating circuit if necessary (refer Section 5 for details.)
- Turn ON power supply.

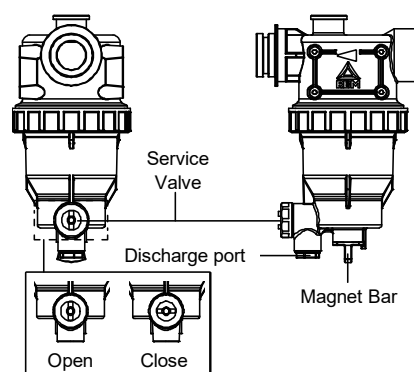

11.2.9.2 Maintenance for Pressure Relief Valve ⑬

- It is strongly recommended to operate the valve by turning the lever up & release it down a few times to ensure free water flow through discharge hose at regular intervals to ensure it is not blocked and to remove lime deposit.
- Use a container to collect high volume of discharge water from the discharge hose.

11.2.9.3 Maintenance for Safety Relief Valve ⑭

- It is strongly recommended to operate the valve by turn the knob counter clockwise to ensure free water flow through discharge pipe at regular intervals to ensure it is not blocked and to remove lime deposit.

11.3 Appendix

11.3.1 Variation of System

This section introduces variation of various systems using Air-To-Water Heatpump and actual setting method.

11.3.1.1 Introduce Application Related to Temperature Setting

11.3.1.1.1 Temperature Setting Variation for Heating

1. Remote Controller

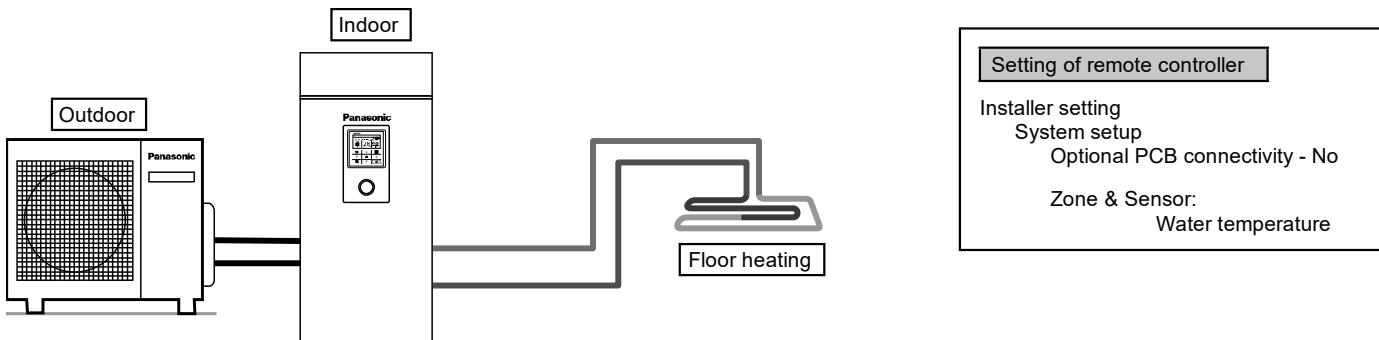

Connect floor heating or radiator directly to the Tank Unit.

Remote controller is installed on Tank Unit.

This is the basic form of the most simple system.

2. Room Thermostat

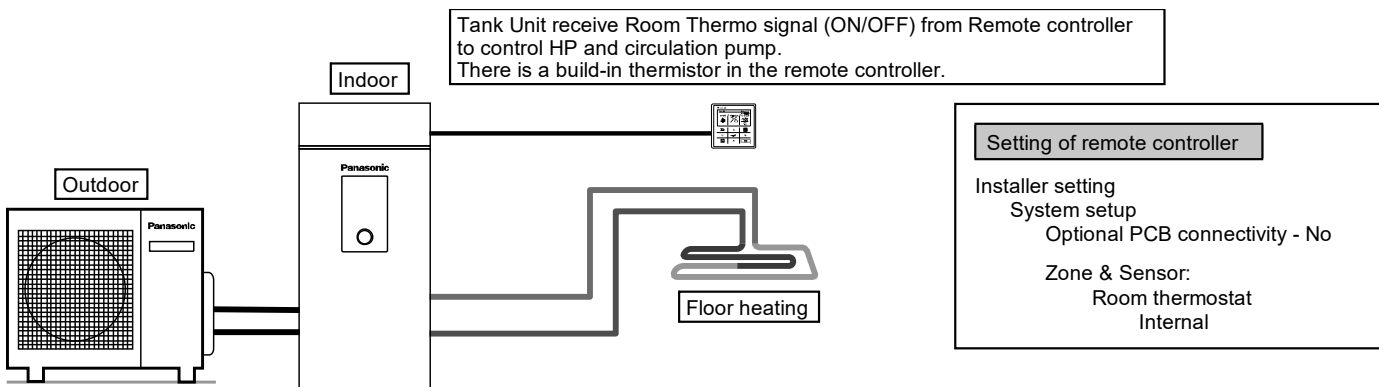

Connect floor heating or radiator directly to the Tank Unit.

Remove remote controller from Tank Unit and install it in the room where floor heating is installed.

This is an application that uses remote controller as Room Thermostat.

3. External Room Thermostat

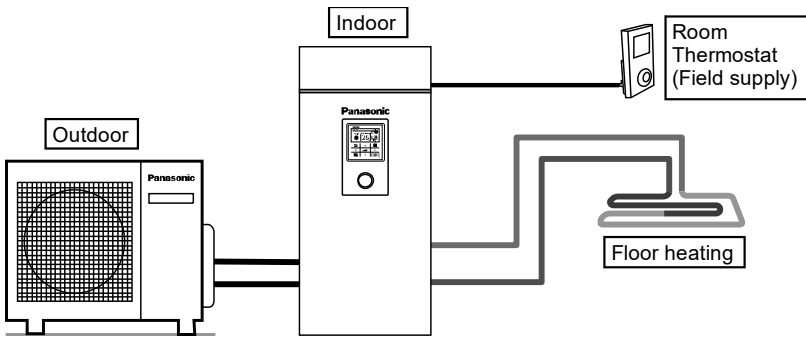

Setting of remote controller

Installer setting
 System setup
 Optional PCB connectivity - No

Zone & Sensor:
 Room thermostat
 (External)

Connect floor heating or radiator directly to Tank Unit.
 Remote controller is installed on Tank Unit.
 Install separate external Room Thermostat (field supply) in the room where floor heating is installed.
 This is an application that uses external Room Thermostat.

4. Room Thermistor

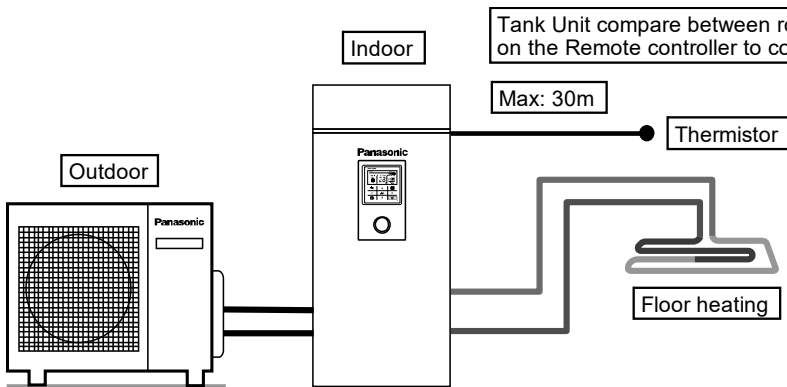

Setting of remote controller

Installer setting
 System setup
 Optional PCB connectivity - No

Zone & Sensor:
 Room thermistor

Connect floor heating or radiator directly to Tank Unit.
 Remote controller is installed on Tank Unit.
 Install separate external room thermistor (specified by Panasonic) in the room where floor heating is installed.
 This is an application that uses external room thermistor.

There are 2 kinds of circulation water temperature setting method.

- Direct: set direct circulation water temperature (fixed value)
- Compensation curve: set circulation water temperature depends on outdoor ambient temperature

In case of Room thermo or Room thermistor, compensation curve can be set.
 In this case, shift compensation curve according to the thermo ON/OFF situation.

- (Example) If room temperature increasing speed is;
 - very slow → shift up the compensation curve
 - very fast → shift down the compensation curve

11.3.1.1.2 Examples of Installations

Floor heating 1 + Floor heating 2

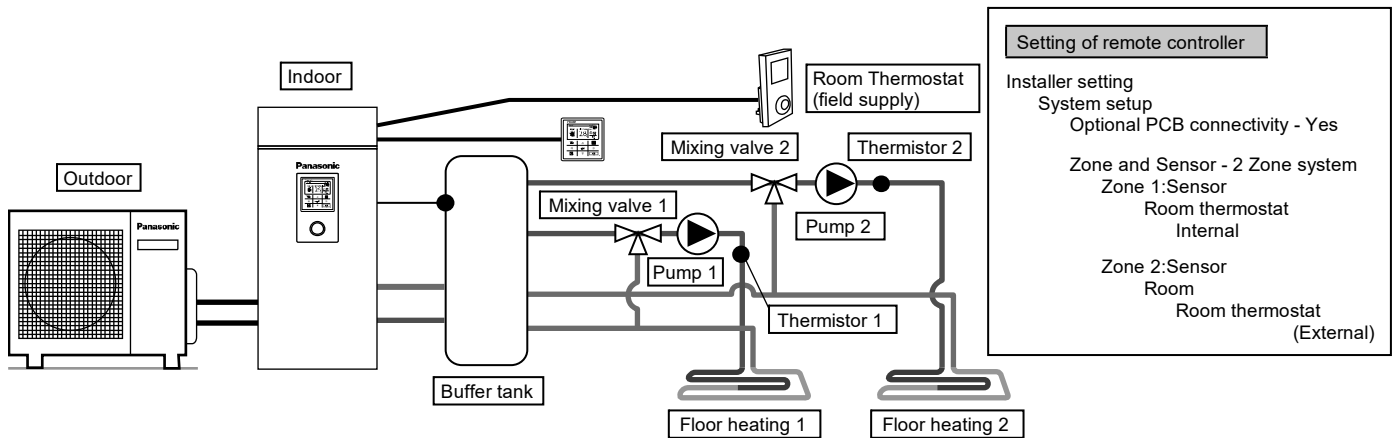

Connect floor heating to 2 circuits through buffer tank as shown in the figure.
 Install mixing valves, pumps and thermistors (specified by Panasonic) on both circuits.
 Remove remote controller from Tank Unit, install it in one of the circuit and use it as Room Thermostat.
 Install external Room Thermostat (field supply) in another circuit.
 Both circuits can set circulation water temperature independently.
 Install buffer tank thermistor on buffer tank.
 It requires connection setting of buffer tank and ΔT temperature setting at heating operation separately.
 This system requires Optional PCB (CZ-NS4P).

Floor heating + Radiator

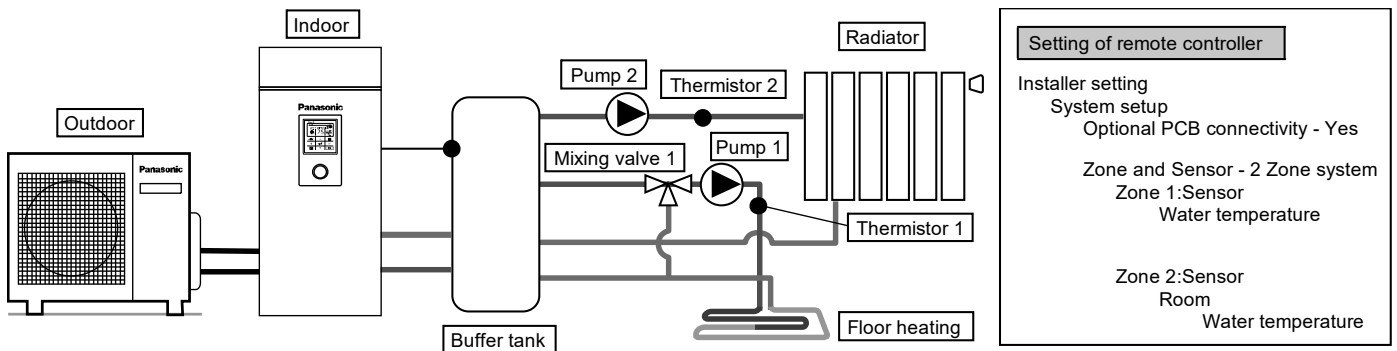

Connect floor heating or radiator to 2 circuits through buffer tank as shown in figure.
 Install pumps and thermistors (specified by Panasonic) on both circuits.
 Install mixing valve in the circuit with lower temperature among the 2 circuits.
 (Generally, if install floor heating and radiator circuit at 2 zones, install mixing valve in floor heating circuit.)
 Remote controller is installed on Tank Unit.
 For temperature setting, select circulation water temperature for both circuits.
 Both circuits can set circulation water temperature independently.
 Install buffer tank thermistor on buffer tank.
 It requires connection setting of buffer tank and ΔT temperature setting at heating operation separately.
 This system requires the Optional PCB (CZ-NS4P).
 Mind that if there is no mixing valve at the secondary side, the circulation water temperature may get higher than setting temperature.

Floor heating + Swimming pool

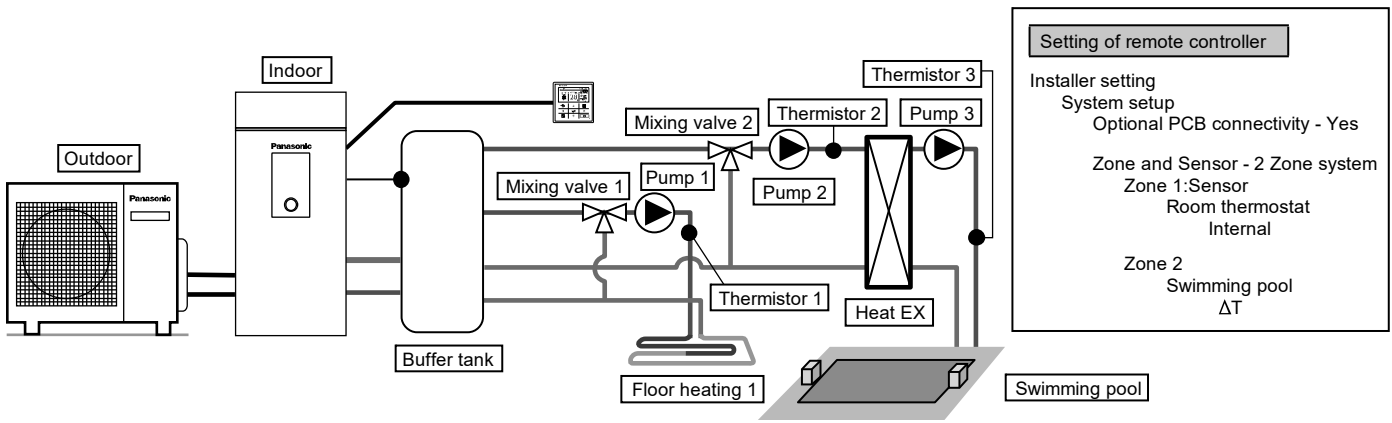

Connect floor heating and swimming pool to 2 circuits through buffer tank as shown in figure.

Install mixing valves, pumps and thermistors (specified by Panasonic) on both circuits.

Then, install additional pool heat exchanger, pool pump and pool sensor on pool circuit.

Remove remote controller from Tank Unit and install in room where floor heating is installed. Circulation water temperature of floor heating and swimming pool can be set independently.

Install buffer tank sensor on buffer tank.

It requires connection setting of buffer tank and ΔT temperature setting at heating operation separately. This system requires the Optional PCB (CZ-NS4P).

✳ Must connect swimming pool to "Zone 2".

If it is connected to swimming pool, operation of pool will stop when "Cooling" is operated.

Swimming pool only

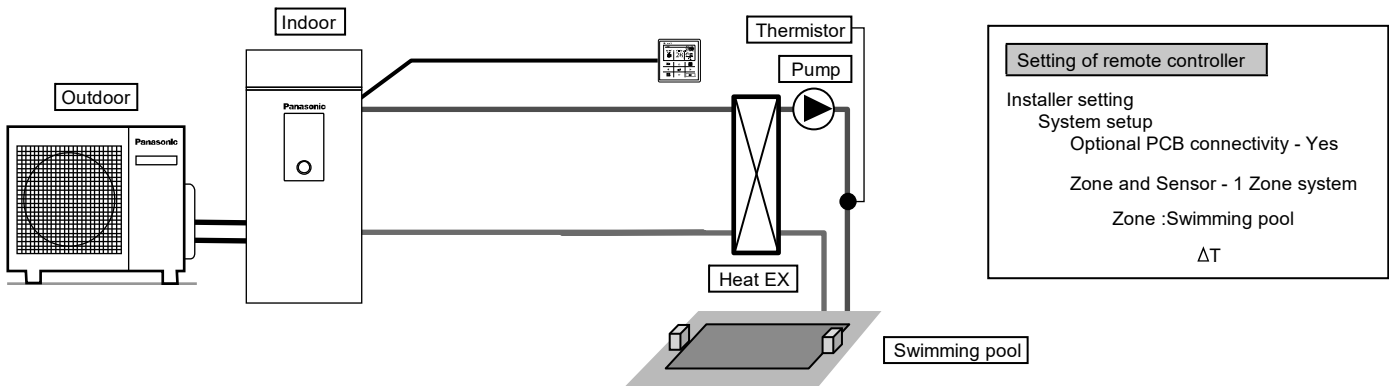

This is an application that connects to the swimming pool only.

Connects pool heat exchanger directly to Tank Unit without using buffer tank.

Install pool pump and pool sensor (specified by Panasonic) at secondary side of the pool heat exchanger.

Remove remote controller from Tank Unit and install in room where floor heating is installed.

Temperature of swimming pool can be set independently.

This system requires the Optional PCB (CZ-NS4P).

In this application, cooling mode cannot be selected. (not display on remote controller)

Simple 2 zone (Floor heating + Radiator)

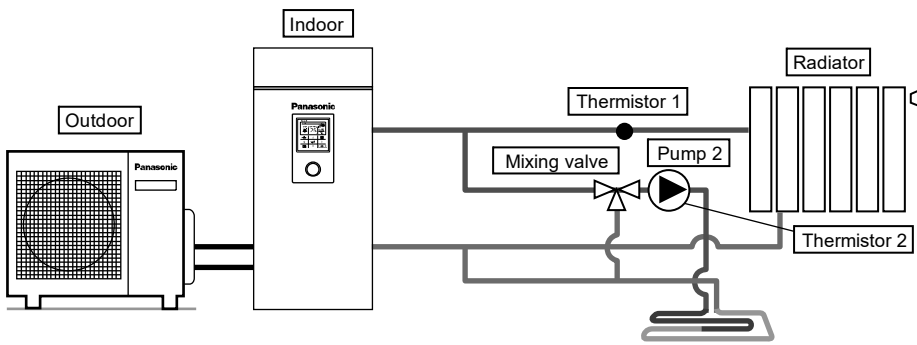

Setting of remote controller	
Installer setting	
System setup	Optional PCB connectivity - Yes
Zone and Sensor - 2 Zone system	
Zone 1:Sensor	Water temperature
Zone 2:Sensor	Room Water temperature
Operation setup	
Heat	ΔT for heating ON - 1°C
Cool	ΔT for cooling ON - 1°C

This is an example of simple 2 zone control without using buffer tank.
 Built-in pump from Tank Unit served as a pump in zone 1.
 Install mixing valve, pump and thermistor (specified by Panasonic) on zone 2 circuit.
 Please be sure to assign high temperature side to zone 1 as temperature of zone 1 cannot be adjusted.
 Zone 1 thermistor is required to display temperature of zone 1 on remote controller.
 Circulation water temperature of both circuits can be set independently.
 (However, temperature of high temperature side and low temperature side cannot be reversed)
 This system requires the Optional PCB (CZ-NS4P).

(NOTE)

- Thermistor 1 does not affect operation directly. But error happens if it is not installed.
- Please adjust flow rate of zone 1 and zone 2 to be in balance. If it is not adjusted correctly, it may affect the performance.
 (If zone 2 pump flow rate is too high, there is possibility that no hot water flowing to zone 1.)
 Total flow rate can be confirmed by "Actuator Check" from maintenance menu.

Buffer tank connection

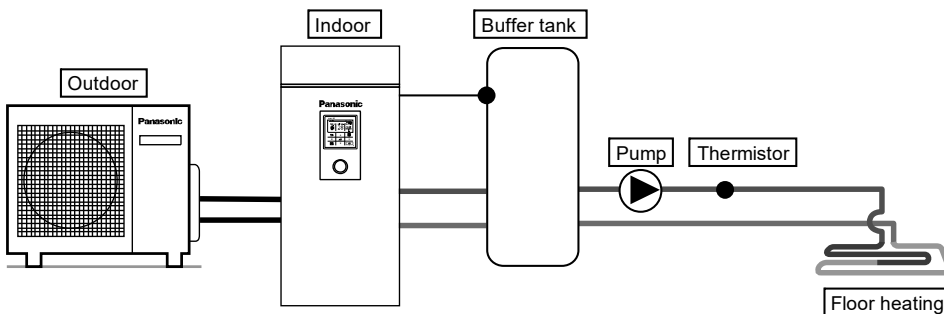

Setting of remote controller	
Installer setting	
System setup	Optional PCB connectivity - Yes
Buffer Tank connection - Yes	ΔT for buffer tank

This is an application that connects the buffer tank to the Tank Unit.
 Buffer tank's temperature is detected by buffer tank thermistor (specified by Panasonic).
 This system requires Optional PCB (CZ-NS4P).

Buffer tank + Solar

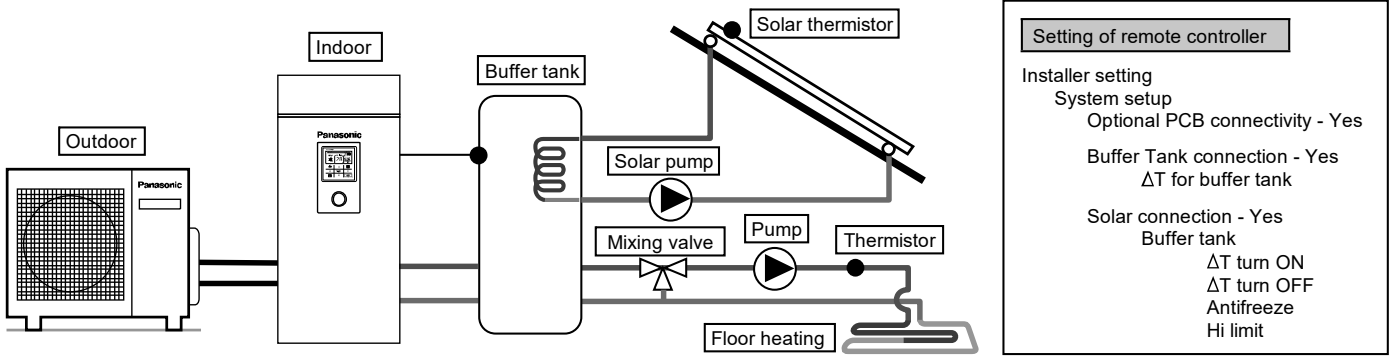

This is an application that connects the buffer tank to the Tank Unit before connecting to the solar water heater to heat up the tank.

Buffer tank's temperature is detected by buffer tank thermistor (specified by Panasonic).

Solar panel's temperature is detected by solar thermistor (specified by Panasonic).

Buffer tank shall use tank with built-in solar heat exchange coil independently.

During winter season, solar pump for circuit protection will be activated continuously. If does not want to activate the solar pump operation, please use glycol and set the anti-freezing operation start temperature to -20°C .

Heat accumulation operates automatically by comparing the temperature of tank thermistor and solar thermistor.

This system requires Optional PCB (CZ-NS4P).

Boiler connection

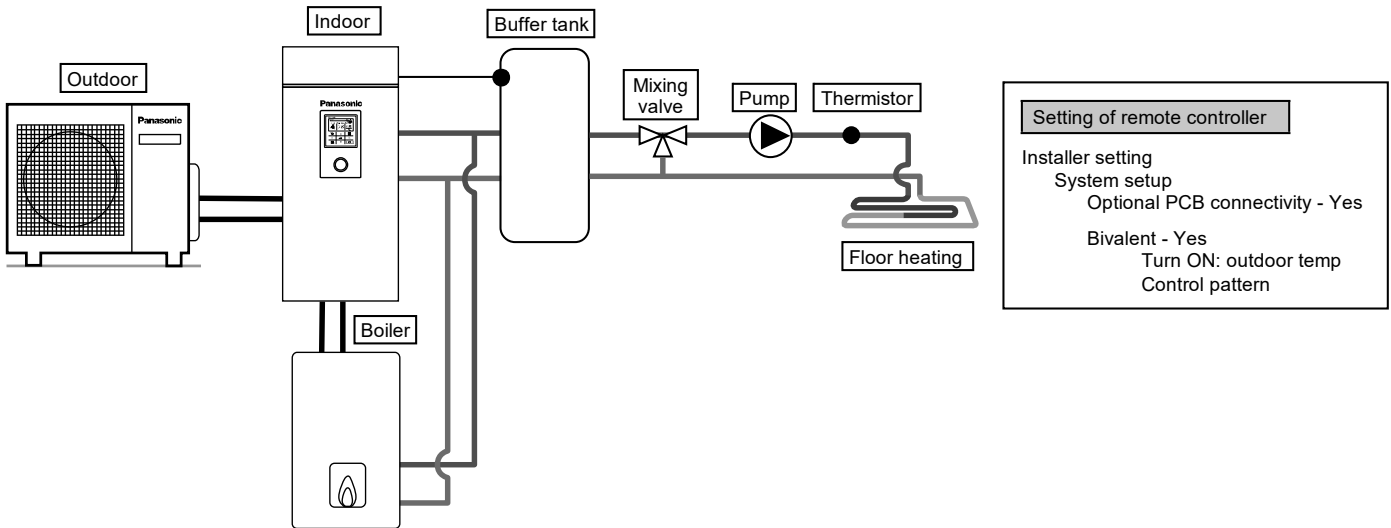

This is an application that connects the boiler to the Tank Unit, to compensate for insufficient capacity by operate boiler when outdoor temperature drops & heat pump capacity is insufficient.

Boiler is connected parallel with heat pump against heating circuit.

Besides that, an application that connects to the DHW tank's circuit to heat up tank 's hot water is also possible.

Boiler output can be control by either SG ready input from optional PCB or Auto control by 3 modes selection pattern. (Operation setting of boiler shall be responsible by installer.)

This system requires Optional PCB (CZ-NS4P) for SG ready input control or buffer tank temperature control.

Depending on the settings of the boiler, it is recommended to install buffer tank as temperature of circulating water may get higher. (It must connect to buffer tank especially when select Advanced Parallel setting.)

⚠ WARNING

Panasonic is NOT responsible for incorrect or unsafe situation of the boiler system.

⚠ CAUTION

Make sure the boiler and its integration in the system complies with applicable legislation.
 Make sure the return water temperature from the heating circuit to the Tank Unit does NOT exceed 55°C .
 Boiler is turned off by safety control when the water temperature of the heating circuit exceed 85°C .

11.3.2 How to Fix Cable

11.3.2.1 Connecting with External Device (Optional)

- All connections shall follow to the local national wiring standard.
- It is strongly recommended to use manufacturer-recommended parts and accessories for installation.
- For connection to main PCB ⑤
 - 1 Room thermostat cable must be (4 or 3 x min 0.5 mm²), of type designation 60245 IEC 57 or heavier cord, or similarly double insulation sheathed cable.
 - 2 Extra pump cable shall be (2 x min 1.5 mm²), of type designation 60245 IEC 57 or heavier.
 - 3 Boiler contact cable shall be (2 x min 0.5 mm²), of type designation 60245 IEC 57 or heavier.
 - 4 External control shall be connected to 1-pole switch with min 3.0 mm contact gap. Its cable must be (2 x min 0.5 mm²), double insulation layer of PVC-sheathed or rubber-sheathed cable.
 - * note: - Switch used shall be CE compliance component.
 - Maximum operating current shall be less than 3A_{rms}.
 - 5 Room sensor zone 1 cable shall be (2 x min 0.3 mm²) double insulation layer of PVC-sheathed or rubber-sheathed.

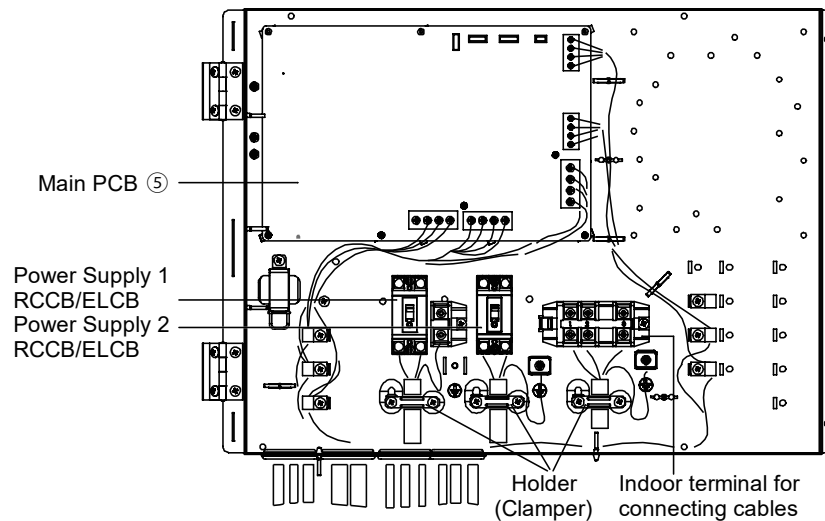

How to guide the optional cables and power supply cord
(view without internal wiring)

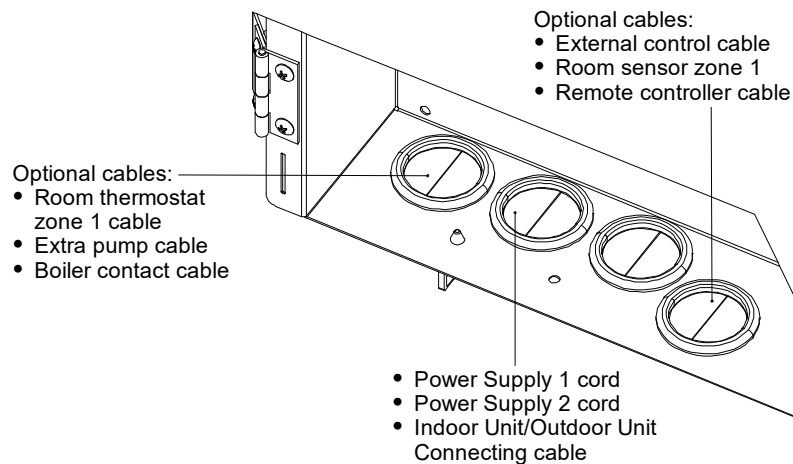

- For connection to Optional PCB [6]

- By connecting Optional PCB, 2 Zone temperature control can be achieved. Please connect mixing valves, water pumps and thermistors in zone 1 and zone 2 to each terminals in Optional PCB. Temperature of each zone can be controlled independently by remote controller.
- Pump zone 1 and zone 2 cable shall be (2 x min 1.5 mm²), of type designation 60245 IEC 57 or heavier.
- Solar pump cable shall be (2 x min 1.5 mm²), of type designation 60245 IEC 57 or heavier.
- Pool pump cable shall be (2 x min 1.5 mm²), of type designation 60245 IEC 57 or heavier.
- Room thermostat zone 1 and zone 2 cable shall be (4 x min 0.5 mm²), of type designation 60245 IEC 57 or heavier.
- Mixing valve zone 1 and zone 2 cable shall be (3 x min 1.5 mm²), of type designation 60245 IEC 57 or heavier.
- Room sensor zone 1 and zone 2 cable shall be (2 x min 0.3 mm²), double insulation layer (with insulation strength of minimum 30V) of PVC-sheathed or rubber-sheathed cable.
- Buffer tank sensor, pool water sensor and solar sensor cable shall be (2 x min 0.3 mm²), double insulation layer (with insulation strength of minimum 30V) of PVC-sheathed or rubber-sheathed cable.
- Water sensor zone 1 and zone 2 cable shall be (2 x min 0.3 mm²), double insulation layer of PVC-sheathed or rubber-sheathed cable.
- SG signal cable shall be (3 x min 0.3 mm²), double insulation layer of PVC-sheathed or rubber-sheathed cable.
- Heat/Cool switch cable shall be (2 x min 0.3 mm²), double insulation layer of PVC-sheathed or rubber-sheathed cable.
- External compressor switch cable shall be (2 x min 0.3 mm²), double insulation layer of PVC-sheathed or rubber-sheathed cable.

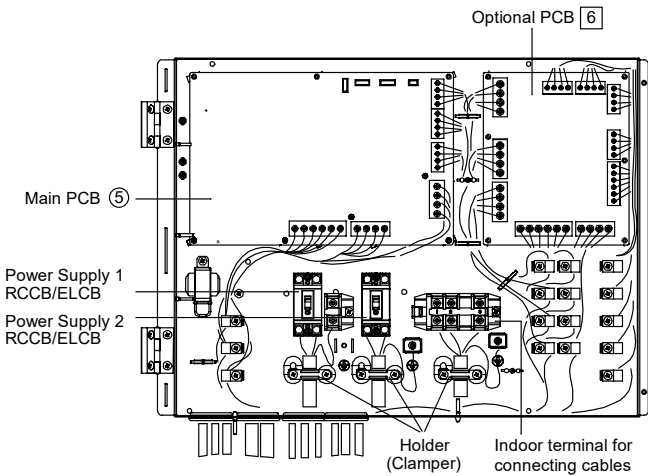

How to guide the optional cables and power supply cord
(view without internal wiring)

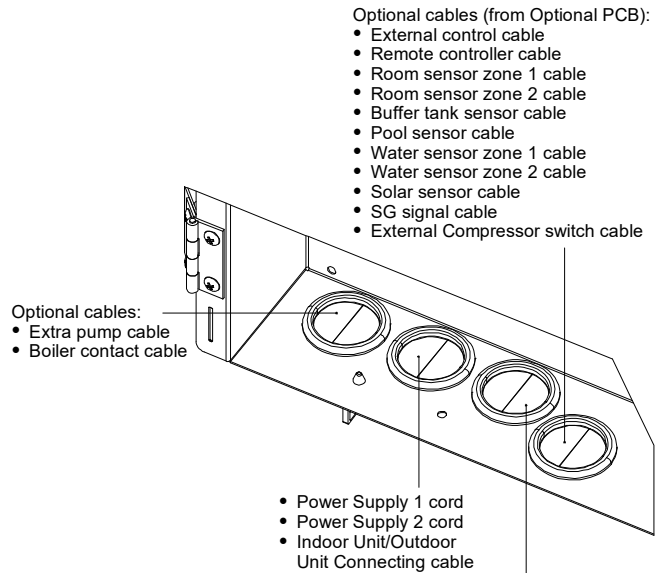

- Optional cables (from Optional PCB):
- External control cable
 - Remote controller cable
 - Room sensor zone 1 cable
 - Room sensor zone 2 cable
 - Buffer tank sensor cable
 - Pool sensor cable
 - Water sensor zone 1 cable
 - Water sensor zone 2 cable
 - Solar sensor cable
 - SG signal cable
 - External Compressor switch cable

- Optional cables:
- Extra pump cable
 - Boiler contact cable

- Power Supply 1 cord
- Power Supply 2 cord
- Indoor Unit/Outdoor Unit Connecting cable

- Optional cables (from Optional PCB):
- Pump zone 1 cable
 - Pump zone 2 cable
 - Solar pump cable
 - Room thermostat zone 1 cable
 - Room thermostat zone 2 cable
 - Mixing valve zone 1 cable
 - Mixing valve zone 2 cable

Terminal screw on PCB	Maximum tightening torque cN•m {kgf•cm}
M3	50 {5.1}
M4	120 {12.24}

11.3.2.2 Guide Optional Cables and Power Supply Cords to Bushings

 CAUTION
Wire guiding shall be free from hot surfaces. Else, cable insulator damage and electrical shock may happen.
Wire ways shall be smooth and free from sharp edges. Else, cable insulator damage and electrical shock may happen.

- Use either "COMBINATION-1" or "COMBINATION-2" for guiding Optional Cables and Power Supply Cords to Bushings.

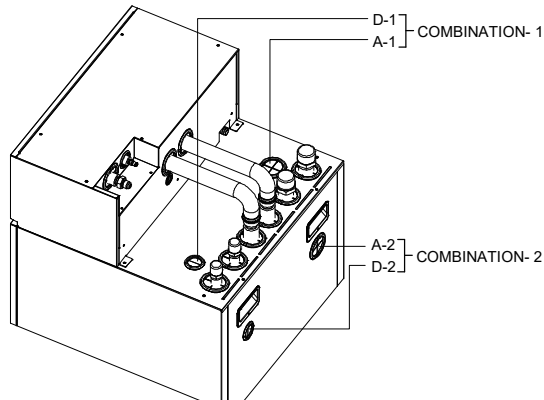

- A-1 and A-2 Bushings are for:
 - Power Supply 1 cord
 - Power Supply 2 cord
 - Indoor Unit/ Outdoor Unit Connecting cable
 - Pump zone 1 cable
 - Pump zone 2 cable
 - Solar pump cable
 - Room thermostat zone 1 cable
 - Room thermostat zone 2 cable
 - Mixing valve zone 1 cable
 - Mixing valve zone 2 cable
 - Extra pump cable
 - Boiler contact cable

- D-1 and D-2 Bushings are for:
 - External control cable
 - Remote controller cable
 - Room sensor zone 1 cable
 - Room sensor zone 2 cable
 - Buffer tank sensor cable
 - Pool sensor cable
 - Water sensor zone 1 cable
 - Water sensor zone 2 cable
 - Solar sensor cable
 - SG signal cable
 - External Compressor switch cable

- Ensure all sensor cables are not touching with Front Panel ⑩
- Guide the wiring inside the unit like below figure. Once all wiring work done, tie the cable / cord with the banding strap (field supply), to prevent them touching with hot surfaces such as Heater Assembly, bare copper pipes and etc.

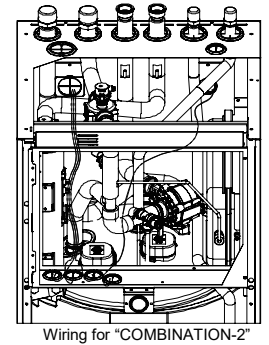
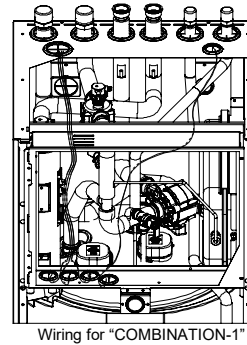

11.3.2.3 Connecting Cables Length

When connecting cables between Tank Unit and external devices, the length of the said cables must not exceed the maximum length as shown in the table.

External device	Maximum cables length (m)
Mixing valve	50
Room thermostat	50
Extra pump	50
Solar pump	50
Pool pump	50
Pump	50
Boiler contact / Defrost signal	50
External control	50
Room sensor	30
Buffer tank sensor	30
Pool water sensor	30
Solar sensor	30
Water sensor	30
SG signal	50
External compressor switch	50

11.3.2.4 Connection of the Main PCB

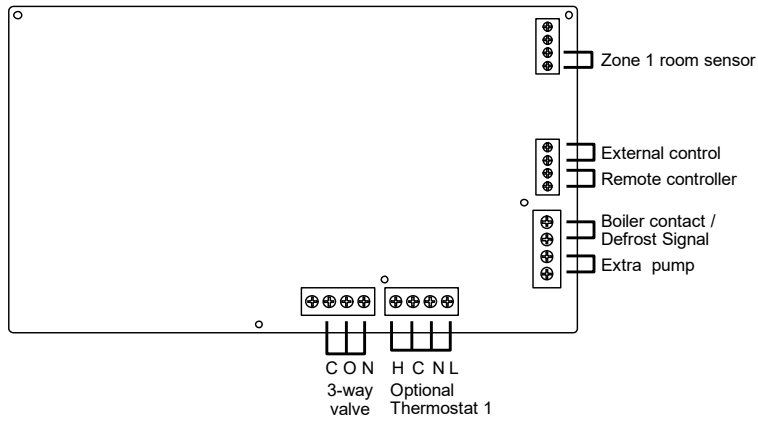

- Signal inputs

Optional Thermostat	L N =AC230V, Heat, Cool=Thermostat heat, Cool terminal * It does not function when using the Optional PCB
External control	Dry contact Open=not operate, Short=operate (System setup necessary) Able to turn ON/OFF the operation by external switch
Remote controller	Connected (Please use 2 cores wire for relocation and extension. Total cable length shall be 50m or less.)

- Outputs

3-way valve	AC230V N=Neutral Open, Close=direction (For circuit switching when connected to DHW tank)
Extra pump	AC230V (Used when Tank Unit pump capacity is insufficient)
Boiler contact / Defrost signal	Dry contact (System setup necessary)

- Thermistor inputs

Zone 1 room sensor	PAW-A2W-TSRT * It does not work when using the Optional PCB
--------------------	---

11.3.2.5 Connection of Optional PCB (CZ-NS4P)

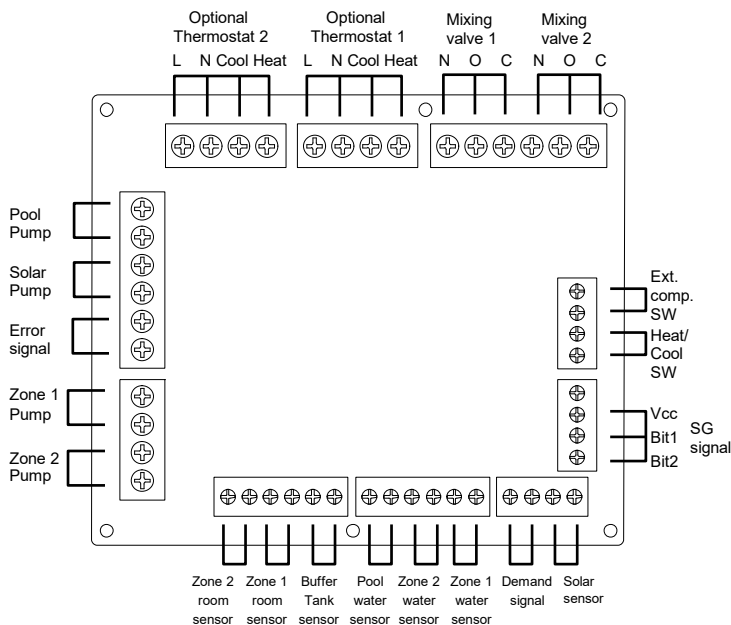

- Signal inputs

Optional Thermostat	L N =AC230V, Heat, Cool=Thermostat heat, Cool terminal
SG signal	Dry contact Vcc-Bit1, Vcc-Bit2 open/short (System setup necessary) Switching SW (Please connect to the 2 contacts controller)
External comp.SW	Dry contact Open=Comp.OFF, Short=Comp.ON (System setup necessary)

- Outputs

Mixing valve	AC230V N=Neutral Open, Close=mixture direction Operating time: 30s~120s
Pool pump	AC230V
Solar pump	AC230V
Zone pump	AC230V

- Thermistor inputs

Zone room sensor	PAW-A2W-TSRT
Buffer tank sensor	PAW-A2W-TSBU
Pool water sensor	PAW-A2W-TSHC
Zone water sensor	PAW-A2W-TSHC
Solar sensor	PAW-A2W-TSSO

11.3.2.6 Recommended External Device Specification

- This section explains about the external devices (optional) recommended by Panasonic. Please always ensure to use the correct external device during system installation.
- For optional sensor.

- 1 Buffer tank sensor: PAW-A2W-TSBU
Use for measurement of the buffer tank temperature.
Insert the sensor into the sensor pocket and paste it on the buffer tank surface.

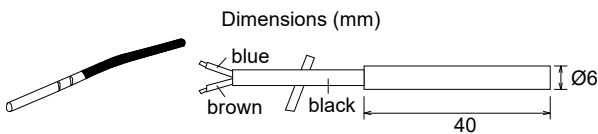

- 2 Zone water sensor: PAW-A2W-TSHC
Use to detect the water temperature of the control zone.
Mount it on the water piping by using the stainless steel metal strap and contact paste (both are included).

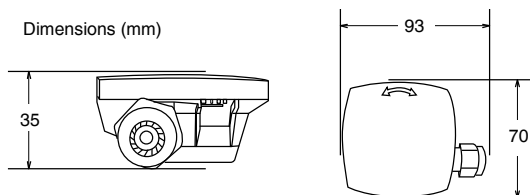

- 3 Room sensor: PAW-A2W- TSRT
Install the room temperature sensor to the room which requires room temperature control.

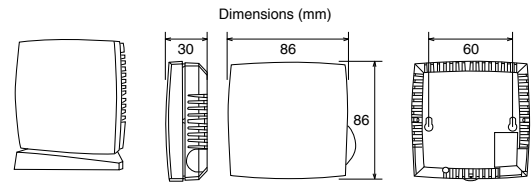

- 4 Solar sensor: PAW-A2W-TSSO
Use for measurement of the solar panel temperature.
Insert the sensor into the sensor pocket and paste it on the solar panel surface.

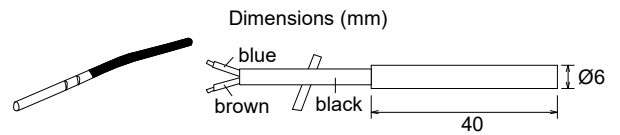

- 5 Please refer to the table below for sensor characteristic of the sensors mentioned above.

Temperature (°C)	Resistance (kΩ)	Temperature (°C)	Resistance (kΩ)
30	5.326	150	0.147
25	6.523	140	0.186
20	8.044	130	0.236
15	9.980	120	0.302
10	12.443	110	0.390
5	15.604	100	0.511
0	19.70	90	0.686
-5	25.05	80	0.932
-10	32.10	70	1.279
-15	41.45	65	1.504
-20	53.92	60	1.777
-25	70.53	55	2.106
-30	93.05	50	2.508
-35	124.24	45	3.003
-40	167.82	40	3.615
		35	4.375

- For optional pump.
Power supply: AC230V/50Hz, <500W
Recommended part: Yonos 25/6: made by Wilo

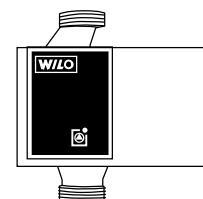

- For optional mixing valve.
Power supply: AC230V/50Hz (input open/output close)
Operating time: 30s~120s
Recommended part: 167032: made by Caleffi

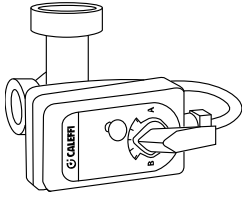

- Insert a flat head screwdriver into the slot on the top of the adaptor and remove the cover. Connect the other end of the CN-CNT cable to the connector inside the adaptor.

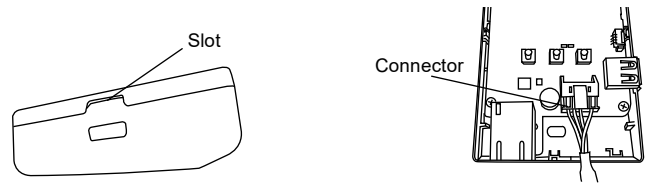

- On the wall near the Tank Unit, attach the adaptor by screwing screws through the holes in the back cover.

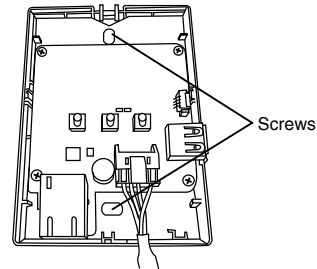

- Pull the CN-CNT cable through the hole in the bottom of the adaptor and re-attach the front cover to the back cover.

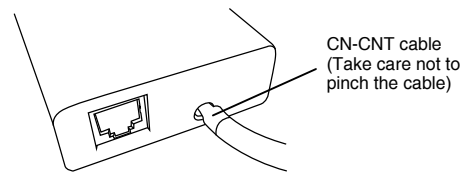

- Use the included cord clamp to fix the CN-CNT cable to the wall.

Pull the cable around as shown in the diagram so that external forces cannot act on the connector in the adaptor.

Furthermore, on the Tank Unit end, use the included cable tie to fix the cables together.

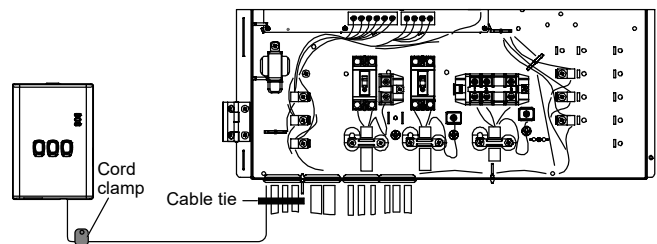

⚠ WARNING

This section is for authorized and licensed electrician/water system installer only. Work behind the front plate secured by screws must only be carried out under supervision of qualified contractor, installation engineer or service person.

11.3.2.7 Network Adaptor 5 Installation

- Remove the Control Board Cover ③, then connect the cable included with this adaptor to the CN-CNT connector on the printed circuit board.
 - Pull the cable out of the Tank Unit so that there is no pinching.
 - If an Optional PCB has been installed in the Tank Unit, connect to the CN-CNT connector of the Optional PCB.

Connection examples:

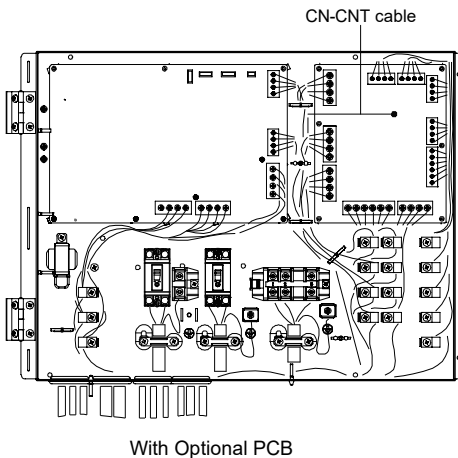
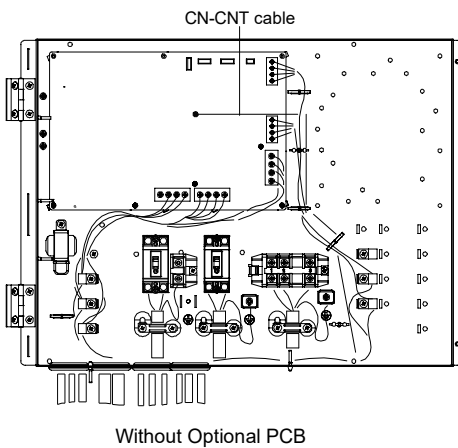

11.3.3 System Installation

11.3.3.1 Remote Controller Outline

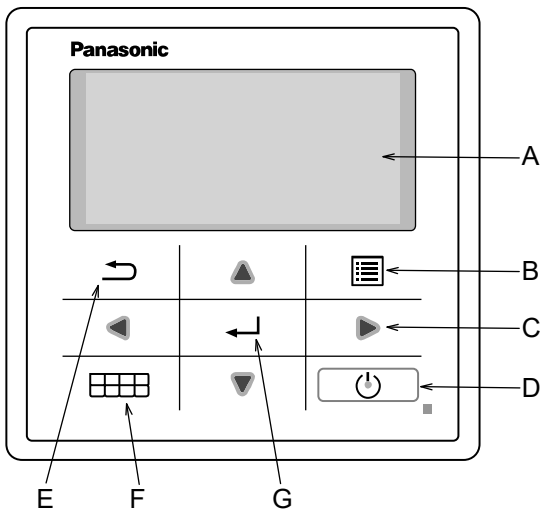

Name	Function
A: Main screen	Display information
B: Menu	Open/Close main menu
C: Triangle (Move)	Select or change item
D: Operate	Start/Stop operation
E: Back	Back to previous item
F: Quick Menu	Open/Close Quick menu
G: OK	Confirm

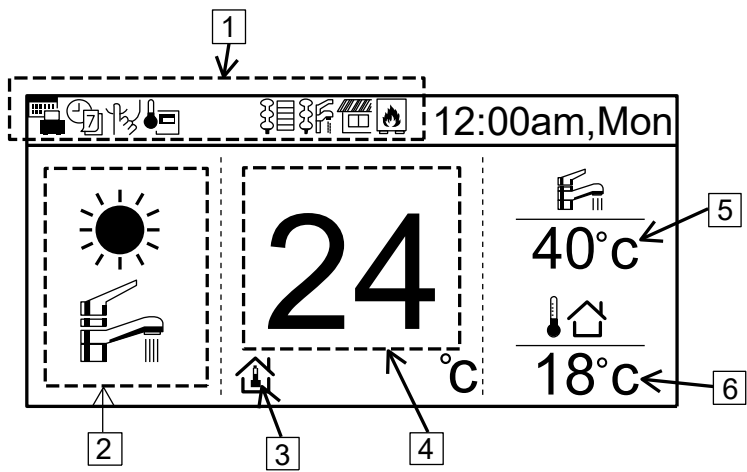

Name	Function
1: Function icon	Display set function/status
	Holiday mode
	Weekly timer
	Quiet mode
	Remote controller room thermostat
	Room heater
	Tank heater
	Solar
	Boiler
2: Mode	Display set mode/current status of mode
	Heating
	Heat pump operating
3: Temp setting	Set room temp
	Compensation curve
	Set direct water temp
	Set pool temp
4: Display Heat temp	Display current heating temperature (it is set temperature when enclosed by line)
5: Display tank temp	Display current tank temperature (it is set temperature when enclosed by line)
6: Outdoor temp	Display outdoor temp

First time of power ON (Start of installation)

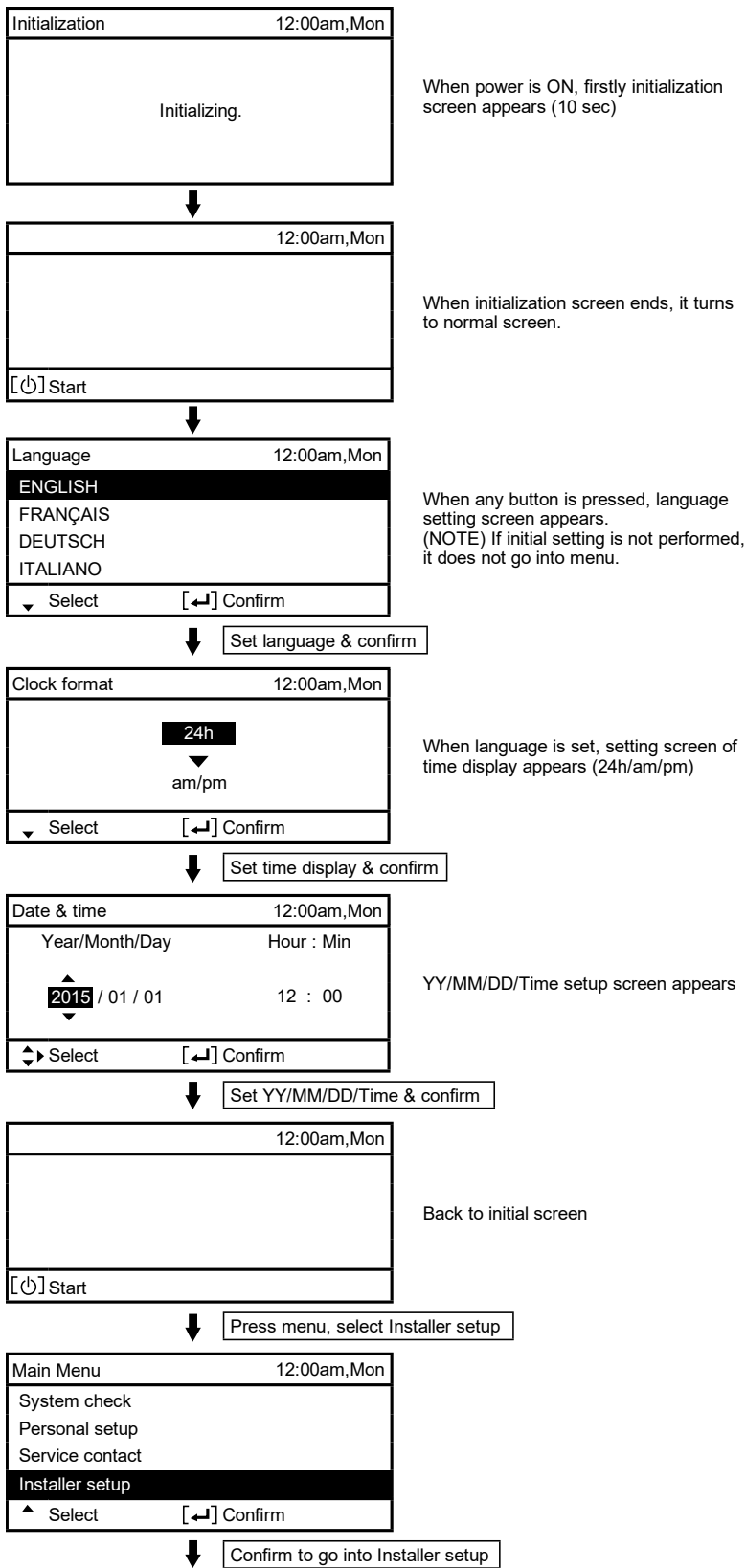

11.3.3.2 Installer Setup

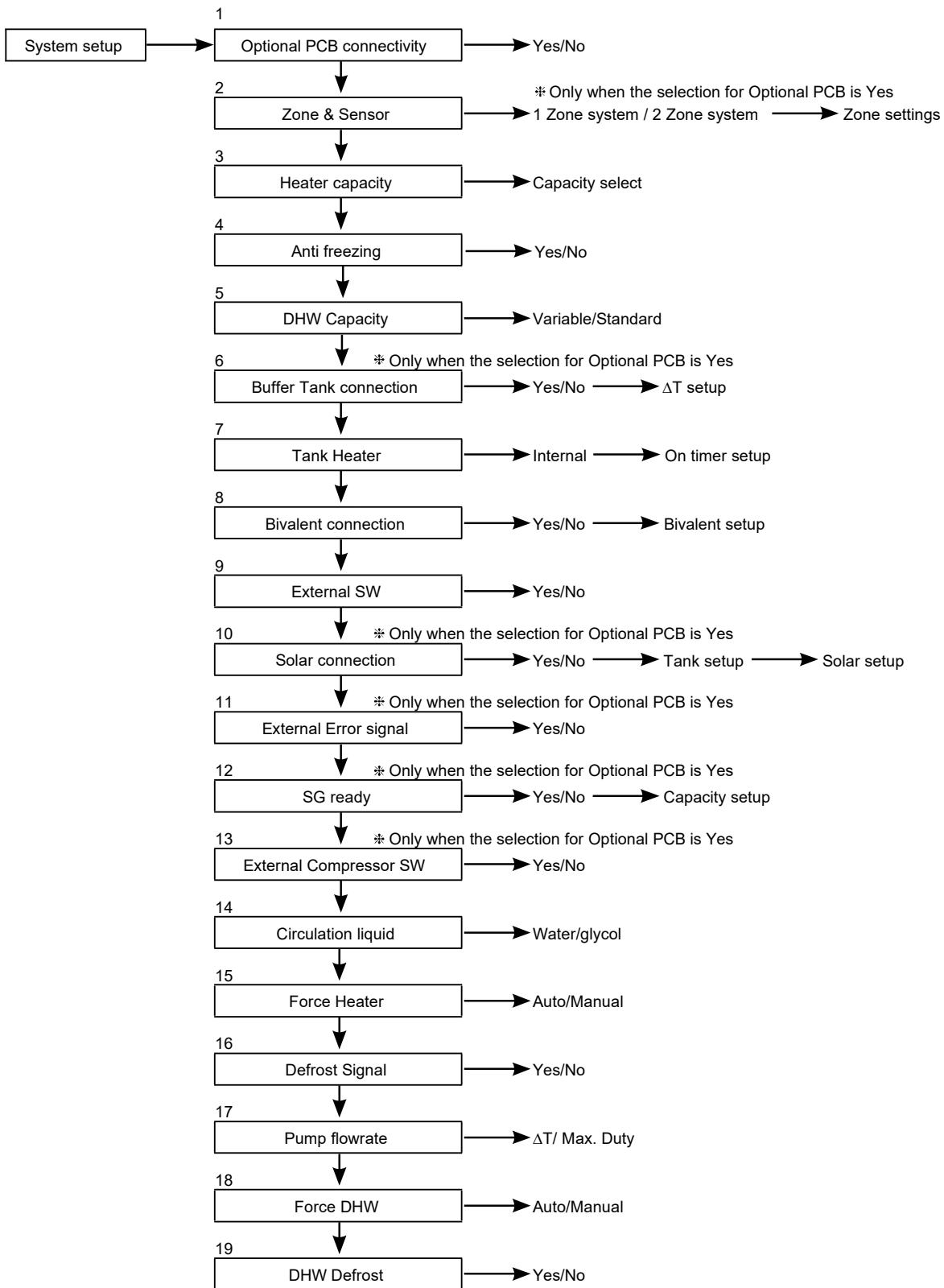

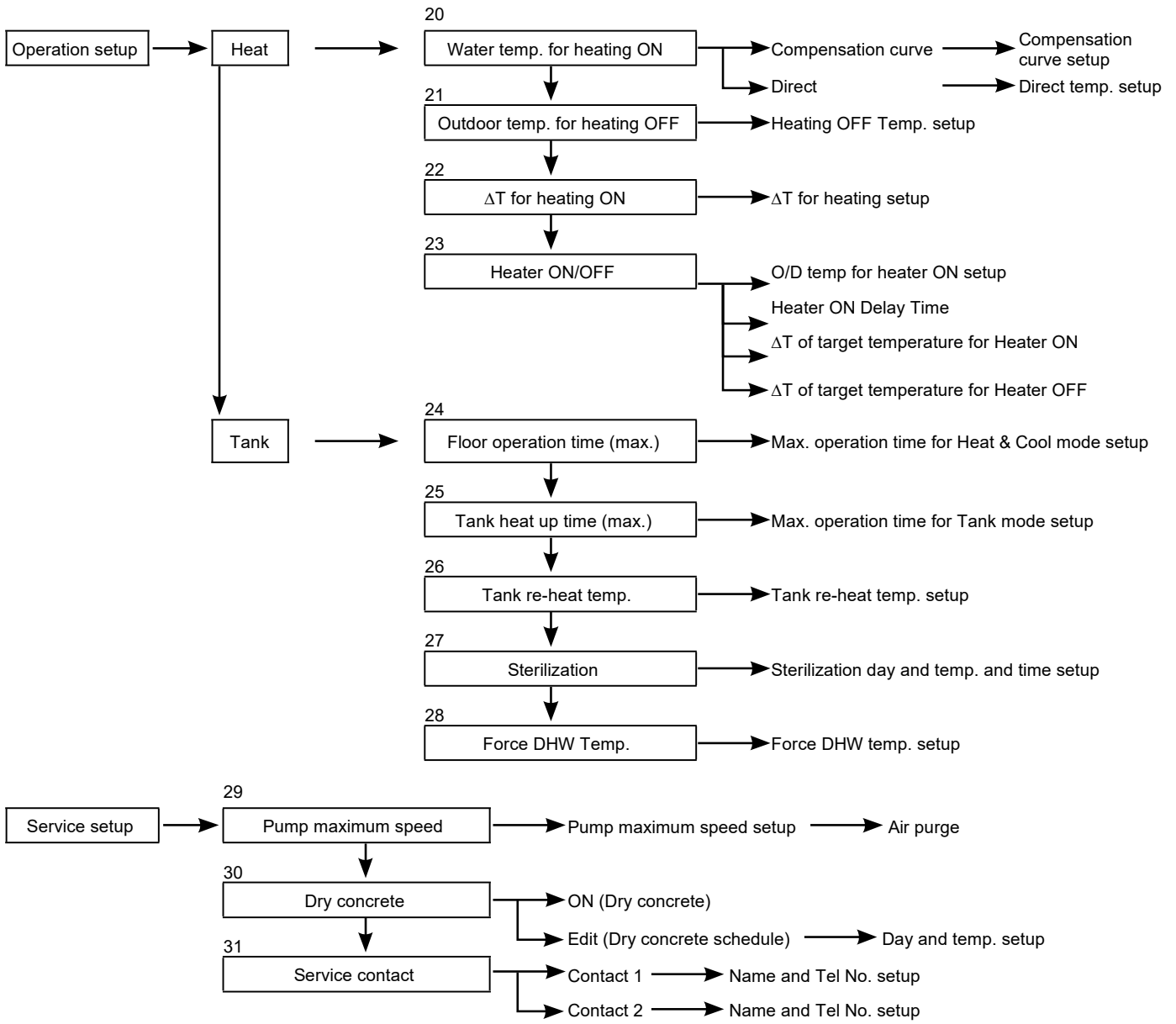

11.3.3.3 System Setup

<div style="border: 1px solid black; display: inline-block; padding: 2px 5px;">1. Optional PCB connectivity</div>	<div style="border: 1px solid black; display: inline-block; padding: 2px 5px;">Initial setting: No</div>	<table border="1" style="width: 100%; border-collapse: collapse;"> <tr> <td style="font-size: small;">System setup</td> <td style="text-align: right;">12:00am, Mon</td> </tr> <tr> <td colspan="2" style="background-color: #f0f0f0;">Optional PCB connectivity</td> </tr> <tr> <td colspan="2">Zone & Sensor</td> </tr> <tr> <td colspan="2">Heater capacity</td> </tr> <tr> <td colspan="2">Anti freezing</td> </tr> <tr> <td style="text-align: left;">▼ Select</td> <td style="text-align: right;">[↔] Confirm</td> </tr> </table>	System setup	12:00am, Mon	Optional PCB connectivity		Zone & Sensor		Heater capacity		Anti freezing		▼ Select	[↔] Confirm
System setup	12:00am, Mon													
Optional PCB connectivity														
Zone & Sensor														
Heater capacity														
Anti freezing														
▼ Select	[↔] Confirm													
<p>If function below is necessary, please purchase and install Optional PCB. Please select Yes after installing Optional PCB.</p> <ul style="list-style-type: none"> • 2-zone control • Pool • Buffer tank • Solar • External error signal output • Demand control • SG ready • Stop heat source unit by external SW 														

<div style="border: 1px solid black; display: inline-block; padding: 2px 5px;">2. Zone & Sensor</div>	<div style="border: 1px solid black; display: inline-block; padding: 2px 5px;">Initial setting: Room and Water temp.</div>	<table border="1" style="width: 100%; border-collapse: collapse;"> <tr> <td style="font-size: small;">System setup</td> <td style="text-align: right;">12:00am, Mon</td> </tr> <tr> <td colspan="2" style="background-color: #f0f0f0;">Optional PCB connectivity</td> </tr> <tr> <td colspan="2" style="background-color: #f0f0f0;">Zone & Sensor</td> </tr> <tr> <td colspan="2">Heater capacity</td> </tr> <tr> <td colspan="2">Anti freezing</td> </tr> <tr> <td style="text-align: left;">▲ Select</td> <td style="text-align: right;">[↔] Confirm</td> </tr> </table>	System setup	12:00am, Mon	Optional PCB connectivity		Zone & Sensor		Heater capacity		Anti freezing		▲ Select	[↔] Confirm
System setup	12:00am, Mon													
Optional PCB connectivity														
Zone & Sensor														
Heater capacity														
Anti freezing														
▲ Select	[↔] Confirm													
<p>If no Optional PCB connectivity Select sensor of room temperature control from the following 3 items</p> <ol style="list-style-type: none"> ① Water temperature (circulation water temperature) ② Room thermostat (Internal or External) ③ Room thermistor <p>When there is Optional PCB connectivity</p> <ol style="list-style-type: none"> ① Select either 1 zone control or 2 zone control. If it is 1 zone, select either room or pool, select sensor If it is 2 zone, after select sensor of zone 1, select either room or pool for zone 2, select sensor <p>(NOTE) In 2 zone system, pool function can be set at zone 2 only.</p>														

<div style="border: 1px solid black; display: inline-block; padding: 2px 5px;">3. Heater capacity</div>	<div style="border: 1px solid black; display: inline-block; padding: 2px 5px;">Initial setting: Depend on model</div>	<table border="1" style="width: 100%; border-collapse: collapse;"> <tr> <td style="font-size: small;">System setup</td> <td style="text-align: right;">12:00am, Mon</td> </tr> <tr> <td colspan="2" style="background-color: #f0f0f0;">Optional PCB connectivity</td> </tr> <tr> <td colspan="2" style="background-color: #f0f0f0;">Zone & Sensor</td> </tr> <tr> <td colspan="2" style="background-color: #f0f0f0;">Heater capacity</td> </tr> <tr> <td colspan="2">Anti freezing</td> </tr> <tr> <td style="text-align: left;">▲ Select</td> <td style="text-align: right;">[↔] Confirm</td> </tr> </table>	System setup	12:00am, Mon	Optional PCB connectivity		Zone & Sensor		Heater capacity		Anti freezing		▲ Select	[↔] Confirm
System setup	12:00am, Mon													
Optional PCB connectivity														
Zone & Sensor														
Heater capacity														
Anti freezing														
▲ Select	[↔] Confirm													
<p>If there is built-in Heater, set the selectable heater capacity.</p> <p>(NOTE) There are models which cannot select heater capacity.</p>														

<div style="border: 1px solid black; display: inline-block; padding: 2px 5px;">4. Anti freezing</div>	<div style="border: 1px solid black; display: inline-block; padding: 2px 5px;">Initial setting: Yes</div>	<table border="1" style="width: 100%; border-collapse: collapse;"> <tr> <td style="font-size: small;">System setup</td> <td style="text-align: right;">12:00am, Mon</td> </tr> <tr> <td colspan="2" style="background-color: #f0f0f0;">Optional PCB connectivity</td> </tr> <tr> <td colspan="2" style="background-color: #f0f0f0;">Zone & Sensor</td> </tr> <tr> <td colspan="2" style="background-color: #f0f0f0;">Heater capacity</td> </tr> <tr> <td colspan="2" style="background-color: #f0f0f0;">Anti freezing</td> </tr> <tr> <td style="text-align: left;">▲ Select</td> <td style="text-align: right;">[↔] Confirm</td> </tr> </table>	System setup	12:00am, Mon	Optional PCB connectivity		Zone & Sensor		Heater capacity		Anti freezing		▲ Select	[↔] Confirm
System setup	12:00am, Mon													
Optional PCB connectivity														
Zone & Sensor														
Heater capacity														
Anti freezing														
▲ Select	[↔] Confirm													
<p>Operate anti-freezing of water circulation circuit. If select Yes, when the water temperature is reaching its freezing temperature, the circulation pump will start up. If the water temperature does not reach the pump stop temperature, back-up heater will be activated.</p> <p>(NOTE) If set No, when the water temperature is reaching its freezing temperature or below 0°C, the water circulation circuit may freeze and cause malfunction.</p>														

<div style="border: 1px solid black; display: inline-block; padding: 2px 5px;">5. DHW Capacity</div>	<div style="border: 1px solid black; display: inline-block; padding: 2px 5px;">Initial setting: Variable</div>	<table border="1" style="width: 100%; border-collapse: collapse;"> <tr> <td style="font-size: small;">System setup</td> <td style="text-align: right;">12:00am, Mon</td> </tr> <tr> <td colspan="2" style="background-color: #f0f0f0;">Zone & Sensor</td> </tr> <tr> <td colspan="2" style="background-color: #f0f0f0;">Heater capacity</td> </tr> <tr> <td colspan="2" style="background-color: #f0f0f0;">Anti freezing</td> </tr> <tr> <td colspan="2" style="background-color: #f0f0f0;">DHW capacity</td> </tr> <tr> <td style="text-align: left;">▲ Select</td> <td style="text-align: right;">[↔] Confirm</td> </tr> </table>	System setup	12:00am, Mon	Zone & Sensor		Heater capacity		Anti freezing		DHW capacity		▲ Select	[↔] Confirm
System setup	12:00am, Mon													
Zone & Sensor														
Heater capacity														
Anti freezing														
DHW capacity														
▲ Select	[↔] Confirm													
<p>Variable DHW capacity setting normally run with efficient boiling which is energy saving heating. But while hot water usage high and tank water temperature low, variable DHW mode will run with fast heat up which heat up the tank with high heating capacity. If standard DHW capacity setting is selected, heat pump run with heating rated capacity at tank heat up operation.</p>														

6. Buffer Tank connection Initial setting: No

Select whether it is connected to buffer tank for heating or not.
If buffer tank is used, please set Yes.
Connect buffer tank thermistor and set, ΔT (ΔT use to increase primary side temp against secondary side target temp).
(NOTE) Does not display if there is no Optional PCB.
If the buffer tank capacity is not so large, please set larger value for ΔT .

System setup 12:00am, Mon
Heater capacity
Anti freezing
Tank connection
Buffer tank connection
Select [Confirm]

7. Tank heater Initial setting: Internal

Please set "Tank heater" to "ON" in the "Function setup" from remote controller when using heater to boil the tank.

Internal A setting which is using backup heater of Indoor Unit to boil the tank. The operation to boil the tank with heater is as below.
In addition, be sure to set suitable "Tank heater: ON time"

For 65°C setting

HP
Booster heater
Pump

* This value is an example and for reference only. Real value may differ.

System setup 12:00am, Mon
Anti freezing
Tank connection
Buffer tank connection
Tank heater
Select [Confirm]

8. Bivalent connection Initial setting: No

Set if heat pump linked with boiler operation.
Connect the start signal of the boiler in boiler contact terminal (main PCB).
Set Bivalent connection to YES.
After that, please begin setting according to remote controller instruction.
Boiler icon will be displayed on remote controller top screen.

After Bivalent connection Set YES, there is two option of control pattern to be select, (SG Ready / Auto)

1) SG ready (Only available to set when optional PCB set to YES)
- SG Ready input from optional PCB terminal control ON/OFF of boiler and heat pump as below condition

SG signal		Operation pattern
Vcc-bit1	Vcc-bit2	
Open	Open	Heat pump OFF, Boiler OFF
Short	Open	Heat pump ON, Boiler OFF
Open	Short	Heat pump OFF, Boiler ON
Short	Short	Heat pump ON, Boiler ON

* This bivalent SG ready input is sharing same terminal as [12. SG ready] connection. Only one of these two setting can be set at the same time.
When one is set, another setting will reset to not set.

2) Auto (If Optional PCB no Set, bivalent control pattern will set to this auto as default value)
There are 3 different modes in the boiler auto pattern operation. Movement of each modes are shown below.

- Alternative (switch to boiler operation when drops below setting temperature)
- Parallel (allow boiler operation when drops below setting temperature)
- Advanced Parallel (able to slightly delay boiler operation time of parallel operation)

When the boiler operation is "ON", "boiler contact" is "ON", " "(underscore) will be displayed below the boiler icon.
Please set target temperature of boiler to be the same as heat pump temperature.
When boiler temperature is higher than heat pump temperature, zone temperature cannot be achieved if mixing valve is not installed.
This product only allows one signal to control the boiler operation. Operation setting of boiler shall be responsible by installer.

System setup 12:00am, Mon
Tank connection
Buffer tank connection
Tank heater
Bivalent connection
Select [Confirm]

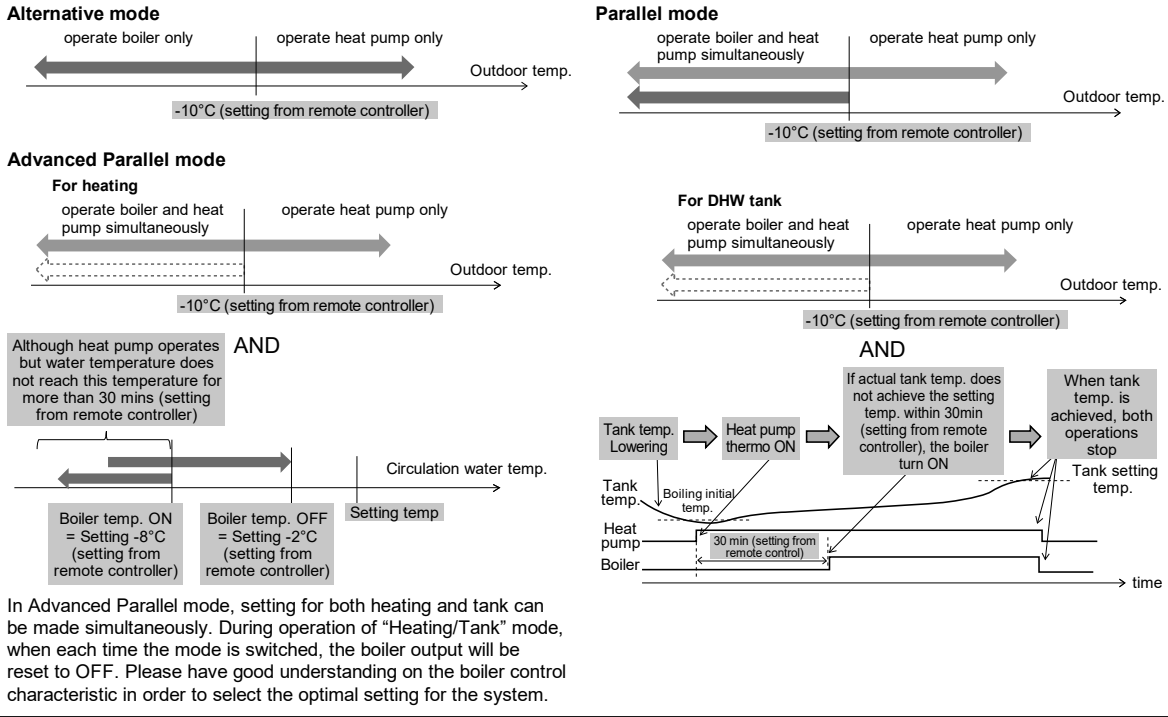

9. External SW Initial setting: No

Able to turn ON/OFF the operation by external switch.

System setup	12:00am, Mon
Buffer tank connection	
Tank heater	
Bivalent connection	
External SW	
▲ Select	[←→] Confirm

10. Solar connection Initial setting: No

Set when solar water heater is installed.

Setting include items below.

- Set either buffer tank or DHW tank for connection with solar water heater.
- Set temperature difference between solar panel thermistor and buffer tank or DHW tank thermistor to operate the solar pump.
- Set temperature difference between solar panel thermistor and buffer tank or DHW tank thermistor to stop the solar pump.
- Anti-freezing operation start temperature (please change setting based on usage of glycol.)
- Solar pump stop operation when it exceeds high limit temperature (when tank temperature exceed designated temperature (70~90°C))

System setup	12:00am, Mon
Tank heater	
Bivalent connection	
External SW	
Solar connection	
▲ Select	[←→] Confirm

11. External Error Signal Initial setting: No

Set when external error display unit is installed.
Turn on Dry Contact SW when error happened.

(NOTE) Does not display when there is no Optional PCB.
When error occurs, error signal will be ON.
After turn off "close" from the display, error signal will still remain ON.

System setup	12:00am, Mon
Bivalent connection	
External SW	
Solar connection	
External error signal	
▲ Select	[←→] Confirm

12. SG ready Initial setting: No

Switch operation of heat pump by open-short of 2 terminals.
Setting belows are possible

SG signal		Working pattern
Vcc-bit1	Vcc-bit2	
Open	Open	Normal
Short	Open	Heat pump and Heater OFF
Open	Short	Capacity 1
Short	Short	Capacity 2

Capacity setting 1

- DHW capacity ___%
- Heating capacity ___%
- Cooling capacity ___°C

Capacity setting 2

- DHW capacity ___%
- Heating capacity ___%
- Cooling capacity ___°C

} Set by SG ready setting of remote controller

(When SG ready set to YES, Bivalent control pattern will set to Auto.)

System setup 12:00am, Mon

External error signal

Demand control

SG ready

SG ready

⬆ Select [↵] Confirm

13. External Compressor SW Initial setting: No

Set when external compressor SW is connected.
SW is connected to external devices to control power consumption, Open Signal will stop compressor's operation. (Heating operation etc. are not cancelled).

(NOTE) Does not display if there is no Optional PCB.

If follow Swiss standard power connection, need to turn on DIP SW (SW2 pin3) of main unit PCB. Short/Open signal used to ON/OFF tank heater (for sterilization purpose)

System setup 12:00am, Mon

External error signal

Demand control

SG ready

External compressor SW

⬆ Select [↵] Confirm

14. Circulation Liquid Initial setting: Water

Set circulation of heating water.

There are 2 types of settings, water and glycol.

(NOTE) Please set glycol when using anti-freeze liquid.
It may cause error if setting is wrong.

System setup 12:00am, Mon

Demand control

SG ready

External compressor SW

Circulation liquid

⬆ Select [↵] Confirm

15. Force Heater Initial setting: Manual

Under manual mode, user can turn on force heater through quick menu.

If selection is 'auto', force heater mode will turn automatically if pop up error happen during operation.
Force heater will operate follow the latest mode selection, mode selection is disable under force heater operation.

Heater source will ON during force heater mode.

System setup 12:00am, Mon

External compressor SW

Circulation liquid

Heat-Cool SW

Force Heater

⬆ Select [↵] Confirm

16. Defrost signal Initial setting: No

Defrost signal sharing same terminal as bivalent contact in main board. When defrost signal set to YES, bivalent connection reset to NO. Only one function can be set between defrost signal and bivalent.

When defrost signal set to YES, during defrost operation is running at outdoor unit defrost signal contact turn ON. Defrost signal contact turn OFF after defrost operation end.
(Purpose of this contact output is to stop indoor fan coil or water pump during defrost operation).

System setup 12:00am, Mon

Heat-Cool SW

Force heater

Force defrost

Defrost signal

⬆ Select [↵] Confirm

17. Pump flowrate	Initial setting: ΔT	<table border="1" style="width: 100%; border-collapse: collapse;"> <tr> <td style="width: 70%;">System setup</td> <td style="width: 30%;">12:00am, Mon</td> </tr> <tr> <td>Force heater</td> <td></td> </tr> <tr> <td>Force defrost</td> <td></td> </tr> <tr> <td>Defrost signal</td> <td></td> </tr> <tr style="background-color: #f0f0f0;"> <td>Pump flowrate</td> <td></td> </tr> <tr> <td>▲ Select</td> <td>[←] Confirm</td> </tr> </table>	System setup	12:00am, Mon	Force heater		Force defrost		Defrost signal		Pump flowrate		▲ Select	[←] Confirm
System setup	12:00am, Mon													
Force heater														
Force defrost														
Defrost signal														
Pump flowrate														
▲ Select	[←] Confirm													

If pump flowrate setting is ΔT , unit adjust pump duty to get different of water inlet and outlet base on setting on * ΔT for heating ON and * ΔT for cooling ON in operation setup menu during room side operation.

If pump flowrate setting is set to Max. duty, unit will set the pump duty to the set duty at *Pump maximum speed in service setup menu during room side operation.

18. Force DHW	Initial setting: Manual	<table border="1" style="width: 100%; border-collapse: collapse;"> <tr> <td style="width: 70%;">System setup</td> <td style="width: 30%;">12:00am, Mon</td> </tr> <tr> <td>DHW capacity</td> <td></td> </tr> <tr> <td>Defrost signal</td> <td></td> </tr> <tr> <td>Pump flowrate</td> <td></td> </tr> <tr style="background-color: #f0f0f0;"> <td>Force DHW</td> <td></td> </tr> <tr> <td>▲ Select</td> <td>[←] Confirm</td> </tr> </table>	System setup	12:00am, Mon	DHW capacity		Defrost signal		Pump flowrate		Force DHW		▲ Select	[←] Confirm
System setup	12:00am, Mon													
DHW capacity														
Defrost signal														
Pump flowrate														
Force DHW														
▲ Select	[←] Confirm													

Force DHW mode is priority request to heat up tank from heat pump with tank only mode.

If selection is Manual, force DHW mode can be activate from quick menu force DHW icon.

If selection is Auto, force DHW mode will auto activated if tank temperature drop below the force DHW tank set temperature. (Please refer to operation setup->Tank for more information)

19. DHW Defrost	Initial setting: Yes	<table border="1" style="width: 100%; border-collapse: collapse;"> <tr> <td style="width: 70%;">System setup</td> <td style="width: 30%;">12:00am, Mon</td> </tr> <tr> <td>Defrost signal</td> <td></td> </tr> <tr> <td>Pump flowrate</td> <td></td> </tr> <tr> <td>Force DHW</td> <td></td> </tr> <tr style="background-color: #f0f0f0;"> <td>DHW Defrost</td> <td></td> </tr> <tr> <td>▲ Select</td> <td>[←] Confirm</td> </tr> </table>	System setup	12:00am, Mon	Defrost signal		Pump flowrate		Force DHW		DHW Defrost		▲ Select	[←] Confirm
System setup	12:00am, Mon													
Defrost signal														
Pump flowrate														
Force DHW														
DHW Defrost														
▲ Select	[←] Confirm													

If setting is YES, system can run defrost operation by using hot water while other room units in heat mode operation.

If setting is NO, system will not run defrost by using hot water.

11.3.3.4 Operation Setup

Heat

20. Water temp. for heating ON	Initial setting: compensation curve	<table border="1" style="width: 100%; border-collapse: collapse;"> <tr> <td style="width: 70%;">System setup</td> <td style="width: 30%;">12:00am, Mon</td> </tr> <tr> <td>Defrost signal</td> <td></td> </tr> <tr> <td>Pump flowrate</td> <td></td> </tr> <tr> <td>Force DHW</td> <td></td> </tr> <tr style="background-color: #f0f0f0;"> <td>DHW Defrost</td> <td></td> </tr> <tr> <td>▲ Select</td> <td>[←] Confirm</td> </tr> </table>	System setup	12:00am, Mon	Defrost signal		Pump flowrate		Force DHW		DHW Defrost		▲ Select	[←] Confirm
System setup	12:00am, Mon													
Defrost signal														
Pump flowrate														
Force DHW														
DHW Defrost														
▲ Select	[←] Confirm													

Set target water temperature to operate heating operation.
 Compensation curve: Target water temperature change in conjunction with outdoor ambient temperature change.
 Direct: Set direct circulation water temperature.

In 2 zone system, zone 1 and zone 2 water temperature can be set separately.

21. Outdoor temp. for heating OFF	Initial setting: 24°C	<table border="1" style="width: 100%; border-collapse: collapse;"> <tr> <td style="width: 70%;">System setup</td> <td style="width: 30%;">12:00am, Mon</td> </tr> <tr> <td>Defrost signal</td> <td></td> </tr> <tr> <td>Pump flowrate</td> <td></td> </tr> <tr> <td>Force DHW</td> <td></td> </tr> <tr style="background-color: #f0f0f0;"> <td>DHW Defrost</td> <td></td> </tr> <tr> <td>▲ Select</td> <td>[←] Confirm</td> </tr> </table>	System setup	12:00am, Mon	Defrost signal		Pump flowrate		Force DHW		DHW Defrost		▲ Select	[←] Confirm
System setup	12:00am, Mon													
Defrost signal														
Pump flowrate														
Force DHW														
DHW Defrost														
▲ Select	[←] Confirm													

Set outdoor temp to stop heating.
 Setting range is 5°C ~ 35°C

22. ΔT for heating ON	Initial setting: 5°C	<table border="1" style="width: 100%; border-collapse: collapse;"> <tr> <td style="width: 70%;">System setup</td> <td style="width: 30%;">12:00am, Mon</td> </tr> <tr> <td>Defrost signal</td> <td></td> </tr> <tr> <td>Pump flowrate</td> <td></td> </tr> <tr> <td>Force DHW</td> <td></td> </tr> <tr style="background-color: #f0f0f0;"> <td>DHW Defrost</td> <td></td> </tr> <tr> <td>▲ Select</td> <td>[←] Confirm</td> </tr> </table>	System setup	12:00am, Mon	Defrost signal		Pump flowrate		Force DHW		DHW Defrost		▲ Select	[←] Confirm
System setup	12:00am, Mon													
Defrost signal														
Pump flowrate														
Force DHW														
DHW Defrost														
▲ Select	[←] Confirm													

Set temp difference between out temp & return temp of circulating water of Heating operation.
 When temp gap is enlarged, it is energy saving but less comfort. When the gap gets smaller, energy saving effect gets worse but it is more comfortable.
 Setting range is 1°C ~ 15°C

23. Heater ON/OFF

a. Outdoor temp. for heater ON

Initial setting: 0°C

Set outdoor temp when back-up heater starts to operate.
Setting range is -20°C ~ 15°C

User shall set whether to use or not to use heater.

b. Heater ON delay time

Initial setting: 30 minutes

Set delay time from compressor ON for heater to turn ON if not achieve water set temperature.
Setting range is 10 minutes ~ 60 minutes

c. Heater ON: ΔTof target Temp

Initial setting: -4°C

Set water temperature for heater to turn on at heat mode.
Setting range is -10°C ~ -2°C

d. Heater OFF: ΔTof target Temp

Initial setting: -2°C

Set water temperature for heater to turn off at heat mode.
Setting range is -8°C ~ 0°C

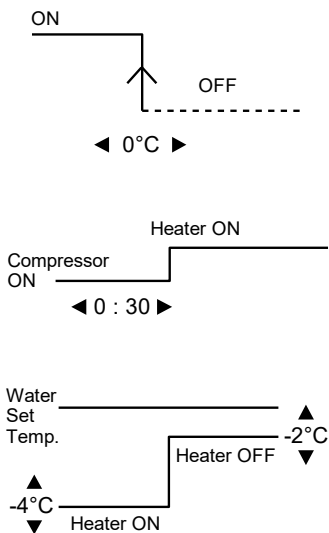

Tank

24. Floor operation time (max)

Initial setting: 8h

Set max operating hours of heating.
When max operation time is shortened, it can boil the tank more frequently.

It is a function for Heating + Tank operation.

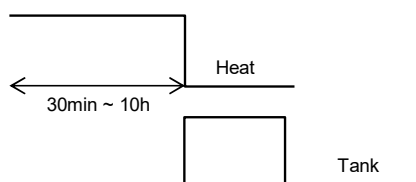

25. Tank heat up time (max)

Initial setting: 60min

Set max boiling hours of tank.
When max boiling hours are shortened, it immediately returns to Heating operation, but it may not fully boil the tank.

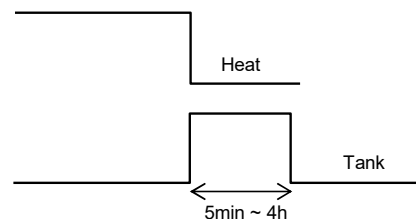

26. Tank re-heat temp.

Initial setting: -8°C

Set temp to perform reboil of tank water.
(When boiled by heat pump only, (51°C – Tank re-heat temp) shall become max temp.)

Setting range is -12°C ~ -2°C

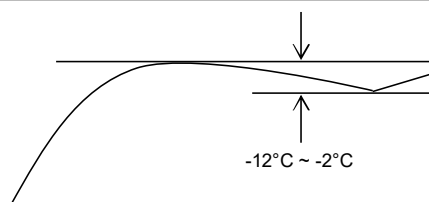

27. Sterilization Initial setting: 65°C 10min

Set timer to perform sterilization.

- ① Set operating day & time. (Weekly timer format)
- ② Sterilization temp (55~75°C ※ If use back-up heater, it is 65°C)
- ③ Operation time (Time to run sterilization when it reached setting temp 5min ~ 60min)

User shall set whether to use or not to use sterilization mode.

28. Force DHW Temp. Initial setting: 35°C

Set tank temperature to perform force DHW:
(When tank temperature drop below set point, will switch to tank only mode and have higher priority for heat pump to heat up tank water by temporarily stop room units operation.

Setting range is 25°C ~ 40°C

11.3.3.5 Service Setup

29. Pump maximum speed Initial setting: Depend on model

Normally setting is not necessary.
Please adjust when need to reduce the pump sound etc.
Besides that, it has Air Purge function.

When *Pump flow setting is Max. Duty, this duty set is the fix pump duty run during room side operation.

Service setup		12:00am, Mon
Flow rate	Max. Duty	Operation
88:8 L/min	0xCE	Air Purge
▲ Select		

30. Dry concrete

Operate concrete curing operation.
Select Edit, set temp for every stage (1~99 1 is for 1 day).
Setting range is 25~55°C

When it is turned ON, dry concrete starts.

When it is 2 zone, it dries both zones.

31. Service contact

Able to set name & tel no. of contact person when there is breakdown etc. or client has trouble. (2 items)

Service setup	12:00am, Mon	Contact-1: Bryan Adams
Service contact:		ABC/ abc 0-9/ Other
Contact 1		A B C D E F G H I J K L M N O P Q R
Contact 2		S T U V W X Y Z a b c d e f g h i
		j k l m n o p q r s t u v w x y z
▲ Select	[↵] Confirm	▼ Select [↵] Enter

11.4 Service and Maintenance

If forget Password and cannot operate remote controller

Press + + for 5 sec.
 Password unlock screen appears, press Confirm and it shall reset.
 Password will become 0000. Please reset it again.
 (NOTE) Only display when it is locked by password.

Maintenance menu

Setting method of Maintenance menu

Maintenance menu	12:00am, Mon
Actuator check	
Test mode	
Sensor setup	
Reset password	
▼ Select	[] Confirm

Press + + for 5 sec.

Items that can be set

- ① Actuator check (Manual ON/OFF all functional parts)
 (NOTE) As there is no protection action, please be careful not to cause any error when operating each part (do not turn on pump when there is no water etc.)
- ② Test mode (Test run)
 Normally it is not used.
- ③ Sensor setup (offset gap of detected temp of each sensor within -2~2°C range)
 (NOTE) Please use only when sensor is deviated. It affects temperature control.
- ④ Reset password (Reset password)

Custom menu

Setting method of Custom menu

Custom menu	12:00am, Mon
Back-up heater	
Reset energy monitor	
Reset operation history	
Smart DHW	
▼ Select	[] Confirm

Please press + + for 10 sec.

Items that can be set

- ① Backup heater (Use/Do not use Backup heater)
 (NOTE) It is different from to use/not to use backup heater set by client. When this setting is used, heater power on due to protection against frost will be disabled. (Please use this setting when it is required by utility company.)
 By using this setting, it cannot defrost due to low Heating's setting temp and operation may stop (H75)
 Please set under the responsibility of installer. When it stops frequently, it may be due to insufficient circulation flow rate, setting temp of heating is too low etc.
- ② Reset energy monitor (delete memory of Energy monitor)
 Please use when moving house and handover the unit.
- ③ Reset operation history (delete memory of operation history)
 Please use when moving house and handover the unit.
- ④ Smart DHW (Set Smart DHW mode Parameter)
 - a) Start time: Tank reboil at lower ON Temp. onward.
 - b) Stop time: Tank reboil at normal ON Temp. onward.
 - c) ON Temp.: Tank Reboil Temp when Smart DHW start.





12. Installation Instruction (S-71WF3E)

12.1 Indoor Unit Installation

12.1.1 General

This booklet briefly outlines where and how to install the air conditioning system. Please read over the entire set of instructions for the indoor and outdoor units and make sure all accessory parts listed are with the system before beginning.

The installation of pipe-work shall be kept to a minimum.









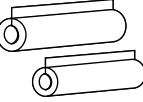

	WARNING	This symbol shows that this equipment uses a flammable refrigerant. If the refrigerant is leaked, together with an external ignition source, there is a possibility of ignition.
	CAUTION	This symbol shows that the Operating Instructions should be read carefully.
	CAUTION	This symbol shows that a service personnel should be handling this equipment with reference to the Technical Manual.
	CAUTION	This symbol shows that there is information included in the Operating Instructions and/or Installation Instructions.

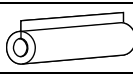

12.1.1.1 Tools Required for Installation (not supplied)

1. Flathead screwdriver
2. Phillips head screwdriver
3. Knife or wire stripper
4. Tape measure
5. Carpenter's level
6. Sabre saw or keyhole saw
7. Hacksaw
8. Core bits
9. Hammer
10. Drill
11. Tube cutter
12. Tube flaring tool
13. Torque wrench
14. Adjustable wrench
15. Reamer (for deburring)

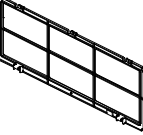
12.1.1.2 Accessories Supplied with Unit

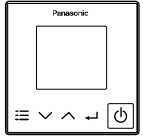
Table 1-1 (Middle Static Pressure Duct)

Part Name	Figure	Q'ty	Remarks
Washer		8	For suspending indoor unit from ceiling
Flare insulator		2	For gas and liquid tubes
Insulating tape		2	For gas and liquid tubes flare nuts
Drain insulator		1	For drain hose joint
Hose band		1	For securing drain hose
Packing		2	For drain hose joint (hard material)
Clamper		2	For drain hose joint
Drain hose		1	For main unit + PVC pipe joints
Clamper		2	For electrical wiring
Filter		2	When not connecting the air intake, be sure to install the filter.
Screw		2	
Wired Remote Controller CZ-RTC6LBW		1	

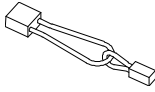
Part Name	Figure	Q'ty	Remarks
Operating Instructions		1	
Installation Instructions		1	
Short-circuit connection		1	For vertical installation (Located on the back of the electrical component box lid.)

- Use M10 for suspension bolts.
- Field supply for suspension bolts and nuts.

12.1.1.3 Type of Copper Tube and Insulation Material

If you wish to purchase these materials separately from a local source, you will need:

1. Deoxidized annealed copper tube for refrigerant tubing.
2. Foamed polyethylene insulation for copper tubes as required to precise length of tubing. Wall thickness of the insulation should be not less than 8 mm.
3. Use insulated copper wire for field wiring. Wire size varies with the total length of wiring. See the section "12.1.4. ELECTRICAL WIRING" for details.

CAUTION

Check local electrical codes and regulations before obtaining wire. Also, check any specified instructions or limitations.

12.1.1.4 Additional Materials Required for Installation

1. Refrigeration (armored) tape
2. Insulated staples or clamps for connecting wire (See your local codes.)
3. Putty
4. Refrigeration tubing lubricant
5. Clamps or saddles to secure refrigerant tubing
6. Scale for weighing

12.1.2 Selecting the Installation Site

12.1.2.1 Indoor Unit

AVOID:

- areas where leakage of flammable gas may be expected.
- places where large amounts of oil mist exist.
- direct sunlight.
- locations near heat sources which may affect the performance of the unit.
- locations where external air may enter the room directly. This may cause “condensation” on the air discharge ports, causing them to spray or drip water.
- locations where the remote controller will be splashed with water or affected by dampness or humidity.
- installing the remote controller behind curtains or furniture.
- locations where high-frequency emissions are generated.

DO:

- select an appropriate position from which every corner of the room can be uniformly cooled.
- select a location where the ceiling is strong enough to support the weight of the unit.
- make sure to install protective guards on the suction and discharge side to prevent somebody from touching the fan blades or heat exchanger.
- select a location where tubing and drain pipe have the shortest run to the outdoor unit.
- allow room for operation and maintenance as well as unrestricted air flow around the unit.
- the limitation of the tubing length between the indoor and the outdoor units should be referred to the Installation Instructions of the outdoor unit.
- allow room for mounting the remote controller about 1m off the floor, in an area that is not in direct sunlight or in the flow of cool air from the indoor unit.

< Horizontal installation >

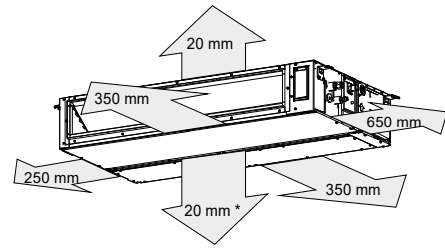

- * It is necessary to make space for the cleaning as well as the maintenance of the drain pan and the heat exchanger. Do not put any obstacle not to cause obstructing maintenance or cleaning works. If the place where the ceiling material cannot be removed, make an opening section below the bottom surface of the indoor unit in order to take it out. If it is impossible to provide an opening, make space more than 300 mm between the indoor unit's bottom surface and the ceiling material.

< Vertical installation >

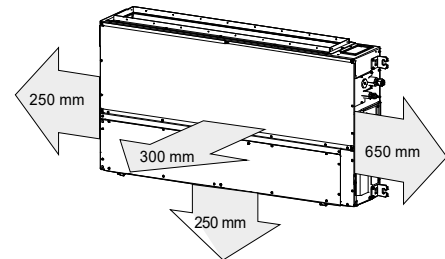

12.1.3 How to Install the Indoor Unit

■ Middle Static Pressure Duct Type (Type F3)

12.1.3.1 Required Minimum Space for Installation and Maintenance Services

< Horizontal installation >

- This air conditioner is usually installed above the ceiling so that the indoor unit and ducts are not visible. Only the air intake and air outlet ports are visible from below.
- The minimum space for installation and maintenance services is shown in the figure.

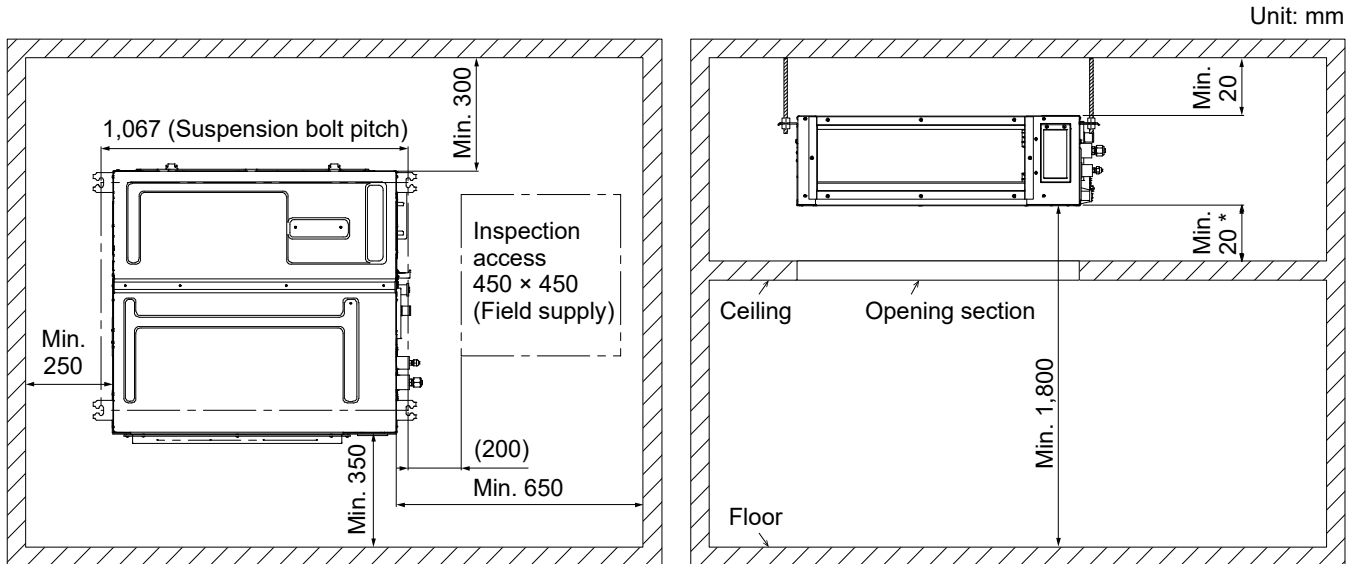

Minimum space for installation and maintenance services

* It is necessary to make space for the cleaning as well as the maintenance of the drain pan and the heat exchanger.

Do not put any obstacle not to cause obstructing maintenance or cleaning works.

If the place where the ceiling material cannot be removed, make an opening section below the bottom surface of the indoor unit in order to take it out.

If it is impossible to provide an opening, make space more than 300 mm between the indoor unit's bottom surface and the ceiling material.

< Vertical installation >

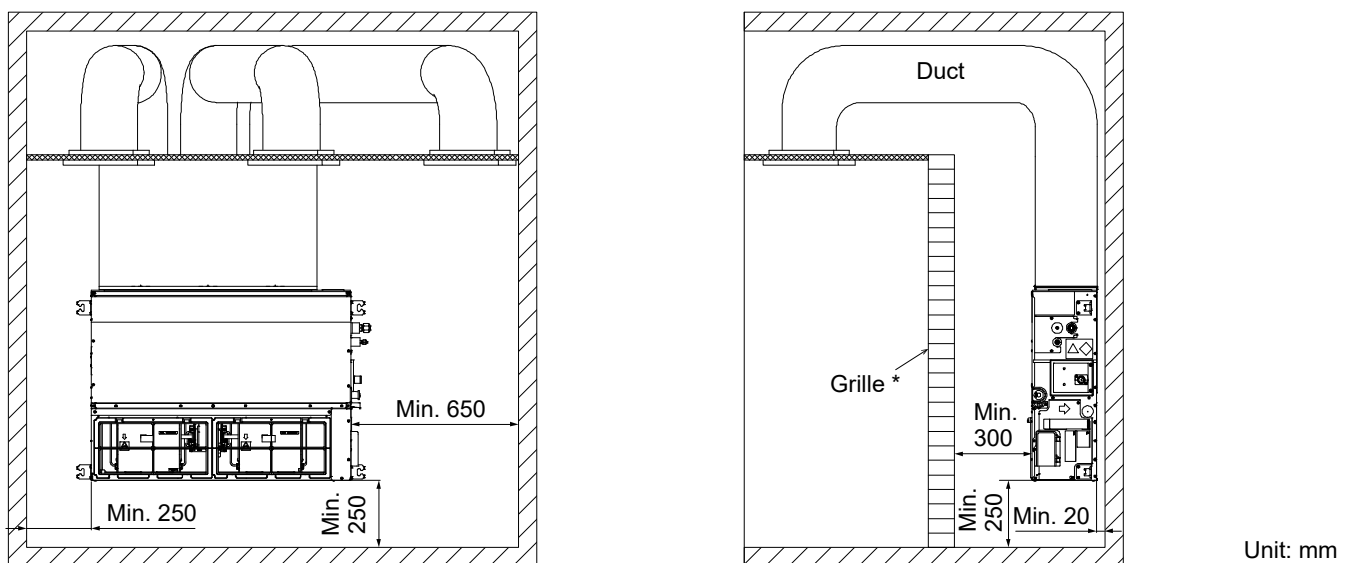

* Make it possible to open / close for maintenance services.

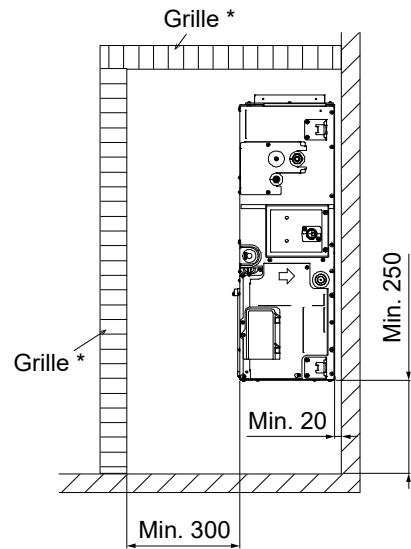
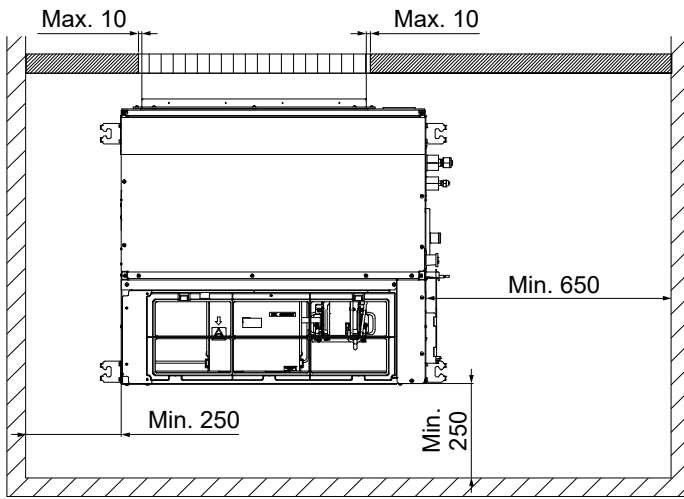

Unit: mm

* Make it possible to open / close for maintenance services.

- It is recommended that space be provided (450 × 450 mm) for checking and servicing the electrical system.

Detailed dimensions of indoor unit

Unit: mm

Type	A	B	C	D	E	F
71	1,067	1,000	750 (Pitch 150 × 5)	21	792	16

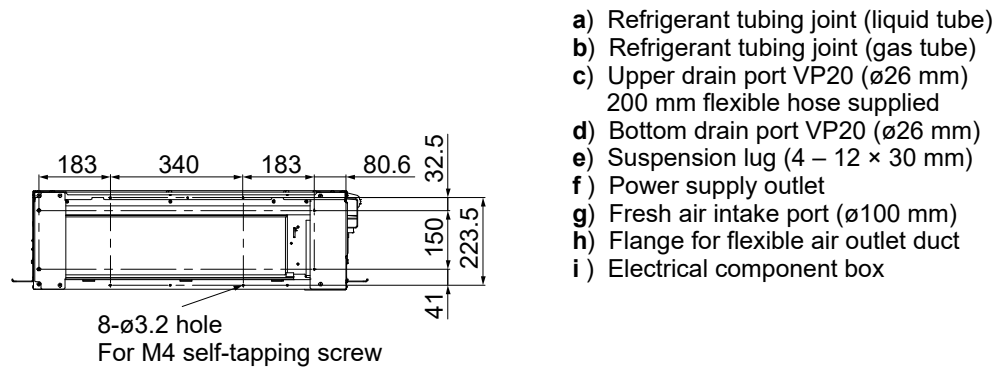

- a) Refrigerant tubing joint (liquid tube)
- b) Refrigerant tubing joint (gas tube)
- c) Upper drain port VP20 (ø26 mm) 200 mm flexible hose supplied
- d) Bottom drain port VP20 (ø26 mm)
- e) Suspension lug (4 – 12 × 30 mm)
- f) Power supply outlet
- g) Fresh air intake port (ø100 mm)
- h) Flange for flexible air outlet duct
- i) Electrical component box

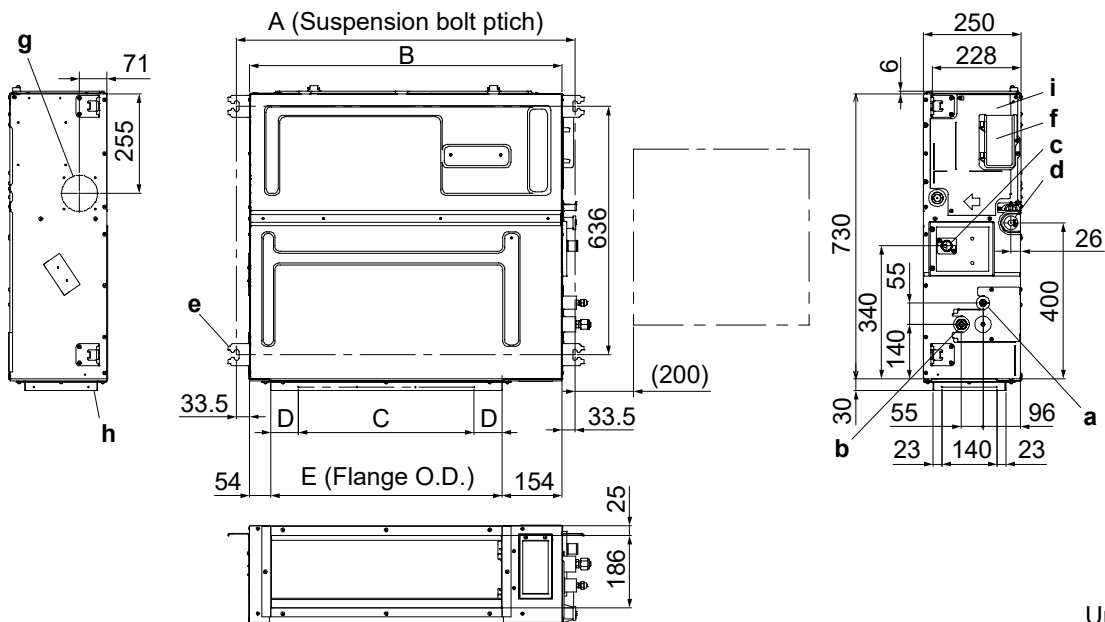

Unit: mm

12.1.3.2 Preparation Before Installation

12.1.3.2.1 Main Types of Installation

Case A (Standard installation)

Horizontal installation in the ceiling, rear side air intake

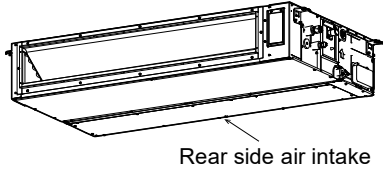

Case B

Horizontal installation in the ceiling, lower side air intake

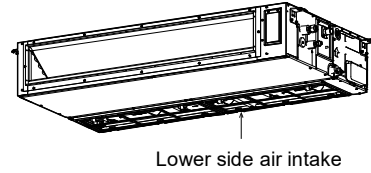

Case C

Vertical installation on the sidewall, lower side air intake

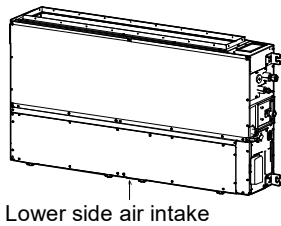

Case D

Vertical installation on the sidewall, front side air intake

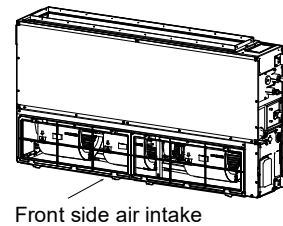

* While in heating mode, the temperatures may increase higher than the set temperature.

* While in heating mode, the temperatures may increase higher than the set temperature.

12.1.3.2.2 Install the Filter

When not connecting the air intake duct, be sure to install the filters (Accessories). Case A and Case C are shown below.

Type 71

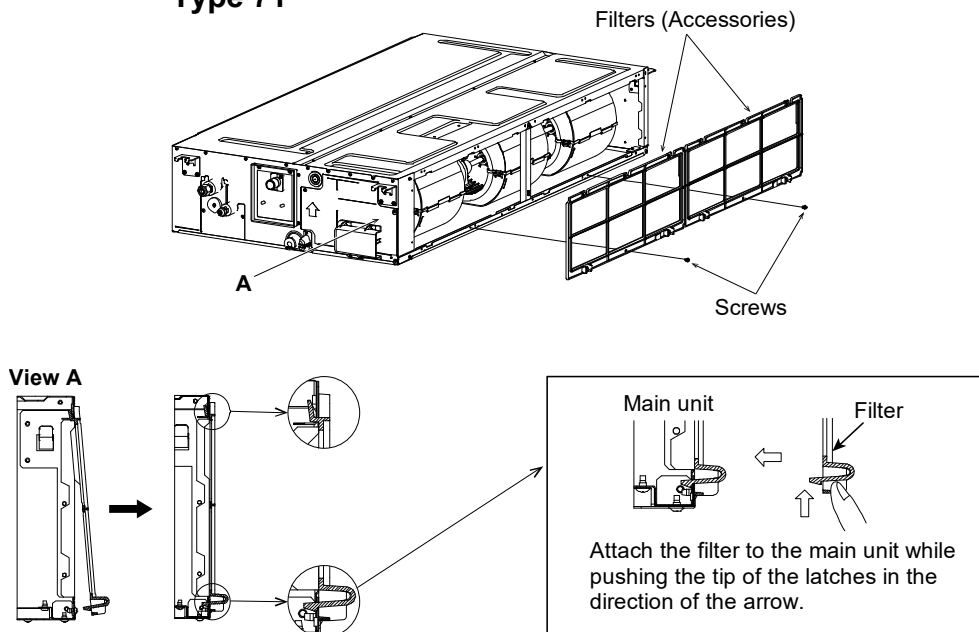

Attach the filters (accessories) in the manner shown in the figure. Securely fix the filters with the screws.

Case B and Case D are shown below.

For Case B, replace the cover plates in the procedure shown in the figure.

Type 71

1. Remove the cover plate.

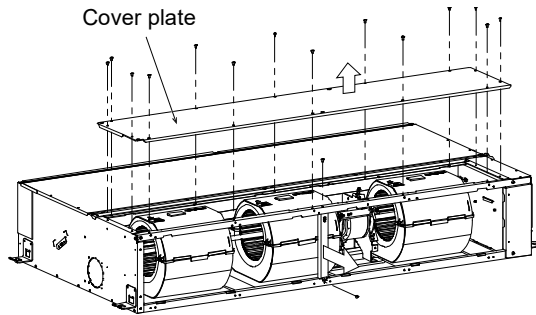

2. Attach the cover plate and the support plate removed in step 1 and filters (accessories) in the direction shown in the figure below.

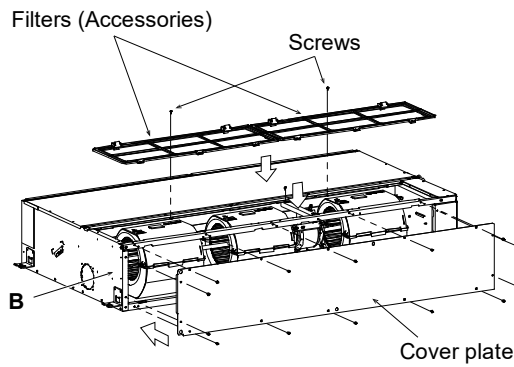

3. Attach the filters (accessories) in the manner shown in the figure. Securely fix the filters with the screws.

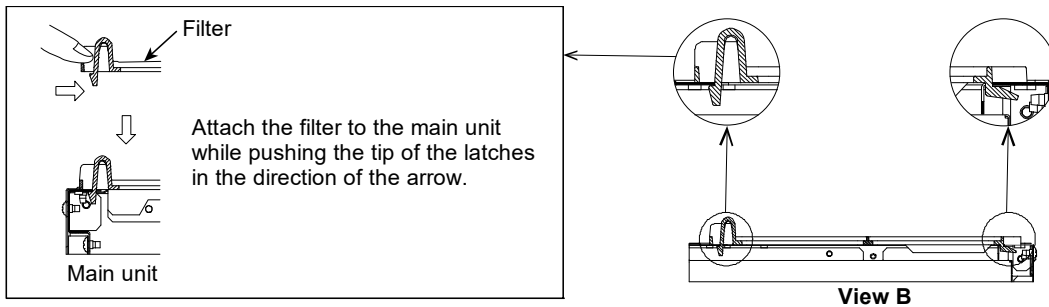

12.1.3.3 Fix the Indoor Unit

12.1.3.3.1 Horizontal Installation

Depending on the ceiling type:

- a) Insert suspension bolts
- or
- b) Use existing ceiling supports or construct a suitable support.

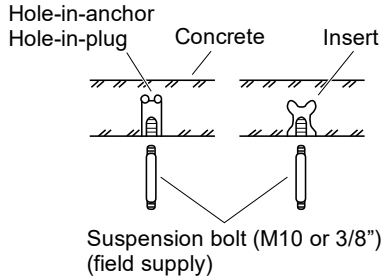

a)

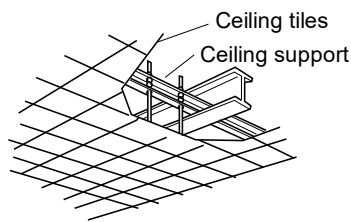

b)

! WARNING

It is important that you use extreme care in supporting the indoor unit inside the ceiling. Ensure that the ceiling is strong enough to support the weight of the unit. Before hanging the unit, test the strength of each attached suspension bolt.

- (1) When placing the unit inside the ceiling, determine the pitch of the suspension bolts referring to the dimensional data as shown in the tables and diagrams under the section 12.1.3.1. Tubing must be laid and connected inside the ceiling when suspending the unit. If the ceiling is already constructed, lay the tubing into position for connection to the unit before placing the unit inside the ceiling.
- (2) Screw in the suspension bolts allowing them to protrude from the ceiling. (Cut the ceiling material, if necessary.)

- (3) Thread the 3 hexagonal nuts and 2 washers (field supply) onto each of the 4 suspension bolts. Use 1 nut and 1 washer for the upper part, and 2 nuts and 1 washer for the lower part, so that the unit will not fall off the suspension lugs.

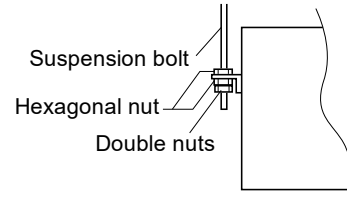
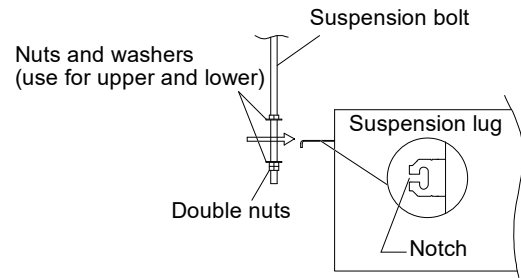

- This shows an example of installation.

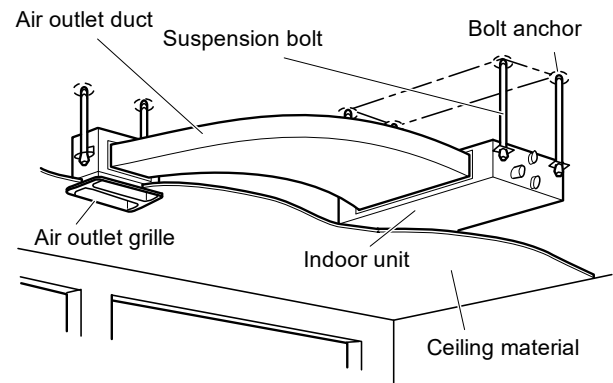

12.1.3.3.2 Vertical Installation

- To prevent overturning, fasten the unit to the wall securely.
- Check to make sure the wall can endure 5 times of weight of the unit. Ensure to fix the unit.
- In order to suppress vibrations, provide the spacer between the unit and the wall.
- Fasten the hanging brackets and bolts using by the hexagon nuts and washers.
- Check to make sure the unit is installed in a horizontal position by using a level.
Water leakage may occur if the unit is not installed horizontally.

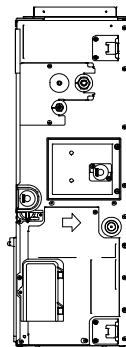
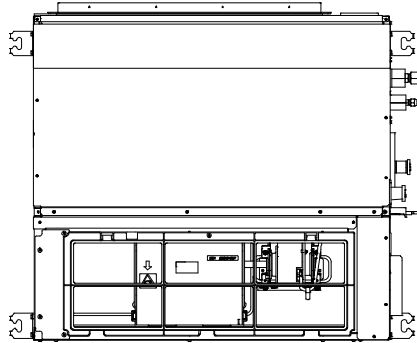

12.1.3.4 Installing the Drain Pipe

- Prepare standard hard PVC pipe (O.D. 26 mm) for the drain and use the supplied hose band to prevent water leaks. The PVC pipe must be purchased separately. The transparent drain part on the unit allows you to check drainage.

⚠ CAUTION

- Do not use adhesive tape at the drain connection port on the indoor unit.
- Insert the drain pipe until it contacts the socket, and then secure it tightly with the hose band.
- Do not use the supplied drain hose bent at a 90° angle. (The maximum permissible bend is 45°.)
- Tighten the hose clamps so their locking nuts face upward.

(2) Installing the drain hose

- First insert the drain hose (supplied) to the hose band (supplied) and then install the drain hose to the unit drain port.
- Insert until the drain hose bumps to the end.
- Hose band screw torque is 30 - 35 N · cm.
- Connect both the drain hose and PVC pipe (VP20 or similar material, not supplied). Insert until the PVC pipe bumps to the end and adhere with PVC adhesive.

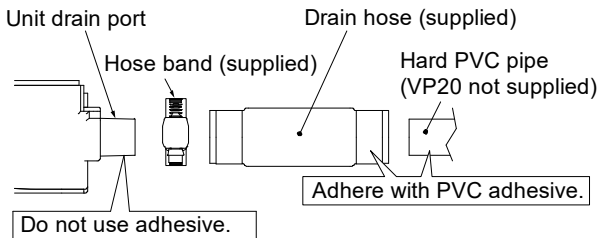

- After connecting the drain pipe securely, wrap the supplied packing and drain pipe insulator around the pipe, then secure it with the clampers.

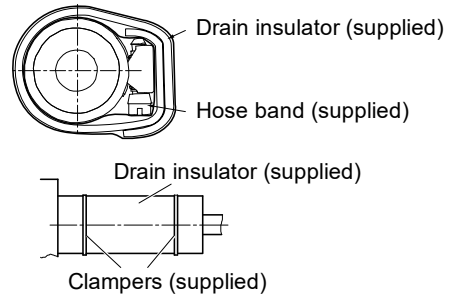
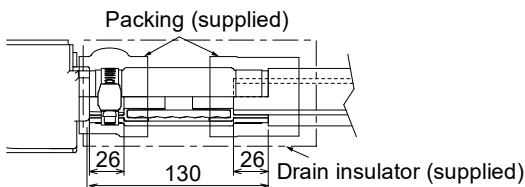

12.1.3.4.1 Horizontal Installation

NOTE

Make sure the drain pipe has a downward gradient (1/100 or more) and that there are no water traps.

⚠ CAUTION

- Do not install an air bleeder as this may cause water to spray from the drain pipe outlet.

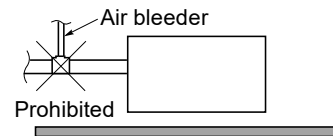

- If it is necessary to increase the height of the drain pipe, the section directly after the connection port can be raised a maximum of 500 mm. Do not raise it any higher than 500 mm, as this could result in water leaks.

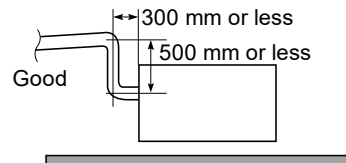

- Do not install the pipe with an upward gradient from the connection port. This will cause the drain water to flow backward and leak when the unit is not operating.

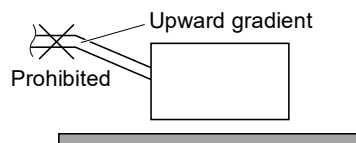

- Do not apply force to the piping on the unit side when connecting the drain pipe. The pipe should not be allowed to hang unsupported from its connection to the unit. Fasten the pipe to a wall, frame, or other support as close to the unit as possible.

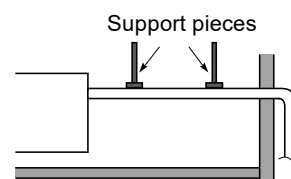

12.1.3.4.2 Vertical Installation

- Replace the drain cap

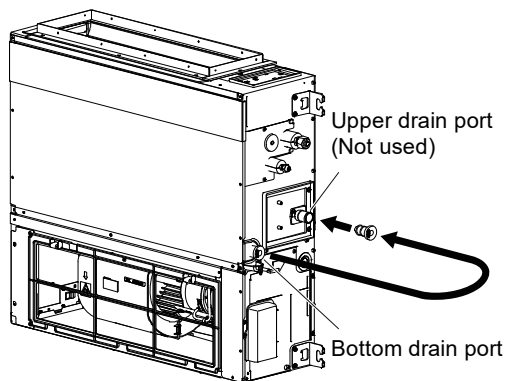

The drain cap can be inserted easily by using a screwdriver or similar tool to push the drain cap into the drain port on the main unit. Push the drain cap into the main unit's drain port until it reaches the end-stop.

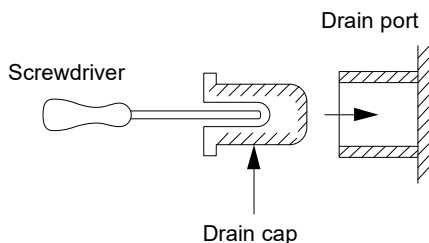

- Replace the connectors

When installing the unit vertically, disconnect the connectors of the drain pump (3-pin) and the float switch (2-pin) from the PCB.

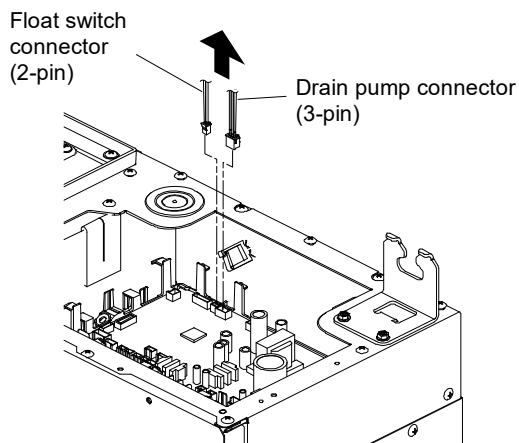

Insert the supplied short-circuit connection to the place where the connectors were removed.

Short-circuit connection (Accessories)

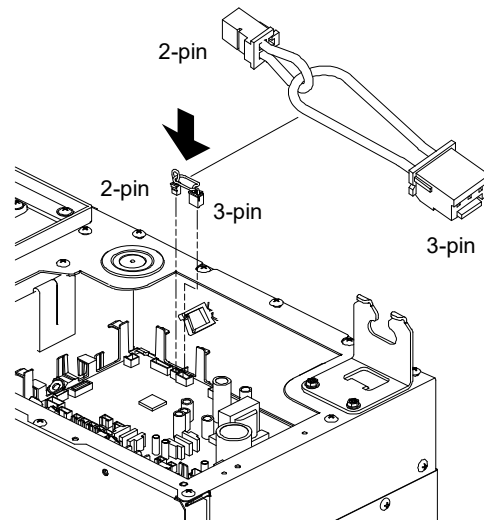

- * Pay attention to the type of connector.
- After switching on the power, invalidate the drain pump and change the heating intake temperature by setting the remote controller. (For details, see next page.)

How to make drain pump ineffective and changing heating intake temperature

Operating the High-spec Wired Remote Controller (CZ-RTC5B)

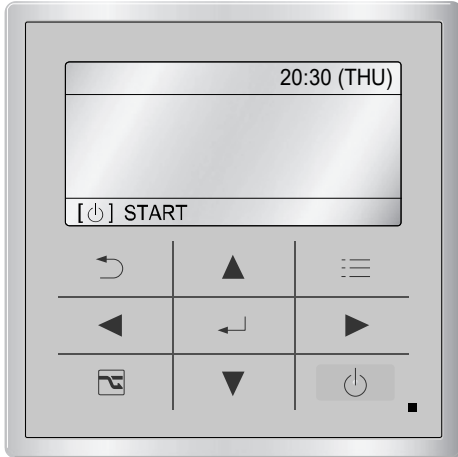

After completing the address setting under the Section "12.1.8. TEST RUN", carry out the following procedure.

1. Keep pressing the , and buttons simultaneously for 4 or more seconds. The "Maintenance func" screen appears on the LCD display.

Maintenance func	20:30 (THU)
1. Outdoor unit error data	
2. Service contact	
3. RC setting mode	
4. Test run	
◀ Sel. ▶ Page [↵] Confirm	

2. Press the or button to see each menu. If you wish to see the next screen instantly, press the or button. Select "8. Detailed settings" on the LCD display and press the button.

Maintenance func	20:30 (THU)
5. Sensor info.	
6. Servicing check	
7. Simple settings	
8. Detailed settings	
◀ Sel. ▶ Page [↵] Confirm	

The "Detailed settings" screen appears on the LCD display.

Select the "Unit no." by pressing the or button for changes.

Detailed settings		20:30 (THU)
Unit no.	Code no.	Set data
1-1	10	0005
◀ Sel. ▶ Next		

3. Select the "Code no." by pressing the or button.
Change the "Code no." to "3F" by pressing the or button (or keeping it pressed).

Detailed settings		20:30 (THU)
Unit no.	Code no.	Set data
1-1	3F	0007
◀ Sel. ▶ Next		

4. Select the "Set data" by pressing the or button.
("0007" or "0000" set at shipment)
Change the Setting Data "0001" by pressing the or button. Then press the button.

5. Select the "Code no." by pressing the or button.
Change the "Code no." to "06" by pressing the or button (or keeping it pressed).

Detailed settings		20:30 (THU)
Unit no.	Code no.	Set data
1-1	06	0004
◀ Sel. ▶ Next		















6. Select the "Set data" by pressing the or button.
("0004" set at shipment)
Change the Setting Data "0000" by pressing the or button. Then press the button.

7. Select the "Unit no." by pressing the or button and press the button.
The "Exit detailed settings and restart?" (Detailed setting-end) screen appears on the LCD display.
Select "YES" and press the button.

Exit detailed settings and restart?	
YES	NO

Operating the Timer Remote Controller (CZ-RTC4)

Setting Item Code “3F” and “06”

1. Press and hold down the ,  and  buttons simultaneously for 4 or more seconds.
(**SETTING**, the unit no., item code and detailed data will blink on the LCD display.)
2. The indoor unit numbers in the group control will be sequentially displayed whenever the Unit Select button is pressed .
Only the fan motor for the selected indoor unit will operate during this time.
3. Specify the “3F” item code by pressing the  /  buttons for the temperature setting buttons and confirm the values.
(“0007” or “0000” set at shipment)
4. Press the  /  buttons for the time to amend the values for the set data.
Select “0001”.
5. Press the  button.
The display will stop blinking and remain illuminated.
6. Specify the “06” item code by pressing the  /  buttons for the temperature setting buttons and confirm the values.
(“0004” set at shipment)
7. Press the  /  buttons for the time to amend the values for the set data.
Select “0000”.
8. Press the  button.
The display will stop blinking and remain illuminated.
9. Press the  button to return to normal remote controller display.

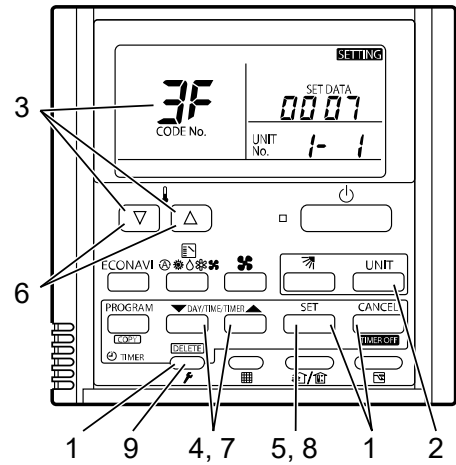

*Failure to make this setting may cause malfunction of the drain pump.

NOTE

Make sure the drain pipe has a downward gradient (1/100 or more) and that there are no water traps.

⚠ CAUTION

- Do not install an air bleeder as this may cause water to spray from the drain pipe outlet.

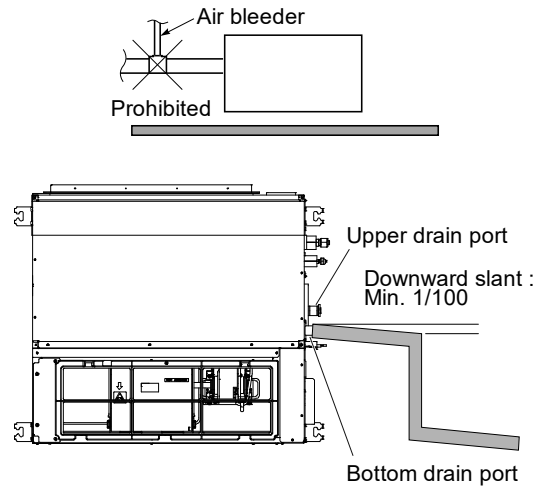

(1) Drain hose connection

- The drain hose is connected below the refrigerant tubing.

⚠ CAUTION

- **Wrap the drain insulator (supplied) between the connection of the drain hose and tubing not to expose the copper tubing.**
Also, wrap the hose band together. Wrap the hose band with the drain insulator, where the screw is located facing upward. Then, tighten the insulator with a vinyl tape not to cause the detachment.
If the tubing parts remain exposed, condensation may occur.
- **Be sure to use the supplied drain hose.**
- **If other commercially available hose bands are used, the drain hose may become pinched or wrinkled and there is danger of water leakage. Therefore be sure to use the supplied hose bands.**
- **Connect the drain pipe so that it slopes downward from the unit to the outside.**
- **Never allow water traps to occur in the course of the piping.**
- **Insulate any piping inside the room to prevent dripping.**
- **After the drain piping, pour an appropriate amount of water into the drain pan through the opening on the side of the air discharge port. Check the water draining smoothly.**

12.1.3.5 Checking the Drainage

12.1.3.5.1 Horizontal Installation Only

After wiring and drain piping are completed, use the following procedure to check that the water will drain smoothly. For this, prepare a bucket and wiping cloth to catch and wipe up spilled water.

- (1) Connect power to the power terminal board (L/1, N/2 terminals) inside the electrical component box.
- (2) Remove the tube cover and slowly pour about 1,200 cc of water through the opening into the drain pan to check drainage.
- (3) Short the check pin (CHK) (6P : 1-4) on the indoor unit control PCB and operate the drain pump. Check the water flow through the transparent upper drain port and see if there is any leakage.
* If the check pin (CHK) (6P : 1-4) is shorted, the fan starts rotating at high speed and could cause injury.
- (4) When the drainage check is complete, open the check pin (CHK) (6P : 1-4) and remount the insulator and the cap onto the drain inspection port.

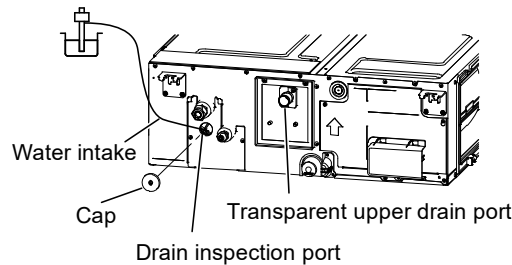

12.1.3.6 Connecting Duct to Air Intake Port Side

- (1) Install the duct (field supply).
See the figure for the dimension of the installation hole.
Use M4 self-tapping screws for installation.

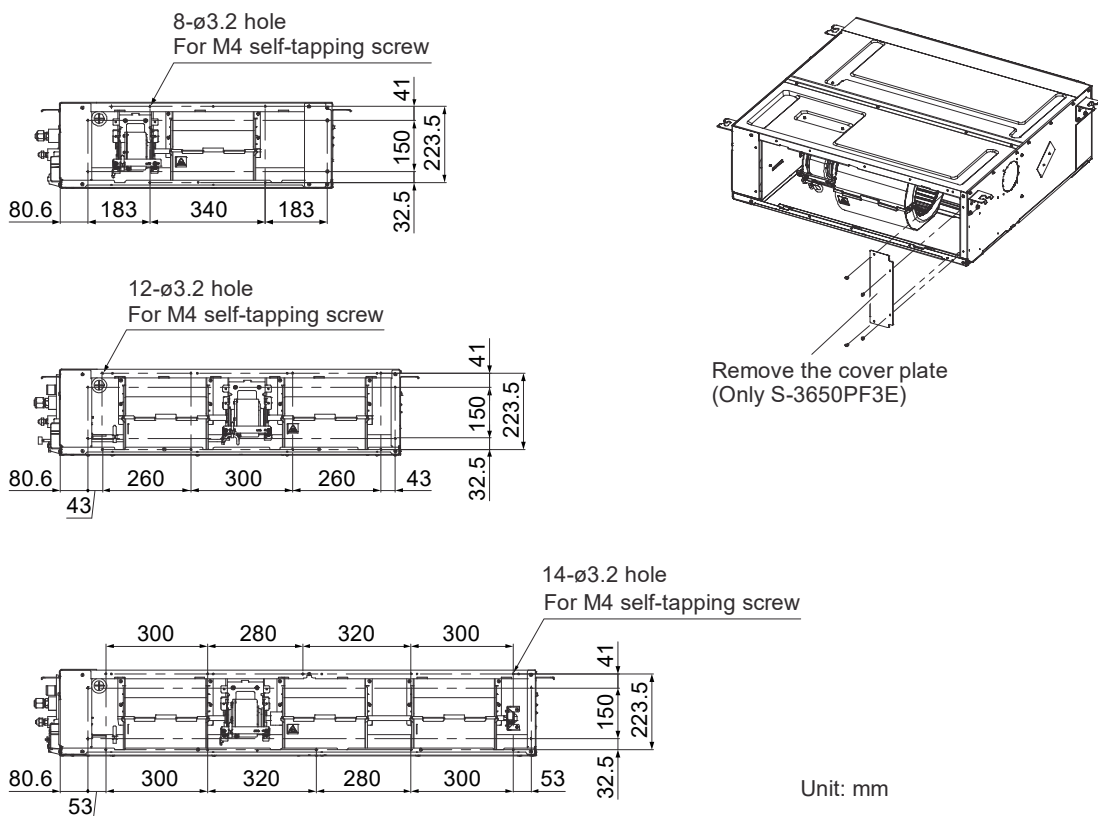

NOTE

To get clean air and to extend the service life of the air conditioner, an air filter must be installed in the air intake. For installation and cleaning the air filter, consult your dealer or service center.

12.1.4 Electrical Wiring

12.1.4.1 General Precautions on Wiring

- (1) Before wiring, confirm the rated voltage of the unit as shown on its nameplate, then carry out the wiring closely following the wiring diagram.



WARNING

- (2) This equipment is strongly recommended to be installed with Earth Leakage Circuit Breaker (ELCB) or Residual Current Device (RCD). Otherwise, it may cause electrical shock and fire in case of equipment breakdown or insulation breakdown.
Earth Leakage Circuit Breaker (ELCB) must be incorporated in the fixed wiring in accordance with the wiring regulations. The Earth Leakage Circuit Breaker (ELCB) must be an approved circuit capacity, having a contact separation in all poles.
- (3) To prevent possible hazards from insulation failure, the unit must be grounded.
- (4) Each wiring connection must be done in accordance with the wiring system diagram. Wrong wiring may cause the unit to misoperate or become damaged.
- (5) Do not allow wiring to touch the refrigerant tubing, compressor, or any moving parts of the fan.
- (6) Unauthorized changes in the internal wiring can be very dangerous. The manufacturer will accept no responsibility for any damage or misoperation that occurs as a result of such unauthorized changes.
- (7) Regulations on wire diameters differ from locality to locality. For field wiring rules, please refer to your LOCAL ELECTRICAL CODES before beginning.
You must ensure that installation complies with all relevant rules and regulations.
- (8) To prevent malfunction of the air conditioner caused by electrical noise, care must be taken when wiring as follows:
 - The remote control wiring and the inter-unit control wiring should be wired apart from the inter-unit power wiring.



CAUTION

Check local electrical codes and regulations before wiring. Also, check any specified instruction or limitations.

12.1.4.2 Recommended Wire Length and Wire Diameter for Power Supply System

The terminal block of the outdoor unit is as shown in the figure below.
Wire the indoor unit to the terminal block of unit C.

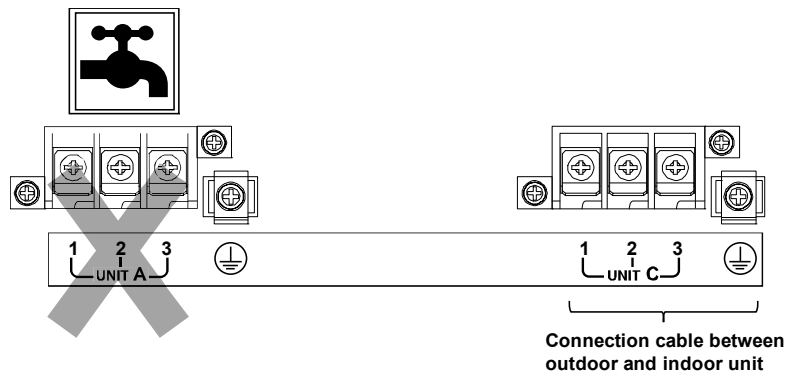

Indoor unit
(Type of 3-line connection [1, 2 and 3 with indoor and outdoor units])

Type	Connection cable between outdoor and indoor unit
F3	Max. 40 m

Control wiring

(C) Intergrated indoor unit control wiring	(D) Remote control wiring
0.75 mm ² (AWG #18) Use shielded wiring*	0.75 mm ²
Max. 1,000 m	(D) : Max. 500 m The above descriptions can be used for the model CZ-RTC4 or CZ-RTC5B series. For other remote controllers, refer to the manual of each unit.

NOTE

*1 Maximum applicable wire for terminal board of indoor unit : 4 mm²

*2 With ring-type wire terminal.

*3 Maximum length shows a 2% voltage drop.

12.1.4.3 Wiring System Diagrams

■ Wiring System Diagram For Multi Split Indoor Unit

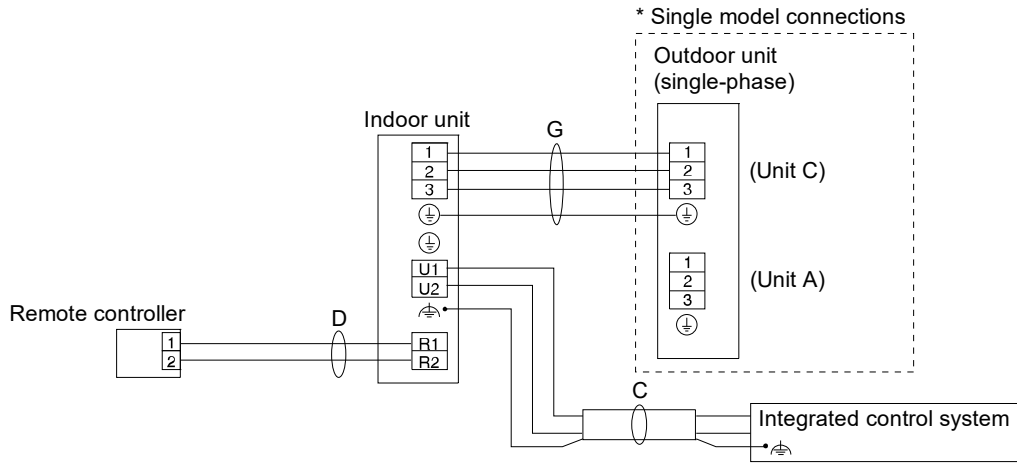

Indoor unit wiring sample

Use this screw when connecting the shield for the Inter-unit control wiring to ground.
(⊕ : Functional earthing)

Earth wiring:
Make the earth wiring 25 - 30 mm longer than connecting wires to 1, 2, 3.

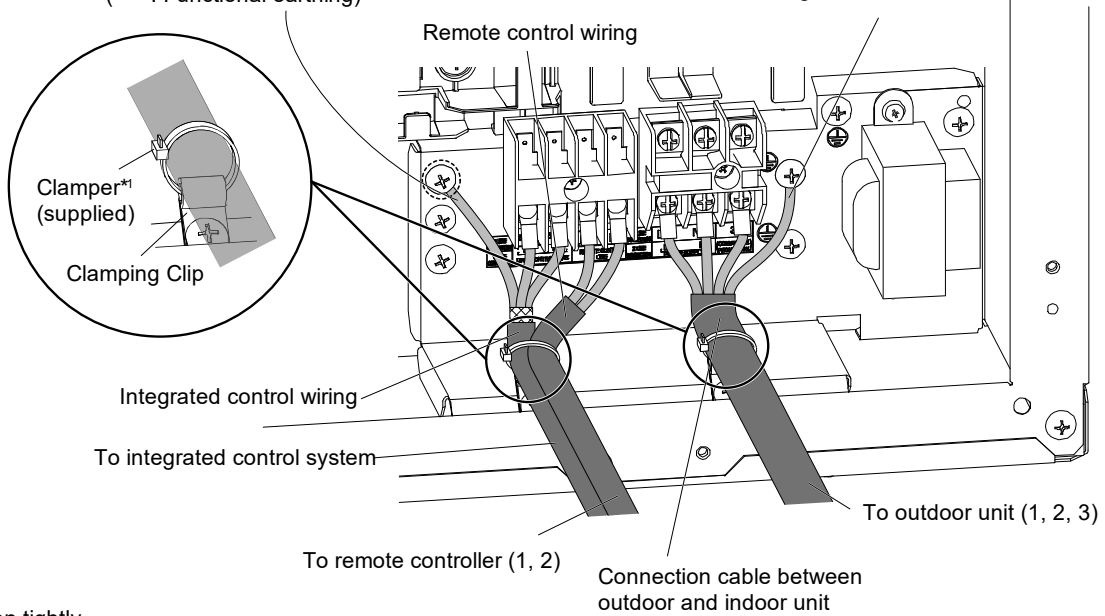

*1 Fasten tightly.

After all of the wires are connected, close the lid of the electrical component box.

Make the distance between two cables (① and ②) as shown in the figure to the right.

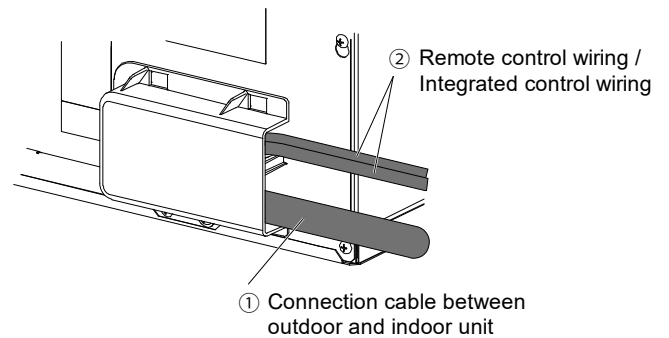

NOTE

- (1) See the section “12.1.4.2. Recommended Wire Length and Wire Diameter for Power Supply System” for the explanation of “C”, “D” and “G” under the section 12.1.4.3. in the previous page.
- (2) The basic connection diagram of the indoor unit shows the terminal boards, so the terminal boards in your equipment may differ from the diagram.
- (3) Regarding Refrigerant Circuit address setting, refer to the installation instructions supplied with the remote controller (Optional). Auto address setting can be executed by remote controller automatically.

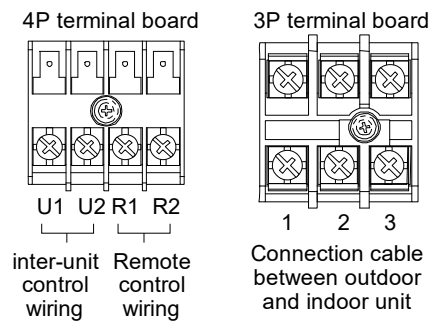

Type F3

CAUTION

- In the case of 3-line connection, connection cable between outdoor and indoor unit shall be approved polychloroprene sheathed flexible cord. Type designation 60245 IEC57 (H05RN-F, GP85PCP etc.) or heavier cord.

WARNING

Loose wiring may cause the terminal to overheat or result in unit malfunction. A fire hazard may also occur. Therefore, ensure that all wiring is tightly connected.

When connecting each power wire to the terminal, follow the instructions on “How to connect wiring to the terminal” and fasten the wire securely with the terminal screw.

How to connect wiring to the terminal

■ For stranded wiring

- (1) Cut the wire end with cutting pliers, then strip the insulation to expose the stranded wiring about 10 mm and tightly twist the wire ends.

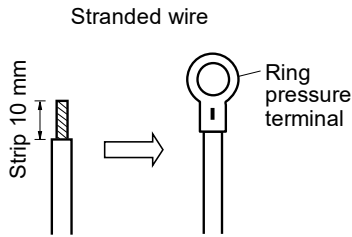

- (2) Using a Phillips head screwdriver, remove the terminal screw(s) on the terminal board.
- (3) Using a ring connector fastener or pliers, securely clamp each stripped wire end with a ring pressure terminal.
- (4) Place the ring pressure terminal, and replace and tighten the removed terminal screw using a screwdriver.

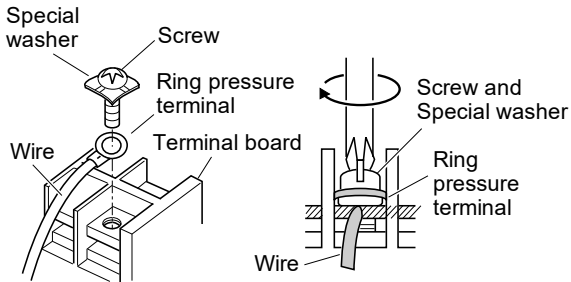

■ Examples of shield wires

- (1) Remove cable coat not to scratch braided shield.



- (2) Unbraid the braided shield carefully and twist the unbraided shield wires tightly together. Insulate the shield wires by covering them with an insulation tube or wrapping insulating tape around them.

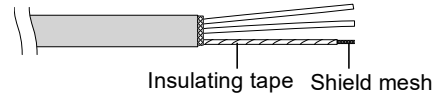

- (3) Remove coat of signal wire.

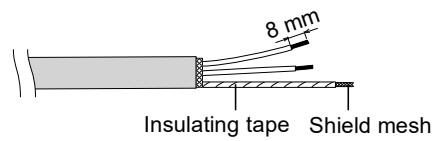

- (4) Attach ring pressure terminals to the signal wires and the shield wires insulated in Step (2).

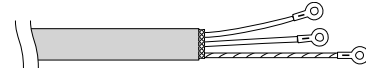

12.1.5 How to Process Tubing

Must ensure mechanical connections be accessible for maintenance purposes.

12.1.5.1 Connecting the Refrigerant Tubing

Use of the Flaring Method

Many of conventional split system air conditioners employ the flaring method to connect refrigerant tubes that run between indoor and outdoor units. In this method, the copper tubes are flared at each end and connected with flare nuts.

Flaring Procedure with a Flare Tool

- (1) Cut the copper tube to the required length with a tube cutter. It is recommended to cut approx. 30 – 50 cm longer than the tubing length you estimate.
- (2) Remove burrs at each end of the copper tubing with a tube reamer or a similar tool. This process is important and should be done carefully to make a good flare. Be sure to keep any contaminants (moisture, dirt, metal filings, etc.) from entering the tubing.

NOTE

When reaming, hold the tube end downward and be sure that no copper scraps fall into the tube.

- (3) Remove the flare nut from the unit and be sure to mount it on the copper tube.
- (4) Make a flare at the end of the copper tube with a flare tool.

NOTE

When flared joints are reused, the flare part shall be re-fabricated.

A good flare should have the following characteristics:

- inside surface is glossy and smooth
- edge is smooth
- tapered sides are of uniform length

Caution Before Connecting Tubes Tightly

- (1) Apply a sealing cap or water-proof tape to prevent dust or water from entering the tubes before they are used.
- (2) Be sure to apply refrigerant lubricant (ether oil) to the inside of the flare nut before making piping connections. This is effective for reducing gas leaks.
- (3) For proper connection, align the union tube and flare tube straight with each other, then screw on the flare nut lightly at first to obtain a smooth match.

- Adjust the shape of the liquid tube using a tube bender at the installation site and connect it to the liquid tubing side valve using a flare.

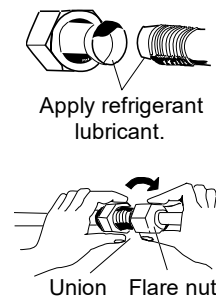
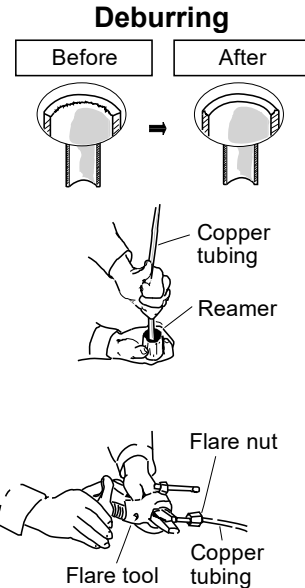

12.1.5.2 Connecting Tubing Between Indoor and Outdoor Units

(1) Tightly connect the indoor-side refrigerant tubing extended from the wall with the outdoor-side tubing.

Indoor Unit Tubing Connection

Unit : mm

Indoor unit type	S-71WF3E
Gas tube	Ø12.7
Liquid tube	Ø6.35

(2) To fasten the flare nuts, apply specified torque.

- When removing the flare nuts from the tubing connections, or when tightening them after connecting the tubing, be sure to use two spanners.
When tightening the flare nuts, use a torque wrench.
If the flare nuts are over-tightened, the flare may be damaged, which could result in refrigerant leakage and cause injury or asphyxiation to room occupants.
- For the flare nuts at tubing connections, be sure to use the flare nuts that were supplied with the unit, or else flare nuts for R410A, R32 (type 2). The refrigerant tubing that is used must be of the correct wall thickness as shown in the table at right.
Because the pressure is approximately 1.6 times higher than conventional refrigerant R22 pressure, the use of ordinary flare nuts (type 1) or thin-walled tubes may result in tube rupture, injury, or asphyxiation caused by refrigerant leakage.
- In order to prevent damage to the flare caused by over-tightening of the flare nuts, use the table on the right as a guide when tightening.
- When tightening the flare nut on the liquid tube, use an adjustable wrench with a nominal handle length of 200 mm.

Tube diameter	Tightening torque (approximate)	Tube thickness
ø6.35 (1/4")	14 – 18 N · m {140 – 180 kgf · cm}	0.8 mm
ø9.52 (3/8")	34 – 42 N · m {340 – 420 kgf · cm}	0.8 mm
ø12.7 (1/2")	49 – 55 N · m {490 – 550 kgf · cm}	0.8 mm
ø15.88 (5/8")	68 – 82 N · m {680 – 820 kgf · cm}	1.0 mm

12.1.5.3 Insulating the Refrigerant Tubing

Tubing Insulation

Must ensure that pipe-work shall be protected from physical damage.

- Thermal insulation must be applied to all units tubing, including distribution joint (field supply).
* For gas tubing, the insulation material must be heat resistant to 120°C or above. For other tubing, it must be heat resistant to 80°C or above.

Insulation material thickness must be 10 mm or greater.

If the conditions inside the ceiling exceed DB 30°C and RH 70%, increase the thickness of the gas tubing insulation material by 1 step.

Two tubes arranged together

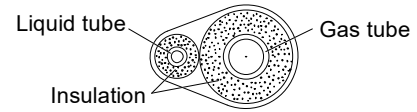

⚠ CAUTION

If the exterior of the outdoor unit valves has been finished with a square duct covering, make sure you allow sufficient space to access the valves and to allow the panels to be attached and removed.

Additional Precautions For R32 Models.

- ⚠ Ensure to do the re-flaring of pipes before connecting to units to avoid leaking.

To prevent the ingress of moisture into the joint which could have the potential to freeze and then cause leakage, the joint must be sealed with suitable silicone and insulation material. The joint should be sealed on both liquid and gas side.

Taping the flare nuts

Wind the white insulating tape around the flare nuts at the gas tube connections.

Then cover up the tubing connections with the flare insulator, and fill the gap at the union with the supplied black insulating tape.

Insulation material

The material used for insulation must have good insulation characteristics, be easy to use, be age resistant, and must not easily absorb moisture.

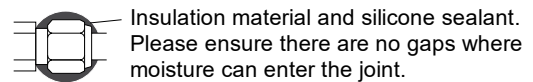

Silicone Sealant must be neutral cure and ammonia free. Use of silicon containing ammonia can lead to stress corrosion on the joint and cause leakage.

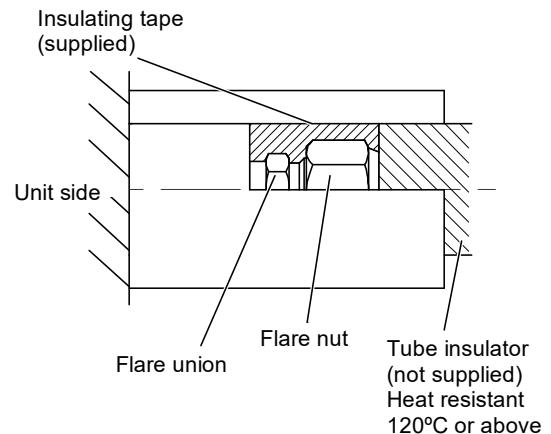

NOTE

If noise bothers you from the area between indoor and outdoor units' connection pipes, it is effective to wind the soundproofing materials (field supply) to reduce noise.

⚠ CAUTION

After a tube has been insulated, never try to bend it into a narrow curve because it can cause the tube to break or crack.

Never grasp the drain or refrigerant connecting outlets when moving the unit.

12.1.5.4 Taping the Tubes

- (1) At this time, the refrigerant tubes (and electrical wiring if local codes permit) should be taped together with armoring tape in 1 bundle. To prevent condensation from overflowing the drain pan, keep the drain hose separate from the refrigerant tubing.
- (2) Wrap the armoring tape from the bottom of the outdoor unit to the top of the tubing where it enters the wall. As you wrap the tubing, overlap half of each previous tape turn.
- (3) Clamp the tubing bundle to the wall, using 1 clamp approx. each meter.

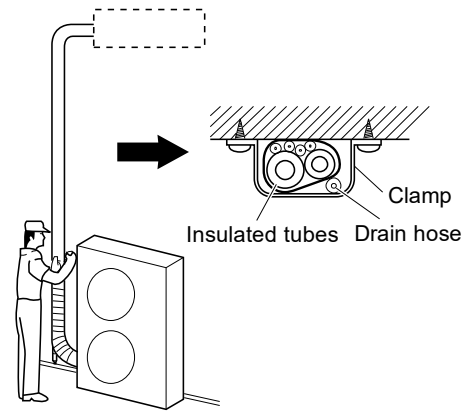

NOTE

Do not wind the armoring tape too tightly since this will decrease the heat insulation effect. Also ensure that the condensation drain hose splits away from the bundle and drips clear of the unit and the tubing.

12.1.5.5 Finishing the Installation

After finishing insulating and taping over the tubing, use sealing putty to seal off the hole in the wall to prevent rain and draft from entering.

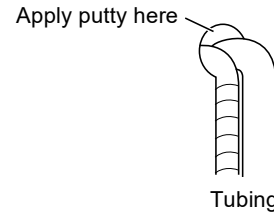

12.1.6 How to install the Timer Remote Controller or High-Spec Wired Remote Controller (Optional Part)

NOTE

Refer to the Installation Instructions attached to the optional Timer Remote Controller or optional High-spec Wired Remote Controller.

12.1.7 How to install Wireless Remote Controller

NOTE

Refer to the Installation Instructions attached to the optional Wireless Remote Controller.

12.1.8 Test Run

12.1.8.1 Precautions

- Request that the customer be present when the test run is performed.
At this time, explain the operation manual and have the customer perform the actual steps.
- Check that the 230 VAC power is not connected to the inter-unit control wiring connector terminal.
* If 230 VAC is accidentally applied, the indoor unit control PCB fuse will blow in order to protect the PCB.
In this case, make the wiring correctly.
Then disconnect the 2P connectors (OC) that are connected to the indoor unit control PCB, and replace them with 2P connectors (EMG).
- If operation is still not possible after changing the brown connectors, cut the jumper on the indoor unit control PCB.
(Be sure to turn the power OFF before performing this work.)
- Be sure to set the external static pressure before performing the test run.

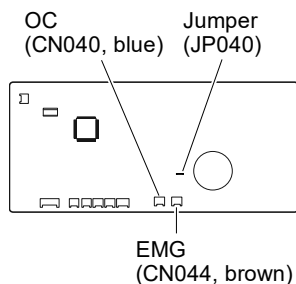

12.1.8.2 Test Run Procedure

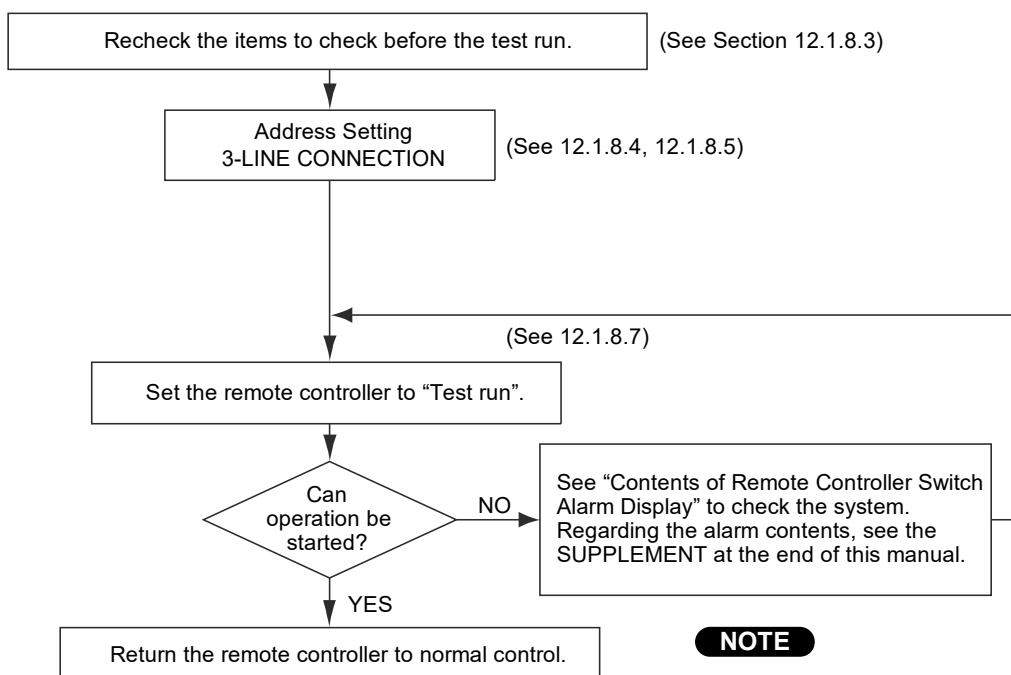

NOTE

Check the indoor-side drainage.

12.1.8.3 Items to Check Before the Test Run

- (1) Turn the remote power switch ON at least 5 hours in advance in order to energize.
- (2) Fully open the closed valves on the liquid tubing and gas tubing sides.
- (3) Separate the power supply in accordance with the types of system.

12.1.8.4 Address Setting : 3-LINE CONNECTION

NOTE

The displays of the earth is omitted.

12.1.8.4.1 Basic connection 1 : Single type

- It is not necessary to make setting of the refrigerant system address.
- When turning on all indoor and outdoor units, the auto address will start. It takes maximum 10 minutes.
- When the auto address setting is completed, wait at least 1 minute and 30 seconds. Then start the operation.

Single type

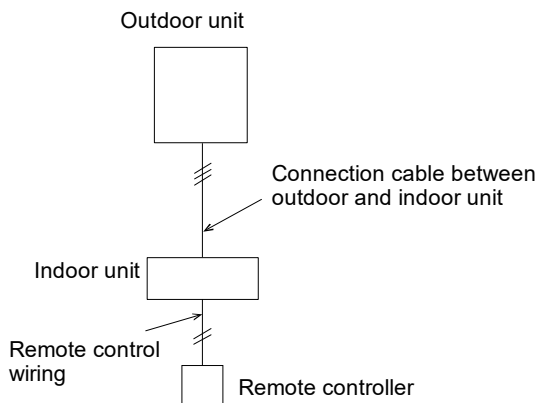

12.1.8.5 Auto Address Setting Using the Remote Controller

Auto Address Setting from the High-spec Wired Remote Controller (CZ-RTC5B)

- Keep pressing the , and buttons simultaneously for 4 or more seconds. The "Maintenance func" screen appears on the LCD display.
- Press the or button to see each menu. If you wish to see the next screen instantly, press the or button. Select "9. Auto address" on the LCD display and press the button.

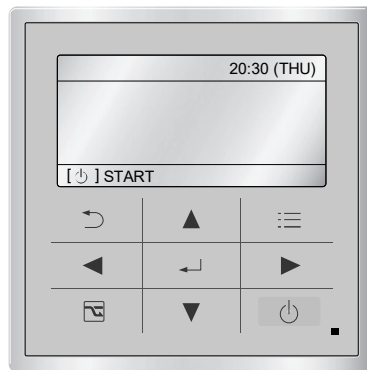

CZ-RTC5B

Maintenance func	20:30 (THU)
9. Auto address	
10. Set elec. consumption	
11. Set touch key	
12. Check touch key	
◄ Sel.	▶ Page [↵] Confirm

- The "Auto address" screen appears on the LCD display. Change the "Code no." to "A1" by pressing the or button.

Auto address	20:30 (THU)
Code no.	O/D unit no.
A1	1
◄ Sel.	▶ Next

- Select the "O/D unit no." by pressing the or button.

Select one of the "O/D unit no." for auto address

by pressing the or button.

Approximately 10 minutes are required.

When auto address setting is completed, the units return to normal stopped status.

Auto Address Setting* from the Remote Controller (CZ-RTC4)

* Auto address setting in Cooling mode cannot be done from the remote controller.

NOTE

- Selecting each refrigerant system individually for auto address setting
- Auto address setting for each system : Item code "A1"

- Press the remote controller timer time button and button at the same time. (Press and hold for 4 seconds or longer.)
- Next, press either the temperature setting / button. (Check that the item code is "A1".)
- Use either the button to set the system No. to perform auto address setting.
- Then press the button. (Auto address setting for one refrigerant system begins.) (When auto address setting for one system is completed, the system returns to normal stopped status.)

<Approximately 10 minutes are required.>

(During auto address setting, "SETTING" is displayed on the remote controller.

This message disappears when auto address setting is completed.)

- Repeat the same steps to perform auto address setting for each successive system.

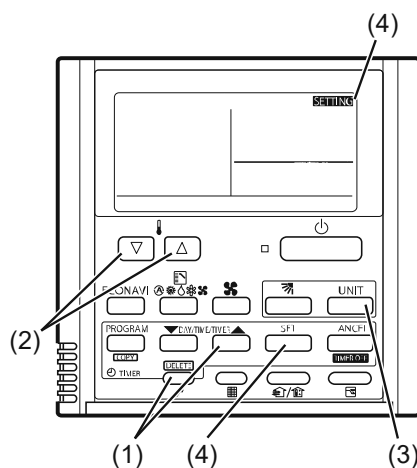





CZ-RTC4





12.1.8.6 Checking the Indoor Unit Addresses

Use the remote controller to check the indoor unit address.

CZ-RTC5B (High-spec wired remote controller)

- (1) Keep pressing the ,  and  buttons simultaneously for 4 or more seconds. The “Maintenance func” screen appears on the LCD display.

 Maintenance func	20:30 (THU)
1. Outdoor unit error data	
2. Service contact	
3. RC setting mode	
4. Test run	
◀ Sel. ▶ Page [↵] Confirm	

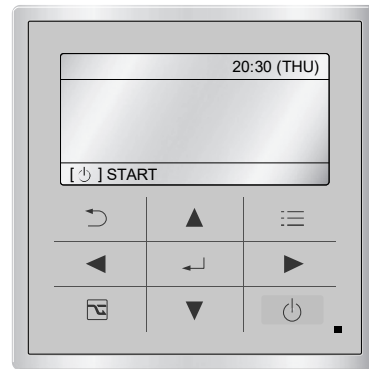

- (2) Press the  or  button to see each menu. If you wish to see the next screen instantly, press the  or  button. Select “7. Simple settings” on the LCD display and press the  button.

 Maintenance func	20:30 (THU)
5. Sensor info.	
6. Servicing check	
7. Simple settings	
8. Detailed settings	
◀ Sel. ▶ Page [↵] Confirm	



CZ-RTC5B

- (3) The “Simple settings” screen appears on the LCD display.

Select the “Unit no.” by pressing the  or  button for changes.

* The initial display is “ALL”.

Simple settings		20:30 (THU)
Unit no.	Code no.	Set data
▲ ALL ▼	01	0001
◀ Sel. ▶ Next		

The indoor unit fan operates only at the selected indoor unit.

CZ-RTC4 (Timer remote controller)

<If 1 indoor unit is connected to 1 remote controller>

- (1) Press and hold the button and button for 4 seconds or longer (simple settings mode).
- (2) The address is displayed for the indoor unit that is connected to the remote controller.
(Only the address of the indoor unit that is connected to the remote controller can be checked.)
- (3) Press the button again to return to normal remote controller mode.

Number changes to indicate which indoor unit is currently selected.

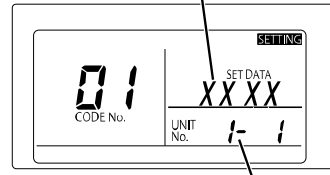

Indoor unit address

<If multiple indoor units are connected to 1 remote controller (group control)>

- (1) Press and hold the button and button for 4 seconds or longer (simple settings mode).
- (2) "ALL" is displayed on the remote controller.
- (3) Next, press the button.
- (4) The address is displayed for 1 of the indoor units which is connected to the remote controller.
Check that the fan of that indoor unit starts and that air is discharged.
- (5) Press the button again and check the address of each indoor unit in sequence.
- (6) Press the button again to return to normal remote controller mode.

Number changes to indicate which indoor unit is currently selected.

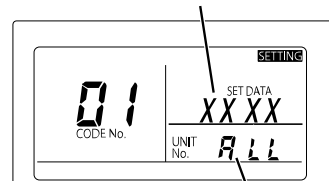

Indoor unit address

12.1.8.7 Test Run Using the Remote Controller

CZ-RTC5B (High-spec wired remote controller)

- (1) Keep pressing the , , and buttons simultaneously for 4 or more seconds.
The "Maintenance func" screen appears on the LCD display.

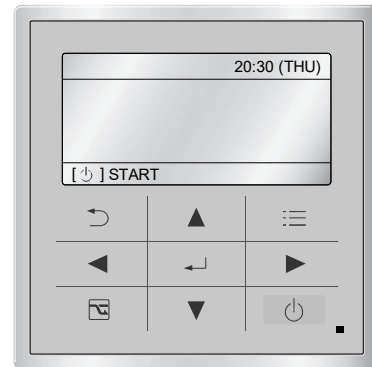
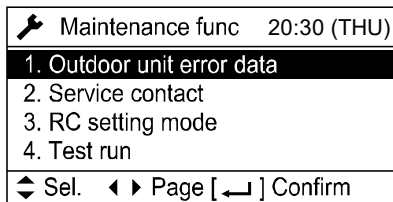

CZ-RTC5B

- (2) Press the or button to see each menu.
If you wish to see the next screen instantly, press the or button.
Select "4. Test run" on the LCD display and press the button.

Change the display from "OFF" to "ON" by pressing the or button. Then press the button.

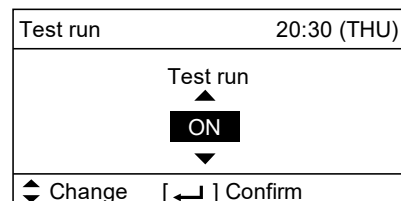
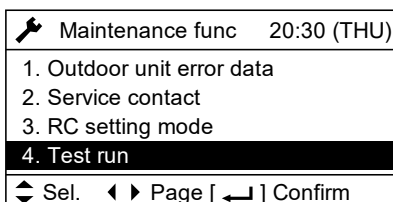

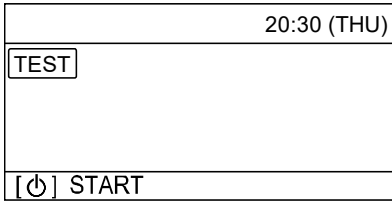

- (3) Press the  button. "TEST" will be displayed on the LCD display.

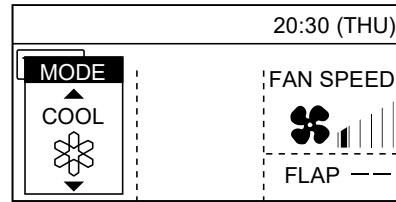

- (4) Press the  button. Test run will be started. Test run setting mode screen appears on the LCD display.



CZ-RTC4 (Timer remote controller)

- (1) Press the remote controller  button for 4 seconds or longer.
- Then press the  button.
- "TEST" appears on the LCD display while the test run is in progress.
 - The temperature cannot be adjusted when in Test Run mode.
(This mode places a heavy load on the machines. Therefore use it only when performing the test run.)
- (2) The test run can be performed using the HEAT, COOL, or FAN operation modes.

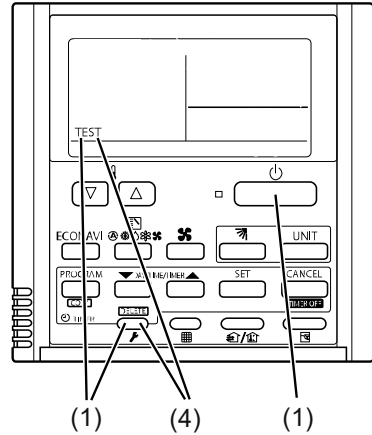

CZ-RTC4

NOTE

The outdoor units will not operate for approximately 3 minutes after the power is turned ON and after operation is stopped.

- (3) If correct operation is not possible, a code is displayed on the remote controller LCD display. (Regarding the alarm contents, see the SUPPLEMENT at the end of this manual.)
- (4) After the test run is completed, press the  button again. Check that "TEST" disappears from the LCD display. (To prevent continuous test runs, this remote controller includes a timer function that cancels the test run after 60 minutes.)
- * If the test run is performed using the wired remote controller, operation is possible even if the cassette-type ceiling panel has not been installed. ("P09" display does not occur.)

12.1.9 Checklist after Installation Work

Work List	No.	Content	Check <input checked="" type="checkbox"/>	Possibility of Failure & Checkpoint
Installation	1	Are the indoor units installed following the content of the section "12.1.2. SELECTING THE INSTALLATION SITE"?	<input type="checkbox"/>	There is a possibility of light injure or loss of property.
	2	Is the earth leakage circuit breaker (all-pole switching function provided) installed?	<input type="checkbox"/>	Power failure or short circuit may cause electric shock or fire. Check installation work and ground wire work.
	3	Is there any wrong installation of optional parts or wrong wiring?	<input type="checkbox"/>	
	4	Was the ground wire work performed?	<input type="checkbox"/>	
	5	Are there any wrong power supply wiring, wrong connection wire, wrong signal wire or loose screw?	<input type="checkbox"/>	
	6	Is the thickness of wire in accordance with rule?	<input type="checkbox"/>	
	7	Is the power-supply voltage equal to the nameplate of the unit?	<input type="checkbox"/>	
	8	Was the check of the airtight test, flared tube fitting and gas leakage on the welded portion performed?	<input type="checkbox"/>	
Drain Check	9	Has the adhesive been applied to the drain connecting portion (resin portion) of the indoor unit?	<input type="checkbox"/>	The resin portion cracks after a few months and it may cause water drain.
	10	Is there water leakage?	<input type="checkbox"/>	Since there is a possibility of water drain, repair the drain pipe if the drain failure or water drain occurs.
	11	Indoor unit drain pipe has a downward gradient (1/100 or more) by rule. Is the drain water flowing smoothly?	<input type="checkbox"/>	
Heat Insulation	12	Was the heat insulation work at a suitable location including the flared tube fitting (refrigerant tube & drain pipe) performed properly?	<input type="checkbox"/>	The quality of unit not only becomes inferior but there is a possibility of the water drain. So, perform the heat insulation work properly.
Test Run	13	Did the abnormal sound occur?	<input type="checkbox"/>	Check if there is a fan contact or distortion of the indoor unit.
	14	Did the cool and warm airflow discharge from the indoor unit?	<input type="checkbox"/>	Check if the unit does not operate or there is a wrong tubing or wiring connection with another system.

12.1.10 External Static Pressure Setting

For middle static pressure duct type indoor units, the ventilating resistance so-called “external static pressure” becomes greatly different depending on the connected duct length, shape, number of air outlet ports and types of filters.

When installing this unit, be sure to carry out the external static pressure setting in order to operate in the rated airflow volume.

Choose one of the following methods from “a”, “b”, “c” or “d” as shown in the flow chart (within the dotted lines) and then make the setting accordingly.

- a. No setting modification:
Use-as-is at shipment (there are cases in which the setting may differ from the shipment setting when reset after once setting the external static pressure.)
- b. Manual setting (set with the indoor unit control PCB):
For high static pressure. Switching method with the short-circuit connector.
- c. Manual setting (set with the wired remote controller):
Low static pressure ~ high static pressure
- d. Auto airflow volume setting (set on the wired remote controller):
Air outlet volume is automatically adjusted to the rated airflow volume with the auto airflow volume control operation.

Flow of External Static Pressure

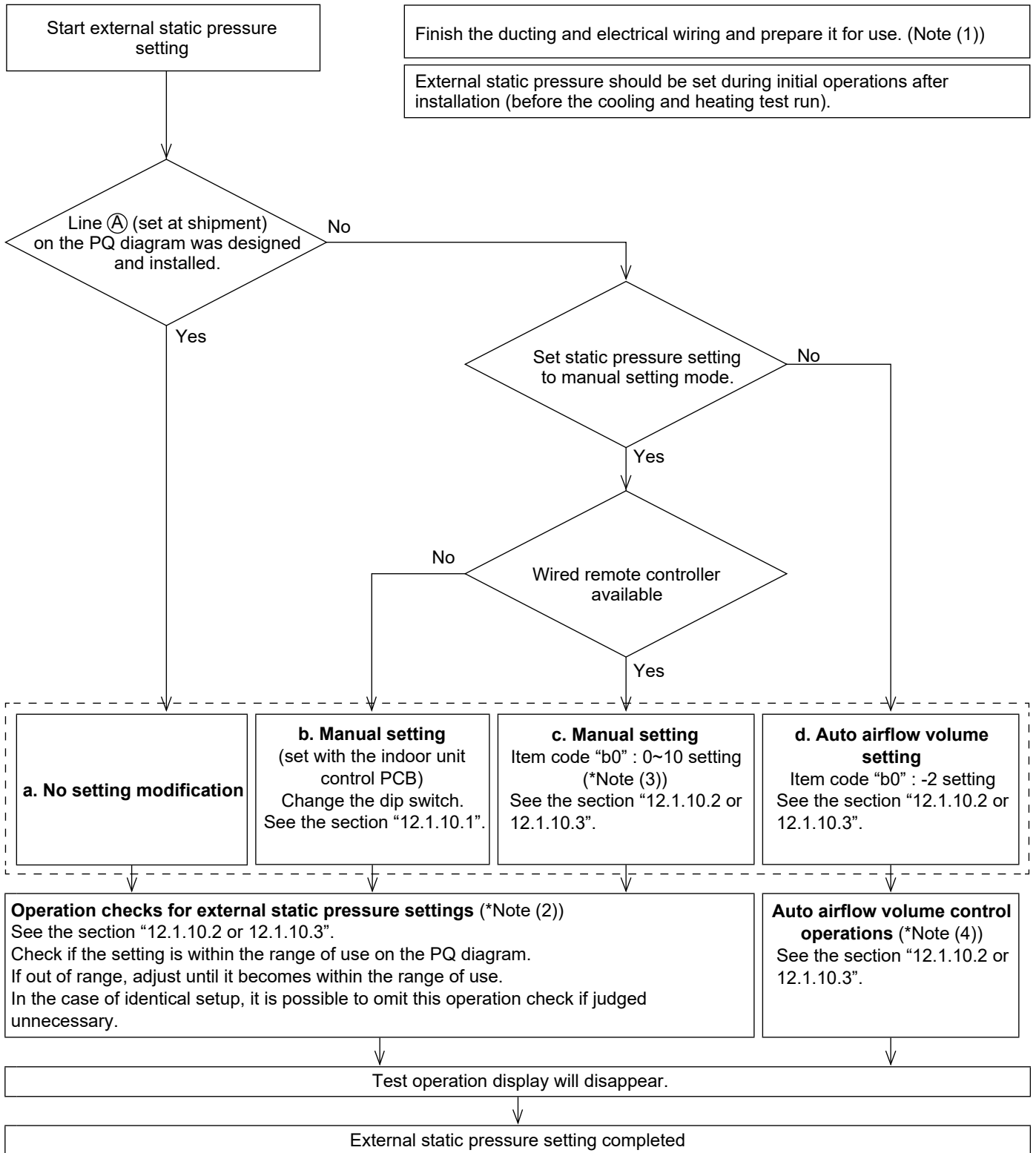

NOTE

- (1) Check the following items before performing the setting-check operations or auto airflow volume operations.
- 1) Check to make sure that the electrical wiring and ducting have been completed. Activate the stand-by mode. In particular, make sure that the closed damper located in the middle of the duct is open, if installed. Also, make sure that air filters have been installed inside the air inlet duct. Check to make sure air is not leaking from the joints.

- 2) If multiple air outlets and air inlets are included, adjust the airflow volume ratio of all of them until they meet the design airflow ratio.
- 3) Make sure the address setting has been completed.
- (2) The operation check will be completed in approximately three minutes if the settings have been made correctly. The settings will be modified if they are out of the range of use (maximum 30 minutes). If this is not completed within 31 minutes, check whether the air speed is set to "H" or not.
- (3) See Table 10-2, 10-3 and Page 303 for details on the relationship between the value of item code "b0" and the external static pressure.
- (4) If this is not completed within 8 minutes, check the operation mode, air speed and air inlet temperature.



CAUTION

- **Be sure to check that the external static pressure is within the range for use and then make the setting. Failure to observe this may result in insufficient airflow or water leakages. See Page 303 for the external static pressure setting range.**
- **There are cases in which automatic variable dampers and other mounted items may trigger the P12 alarm on systems that modify the external static pressure when the auto airflow volume control operations or setting check operations are carried out if high external static pressure is lowered. In this event, lower the dampers, etc., so that the external static pressure reaches its lowest level, and then carry out the auto airflow volume control operations or setting check operations.**
- **Be sure to set the [External Static Pressure Setting] once again after amending the airflow path for the duct or air outlet after setting the external static pressure.**
- **Set the air inlet temperature within the range for use. The auto airflow volume control will not function if the air inlet temperature is over 45°C or if operation is other than fan mode.**

12.1.10.1 How to Set on Indoor Unit Control PCB

1. Turn off the power breaker to halt the supply of electricity to the indoor unit control PCB.
2. Open the electrical component box cover, then check the indoor unit control PCB. (Fig. 10-1)
3. Change the dip switch (SW001) of the indoor unit control PCB according to the setting selected in Table 10-1.

Table 10-1

External static pressure of the rated airflow volume	DIP switch
10 Pa	
50 Pa	
110 Pa	

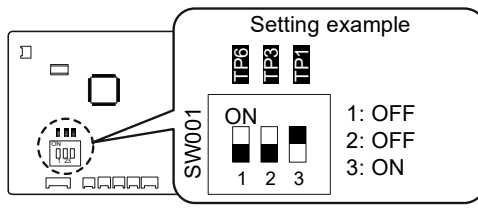

Indoor unit control PCB

Fig. 10-1

12.1.10.2 Operating the High-spec Wired Remote Controller (CZ-RTC5B)

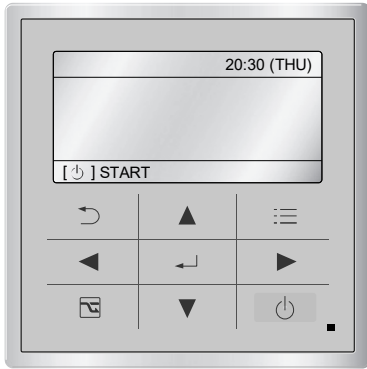

How to set the external static pressure

1. Keep pressing the , and buttons simultaneously for 4 or more seconds. The "Maintenance func" screen appears on the LCD display.

Maintenance func	20:30 (THU)
1. Outdoor unit error data	
2. Service contact	
3. RC setting mode	
4. Test run	
◆ Sel. ◀ ▶ Page [↵] Confirm	

2. Press the or button to see each menu. If you wish to see the next screen instantly, press the or button. Select "8. Detailed settings" on the LCD display and press the button.

Maintenance func	20:30 (THU)
5. Sensor info.	
6. Servicing check	
7. Simple settings	
8. Detailed settings	
◆ Sel. ◀ ▶ Page [↵] Confirm	

The "Detailed settings" screen appears on the LCD display.

Select the "Unit no." by pressing the or button for changes.

Detailed settings		20:30 (THU)
Unit no.	Code no.	Set data
1-1	10	0005
◆ Sel. ▶ Next		

3. Select the "Code no." by pressing the or button.
Change the "Code no." to "B0" by pressing the or button (or keeping it pressed).

Detailed settings		20:30 (THU)
Unit no.	Code no.	Set data
1-1	B0	-001
◆ Sel. ▶ Next		

4. Select the "Set data" by pressing the or button.
Select one of the "Set data" among "0001" – "0010" according to the desired external static pressure setting by pressing the or button.

Then press the button.
(See the table below.)

When setting to auto airflow volume control:
Select the setting data to "-002".

Then press the button.

Table 10-2 Setting the external static pressure

Indoor unit type	Item code
S-71WF3E	B0
Outdoor unit type	
CU-2WZ71YBE5	
External static pressure of the rated airflow volume (Pa)	
150	0010
140	0009
130	0008
120	0007
110	0006
90	0005
70	0004
50	0003
30 *	0002
10	0001
No auto airflow volume setting	-001
Auto airflow volume setting	-002

* Setting at shipment

5. Select the "Unit no." by pressing the or button and press the button. The "Exit detailed settings and restart?" (Detailed setting-end) screen appears on the LCD display.

Select "YES" and press the button. When the setting is completed, perform the test run for the external static pressure setting described in "Auto External Static Pressure Setting Operation".

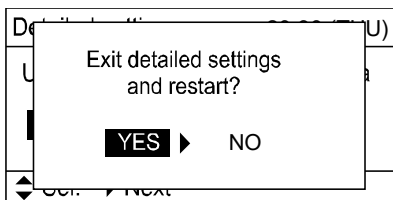

Auto External Static Pressure Setting Operation

6. Keep pressing the , , and buttons simultaneously for 4 or more seconds. The "Maintenance func" screen appears on the LCD display.

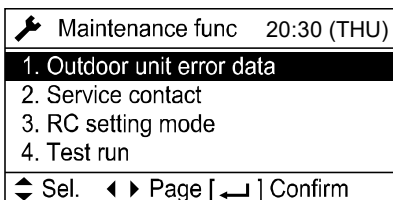

7. Press the or button to see each menu. If you wish to see the next screen instantly, press the or button. Select "4. Test run" on the LCD display and press the button.

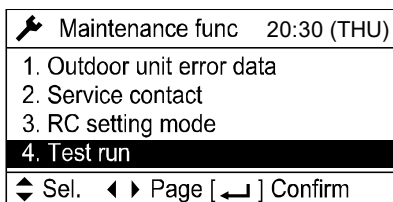

The "Test run" screen appears on the LCD display.

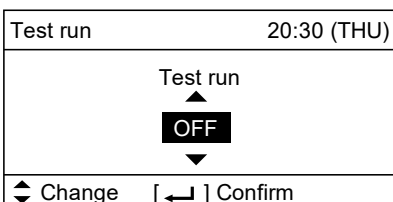

Change the display from "OFF" to "ON" by pressing the or button. Then press the button.

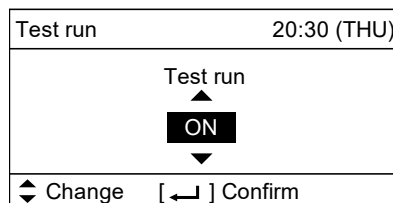

The "Maintenance func" screen appears on the LCD display.

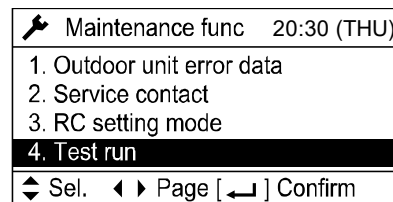

8. Press the button. "TEST" will be displayed on the LCD display.

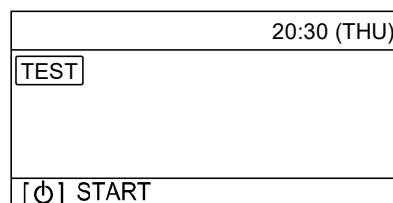

9. Press the button. Test run will be started. Test run setting mode screen appears on the LCD display.

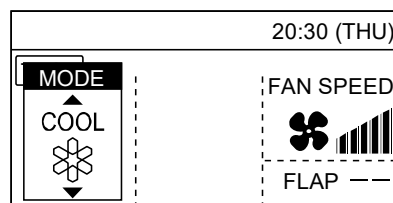

10. Set the operation mode to "MODE FAN" and fan speed mode to "FAN SPEED" by pressing the or button or or button. Then press the button.

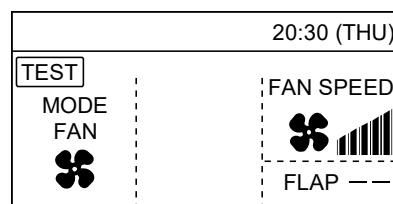

The fan motor will be activated, the auto external static pressure setting operation and setting-check operation will be performed for about 3 to 30 minutes. The fan speed will change automatically while these operations are in progress. When these operations completed, "TEST" will be disappeared from the LCD display.

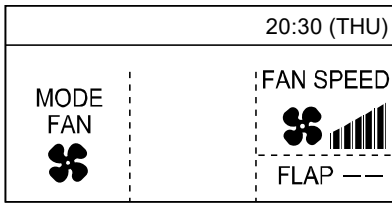

NOTE:

The auto external static pressure setting operation and setting-check operation will not be performed unless "MODE FAN" and "FAN SPEED" have been selected.

- Press the [POWER] button. The LCD display will be returned to the initial screen.

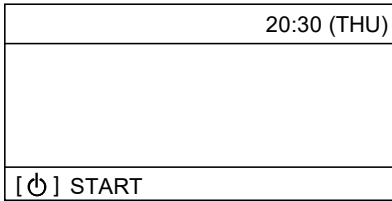

NOTE:

Failure to set this parameter may result in decreased airflow and condensation.

12.1.10.3 Operating the Timer Remote Controller (CZ-RTC4)

12.1.10.3.1 Setting Item Code "b0"

- Press and hold down the [STOP], [CANCEL] and [SET] buttons simultaneously for 4 or more seconds. (SETTING, the unit no., item code and detailed data will blink on the LCD display.)
- The indoor unit numbers in the group control will be sequentially displayed whenever the Unit Select button is pressed [UNIT]. Only the fan motor for the selected indoor unit will operate during this time.

- Specify the "b0" item code by pressing the [DOWN] / [UP] buttons for the temperature setting buttons and confirm the values. ("001" set at shipment)
- Press the [DAY] / [TIMER] buttons for the time to amend the values for the set data. See Table 10-3 and Page 303 and select a value between "001" and "0010". Select "-002" if the auto airflow volume setting is activated.
- Press the [SET] button. The display will stop blinking and remain illuminated.
- Press the [STOP] button. The fan motor will stop operating and the LCD display will return to the normal stop mode.

Table 10-3 Setting the external static pressure

Indoor unit type	Item code
S-71WF3E	b0
Outdoor unit type	
CU-2WZ71YBE5	
External static pressure of the rated airflow volume (Pa)	
150	0010
140	0009
130	0008
120	0007
110	0006
90	0005
70	0004
50	0003
30 *	0002
10	0001
No auto airflow volume setting	-001
Auto airflow volume setting	-002

* Setting at shipment

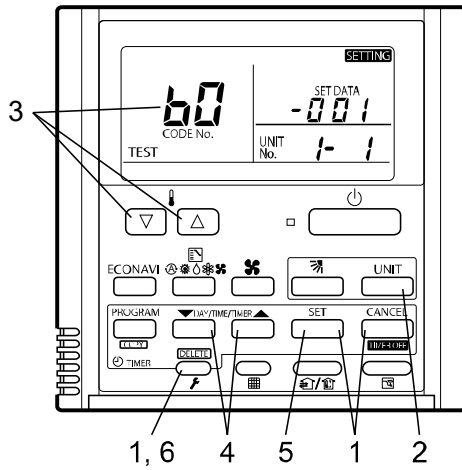





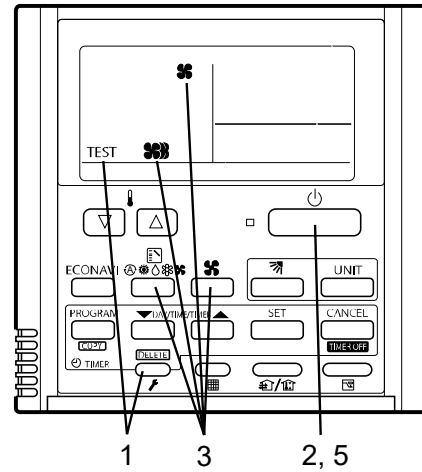

* Failure to set this parameter may result in decreased airflow and condensation.

5. Press the  button to halt the test run.



12.1.10.3.2 Auto Airflow Volume Control Operations and External Static Pressure Setting-Check Operation

1. Press and hold down the  button for 4 or more seconds. "TEST" will be displayed on the LCD display.
2. Press the  button to start the test run.
3. Select the operation mode  (Fan) by pressing the  (Mode select) button.
Then select the fan speed  by pressing the  (Fan speed) button.

NOTE

Auto airflow volume control operations and external static pressure setting-check operations will not be performed unless the above settings are made.

4. The fan motor will be activated and auto airflow volume control operations or external static pressure setting-check operations will be started. The power of the airflow will change while these operations are in progress. The external static pressure setting-check operations and auto airflow volume control operations will be completed in about 3 to 30 minutes. "TEST" display will be disappeared from the LCD display.

12.1.10.3.3 Fresh Air Intake

The amount of external air intake that is possible to feed when it is fed directly into the unit

Type	S-71WF3E
Permissible Air Intake Volume (m ³ /h)	105

12.1.11 Appendix

Care and Cleaning

WARNING

- For safety, be sure to turn the air conditioner off and also to disconnect the power before cleaning.
- Do not pour water on the indoor unit to clean it. This will damage the internal components and cause an electric shock hazard.

Air intake and outlet side (Indoor unit)

Clean the air intake and outlet side of the indoor unit with a vacuum cleaner brush, or wipe them with a clean, soft cloth.

If these parts are stained, use a clean cloth moistened with water. When cleaning the air outlet side, be careful not to force the vanes out of place.

CAUTION

- Never use solvents or harsh chemicals when cleaning the indoor unit. Do not wipe plastic parts using very hot water.
- Some metal edges and the fins are sharp and may cause injury if handled improperly; be especially careful when you clean these parts.
- The internal coil and other components of outdoor unit must be cleaned regularly. Consult your dealer or service center.

Air filter

The air filter collects dust and other particles from the air and should be cleaned at regular intervals or when the filter indication (🧺) on the display of the remote controller (wired type) shows that the filter needs cleaning. If the filter gets blocked, the efficiency of the air conditioner drops greatly.

Type	F3
Period	2 weeks

After Cleaning

- After the air filter is cleaned, reinstall it in its original position.
Be sure to reinstall in reverse order.
- [In the case of Timer Remote Controller]
Press the Filter reset button.

The 🧺 (Filter) indicator on the display goes out.

Timer Remote Controller

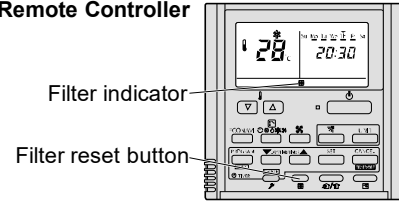

[In the case of High-spec Wired Remote Controller and Wired Remote Controller]
Refer to the Operating Instructions attached to the optional High-spec Wired Remote Controller or optional Wired Remote Controller.

High-spec Wired Remote Controller

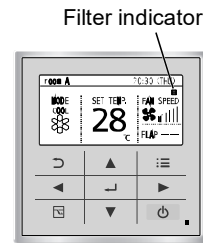

Wired Remote Controller



NOTE

The frequency with which the filter should be cleaned depends on the environment in which the unit is used. Clean the filter frequently for best performance in the area of dusty or oil spots regardless of filter status.

<How to clean the filter>

Use a vacuum cleaner to remove light dust. If there is sticky dust on the filter, wash the filter in lukewarm, soapy water, rinse it in clean water, and dry it.

<How to remove the filter>

Remove the filter in reverse order of the section “12.1.3.2.2. Install the Filter”.

- **In case of Installing the Duct (field supply)**

Type	F3
Period	(Depends on filter's specifications)

When cleaning the air filter, consult your dealer or service center.



CAUTION

- **Certain metal edges and the condenser fins are sharp and may cause injury if handled improperly; special care should be taken when you clean these parts.**
- **Periodically check the outdoor unit to see if the air outlet or air intake is clogged with dirt or soot.**
- **The internal coil and other components must also be cleaned periodically. Consult your dealer or service center.**

Care: After a prolonged idle period

Check the indoor and outdoor unit air intakes and outlets for blockage; if there is a blockage, remove it.

Care: Before a prolonged idle period

- Operate the fan for half a day to dry out the inside.
- Disconnect the power supply and also turn off the circuit breaker.
- Clean the air filter and replace it in its original position.
- Outdoor unit internal components must be checked and cleaned periodically. Contact your local dealer for this service.

■ Troubleshooting

If your air conditioner does not work properly, first check the following points before requesting service. If it still does not work properly, contact your dealer or a service center.







• Indoor unit

Symptom		Cause
Noise	Sound like streaming water during operation or after operation	<ul style="list-style-type: none"> • Sound of refrigerant liquid flowing inside unit • Sound of drainage water through drain pipe
	Cracking noise during operation or when operation stops.	Cracking sound due to temperature changes of parts
Odor	Discharged air is smelled during operation.	Indoor odor components, cigarette odor and cosmetic odor accumulated in the air conditioner and its air is discharged. Unit inside is dusty. Consult your dealer.
Dewdrop	Dewdrop gets accumulated near air discharge during operation	Indoor moisture is cooled by cool wind and accumulated by dewdrop.
Fog	Fog occurs during operation in cooling mode. (Places where large amounts of oil mist exist at restaurants.)	<ul style="list-style-type: none"> • Cleaning is necessary because unit inside (heat exchanger) is dirty. Consult your dealer as technical engineering is required. • During defrost operation
Fan is rotating for a while even though operation stops.		<ul style="list-style-type: none"> • Fan rotating makes operation smoothly. • Fan may sometimes rotate because of drying heat exchanger due to settings. • Fan may sometimes rotate in internal cleaning operation mode for a while.
Dust		Dust accumulation inside indoor unit is discharged.
Poor cooling or heating performance		<p>The indoor unit is initially designed to control the indoor temperature detected by the built-in room sensor inside the indoor unit.</p> <p>Due to indoor unit installation position, however, the built-in sensor may occasionally sense temperature improperly; for example, temperature difference between the ceiling and floor, lighting apparatus, electric fan, windows or waist-high partition walls, etc.</p> <p>In this case, the unit does not operate properly at the desired temperature. You may change the use of the temperature sensor inside the indoor unit to that of the remote controller.</p> <p>Then the desired room temperature can be controlled properly.</p> <p>For details, consult your dealer.</p>

- **Check Before Requiring Services**

Symptom	Cause	Remedy
Air conditioner does not run at all although power is turned on.	Power failure or after power failure	Press ON/OFF operation button on remote controller again.
	Operation button is turned off.	<ul style="list-style-type: none"> • Switch on power if breaker is turned off. • If breaker has been tripped, consult your dealer without turning it on.
	Fuse blow out.	If blown out, consult your dealer.
Poor cooling or heating performance	Air intake or air discharge port of indoor and outdoor units is clogged with dust or obstacles.	Remove dust or obstruction.
	Fan speed switch is set to "Low".*	Change to "Medium" or "High".*
	Improper temperature settings	Refer to "■ Tips for Energy Saving".
	Room is exposed to direct sunlight in cooling mode.	
	Doors and /or windows are open.	
	Air filter is clogged.	Refer to "■ Care and Cleaning".
	Too much heat sources in room in cooling mode.	Use minimum heat sources and in a short time.
	Too many people in room in cooling mode.	Reduce temperature settings or change to "Medium" or "High".*

* Fan speed display on the remote controller

- High :  (CZ-RTC4),  (CZ-RTC5B, CZ-RTC6*)
- Medium :  (CZ-RTC4),  (CZ-RTC5B, CZ-RTC6*)
- Low :  (CZ-RTC4),  (CZ-RTC5B, CZ-RTC6*)

If your air conditioner still does not work properly although you checked the points as described above, first stop the operation and turn off the power switch. Then contact your dealer and report the serial number and symptom. Never repair your air conditioner by yourself since it is very dangerous for you to do so.

■ Tips for Energy Saving

Avoid

- **Do not block the air intake and outlet of the unit. If either is obstructed, the unit will not work well, and may be damaged.**
- Do not let direct sunlight into the room. Use sunshades, blinds or curtains. If the walls and ceiling of the room are warmed by the sun, it will take longer to cool the room.

Do

- Always try to keep the air filter clean. (Refer to "■ Care and Cleaning".) A clogged filter will impair the performance of the unit.
- To prevent conditioned air from escaping, keep windows, doors and any other openings closed.

NOTE

Should the power fail while the unit is running

If the power supply for this unit is temporarily cut off, the unit will automatically resume operation once power is restored using the same settings before the power was interrupted.

Important Information Regarding The Refrigerant Used

NOTE

Refer to the Installation Instructions attached to the outdoor unit.

12.1.12 Indoor Floor Area Requirement

The refrigerant (R32), which is used in the air conditioner, is a flammable refrigerant. So the requirements for installation space of appliance are determined according to the refrigerant charge amount [m_c] used in the appliance.

Regarding the refrigerant charge amount [m_c] used in the appliance, refer to the installation instructions for the outdoor unit.

- If the total refrigerant charge in the system is <math>< 1.84 \text{ kg}</math>, no additional minimum floor area is required.
- If the total refrigerant charge in the system is $\geq 1.84 \text{ kg}$, additional minimum floor area requirements is complied as described below:

<Horizontal Installation>

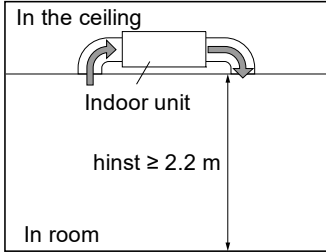

<Horizontal Installation>

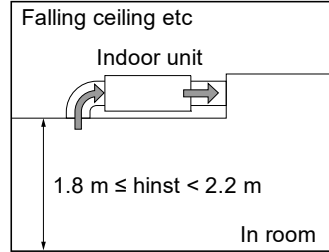

<Vertical Installation>

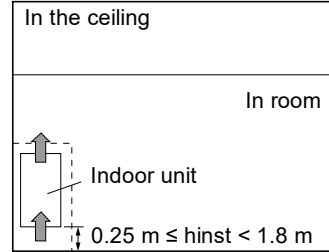

Table I - Maximum refrigerant charge allowed in a room

<Vertical Installation>

A _{room} (m ²)	Maximum refrigerant charge in a room (m _{max}) (kg)
	H=0.6m
49	2.40
50	2.42
51	2.45
52	2.47
53	2.50
54	2.52
55	2.54
56	2.57
57	2.59
58	2.61
59	2.63
60	2.66
61	2.68
62	2.70
63	2.72
64	2.74
65	2.76
66	2.78
67	2.81
68	2.83

A _{room} (m ²)	Maximum refrigerant charge in a room (m _{max}) (kg)
	H=0.6m
69	2.85
70	2.87
71	2.89
72	2.91
73	2.93
74	2.95
75	2.97
76	2.99
77	3.01
78	3.03
79	3.05
80	3.07
81	3.09
82	3.10
83	3.12
84	3.14
85	3.16
86	3.18
87	3.20

<Horizontal Installation>

A _{room} (m ²)	Maximum refrigerant charge in a room (m _{max}) (kg)		
	H=1.8m	H=2.0m	H=2.2m
1	0.41	0.46	0.51
2	0.83	0.92	1.01
3	1.24	1.38	1.52
4	1.66	1.84	2.03
5	2.07	2.30	2.53
6	2.49	2.76	3.04
7	2.72	3.02	3.33
8	2.91	3.23	
9	3.09		
10	3.25		

- For intermediate A_{room} values, the value that corresponds to the lower A_{room} value from the table is considered.
Example:
For A_{room}= 6.5 m², the value that corresponds to "A_{room}= 6 m²" is considered.

Table II – Minimum floor area



[m _c] kg	Minimum floor area (A _{min}) m ²			
	H=0.6m	H=1.8m	H=2.0m	H=2.2m
1.84	28.81	4.44	4.00	3.63
1.86	29.44	4.49	4.04	3.67
1.88	30.08	4.54	4.08	3.71
1.90	30.72	4.58	4.13	3.75
1.92	31.37	4.63	4.17	3.79
1.94	32.03	4.68	4.21	3.83
1.96	32.70	4.73	4.26	3.87
1.98	33.37	4.78	4.30	3.91
2.00	34.04	4.83	4.34	3.95
2.02	34.73	4.87	4.39	3.99
2.04	35.42	4.92	4.43	4.03
2.06	36.12	4.97	4.47	4.07
2.08	36.82	5.02	4.52	4.11
2.10	37.53	5.07	4.56	4.15
2.12	38.25	5.12	4.60	4.19
2.14	38.98	5.16	4.65	4.22
2.16	39.71	5.21	4.69	4.26
2.18	40.45	5.26	4.73	4.30
2.20	41.19	5.31	4.78	4.34
2.22	41.94	5.36	4.82	4.38
2.24	42.70	5.40	4.86	4.42
2.26	43.47	5.45	4.91	4.46
2.28	44.24	5.50	4.95	4.50
2.30	45.02	5.55	4.99	4.54
2.32	45.81	5.60	5.04	4.58
2.34	46.60	5.65	5.08	4.62
2.36	47.40	5.69	5.12	4.66
2.38	48.21	5.74	5.17	4.70
2.40	49.02	5.79	5.21	4.74
2.42	49.84	5.84	5.26	4.78
2.44	50.67	5.89	5.30	4.82
2.46	51.50	5.94	5.34	4.86
2.48	52.34	5.98	5.39	4.90
2.50	53.19	6.03	5.43	4.94
2.52	54.05	6.08	5.47	4.97

[m _c] kg	Minimum floor area (A _{min}) m ²			
	H=0.6m	H=1.8m	H=2.0m	H=2.2m
2.54	54.91	6.13	5.52	5.01
2.56	55.78	6.20	5.56	5.05
2.58	56.65	6.29	5.60	5.09
2.60	57.53	6.39	5.65	5.13
2.62	58.42	6.49	5.69	5.17
2.64	59.32	6.59	5.73	5.21
2.66	60.22	6.69	5.78	5.25
2.68	61.13	6.79	5.82	5.29
2.70	62.04	6.89	5.86	5.33
2.72	62.97	7.00	5.91	5.37
2.74	63.90	7.10	5.95	5.41
2.76	64.83	7.20	5.99	5.45
2.78	65.78	7.31	6.04	5.49
2.80	66.72	7.41	6.08	5.53
2.82	67.68	7.52	6.12	5.57
2.84	68.64	7.63	6.18	5.61
2.86	69.62	7.74	6.27	5.65
2.88	70.59	7.84	6.35	5.69
2.90	71.58	7.95	6.44	5.73
2.92	72.57	8.06	6.53	5.76
2.94	73.56	8.17	6.62	5.80
2.96	74.57	8.29	6.71	5.84
2.98	75.58	8.40	6.80	5.88
3.00	76.60	8.51	6.89	5.92
3.02	77.62	8.62	6.99	5.96
3.04	78.65	8.74	7.08	6.00
3.06	79.69	8.85	7.17	6.04
3.08	80.74	8.97	7.27	6.08
3.10	81.79	9.09	7.36	6.12
3.12	82.85	9.21	7.46	6.16
3.14	83.91	9.32	7.55	6.24
3.16	84.99	9.44	7.65	6.32
3.18	86.06	9.56	7.75	6.40
3.20	87.15	9.68	7.84	6.48











- For intermediate m_c values, the value that corresponds to the higher m_c value from the table is considered.
Example:
If m_c= 1.85 kg, the value that corresponds to “m_c= 1.86 kg” is considered.
- Charges above 3.20 kg are not allowed in the unit.

SUPPLEMENT
Contents of Remote Controller Switch Alarm Display



ON: ○ Blinking: ☀ OFF: ●

Abnormal display	Wireless remote controller receiver display			Alarm contents	Error location
					
	Operation	Timer	Standby		
Remote controller • Indoor Unit	E01	Operating lamp blinking ☀ ● ●	● ●	Faulty remote controller	• Replace the remote controller
				Disconnection / Contact failure of remote controller wiring	• Correct the remote controller wiring
				CHK (check) pins on the indoor unit control PCB are short circuited	• Remove the short
				In the case of non-group control · Power supply OFF of outdoor unit · Disconnection / Contact failure of inter-unit wiring In the case of group control Automatic address operation was not carried out	• Execute auto address setting
				Faulty setting of EEPROM (IC010) on indoor unit	• Replace the indoor unit EEPROM
	E02			Faulty remote controller	• Replace the remote controller
				Wrong wiring of remote controller	• Correct the remote controller wiring
	E03			Error in indoor unit receiving signal from remote controller (central)	• Check the indoor unit control PCB • Check the remote controller wiring • Check the inter-unit control wiring
	E04	Standby lamp blinking ● ● ☀	● ●	Disconnection / Contact failure of inter-unit wiring	• Check the electrical connection of inter-unit control wiring • Replace the indoor unit control PCB • Replace the outdoor unit control PCB • Check the electrical connection of fuse (F302) on indoor unit control PCB In the case of the fuse opened on an indoor unit control PCB, after correcting wiring connection, it substitutes an EMG plug for OC plug
				• Faulty indoor unit control PCB • Faulty outdoor unit control PCB • Communication circuit fuse (F302) on indoor unit control PCB opened	
• Fuse on outdoor unit control PCB opened Since failure of an outdoor fan motor is considered as a cause, both outdoor unit control PCB and outdoor unit fan motor are exchanged simultaneously				• In the case of the fuse opened on an outdoor unit control PCB, replace both outdoor unit control PCB (CR/HIC) and outdoor unit fan motor simultaneously	
E08			Duplication of indoor unit address setting	• Indoor unit address re-setting	
E09	Operating lamp blinking ☀ ● ●	● ●	Error because of more than one remote controller setting to main	• Correct the setting	
E18			• Disconnection of wiring between main unit and additional units • Contact failure of wiring • Faulty indoor unit control PCB (main or addition)	• Correct the wiring connection • Replace the wiring • Replace the indoor unit control PCB	
F01	Operating and timer lamp blinking alternately ☀ ☀ ●	●	Indoor heat exchanger temperature sensor (E1) trouble	• Check the indoor unit heat exchanger temperature sensor (E1) • Check the indoor unit control PCB	
F02			Indoor heat exchanger temperature sensor (E2) trouble	• Check the indoor unit heat exchanger temperature sensor (E2) • Check the indoor unit control PCB	
F10			Indoor air temperature sensor (TA) trouble	• Check the indoor unit air temperature sensor (TA) • Check the indoor unit control PCB	

ON: ○ Blinking: ☀ OFF: ●

Abnormal display		Wireless remote controller receiver display			Alarm contents	Error location	
							
		Operation	Timer	Standby			
Remote controller • Indoor Unit	F29	Operating and timer lamp blinking simultaneously   ●			Indoor unit EEPROM trouble	<ul style="list-style-type: none"> • Check the indoor unit EEPROM • Check the indoor unit control PCB 	
	L02	Operating and standby lamps blinking simultaneously  ● 			Setting error, indoor / outdoor unit type / model miss-matched	<ul style="list-style-type: none"> • Address re-setting after correcting the combination of units 	
	L03				Duplication of main indoor unit address in group control	<ul style="list-style-type: none"> • Correct the group (main and addition) 	
	L07				Group control wiring is connected to individual control indoor unit	<ul style="list-style-type: none"> • Correct the indoor unit address 	
	L08				Indoor unit address is not set	<ul style="list-style-type: none"> • Correct the indoor unit address 	
	L09				Indoor unit capacity is not set	<ul style="list-style-type: none"> • Correct the capacity setting of indoor units 	
	P01				Timer and standby lamp blinking alternately ●  		
	P09	Indoor unit fan motor layer short	<ul style="list-style-type: none"> • Replace the fan motor 				
		Contact failure in thermostat protector circuit	<ul style="list-style-type: none"> • Correct the wiring 				
		Faulty wiring connections of (ceiling) indoor unit panel	<ul style="list-style-type: none"> • Correct the wiring connection 				
	P10	Faulty drain pump	<ul style="list-style-type: none"> • Repair / Replace 				
		Drainage failure	<ul style="list-style-type: none"> • Correct 				
		Contact failure of float switch wiring	<ul style="list-style-type: none"> • Correct the wiring 				
P11	Float switch : High water alarm	<ul style="list-style-type: none"> • For vertical installation, set the detailed settings Code No. "3F" to "0001". (See pages 108 to 109.) 					
	Faulty drain pump	<ul style="list-style-type: none"> • Repair / Replace 					
	Drain pump locked	<ul style="list-style-type: none"> • Remove the cause 					
P12	Indoor unit fan motor locked Faulty wiring connections of indoor unit fan motor			<ul style="list-style-type: none"> • Remove the cause • Correct the wiring 			
Outdoor Unit	E06	Standby lamp blinking ● ● 					
					<ul style="list-style-type: none"> • Disconnection of inter-unit wiring • Communication circuit fuse (F302) on indoor unit control PCB opened 		
	E12	Operating lamp blinking  ● ●			Indoor unit control PCB address settings error	<ul style="list-style-type: none"> • Indoor unit address re-setting 	
					Auto address setting start is prohibited	<ul style="list-style-type: none"> • Check the inter-unit control wiring 	
E14	Duplication of main unit in group control			<ul style="list-style-type: none"> • Check the inter-unit control wiring • Check the indoor unit combination 			

ON: ○ Blinking: ☀ OFF: ●

Abnormal display	Wireless remote controller receiver display			Alarm contents	Error location			
								
	Operation	Timer	Standby					
Outdoor Unit	E15	Standby lamp blinking		Automatic address alarm	The total capacity of indoor units are too low	<ul style="list-style-type: none"> • Check the inter-unit control wiring • Check the indoor and outdoor unit control PCB • Address re-setting after correcting the combination of units 		
	E16				The total capacity of indoor units are too high The numbers of indoor units are two or more	<ul style="list-style-type: none"> • Check the inter-unit control wiring • Check the indoor and outdoor unit control PCB 		
	E20				● ● ☀	No indoor unit connected		
	E24					<ul style="list-style-type: none"> • Outdoor unit communication error 	<ul style="list-style-type: none"> • Check the outdoor unit control PCB 	
	E29			<ul style="list-style-type: none"> • Outdoor unit communication error 	<ul style="list-style-type: none"> • Check the outdoor unit control PCB 			
	F04	Operating and timer lamp blinking alternately			Compressor discharge temperature sensor (TD) trouble	<ul style="list-style-type: none"> • Check the compressor discharge temperature sensor (TD) • Check the outdoor unit control PCB 		
	F06				Outdoor heat exchanger temperature sensor (C1) trouble	<ul style="list-style-type: none"> • Check the outdoor unit heat exchanger temperature sensor (C1) • Check the outdoor unit control PCB 		
	F07				Outdoor heat exchanger temperature sensor (C2) trouble	<ul style="list-style-type: none"> • Check the outdoor unit heat exchanger temperature sensor (C2) • Check the outdoor unit control PCB 		
	F08				Outdoor air temperature sensor (TO) trouble	<ul style="list-style-type: none"> • Check the outdoor air temperature sensor (TO) • Check the outdoor unit control PCB 		
	F12				☀ ☀ ○	Compressor suction temperature sensor (TS) trouble	<ul style="list-style-type: none"> • Check the compressor suction temperature sensor (TS) • Check the outdoor unit control PCB 	
	F16					High Pressure Sensor Trouble	<ul style="list-style-type: none"> • Check the high pressure sensor • Check the outdoor unit control PCB 	
	F23					Outdoor Gas Pipe Temperature Sensor Trouble	<ul style="list-style-type: none"> • Check the outdoor gas pipe temperature sensor • Check the outdoor unit control PCB 	
	F24					Outdoor Liquid Pipe Temperature Sensor Trouble	<ul style="list-style-type: none"> • Check the outdoor liquid pipe temperature sensor • Check the outdoor unit control PCB 	
	F31				Operating and timer lamp blinking alternately			Outdoor unit EEPROM trouble
H01	Timer lamp blinking						Primary (input) overcurrent detected	<ul style="list-style-type: none"> • Check the refrigerant cycle (abnormal overload operation) • Check the outdoor unit control PCB • Check the power supply
H02		PAM trouble	<ul style="list-style-type: none"> • Check the outdoor unit control PCB • Compressor locked • Check the power supply 					
H03		● ☀ ●	Primary current CT sensor failure	<ul style="list-style-type: none"> • Check the outdoor unit control PCB 				
H31			HIC trouble DC voltage not detected	<ul style="list-style-type: none"> • Check the outdoor unit control PCB • Check the HIC • Compressor locked • Valve blockage 				

ON: ○ Blinking: ☀ OFF: ●

Abnormal display	Wireless remote controller receiver display			Alarm contents	Error location
	☀	⌚	☀		
	Operation	Timer	Standby		
Outdoor Unit	L04			Duplication of outdoor unit address	<ul style="list-style-type: none"> Check the inter-unit control wiring
	L10			Outdoor unit capacity is not set or setting error	<ul style="list-style-type: none"> Replace the outdoor unit EEPROM Capacity value re-setting
	L13	Operating and standby lamps blinking simultaneously		Indoor unit type setting error Type of indoor/outdoor units is different	<ul style="list-style-type: none"> Replace the indoor unit EEPROM Check the outdoor unit control PCB Check the type of IU and OU, and re-set address
	L18	☀ ○ ☀		4-way valve locked trouble / operation failure	<ul style="list-style-type: none"> Check the 4-way valve Check the 4-way valve wiring Check the outdoor unit control PCB
	P03			Compressor discharge temperature trouble	<ul style="list-style-type: none"> Check the refrigerant cycle (gas leak) Trouble with the electronic expansion valve Check the discharge temperature sensor (TD)
	P04	Operating and standby lamp blinking alternately		Condensing pressure trouble	<ul style="list-style-type: none"> Check the refrigerant cycle Valve blockage Heat exchanger obstruction
	P05	☀ ● ☀		Open phase detected AC power supply trouble	<ul style="list-style-type: none"> Check the power supply Check the reactor wiring Check the outdoor unit control PCB Check the compressor wiring
	P07			HIC (IPM) temperature trouble	<ul style="list-style-type: none"> Check the outdoor unit control PCB Check the HIC Compressor locked Valve blockage
	P13	Timer and standby lamp blinking alternately		Valve error Refrigerant circuit error Wrong installation for refrigerant piping and wiring	<ul style="list-style-type: none"> Valve blockage Check the refrigerant circuit Check the refrigerant piping and wiring installation
	P14	● ☀ ☀		O ₂ sensor detected	<ul style="list-style-type: none"> Input from the O₂ sensor
	P15			Insufficient gas level detected	<ul style="list-style-type: none"> Check the refrigerant cycle (gas leak) Trouble with the electronic expansion valve Valve (or refrigerant circuit) blockage
	P16	Operating and standby lamp blinking alternately		Compressor overcurrent trouble	<ul style="list-style-type: none"> Layer short on the compressor Compressor locked Check the outdoor unit control PCB
	P22			Outdoor unit fan motor trouble Outdoor unit fan trouble	<ul style="list-style-type: none"> Check the outdoor unit fan motor, connector
	P29	☀ ● ☀		Inverter compressor trouble	<ul style="list-style-type: none"> Layer short on the compressor Check the outdoor unit control PCB Check the inverter compressor wiring (Open phase/Reverse phase) Compressor actuation failure (include lock) Valve (or refrigerant circuit) blockage
	P31			Indoor unit in group control trouble	<ul style="list-style-type: none"> Repair indoor unit which blinking alarm

12.2 Wired Remote Control Installation (Optional Part)

12.2.1 CZ-RTC4

12.2.1.1 Supplied Accessories

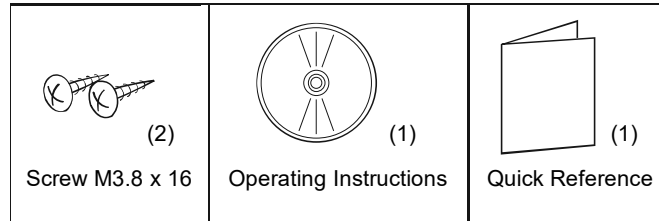

*Remote control wiring is not supplied. (field supplied item)

12.2.1.2 Dimensions

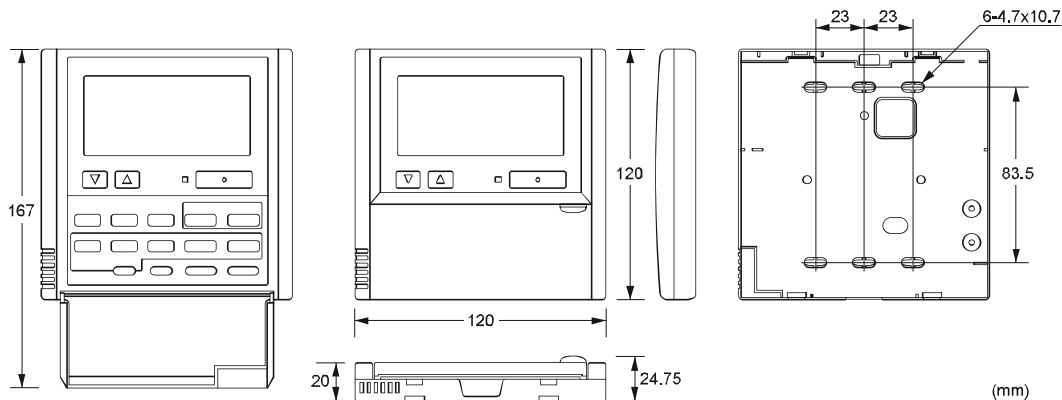

12.2.1.3 Installation Location

- Install at the height of 1 to 1.5 m from the floor (Location where average room temperature can be detected).
- Install vertically against the floor.
- When installing more than 1 remote controller next to each other, keep distance of 5 mm on the right and left and 50 mm on top and bottom.
- Avoid the following locations for installation.
 - By the window, etc. exposed to direct sunlight or direct air
 - In the shadow or backside of objects deviated from the room airflow.
 - Location where condensation occurs (The remote controller is not moisture proof or drip proof.)
 - Location near heat source
 - Uneven surface
- Keep distance of 1 m or more from the TV, radio and PC. (Cause of fuzzy images or noise)

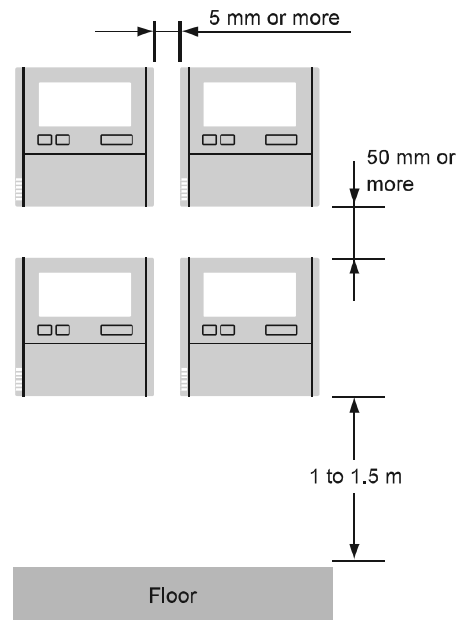

12.2.1.4 Remote Control Wiring

- **Wiring diagram**

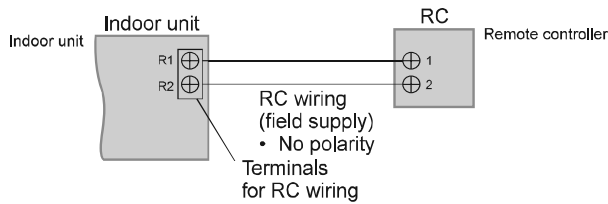

- **Type of wiring**

Use cables of 0.5 to 1.25 mm².

- **Total wire length:** 500 m or less

(The wire length between indoor units should be 200 m or less.)

- **Number of connectable units**

Remote controller: Max. 2 Indoor unit: Max. 8

Attention

- Use the field supplied RC wiring with at least 1 min in thickness of insulation part including the sheath. Regulations on wire diameters differ from locally to locally. For field wiring rules, please refer to your LOCAL ELECTRICAL CODES before beginning. You must ensure that installation complies with relevant rules and regulations.
- Be careful not to connect cables to other terminals of indoor units (e.g. power source wiring terminal). Malfunction may occur.
- Do not bundle together with the power source wiring or store in the same metal tube. Operation error may occur.
- If noise is induced to the unit power supply, attach a noise filter.

***Wiring as shown below is prohibited.**

Installation example

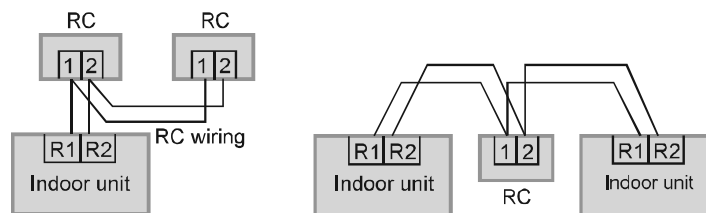

- **When setting both the main and sub remote controllers**

After installation, set one remote controller to [Main] and the other to [Sub] for [Main/sub] for "Setting".

Installation example

- Using 1 indoor unit

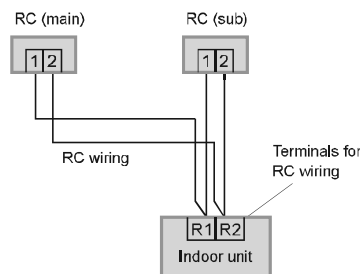

*Remote controllers can be connected to any indoor unit for operation.

12.2.1.5 Mounting

1. Remove the bottom case.

Insert the driver and slightly turn.

*Do not insert the screw driver too deep. Doing so may cause the claw to be broken.

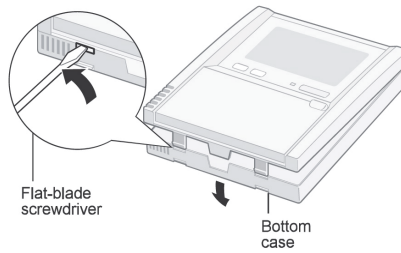

Attention

• Mounting the bottom case

- Tighten the screws securely until the screw heads touch the bottom case. (Otherwise, loose screw heads may hit the PCB and cause malfunction when mounting the top case.)
- Do not over-tighten the screws. (The bottom case may be deformed, resulting in fall of the unit.)

• Connecting the remote control wiring

- Arrange the wires as shown in the illustration for ⑥ in step 2 and ⑤, avoiding unnecessary wires being stored in the case.
- Avoid the wires touching parts on the PCB.
- Avoid the wires coming in contact with the metallic object protruded from the PCB. (Caught wires may destroy the PCB.)

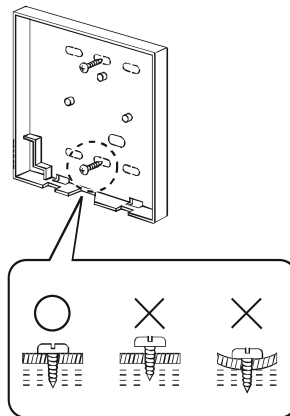

• Mounting the top case

- Do not push the top case with excessive force. (Doing so may cause the protrusions of the bottom case to hit and destroy the PCB.)

2. Mount to the wall.

- Exposed type

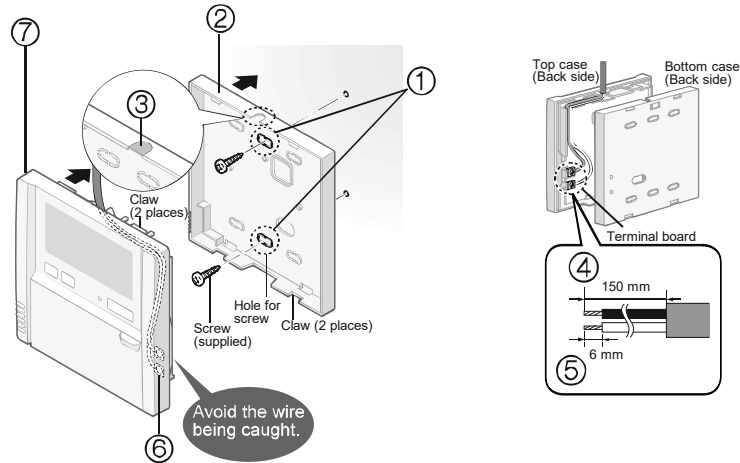

- Make 2 holes for screws using a driver.
- Mount the bottom case to the wall.
- Cut here with a nipper and remove the burr with a file.
- Remove the sheath. Approx. 150 mm
- Remove the coating. Approx. 6 mm
- Connect the remote control wiring.
 - Make sure the wiring connection is in the correct direction.
 - Arrange the wires along the groove of the case.
 - Avoid the wire being caught.
- Mount the top case.
 - Align the claws of the top case and then align the claws of the bottom case.

- Embedded type

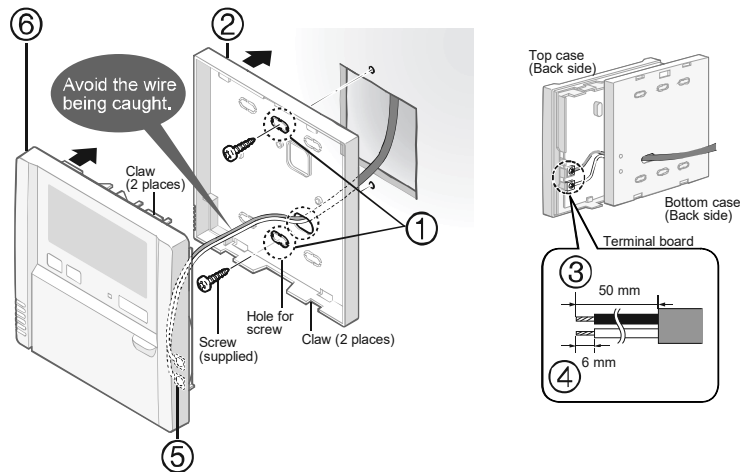





- Make 2 holes for screws using a driver.
- Mount the bottom case to the wall.
 - Pass the wire through the hole in the centre of the bottom case.
- Remove the sheath. Approx. 50 mm
- Remove the coating. Approx. 6 mm
- Connect the remote control wiring.
 - Make sure the wiring connection is in the correct direction.
 - Avoid the wire being caught.
- Mount the top case.
 - Align the claws of the top case and then align the claws of the bottom case.

12.2.1.6 Setting / Test Operation

Setting

- Clock
- RC. setting mode (Main/sub, Clock type)
- Detailed setting mode (Ventilation fan output setting, Room temperature sensor, Temperature display setting)

Clock

1. Press and hold  for several seconds.
2. Set day of the week, hour and minute.
 →  "▼": Su ↔ Mo ↔ ... ↔ Sa
 (Repeat) 

RC. setting mode

1. Press and hold the 2 buttons for several seconds simultaneously.



2. Select the Code no.



3. Select the Set data.



The indicator illuminates after blinking.

Press .

Code no.	Item	Set data	
		0000	0001
01	Main/sub	Sub	Main
02	Clock type	24 hours	12 hours (AM/PM)

Detailed setting mode

1. Press and hold the 3 buttons for several seconds simultaneously.



2. Select the Code no.



3. Select the Unit no.



4. Select the Set data.









The indicator illuminates after blinking.

Press .

Code no.	Item	Set data	
		0000	0001
31	Ventilation fan output setting	Not connected	Connected
32	Room temperature sensor	Main unit	RC
33	Temperature display setting	°C	°F

Test operation

Turn on the circuit breaker beforehand, referring to the operating instructions for the unit. The remote controller starts.

1. **Press and hold  for several seconds.**
[TEST] display appears. (The unit enters the test operation mode.)
2. **Press . Perform the test operation.**
[TEST] is display during the test operation.
3. **Press . Finish the test operation**
[TEST] display disappears.
4. **Delete the error history.**
Press and hold the 2 buttons for several seconds simultaneously.
, 
 Information of errors is displayed.
 To delete the error history, press .
 Press  to finish service mode.

Attention

- Do not use this mode for purposes other than the test operation.
(To prevent overload of this units)
- Read the installation instructions supplied with the units.
- Any of the Heat, Cool and Fan operations can only be performed.
- Temperature cannot be changed.
- The test operation mode is automatically turned off in 60 minutes. (To prevent continuous test operation)
- Outdoor units do not operate for approx. 3 minutes after the power is turned on or operation is stopped.

12.2.2 CZ-RTC5B

12.2.2.1 Supplied Accessories

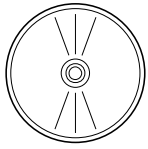
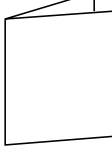
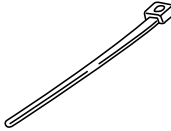
Screw M3.8 x 16 (2)	Instructions (1)	Quick Reference (1)	Clamper (1)
			

*Remote control wiring is not supplied. (field supplied item)

12.2.2.2 Dimensions

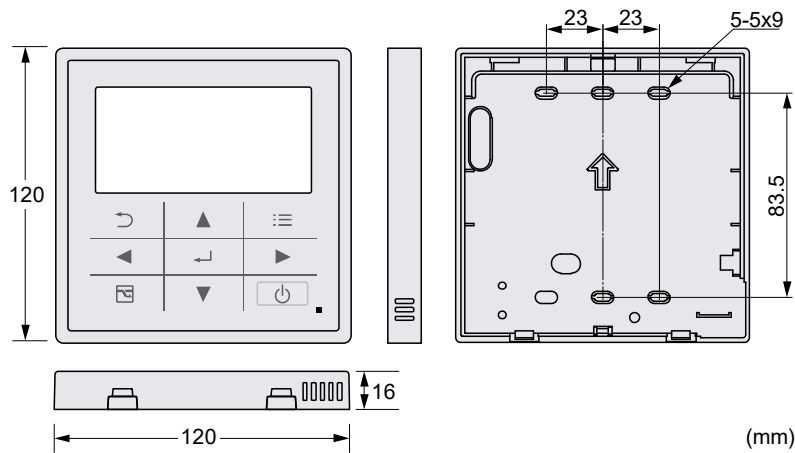

12.2.2.3 Installation Precautions

12.2.2.3.1 Installation Location

- Install at the height of 1 to 1.5 m from the floor (Location where average room temperature can be detected).
- Install vertically against the floor.
- When installing more than 1 remote controller next to each other, keep distance of 5 mm on the right and left and 50 mm on top and bottom.
- Avoid the following locations for installation.
 - By the window, etc. exposed to direct sunlight or direct air
 - In the shadow or backside of objects deviated from the room airflow.
 - Location where condensation occurs (The remote controller is not moisture proof or drip proof.)
 - Location near heat source
 - Uneven surface
- Keep distance of 1 m or more from the TV, radio and PC. (Cause of fuzzy images or noise)

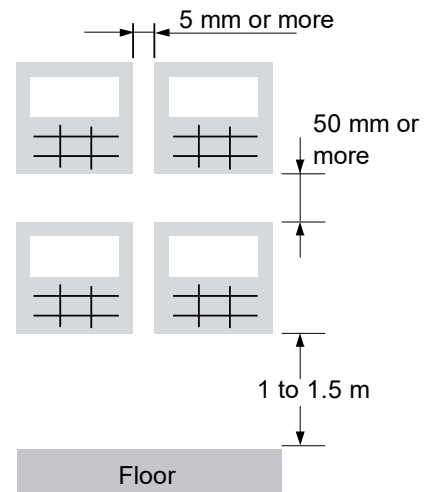

12.2.2.3.2 Remote Control Wiring

- **Wiring diagram**

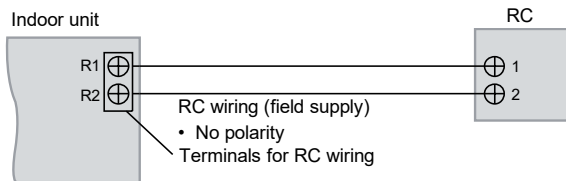

- Type of wiring
Use cables of 0.5 to 1.25 mm².
- Total wire length: 500 m or less
(The wire length between indoor units should be 200 m or less.)
- Number of connectable units
Remote controller: Max. 2
Indoor unit: Max. 8

Attention

- Use the field supplied RC wiring with at least 1 mm in thickness of insulation part including the sheath. Regulations on wire diameters differ from locally to locally. For field wiring rules, please refer to your LOCAL ELECTRICAL CODES before beginning. You must ensure that installation complies with relevant rules and regulations.
- Be careful not to connect cables to other terminals of indoor units (e.g. power source wiring terminal). Malfunction may occur.
- Do not bundle together with the power source wiring or store in the same metal tube. Operation error may occur.
- If noise is induced to the unit power supply, attach a noise filter.

Wiring as shown below is prohibited.

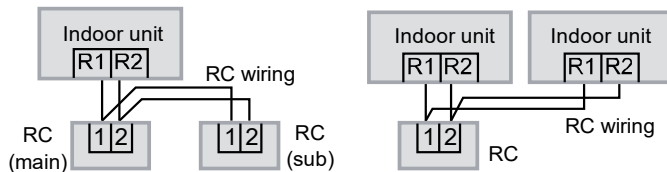

- **When setting both the main and sub remote controllers**
After installation, set one remote controller to [Main] and the other to [Sub] for [Main/sub] for “Setting”. (See the other side)
When using the remote controllers* in combination, set this unit to [Main].
*CZ-RTC2, CZ-RTC4, CZ-RE2C2, CZ-RELC2

- **Using 1 indoor unit**

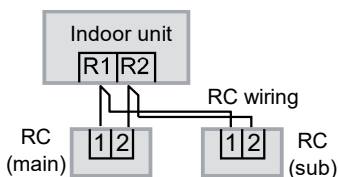

Note

Remote controllers can be connected to any indoor unit for operation.

12.2.2.4 Mounting

1. Remove the bottom case.

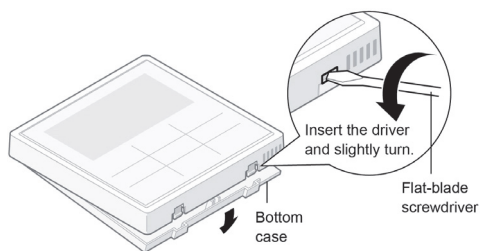

Attention

- **Mounting the bottom case**
 - Tighten the screws securely until the screw heads touch the bottom case. (Otherwise, loose screw heads may hit the PCB and cause malfunction when mounting the top case.)
 - Do not over-tighten the screws. (The bottom case may be deformed, resulting in fall of the unit.)
- **Connecting the remote control wiring**
 - Arrange the wires as shown in the illustration for ② in step 2, avoiding unnecessary wires being stored in the remote controller case. (Caught wires may destroy the PCB.)
 - Avoid wires touching parts on the PCB. (Caught wires may destroy the PCB.)

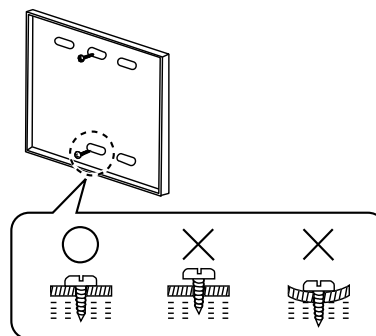

2. Mount the wall.

- Exposed type
Preparation: Make 2 holes for screws using a driver.

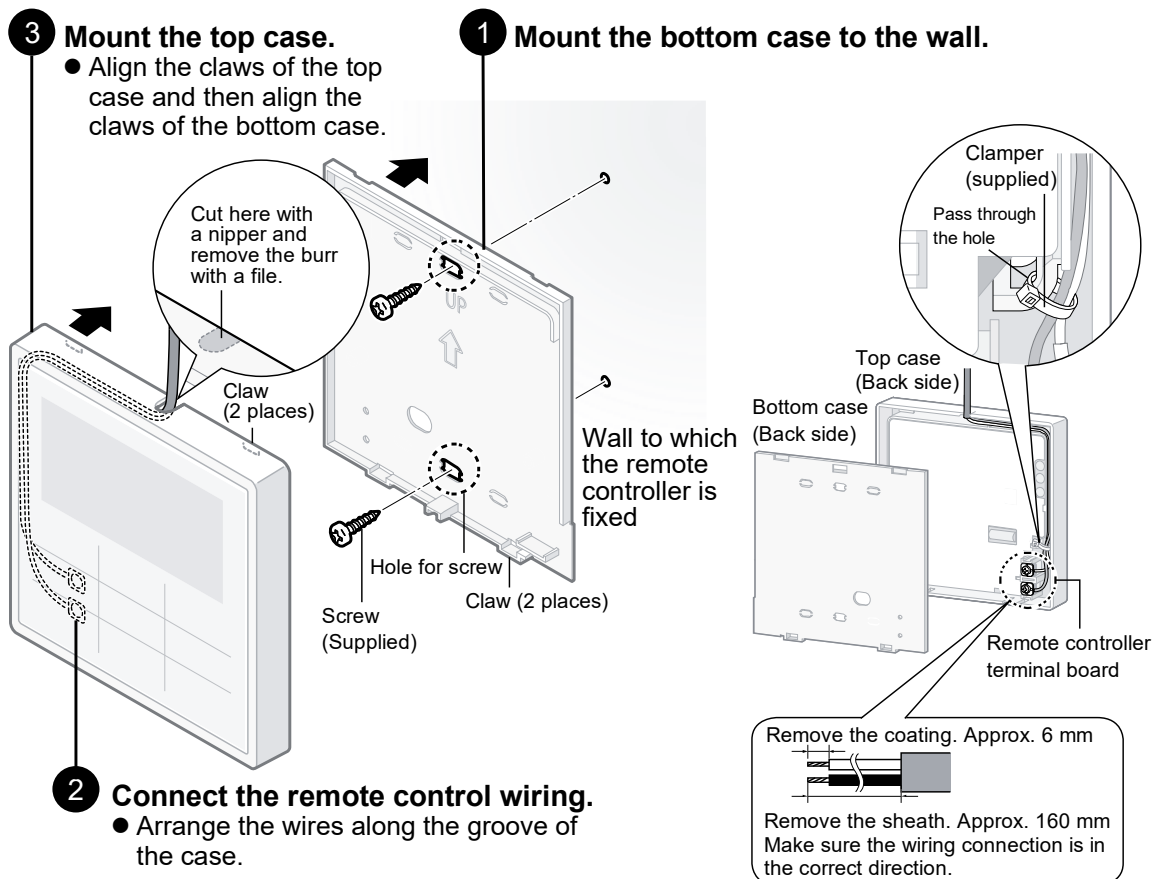

- Embedded type

Preparation: Make 2 holes for screws using a driver.

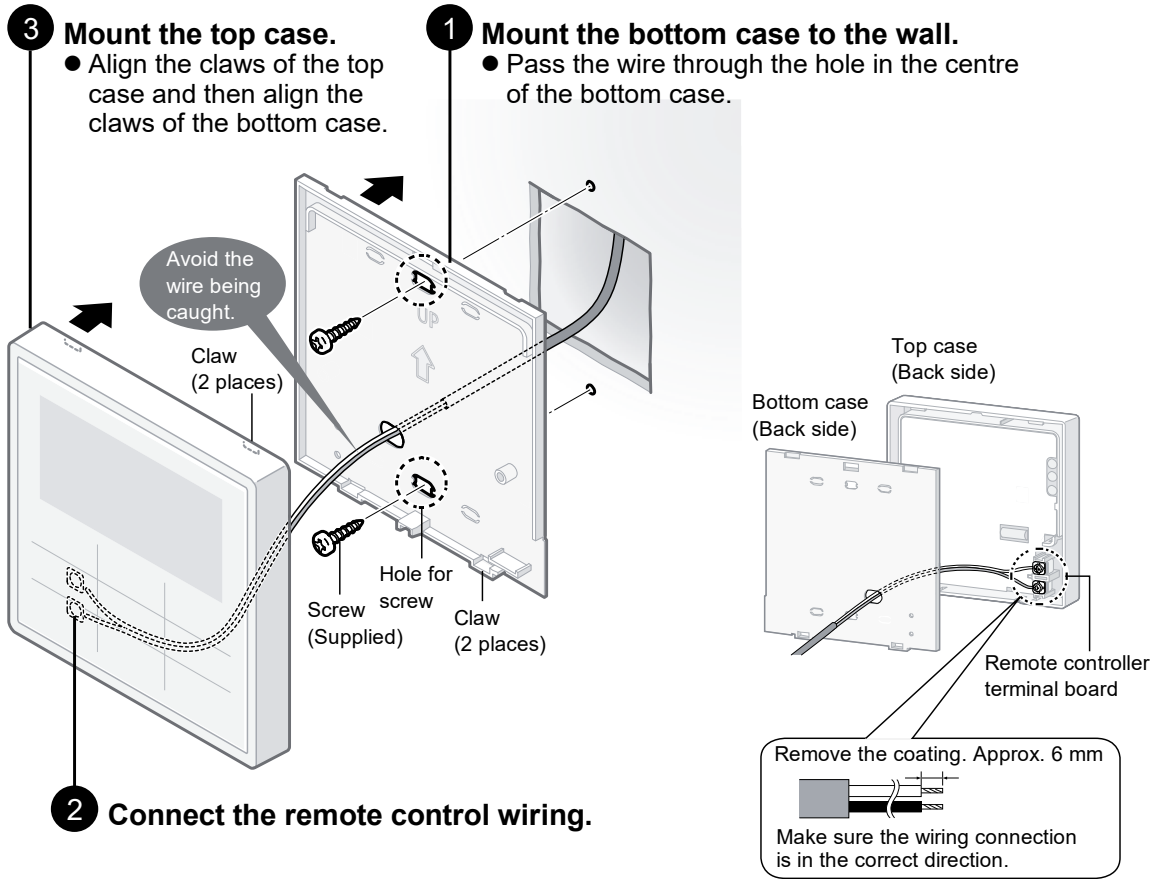

12.2.2.5 Setting

Preparation:

Turn on the circuit breaker of units and then turn the power on. The remote controller starts, and wait until the [Assigning] display disappears.
(If [Assigning] continues to blink for 10 minutes or more, check the address setting of indoor units.)

Note

To return to the previous screen



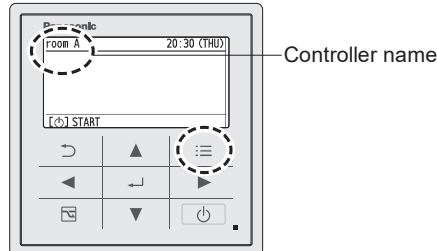

Press .

■ Language ■ Clock ■ Controller name





1 Press .



2 Select [Initial settings].

3 Select the item to set.

   

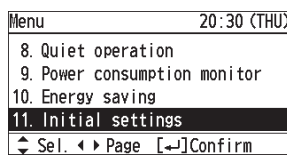

Language

4 Set.

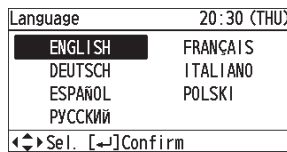

Default setting : English

Clock

4 Set.

(Repeat)

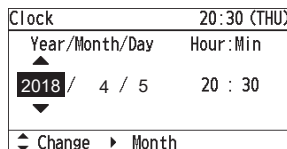

Controller name

4 Set.





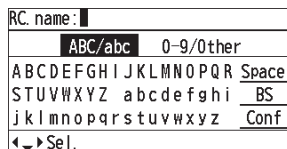

(Repeat the same procedure for all characters.)







• Up to 16 characters
(Space is included in the number of characters.)





■ To change the character type

Select the character type with     and press .

■ To delete 1 character

Select [BS] with     and press .

■ To enter space

Select [Space] with     and press .

5 Select [Conf].

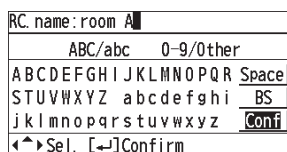

■ Service contact

- 1 Press and hold the 3 buttons for 4 seconds or more simultaneously.

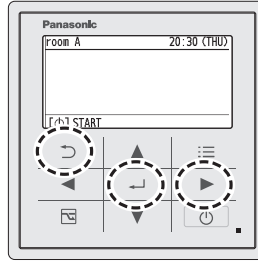

- 2 Select the item to set.

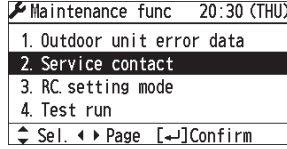
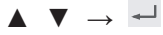

Service contact

- 3 Select. (Name)

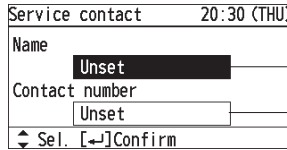

Name

Contact number

- 4 ▲ ▼ ◀ ▶ → [↔]
(Repeat the same procedure for all characters.)

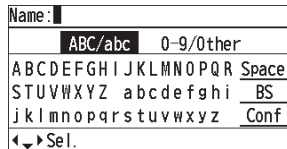

• Up to 16 characters
(Space is included in the number of characters.)

■ To change the character type

Select the character type with ▲ ▼ ◀ ▶ and press [↔].

■ To delete 1 character

Select [BS] with ▲ ▼ ◀ ▶ and press [↔].

■ To enter space

Select [Space] with ▲ ▼ ◀ ▶ and press [↔].

- 5 Select [Conf].

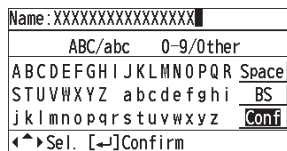

- 6 Select on the screen for step 3.
(Contact number)

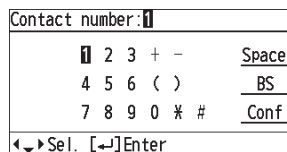

• Up to 16 characters
(Space is included in the number of characters.)

- 7 ▲ ▼ ◀ ▶ → [↔]
(Repeat the same procedure for all characters.)

- 8 Select [Conf].

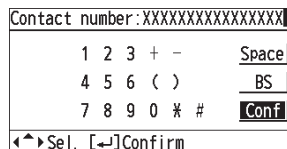

■ RC. setting mode ■ Detailed settings ■ Auto address ■ Set elec. consumption

1 Press and hold the 3 buttons for 4 seconds or more simultaneously.

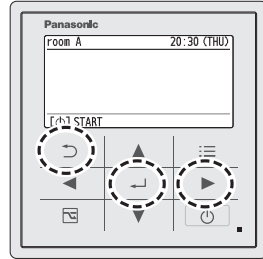

2 Select the item to set.



Maintenance func 20:30 (THU)	
1. Outdoor unit error data	
2. Service contact	
3. RC. setting mode	
4. Test run	
Sel. ◀ ▶ Page [↔] Confirm	

RC. setting mode

3 Set.
(Select the Code no. and Set data.)

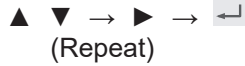

(Repeat)

4 Press

- After Selecting [YES], the unit restarts.

RC. setting mode 20:30 (THU)	
Code no.	Set data
01	0001
Sel. ▶ Next	
Code no.	Set data

Code no.			Set data
01	Main/sub	Set this when using 2 remote controllers.	<ul style="list-style-type: none"> • 0000: Sub • 0001: Main (factory setting)
02	Clock type	Set the type of clock display.	<ul style="list-style-type: none"> • 0000: 24 hours • 0001: 12 hours (AM/PM)
2F	Password change	Set the administrator password.	<ul style="list-style-type: none"> • 0000 to 9999 • 0000 (factory setting)
36	Display of operation lock cancelling method	Set whether to display the operation lock cancelling method on the lock screen while operation is locked. (For the lock screen, see the "Part Names" section in the Operating Instructions.)	<ul style="list-style-type: none"> • 0000: Displayed (factory setting) • 0001: Not displayed • 0002: Not displayed (password)

Detailed settings

3 Set.
(Select the indoor unit number, Code no. and Set data.)

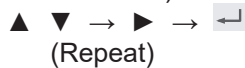

(Repeat)

4 Press

- After Selecting [YES], the unit restarts.

Detailed settings 20:30 (THU)		
Unit no.	Code no.	Set data
1-1	10	0001
Sel. ▶ Next		
Indoor unit number	Code no.	Set data

Code no.			Set data
31	Vent output setting	Set this when connecting a commercially sold fan, etc. to the ventilation fan output "FAN DRIVE:2P (White)" on the indoor control board. *Dedicated cables (optional) are required.	<ul style="list-style-type: none"> • 0000: Not connected • 0001: Connected
32	Temp sensor setting	Set this when measuring the room temperature with the room temperature sensor of the remote controller. <ul style="list-style-type: none"> • When using the main and sub controllers, the main one is enabled. • When using with the remote sensor in combination, set the indoor unit setting data. • This setting is not available during group-controlling. 	<ul style="list-style-type: none"> • 0000: Indoor unit • 0001: Remote controller
33	Temp display setting	Set the type of temperature display.	<ul style="list-style-type: none"> • 0000: °C • 0001: °F

Auto address

- 3 **Set.**
(Select the Code no. [A1] and O/D unit no.)

▲ ▼ → ▶ → ↵

(Repeat)

- 4 **Press** ↻

- After Selecting [YES], the unit restarts.

Auto address		20:30 (THU)
Code no.	O/D unit no.	
A1	1	
↕ Sel.	▶ Next	
Code no.	O/D unit no.	

Code no.		O/D unit no.
A1	Set the Auto address for each O/D unit no. Select the O/D unit no. (outdoor unit) for Auto address.	<ul style="list-style-type: none"> • Outdoor unit number

Attention

- Set Auto address after all units are turned on and 90 seconds or more have passed.
- Operate the units after Auto address is set and 90 seconds or more have passed.

Set elec. consumption

- 3 **Set.**
(Select the power supply voltage of outdoor units.)

▲ ▼ → ▶ → ↵

- 4 **Select [YES].**

Set elec. consump.		20:30 (THU)
Set voltage		
230 V		
↕ Sel.	[↵] Confirm	

Note

- Set the power supply voltage of outdoor units to calculate electric consumption of the Power consumption monitor.
- If the setting differs from the power supply voltage of outdoor units, the electric consumption value of the Power consumption monitor will differ from the actual calculation result by a power meter.
- Depending on the outdoor unit model, this cannot be set.

When 3-phase model connections are used for outdoor units

Power supply voltage	Setting value
380 V	220 V
400 V	230 V
415 V	240 V

12.2.2.6 Confirming Information

■ Sensor info. ■ Service check

- 1 Press and hold the 3 buttons for 4 seconds or more simultaneously.

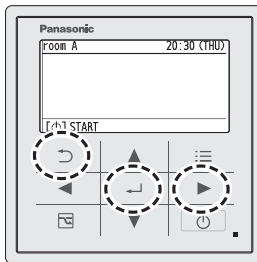

- 2 Select the item to set.



✓ Maintenance func	20:30 (THU)
2. Service contact	
3. RC setting mode	
4. Test run	
5. Sensor info.	
↔ Sel. ▶ Page [↔] Confirm	

Sensor info.

This displays each sensor temperature of the remote controller, indoor units.

- 3 Select.

(Select the unit number.)



Sensor info.		20:30 (THU)
Unit no.	Code no.	Data
▲	00	0026
1- 1	01	0028
▼	02	0026
↔ Sel.	▶ Next	

- 4 Confirm the content.



- Pressing will return to the Maintenance func screen.

Sensor info.		20:30 (THU)
Unit no.	Code no.	Data
1- 1	00	0026
	01	0028
	02	0026
↔ Scroll		

Service check

This displays the alarm history.

- 3 Confirm the content.



Service check		20:30 (THU)
	Unit no.	Alarm
1	1- 1	E04
2	1- 5	F10
3	1- 2	P01
▼ Check	[↔] Delete	

Information of 4 errors is displayed.

[--] shows that no error has occurred.

- Pressing will return to the Maintenance func screen.
- To delete the error history, press and select [YES].

12.2.2.7 Test Operation

- 1 Press and hold the 3 buttons for 4 seconds or more simultaneously.



- 2 Select [Test run].

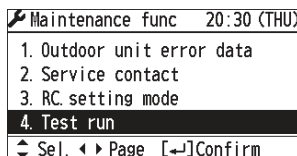
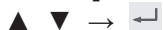

- 3 Select [ON].

(The unit enters the test operation mode. Then, [TEST] turns on.)

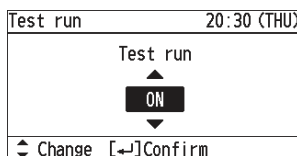

Press .

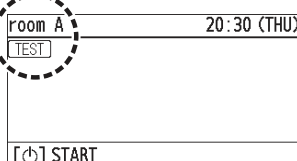
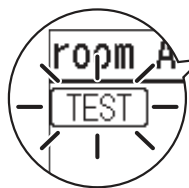

- 4 Perform the test operation.

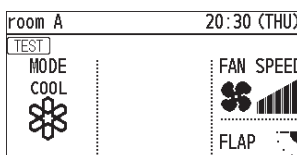

- 5 Finish the test operation.

Perform step 1 and 2, and then select [OFF] in step 3. ([TEST] display disappears.)

- The test operation can be performed in Heat or Cool mode.
- Temperature cannot be changed.
- The test operation mode is automatically turned off in 60 minutes. (To prevent continuous test operation)
- Outdoor units do not operate for approx. 3 minutes after the power is turned on or operation is stopped.

Attention

- Do not use this mode for purposes other than the test operation. (To prevent overload of the units)
- Read the installation instructions supplied with the units.

12.2.3 CZ-RTC6 Series

12.2.3.1 Installation Location

- Install at the height of 1 to 1.5 m from the floor (Location where average room temperature can be detected).
- Install vertically against a wall or suitable supporting structure.
- Keep a space around the remote controller as detailed on the figure shown left.
- Avoid the following locations for installation.
 - By a window, etc. exposed to direct sunlight or external airflow
 - In the shadow or backside of objects deviated from the room airflow
 - Location where condensation occurs (The remote controller is not moisture proof or drip proof)
 - Location near heat source
 - Uneven surface
- Keep distance of 1 m or more from the TV, radio and PC. (Image blur or related noise may occur)

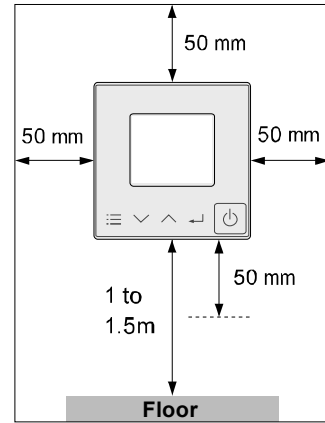

12.2.3.2 Remote Control Wiring

Wiring diagram

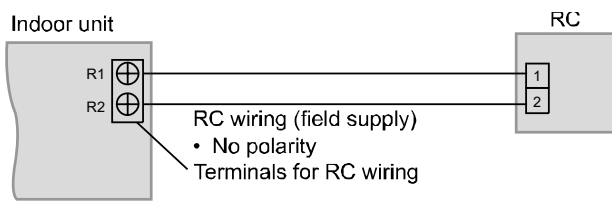

- Type of wiring
 - Use cables of 0.75 to 1.25 mm².
- Total wire length: 500 m or less (The wire length between indoor units should be 200 m or less.)
- Number of connectable units
 - Remote controller: Max. 2
 - Indoor unit: Max. 8

Attention

- Use the field supplied RC wiring with at least 1 mm in thickness of insulation part including the sheath. Wiring Regulations may differ depending on location. For field wiring rules, please refer to your LOCAL ELECTRICAL CODES. You must ensure that installation complies with relevant rules and regulations.
- Be careful not to connect cables to other terminals of indoor units (e.g. power source wiring terminal). Malfunction may occur.
- Do not bundle together with the power source wiring or store in the same metal tube. Operation error may occur.
- If noise is induced to the unit power supply, attach a noise filter.

Using 1 indoor unit

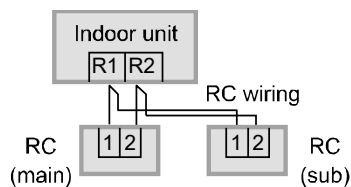

Wiring as shown below is prohibited.

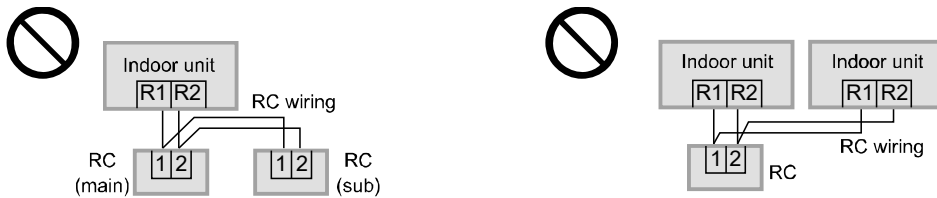

When setting both the main and sub remote controllers

Regarding the contents of the installation, please scan the matrix two-dimensional (2D) barcode and refer to the detailed manuals.

After installation, set one remote controller to [Main] and the other to [Sub] for [Main/sub] for “Setting”.

When using the remote controllers* in combination, set the CZ-RTC6 unit to [Sub].

*CZ-RTC5B

Note

Remote controllers can be connected to any indoor unit for operation.

12.2.3.3 Mounting

1. Remove the top case.

- **Insert the screwdriver to the bottom case.**
Insert the flat-blade screwdriver to the claws as show in the figure.

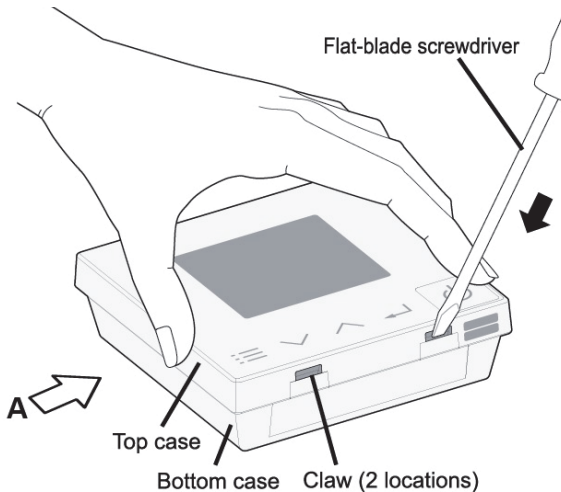

- **Push the flat-blade screwdriver in.**
Push down the flat-blade screwdriver along with the slope of the claws until the top case comes off .

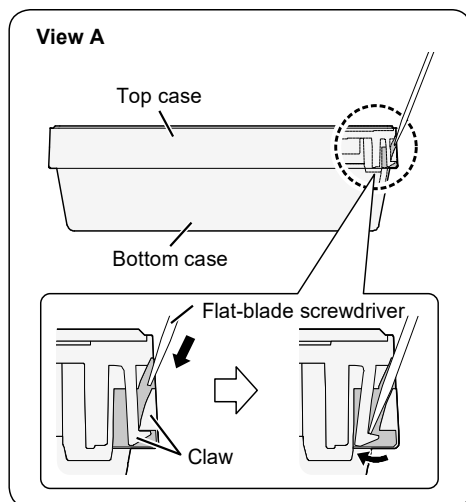

2. Mount to the wall.

There are 2 types of wall-mounting methods: Exposed type and Embedded type.

Attention

Mounting the bottom case

- Tighten the screws securely until the screw heads touch the bottom case. (Otherwise, loose screw heads may hit the PCB and cause malfunction when mounting the top case.)
- Do not over-tighten the screws. (The bottom case may be deformed, resulting in the unit becoming detached from the surface it is fixed to.)

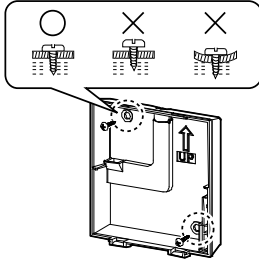

Connection to the remote controller terminal board

- Depress the push button using a round bar or finger, insert the remote control wiring securely from the wiring insertion slot and release the push button.
- Pull the remote control wiring lightly, and confirm it is secured.
- There is the danger of shorting if copper wire is exposed. Make sure the wire is properly inserted.

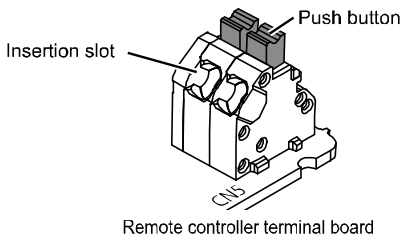

12.2.3.4 Exposed Type

A protective film is attached on the Control panel.

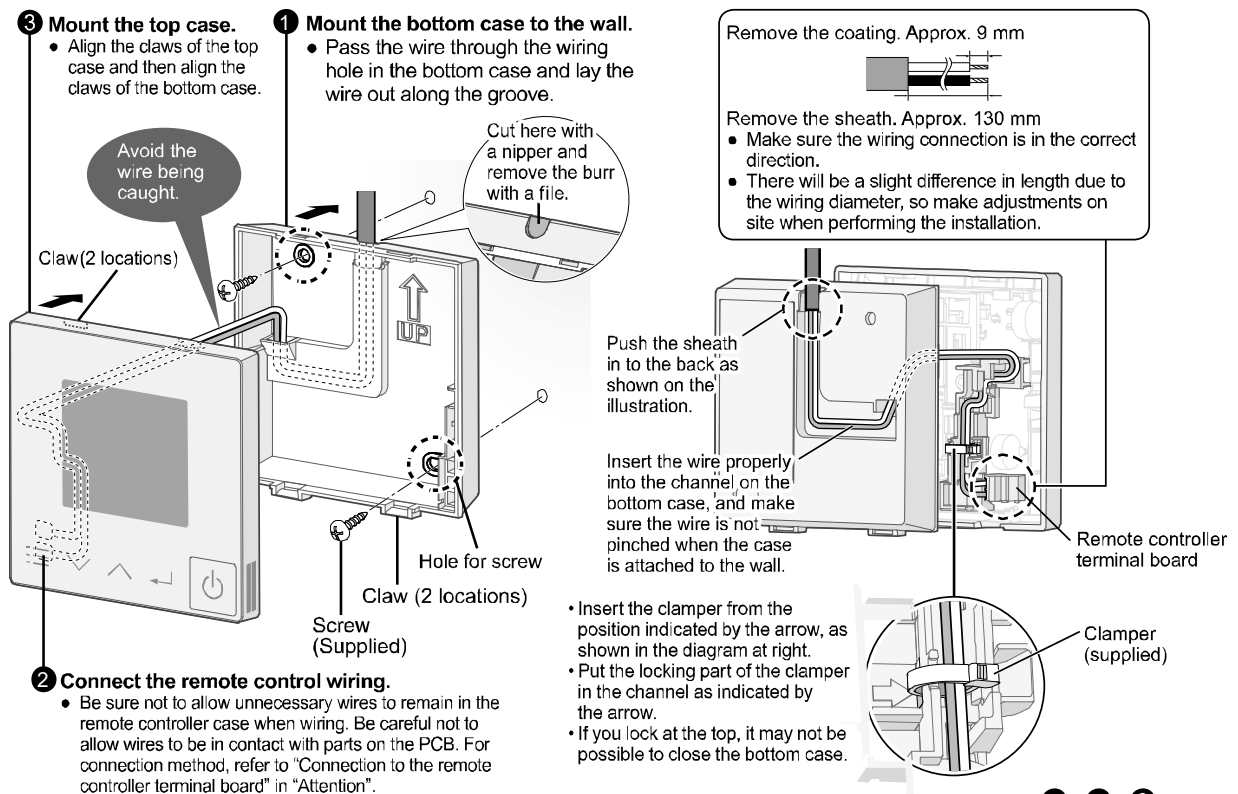

*It is also possible to mount in the order 2 → 1 → 3.

12.2.3.5 Embedded Type

A protective film is attached on the Control panel.

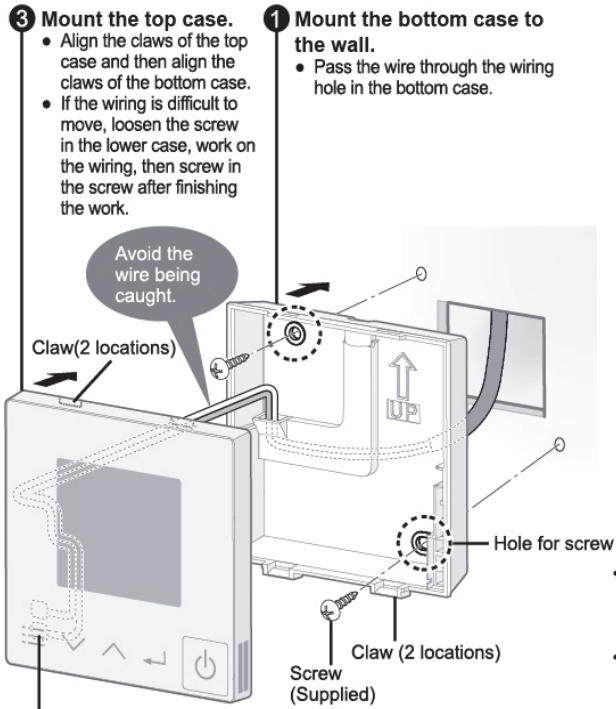

- 2** Connect the remote control wiring.
- Be sure not to allow unnecessary wires to remain in the remote controller case when wiring. Be careful not to allow wires to be in contact with parts on the PCB. For connection method, refer to "Connection to the remote controller terminal board" in "Attention".

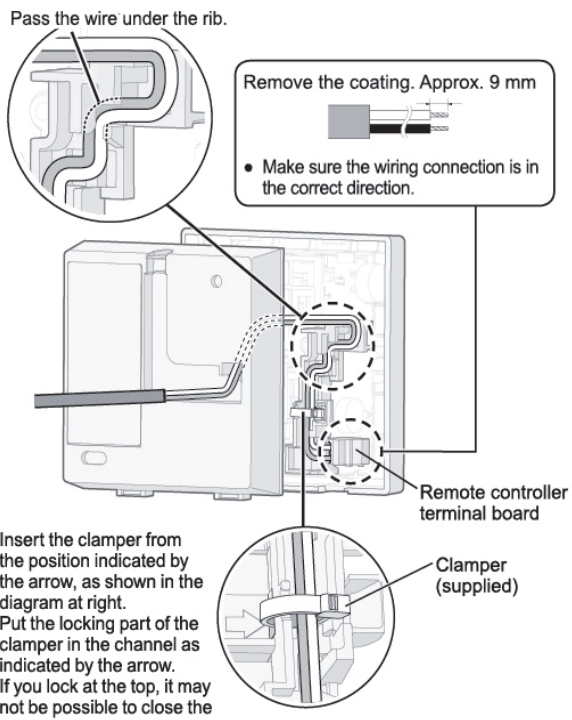

*It is also possible to mount in the order **2**→**1**→**3**.

12.3 Operation Instructions

12.3.1 Wired Remote Control (Optional part)

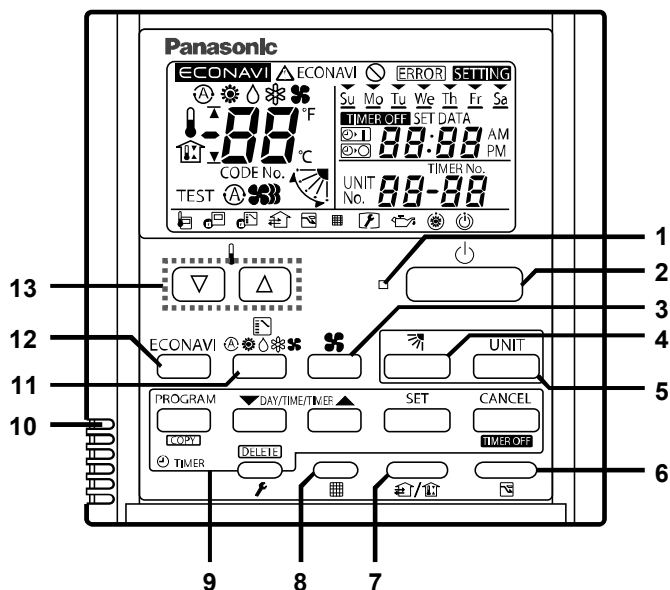

1 Operation indicator

Illuminates during operation. Blinks during alarm.

2 Start/Stop button

Starts/Stops operation.

3 Fan speed

Changing the fan speed.

4 Swing/Air direction

Use this button to set the auto swing or air direction to a specific angle.

5 Unit select

When more than one indoor unit is operated by one remote control unit, this button is used to select a unit when adjusting the air direction.

6 Sleeping

7 Ventilation

Use this button when you installed a fan available in the market. Pressing this button turns on and off the fan. When turning off the air conditioner, the fan will be also turned off.

8 Filter reset

Use this button to reset the filter sign. When  is displayed, press this button after cleaning the filter.

9 Timer setting buttons

10 Remote control sensor

Normally, the temperature sensor of the indoor unit is used to detect the temperature. However, it is also possible to detect the temperature around the remote control unit.

11 Mode select

Pushing this button selects an operation mode.

12 ECONAVI

Use this button to turn on/off the ECONAVI Function.

13 Temperature setting buttons

Changing the temperature setting.

12.3.1.1 CZ-RTC5B

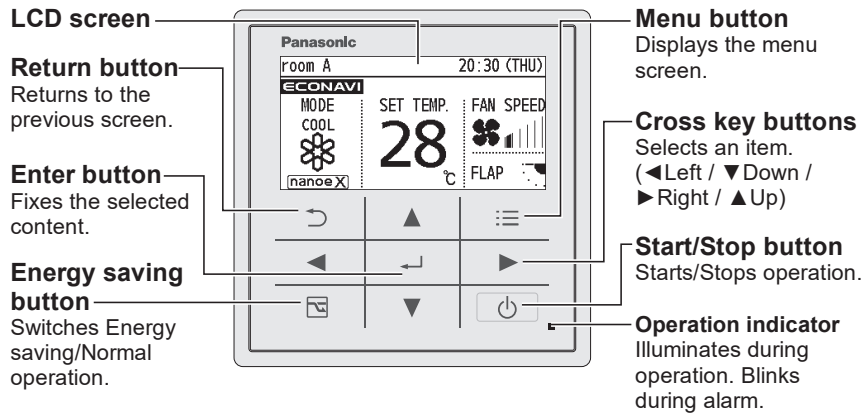

12.3.1.2 CZ-RTC6 Series

■ When stopped

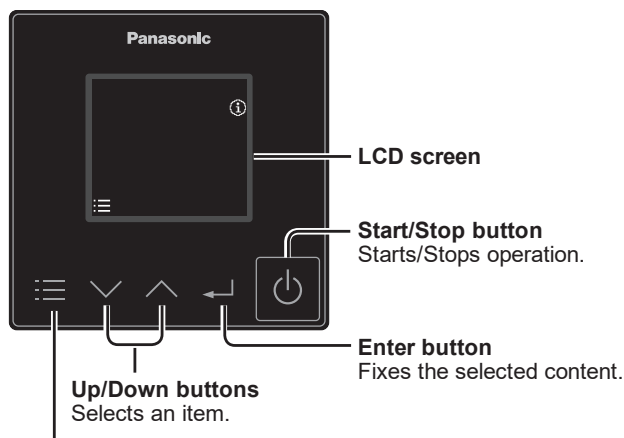

■ When operating

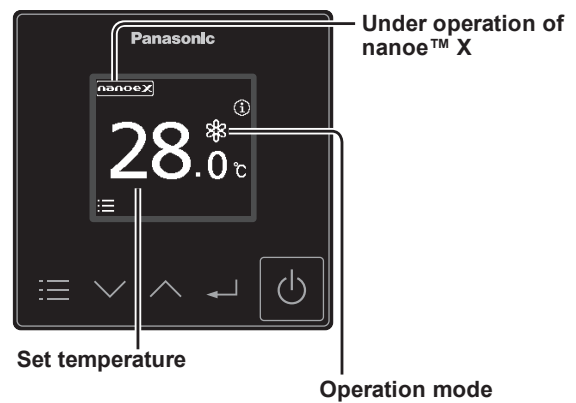

Menu button

- When pressed repeatedly during operation, this shows operating status confirmation, set temperature, operation mode, fan speed, flap, and the menu screen.
- When pressed while stopped, the menu screen is displayed.

13. Installation Instruction (CU-2WZ71YBE5)

13.1 Installation Information

13.1.1 Check Points

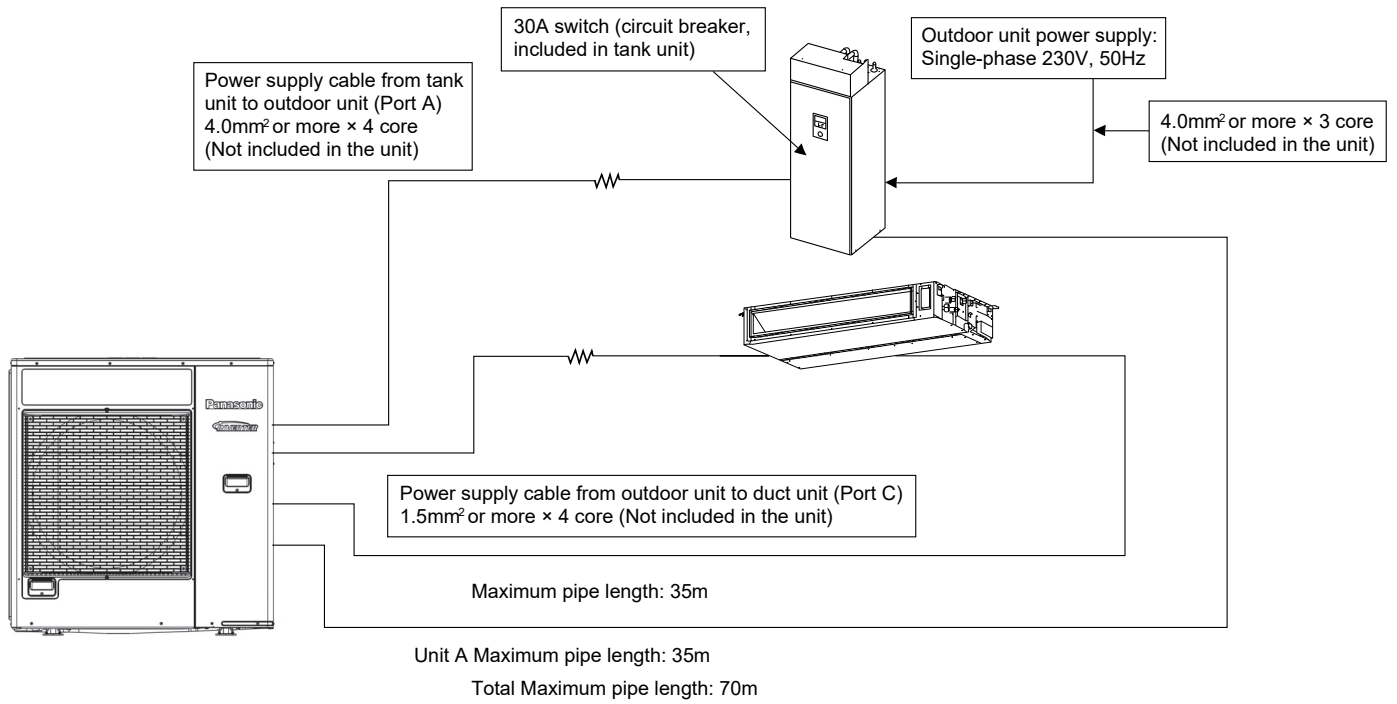

13.2 Select The Best Location

13.2.1 Outdoor Unit

- If an awning is built over the unit to prevent direct sunlight or rain, be careful that heat radiation from the condenser is not obstructed.
- There should not be any animal or plant which could be affected by hot air discharged.
- Keep the spaces indicated by arrows from wall, ceiling, fence or other obstacles.
- Do not place any obstacles which may cause a short circuit of the discharged air.

Refrigerant piping size	
Outdoor Unit	CU-2WZ71****
Liquid - side	ø 6.35 t0.8
Gas - side	ø 12.7 t0.8

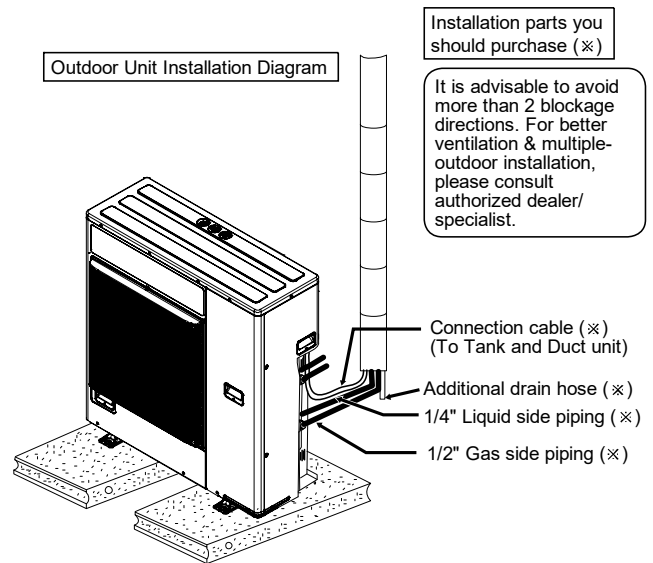

- This illustration is for explanation purposes only.
- * Note:
Respective indoor unit installation procedure shall refer to instruction manual provided in the indoor unit packaging.

Refrigerant Amount and Allowable Piping Length			
Outdoor Unit		CU-2WZ71****	
Pre-charged refrigerant		2.4 kg	
Maximum total piping length for additional gas		30 m	
Additional refrigerant		20 g/m	
Rated length (m)	Indoor - Duct unit		5 m
	Indoor - Tank unit		5 m
Allowable piping length of each indoor unit (min-max)		3 m ~ 35 m	
Allowable total piping length of all indoor unit		70 m or less	
Height difference between indoor and outdoor unit	Outdoor unit located on upper side	(a)	30 m or less
	Outdoor unit located otherwise	(b)	15 m or less
Height difference between indoor and outdoor unit	Outdoor unit located on upper side	(c)	15 m or less
	Outdoor unit located otherwise	(d)	30 m or less

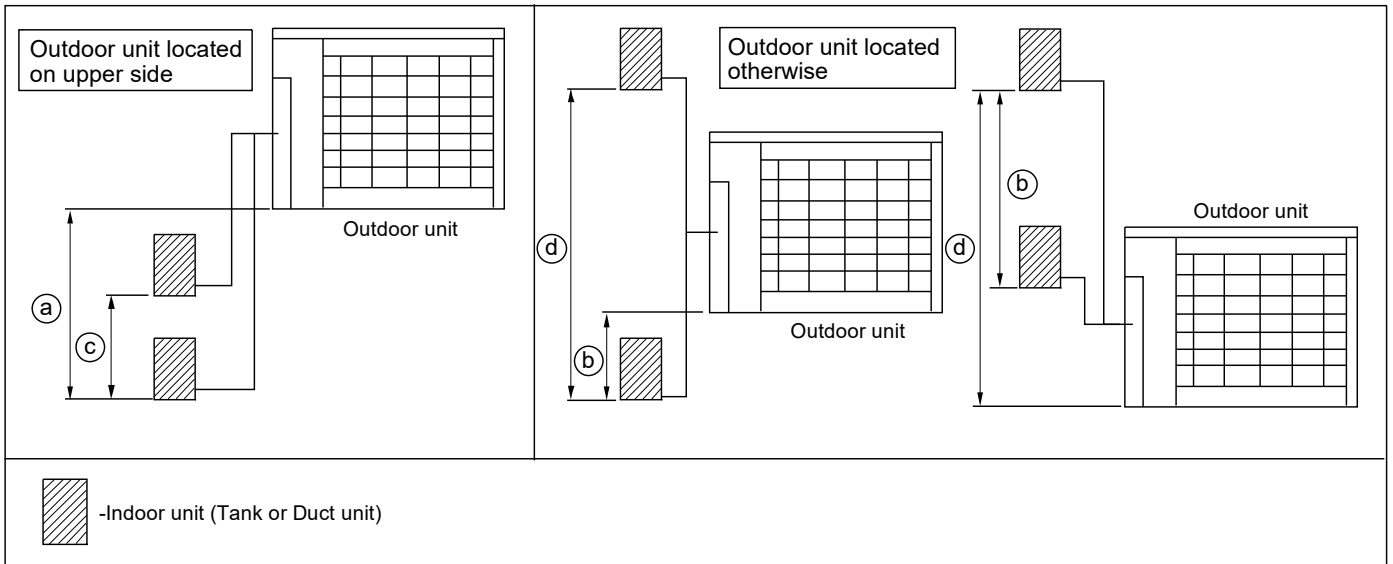

Outdoor Unit Installation Guidelines

- Where a wall or other obstacle is in the path of outdoor unit's intake or exhaust airflow, follow the installation guidelines below.
- For any of the below installation patterns, the wall height on the exhaust side should be 1200 mm or less.

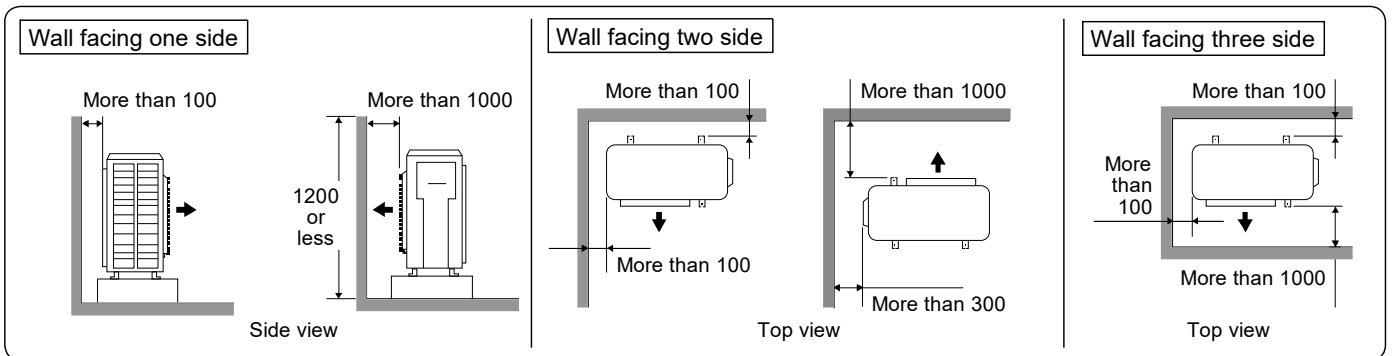

Unit : mm

13.3 Install The Outdoor Unit

- After selecting the best location, start installation to Indoor/Outdoor Unit Installation Diagram.
 1. Fix the unit on concrete or rigid frame firmly and horizontally by bolt nut ($\phi 10$ mm).
 2. When installing at roof, please consider strong wind and earthquake. Please fasten the installation stand firmly with bolt or nails.

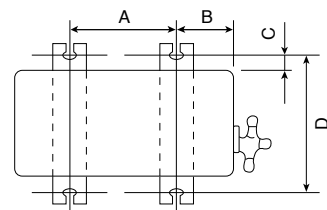

Model	A	B	C	D
CU-2WZ71****	620 mm	170 mm	20 mm	380.5 mm

13.4 Connect The Piping

- Remove the cabinet side plate (metal) from the unit by loosening six screws.

Connecting The Piping To Outdoor Unit

Decide piping length and then cut by using pipe cutter. Remove burrs from cut edge. Make flare after inserting the flare nut (locate at valve) onto the copper pipe.

Align center of piping to valves and then tighten with torque wrench to the specified torque as stated in the table.

Do not over tighten, overtightening may cause gas leakage.	
Piping size	Torque
1/4" (6.35 mm)	[18 N•m (1.8 kgf•m)]
3/8" (9.52 mm)	[42 N•m (4.3 kgf•m)]
1/2" (12.7 mm)	[55 N•m (5.6 kgf•m)]
5/8" (15.88 mm)	[65 N•m (6.6 kgf•m)]
3/4" (19.05 mm)	[100 N•m (10.2 kgf•m)]

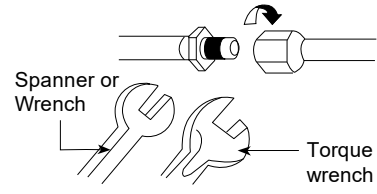

Be sure to use two spanners to tighten.
(If the nuts are overtightened, it may cause the flares to break or leak.)

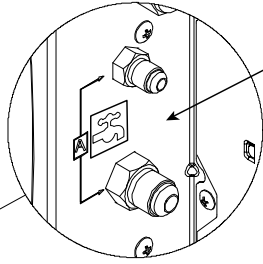
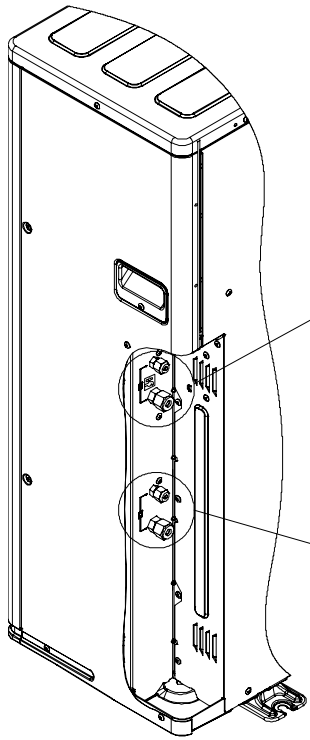

Piping connection A for Tank unit

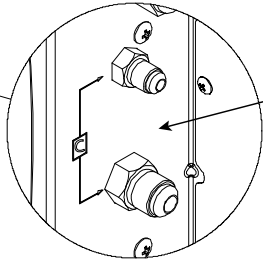
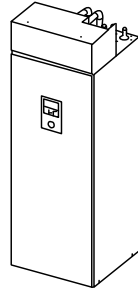

Piping connection C for Duct unit



13.5 Air Tightness Test on the Refrigerating System

⊘ Do not purge the air with refrigerants but use a vacuum pump to vacuum the installation.

⚠ There is no extra refrigerant in the outdoor unit for air purging.

⚠ Air evacuation and tightness test shall be carried out separately for Tank unit and Duct unit piping connection with respective 3-way valve (shown below).

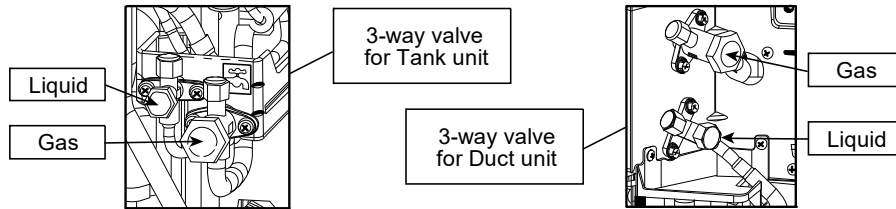

⚠ Additional gas charging shall be carried out only in cooling mode of Duct unit and Tank unit must be in off condition.

- Before system is charged with refrigerant and before the refrigerating system is put into operation, below site test procedure and acceptance criteria shall be verified by the certified technicians, and/or the installer.
- Be sure to check whole system for gas leakage.

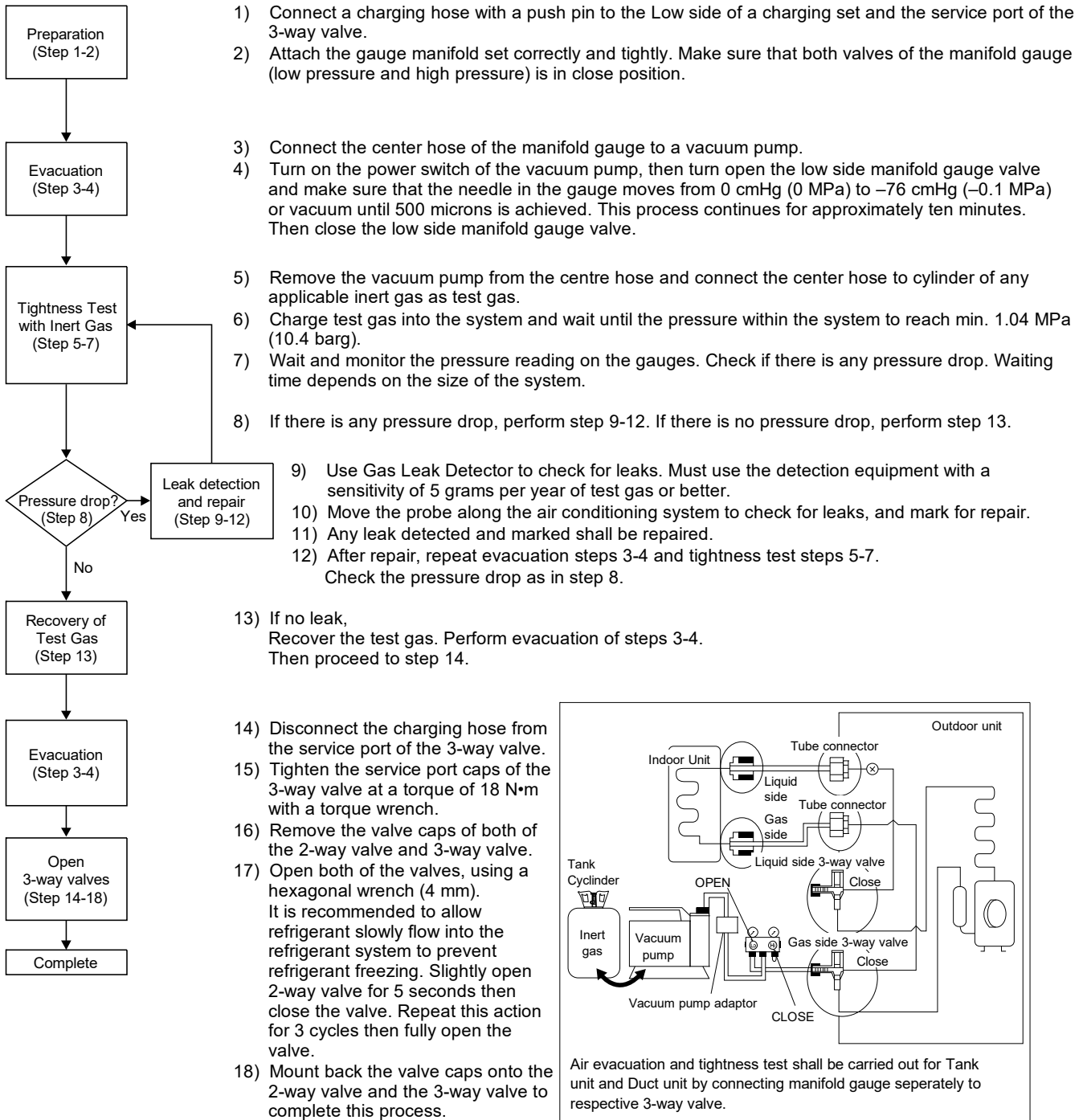

Notes:

Recommended use of any of the following leak detector,

- I) Universal Sniffer leak detector
- II) Electronic halogen leak detector
- III) Ultrasonic Leak Detector

13.6 Connect The Cable To The Outdoor Unit

1. Remove the Particular plate from the unit by loosening the two screws.
2. Connecting cable between all units shall be approved polychloroprene sheathed flexible cable, type designation 60245 IEC 57 or heavier cable. Other detail shall refer to table below:

Cable Connection	Connecting Cable Size	length (max)
Outdoor unit to Tank unit	4 x 4.0 mm ²	40 m
Outdoor unit to Duct unit	4 x 1.5 mm ²	40 m

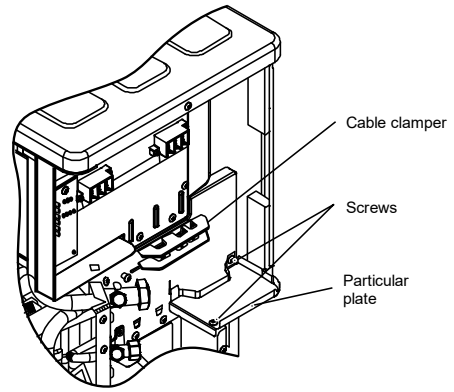

3. Connection cable between outdoor unit and indoor unit according to the diagram as shown.

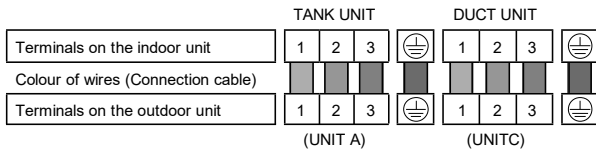

4. Secure the cable onto the control board with the cable clammer.
5. Attach the particular plate back to the original position with screw.

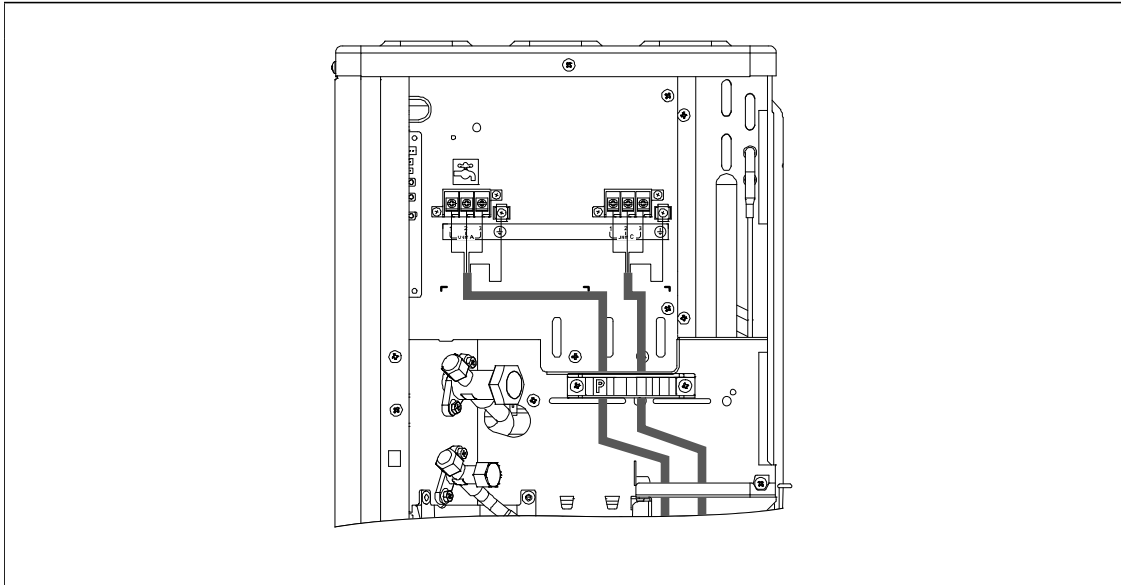

6. For wire stripping and connection requirement, refer to the diagram below.
7. Secure the power supply cord and connecting cables onto the control board with the holder.
8. Attach the control board cover back to the original position with screw.

WIRE STRIPPING AND CONNECTING REQUIREMENT

Wire stripping

10 ± 1 mm

No loose strand when inserted

Indoor/outdoor connecting terminal board

5 mm or more (gap between wires)

Conductor fully inserted

ACCEPT

Conductor over inserted

PROHIBITED

Conductor not fully inserted

PROHIBITED

⚡ This equipment must be properly earthed.

- Note: Isolating Devices (Disconnecting means) should have minimum 3.0 mm contact gap.
- Earth wire shall be Yellow/Green (Y/G) in colour and longer than other AC wires for safety reason.

13.7 Heat Insulation

1. Please carry out insulation at pipe connection portion as mentioned in Indoor/Outdoor Unit Installation Diagram. Please wrap the insulated piping end to prevent water from going inside the piping.
2. If drain hose or connecting piping is in the room (where dew may form), please increase the insulation by using POLY-E FOAM with thickness 6 mm or above.

!	Refrigerant tubing shall be protected against mechanical damage.
----------	--

⚠ CAUTION	Use a material with good heat-resistant properties as the heat insulation for the pipes. Be sure to insulate both the gas-side and liquid-side pipes. If the pipes are not adequately insulated, condensation or water leakages may occur.
------------------	--

Liquid-side pipes	Material shall withstand 120 °C or higher
Gas-side pipes	

13.7.1 Disposal Of Outdoor Unit Drain Water

- If a drain elbow is used, the unit should be placed on a stand which is taller than 5 cm.
- If the unit is used in an area where temperature falls below 0 °C for 2 or 3 days in succession, it is recommended not to use a drain elbow, for the drain water freezes and the fan will not rotate.

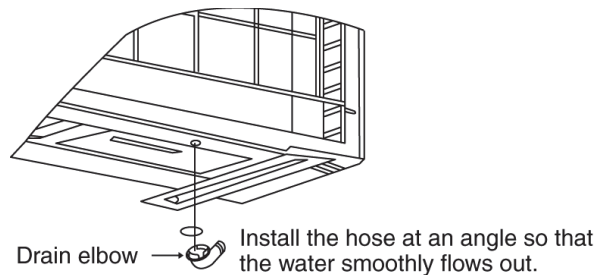

13.7.2 Pump Down Operation

- Operate the pump down according to the following procedures.
 1. Confirm all the 4pcs of 3-way valve on liquid and gas side are open.
 2. Connect pressure gauge to gas side of 3-way valve for Duct unit (recommended).
 3. Press PUMP DOWN switch (SW1) on the display printed circuit board for more than 5 seconds. Pump down (cooling) operation is performed for 15 minutes.
 4. Set the liquid side 3-way valve for Tank unit to close position followed by liquid side 3-ways valve for Duct unit and wait until the pressure gauge indicates 0.01 MPa (0.1 kg/cm²G).
 5. Immediately set the gas side 3-way valve for Tank unit to close position followed by gas side 3-way valve for Duct unit and then press the PUMP DOWN switch (SW1) to stop the pump down operation.

Note: Pump down operation will stop automatically after 15 minutes if PUMP DOWN switch (SW1) is not pressed again.
Pump down operation is not started within 3 minutes after compressor is stopped.

LED	2	3	4	5	Message
Status	○	○	○	○	Pump down operation progress
	○	○	○		3 minutes before operation end
	○	○			2 minutes before operation end
	○				1 minute before operation end
					Pump down operation end

○: Flashing

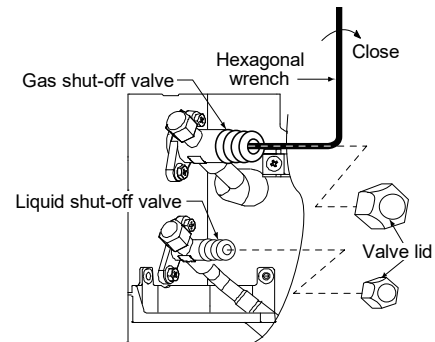

13.7.3 Cooling only Operation

- Setting of Cooling only operation (Duct unit).

The Duct unit can be set to cooling only operation by setting the JP line on the outdoor unit display circuit board.

[Setting method]

Switch off power supply to the outdoor unit, cut JP1 (COOL ONLY) as shown in Figure 1.

After cut off the wire, switch ON the equipment power.

When setting the cooling only operation, Heating operation of Duct unit is disabled.

ODOUR WASH operation is disabled. (Odour cut operation is still enabled.)

To revert back the setting to heat pump operation, switch OFF the equipment power, reconnect JP1 (COOL ONLY) back to short circuit condition and switch ON the equipment power.

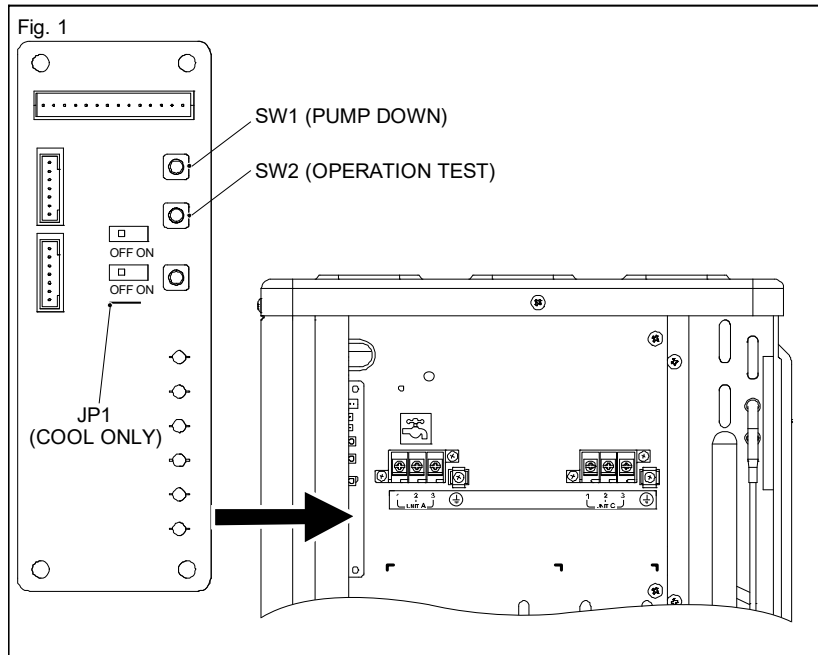

13.7.4 In Case of Reusing Existing Refrigerant Piping

- Observe the followings to decide reusing the existing refrigerant piping.
 - Poor refrigerant piping could result in product failure.
- In the circumstances listed below, do not reuse any refrigerant piping. Instead, make sure to install a new piping.
 - Heat insulation is not provided for either liquid-side or gas-side piping or both.
 - The existing refrigerant pipe has been left in an open condition.
 - The diameter and thickness of the existing refrigerant piping does not meet the requirement.
 - The piping length and elevation does not meet the requirement.

Perform proper pump down before reuse piping.
- In the circumstances listed below, clean it thoroughly before reuse.
 - Pump down operation cannot be performed for the existing air-conditioner.
 - The compressor has a failure history.
 - Oil color is darken. (ASTM 4.0 and above).
 - The existing air-conditioner is gas/oil heat pump type.
- Do not reuse the flare to prevent gas leak. Make sure to install a new flare.
- If there is a welded part on the existing refrigerant piping, conduct a gas leak check on the welded part.
- Replace deteriorated heat insulating material with a new one.
 - Heat insulating material is required for both liquid-side and gas-side piping.

13.7.5 Check Items

- | | |
|--|--|
| <input type="checkbox"/> Short circuit of the blow-out air | <input type="checkbox"/> Mistake in wiring |
| <input type="checkbox"/> Smooth flow of the drain | <input type="checkbox"/> Reliable connection of the grand wire |
| <input type="checkbox"/> Reliable thermal insulation | <input type="checkbox"/> Looseness in terminal screw |
| <input type="checkbox"/> Leakage of refrigerant | <input type="checkbox"/> Grounding/Earth connection |

14. Operation Control (WH-ADF0309J3E5CM)

14.1 Basic Function

Inverter control, which equipped with a microcomputer in determining the most suitable operating mode as time passes, automatically adjusts output power for maximum comfort always. In order to achieve the suitable operating mode, the microcomputer maintains the set temperature by measuring the temperature of the environment and performing temperature shifting. The compressor at outdoor unit is operating following the frequency instructed by the microcomputer at indoor unit that judging the condition according to internal water setting temperature and water outlet temperature.

14.1.1 Internal Water Setting Temperature

Once the operation starts, control panel setting temperature will be taken as base value for temperature shifting processes. These shifting processes are depending on the Air-to-Water Heat pump settings and the operation environment. The final shifted value will be used as internal water setting temperature and it is updated continuously whenever the electrical power is supplied to the unit.

14.1.2 Heating Operation

14.1.2.1 Thermostat Control

- Compressor is OFF when Water Outlet Temperature – Internal Water Setting Temperature $> 2^{\circ}\text{C}$ for continuously 3 minutes.
- Compressor is ON after waiting for 3 minutes, if the Water Outlet Temperature – Water Inlet Temperature (temperature at thermostat OFF is triggered) $< -3^{\circ}\text{C}$.

14.1.2.2 Thermostat Control (Outdoor Ambient Temperature)

Stops provide heating to room side during high outdoor ambient condition.

Control content:

- Heating operation and water pump will turn OFF when outdoor ambient temperature $>$ outdoor thermo off temperature $+ 3^{\circ}\text{C}$.
(Outdoor thermo off set temperature is set by control panel. Thermo off set temperature is between $5^{\circ}\text{C} \sim 35^{\circ}\text{C}$)
- Heating operation will resume when Outdoor ambient temperature $<$ Outdoor thermo OFF set temperature $+ 1^{\circ}\text{C}$.

14.1.2.3 Heat Mode Operation

Operation of heat pump provide heating capacity to room side by hot water through heating panel, floor heating or fan coil unit.

1. 3 ways valve control:
 - 3 ways valve switch and fix to heating side.
2. Heat pump operates follow normal heating operation.
3. Back up heater operate follow normal operation.
4. 2 ways valve control:
 - 2 ways valve opens.

14.1.3 Target Water Temperature Setting

14.1.3.1 Target Water Temperature Control of Standard System (Optional PCB not connected)

There are 2 types of temperature control selection which are Compensation and Direct.

- Temperature control type selection by installer:
 1. Compensation : W_{lo}, W_{Hi}, OD_{Lo}, OD_{Hi} can be set at installer menu.
 2. Direct : Direct Water Temperature Set
- Remote control setting by user:
 1. Compensation : Shift value $\pm 5^{\circ}\text{C}$ from the compensation curve
 2. Direct : Direct water temperature set change

*This setting only able to set when room sensor select as Water Temperature.

*Instead of water temperature, user will set target room temperature when room sensor select as Room Thermistor OR Internal Room Thermostat.

- Target water temperature is calculated as below condition.
 - Target water temperature = A (Base temperature) + B (shift temperature)

A (Base Temperature)	Compensation	Direct
	Value from the curve + User shift value set	Direct value from user setting

- B (shift temperature) value is depend on the room sensor selection at remote controller as below table:

B (Shift Temp.)	B shift value depend on the room sensor selection at remocon as table below
Sensor selection	
Water temperature	B = 0
External Room thermostat	B = 0
Internal Room thermostat & Room Thermistor	Heat Mode: B = 0 ; when Zone OFF or Zone Room Thermo OFF B = follow Heating Room Temperature PI control logic

- Maximum/minimum regulation of Target Water Temperature

	Heating
Max	55°C
Min	20°C

Compensation Type: (Operation under Heat Mode)

- The set temperature defines the parameters for the ambient (Outdoor temperature) dependent operation of the unit. The water temperature is determined automatically depending on the outdoor temperature. Default setting is the colder outdoor temperature will result in warmer water and vice versa. The user has the possibility to shift up and shift down the target water by remote control setting.

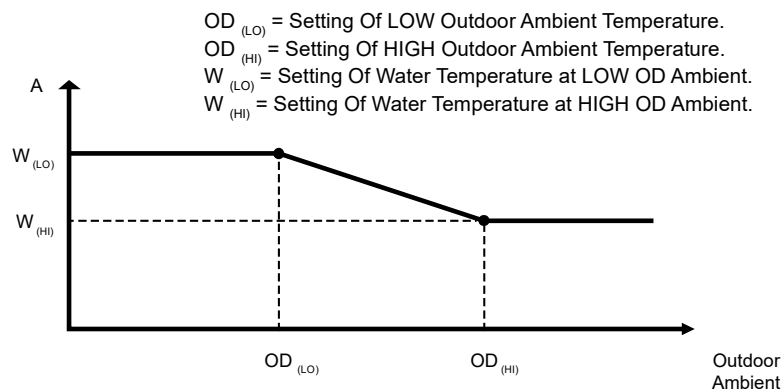

- Outdoor ambient is updated every 5 minutes when operation ON.
- Setting water outlet temperature always follow $W_{(LO)}$ or $W_{(HI)}$ whenever is higher if outdoor ambient sensor or indoor communication error happen.
- Compensation curve set shift value:

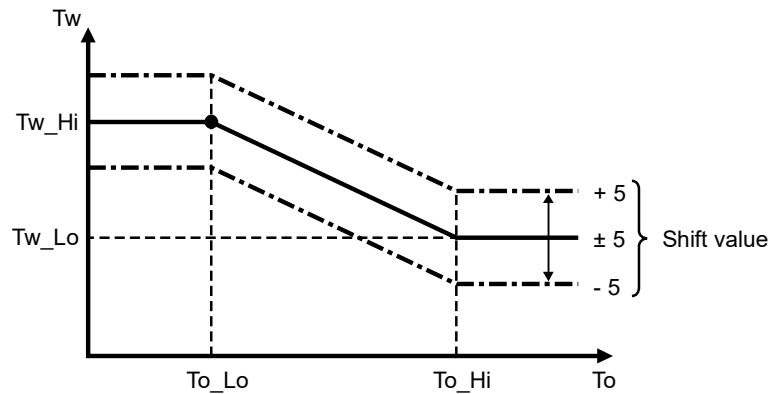

14.1.4 Target Water Temperature at Extension System (Optional PCB is connected)

Target water temperature is calculated as below.

- Heat Mode:
 - Target water temperature setting:
 - Max= 55°C Min= 20°C
- When buffer tank selection is "YES:"
 - Target water temperature = Target buffer tank temperature + [2°C]
- When buffer tank selection is "NO"
 - If both zone 1 and zone 2 is active
 - Target Water Temperature = Higher zone target water temperature of Zone 1 and Zone 2.
 - If only one zone is active
 - Target Water Temperature = Zone target water temperature of active zone.

14.1.5 Target Zone Water Temperature Control

Purpose:- To control zone mixing and zone pump according to the zone sensor temperature

14.1.5.1 Target Zone 1 water temperature setting control

- Start condition
 - Heating zone 1 is ON by remote control or Timer.
- Cancel condition
 - Heating zone 1 is OFF by remote control or Timer.
- Target Zone 1 water temperature is calculated as below condition.
 - Target Zone 1 water temperature = A (Base temperature) + B (shift temperature)

A (Base Temperature)	Compensation	Direct
	Value from the curve + User shift value set	Direct value from user setting

- B (shift temperature) value is depend on the room sensor selection at remote controller as below table:

B (Shift Temp.)	B shift value depend on the room sensor selection at remocon as table below
Sensor selection	
Water temperature	B = 0
External Room thermostat	B = 0
Internal Room thermostat & Room Thermistor	Heat Mode: B = 0 ; when Zone OFF or Zone Room Thermo OFF B = follow Heating Room Temperature PI control logic
Pool Function Selected	B = Delta value setting from remocon

* B = 0 regardless of which sensor selection, if SHP control bit is enable except Pool function select (maintain Pool "B" value)

** Pool function also can be select at Zone 1 when optional PCB is connected and Zone 1 system is select.

- Maximum/minimum regulation of Target Water Temperature.

	Heating
Max	55°C
Min	20°C

- Target Zone 1 Water Temperature (Heat mode) during SG ready control
 - If buffer tank selection is "NO" then following shift is carried out.
 - While digital input is "10" or "11" then,
Final Target Zone 1 water temperature
= Target Zone 1 water temperature* (SG ready % setting (remote control menu))%
 - If buffer tank selection is "YES"
 - No shift of Target Zone 1 Water Temperature. Target Buffer Tank Temperature will change accordingly.
* Refer to "Buffer tank temperature control"

14.1.5.2 Target Zone 2 water temperature setting control

- Start condition
 - Heating zone 2 is ON by remote control or Timer.
- Cancel condition
 - Heating zone 2 is OFF by remote control or Timer.
- Target Zone 2 water temperature is calculated as below condition.
 - Target Zone 2 water temperature = A (Base temperature) + B (shift temperature)

A (Base Temperature)	Compensation	Direct
	Value from the curve + User shift value set	Direct value from user setting

- B (shift temperature) value is depend on the room sensor selection at remote controller as below table:

B (Shift Temp.)	B shift value depend on the room sensor selection at remocon as table below
Sensor selection	
Water temperature	B = 0
External Room thermostat	B = 0
Internal Room thermostat & Room Thermistor	Heat Mode: B = 0 ; when Zone OFF or Zone Room Thermo OFF B = follow Heating Room Temperature PI control logic
Pool Function Selected	B = Delta value setting from remocon

* B = 0 regardless of which sensor selection, if SHP control bit is enable except Pool function select (maintain Pool "B" value)

** Pool function also can be select at Zone 2 when optional PCB is connected and Zone 2 system is select.

- Maximum/minimum regulation of Target Water Temperature.

	Heating
Max	55°C
Min	20°C

- Target Zone 2 Water Temperature (Heat mode) during SG ready control
 - If buffer tank selection is "NO" then following shift is carried out.
 - While digital input is "10" or "11" then,
Final Target Zone 2 water temperature
= Target Zone 2 water temperature* (SG ready % setting (remote control menu))%
 - If buffer tank selection is "YES"
 - No shift of Target Zone 2 Water Temperature. Target Buffer Tank Temperature will change accordingly.
* Refer to "Buffer tank temperature control"

14.1.5.3 Zone Temperature Control Contents

- During Standard System (Optional PCB not connected)
 - Only 1 zone temperature control is available
 - This zone room temperature is control by either one of the 4 room sensor (Room Th, Int/Ext Room Thermostat, Water temperature)
 - Target Zone Water Temperature is calculated based on selected temperature control type (Compensation or Direct) and selected room sensor. Target Water Temperature will set same as Target Zone Water Temperature
 - Target Water Temperature is the temperature for heat pump to operate refer to indoor water outlet sensor.
 - Heat pump and water pump OFF when ROOM Thermo OFF (Zone thermo OFF by Room Th or Room Thermostat).
- * There will be no zone sensor connected to zone 1 (No zone sensor error), mixing valve and zone pump will not operate.
- During Extension System (Optional PCB connected)
- * There will be no zone sensor connected to zone 1 (No zone sensor error), mixing valve and zone pump will not operate.
- During Extension System (Optional PCB connected)
- Buffer Tank connection select "NO" &
 - One zone system is select
 - This zone room temperature control by either one of the 4 room sensor (Room Th, Int/Ext Room Thermostat, Water temp.)
 - Target Zone Water Temperature calculate base on selected temperature control type (Compensation or Direct) and selected room sensor.
 - Target Water Temperature will set same as Target Zone Water Temperature
 - Target Water Temperature is a temperature for heat pump to operate refer to indoor water outlet sensor.
 - Heat pump and water pump OFF when ROOM Thermo OFF (Zone thermo OFF by Room Th or Room Thermostat).
 - * There will be no zone sensor connected to zone 1 (No zone sensor error), mixing valve and zone pump will not operate.
 - 2 zone system select
 - Each zone room temperature is control by each sensor which select from either one of the 4 room sensor
 - Target Zone 1 & 2 Water Temperature is calculated based on selected temperature control type (Compensation or Direct) and selected room sensor.
 - * Zone Mixing Valve & Zone pump will operate to achieve Target Zone Water Temperature which refer to zone sensor.
 - * Zone Sensor will detect if zone sensor is open or short.
 - Target Water Temperature will set same as the active & higher zone water temperature setting.
 - Target Water Temperature is the temperature for heat pump to operate refer to indoor water outlet sensor.
 - Heat pump and water pump OFF when ROOM Thermo OFF (Both Zone thermo OFF by Room Th or Room Thermostat).
- Buffer Tank Connection select "YES" &
 - 1 zone system or 2 zone system select
 - Each zone control by each sensor which select from either one of the 4 room sensor
 - Target Zone 1 & 2 Water Temperature calculate base on selected temperature control type (Compensation or Direct) and selected room sensor. Each zone have their own Target Zone Water Temperature.
 - * Zone Mixing Valve & Zone pump will operate to achieve each Target Zone Water Temperature which refer to zone sensor
 - * Zone Sensor will detect if zone sensor is open or short.
 - Target Buffer Tank Temperature will be set as active & higher zone water temperature setting + Buffer Delta T.
 - Target Water Temperature will set as Target Buffer Tank Temperature + [2°C] (Heating)
 - Target Water Temperature is a temperature for heat pump to operate refer to indoor water outlet sensor.
 - Heat pump and water pump OFF when ROOM thermo OFF
 - Heat mode: ROOM thermo OFF (Buffer Tank Temperature > Target Buffer Tank + [0°C])

14.1.6 Tank Mode Operation

- 3 ways valve direction
 - 3 ways valve switch to tank side during Tank Thermo ON condition. Switch 3 ways valve to room side when tank achieve Tank Thermo OFF temperature.

- Tank Thermo ON/OFF Characteristic

Tank Thermo OFF

Case 1: Internal Tank Heater is select and Tank Heater ON

- Tank temperature > Tank Set Temperature continuously for 15 seconds. **OR**
- Water outlet >75°C

- Case 2: Tank Heater OFF OR External Heater is select

- When heat pump OFF due to water thermos & Tank temperature > Tank water set temperature for continuously 20 seconds. **OR**
- Tank temperature > Tank set temperature + 1°C for continuously 20 seconds.

Tank Thermo ON

Case 1: Tank Heater ON (Internal Tank Heater)

- Tank temperature < Tank set temperature + R/C (Tank re-heat temperature) AND Tank temperature < 50°C

Case 2: Tank Heater OFF (Internal Tank Heater)

- Tank temperature < Tank water set temperature + R/C (Tank re-heat temperature)

Case 3: Heat pump operate in cool mode by other indoor unit.

- Tank temperature < Tank set temperature or 43°C whichever lower.

* When tank thermo ON, water pump will ON for 3 minutes then only heat pump turn ON.

* Tank water set temperature = tank set temperature or 51°C whichever lower.

- 2 ways valve close
- Heat pump Thermostat Characteristic
 - Heat pump Water Outlet set temperature is set to below table:

Outdoor ambient temperature	Heat pump target water outlet temperature
< -5°C	53°C
> -5°C	56°C

Characteristic of heat pump thermos ON/OFF under tank mode condition:

Water Outlet Thermo Condition

- Heat pump thermos OFF temperature:
 1. Heat pump thermo OFF temperature = Target Water outlet temperature + (3°C)
 2. Water outlet temperature > heat pump thermo OFF temperature for continuously 3 minutes, heat pump OFF but water pump continue ON.
- Heat pump thermo ON temperature
 1. Heat pump thermo ON temperature = water inlet during thermo OFF time + [-3°C]
 2. When water outlet temperature < heat pump thermo ON temperature, heat pump ON.

Water inlet thermo protection condition

- Heat pump thermo OFF temperature:
 1. Water inlet temperature > [55°C/53°C] for continuously 30 seconds, heat pump OFF, water pump continue ON.
- Heat pump thermo ON temperature:
 1. Heat pump thermos ON temp = water inlet temperature < [55°C/53°C].

Outdoor ambient temperature	Water inlet temperature
< -5°C	53°C
> -5°C	55°C

Thermo ON/OFF for Heat Pump in Tank Operation:

When tank temperature achieve heat pump OFF condition, refer below condition:

Conditon 1 : Tank Heater ON (Internal Tank Heater)

- Heat pump will turn OFF, water pump continue ON and room heater will continue ON if tank temperature below tank heater thermo ON condition. 3 ways valve will only switch to room side after tank temperature reach tank heater thermo OFF condition.

Conditon 2 : Tank Heater OFF (Internal Tank Heater)

- If tank temperature achieve tank thermo OFF, heat pump turn OFF, water pump turn OFF, heater OFF and 3 ways valve switch to room side.

When tank temperature achieve heat pump ON condition, water pump ON, heat pump ON and heater turn OFF.

Heat pump OFF condition at Tank Mode

- Tank temperature > tank water set temperature continuously for 20 seconds after heat pump thermos OFF due to water thermo. (Heat pump turn OFF but water pump continue ON and heater turn ON to achieve tank set temperature) **OR**
- Tank temperature > tank set temperature + [1°C] for continuously 20 seconds. (Heat pump OFF, water pump OFF, heater OFF and 3 ways valve switch to room side)

Heat pump ON condition at Tank Mode

- Tank temperature < tank water set temperature + R/C setting (Tank re-heat temp) (Water pump turn ON OR continue ON, heat pump ON and 3 ways valve switch to tank side or maintain at tank side)

Tank heater control

- Internal heater only operates to tank side if Tank heater ON and backup heater is enable.

Internal heater turn ON condition:

- Tank temperature < tank set temperature **AND**
- Tank Thermo ON for the Remote Control Set timer **AND**
- 20 minutes from previous heater off **AND**
- Internal tank heater selects USE from control panel.

Internal heater turn OFF condition:

- Tank temperature > tank set temperature for continuously 15 seconds **OR**
- Mode change or operation is off by control panel.

14.1.7 Heat + Tank Mode Operation

1. 3 ways valve control:
 - 3 ways valve switch to room side during room heat-up interval and switch to tank side during tank heat-up interval. Both modes will switch alternately. Tank mode is the initial running mode of Heat + Tank mode.
2. Heat pump operation control:
 - During room heat-up interval
 - Follow normal heating operation.
Switching to tank side depends to below cases:
Case 1:
[Previous switch from tank interval to room interval due to thermo OFF]
 - Switch to tank heat-up interval when Tank temp < Tank thermos ON temp (Room heat-up interval ends)
Case 2:
[If heating operation at room side is less than 30 minutes and switch to tank side 3 times consecutively]
 - Maintain at room heat-up interval regardless of the tank temperature. Switch to tank heat-up interval only when (Room Interval Timer is complete **OR** Room heat pump thermo OFF) **AND** Tank temperature < Tank thermo ON temperature.
Case 3:
[Previous switch from tank interval to room interval due to tank interval timer is complete]
 - Maintain at room heat-up interval regardless of the tank temperature. Switch to tank heat-up interval only when (Room Interval Timer is complete **OR** Room heat pump thermo OFF) **AND** tank temperature < Tank thermo ON temperature.

- During Tank heat-up interval
 - Tank interval is the first mode running when heat + tank mode is select.
 - Switch to room interval only when tank achieve tank thermo OFF **OR** tank heat-up interval timer is complete.
 - Heat pump operates according to normal tank mode operation.
3. Room heater control:
- During heating heat-up interval
 - Follow normal room heater control operation.
4. Tank heater control:
- During heating heat-up interval
 - Internal tank heater will not function under heating heat-up interval.
 - During tank heat-up interval
 - Internal tank heater will turn ON after heat pump thermo off to boil tank temperature to tank set temperature.
 - 2 ways valve control is open
 - Indoor water pump control:
 - Indoor water pump always turn ON if room heat pump thermo ON **OR** Tank thermo ON.

14.2 Water Pump

14.2.1 Water Pump Control

- Once the indoor unit is ON, the water pump will be ON immediately, if there is any abnormality cause at outdoor or malfunction, the compressor should be OFF immediately and restart delay after 3 minutes.
- The system will start checking on the water flow level after operation start. If water flow level is detected low continuously 160 seconds, the water pump and the compressor will be OFF permanently and OFF/ON control panel LED will blink (H62 error occurs).
- When error happens, the power has to be reset to clear the error.
- If there is no error indication, the water pump shall be continuously running.
- The water pump will remain ON when compressor OFF due to thermostat OFF setting is reached.
- Water pump will OFF when room thermo **OR** tank thermo **OR** buffer tank thermo OFF.
- Water pump will delay 15 seconds to turn OFF when request to OFF except during anti-freeze deice activate or air purge mode.

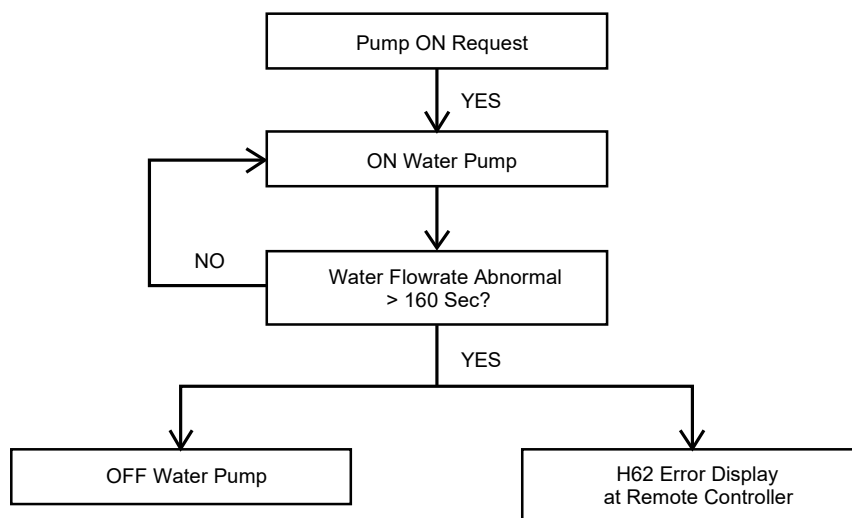

Maximum pump speed setting on remote control

- 1) When Pump flowrate setting is ΔT
 Standard pump speed is automatically controlled to get the designed water temperature different between water inlet and outlet (ΔT). The maximum pump speed setting limitation can be adjusted by the installer according to water circuit pressure drop condition.

- 2) When pump flowrate setting is Max. Duty
 Indoor water pump speed will operate at the maximum pump speed setting at room side operation. The maximum pump speed setting can be adjusted by the installer according to water circuit pressure drop condition.

However, the following sequences do not follow maximum pump duty setting by remote control.

- Pump down mode
- Air purge mode
- Normal deice

1) P-Q graph for different pump HEX duty

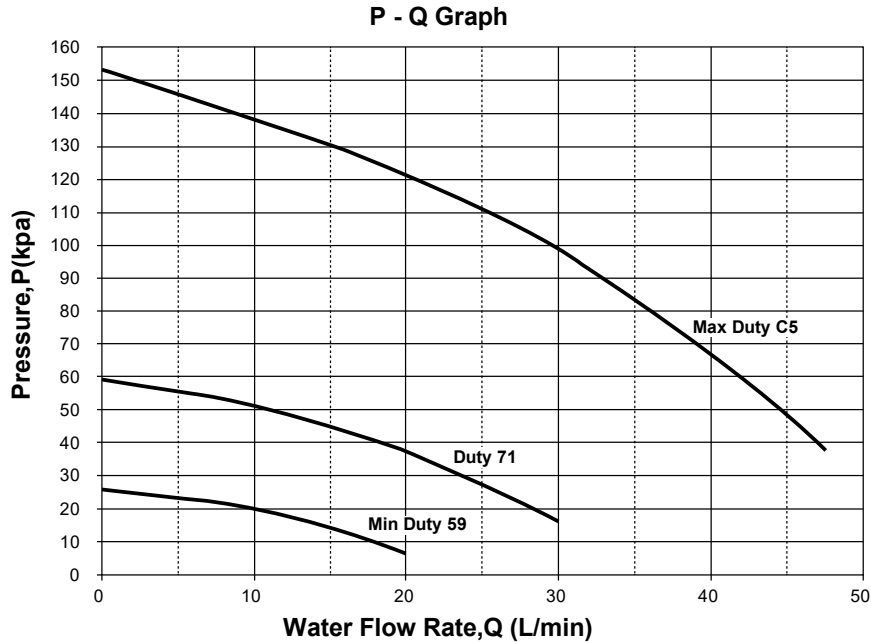

14.2.2 Zone Water Pump Control

Purpose:

- Water pump install at each zone to circulate the water inside each zone during buffer tank connection selected "YES" or 2 zone systems.

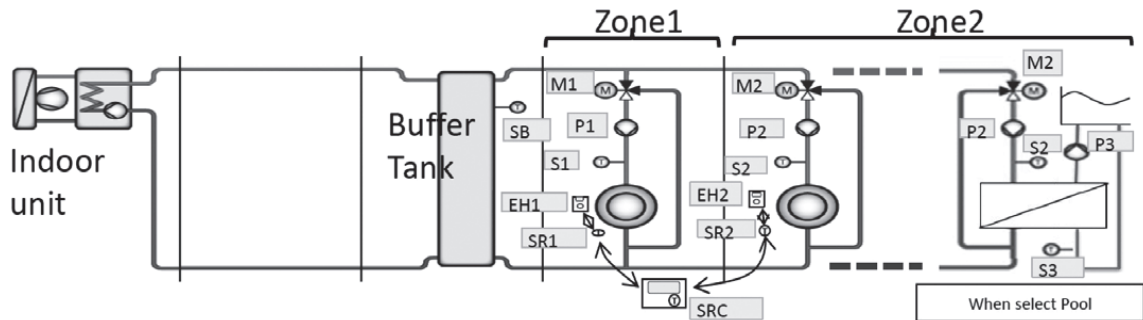

Content:

- AC type water pump install for this zone water pump control. When optional PCB connected, 230V output will drive this zone pump.
- There are three pump can be connected through Optional PCB. (Zone 1 Pump, Zone 2 Pump, & Pool Pump)

* Zone 1 pump [P1] use to circulate zone 1 water circuit & Zone 1 mixing valve [M1] adjust to control the Zone 1 target water temperature.

* Zone 2 pump [P2] use to circulate zone 2 water circuit & Zone 2 mixing valve [M2] adjust to control the Zone 2 target water temperature.

* When Pool Function select as Zone 2 circuit, [P2] use to circulate water to heat exchanger which use to transfer heat to pool water.

* Pool pump [P3] circulates the pool water through the heat exchanger to get warm water.

- Zone 1 and Zone 2 water pump start condition:
 - Zone room request ON
(eg. Zone 1 thermo ON, only zone 1 pump will turn ON)
- Zone 1 and Zone 2 water pump stop condition:
 - Zone room request OFF
- Pool water pump start condition:
 - Pool Zone request ON **AND**
 - Pool function is selected
- Pool water pump stop condition
 - Pool zone: Zone room request OFF **OR**
 - Pool function is cancel

* Zone 1 & Zone 2 water pump need to turn OFF when antifreeze deice pump stop control activate and turn ON back after the antifreeze deice pump stop control end under setting of "NO" buffer tank connection.

Zone Pump Prohibit ON control:

- Start condition:
 - Zone 1 water temperature $\geq 75^{\circ}\text{C}$ continuously for 5 minutes
 - *stop zone water pump operates if the zone water fulfilled.
- Cancel condition:
 - After 30 minutes from start condition fulfilled.
 - *zone water pump operates according to normal condition.

Zone Pump Control during Anti-Freeze

Zone pump control during Zone Anti-Freeze Control:

- When Zone Anti-Freeze Flag=1, Zone Pump Turn ON.
- When Zone Anti-Freeze Flag=0, Zone Pump Turn OFF.

Zone pump control during Indoor Anti-Freeze Control:

- Zone pump only ON/OFF if the Extension PCB connected and Buffer Tank select "NO" condition

When Indoor Anti-Freeze flag=1, Zone Pump Turn ON

When Indoor Anti-Freeze flag=0, Zone Pump Turn OFF

* Pool Water Pump will not affected by both Indoor anti-freeze control or zone anti-freeze control.

14.2.3 Water Pump Speed Feedback Error

- Basically pump speed feedback is control by micon.
- When pump speed is below low limit or over high limit for a few seconds, micon detect pump error and system is stopped.
- Error detection conditions:
 - Detect abnormal water pump speed for continuous 10 secs.
 - Current pump speed < 700 rpm or
 - Current pump speed > 6000 rpm for 10 seconds.
- Control contents:
 - When error occurs, water pump, heating and heater is stopped for 30 seconds then restart again (Retry control).
 - When micon detect error again, system is stopped and error code [H20] is displayed at control panel.

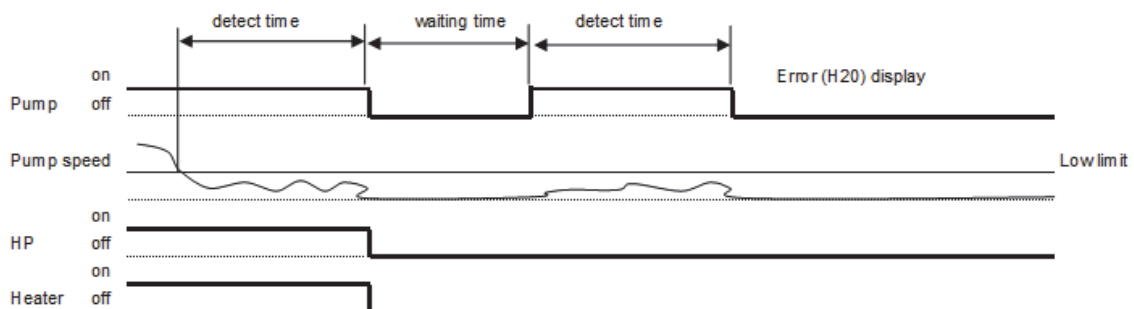

14.3 Indoor Unit Safety

14.3.1 Indoor Unit Safety Control

- When water pump is ON, the system will start checking flow switch status (ON/OFF).
- If the flow switch ON for 10 seconds, the system will check on the water inlet temperature for 10 seconds. If the water inlet temperature not exceeds 80°C, the water pump shall be continuously running with normal mode.
If the water inlet temperature exceeds 80°C for continuously 10 seconds, the water pump will be OFF immediately.
- After water pump OFF for more than 10 minutes, it will be ON back and the indoor unit safety control checking is restarted.

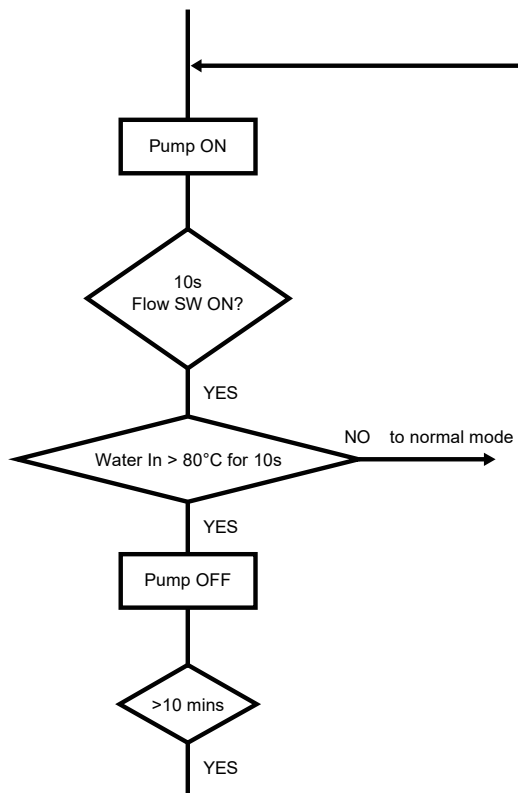

14.4 Auto Restart Control

- When the power supply is cut off during the operation of Air-to-Water Heatpump, the compressor will reoperate after power supply resumes.

14.5 Indication Panel

LED	Operation
Color	Green
Light ON	Operation ON
Light OFF	Operation OFF

Note:

- If Operation LED is blinking, there is an abnormality operation occurs.

14.6 Indoor Back-Up Heater Control

14.6.1 Indoor Electric Heater Control

1. Normal Heating Mode
 - Heater On condition:
 - a. Heater switch is ON
 - b. After Heatpump thermo ON for Remote Control Set Delay Time mins
 - c. After water pump operate **[3]** mins
 - d. Outdoor air temperature < Outdoor set temperature for heater
 - e. When water outlet temperature < Water set temperature + Remote Control Heater ON Setting
 - f. **[20]** minutes since previous Backup heater Off
 - * When heatpump cannot operate due to error happens during normal operation, heater will go into force mode automatic
 - * Heater need to operate during deice operation
 - Heater Stop Condition:
 - a. When outdoor set temperature > outdoor set temperature + **[+2°C]** for continuous 15 secs OR
 - b. When water out temp > water set temperature + Remote Control Heater OFF Setting for continuous 15 secs OR
 - c. Heater switch is Off OR
 - d. Heatpump thermo-off or OFF condition
2. Force Heater Mode
 - Heater On condition:
 - a. After water pump operate **[3]** mins
 - b. When water outlet temperature < water set temperature + Remote Control Heater ON Setting
 - c. **[20]** minutes since previous Backup heater Off
 - Heater Stop condition
 - a. Force mode off **OR**
 - b. When water outlet temperature > water set temperature + Remote Control Heater OFF Setting for continuous 15 secs

* Do not operate heater at the following situation

1. Water outlet temperature sensor, and water inlet sensor abnormal
2. Flow switch abnormal
3. Circulation pump stop condition

14.6.2 Room Heater Operation during Deice

Purpose:

- To protect the indoor Heat Exchanger from ice forming and prevent heat exchanger plate breakage.

Control content:

- This Heater protection control will activate only if the backup heater is enable at custom setup by remote controller. Once fulfil the start condition, room heater will turn ON together (base on max heater capacity selection) and stop together if stop condition is fulfilled.
 - * If the heater is request to turn ON OLP feedback will be detected.

Starting conditions:

- During normal deice operation 4~9
- Water outlet temperature < 10°C or
- Outdoor air temperature < -10°C or
- Water inlet temperature < 27°C

Heater operates When 1 and 2 ~ 4 is fulfilled.

However, this control does not relate to Heater ON/OFF button on remote control.

Stop condition:

- When normal deice end or
- Water outlet temperature > 45°C

However, room heater keeps ON if indoor electric heater control activate.

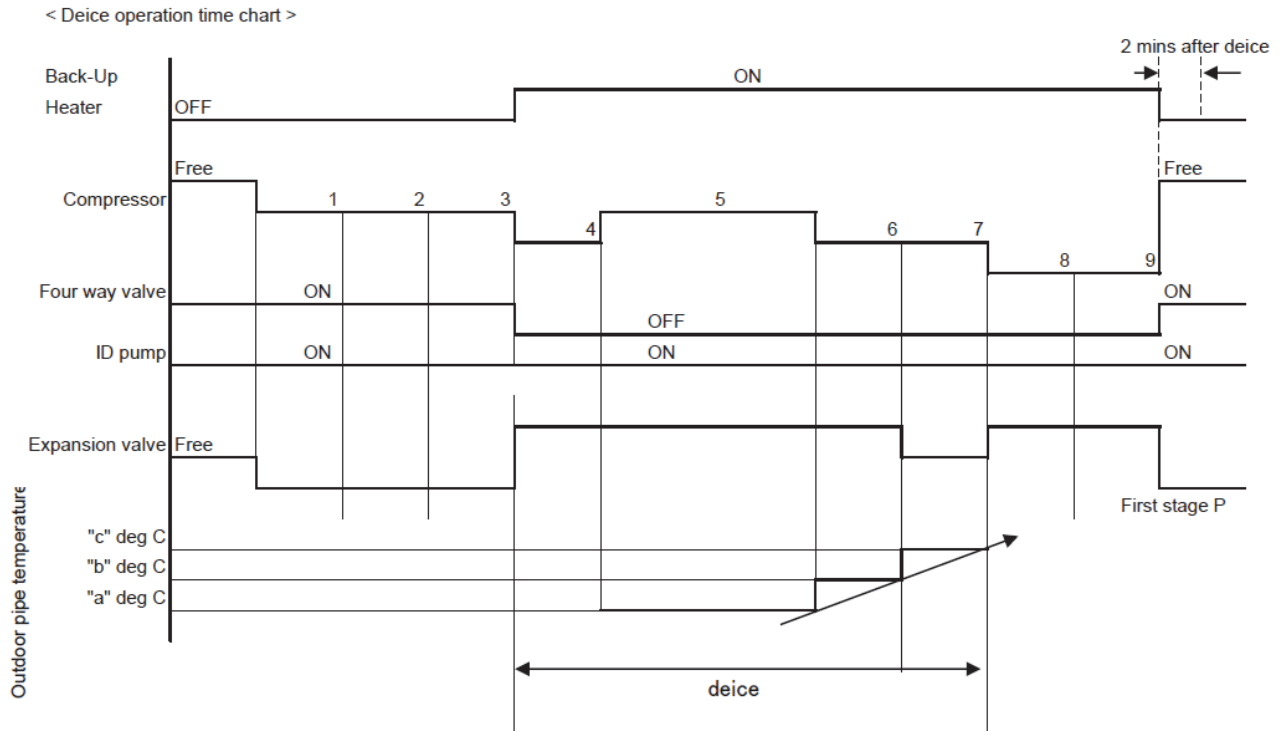

* Backup heater must Turn OFF if the water pump turn OFF.

14.7 Tank Heater Control

14.7.1 Tank Heater Remote Control Setting

- 1 Tank heater selection:
Internal: - Backup Heater use to heat up tank when select internal Heater Delay ON Timer need to set. (range 20 min ~ 3 hrs)
- 2 Tank Heater ON/OFF selection by user.

The remote control Tank set Temperature range will change according to the External and Internal Tank Heater use.

Tank Heater Selection	Range
Internal	40 ~ 65°C

14.7.2 Internal Heater Control at Tank Mode

- Internal heater turn ON condition:
 - 1 Internal Heater select for Tank heater by remote controller
 - 2 Tank Heater select ON by user.
 - 3 Backup Heater Enable
 - 4 Tank Temperature < Tank Set Temperature
 - 5 Tank Thermo ON for remote controller set timer
 - 6 20 minutes from previous heater off.
 - Room heater turn OFF condition:
 - 1 Tank Temperature > Tank Set Temperature + [0°C] for continuous 15 seconds. **OR**
 - 2 Mode Change or Operation OFF by remote controller **OR**
- * Backup Heater Turn ON/OFF all together according to the selected heater capacity.

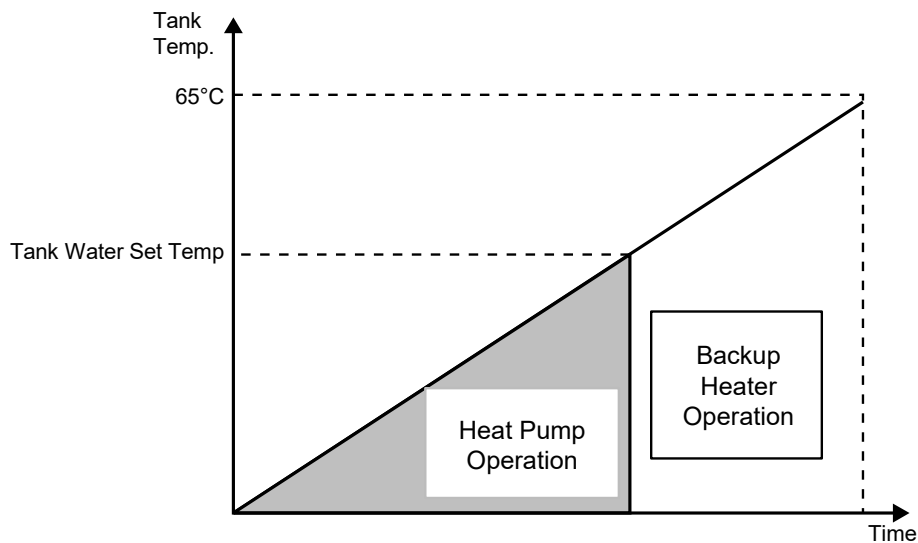

14.8 Force Heater Mode

Purpose of Force Heater Mode:

- As a backup heat source when heat pump error. Force heater Mode only control backup heater to heat up the room circuit, and turn ON back up heater or booster heater to boil up tank water base on the tank heater selection (internal or external).

Force Heater Control start condition:

- Force heater request ON by user during error OR auto turn ON by remote controller during error **AND** (Force Heater mode can be operate regardless of mode selection, remocn will send the latest mode selection force bit by bit to indoor. Indoor will judge to turn ON heater to room side if it is heat mode selected, and turn ON heater to heat tank water base on tank heater selection)
- During Error Happen (exclude the error list below)

Error List which not allow Force Heater operation

H12	Capacity Mismatch	H76	Indoor-Remote Controller Communication Error
H20	Abnormal Water Pump	H95	Abnormal Voltage Connection
H62	Abnormal Water Flow	F37	Abnormal Water Inlet sensor
H70	Abnormal Back-up Heater OLP	H45	Abnormal Water Outlet sensor
H74	PCB Communication Error		
[When tank mode operate with external heater selected & tank heater select ON]			
H73	Abnormal tank sensor	H91	Abnormal tank heater OLP

Force Heater Control Stop Condition:

- Force Heater request OFF **OR**
- Operation OFF request **OR**
- Power reset **OR**
- Error of above list happens during force heater operation.

Control contents:

- After fulfill start condition, indoor will operate the force heater operation according to below mode condition
Heat mode Only: Turn ON backup heater to achieve room heat pump target water temperature.
Heat + Tank mode: Turn ON backup heater to heat up room **OR** Turn ON Heater to Boil up tank water.
Tank mode Only: Operate pump and internal Heater OR External heater to Boil up tank water.
* For heat mode condition, backup heater will only turn ON if the backup heater is enable regardless of Room Heater Selection.
* For tank mode condition, If internal heater selected backup heater will turn ON to boil up tank water.
If external heater selected , booster heater will turn ON to boil up tank water regardless of tank heater selection.

Room Side: (Heat Mode):

- When force heater mode start condition fulfilled, turn ON water pump and turn ON backup heater follow below control.
- Operate the 3 ways valve at room side only and turn ON 2 ways valve as heat mode operation.
- Turn ON the zone pump and mixing valve if system select 2 zone system or Buffer tank connect YES, control according to normal zone pump and mixing valve control.
- When Force heater mode stop condition fulfilled, turn OFF heater as below condition and turn OFF water pump after pump delay time.

Backup Heater On Condition:

- When Force Heater Control start condition fulfill **AND**
- After water pump operate 2 minutes **AND**
- When water outlet temperature < water set temperature + Remote Control Heater ON Setting **AND**
- 20 minutes since previous Backup heater Off **AND**
- Backup Heater Enable

Backup Heater Stop condition:

- Force mode off **OR**
- Operation off **OR**
- When water outlet temperature > water set temperature + Remote Control Heater OFF Setting for continuous 15 secs **OR**
* ON/OFF follow normal heater sequence.

Tank side (Tank mode):

- When tank mode select and force heater bit received, turn ON backup heater (INTERNAL) or Booster Heater (External) depend on the tank heater selection.
- If tank heater selection is INTERNAL, follow normal thermo judgement to switch 3 ways valve to tank side and room side.

Tank Heater selection is INTERNAL:

Backup Heater ON Condition:

- After water pump operate 2 mins **AND**
- When tank temperature < Tank set temperature - [Remocon Set Tank Re-heat Temp] **AND**
- 20 minutes since previous Backup heater OFF **AND**
- Backup Heater Enable

Backup Heater OFF condition:

- Force mode off **OR**
- When tank temperature > Tank set temperature for continuous 15 secs **OR**
- Tank Operation OFF

14.9 Quiet Operation

Quiet mode is use to reduce the noise of outdoor unit by reducing the frequency or fan speed.

Quiet level

There are 3 level (Level 1, Level 2, Level 3) to set by quick menu function on remote control.

Control content

Once the quiet function is select, the remote control will transmit the signal to indoor and outdoor unit.

Start condition

- Quiet mode is set on remote control.
- Quiet mode is request ON by weekly timer.

Stop condition

If any of below condition is achieve.

- OFF/ON button is pressed.
- Quiet mode is OFF by remote control.
- Quiet mode is request OFF by weekly timer.

14.10 Sterilization Mode

- Purpose:
 - To sterilize water tank by setting the required boiling temperature.
- Remote control setting
 - Days for sterilization function to start can be select.
 - Time of selected day to start sterilization function.
 - Boiling temperature (Internal heater is 55°C ~ 65°C)
 - Maximum operation time is 5 minutes to 1 hour.
- Start condition
 - Tank connection set to "YES" by remote control
 - Sterilization function selects "YES".
 - Sterilization signal received from remote controller by timer.
 - Tank mode request ON.
- Stop condition
 - When boiling timer is completed. Boiling timer (Remote control set maximum operation time) start counting once tank achieve boiling set temperature **OR**
 - After 8 hours of operation since sterilization start.
 - Tank mode request OFF.

- Control content:
 - During sterilization function activation time, target tank set temperature will internally change to boiling set temperature.
 - During sterilization activates, heat pump and heater (external or internal) will operate as normal tank mode to achieve the boiling set temperature.
 - Sterilization operation will end when stop condition is fulfill.
 - After sterilization is complete, tank set temperature will resume to normal operation.

* Tank temperature may not achieve boiling set temperature if tank heater is select OFF **OR** external compressor switch.

14.11 Outdoor Ambient Thermo OFF Control

- Purpose:
 - Stop provides heating to room side during high outdoor ambient condition.

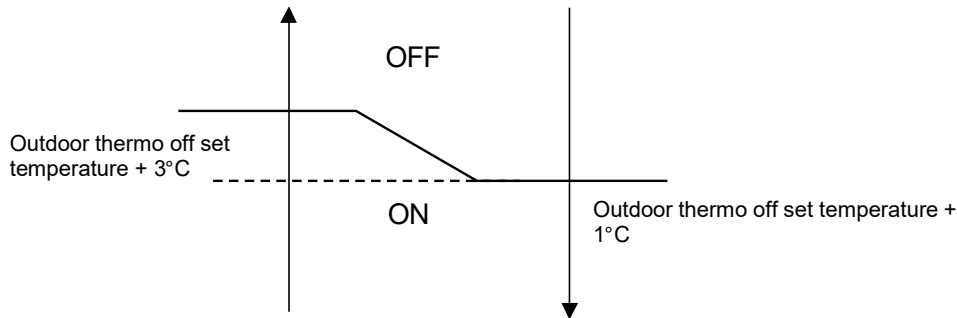

- Control content:
 - Heating outdoor ambient thermos OFF control only applicable when heat pump operate in heat mode. (This control will not activate when running in tank side)
 - Heat pump and water pump will turn OFF when outdoor ambient is higher than outdoor thermo OFF set temperature.
 - Heat pump thermos ON when outdoor ambient < outdoor thermos OFF set temperature + 1°C.

14.12 Force DHW mode

Purpose:

There are two selection to activate force DHW mode, either auto or manual. For manual selection, when user want to use hot water now, user can press this force DHW mode under the quick menu to operate tank only mode to boil up the tank temperature. For Auto selection, when tank temperature drop below the remote controller set temperature. Force DHW request will auto turn ON to operate tank only mode.

Remocon setting:

Force DHW function can be activate manually under quick menu or set auto force DHW to activate when tank drop below set temperature.

Control Content: (Manual)

- When press the Force DHW function during operation OFF condition:
 - When receive this Force DHW bit from remocon, indoor will run tank only mode regardless of the mode selection.
 - After tank temperature achieve tank thermo off temperature, turn OFF force DHW bit and return to operation OFF with previous mode selection.
- When press the Force DHW function during operation ON condition:
 - When receive this Force DHW bit from remocon, indoor will memories the running mode and run tank only mode regardless of the mode selection.
 - After tank temperature achieve tank thermo off temperature, turn OFF force DHW bit and return to previous memories running mode.

* when operation OFF or mode change request from remocon during force DHW mode operation, End force DHW mode and follow the new request operation.

* Once receive force DHW mode from remocon, indoor direct start tank mode and consider tank thermo ON. Thermo OFF only when achieve tank thermo OFF depend on the Tank System Setting.

Control Content: (Auto)

- When auto Force DHW activated in installer setup condition:
 - Force DHW mode will auto turn ON when tank mode is ON & tank temperature drop below Remote Controller Force DHW set temperature.
 - Operation after Force DHW turn ON is same as manual turn ON control.

* Force DHW mode is an option for priority of heat pump operation switch from air conditioning room to domestic hot water operation.

14.13 SMART DHW mode

Panasonic All In One model provide the option to choose STANDARD DHW Mode or SMART DHW Mode for Tank Heat Up according to requirement. SMART DHW mode comparatively consume lower tank heat up power but longer re-heat time than STANDARD DHW Mode.

SMART DHW control

- During SMART DHW start time 20:00 (Default Setting) to SMART DHW stop time 05:00 (Default setting) Heat pump re-heat the tank water only when tank temperature drop below 20°C (Default setting)
- Time between 05:00 to 20:00 Heat pump reheat the tank water when tank temperature as below condition

Condition 1: Tank Heater ON

Reheat when tank temperature below tank set temperature + R/C (Tank re-heat Temperature) - 3°C

Condition 2: Tank Heater OFF

Reheat when tank temperature below Tank set temperature or 51°C (Whichever lower) + R/C (Tank re-heat Temperature) -3°C

* SMART DHW start time, stop time and SMART ON Temperature can change in CUSTOM menu.

STANDARD DHW Mode

- Heat pump always reheat the tank water when tank temperature as below condition

Condition 1: Tank Heater ON

Reheat when tank temperature below tank set temperature + R/C (Tank re-heat temperature)

Condition 2: Tank Heater OFF

Reheat when tank temperature below Tank set temperature or 51°C (Whichever lower) + R/C (Tank re-heat temperature)

14.14 DHW Capacity Setting

DHW Capacity is heat pump heating capacity output control during tank boiling operation. There are two DHW capacity setting (VARIABLE & STANDARD) which can be set in remote control.

VARIABLE DHW Capacity:

- Heat pump operate with efficient (Low) Capacity to boil tank temperature during re-heat process. And heat pump regulated to operate with high capacity to boil tank temperature when tank temperature drop below 25°C.

STANDARD DHW Capacity:

- Heat pump operate according to outdoor rated heating capacity during tank boiling process.

14.15 Anti Freeze Control

- Anti freeze protection control menu can be set YES or NO by control panel.
- In heatpump system, there are 3 types of anti freeze control:
 1. Expansion tank anti-freeze control
 - Expansion tank anti freeze heater ON condition:
 - Outdoor ambient temp. < 3°C
 - Expansion tank anti freeze heater OFF condition:
 - Outdoor ambient temp. > 4°C
 2. Water pump circulation anti freeze control
 - Water pump turns ON when **ALL** below conditions are fulfilled:
 - Heatpump OFF (stand by) OR error occurs.
 - Water flowing flag is ON.
 - Water flow switch is not abnormal.
 - Outdoor ambient temp. < 3°C OR outdoor ambient temp. sensor is abnormal.
 - Water inlet/outlet temp. < 6°C.
 - After 5 minutes from previous water pump OFF.
 - Water pump turn OFF when **ANY** of below conditions is fulfilled:
 - Outdoor ambient temperature $\geq 4^{\circ}\text{C}$.
 - During $-5^{\circ}\text{C} < \text{outdoor ambient temp.} < 4^{\circ}\text{C}$
 - After water pump ON for 4 minutes, and water inlet temp. $\geq 8^{\circ}\text{C}$.
 - Else, shift to back up heater anti freeze control.
 - During outdoor ambient temp. < -5°C
 - After water pump ON for 4 minutes, and water inlet/outlet $\geq 20^{\circ}\text{C}$.
 - Else, shift to back up heater anti freeze control.
 - However, if flow switch is abnormal (H62), then water pump circulation anti freeze control will not activate.
 3. Back up heater anti freeze control:
 - Back up heater turn ON when **ALL** below conditions is fulfilled:
 - Water inlet/outlet temp. < 6°C.
 - Water pump circulation anti freeze control activated and water pump ON for 4 minutes.
 - Back up heater turns OFF when ANY of below conditions is fulfilled:
 - Water inlet/outlet temp. > 28°C.
 - Water pump circulation anti freeze control deactivated/water pump OFF.
 - However, if back up heater is abnormal (H70) then back up heater anti freeze control will not activate.

14.15.1 Zone Anti-Freeze Control

- If buffer tank selection is "NO" and Anti- Freeze function select "NO" from remote control, this control cannot activate.

Start condition:

- After [5] min from previous Zone pump off. **AND**
- Outdoor air temp < [3] °C **OR** Outdoor sensor is abnormal. **AND**
- Zone water temperature < [6]°C **OR** Zone Sensor Short or Open

Cancel condition:

- After water Zone pump ON [4] min **AND**
- Outdoor air temp $\geq [4]^{\circ}\text{C}$ **OR**
- During $-5^{\circ}\text{C} \leq \text{Outdoor air temp} < [4]^{\circ}\text{C}$ **OR**
Zone water temperature sensor > [8] °C
- During Outdoor air temp < $[-5]^{\circ}\text{C}$
Zone water temperature sensor > [20] °C

*However, Zone water temperature sensor is Open or Short, Condition C and D is ignored.

14.16 Solar Operation (Optional)

14.16.1 Solar Operation:

Solar function:

- This function allow user to control the solar pump to operate depend on the solar sensor reading compare to the tank installed. Solar pump will circulate the hot water energy store at solar panel to heat up the DHW Tank or Buffer Tank.

Solar Connection Diagram:

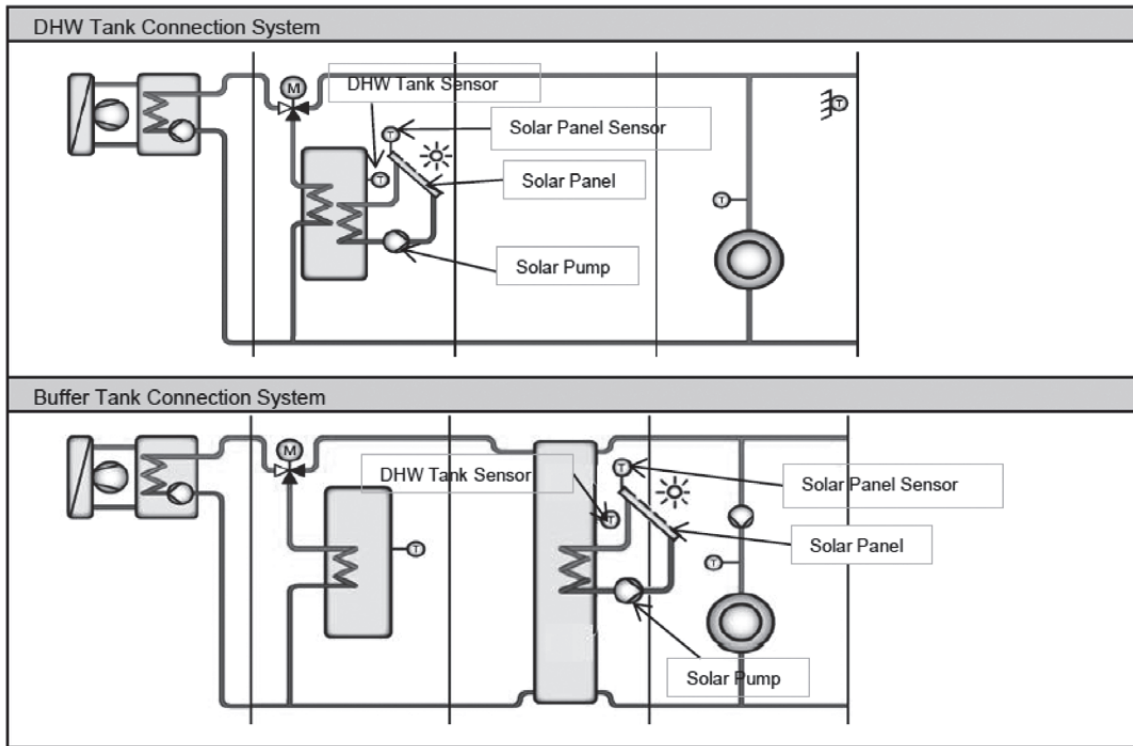

- Solar function can only enable when the Optional PCB is connected.
- Few part as below need to install to control the solar operation:
 - Solar Panel
 - Solar Pump
 - Solar Panel Sensor
 - Tank Sensor (Buffer tank sensor OR DHW Tank sensor depend on the connection direction)

* During Solar Connection to the system, installer need to alert on the high water temperature may flow to the zone circuit or DHW piping circuit. Therefore pipe which withstand higher water temperature need to be installed.
- Solar remote control setting
 1. Solar Setting can only be set when the optional PCB connection is select "YES"
 2. By remote controller, Setting as below list can be set for solar function operation (Installer Menu)
 - Solar Function ("YES" or "NO")
 - Tank Connection Direction ("DHW TANK" or "BUFFER TANK")
 - Delta T turns ON: Difference temperature setting between solar panel sensor and Tank to turn on solar pump. (Range :5 ~ 15°C)
 - Delta T turns OFF: Difference temperature setting between solar panel thermistor and Tank to turn off solar pump. (Range :2 ~ 10°C)
 - Outdoor temp for Anti-Freeze : Outdoor temp to start Anti-Freeze control for solar circuit. (Range : -20 ~ 10°C)
 - Tank Temperature HI Limit Set (Range : 70 ~ 90°C)

14.16.2 Solar Operation Control

- Solar function can only be activate if the solar function selection "YES" from remote control. To achieve hot water from solar panel, indoor need to control the solar pump and circulate hot water from solar panel.

Under normal case:

- Solar pump start condition:
 - Solar panel temperature > Delta T turn on setting temp (R/C) + Tank temperature (depend on selection, DHW or Buffer) **AND**
 - Tank temperature (DHW or Buffer) < Solar HI Limit Temp (R/C) **AND**
 - Operation ON with heat mode (apply to solar connect to "Buffer Tank" case)
- * Condition c) ignore if the solar system is connect to DHW tank (control active under operation OFF time for Tank connection case)
- Solar pump stop condition:
 - Solar panel temperature < Delta T turn OFF setting temp (R/C) + Tank temperature (depend on selection, DHW or Buffer) **OR**
 - Tank hot water temp >= Solar HI Limit Temp (R/C) + [2]°C

Under solar Anti-freeze protection control:

- Solar pump start condition:
 - Outdoor temp < Outdoor temp setting for Anti-Freeze (R/C)
- Solar pump stop condition:
 - Outdoor temp > Outdoor temp setting for Anti-Freeze + [2]°C

**However, During Cool mode this function cannot activate if Tank selection is "Buffer Tank".

**Solar pump can operate even if Heat pump is under error stop.

- Solar operation during error:
 - During Tank sensor (DHW or Buffer depend on selection) abnormal, Solar operation will not able to function.
 - During Solar Panel sensor detect OPEN (not include SHORT), Solar operation will not able to function too.

14.17 Boiler Bivalent Control

- Boiler is an additional or alternative heat source to heat up the room when necessary.
- Purpose of this control is to turn ON and turn OFF the Boiler output signal when boiler heating capacity needed in the system.
- Boiler is possible to connect to DHW Tank and Buffer Tank depends on the installer.
- Boiler operation parameter need to be set on Boiler itself, indoor do not control the boiler operation direction and operation.
- There is two option of control pattern can be set by remote controller: AUTO OR SG ready Mode

Auto Control Mode:

- 1 There are Alternative mode, Parallel mode, & Advance Parallel mode available to select by installer to fit to the total system.

Remote control setting value:

- 1 Outdoor Ambient Set = (Range: -15°C ~ 35°C)

• **Alternative Mode**

- Only one heat source operates at one time, either heat pump or boiler depends on condition.
- * External pump will turn ON when the external pump selection is ON when boiler is ON even heat pump is OFF.

Control detail:

During Operation ON at Heat mode or Tank mode or Heat + Tank Mode

- Boiler signal turn ON and heat pump and water pump turn OFF when:
 - Outdoor ambient < Outdoor Ambient Set **AND**
 - Boiler prohibit flag = 0

** However indoor water pump can operate when Anti-freeze control condition fulfilled.

- Boiler signal turn OFF and heat pump and water pump turn ON when:
 - Outdoor ambient > Outdoor Ambient Set + [2°C] **OR**
 - Boiler prohibit flag = 1

- Boiler signal turns OFF when
 - Outdoor ambient > Outdoor Ambient Set + [2°C] **OR**
 - Heat pump not operates at tank side. **OR**
 - Boiler prohibit flag = 1

Boiler prohibit flag control

Purpose:

- For product safety. Boiler signal is OFF when water temperature is too high.

Start condition:

- Water outlet ≥ 85°C continues for 5 minutes.
- Water inlet ≥ 85°C continues for 5 minutes.
- Zone1 water temp ≥ 75°C continues for 5 minutes.
- Zone2 water temp ≥ 75°C continues for 5 minutes.

Contents:

- After start condition fulfilled, set boiler prohibit flag = 1

Cancel condition:

- After 30 minutes from start condition fulfilled.

Contents:

- Set boiler prohibit flag = 0

14.18 External Room Thermostat Control (Optional)

Purpose:

1. Better room temperature control to fulfill different temperature request by external room thermostat.
Recommended external room thermostat:

Maker	Characteristic
Siemen (REV200)	Touch panel
Siemen (RAA20)	Analog

Connection of external room thermostat:

Wire Connection and thermo characteristic of Siemen REV200:

Setting	L/L1 (H)	Heat Thermo	L/L2 (C)	Cool Thermo
Set Temp < Actual Temp	Open Circuit	OFF	Short Circuit	ON
Set Temp > Actual Temp	Short Circuit	ON	Open Circuit	OFF

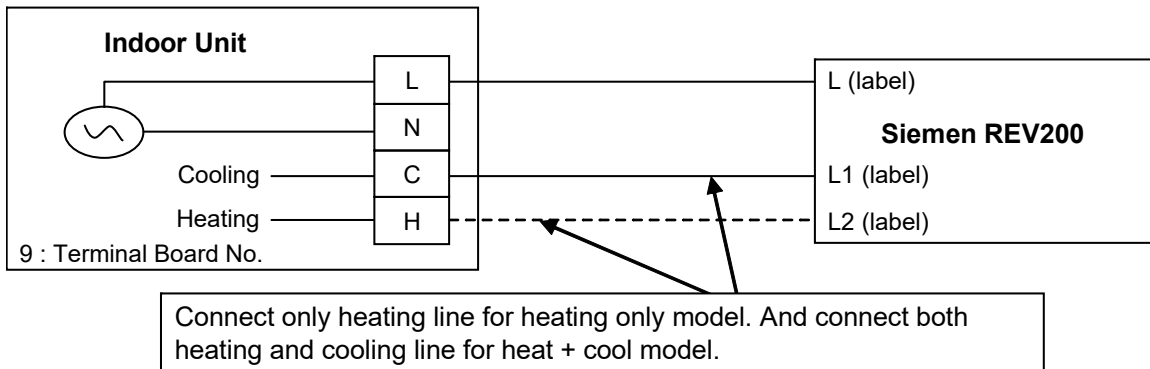

Wire Connection and thermo characteristic of Siemen RAA20:

Setting	L/Y1 (H)	Heat Thermo	L/Y2 (C)	Cool Thermo
Set Temp < Actual Temp	Open Circuit	OFF	Short Circuit	ON
Set Temp > Actual Temp	Short Circuit	ON	Open Circuit	OFF

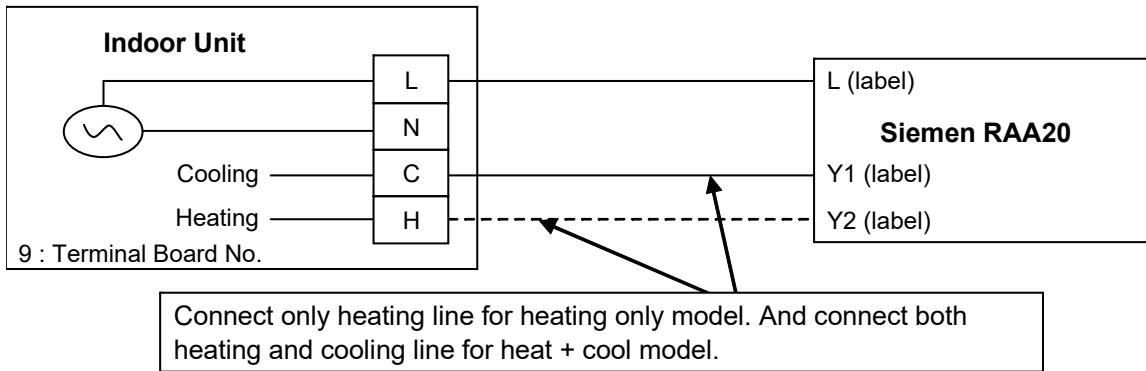

Control Content:

- External room thermostat control activate only when remote thermostat connection select YES by Indoor control panel.
- When indoor running heat mode, refer thermo On/Off from heating line feedback. And when indoor running cool mode, refer thermo On/Off from cooling line feedback.
- Heat pump Off immediately when receive thermo off feedback.

14.19 Three Ways Valve Control

Purpose:

- 3 ways valve is used to change flow direction of hot water from heat pump between heating side and tank side.

Control contents:

1. 3 ways valve switch Off:
 - o During 3 ways valve switch Off time, the hot water will provide heat capacity to heating side.
2. 3 ways valve switch On:
 - o During 3 ways valve switch On time, the hot water will provide heat capacity to tank side.
3. Stop condition:
 - o During stop mode, 3 ways valve will be in switch off position.

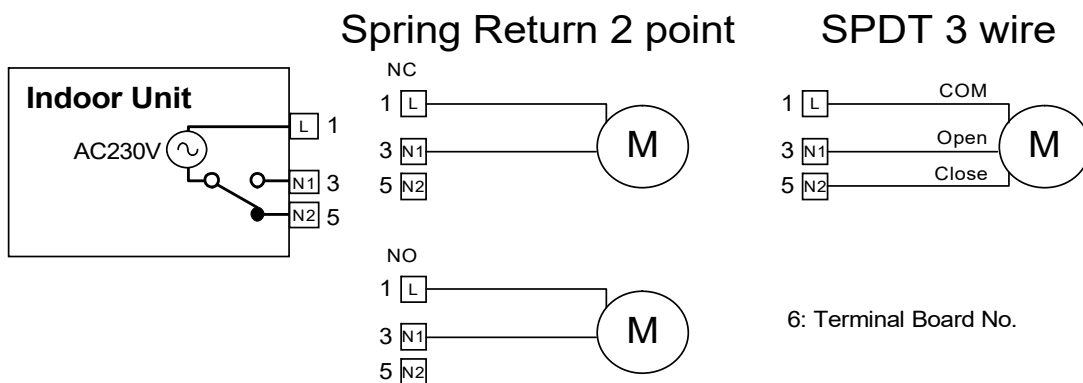

* During pump down and force mode, fix 3 ways valve in close condition.

* Recommended Parts : SFA 21/18 (Siemens)

14.20 External OFF/ON Control

- Communication circuit between indoor unit and external controller is as per below.

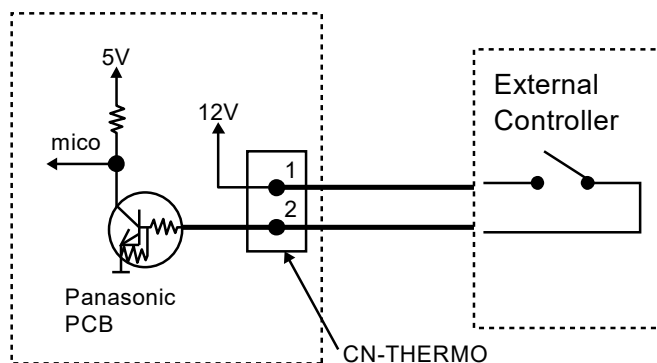

- Maximum length of communication cable is 50 meter.
- Control content:

External Control Switch	Control Panel OFF/ON	Control Panel Power LED	System Status
ON	ON	ON	ON
ON	OFF	OFF	OFF
OFF	ON	ON	OFF
OFF	OFF	OFF	OFF

Remocon Screen Display and Control Detail:

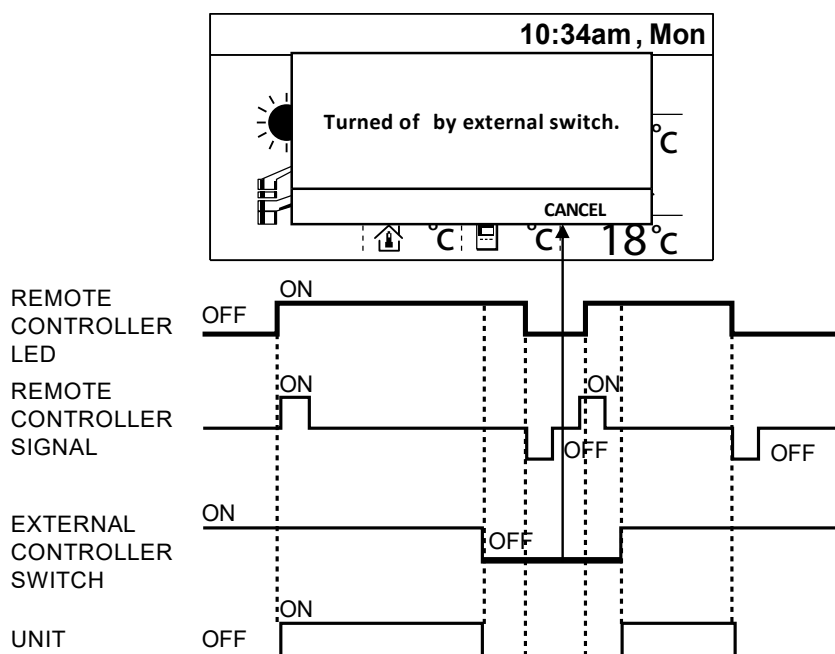

When External SW connection select "YES" from remocon installer menu:

- Heating or Cooling system will operate normally if the External Switch signal is ON.
- Once the External Switch turn OFF, System Turn OFF (Heat pump, water pump, heater etc...)
- Remocon LED remain ON or OFF according to the current operation request.
- Pop up menu at remocon main screen as above screen to inform customer system stop by External Switch.
- It is possible to press cancel and return to main screen to do change of operation setting while waiting the External Switch turn ON back.
- Remocon LED will always follow the latest changes from remocon.
- If no action on remocon for continuous 5 minutes, the pop up screen will show again on the screen.
- But once the External Switch Turn ON back, pop up screen will disappear and system can operate normally according to the latest operation setting and request.

14.21 External Compressor Switch (Optional PCB)

External compressor switch port can have two purpose of control as below:

- Heat source ON/OFF function (Dip switch Pin 3 on PCB "OFF")
- Heater ON/OFF function (Dip switch Pin 3 on PCB "ON")
- Heat source ON/OFF function

Purpose:

- Heat pump ON/OFF function is use to turn OFF the high power consumption device (Heat pump, & Heater) when there is energy or electric current limitation. Other optional function still can be operate under heat pump and heater OFF condition.

Control Detail:

- This External Compressor Switch is possible to connect to Optional PCB only.
- Once the remocon select External Compressor Switch connection "YES", & Dip Switch on PCB "OFF" This heat pump ON/OFF function will activate
- The ON/OFF signal of this External Compressor Switch is same as External Switch.
- When the External Compressor Switch is ON:
 - Heat pump system operate normally
- When the External Compressor Switch is OFF:
 - Heat pump, Indoor water pump & Heater (Booster heater & Backup Heater) need to turn OFF
 - Solar, Boiler and zone control can be operate follow normal control condition.
 - * pump delay OFF also included in this control

(There is NO pop up screen like External Switch when this External Compressor Switch is OFF.)

- Heater ON/OFF function

Purpose:

- Heater ON/OFF function is use to turn OFF the heater (backup heater & booster heater) when there is energy or electric current limitation. Heat pump and other optional function still can operate.

Control detail:

- This External Compressor Switch is possible to connect to Optional PCB only.
- Once the remocon select External Compressor Switch connection "YES", & Dip Switch on PCB "ON" This heater ON/OFF function will activate
- When the External Compressor Switch is ON:
 - Heat pump and heater operate normally
- When the External Compressor Switch is OFF:
 - Backup heater and booster heater cannot operate even heater request is ON.
 - Heat pump and option function (Solar, Boiler and zone control) can be operate follow normal control condition.

(There is NO pop up screen like External Switch when this External Compressor Switch is OFF.)

14.22 SG Ready Control (Optional PCB)

Purpose:

- To set ON/OFF of heat pump and target temperature by digital input of third party device if necessary in field.

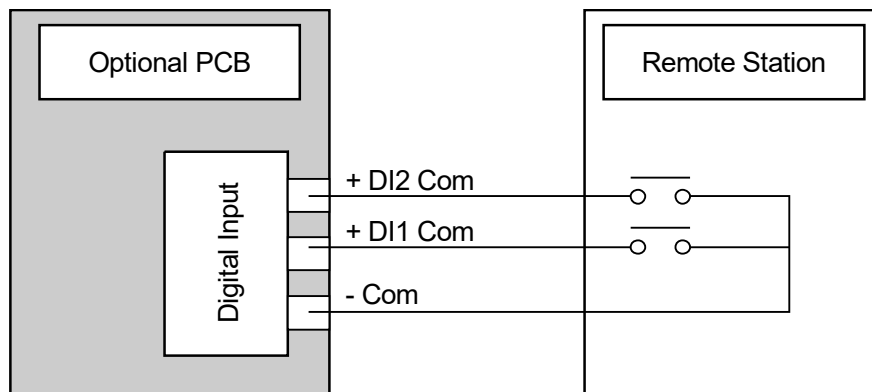

Remote control setting

For this function, following items need to be set on Remote Control (installer menu) –

- SG control = YES or NO
- Capacity up setting 1
 - Heating capacity [50 ~ 150 %]
 - DHW capacity [50 ~ 150 %]
 - Cooling capacity [-15 ~ 0 %]
- Capacity up setting 2
 - Heating capacity [50 ~ 150 %]
 - DHW capacity [50 ~ 150 %]
 - Cooling capacity [-15 ~ 0 %]

Control contents:

If SG control on remote control = "Yes", then following control only activate by digital input.

- While Digital input is " 00 " (Normal operation)**
 - Normal operation. Once detect '00' system will operate back to normal condition. (All the target set temperature for heating side and DHW side will return back to previous set temperature when digital signal change from "10" or "11" back to "00".)
- While digital input is detected " 01 " (HP stop)**
 - Heat pump & room heater & tank heater cannot operate. (Solar control and Boiler back up and 2 Zone control can activate.)
- While digital input is detected " 10 " (Capacity 1)**
 - Target temperature for heating and DHW Tank is changed according to the percentage set by Remote control setting. However, which setting temperature is change depend on system setting.
 - Target water temperature of cooling is changed according to the adjustment value set by remocon setting.
- While digital input is detected " 11 " (Capacity 2)**
 - Target temperature for heating and DHW Tank is changed according to the percentage set by Remote control setting. However, which setting temperature is change depend on system setting.
 - Target water temperature of cooling is changed according to the adjustment value set by remocon setting.
- While digital input is detected " 10 " (Capacity 1)**
 - Setting temperature for heating and Tank is changed. However, which setting temperature is change depend on system setting.

If Buffer selection is "YES"

Room side

New Target Buffer tank temperature = Current Target Buffer Tank Temperature * Remote Control setting (" capacity 1) %

* Max Min regulation is follow Target Buffer tank temperature control specification

** No change of Target zone water temperature, only set higher buffer tank temperature.

DHW Tank side

New Tank Set Temperature = Tank Set Temperature * Remote Control setting for DHW ("Capacity 1) % *
(Max regulation depend on the tank max setting limit)

If Buffer selection is "NO"

Room side

New Target Zone Water Temperature = Current Target Zone Water Temperature * Remote Control Setting (*Capacity 1) %
(Zone 1 and Zone 2 will change according to its own target zone water temperature.)
(Max regulation depend on the temperature control type select)

DHW Tank side

New Tank Set Temperature = Tank Set Temperature * Remote Control setting for DHW ("Capacity 1) %
* (Max regulation depends on the tank max setting limit)

Setting temperature for cooling is changed

New Target water temperature = target water temperature + Remote Control setting for cool (*Capacity 1)
* (Min/Max regulation of cooling water set apply)

- **While digital input is detected " 11 " (Capacity 2)**
 - Setting temperature for heating and Tank is changed.
However, which setting temperature is change depend on system setting.

If Buffer selection is "YES"

Room side

New Target Buffer tank temperature = Current Target Buffer Tank Temperature * Remote Control setting (" capacity 2) %
* Max Min regulation is follow Target Buffer tank temperature control specification
** No change of Target zone water temperature, only set higher buffer tank temperature.

DHW Tank side

New Tank Set Temperature = Tank Set Temperature * Remote Control setting for DHW ("Capacity 2) %
* (Max regulation depends on the tank max setting limit)

If Buffer selection is "NO"

Room side

New Target Zone Water Temperature = Current Target Zone Water Temperature * Remote Control Setting (*Capacity 2) %
(Zone 1 and Zone 2 will change according to it's own target zone water temperature.)
(Max regulation depend on the temperature control type select)

DHW Tank side

New Tank Set Temperature = Tank Set Temperature * Remote Control setting for DHW ("Capacity 2) %
* (Max regulation depends on the tank max setting limit)
** This function is not applicable for Cooling mode.

Setting temperature for cooling is changed

New Target water temperature = target water temperature + Remote Control setting for cool (*Capacity 2)
* (Min/Max regulation of cooling water set apply)

14.23 Holiday Mode

- Purpose:
Promotes energy saving by allowing the user to stop the system during holiday and enables the system to resume at the preset temperature after holiday.
- Control details:
 - Indoor operate the unit according running mode request. Target temperature will follow holiday setting temperature.
 - If heat mode request is receive, Target Water Out Temperature will change according to holiday shift temperature set.
[If heat is set OFF at holiday, unit, water pump and zone control will OFF]
 - If tank mode request is receive, Target Tank Set Temperature will change according to the holiday tank shift temperature set.
[If tank is set OFF at holiday, heat pump and tank heater will OFF]

- After days of holiday have been set, heat pump will stop and only resume operation at the end of holiday countdown.
- Start condition:
 - Holiday timer set and the holiday timer start
 - * The day holiday mode was set is counted as day 1.
- Stop condition:
 - OFF/ON button is pressed.
 - Holiday timer is reached.

14.24 Dry Concrete

- Purpose
Provide heat to floor heating panel and dry the wet concrete during installation.
- Setting condition:
 - Dry concrete parameter can be set through remote control under system setup.
 - Parameters are possible to set up to 99 days with different target set temperature
- Control details:
 - Dry concrete mode will be activates when select ON from service setup.
 - Once start dry concrete function, remote control will send step 1 setting temperature to indoor unit.
 - * This temperature is set at zone temperature. If system is 2 zones, both zone target temperature is set as same temperature.
 - Heat pump will start heat mode operation to room side with received target water outlet temperature.
 - * Heat pump will operate according to Heat pump Target Water Temperature.
 - After complete day 1 setup operation, day 2 data will be send to indoor at 12.00am on the second day.
 - Each preset data will be send every day until dry concrete mode is complete, unit will turns OFF and exit dry concrete function.
 - 3 ways valve and booster heater will turn OFF and 2 ways valve will turns ON.
- Cancel condition:
 - Dry concrete mode is complete and OFF signal is received.
 - OFF signal is received by pressing OFF/ON button.

14.25 Flow Sensor

- The water flow sensor serves as an overload protector that shuts down the unit when the water level is detected to be low.
- Abnormal flow detection:

Sequence	Abnormal flow	Normal flow
Normal case	Flow rate < 7 l/min or ≥ 69 l/min	≥ 7 l/min
During Deice Operation	Flow rate < 12 l/min or ≥ 69 l/min	Flow rate ≥ 12 l/min

14.26 DHW Defrost Operation

User can select either enable or disable this DHW defrost operation from installer setup.

- If DHW defrost is enabled, system will run defrost at Tank Unit if water tank temperature ≥ 40°C & Water Inlet ≥ 35°C and Room Air Conditioning Unit will continue in limited heating generation. Or else system will run defrost at Room Air Conditioning Unit.
- If DHW defrost is disabled, system will always run defrost at Room Air Conditioning unit at all time.

15. Operation Control (S-71WF3E)

15.1 Cooling Operation

- Cooling operation can be set using remote control.
- This operation is applied to cool down the room temperature reaches the setting temperature set on the remote control.
- Cooling Operation Time Diagram.

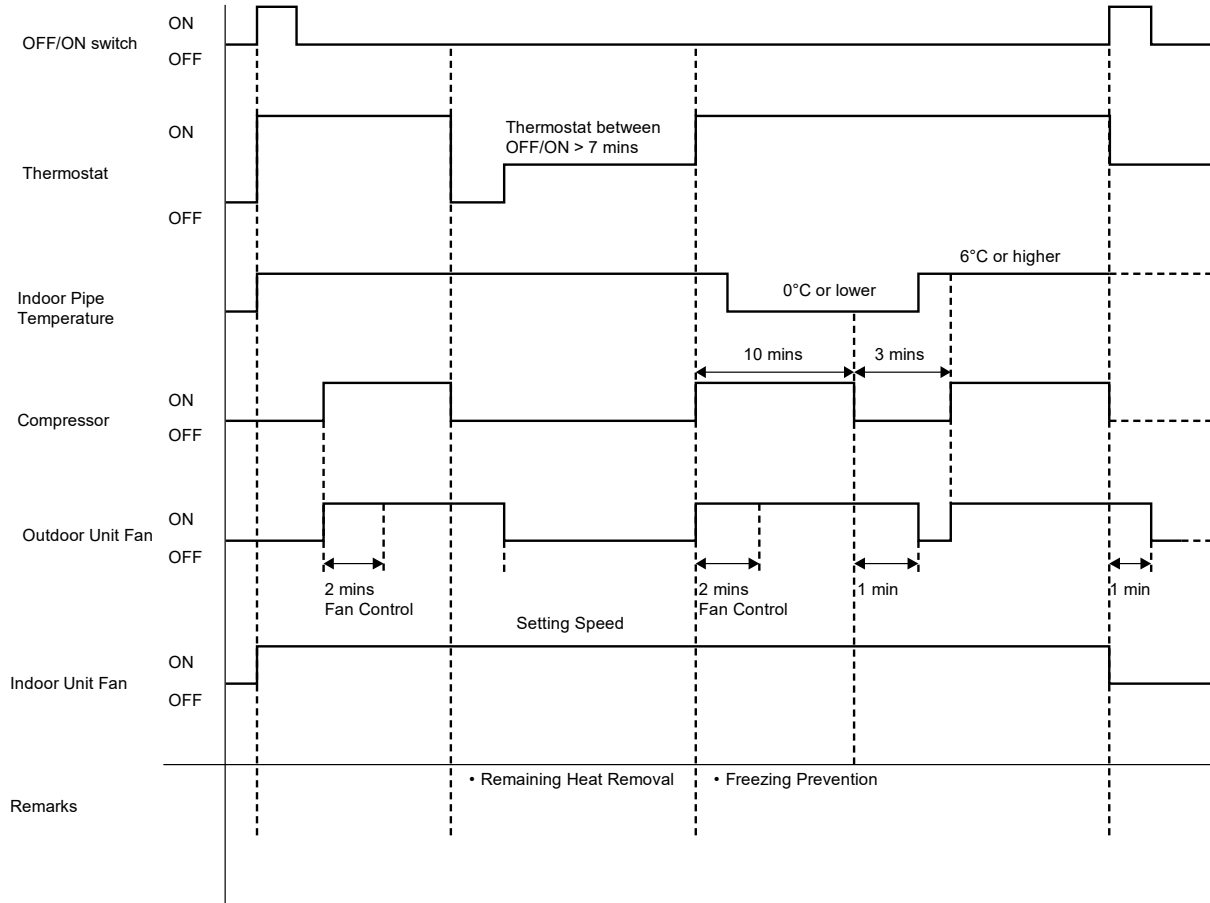

15.2 Dry Mode Operation

- Soft Dry Operation can be set using remote control.
- Soft Dry operation is applied to dehumidify the room.
- When operation begins, the fan speed is control as follows.

15.2.1 S-71WF3E

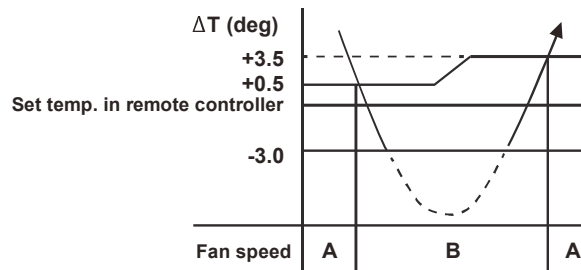

A: Fan speed is as set in the remote controller

B: Fan speed is DRY-L during thermostat ON, SSSo during thermostat OFF

(Lo ≥ DRY-L ≥ SSSo)

15.3 Fan Operation

- Fan operation can be set using remote control.
- The indoor fan is operated according to remote control setting and to enable air circulation in the room.

15.4 Thermostat Control

- Depending on differences between room temperature, setting temperature and outdoor temperature, compressor operation is decided and starts operation.
- If temperature difference matches values shown below, thermostat switches off.

Model	S-71WF3E
Cool Mode	0.0°C
Dry Mode	0.0°C

15.4.1 Indoor Fan Control

- Manual Fan Speed
Operation starts at Hi, Me+, Me, Me- or Lo speed set by remote control.
- Auto Fan Speed
When operation starts, or shifting to thermostat ON condition from thermostat OFF condition, indoor fan operates as below.

- (1) The indoor fan speed is controlled as shown below during the automatic fan speed.
- (2) The fan speed does not change for 3 minutes during cooling operation once it is changed.

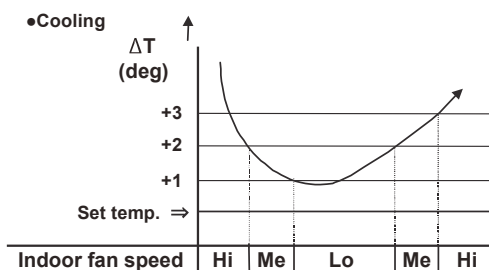

15.4.2 Outdoor Fan Control

Outdoor fan motor is operated with variable fan speed depend on compressor frequency and outdoor ambient temperature. Outdoor fan turns on when compressor starts to operate. But outdoor fan will turn off 30 seconds after compressor stops to operate.

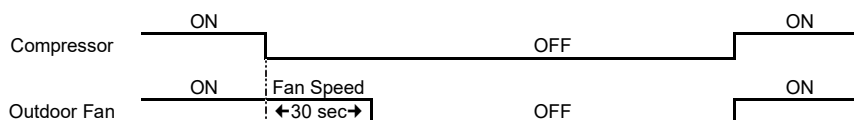

15.5 nanoe™X Operation

- Generate nanoe™X (water wrapped ion particle) to moisturize skin, provide deodorization & sterilization effect.
- nanoe™X operation start condition
 - During unit running at any operation mode, if nanoe™X operation is activated, combination operation (operation mode + nanoe™X operation) starts.
 - During unit is OFF, if nanoe™X operation is activated, nanoe™X individual operation starts.
- nanoe™X operation stop condition
 - When OFF/ON button is pressed to stop the operation.
 - When nanoe™X button is pressed.
 - When OFF Timer activates.
- nanoe™X operation pause condition
 - When indoor fan stop (during deice, odor cut control, thermostat off, etc.). nanoe™X operation resume after indoor fan restarts.
 - When indoor intake temperature $\geq 35^{\circ}\text{C}$ and $\leq 5^{\circ}\text{C}$. nanoe™X operation resume after indoor intake temperature $< 35^{\circ}\text{C}$ or $\geq 5^{\circ}\text{C}$ continuously for 6 minutes.
- Indoor fan control
 - During any operation mode combines with nanoe™X operation, fan speed follows respective operation mode. However, nanoe™X system enabled when fan speed ≥ 430 rpm to ensure proper negative ion distribution, nanoe™X system disabled when fan speed < 430 rpm.
 - During nanoe™X individual operation, fan speed follow remote control setting. Auto Fan Speed for nanoe™X individual operation is cooling medium fan.
- Airflow direction control
 - During any operation mode combines with nanoe™X operation, airflow direction follows respective operation mode.
 - During nanoe™X individual operation, Air Swing follow remote control setting.
- Timer control
 - When ON Timer activates when unit stops, previous operation resumes and restored last saved nanoe™X operation status.
 - When ON Timer activates during any operation, no change on current operation.
 - When OFF Timer activates during any operation, all operation stops and the latest nanoe™X operation status is saved.
- Indicator
 - When nanoe™X starts, nanoe™X indicator ON.
- Remote control receiving sound
 - Normal Operation → nanoe™X Operation : Beep
 - nanoe™X Operation → Normal Operation : Beep
 - Stop → nanoe™X individual Operation : Beep
 - nanoe™X individual Operation → Stop : Long Beep
- Power failure
 - During nanoe™X individual operation, if power failure occurs, after power resumes, nanoe™X individual operation resumes immediately.
 - During combination operation, if power failure occurs, after power resumes, combination operation resume immediately.

16. Operation Control (CU-2WZ71YBE5)

16.1 Cooling Operation

16.1.1 Outdoor fan control

- When cooling operation is enabled, based on outdoor ambient temperature, fan motor control will be adjusted according to figure below:

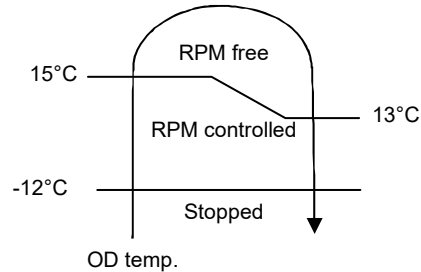

16.1.2 Annual Cooling control

- This control is to enable cooling operation when outdoor ambient temperature is low.
- Control start conditions:
 - Cooling operation is activated with compressor ON.
 - Outdoor ambient temperature is less than 15°C.
- Control contents:
 - When the above conditions are fulfilled, based on outdoor pipe temperature, the outdoor fan motor will operate according to figure below:

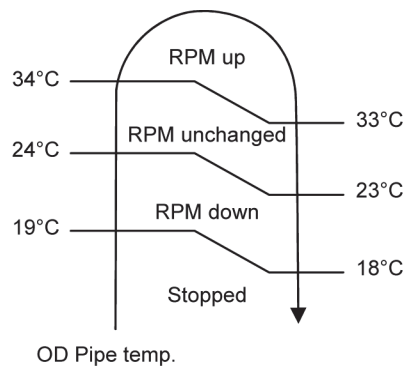

- To improve the judgment accuracy during annual cooling control, outdoor ambient temperature sampling for 2 minutes will be activated every 35 minutes under designated fan speed.
- Control stop conditions:
 - When either one of the start conditions are not complied.

16.1.3 Outdoor Cooling Quiet Operation Control

- Purpose
Provide quiet cooling operation when only 1 indoor in operation.
- Start Condition
 - Indoor fan speed is lower than Lo fan.
 - Only 1 operation indoor unit.
 - Not in any cooling overload zone.
 - Not during annual cooling
 - Not initial frequency operation.
 - Not during starting control.
 - During cool mode
 - Not in Heat Recovery mode.All conditions above are satisfied and function selection enable.
- Control Contents
Compressor frequency and outdoor fan speed maximum limit is set. Adjust accordingly.
- Cancel Condition
 - Indoor fan speed is equal or higher than Lo fan.
 - > 1 operation indoor unit.
 - In any cooling overload zone.
 - During annual cooling
 - Initial frequency operation.
 - During starting control.
 - Not during cool modeWhen any above is satisfied

16.2 Heating Operation (Room Heating / Tank Heating)

16.2.1 Outdoor fan control

- When heating operation is enabled, based on outdoor ambient temperature, fan motor control will be adjusted according to figure below for Heating overload control:

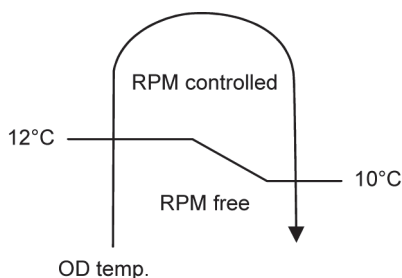

16.2.2 Powerful Operation 2

- During cooling / heating operation, this control is to provide fast cooling / heating operation compare to normal operation.
- Operation start if all condition below are complied:
 - Powerful operation ON for indoor unit.
 - Not under Annual Cooling control.
 - Not in freeze / dew prevention status.
 - Not in Heat recovery mode.
- Operation content:
 - Outdoor fan speed will adjust automatically.
 - Compressor frequency will adjust automatically.
- Operation stop when comply either one of the follow conditions:
 - When the powerful operation is OFF for all indoor units.
 - When annual cooling control activated.
 - When freeze / dew prevention control is activated.

16.2.3 Heating Quiet Operation

- Provide Quiet heating operation when only 1 room / 1 tank in operation.

Starting Condition.

- Indoor fan speed is lower than low fan → only available for room indoor.
- Quiet mode signal (Level 1, 2, 3) is set → only available for tank.
- Only 1 operation indoor / tank unit.
- Not initial frequency operation.
- Not in any of heating overload zone.
- * All condition above are satisfied.

Control Contents.

Compressor frequency and outdoor fan speed maximum limit is set.

Cancel Condition.

- Indoor fan speed is higher or equal to low fan (only available for room indoor).
- Quiet mode signal is cancelled (only available for tank unit).
- > 1 operation room or tank unit.
- During initial frequency operation.
- During any of heating overload zone.
- When any of above condition is satisfied.

17. Simultaneous Operation Control

17.1 Simultaneous Operation (Multiple Indoor Units)

- Operation modes which can be selected using the remote control unit:
 - Automatic, Cooling, Dry, Heating and nanoe operation mode.
- Types of operation modes which can be performed simultaneously
 - Cooling operation and Cooling, Dry or nanoe operation.
 - Heating operation and Heating operation.
- Types of operation modes which cannot be performed simultaneously
 - During cooling operation, heating operation is impossible at another indoor unit in another room. (However, heating operation at tank unit is possible. The unit will be set into Heat Recovery mode.)
 - The priority is given to cooling operation if the cooling mode is selected first. In another room where heating mode is selected afterward, the POWER LED blinks to indicate the heating operation is in standby condition, where the fan is stopped hence no discharged air.
 - During heating operation, cooling operation is impossible at another indoor unit in another room.
 - The priority is given to heating operation if the heating mode is selected first. In another room where cooling mode is selected afterward, the POWER LED blinks to indicate the cooling operation is in standby condition, where the fan is stopped hence no discharged air.
- Operation mode priority control
 - The operation mode designated first by the indoor unit has priority.
 - If the priority indoor unit stops operation or initiates the fan operation, the priority is transferred to other indoor units.

“Waiting” denotes the standby status in which the POWER LED blinks (ON for 2.5 seconds and OFF for 0.5 seconds) and the fan is stopped.

		ROOM A	Non Priority Unit (2 nd ON)			
			Cooling	Dry	Heating	nanoe
Priority Unit (1 st ON)	ROOM B					
	Cooling	C	D	Waiting	E	
	Dry	C	C	C	C	
	Heating	C	D	Waiting	E	
	e-ion	D	D	D	D	
		Waiting	Waiting	H	Stop	
		H	H	H	H	
		C	D	H	E	
		E	E	Stop	E	

In the e-ion mode, priority is transferred to a non-priority unit.

Note

- C: Cooling operation mode
- D: Dry operation mode
- H: Heating operation mode
- E: nanoe operation mode

* When tank unit is set into Force DHW heating, all the operation at room units is stopped. The room units operation will be resumed only after the Force DHW mode is cancelled.

17.2 Simultaneous Operation (Indoor Unit + Tank Unit)

Category	Room	Tank	Mode
Cooling	Cooling	OFF	Cooling
	Cooling	Heating	Heat Recovery
Heating	Heating	OFF	Heating
	OFF	Heating	Tank Heating
	Heating	Heating	Bi-Heating

When different combination of operation setting is set at indoor unit and tank unit, different mode is carried out.

17.2.1 Heat Recovery Mode

This mode is to utilise the waste energy to heat up the tank unit, instead of wasted to outdoor ambient.

The mode is allowed if all of the conditions below are satisfied.

- Indoor unit is set at Cooling operation and it is not in Quiet or Powerful operation
- Tank unit is set at Heating operation and it is not in Force DHW mode
- Outdoor temperature is higher than 10°C
- Not in starting control

Operation content:

Heat recovery mode is carried out

17.2.2 Bi-Heating Mode

This mode is to operate heating operation at indoor unit and tank unit simultaneously.

The mode is allowed if all of the conditions below are satisfied.

- Indoor unit is set at Heating operation
- Tank unit is set at Heating operation and it is not in Force DHW mode
- Outdoor temperature is higher than -5°C
(If outdoor temperature is lower than -5°C, the water inlet temperature has to be lower than 40°C)
- Not in starting control

Operation content:

Bi-Heating mode is carried out

17.2.3 Mode Change

When the combination of operation setting is changed, the mode is changed from one to another.

If the mode change is within the same category (Cooling or Heating), the mode change is carried out by changing the 4-way valve and expansion valve setting, followed to the predetermined control setting.

During this process, the compressor operates in a low frequency setting.

If the mode change is in the different category (Cooling <--> Heating), the compressor stops.

After 3 minutes, the compressor restarts and the 4-way valves and expansion valves setting follows to the predetermined control setting in order to operate in the target mode.

17.2.4 4-way Valve Setting Change

During mode change, the 4-way valve setting is changed when

1. it involves the category change
2. it involves the tank unit operation setting change (OFF <--> Heating)

When 4-way valve setting is changed, there is a intermittent refrigerant gushing sound can be heard at outdoor unit.

18. Protection Control (WH-ADF0309J3E5CM)

18.1 Protection Control for Heating Operation

18.1.1 Force Defrost Operation

Force defrost can be set through remote control.

- If force defrost request from quick menu of remote control, outdoor will run force defrost at heat mode if fulfilled certain condition.

19. Protection Control (CU-2WZ71YBE5)

19.1 Freeze Prevention control (Cool)

- When received freeze prevention signal from indoor unit, the compressor frequency changes according to indoor heat exchanger temperature.
- When indoor unit request capability OFF due to freeze condition, immediately the capability supply to targeted indoor unit stops.

19.2 Dew Prevention control (Cool)

- When received dew prevention signal from indoor unit, which according to indoor intake temperature and indoor heat exchanger temperature the compressor frequency changes.

19.3 Electronic Parts Temperature Rise Protection 1 (Cool)

- This control prevents electronic parts temperature rise during cooling overload condition.
- Start conditions:
 - Outdoor ambient temperature is at protection region as shown in figure below:

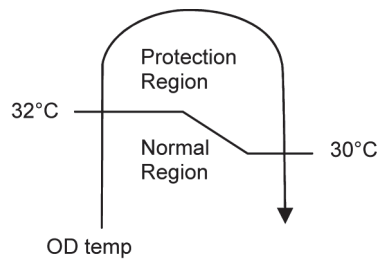

- Outdoor unit total current is above 11.6A.
- Control content
 - Outdoor fan speed is adjusted accordingly.
- Control stop condition
 - When outdoor ambient temperature is back to normal region.

19.4 Cooling overload control (Cool)

- This control detect compressor discharge pressure and perform the compressor frequency restriction during cooling operation.

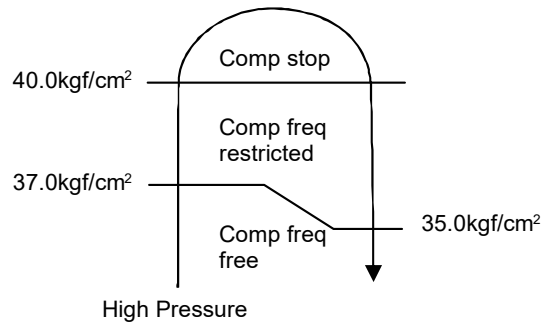

* The high pressure value may be lower by 0 ~ 6kgf/cm². Depends on the compressor frequency.

19.5 Heating overload control (Heat)

- This control detect compressor discharge pressure and perform the compressor frequency restriction during heating operation.

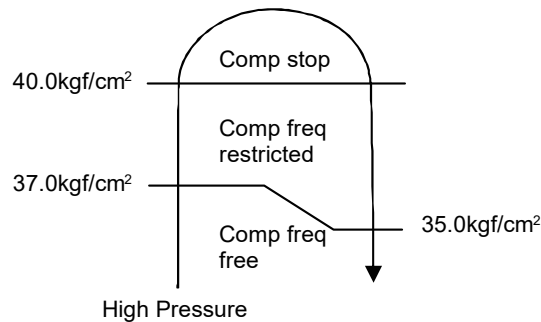

- This control detect outdoor ambient temperature and perform the fan speed adjustment during heating operation.

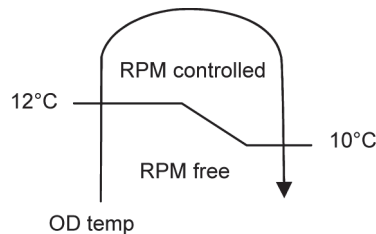

19.6 Extreme Low Temperature Compressor low pressure protection control (Heat)

- This control is to prevent low pressure drops too low during extremely low outdoor ambient temperature to improve the compressor reliability.
- During heating operation, when outdoor ambient temperature is in Zone 1, this control will be activated. Compressor frequency restriction will be based on outdoor piping temperature.

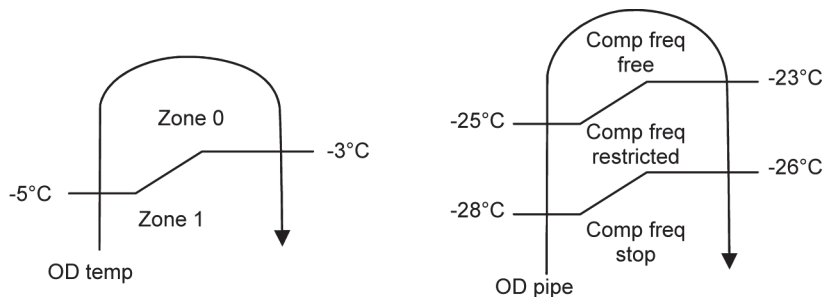

19.7 Deice Control

- When outdoor pipe temperature and outdoor air temperature is low, deice operation starts where indoor fan motor and outdoor fan motor stop, indoor unit horizontal vane close and operation LED blink with compressor ON.

19.8 Time Delay Safety Control (Restart Control)

- The compressor will not restart within three minutes after compressor is stopped.
- This control is not applicable if the power supply reset or after deice condition.

19.9 30 seconds Force Operation

- Once the compressor starts operation, it will not stop its operation for 30 seconds in order to cycle back compressor oil.
- However, it can be stopped using remote control or Auto OFF/ON button at indoor unit.

19.10 Total Current Control

- By referring to table below, during normal (default) operation, the running current refer to Hi values and during Power Save Mode, the running current refer to Lo values.
- When the outdoor unit total running current (AC) exceeds X value, compressor frequency will decrease.
- If the running current does not exceed X value for 5 seconds, compressor frequency will increase.
- However, if total outdoor unit running current exceeds Y value, compressor will be stopped immediately for 3 minutes.

Current Table

Model		2WZ71YBE5	
		Hi	Lo
Cool (X)	A	16.56	11.55
	B	12.56	8.82
	C	11.55	
Heat Recovery (X)	A	17.47	12.38
	B	14.42	10.12
	C	14.42	
Heat (X)		19.45	14.33
Y		23.06	

Current Control

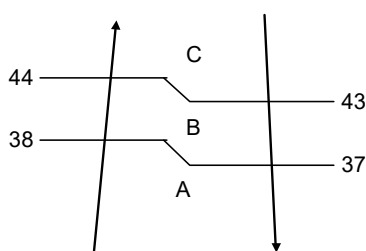

19.11 IPM (power transistor) Protection Control

- Overheating Prevention Control
 - If IPM temperature rises to 80°C, outdoor fan speed will be increased.
 - When the IPM temperature rises to 95°C, compressor operation will stop immediately.
 - Compressor operation restarts when temperature decreases to 90°C.
 - If IPM temperature detected less than -30°C, IPM is judged as open circuit ("F96" is indicated).
- DC peak current control
 - When IPMDC current exceeds set value of 40 ± 3.0 A, the compressor will stop.
 - If the DC peak current detected within 30 seconds after operation starts, compressor will restart after 1 minute.
 - If the DC peak current detected 30 seconds or more after operation starts, compressor will restart after 2 minutes.
 - Within 30 seconds after compressor restarts, if the DC peak current is exceeded set value continuously for 7 times, all indoor and outdoor relays will be cut off ("F99" is indicated).
- Error reset can be done by power supply reset.

19.12 Compressor Protection Control (Gas leak detection control 1)

- Control start conditions
 - For 5 minutes (cool & dry), 8 minutes (heating), the compressor continuously operates and total current is low.
 - High pressure < 21kgf/cm².
 - During Cooling or Soft Dry operation:
Indoor intake temperature — indoor piping temperature is below 4°C.
 - During Heating operation:
Indoor pipe temperature — indoor intake temperature is below 2°C.
 - Not during deice control.
 - Compressor ON with maximum frequency.
- Control content
 - Compressor stops (and restart after 3 minutes)
 - If the conditions above happen 4 times within 60 minutes, the unit will stop operation ("F91" is indicated).

19.13 Compressor Protection Control (Gas leak detection control 2)

- This control detect gas leakage condition to prevent compressor damage.
- Control start condition
 - All connected indoor units capability supply ON.
 - Compressor ON with maximum frequency.
 - Not during annual cooling.
 - Compressor discharge temperature high.
- Control content
 - Compressor OFF during this control ("F91" is memorized in EEPROM)
 - If the above conditions happen 2 times within 60 minutes, indoor units' Timer LED will blinks ("F91" is indicated at all indoor units)

19.14 Valve close detection control

- This control detects 3-way valve close condition to prevent damage to refrigerant cycle.
- Start conditions:
 - For all connected indoor units, if Indoor intake temperature — indoor piping temperature are between -2°C and 2°C continuously for 8 minutes after compressor ON at first cooling operation.
 - The first cooling operation is defined as cooling operation is ON for less than 8 minutes after new installation or after pump down.
- Control content
 - During this control, compressor stop, indoor units' Timer LED will blink. ("F91" is indicated at indoor units)
- Error reset can be done by power supply reset or reset by using remote control.

19.15 Compressor discharge high pressure protection control

- This control protect by using high pressure switch during operation.
- Start conditions
 - High pressure switch is activated (from normally close to open) when outdoor operation mode is cooling or heating during compressor running.
- Control 1 content
 - Compressor stop when high pressure switch is opened and restart after high pressure switch closed. If this condition happen 4 times within 30 minutes, "F94" is indicated.
 - After 30 minutes, counter is reset if this condition does not happen for 4 times.
- Control 1 stop conditions
 - Power supply reset
 - Reset by using remote control

19.16 Compressor discharge high temperature protection control

This control detect compressor tank temperature (CU-2WZ71YBE5) and perform the compressor frequency restriction.

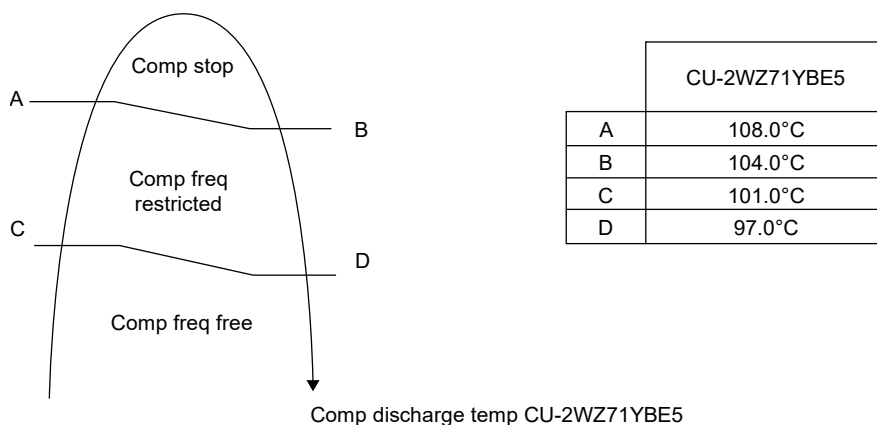

When the discharge temperature more than 108°C, the compressor stops. If this conditions happens for 3 times within 30 minutes, "F97" is indicated.

19.17 Cooling Outdoor Air Temperature Control (Cool)

- The compressor will be stopped to avoid compressor overloading.

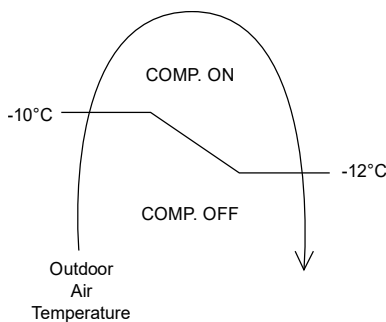

19.18 Heating Outdoor Air Temperature Control (Heat)

- The compressor will be stopped to avoid compressor overloading.

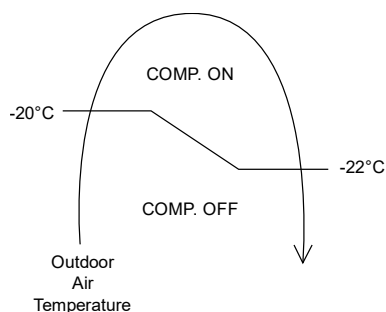

20. Servicing Mode

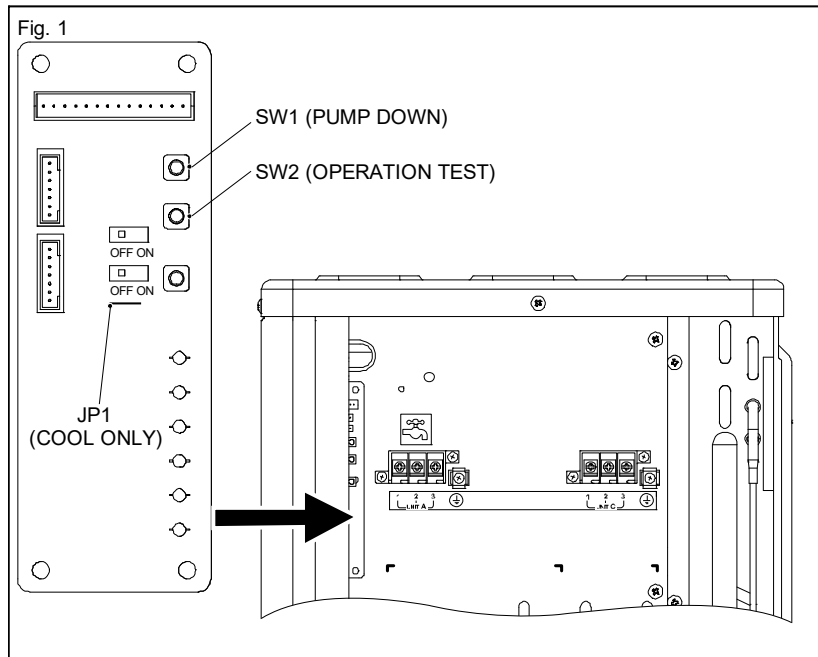

20.1.1 Pump Down Operation

- Operate the pump down according to the following procedures.

- Confirm all the 4pcs of 3-way valve on liquid and gas side are open.
- Connect pressure gauge to gas side of 3-way valve for Duct unit (recommended).
- Press PUMP DOWN switch (SW1) on the display printed circuit board for more than 5 seconds. Pump down (cooling) operation is performed for 15 minutes.
- Set the liquid side 3-way valve for Tank unit to close position followed by liquid side 3-ways valve for Duct unit and wait until the pressure gauge indicates 0.01 MPa (0.1 kg/cm²G).
- Immediately set the gas side 3-way valve for Tank unit to close position followed by gas side 3-way valve for Duct unit and then press the PUMP DOWN switch (SW1) to stop the pump down operation.

Note: Pump down operation will stop automatically after 15 minutes if PUMP DOWN switch (SW1) is not pressed again.

Pump down operation is not started within 3 minutes after compressor is stopped.

LED	2	3	4	5	Message
Status	○	○	○	○	Pump down operation progress
	○	○	○		3 minutes before operation end
	○	○			2 minutes before operation end
	○				1 minute before operation end
					Pump down operation end

○: Flashing

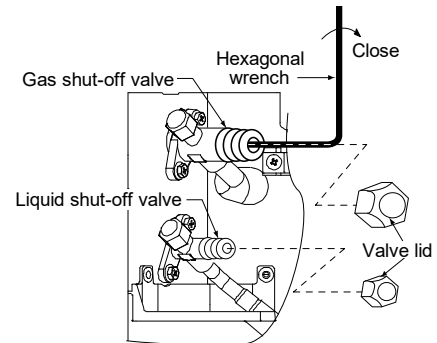

20.1.2 Test Run Operation

- Test operation can be carried out using TEST OPERATION button (SW2) on the Service PCB inside the outdoor unit.
- For Cooling test, press the TEST OPERATION button (SW2) for 5 seconds or more but less than 10 seconds, LED1 and LED 2 will illuminate when shift into cooling test operation.
- For Heating test, press the TEST OPERATION button (SW2) for more than 10 seconds, LED 1 and LED 3 will illuminate when shift into heating test operation.
- Press the TEST OPERATION button (SW2) again to cancel test operation.

20.1.3 Power Save Mode

- Power Save Mode can be enabled by pushing POWER SAVE switch (SW4) to ON before power supply ON.
- When Power Save Mode is ON, the unit can be operate at lower running current where the breaker capacity not achieve the requirement.

20.1.4 Mode priority function

- Mode priority function can be enabled by pushing MODE PRIORITY switch (SW5) to ON before power supply ON.
- When Mode Priority Function is ON, the mode priority is given to higher capacity indoor units.

20.1.5 Cooling only function

- The unit capable to limit the operation mode to Cooling Mode only (Heating mode disabled) by cutting JP1 (COOL ONLY) before power supply ON.
- This function prevent wrong operation during the unit installed in server room.
- This function could be disabled again by short the JP1 (COOL ONLY) before power supply ON.
- However, tank heating operation is still allowed even if the cooling only function is set.

21. Servicing Guide (WH-ADC0309J3E5CM)

21.1 How to Take out Front Plate

Open and Close Front Plate ⑩

- 1 Remove the 2 mounting screws of Front Plate ⑩.
- 2 Slide it upwards to unhook the Front Plate ⑩ hook.
- 3 Reverse above steps 1~2 for close it.

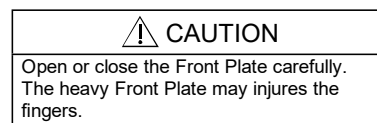
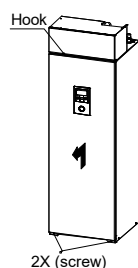

21.2 Test Run

- 1 Before test run, make sure below items have been checked:-
 - a) Pipework are properly done.
 - b) Electric cable connecting work are properly done.
 - c) Tank Unit is filled up with water and trapped air is released.
 - d) Please turn on the power supply after filling the tank until full.
- 2 Switch ON the power supply of the Tank Unit. Set the Tank Unit RCCB/ELCB to "ON" condition. Then, please refer to the Operation Instruction for operation of Remote Controller ①.

Note:

- During winter, turn on the power supply and standby the unit for at least 15 minutes before test run. Allow sufficient time to warm up refrigerant and prevent wrong error code judgement.

- 3 For normal operation, Water Pressure Gauge ⑮ reading should be in between 0.05 MPa and 0.3 MPa.
- 4 During test run, use a container to collect high volume of discharge water from Pressure Relief Valve ⑬ discharge hose.
- 5 After test run, please clean the Magnetic Water Filter Set ⑦. Reinstall it after finish cleaning.

21.3 Expansion Vessel ⑪ Pre Pressure Checking

For Space Heating

- Expansion Vessel ⑪ with 10 L air capacity and initial pressure of 1 bar is installed in this Tank Unit.
- Total amount of water in system should be below 200 L.
(Inner volume of Tank Unit's piping is about 5 L)
- If total amount of water is over 200 L, please add another expansion vessel. (field supply)
- Please keep the installation height difference of system water circuit within 10 m.

21.4 How To Adjust Pump Speed

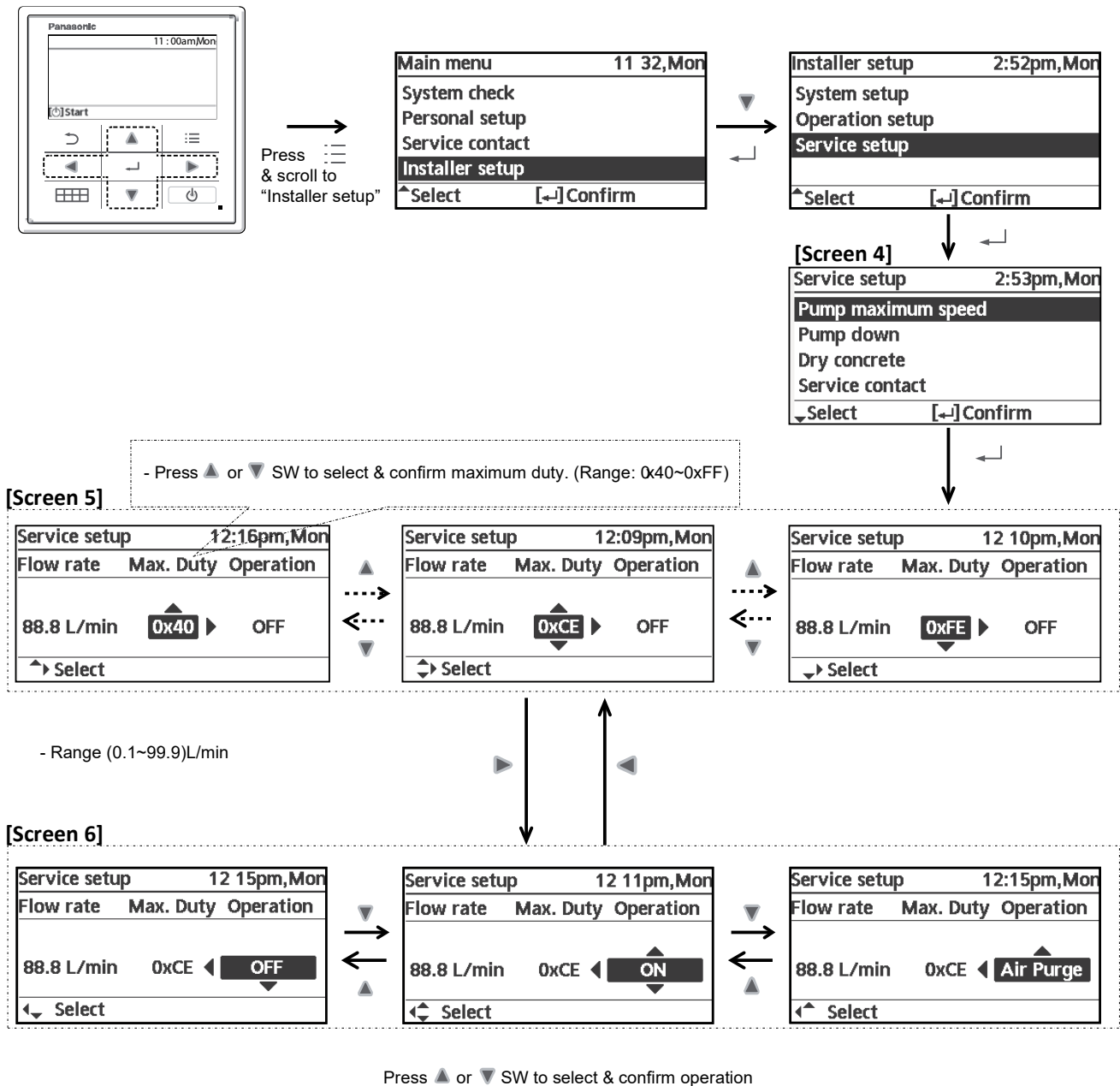

NOTE:

1. Whenever at [Screen 5], if press SW to OFF, pump operation should be turned OFF.
2. Whenever at [Screen 6], if press SW to OFF, pump operation should be turned OFF.

21.5 EEPROM Factory Default Data Setup Procedure

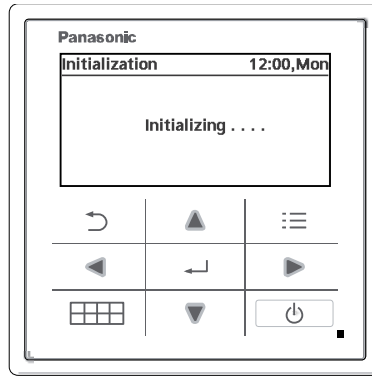

- EEPROM default data setup is only possible during initialization process.
- Press (▲ , ▼ , ◀ , ▶) simultaneously for 5secs continuously, initialization process will stop & EEPROM default data setup process will start.

During EEPROM default data setup process, display should be as shown below.

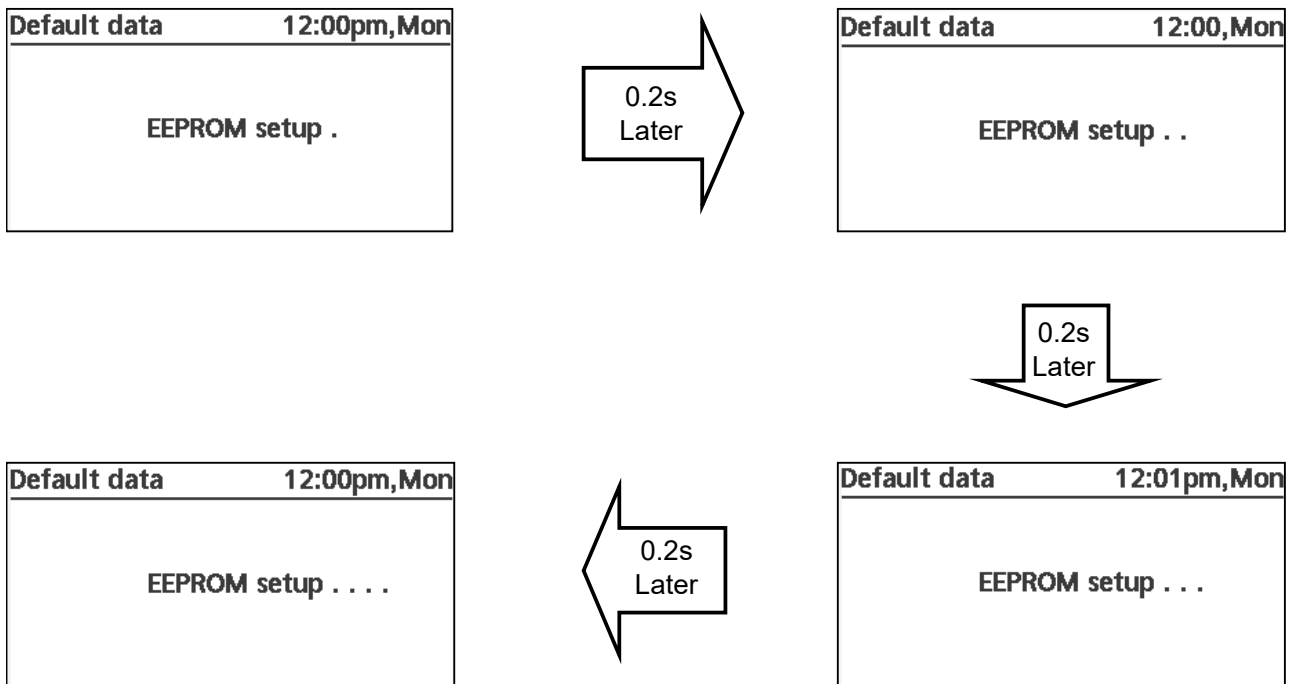

- Once EEPROM default data setup process is complete, initialization process will re-start from beginning.

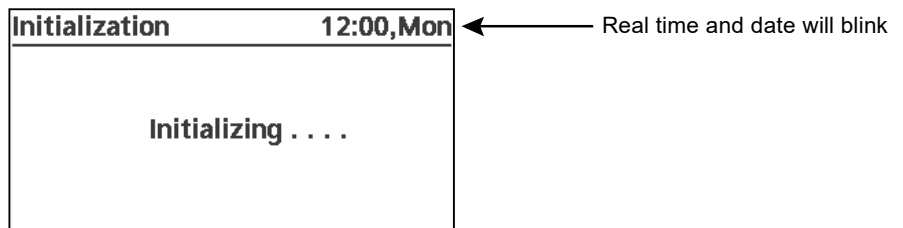

21.6 Dry Concrete Setup

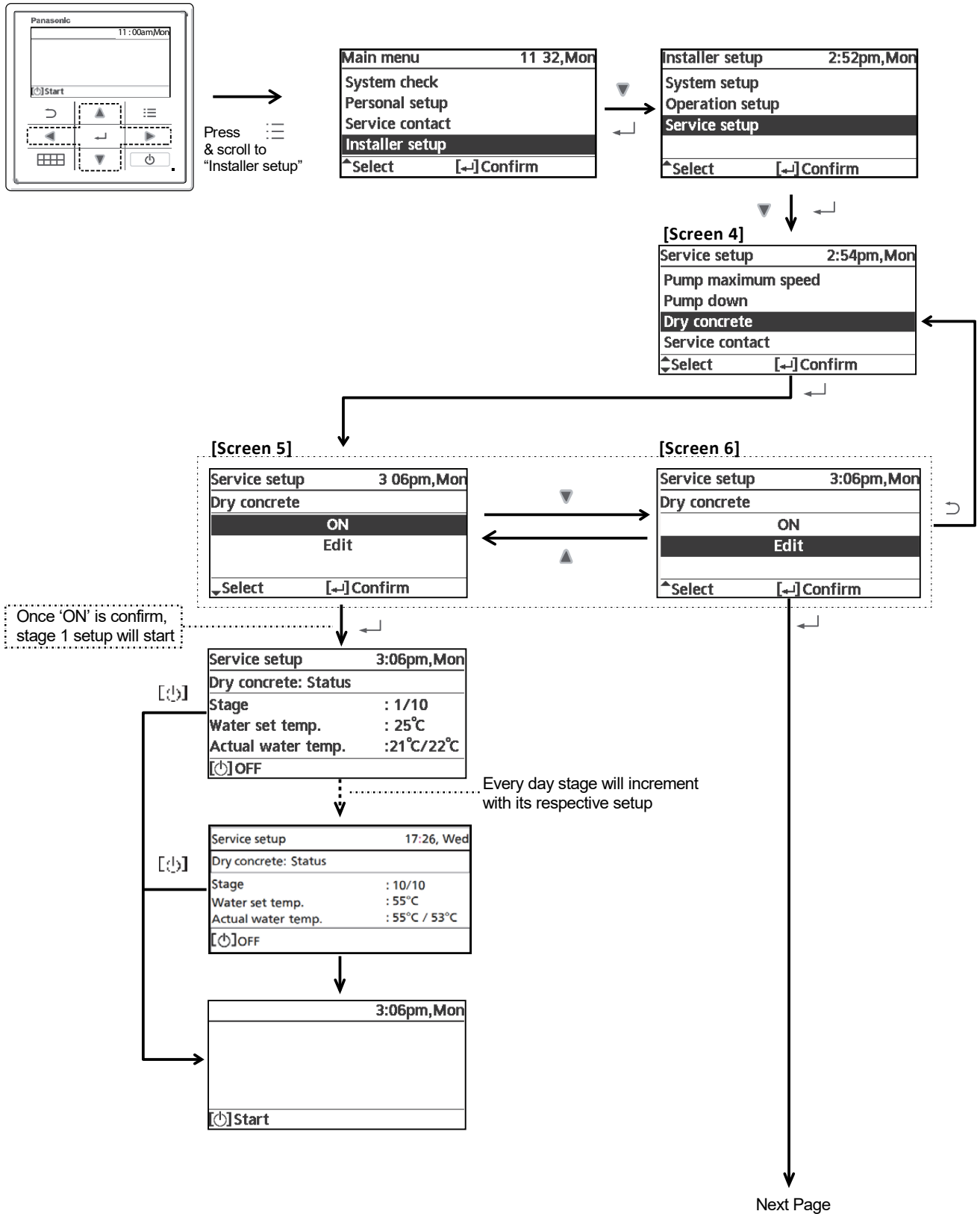

- Press ▲ or ▼ button to select no. of stages.
 - Press ↵ to store latest status.
 - Press ⏪ button, display will return to [Screen 6].

- If suppose to select 10 stages, then setup will start from stage 1/10.
 - Press ▲ or ▼ button to select set temperature.
 - Press ↵ button to store latest status.

- Move to next stage 2/10
 - Repeat the same procedure

- Move to next stage 10/10
 - Repeat the same procedure.
 - Press ↵ to store latest status the the display will return to [Screen 4]
 - Press ⏪ button to return to stage 9/10.

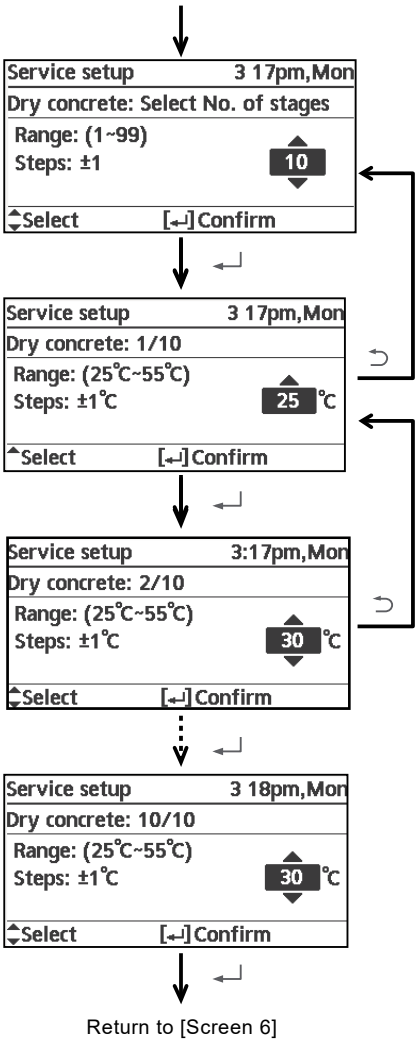

22. Maintenance Guide

In order to ensure safety and optimal performance of the Tank Unit, seasonal inspections on the Tank Unit, functional check of RCCB/ELCB, field wiring and piping have to be carried out at regular intervals. This maintenance should be carried out by authorized dealer. Contact dealer for scheduled inspection.

1 Charging and Discharging the Water

Make sure all the piping installations are properly done before carry out below steps.

Charge the Water

• For Domestic Hot Water Tank

- a. Set the Domestic Hot Water Tank Discharge (Drain Tap) ⑨ to "CLOSE".

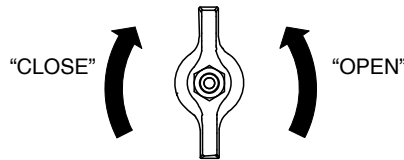

Domestic Hot Water Tank Discharge (Drain Tap) ⑨

- b. Set all Tap / Shower "OPEN".
- c. Start filling water to the Domestic Hot Water Tank via Tube Connector ③.

After 20~40min, water should flow out from Tap / Shower.
Else, please contact your local authorized dealer.
- d. Check and make sure no water leaking at the tube connecting points.
- e. Set the Domestic Hot Water Tank Discharge (Drain Tap) ⑨ to "OPEN" for 10 seconds to release air from this pipeline. Then set it "CLOSE".
- f. Turn the Safety Relief Valve ⑫ knob counterclockwise slightly and hold for 10 seconds to release air from this pipeline. Then recover the knob to original position.
- g. Ensure Step 5 & 6 is carried out each time after charging water to Domestic Hot Water Tank.
- h. To prevent back pressure from happening to the Safety Relief Valve ⑫, do turn the Safety Relief Valve ⑫ knob counterclockwise.

• For Space Heating

- a. Turn the plug on the Air Purge Valve ⑫ outlet anticlockwise by one complete turn from fully closed position.

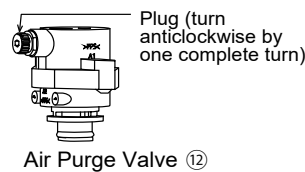

- b. Set the Pressure Relief Valve ⑬ lever "DOWN".

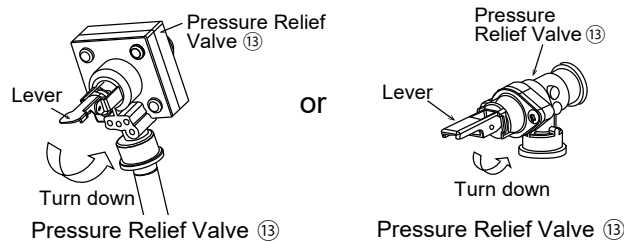

- c. Start filling water (with pressure more than 0.1 MPa (1 bar)) to the Space Heating circuit via Tube Connector ①. Stop filling water if the free water flow through Pressure Relief Valve ⑬ discharge hose.
- d. Turn ON the Tank Unit and make sure Water Pump ② is running.
- e. Check and make sure no water leaking at the tube connecting points.
- f. The water may drip from this discharge hose. Therefore must guide the hose without close or block the outlet of the hose.

Discharge the Water

• For Domestic Hot Water Tank

- a. Turn OFF power supply.
- b. Set the Domestic Hot Water Tank Discharge (Drain Tap) (g) to “OPEN”.
- c. Open Tap / Shower to allow air inlet.
- d. Turn the Safety Relief Valve (22) knob counterclockwise slightly and hold it until all air is released from this pipeline. Then recover the knob to original position after ensured the pipeline is emptied.
- e. After discharge, set Domestic Hot Water Tank Discharge (Drain Tap) (g) to “CLOSE”.

2 Check Water Pressure *(0.1 MPa = 1 bar)

Water pressure should not lower than 0.05 MPa (with inspects the Water Pressure Gauge (15)). If necessary add water into Tank Unit (via Tube Connector (a)).

3 Check Pressure Relief Valve (13)

- o Check for correct operation of Pressure Relief Valve (13) by turning on the lever to become horizontal.
- o If you do not hear a clacking sound (due to water drainage), contact your local authorized dealer.
- o Push down the lever after finish checking.
- o In case the water keep on draining out from the Tank Unit, switch off the system, and then contact your local authorized dealer.

4 Check RCCB/ELCB

Ensure the RCCB/ELCB set to “ON” condition before check RCCB/ELCB.

Turn on the power supply to the Tank Unit.

This testing could only be done when power is supplied to the Tank Unit.

WARNING

Be careful not to touch parts other than RCCB/ELCB test button when the power is supplied to Tank Unit. Else, electrical shock may happen. Before obtaining access to terminals, all supply circuits must be disconnected.

- o Push the “TEST” button on the RCCB/ELCB. The lever would turn down and indicate “0”, if it functions normal.
- o Contact authorized dealer if the RCCB/ELCB malfunction.
- o Turn off the power supply to the Tank Unit.
- o If RCCB/ELCB functions normal, set the lever to “ON” again after testing finish.

5 Reset Overload Protector (10)

Overload Protector (10) a serves the safety purpose to prevent the water over heating. When the Overload Protector (10) trip at high water temperature, take below steps to reset it.

- a. Take out the cover.
- b. Use a test pen to push the centre button gently in order to reset the Overload Protector (10).
- c. Fix the cover to the original fixing condition.

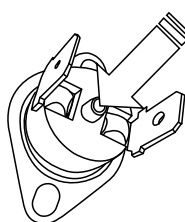

Use test pen to push this button for reset Overload protector (10).

6 Maintenance for Magnetic Water Filter Set (7)

- a. Turn OFF power supply.
- b. Place a container below Magnetic Water Filter Set (7).
- c. Turn to remove the Magnet Bar at bottom of Magnetic Water Filter Set (7).
- d. By using Allen key (8mm), remove the Cap of Discharge Port.
- e. By using Allen Key (4mm), open the Service Valve to release the dirty water from the Discharge Port into a container. Close the service valve when the container is full to avoid spillage in the tank unit. Dispose the dirty water.
- f. Reinstall the Cap of Discharge Port and Magnet Bar.
- g. Re-charging the water to Space Heating circuit if necessary (refer Section 5 for details.)
- h. Turn ON power supply.

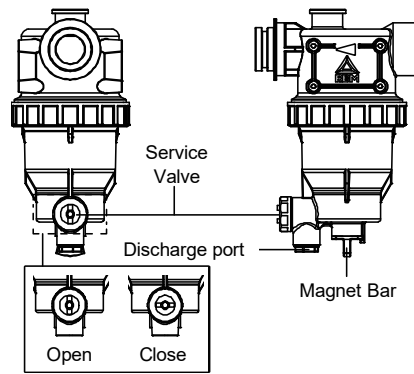

7 Maintenance for Pressure Relief Valve ⑬

It is strongly recommended to operate the valve by turning the lever up & release it down a few times to ensure free water flow through discharge hose at regular intervals to ensure it is not blocked and to remove lime deposit.

Use a container to collect high volume of discharge water from the discharge hose.

8 Maintenance for Safety Relief Valve ⑳

It is strongly recommended to operate the valve by turn the knob counter clockwise to ensure free water flow through discharge pipe at regular intervals to ensure it is not blocked and to remove lime deposit.

22.1 Maintenance for Magnetic Water Filter Set

22.1.1 Service and maintenance

If forget Password and cannot operate remote controller

Press + + for 5 sec.
 Password unlock screen appears, press Confirm and it shall reset.
 Password will become 0000. Please reset it again.
 (NOTE) Only display when it is locked by password.

22.1.2 Maintenance menu

Setting method of Maintenance menu

Maintenance menu	12:00am, Mon
Actuator check	
Test mode	
Sensor setup	
Reset password	
▼ Select	[↵] Confirm

Press + + for 5 sec.

Items that can be set

- ① Actuator check (Manual ON/OFF all functional parts)
 (NOTE) As there is no protection action, please be careful not to cause any error when operating each part (do not turn on pump when there is no water etc.)
- ② Test mode (Test run)
 Normally it is not used.
- ③ Sensor setup (offset gap of detected temp of each sensor within -2~2°C range)
 (NOTE) Please use only when sensor is deviated. It affects temperature control.
- ④ Reset password (Reset password)

22.1.3 Custom menu

Setting method of Custom menu

Custom menu	12:00am, Mon
Back-up heater	
Reset energy monitor	
Reset operation history	
Smart DHW	
▼ Select	[↵] Confirm

Please press + + for 10 sec.

Items that can be set

- ① Backup heater (Use/Do not use Backup heater)
 (NOTE) It is different from to use/not to use backup heater set by client. When this setting is used, heater power on due to protection against frost will be disabled. (Please use this setting when it is required by utility company.)
 By using this setting, it cannot defrost due to low Heating's setting temp and operation may stop (H75)
 Please set under the responsibility of installer. When it stops frequently, it may be due to insufficient circulation flow rate, setting temp of heating is too low etc.
- ② Reset energy monitor (delete memory of Energy monitor)
 Please use when moving house and handover the unit.
- ③ Reset operation history (delete memory of operation history)
 Please use when moving house and handover the unit.
- ④ Smart DHW (Set Smart DHW mode Parameter)
 - a) Start time: Tank reboil at lower ON Temp. onward.
 - b) Stop time: Tank reboil at normal ON Temp. onward.
 - c) ON Temp.: Tank Reboil Temp when Smart DHW start.

22.1.4 Specifications

22.1.4.1 Specifications of fresh water as heat transfer medium in brazed heat exchanger

Parameter	Quality Limits for Tap Water on the Secondary Side
Temperature	Below 60°C
pH	7 to 9
Alkalinity	60mg/l < HCO ₃ < 300mg/l
Conductivity	< 500µS/cm
Hardness	[Ca ⁺ , Mg ⁺] / [HCO ₃ ⁻] > 0.5
Chloride	< 200mg/l at 60°C
Sulphate	[SO ₄ ²⁻] < 100mg/l and [HCO ₃ ⁻] / [SO ₄ ²⁻] > 1
Nitrate	NO ₃ < 100mg/l
Chlorine	< 0.5mg/l

22.1.4.2 External filter

Solids in the water must be filtered.

Minimum filter mesh size required for the field supply external filter in the water inlet is 20 mesh.

23. Breakdown Self Diagnosis Function (WH-ADF0309J3E5CM)

23.1 Self Diagnosis Function (Three Digits Alphanumeric Code)

- When abnormality occur during operation, the system will stop operation, and OFF/ON control panel LED will blink and error code will display on the control panel.
- Even error code is reset by turning OFF power supply or by selecting ERROR RESET, if the system abnormality is still unrepaired, system will again stop operation, and OFF/ON control panel LED will again blinks and error code will be display.
- The error code will store in IC memory.
- **To check the error code**
 1. When an abnormality occurs, system will stop operation and OFF/ON control panel LED will blink.
 2. Error code of the abnormality will be display on the control panel.
 3. To determine the abnormality description, the error code table needs to be referred.

eg:

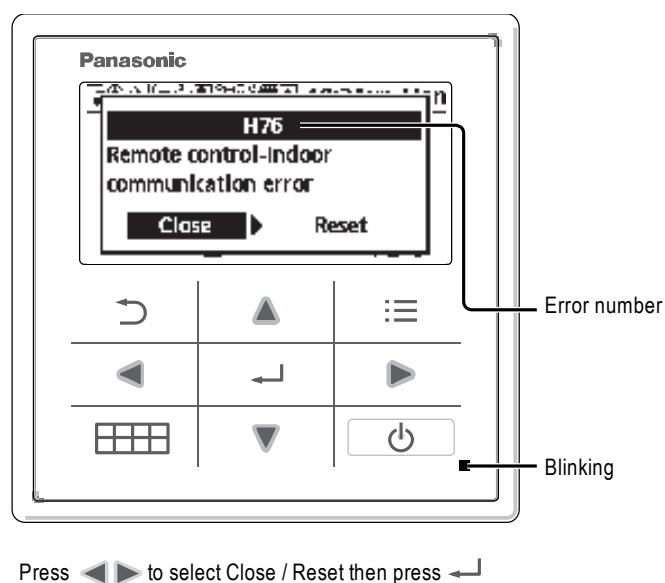

- **To display past/last error code**
 1. Turn ON power supply.
 2. Refer below procedure to retrieve the error code history.
- **To permanently delete error code from IC memory**
 1. Turn ON power supply.
 2. Refer below procedure to clear error history.

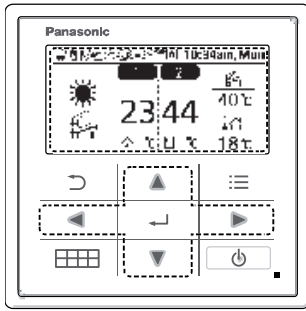

Press button and select "System Check"

Main menu	9:17am, Mon
Function setup	
System check	
Personal setup	
Service contact	
↕Select	[↔] Confirm

System check	9:34am, Mon
Energy monitor	
Water temperatures	
Error history	
Compressor	
↕Select	[↔] Confirm

Press SW to select "Error history"

[Screen 4]

System check	9 43am, Mon
Energy monitor	
Water temperatures	
Error history	
Compressor	
↕Select	[↔] Confirm

Display last 4 error retrieved from EEPROM

Error history	8 23am, Mon
1. H76 (2015/05/18)	
2. H15 (2015/05/18)	
3. H70 (2015/05/18)	
4. H76 (2015/05/18)	
[↔] Clear history	

Do you want to clear error history?	
Yes	No

Do you want to clear error history?	
Yes	No

Error history	9 41am, Mon
1. --	
2. --	
3. --	
4. --	
[↔] Clear history	

23.2 Error Codes Table

Diagnosis display	Abnormality/Protection control	Abnormality judgement	Primary location to verify
H00	No abnormality detected	—	—
H12	Indoor/Outdoor capacity unmatched	90s after power supply	<ul style="list-style-type: none"> Total indoor capability more than maximum limit or less than minimum limit, or number of indoor unit less than two.
H15	Outdoor compressor temperature sensor abnormality	Continue for 5 sec.	<ul style="list-style-type: none"> Compressor temperature sensor (defective or disconnected)
H20	Water pump abnormality	Continue for 10 sec.	<ul style="list-style-type: none"> Indoor PCB Water pump (malfunction)
H23	Indoor refrigerant liquid temperature sensor abnormality	Continue for 5 sec.	<ul style="list-style-type: none"> Refrigerant liquid temperature sensor (defective or disconnected)
H27	Service valve error	Continue for 5 minutes	<ul style="list-style-type: none"> High pressure sensor (defective or disconnected)
H28	Abnormal solar sensor	Continue for 5 sec.	<ul style="list-style-type: none"> Solar temperature sensor (defective or disconnected)
H31	Abnormal swimming pool sensor	Continue for 5 sec.	<ul style="list-style-type: none"> Pool temperature sensor (defective or disconnected)
H36	Abnormal buffer tank sensor	Continue for 5 sec.	<ul style="list-style-type: none"> Buffer tank sensor (defective or disconnected)
H38	Brand code not match	When indoor and outdoor brand code not same	—
H41	Indoor or Standby Unit Error	3 times occurrence within 40 minutes	<ul style="list-style-type: none"> Other indoor standby unit error, wrong wiring & connecting pipe, or expansion valve leakage
H42	Compressor low pressure abnormality	—	<ul style="list-style-type: none"> Outdoor pipe temperature sensor Clogged expansion valve or strainer Insufficient refrigerant Outdoor PCB Compressor
H43	Abnormal Zone 1 sensor	Continue for 5 sec.	<ul style="list-style-type: none"> Water temperature Zone 1 sensor
H44	Abnormal Zone 2 sensor	Continue for 5 sec.	<ul style="list-style-type: none"> Water temperature Zone 2 sensor
H51	Outdoor gas pipe temperature sensor abnormality	Continue for 5 sec.	<ul style="list-style-type: none"> Outdoor gas pipe sensor (defective or disconnected)
H53	Outdoor liquid pipe temperature sensor abnormality	Continue for 5 sec.	<ul style="list-style-type: none"> Outdoor liquid pipe sensor (defective or disconnected)
H62	Water flow switch abnormality	Continue for 160 sec.	<ul style="list-style-type: none"> Water flow switch
*H63	Refrigerant low pressure abnormality	Continue for 5 sec.	<ul style="list-style-type: none"> Outdoor low pressure sensor (defective or disconnected)
H64	Refrigerant high pressure abnormality	Continue for 5 sec.	<ul style="list-style-type: none"> Outdoor high pressure sensor (defective or disconnected)
*H65	Deice circulation error	Continue for 10 sec.	<ul style="list-style-type: none"> Water flow switch sensor (defective or disconnected) Water pump malfunction Buffer tank (is used)
H67	Abnormal External Thermistor 1	Continue for 5 sec.	<ul style="list-style-type: none"> Room temperature Zone 1 sensor
H68	Abnormal External Thermistor 2	Continue for 5 sec.	<ul style="list-style-type: none"> Room temperature Zone 2 sensor
H70	Back-up heater OLP abnormality	Continue for 60 sec.	<ul style="list-style-type: none"> Back-up heater OLP (Disconnection or activated)
H72	Tank sensor abnormal	Continue for 5 sec.	<ul style="list-style-type: none"> Tank sensor
H74	PCB communication error	Communication or transfer error	<ul style="list-style-type: none"> Indoor main PCB and Sub PCB
H75	Low water temperature control	Room heater disable and deice request to operate under low water temperature	<ul style="list-style-type: none"> Heater operation must enable to increase water temperature
H76	Indoor - control panel communication abnormality	—	<ul style="list-style-type: none"> Indoor - control panel (defective or disconnected)
H90	Indoor/outdoor abnormal communication	> 1 min after starting operation	<ul style="list-style-type: none"> Internal/external cable connections Indoor/Outdoor PCB
H91	Tank heater OLP abnormality	Continue for 60 sec.	<ul style="list-style-type: none"> Tank heater OLP (Disconnection or activated)

Diagnosis display	Abnormality/Protection control	Abnormality judgement	Primary location to verify
H95	Indoor/Outdoor wrong connection	—	<ul style="list-style-type: none"> Indoor/Outdoor supply voltage
H98 / F95	Outdoor high pressure overload protection Cooling high pressure overload protection	—	<ul style="list-style-type: none"> Outdoor high pressure sensor Water pump or water leakage Clogged expansion valve or strainer Excess refrigerant Room Air Filter dirty or air circulation short circuit
H99	Indoor heat exchanger freeze prevention	—	<ul style="list-style-type: none"> Indoor heat exchanger Refrigerant shortage
F12	Pressure switch activate	4 times occurrence within 30 minutes	<ul style="list-style-type: none"> Pressure switch
F14	Outdoor compressor abnormal revolution	4 times occurrence within 20 minutes	<ul style="list-style-type: none"> Power transistor module faulty or compressor lock
F15	Outdoor fan motor lock abnormality	2 times occurrence within 30 minutes	<ul style="list-style-type: none"> Outdoor fan motor lead wire & connector Fan motor lock or block
F16	Total running current protection	3 times occurrence within 20 minutes	<ul style="list-style-type: none"> Excess refrigerant Outdoor PCB
F20	Outdoor compressor overheating protection	3 times occurrence within 30 minutes	<ul style="list-style-type: none"> Compressor tank temperature sensor Clogged expansion valve or strainer Insufficient refrigerant Outdoor PCB Compressor
F22	IPM (power transistor) overheating protection	4 times occurrence within 30 minutes	<ul style="list-style-type: none"> Improper heat exchange IPM (Power transistor)
F23	Outdoor Direct Current (DC) peak detection	7 times occurrence continuously	<ul style="list-style-type: none"> Outdoor PCB Compressor
F24	Refrigeration cycle abnormality	4 times occurrence within 60 minutes	<ul style="list-style-type: none"> Insufficient refrigerant Outdoor PCB Valve Close
F25	Cooling/Heating cycle changeover abnormality	4 times occurrence within 30 minutes	<ul style="list-style-type: none"> 4-way valve V-coil
F27	Pressure switch abnormality	Continue for 1 min.	<ul style="list-style-type: none"> Pressure switch
*F29	Low Discharge Superheat	1 times occurrence within 2550 minutes	<ul style="list-style-type: none"> Discharge Temperature Sensor Discharge Pressure Sensor Pressure Switch Outdoor PCB
F30	Water outlet sensor 2 abnormality	Continue for 5 sec.	<ul style="list-style-type: none"> Water outlet sensor 2 (defective or disconnected)
F32	Abnormal Internal Thermostat	Continue for 5 sec.	<ul style="list-style-type: none"> Control panel PCB thermostat
F33	Freezing of standby unit error	3 times occurrence within 40 minutes	<ul style="list-style-type: none"> Wrong wiring and connecting pipe, or Expansion valve leakage
F36	Outdoor air temperature sensor abnormality	Continue for 5 sec.	<ul style="list-style-type: none"> Outdoor air temperature sensor (defective or disconnected)
F37	Indoor water inlet temperature sensor abnormality	Continue for 5 sec.	<ul style="list-style-type: none"> Water inlet temperature sensor (defective or disconnected)
F40	Outdoor discharge pipe temperature sensor abnormality	Continue for 5 sec.	<ul style="list-style-type: none"> Outdoor discharge pipe temperature sensor (defective or disconnected)
F41	PFC control	4 times occurrence within 20 minutes	<ul style="list-style-type: none"> Outdoor PCB
F42	Outdoor heat exchanger temperature sensor abnormality	Continue for 5 sec.	<ul style="list-style-type: none"> Outdoor heat exchanger temperature sensor (defective or disconnected)
F43	Outdoor defrost sensor abnormality	Continue for 5 sec.	<ul style="list-style-type: none"> Outdoor defrost sensor (defective or disconnected)
F45	Indoor water outlet temperature sensor abnormality	Continue for 5 sec.	<ul style="list-style-type: none"> Water outlet temperature sensor (defective or disconnected)
F46	Outdoor Current Transformer open circuit	—	<ul style="list-style-type: none"> Insufficient refrigerant Outdoor PCB Compressor low
*F48	Outdoor EVA outlet temperature sensor abnormality	Continue for 5 sec.	<ul style="list-style-type: none"> Outdoor EVA outlet temperature sensor (defective or disconnected)
*F49	Outdoor bypass outlet temperature sensor abnormality	Continue for 5 sec.	<ul style="list-style-type: none"> Outdoor bypass outlet temperature sensor (defective or disconnected)

Note: * This error code is not applicable for this system.



24. Troubleshooting Guide (S-71WF3E)

24.1 Self-Diagnosis Error Code Table

SUPPLEMENT

Contents of Remote Controller Switch Alarm Display







ON: ○ Blinking: ☀ OFF: ●

Abnormal display	Wireless remote controller receiver display			Alarm contents	Error location
					
	Operation	Timer	Standby		
Remote controller • Indoor Unit	E01	Operating lamp blinking ☀ ● ●	● ●	Faulty remote controller	• Replace the remote controller
				Disconnection / Contact failure of remote controller wiring	• Correct the remote controller wiring
				CHK (check) pins on the indoor unit control PCB are short circuited	• Remove the short
				In the case of non-group control · Power supply OFF of outdoor unit · Disconnection / Contact failure of inter-unit wiring In the case of group control Automatic address operation was not carried out	• Execute auto address setting
				Faulty setting of EEPROM (IC010) on indoor unit	• Replace the indoor unit EEPROM
	E02			Faulty remote controller	• Replace the remote controller
				Wrong wiring of remote controller	• Correct the remote controller wiring
	E03			Error in indoor unit receiving signal from remote controller (central)	• Check the indoor unit control PCB • Check the remote controller wiring • Check the inter-unit control wiring
	E04	Standby lamp blinking ● ● ☀	● ●	Disconnection / Contact failure of inter-unit wiring	• Check the electrical connection of inter-unit control wiring • Replace the indoor unit control PCB • Replace the outdoor unit control PCB • Check the electrical connection of fuse (F302) on indoor unit control PCB In the case of the fuse opened on an indoor unit control PCB, after correcting wiring connection, it substitutes an EMG plug for OC plug
				• Faulty indoor unit control PCB • Faulty outdoor unit control PCB • Communication circuit fuse (F302) on indoor unit control PCB opened	
• Fuse on outdoor unit control PCB opened Since failure of an outdoor fan motor is considered as a cause, both outdoor unit control PCB and outdoor unit fan motor are exchanged simultaneously				• In the case of the fuse opened on an outdoor unit control PCB, replace both outdoor unit control PCB (CR/HIC) and outdoor unit fan motor simultaneously	
E08			Duplication of indoor unit address setting	• Indoor unit address re-setting	
E09	Operating lamp blinking			Error because of more than one remote controller setting to main	• Correct the setting
E18	Operating lamp blinking	● ●	● ●	• Disconnection of wiring between main unit and additional units • Contact failure of wiring • Faulty indoor unit control PCB (main or addition)	• Correct the wiring connection • Replace the wiring • Replace the indoor unit control PCB

ON: ○ Blinking: ☀ OFF: ●

Abnormal display		Wireless remote controller receiver display			Alarm contents	Error location	
		☀	⌚	☀			
		Operation	Timer	Standby			
Remote controller • Indoor Unit	F01	Operating and timer lamp blinking alternately			Indoor heat exchanger temperature sensor (E1) trouble	<ul style="list-style-type: none"> Check the indoor unit heat exchanger temperature sensor (E1) Check the indoor unit control PCB 	
	F02				Indoor heat exchanger temperature sensor (E2) trouble	<ul style="list-style-type: none"> Check the indoor unit heat exchanger temperature sensor (E2) Check the indoor unit control PCB 	
	F10		☀	☀	●	Indoor air temperature sensor (TA) trouble	<ul style="list-style-type: none"> Check the indoor unit air temperature sensor (TA) Check the indoor unit control PCB
	F29	Operating and timer lamp blinking simultaneously	☀	☀	●	Indoor unit EEPROM trouble	<ul style="list-style-type: none"> Check the indoor unit EEPROM Check the indoor unit control PCB
	L02	Operating and standby lamps blinking simultaneously				Setting error, indoor / outdoor unit type / model miss-matched	<ul style="list-style-type: none"> Address re-setting after correcting the combination of units
	L03					Duplication of main indoor unit address in group control	<ul style="list-style-type: none"> Correct the group (main and addition)
	L07					Group control wiring is connected to individual control indoor unit	<ul style="list-style-type: none"> Correct the indoor unit address
	L08		☀	●	☀	Indoor unit address is not set	<ul style="list-style-type: none"> Correct the indoor unit address
	L09					Indoor unit capacity is not set	<ul style="list-style-type: none"> Correct the capacity setting of indoor units
	P01	Indoor unit fan motor locked				Indoor unit fan motor locked	<ul style="list-style-type: none"> Remove the cause
						Indoor unit fan motor layer short	<ul style="list-style-type: none"> Replace the fan motor
						Contact failure in thermostat protector circuit	<ul style="list-style-type: none"> Correct the wiring
		P09	Faulty wiring connections of (ceiling) indoor unit panel				<ul style="list-style-type: none"> Correct the wiring connection
			Faulty drain pump				<ul style="list-style-type: none"> Repair / Replace
		P10	Timer and standby lamp blinking alternately	●	☀	☀	Drainage failure
Contact failure of float switch wiring						<ul style="list-style-type: none"> Correct the wiring 	
Float switch : High water alarm						<ul style="list-style-type: none"> For vertical installation, set the detailed settings Code No. "3F" to "0001". (See pages 108 to 109.) 	
P11	Faulty drain pump				<ul style="list-style-type: none"> Repair / Replace 		
	Drain pump locked				<ul style="list-style-type: none"> Remove the cause 		
P12	Indoor unit fan motor locked Faulty wiring connections of indoor unit fan motor				<ul style="list-style-type: none"> Remove the cause Correct the wiring 		
Outdoor Unit	E06	Standby lamp blinking	●	●	☀	Disconnection / Contact failure of inter-unit wiring	<ul style="list-style-type: none"> Correct the inter-unit control wiring Check the electrical connection of fuse (F302) on indoor unit control PCB In the case of the fuse opened on an indoor unit control PCB, after correcting wiring connection, it substitutes an EMG plug for OC plug
			●	●	☀	<ul style="list-style-type: none"> Disconnection of inter-unit wiring Communication circuit fuse (F302) on indoor unit control PCB opened 	
					Indoor unit control PCB address settings error	<ul style="list-style-type: none"> Indoor unit address re-setting 	





ON: ○ Blinking: ☀ OFF: ●

Abnormal display	Wireless remote controller receiver display			Alarm contents	Error location	
						
	Operation	Timer	Standby			
E12	Operating lamp blinking			Auto address setting start is prohibited	<ul style="list-style-type: none"> Check the inter-unit control wiring 	
E14		●	●	Duplication of main unit in group control	<ul style="list-style-type: none"> Check the inter-unit control wiring Check the indoor unit combination 	
E15				Automatic address alarm	<ul style="list-style-type: none"> Check the inter-unit control wiring Check the indoor and outdoor unit control PCB Address re-setting after correcting the combination of units 	
E16	Standby lamp blinking				<ul style="list-style-type: none"> The total capacity of indoor units are too high The numbers of indoor units are two or more 	<ul style="list-style-type: none"> Check the inter-unit control wiring Check the indoor and outdoor unit control PCB
E20	●	●			No indoor unit connected	
E24				<ul style="list-style-type: none"> Outdoor unit communication error 	<ul style="list-style-type: none"> Check the outdoor unit control PCB 	
E29				<ul style="list-style-type: none"> Outdoor unit communication error 	<ul style="list-style-type: none"> Check the outdoor unit control PCB 	
F04				Compressor discharge temperature sensor (TD) trouble	<ul style="list-style-type: none"> Check the compressor discharge temperature sensor (TD) Check the outdoor unit control PCB 	
F06				Outdoor heat exchanger temperature sensor (C1) trouble	<ul style="list-style-type: none"> Check the outdoor unit heat exchanger temperature sensor (C1) Check the outdoor unit control PCB 	
F07				Outdoor heat exchanger temperature sensor (C2) trouble	<ul style="list-style-type: none"> Check the outdoor unit heat exchanger temperature sensor (C2) Check the outdoor unit control PCB 	
F08	Operating and timer lamp blinking alternately			Outdoor air temperature sensor (TO) trouble	<ul style="list-style-type: none"> Check the outdoor air temperature sensor (TO) Check the outdoor unit control PCB 	
F12			○	Compressor suction temperature sensor (TS) trouble	<ul style="list-style-type: none"> Check the compressor suction temperature sensor (TS) Check the outdoor unit control PCB 	
F16				High Pressure Sensor Trouble	<ul style="list-style-type: none"> Check the high pressure sensor Check the outdoor unit control PCB 	
F23				Outdoor Gas Pipe Temperature Sensor Trouble	<ul style="list-style-type: none"> Check the outdoor gas pipe temperature sensor Check the outdoor unit control PCB 	
F24				Outdoor Liquid Pipe Temperature Sensor Trouble	<ul style="list-style-type: none"> Check the outdoor liquid pipe temperature sensor Check the outdoor unit control PCB 	
F31	Operating and timer lamp blinking alternately			Outdoor unit EEPROM trouble	<ul style="list-style-type: none"> Check the outdoor unit EEPROM Check the outdoor unit control PCB 	

ON: ○ Blinking: ☀ OFF: ●

Abnormal display		Wireless remote controller receiver display			Alarm contents	Error location
		☀	⌚	☀		
		Operation	Timer	Standby		
Outdoor Unit	H01				Primary (input) overcurrent detected	<ul style="list-style-type: none"> Check the refrigerant cycle (abnormal overload operation) Check the outdoor unit control PCB Check the power supply
	H02	Timer lamp blinking			PAM trouble	<ul style="list-style-type: none"> Check the outdoor unit control PCB Compressor locked Check the power supply
	H03	●	☀	●	Primary current CT sensor failure	<ul style="list-style-type: none"> Check the outdoor unit control PCB
	H31				HIC trouble DC voltage not detected	<ul style="list-style-type: none"> Check the outdoor unit control PCB Check the HIC Compressor locked Valve blockage
	L04				Duplication of outdoor unit address	<ul style="list-style-type: none"> Check the inter-unit control wiring
	L10				Outdoor unit capacity is not set or setting error	<ul style="list-style-type: none"> Replace the outdoor unit EEPROM Capacity value re-setting
	L13	Operating and standby lamps blinking simultaneously			Indoor unit type setting error Type of indoor/outdoor units is different	<ul style="list-style-type: none"> Replace the indoor unit EEPROM Check the outdoor unit control PCB Check the type of IU and OU, and re-set address
	L18	☀	○	☀	4-way valve locked trouble / operation failure	<ul style="list-style-type: none"> Check the 4-way valve Check the 4-way valve wiring Check the outdoor unit control PCB
	P03				Compressor discharge temperature trouble	<ul style="list-style-type: none"> Check the refrigerant cycle (gas leak) Trouble with the electronic expansion valve Check the discharge temperature sensor (TD)
	P04	Operating and standby lamp blinking alternately			Condensing pressure trouble	<ul style="list-style-type: none"> Check the refrigerant cycle Valve blockage Heat exchanger obstruction
	P05	☀	●	☀	Open phase detected AC power supply trouble	<ul style="list-style-type: none"> Check the power supply Check the reactor wiring Check the outdoor unit control PCB Check the compressor wiring
	P07				HIC (IPM) temperature trouble	<ul style="list-style-type: none"> Check the outdoor unit control PCB Check the HIC Compressor locked Valve blockage
	P13	Timer and standby lamp blinking alternately			Valve error Refrigerant circuit error Wrong installation for refrigerant piping and wiring	<ul style="list-style-type: none"> Valve blockage Check the refrigerant circuit Check the refrigerant piping and wiring installation
	P14	●	☀	☀	O ₂ sensor detected	<ul style="list-style-type: none"> Input from the O₂ sensor

ON: ○ Blinking: ☀ OFF: ●

Abnormal display		Wireless remote controller receiver display			Alarm contents	Error location	
							
		Operation	Timer	Standby			
Outdoor Unit	P15				Insufficient gas level detected	<ul style="list-style-type: none"> • Check the refrigerant cycle (gas leak) • Trouble with the electronic expansion valve • Valve (or refrigerant circuit) blockage 	
	P16	Operating and standby lamp blinking alternately			Compressor overcurrent trouble	<ul style="list-style-type: none"> • Layer short on the compressor • Compressor locked • Check the outdoor unit control PCB 	
	P22				Outdoor unit fan motor trouble Outdoor unit fan trouble	<ul style="list-style-type: none"> • Check the outdoor unit fan motor, connector 	
	P29			●		Inverter compressor trouble	<ul style="list-style-type: none"> • Layer short on the compressor • Check the outdoor unit control PCB • Check the inverter compressor wiring (Open phase/Reverse phase) • Compressor actuation failure (include lock) • Valve (or refrigerant circuit) blockage
	P31					Indoor unit in group control trouble	<ul style="list-style-type: none"> • Repair indoor unit which blinking alarm

24.2 Self-Diagnostics Method (S-71WF3E)

24.2.1 Error Code Definition

Error Code	Code Definition
E	Communication Error (Communication between indoor and outdoor; Communication between wired remote controller & Wired remote controller improper setting)
L	Improper setting from outdoor & indoor unit and wired remote controller
F	<ul style="list-style-type: none">• Temperature sensor issue (Indoor & Outdoor Unit).<ul style="list-style-type: none">○ EEPROM Issue (F31)
P	Protective device activated
H	Protective device activated (inverter compressor)

24.2.2 E01 & E02

E01 - Remote Controller Reception Error

E02 - Remote Controller Transmission Error

When remote controller is set to sub (Slave) remote controller:

- If only one remote controller is connected to indoor unit, this remote controller must set to main remote controller. (Wireless remote controller set the switch at wireless receiver)

Group control:

- Confirm the grouped indoor units no more than eight units.
- Check all indoor unit power supply status.
- Make sure group control setting is executed.
- Group control wiring changed after setting is done.
- Grouped control wire (Black & White) shorted, mis-wiring, wrong contact or grounded.

Setting Related:

- CHK and TEST pin shorted.
- EEPROM no installed or defect when main power switched ON.
- Remote controller on check mode.
- Remote controller itself defect.
- Indoor unit PCB malfunction.

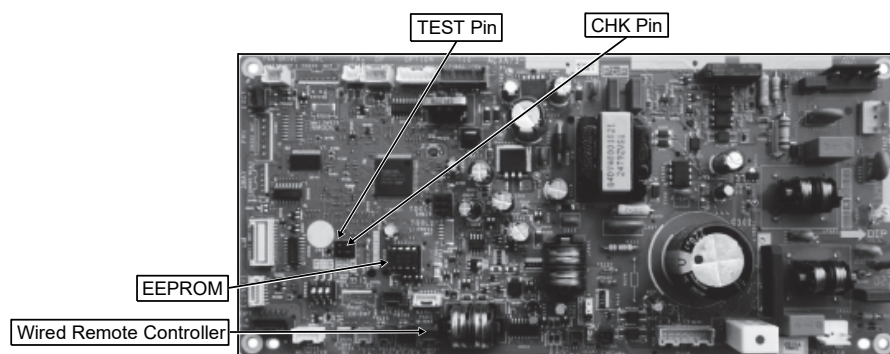
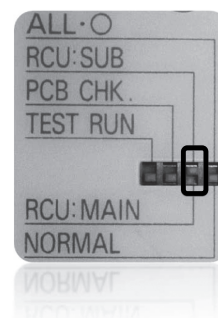

24.2.3 E04 - Error in Indoor Unit Receiving Signal from Outdoor Unit

Wiring/Power Supply issue:

- No communication from outdoor unit within 3 minutes or no signal from outdoor unit
 - Outdoor Unit main power supply turned OFF.
 - No proper set for indoor unit resistance impedance terminal (CN045)
 - Communication cable is lose/opened/improper install.

Setting Related:

- CHK and TEST pin shorted.
- EEPROM no installed or defect when main power switched ON.
- Outdoor unit main PCB malfunction.
- Wrongly set the indoor unit address (duplicated)

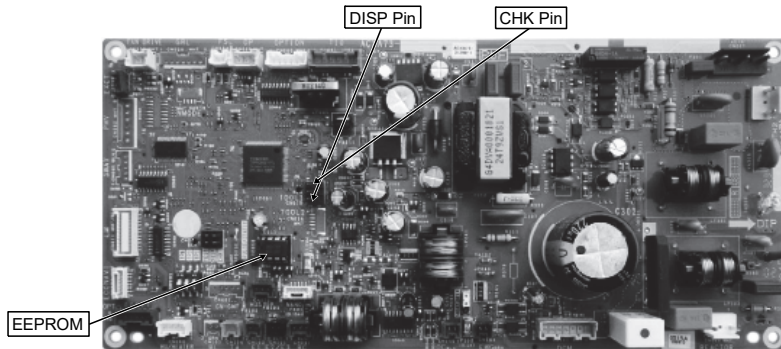

24.2.4 E04 - Communication Issue (Outdoor Unit)

Error Detection Method:

- Faulty of indoor or outdoor unit PCB.
- Signal transmission fail due to wrong wiring/improper connect
- Signal transmission fail due to breaking of communication wire between indoor and outdoor unit.
- Wrongly set the indoor unit address (duplicated)

Troubleshooting Method:

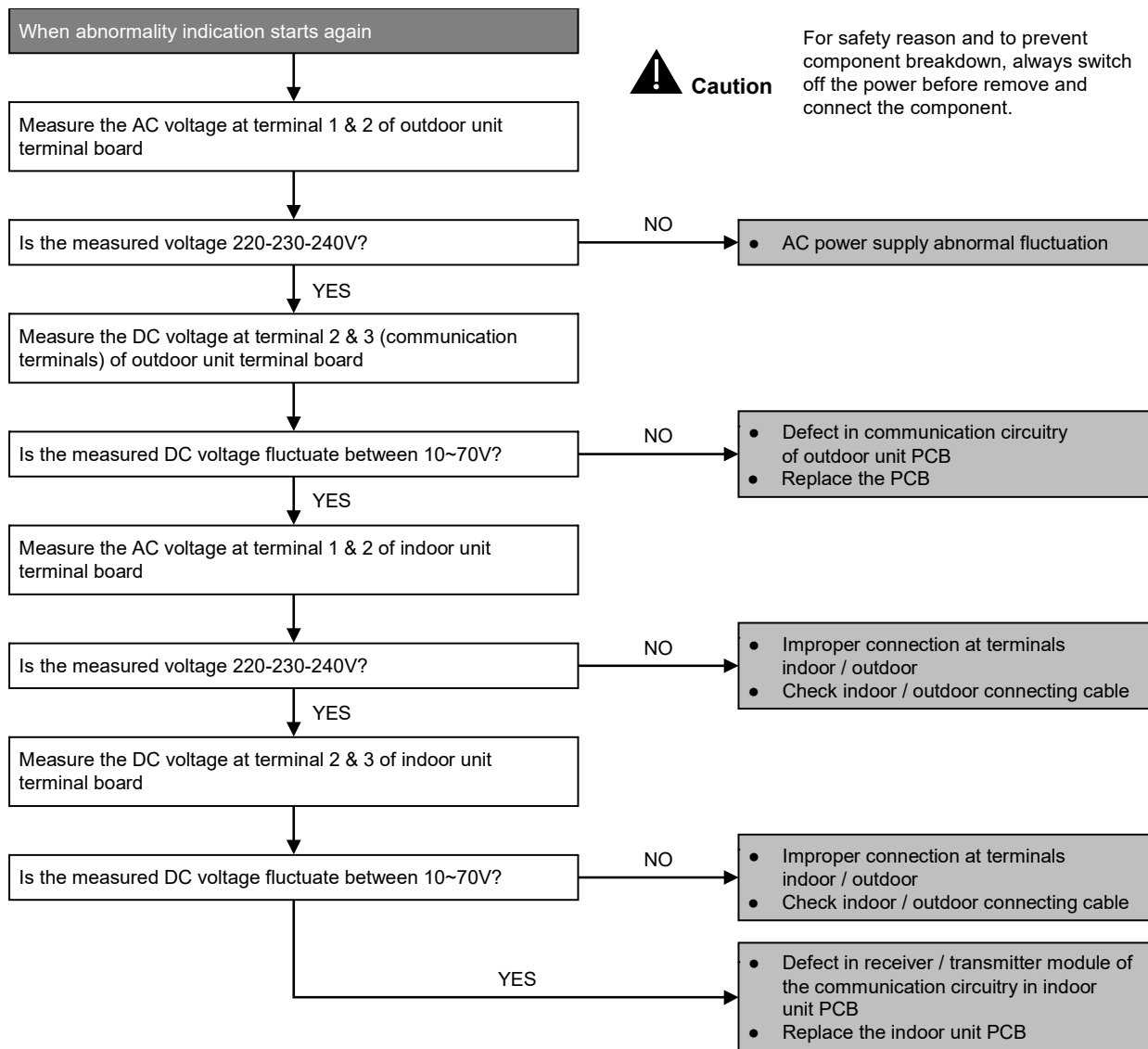

24.2.5 E15 - Total Capacity of Indoor Unit is Too Low

Error Detection Method:

- When indoor unit capacity is lower than outdoor unit.
- CHK pin (CN062/CN071) and/or TEST pin (CN064) shorted when power is turned ON.

24.2.6 E16 - Total Capacity of Indoor Unit is Too High

Setting Related:

- When indoor unit capacity higher than outdoor unit.
- CHK pin (CN062/CN071) and/or TEST pin (CN064) shorted when power is turned ON.

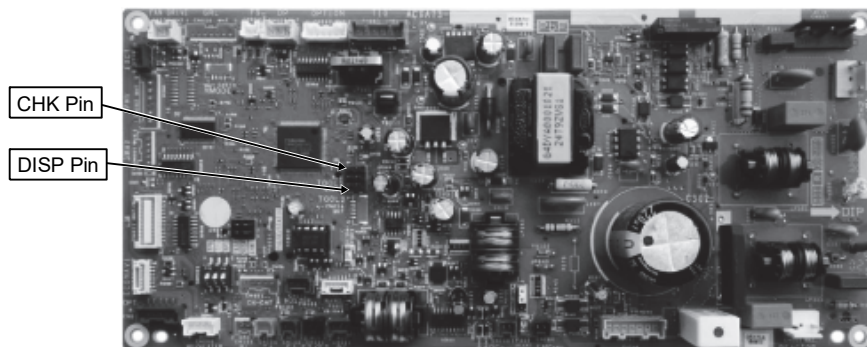

25. Troubleshooting Guide (CU-2WZ71YBE5)

25.1 Self Diagnosis Function (Outdoor LED Diagnosis Table)

- The display screen of wireless remote control unit and the self-diagnosis LEDs (green) on the outdoor printed circuit board in the outdoor unit can be used to identify the location of the problem.
Refer to the table below to identify and solve the cause of the problem, and then re-start the air conditioner system.
- If the problem is solved and operation returns to normal.
LED 1 illuminates and others LED are off.

Diagnosis display (Indoor model: CS-XX / S-XX / WH-XX)	Abnormality or protection control	LED 6	LED 5	LED 4	LED 3	LED 2	LED 1	Abnormality judgement	Protection operation	Problem	Check location
H11 / E04 / H90	Indoor/outdoor abnormal communication						○	After operation for 1 minute	Indoor fan only operation can start by entering into force cooling operation	Indoor/outdoor communication not establish	<ul style="list-style-type: none"> Indoor/outdoor wire terminal Indoor/outdoor PCB Indoor/outdoor connection wire
H12 / E16 / H12	Indoor unit capacity unmatched					○		90s after power supply	-	Total indoor capability more than maximum limit or less than minimum limit, or number of indoor unit less than two.	<ul style="list-style-type: none"> Indoor/outdoor connection wire Indoor/outdoor PCB Specification and combination table in catalogue
H15 / F04 / H15	Compressor temperature sensor abnormality					○	○	Continuous for 5s	-	Compressor temperature sensor open or short circuit	<ul style="list-style-type: none"> Compressor temperature sensor lead wire and connector
H16 / H03 / F46	Outdoor current transformer (CT) abnormality				○		○	-	-	Current transformer faulty or compressor faulty	<ul style="list-style-type: none"> Outdoor PCB faulty or compressor faulty
H27 / F08 / F36	Outdoor air temperature sensor abnormality				○	○		Continuous for 5s	-	Outdoor air temperature sensor open or short circuit	<ul style="list-style-type: none"> Outdoor air temperature sensor lead wire and connector
H28 / F06 / F42	Outdoor heat exchanger temperature sensor 1 abnormality				○	○	○	Continuous for 5s	-	Outdoor heat exchanger temperature sensor 1 open or short circuit	<ul style="list-style-type: none"> Outdoor heat exchanger temperature sensor 1 lead wire and connector
H30 / F04 / F40	Compressor discharge temperature sensor abnormality		○	○	○			Continuous for 5s (after compressor ON for more than 5 minutes)	-	Compressor discharge temperature sensor open or short circuit	<ul style="list-style-type: none"> Compressor discharge temperature sensor lead wire and connector
H32 / F07 / F43	Outdoor heat exchanger temperature sensor 2 abnormality			○				Continuous for 5s	-	Outdoor heat exchanger temperature sensor 2 open or short circuit	<ul style="list-style-type: none"> Outdoor heat exchanger temperature sensor 2 lead wire and connector
H33 / P05 / H95	Indoor / outdoor misconnection abnormality			○			○	-	-	Indoor and outdoor rated voltage different	<ul style="list-style-type: none"> Indoor and outdoor units check

Diagnosis display (Indoor model: CS-XX / S-XX / WH-XX)	Abnormality or protection control	LED 6	LED 5	LED 4	LED 3	LED 2	LED 1	Abnormality judgement	Protection operation	Problem	Check location
H36 / F23 / H51	Outdoor gas pipe temperature sensor abnormality			○		○		Continuous for 5s	Heating protection operation only	Outdoor gas pipe temperature sensor open or short circuit	<ul style="list-style-type: none"> Outdoor gas pipe temperature sensor lead wire and connector
H37 / F24 / H53	Outdoor liquid pipe temperature sensor abnormality			○		○	○	Continuous for 5s	Cooling protection operation only	Outdoor liquid pipe temperature sensor open or short circuit	<ul style="list-style-type: none"> Outdoor liquid pipe temperature sensor lead wire and connector
H64 / P04 / F27	Outdoor high pressure sensor abnormality			○	○			Continuous for 1 minute	-	High pressure sensor open circuit during compressor stop	<ul style="list-style-type: none"> High pressure sensor Lead wire and connector
H89 / F16 / H64	Compressor discharge temperature sensor abnormality		○	○		○		4 times happens within 20 minutes	-	High pressure sensor open or short circuit	<ul style="list-style-type: none"> High pressure sensor Lead wire and connector
H97 / P22 / F15	Outdoor fan motor mechanism lock			○	○		○	2 times happen within 30 minutes	-	Outdoor fan motor lock or feedback abnormal	<ul style="list-style-type: none"> Outdoor fan motor lead wire and connector Fan motor lock or block
H98 / - / H98	Indoor high pressure protection			○	○	○		-	-	Indoor high pressure protection (Heating)	<ul style="list-style-type: none"> Check indoor heat exchanger Air filter dirty Air circulation short circuit
H99 / - / H99	Indoor operating unit freeze protection			○	○	○		-	-	Indoor freeze protection (Cooling)	<ul style="list-style-type: none"> Check indoor heat exchanger Air filter dirty Air circulation short circuit
H64	Outdoor high pressure switch abnormality			○	○			-	-	High pressure switch open circuit during compressor stop	<ul style="list-style-type: none"> High pressure switch lead wire, connector CN-PSW1
H89	High pressure sensor abnormal		○	○		○		-	-	High pressure sensor open or short circuit	<ul style="list-style-type: none"> High pressure sensor lead wire, connector CN-HPS
F11 / L18 / F25	4-way valve switching abnormality			○	○	○	○	4 times happen within 30 minutes	-	4-way valve switching abnormal	<ul style="list-style-type: none"> 4-way valve Lead wire and connector.
F17 / P14 / F33	Indoor standby units freezing abnormality		○					3 times happen within 40 minutes	-	Wrong wiring and connecting pipe, expansion valve leakage.	<ul style="list-style-type: none"> Check indoor/outdoor connection wire and pipe Indoor heat exchanger sensor lead wire and connector Expansion valve lead wire and connector.
F90 / H02 / F41	Power factor correction (PFC) circuit protection		○				○	4 times happen within 20 minutes	-	Power factor correction circuit abnormal	<ul style="list-style-type: none"> Outdoor PCB faulty
F91 / P15 / F24	Refrigeration cycle abnormality		○			○		4 times happen within 60 minutes	-	Refrigeration cycle abnormal	<ul style="list-style-type: none"> Insufficient refrigerant or valve close

Diagnosis display (Indoor model: CS-XX / S-XX / WH-XX)	Abnormality or protection control	LED 6	LED 5	LED 4	LED 3	LED 2	LED 1	Abnormality judgement	Protection operation	Problem	Check location
F93 / P29 / F14	Compressor abnormal revolution		○				○	4 times happen within 20 minutes	-	Compressor abnormal revolution	<ul style="list-style-type: none"> Power transistor module faulty or compressor lock
F94 / P04 / F12	Compressor discharge pressure overshoot protection		○		○			4 times happen within 30 minutes	-	Compressor discharge pressure overshoot	<ul style="list-style-type: none"> Check refrigeration system
F95 / P04 / F95	Outdoor cooling high pressure protection		○		○		○	4 times happen within 20 minutes	-	Cooling high pressure protection	<ul style="list-style-type: none"> Check refrigeration system Outdoor air circuit
F96 / P07 / F22	Power transistor module overheating protection		○		○	○		4 times happen within 30 minutes	-	Power transistor module overheat	<ul style="list-style-type: none"> PCB faulty Outdoor air circuit (fan motor)
F97 / P03 / F20	Compressor overheating protection		○		○	○	○	3 times happen within 30 minutes	-	Compressor overheat	<ul style="list-style-type: none"> Insufficient refrigerant
F98 / H01 / F16	Total running current protection		○	○				3 times happen within 20 minutes	-	Total current protection	<ul style="list-style-type: none"> Check refrigeration system Power source or compressor lock
F99 / P16 / F23	Outdoor direct current (DC) peak detection		○	○			○	Continuous happen for 7 times	-	Power transistor module current protection	<ul style="list-style-type: none"> Power transistor module faulty or compressor lock

LED 1 illuminate is indicated that outdoor unit is operating normally. If the LED 1 is switched off or flashing, check the power supply and self-diagnosis indication.

●----- Illuminate
○----- Flashing
Blank ----- OFF

25.2 Self-diagnosis Method

25.2.1 Indoor/Outdoor Capacity Rank Mismatched (E16 / H12)

Malfunction Decision Conditions

- During startup, error code appears when different types of indoor and outdoor units are interconnected.

Malfunction Caused

- Wrong models interconnected.
- Wrong indoor unit or outdoor unit PCBs mounted.
- Indoor unit or outdoor unit PCBs defective.
- Indoor-outdoor unit signal transmission error due to wrong wiring.
- Indoor-outdoor unit signal transmission error due to breaking of wire 3 in the connection wires between the indoor and outdoor units.

Troubleshooting

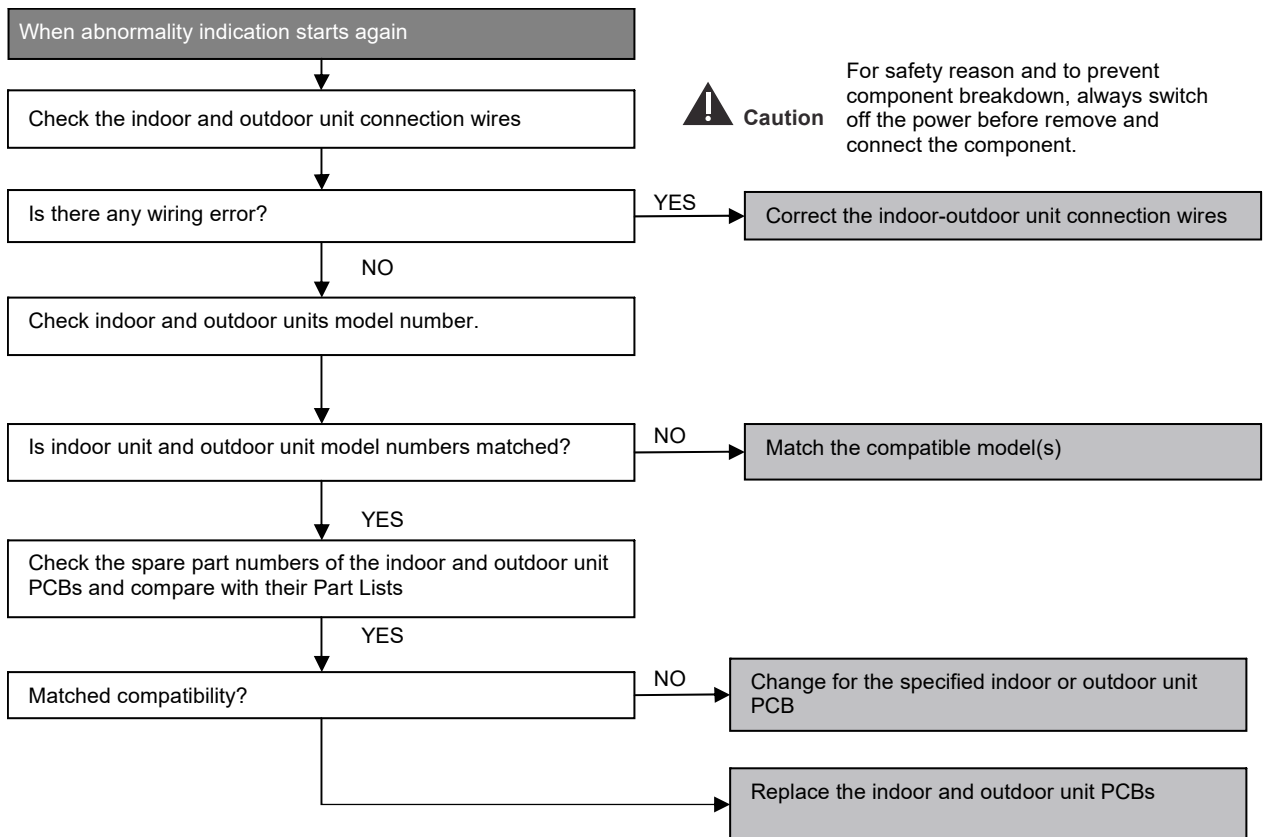

25.2.2 Compressor Tank Temperature Sensor Abnormality (H15 / F04 / H15)

Malfunction Decision Conditions:

During startup and operation of cooling and heating, the temperatures detected by the compressor tank temperature sensor are used to determine sensor error.

Malfunction Caused:

1. Faulty connector connection.
2. Faulty sensor.
3. Faulty outdoor unit PCB (main).

Abnormality Judgment:

Continue for 5 seconds.

Troubleshooting:

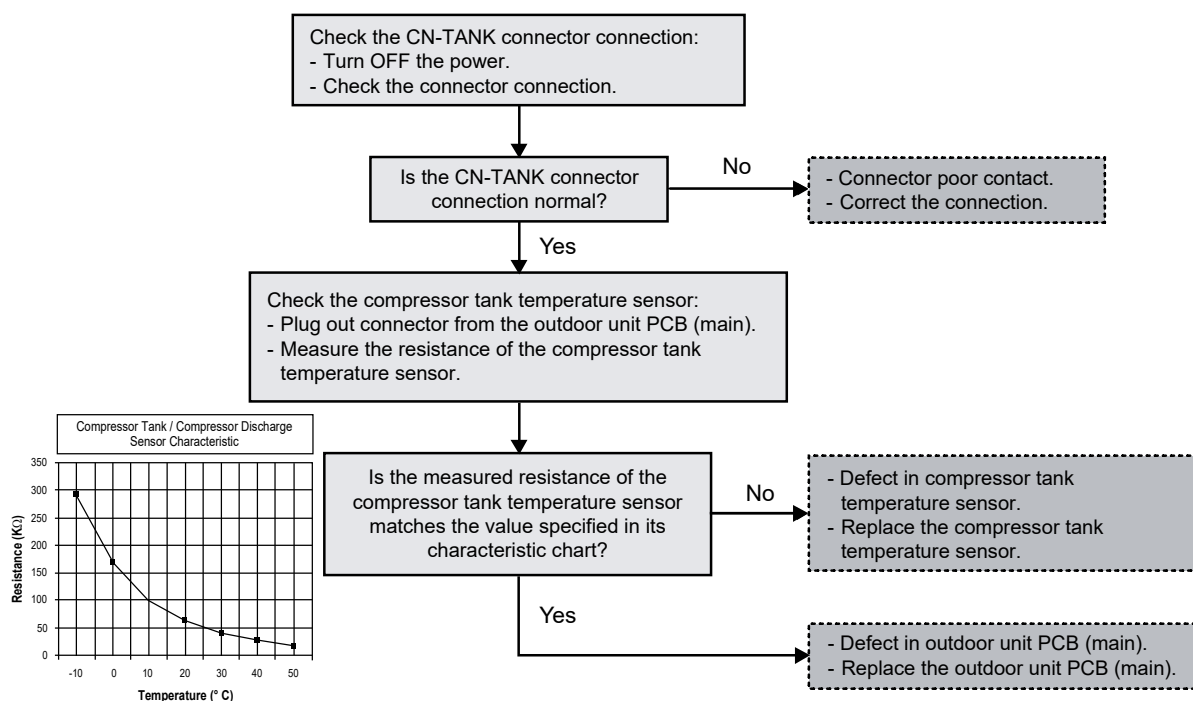

25.2.3 Water Pump Abnormality (- / - / H20)

Malfunction Decision Conditions:

During startup and operation of cooling and heating, the rotation speed detected by the IPM of water pump motor during water pump operation is used to determine abnormal water pump (feedback of rotation > 6,000rpm or < 1,000rpm).

Malfunction Caused:

1. Operation stop due to short circuit inside the water pump motor winding.
2. Operation stop due to breaking of wire inside the water pump motor.
3. Operation stop due to breaking of water pump lead wires.
4. Operation stop due to water pump motor IPM malfunction.
5. Operation error due to faulty indoor unit PCB.

Abnormality Judgment:

Continue for 5 seconds.

Troubleshooting:



Caution

For safety reason and to prevent component breakdown, always switch off the power before remove and connect the component.

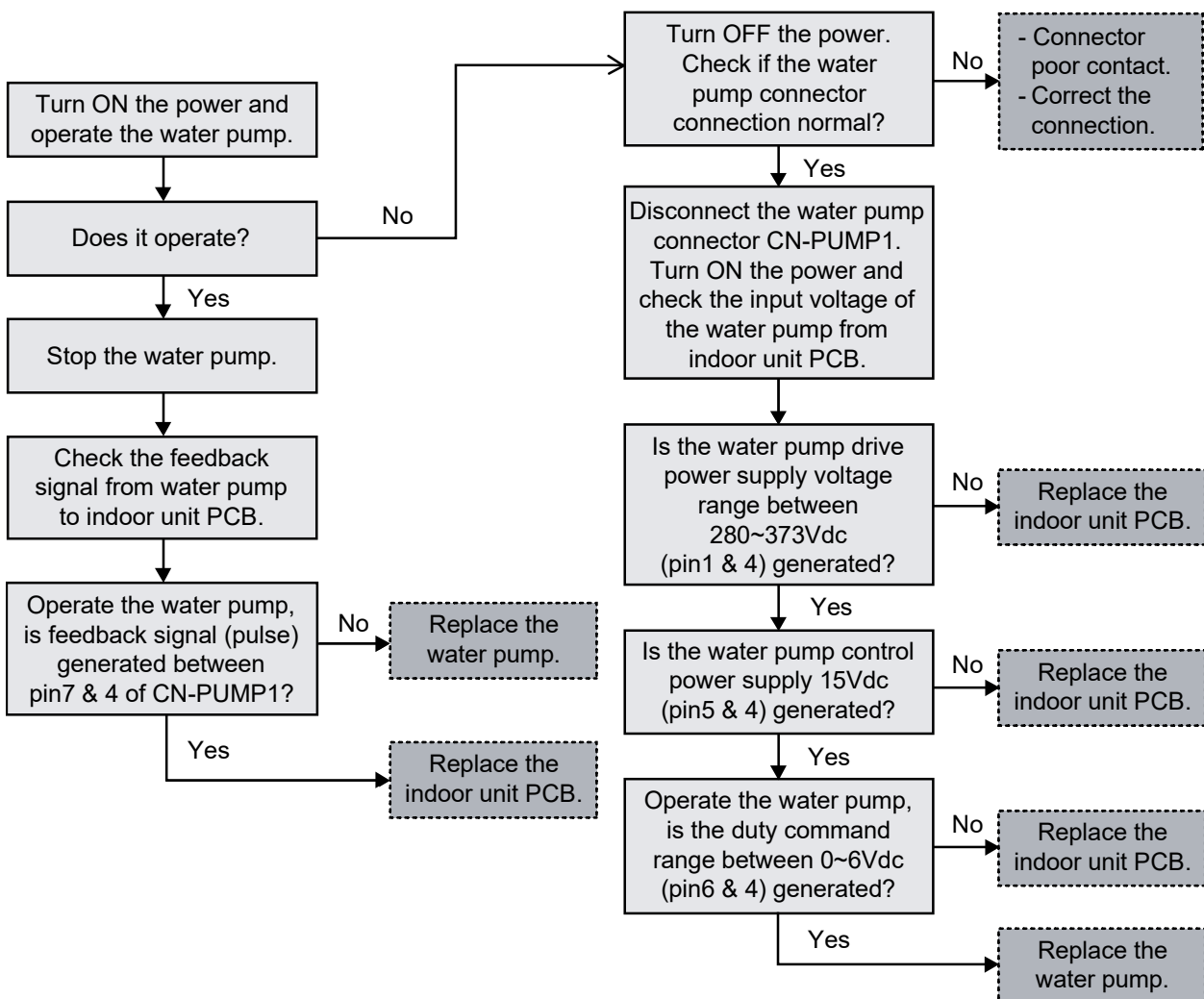

25.2.4 Indoor Refrigerant Liquid Temperature Sensor Abnormality (- / - / H23)

Malfunction Decision Conditions:

During startup and operation of cooling and heating, the temperatures detected by the indoor refrigerant liquid temperature sensor are used to determine sensor error.

Malfunction Caused:

1. Faulty connector connection.
2. Faulty sensor.
3. Faulty indoor unit PCB (main).

Abnormality Judgment:

Continue for 5 seconds.

Troubleshooting:



Caution

For safety reason and to prevent component breakdown, always switch off the power before remove and connect the component.

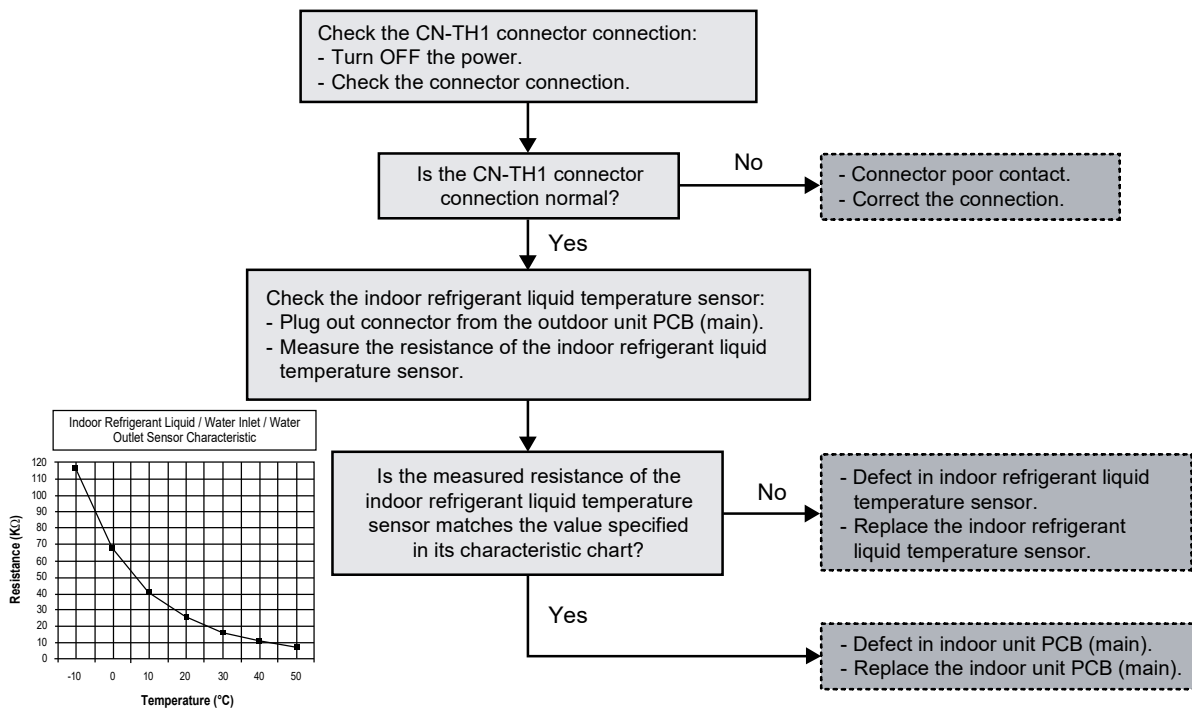

25.2.5 Abnormal Solar Sensor (- / - / H28)

Malfunction Caused:

- 1 Faulty connector connection.
- 2 Faulty solar sensor.
- 3 Faulty indoor sub PCB.

Abnormality Judgment:

Continue for 5 seconds.

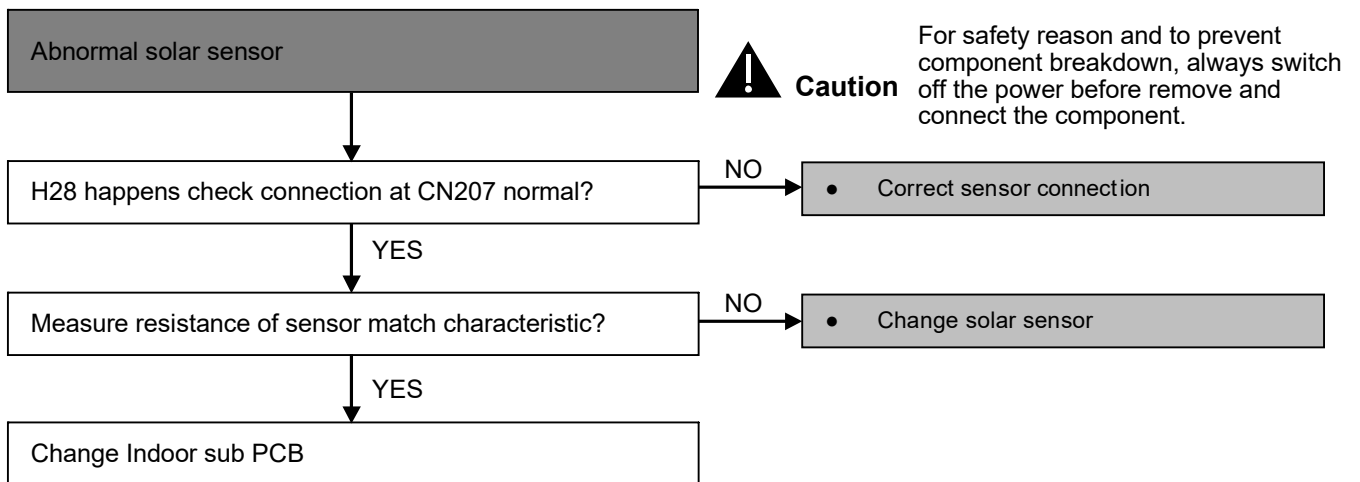

25.2.6 Abnormal Swimming Pool Sensor (- / - / H31)

Malfunction Caused:

- 1 Faulty connector connection.
- 2 Faulty swimming pool sensor.
- 3 Faulty indoor sub PCB.

Abnormality Judgment:

Continue for 5 seconds.

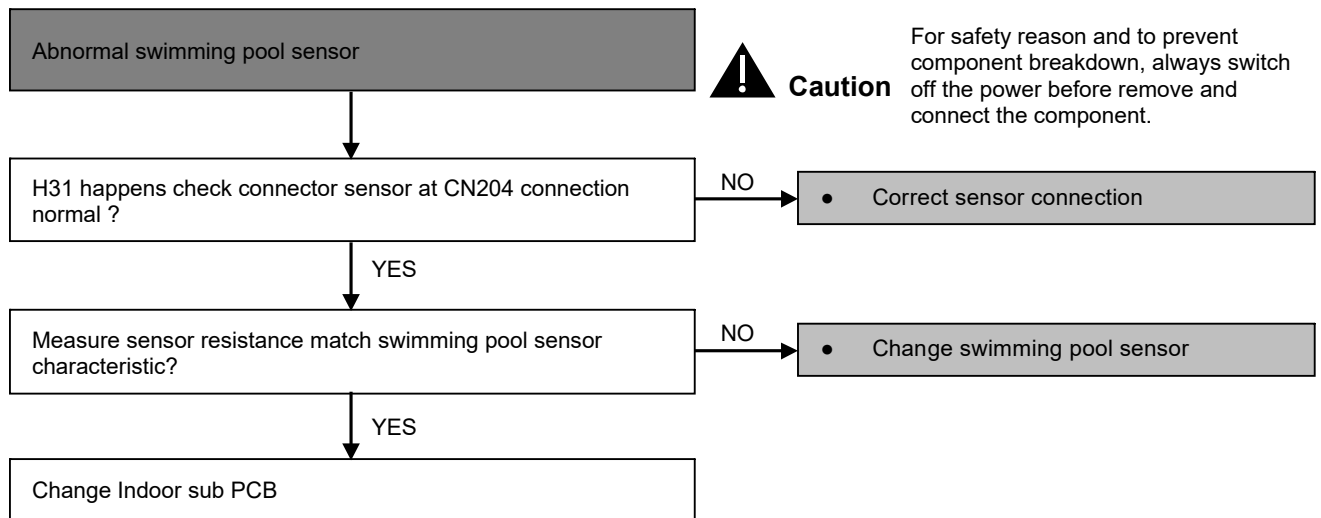

25.2.7 Abnormal Buffer Tank Sensor (- / - / H36)

Malfunction Caused:

- 1 Faulty connector connection.
- 2 Faulty buffer tank sensor.
- 3 Faulty indoor sub PCB.

Abnormality Judgment:

Continue for 5 seconds.

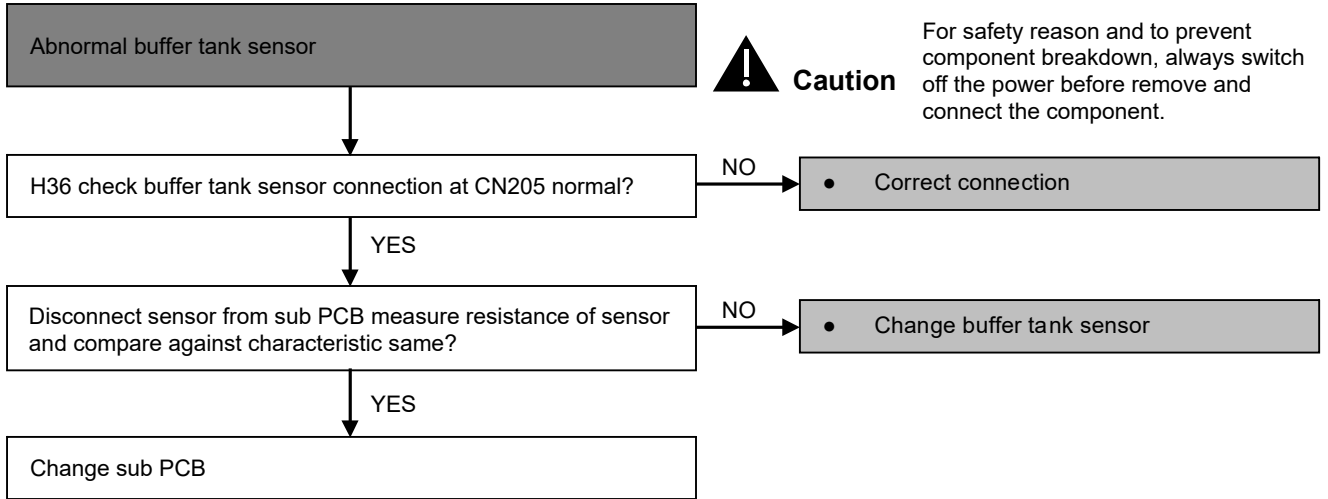

25.2.8 Brand Code Not Matching (H38 / L02 / H38)

Malfunction Caused:

- 1 Indoor and outdoor brand code not match.

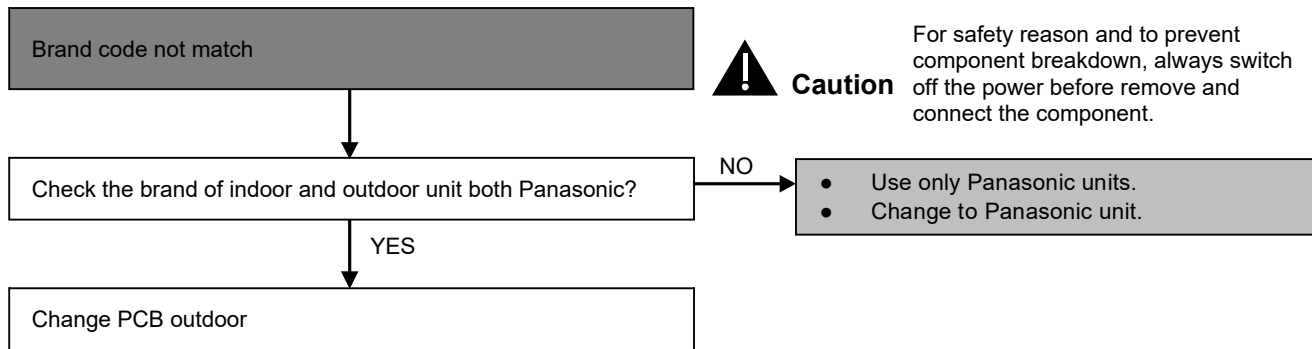

25.2.9 Abnormal Zone 1 Sensor (- / - / H43)

Malfunction Caused:

- 1 Faulty connector connection.
- 2 Faulty buffer tank sensor.
- 3 Faulty indoor sub PCB.

Abnormality Judgment:

Continue for 5 seconds.

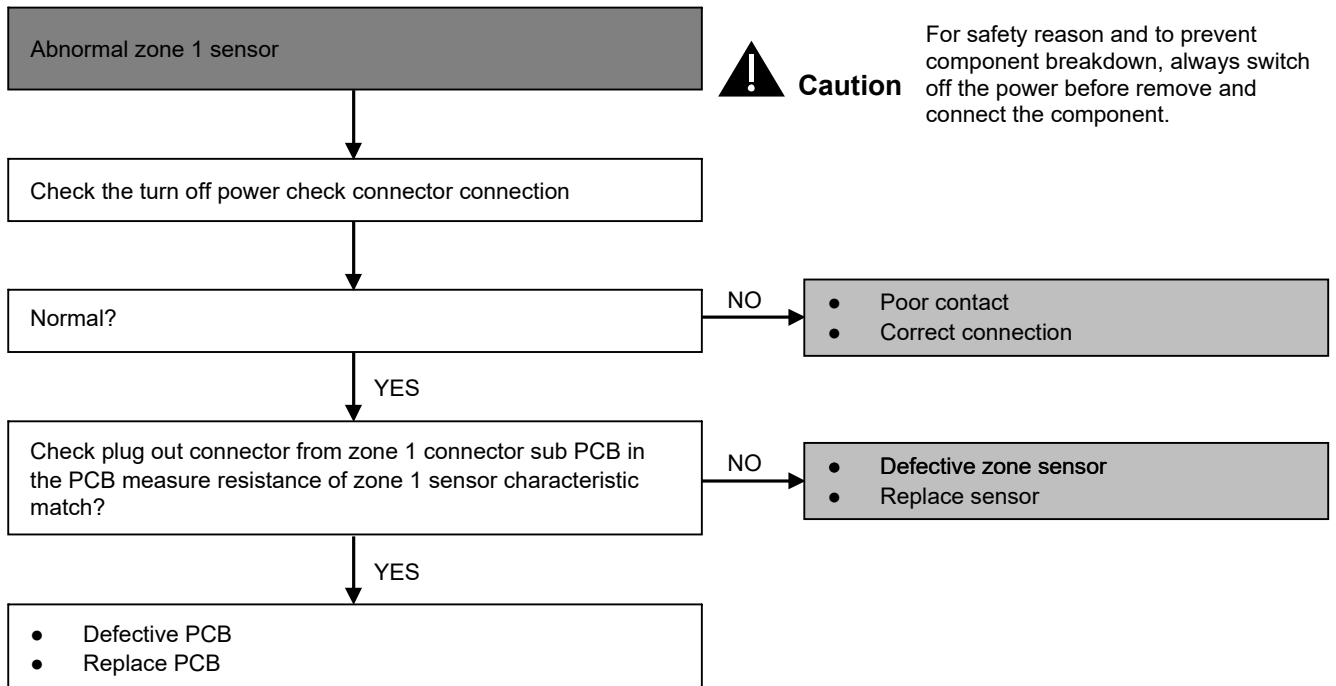

25.2.10 Abnormal Zone 2 Sensor (- / - / H44)

Malfunction Caused:

- 1 Faulty connector connection.
- 2 Faulty buffer tank sensor.
- 3 Faulty indoor sub PCB.

Abnormality Judgment:

Continue for 5 seconds.

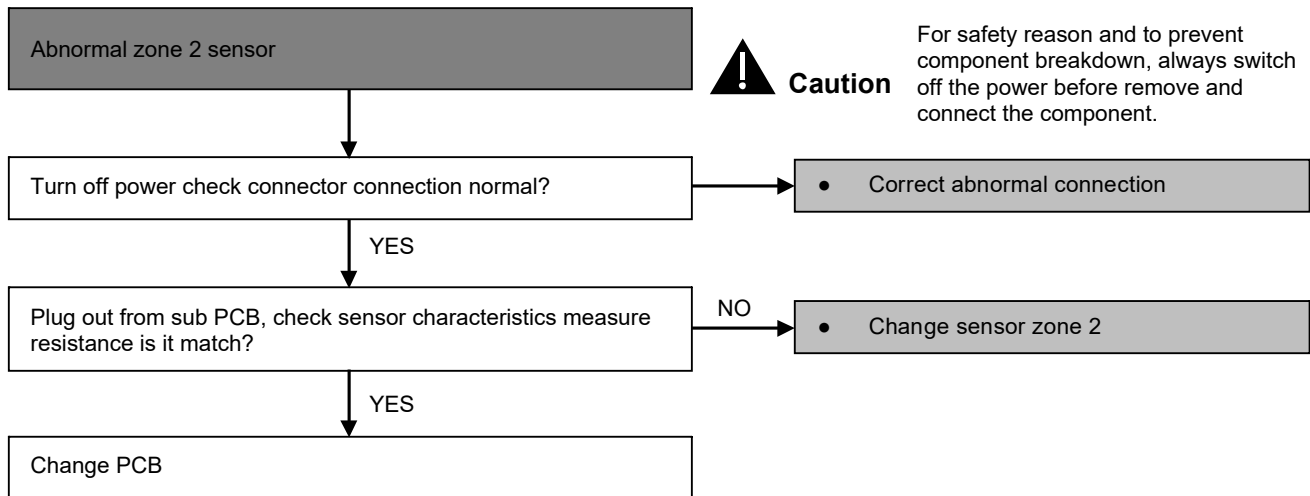

25.2.11 Water Flow Switch Abnormality (- / - / H62)

Malfunction Decision Conditions:

During operation of cooling and heating, the water flow detected by the indoor water flow switch is used to determine water flow error.

Malfunction Caused:

1. Faulty water pump.
2. Water leak in system.
3. Faulty connector connection.
4. Faulty water flow switch.
5. Faulty indoor unit PCB (main).

Abnormality Judgment:

Continue for 10 seconds (but no judgment for 9 minutes after compressor startup/restart).

Troubleshooting:



Caution

For safety reason and to prevent component breakdown, always switch off the power before remove and connect the component.

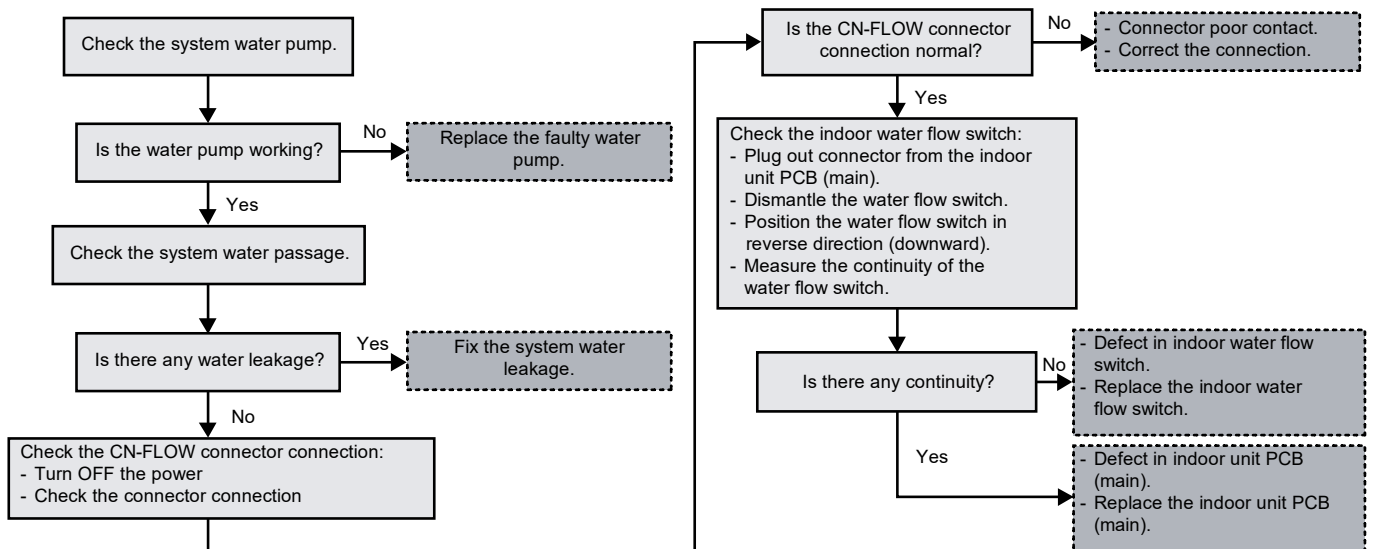

25.2.12 Outdoor High Pressure Abnormality (H89 / F16 / H64)

Malfunction Decision Conditions:

During operation of cooling and heating, when the outdoor high pressure sensor output signal is 0 Vdc or 5 Vdc.

Malfunction Caused:

1. Faulty connector connection.
2. Faulty sensor.
3. Faulty outdoor unit PCB (main).

Abnormality Judgment:

Continue 4 times in 20 minutes.

Troubleshooting:



Caution

For safety reason and to prevent component breakdown, always switch off the power before remove and connect the component.

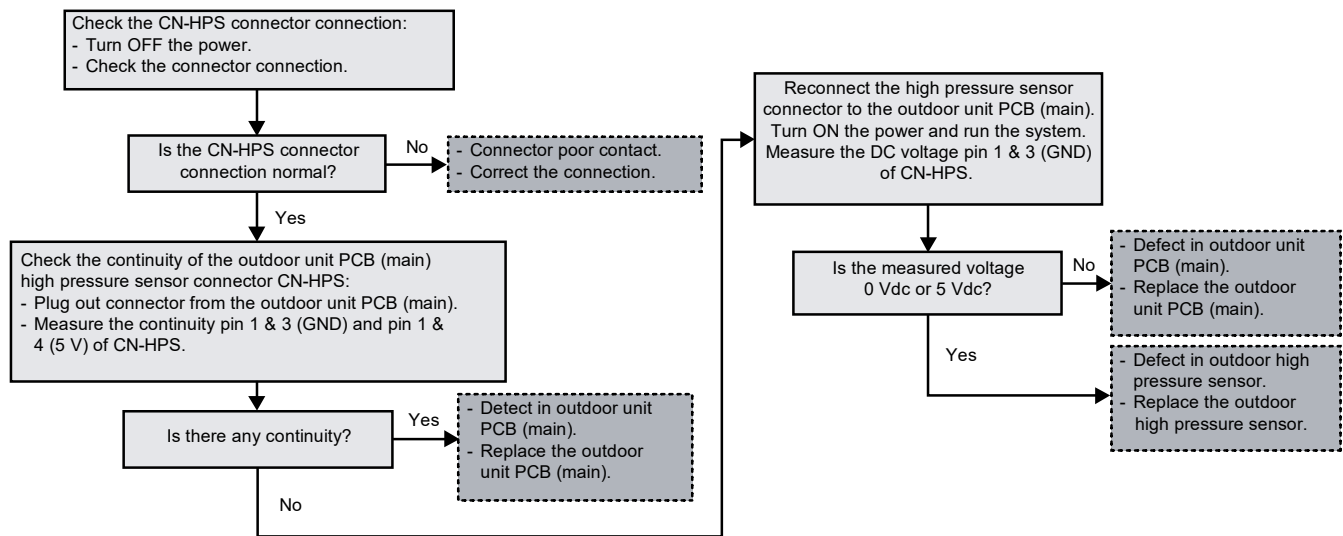

25.2.13 Abnormal External Thermistor 1 (- / - / H67)

Malfunction Caused:

- 1 Faulty connector connection.
- 2 Faulty room temperature zone 1 sensor.
- 3 Faulty indoor sub PCB.

Abnormality Judgment:

Continue for 5 seconds.

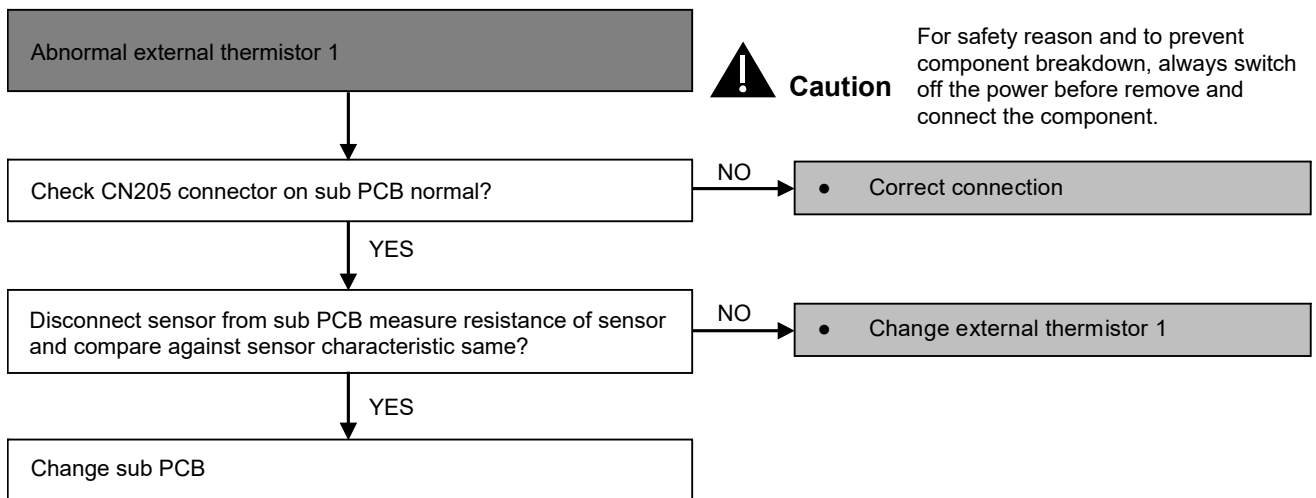

25.2.14 Abnormal External Thermistor 2 (- / - / H68)

Malfunction Caused:

- 1 Faulty connector connection.
- 2 Faulty room temperature zone 2 sensor.
- 3 Faulty indoor sub PCB.

Abnormality Judgment:

Continue for 5 seconds.

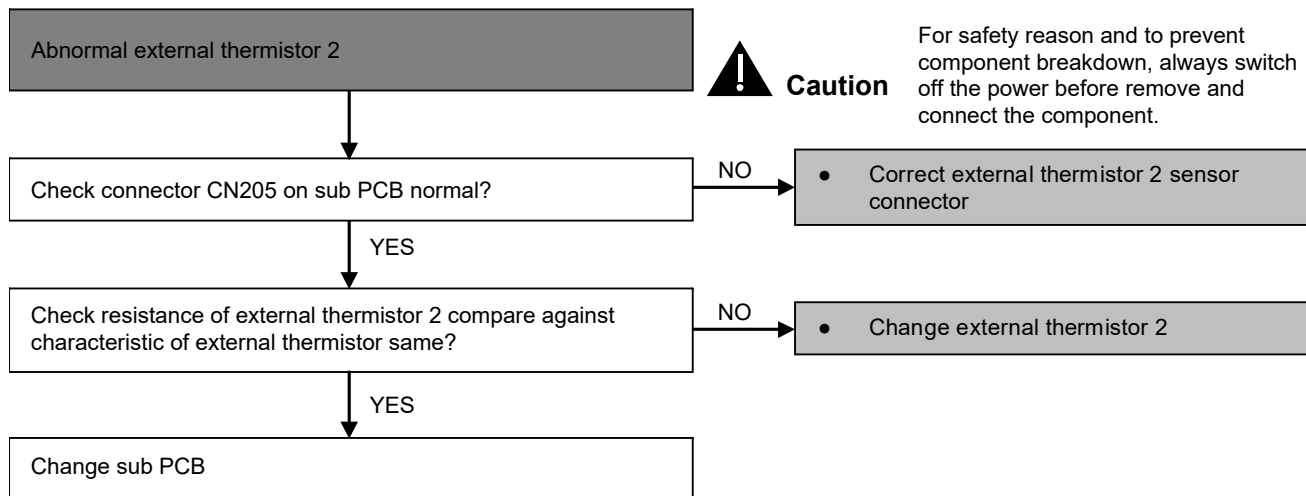

25.2.15 Indoor Backup Heater OLP Abnormality (- / - / H70)

Malfunction Decision Conditions:

During operation of indoor backup heater, when no power supplies to indoor backup heater or OLP open circuit.

Malfunction Caused:

1. Faulty power supply connector connection.
2. Faulty connector connection.
3. Faulty indoor backup heater overload protector (OLP).
4. Faulty indoor unit PCB (main).

Abnormality Judgment:

Continue for 60 seconds.

Troubleshooting:



For safety reason and to prevent component breakdown, always switch off the power before remove and connect the component.

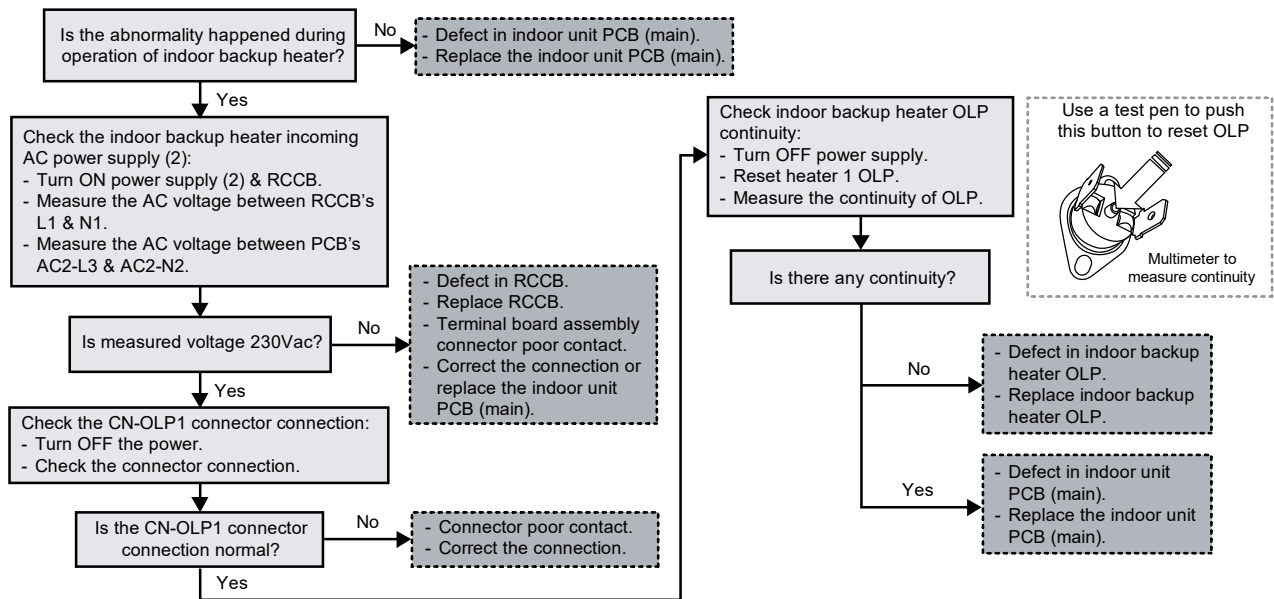

25.2.16 Tank Temperature Sensor Abnormality (- / - / H72)

Malfunction Decision Conditions:

When tank connection is set to ON, the temperatures detected by the tank temperature sensor are used to determine sensor error.

Malfunction Caused:

1. Faulty connector connection.
2. Faulty sensor.
3. Faulty indoor unit PCB (main).

Abnormality Judgment:

Continue for 5 seconds.

Troubleshooting:



Caution

For safety reason and to prevent component breakdown, always switch off the power before remove and connect the component.

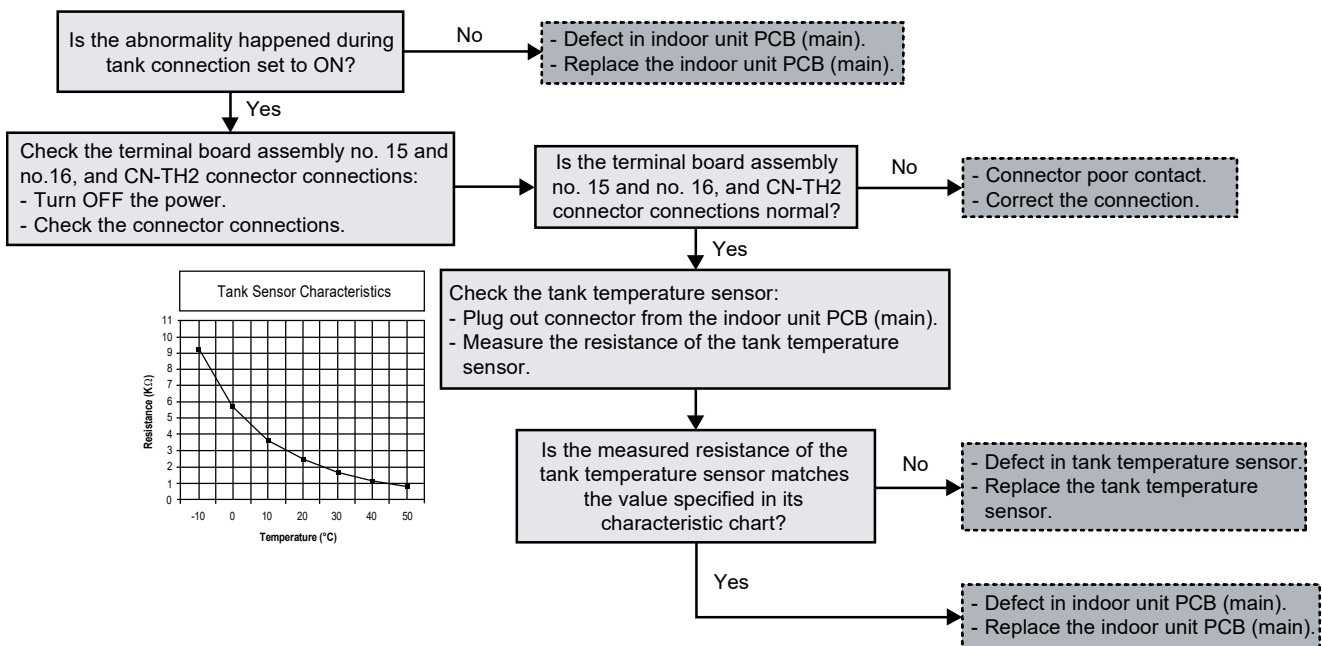

25.2.17 PCB Communication Error (- / - / H74)

Malfunction Decision Conditions:

When External PCB connection is select "YES" and no communication with External PCB micon for 10 seconds and above.

Malfunction Caused:

- 1 Faulty connector connection.
- 2 Faulty indoor PCB.
- 3 Faulty indoor sub PCB.

Abnormality Judgment:

After 1 minute operation started.

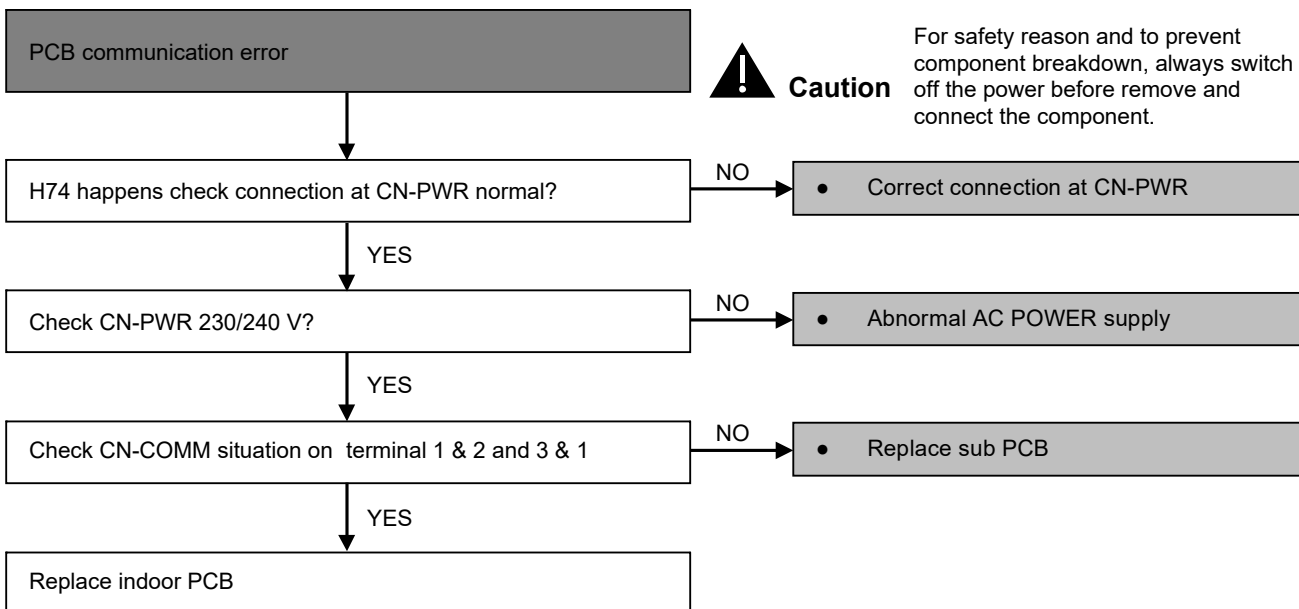

25.2.18 Indoor-Control Panel Communication Abnormality (- / - / H76)

Malfunction Decision Conditions:

During standby and operation of cooling and heating, indoor-control panel error occur.

Malfunction Caused:

1. Faulty connector connection.
2. Faulty control panel.
3. Faulty indoor unit PCB (main).

Troubleshooting: **Caution**

For safety reason and to prevent component breakdown, always switch off the power before remove and connect the component.

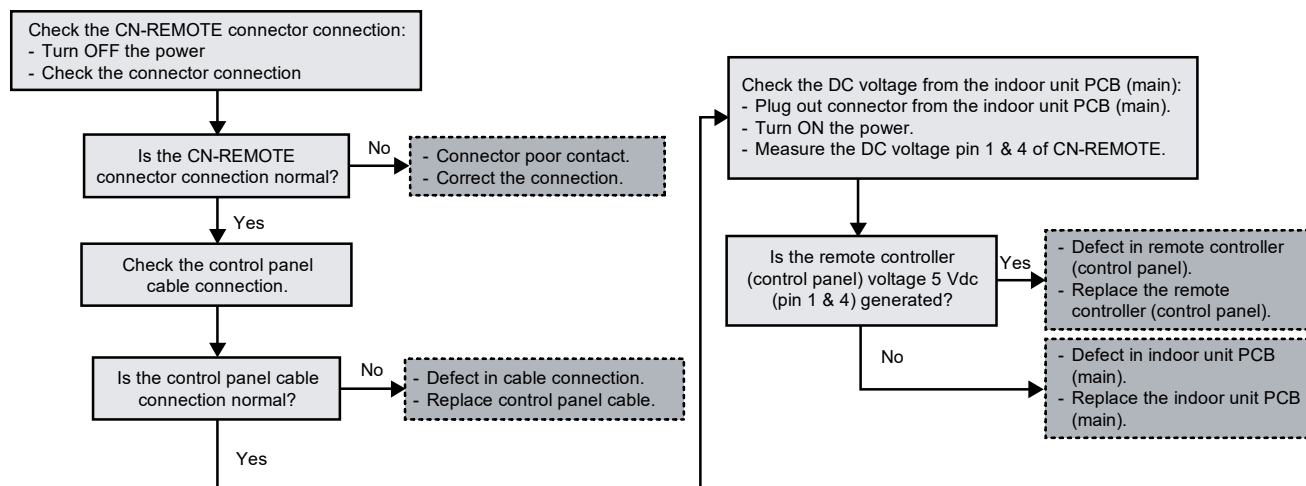

25.2.19 Indoor/Outdoor Abnormal Communication (H11 / E04 / H90)

Malfunction Decision Conditions:

During operation of cooling and heating, the data received from outdoor unit in indoor unit signal transmission is checked whether it is normal.

Malfunction Caused:

1. Faulty outdoor unit PCB (main).
2. Faulty indoor unit PCB (main).
3. Indoor-outdoor signal transmission error due to wrong wiring.
4. Indoor-outdoor signal transmission error due to breaking of wire in the connection wires between the indoor and outdoor units.
5. Indoor-outdoor signal transmission error due to disturbed power supply waveform.

Abnormality Judgment:

Continue for 1 minute after operation.

Troubleshooting: Caution

For safety reason and to prevent component breakdown, always switch off the power before remove and connect the component.

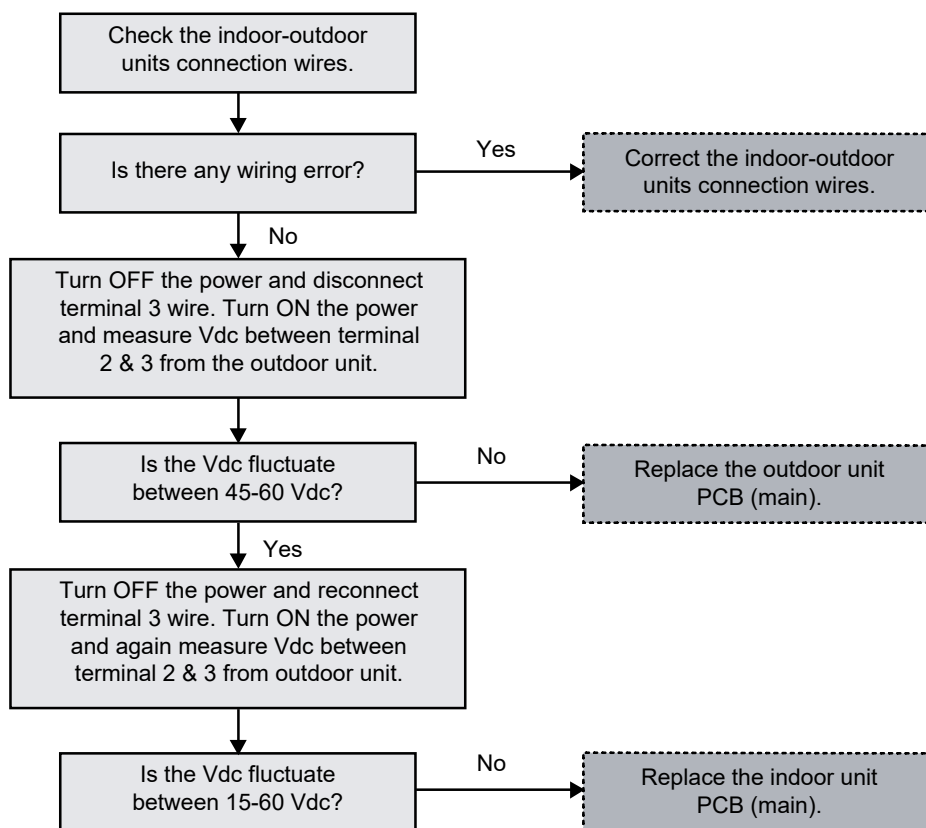

25.2.20 Unspecified Voltage between Indoor and Outdoor (H33 / P05 / H95)

Malfunction Decision Conditions

- The supply power is detected for its requirement by the indoor/outdoor transmission.

Malfunction Caused

- Wrong models interconnected.
- Wrong indoor unit and outdoor unit PCBs used.
- Indoor unit or outdoor unit PCB defective.

Troubleshooting

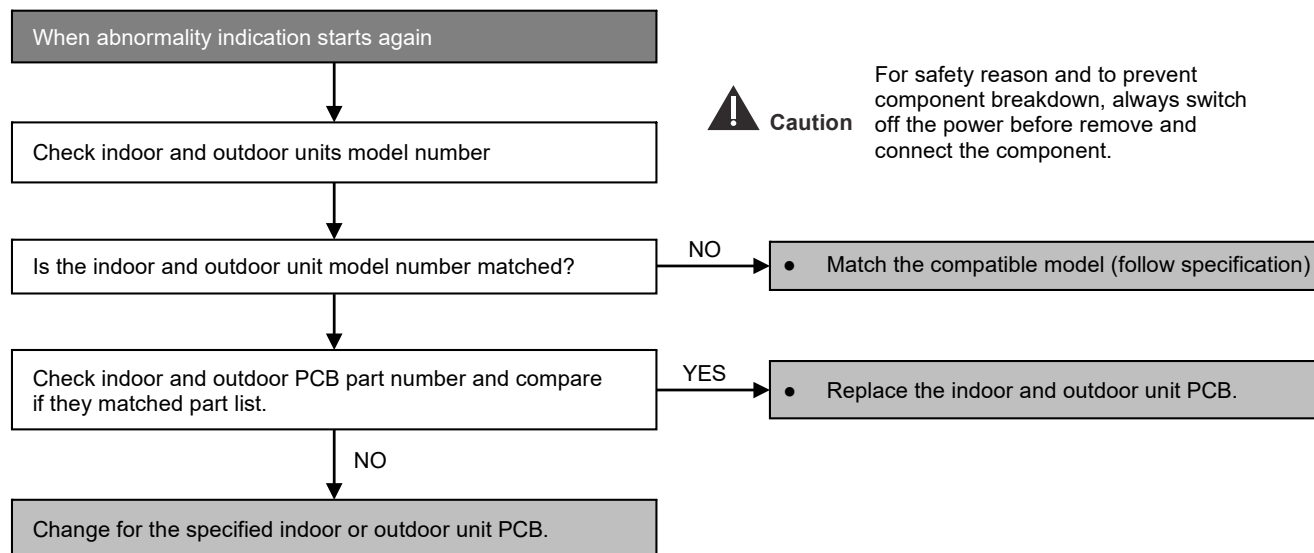

25.2.21 Outdoor High Pressure Error (H98 / - / H98)

Malfunction Decision Conditions:

During operation of heating, when pressure 4.0 MPa and above is detected by outdoor high pressure sensor.

Malfunction Caused:

1. Faulty water pump.
2. Insufficient water flow rate in system.
3. Water leak in system.
4. Dust accumulation in the outdoor unit heat exchanger.
5. Air short circuit at outdoor.
6. Faulty outdoor unit fan motor.
7. 2/3 way closed.
8. Clogged expansion valve or strainer.
9. Excessive refrigerant.
10. Faulty outdoor high pressure sensor.
11. Faulty outdoor unit PCB (main).
12. Room indoor clogged air filter or heat exchanger
13. Over-bent pipe

Troubleshooting:



Caution

For safety reason and to prevent component breakdown, always switch off the power before remove and connect the component.

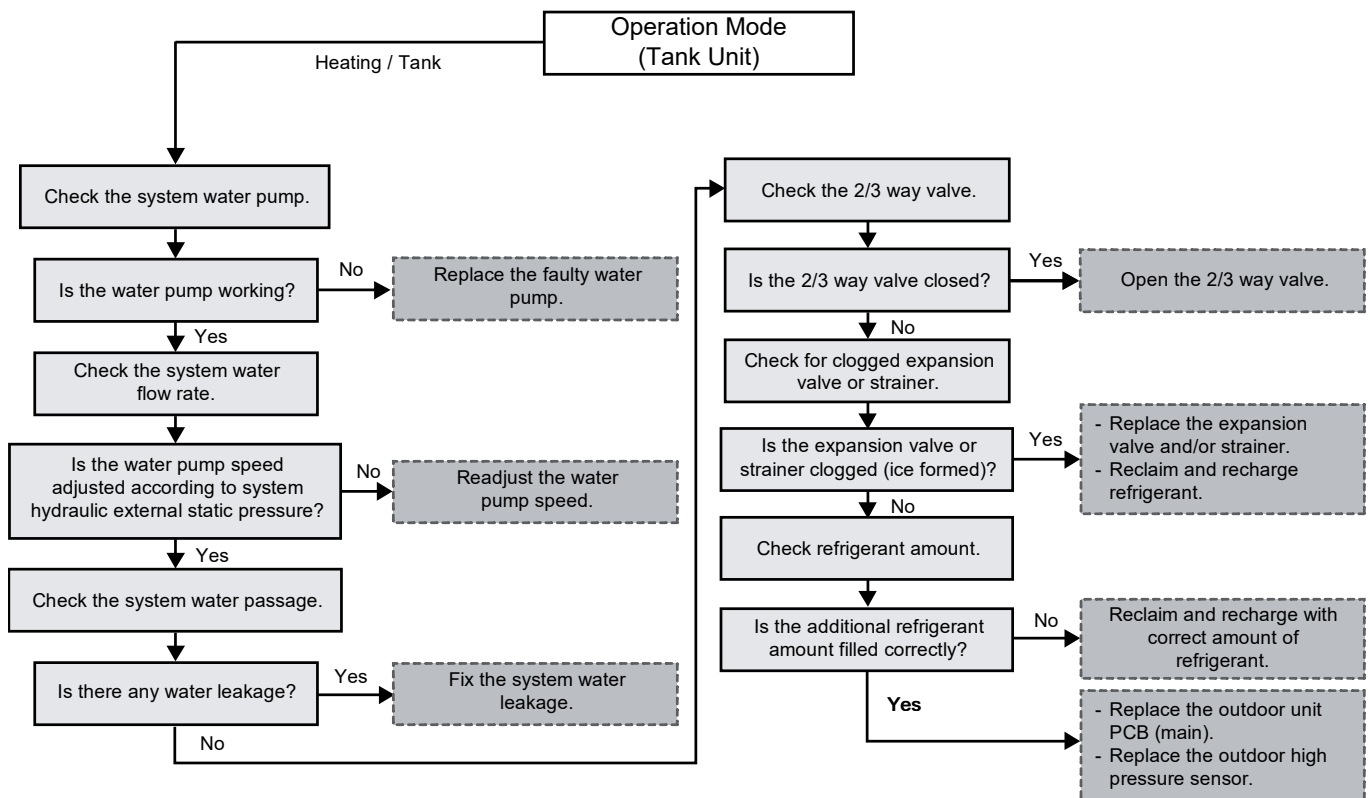

Troubleshooting (Room air Conditioning unit)

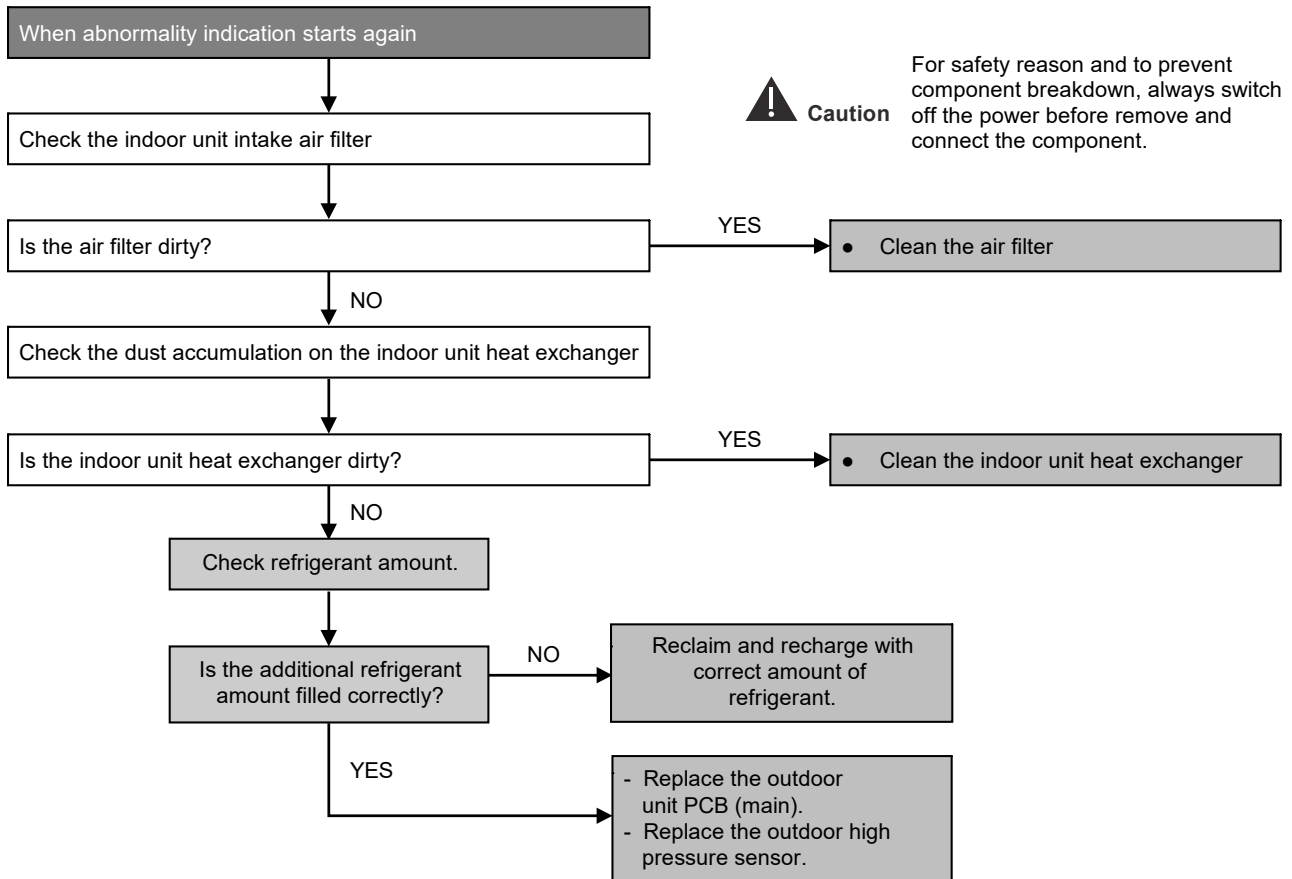

25.2.22 Outdoor High Pressure Protection: Cooling or Soft Dry (F95 / P04 / F95)

Malfunction Decision Conditions

- During operation of cooling or soft dry, when outdoor unit heat exchanger high temperature data is detected by the outdoor unit heat exchanger thermistor.

Malfunction Caused

- Outdoor heat exchanger temperature rise due to short-circuit of hot discharge air flow.
- Outdoor heat exchanger temperature rise due to defective of outdoor fan motor.
- Outdoor heat exchange temperature rise due to defective outdoor heat exchanger thermistor.
- Outdoor heat exchanger temperature rise due to defective of outdoor unit PCB.

Troubleshooting

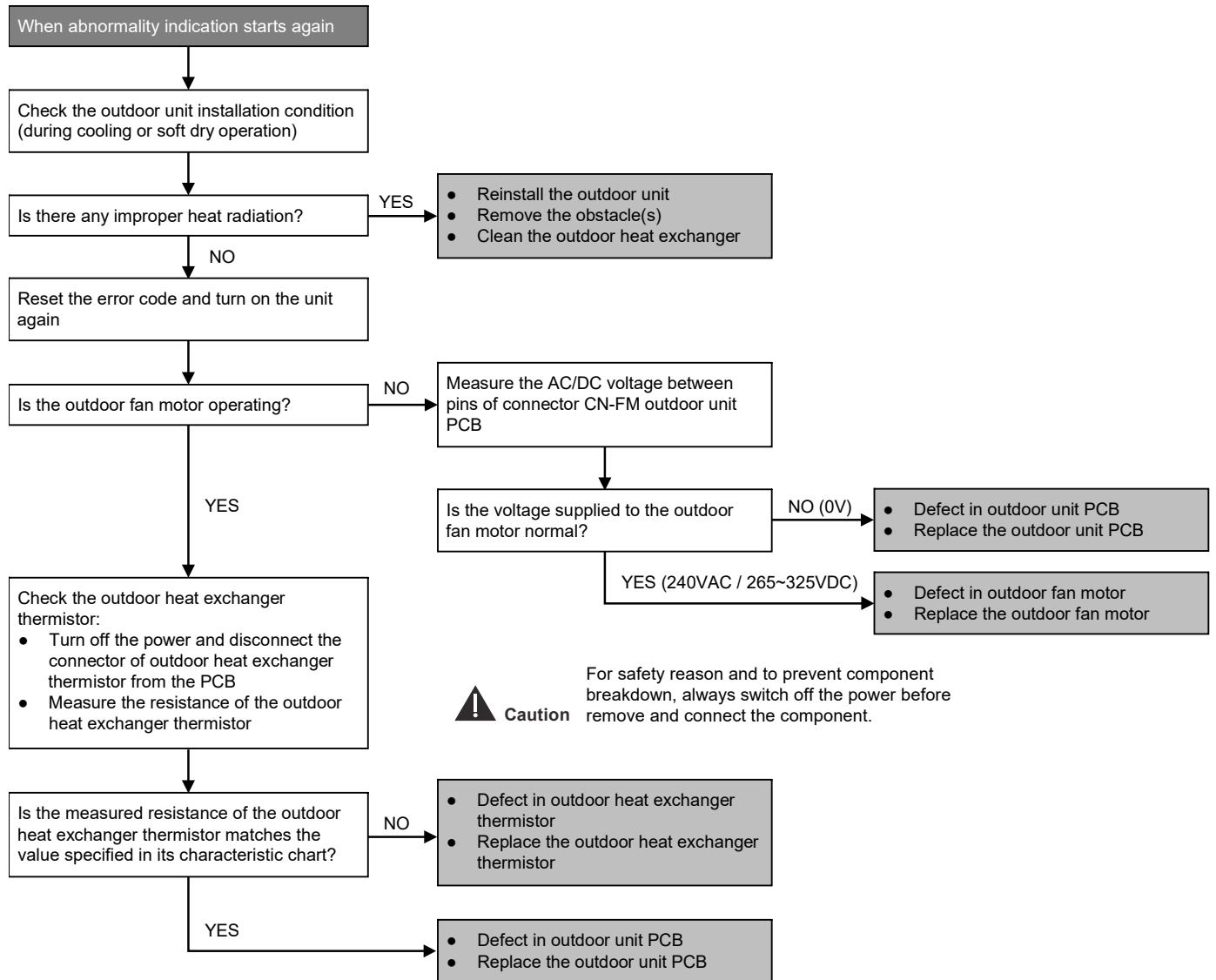

25.2.23 Indoor Freeze-up Protection (H99)

Error Code will not display (no Timer LED blinking) but store in EEPROM

Malfunction Decision Conditions

- Freeze prevention control takes place (when indoor pipe temperature is lower than 2°C)

Malfunction Caused

- Air short circuit at indoor unit
- Clogged indoor unit air filter
- Dust accumulation on the indoor unit heat exchanger
- 2/3 way valve closed
- Faulty indoor unit fan motor
- Refrigerant shortage (refrigerant leakage)
- Clogged expansion valve or strainer
- Faulty indoor pipe temperature sensor
- Faulty indoor unit PCB

Troubleshooting

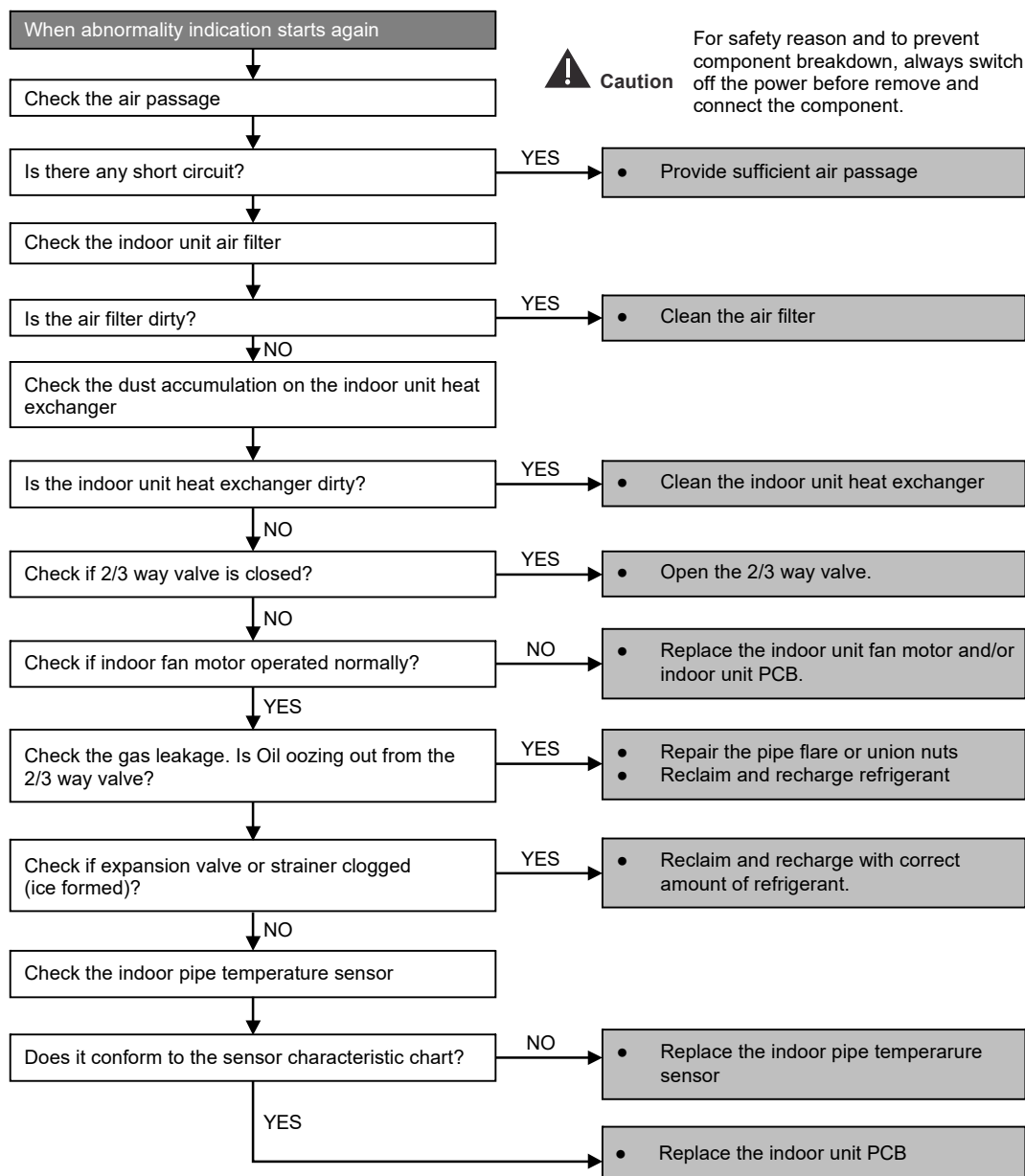

25.2.24 Outdoor High Pressure Switch Activate (F94 / P04 / F12)

Malfunction Decision Conditions:

During operation of cooling and heating, when pressure 4.5 MPa and above is detected by outdoor high pressure switch.

Malfunction Caused:

1. Dust accumulation on the outdoor unit heat exchanger.
2. Air short circuit at outdoor unit.
3. Faulty water pump.
4. Insufficient water flow rate in system.
5. Water leak in system.
6. 2/3 way valve closed.
7. Clogged expansion valve or strainer.
8. Excessive refrigerant.
9. Faulty outdoor high pressure sensor and switch.
10. Faulty outdoor unit PCB.

Abnormality Judgment:

Continue 4 times in 20 minutes.

Troubleshooting:



Caution

For safety reason and to prevent component breakdown, always switch off the power before remove and connect the component.

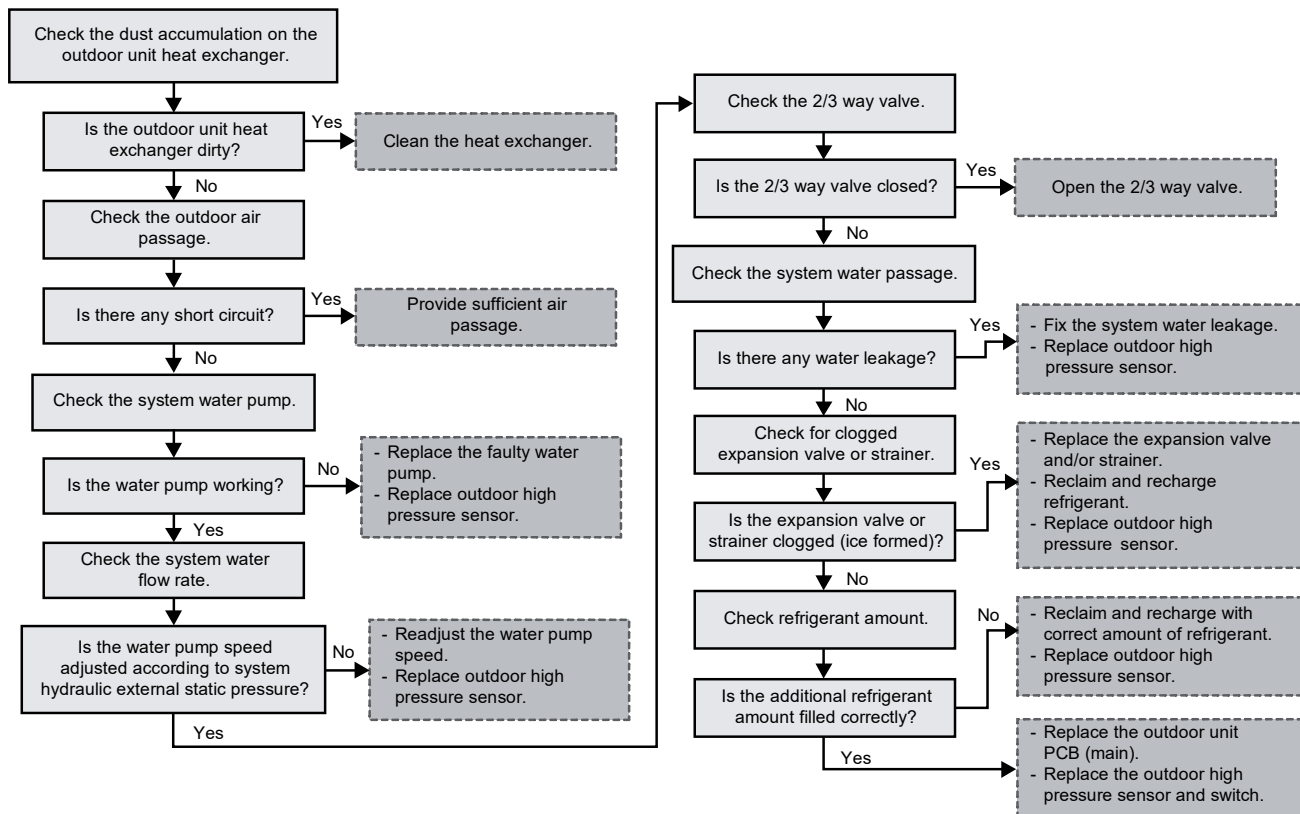

25.2.25 Compressor Rotation Failure (F93 / P29 / F14)

Malfunction Decision Conditions

- A compressor rotation failure is detected by checking the compressor running condition through the position detection circuit.

Malfunction Caused

- Compressor terminal disconnect
- Faulty Outdoor PCB
- Faulty compressor

Troubleshooting

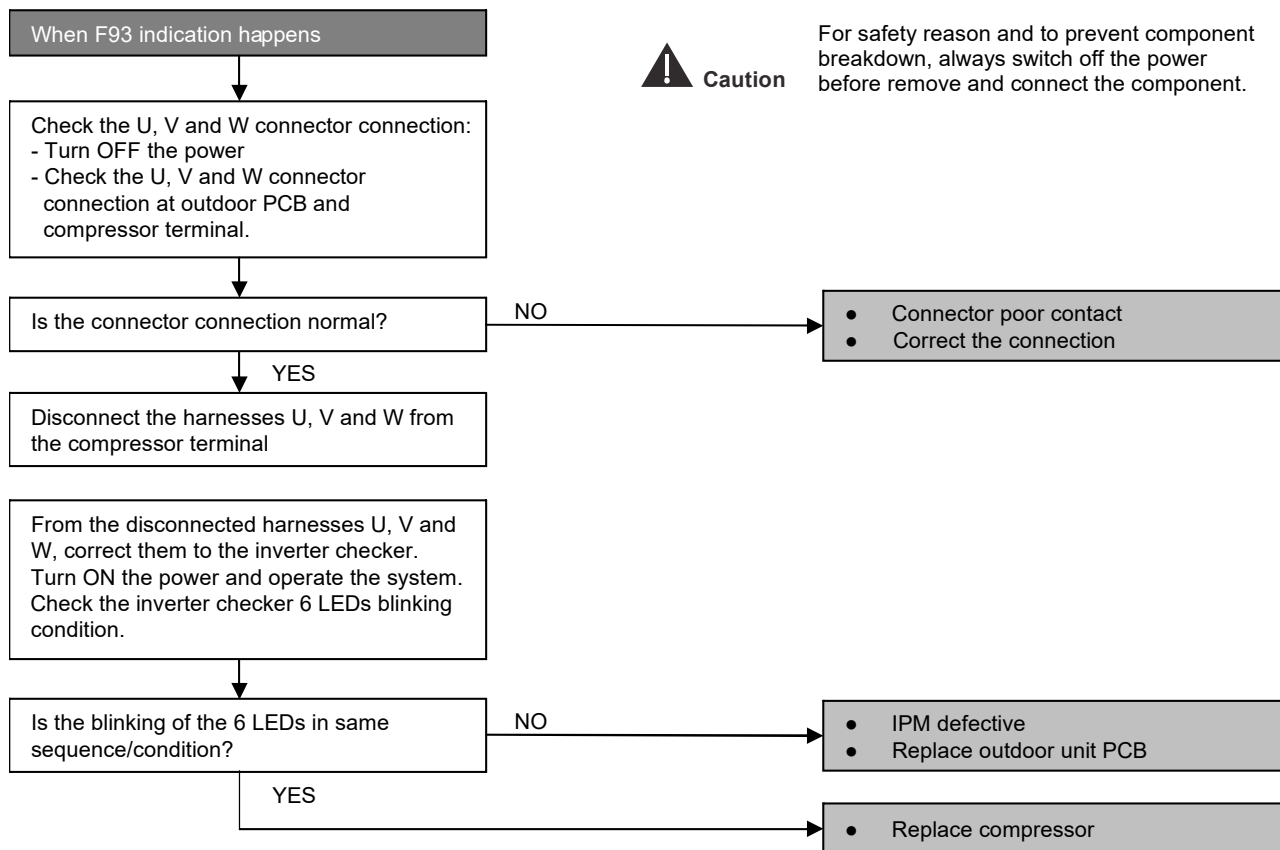

25.2.26 Outdoor Fan Motor (DC Motor) Mechanism Locked (H97 / P22 / F15)

Malfunction Decision Conditions

- The rotation speed detected by the Hall IC during fan motor operation is used to determine abnormal fan motor.

Malfunction Caused

- Operation stops due to short circuit inside the fan motor winding.
- Operation stops due to breaking of wire inside the fan motor.
- Operation stops due to breaking of fan motor lead wires.
- Operation stops due to Hall IC malfunction.
- Operation error due to faulty outdoor unit PCB.

Troubleshooting

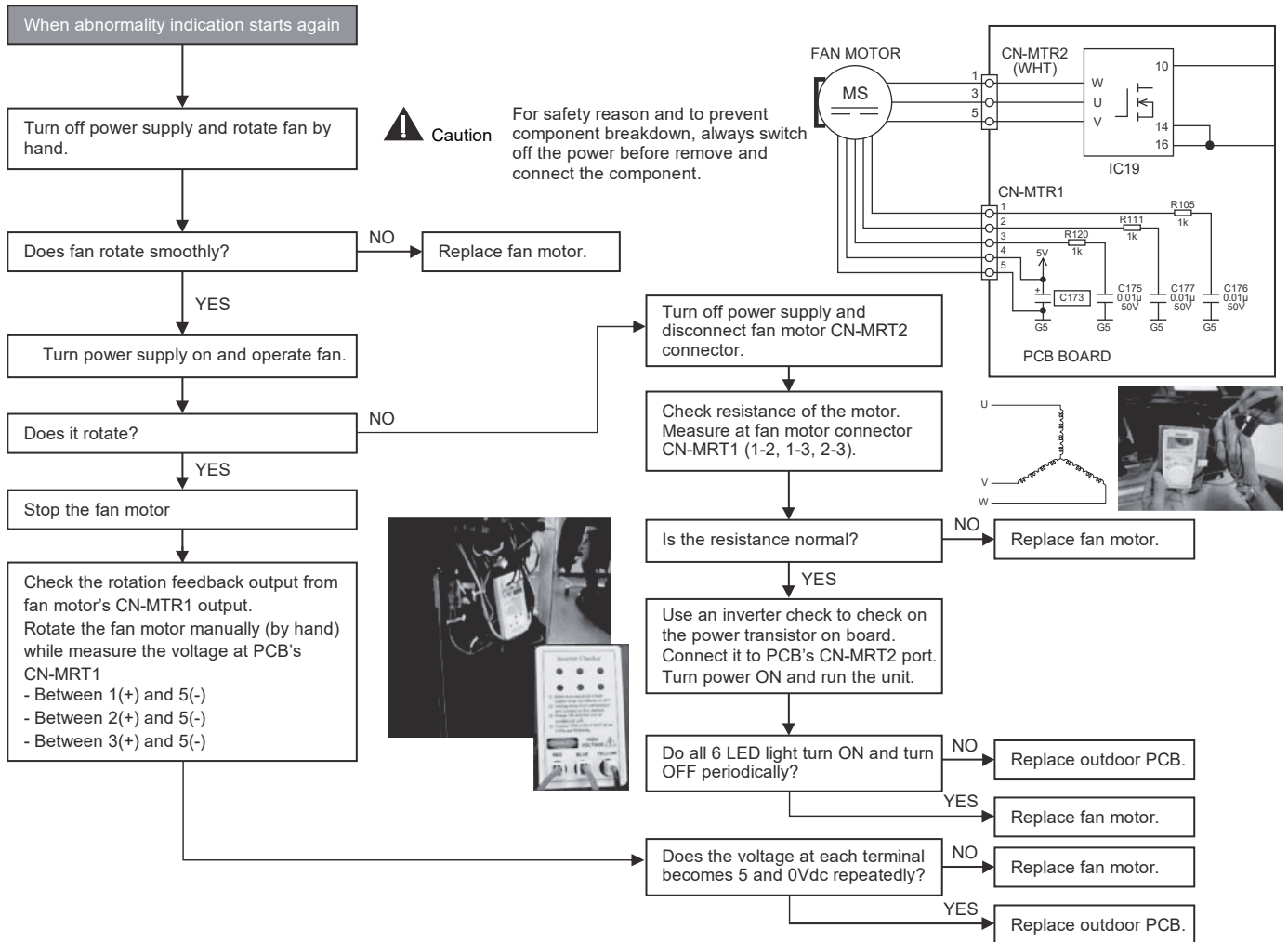

25.2.27 Input Over Current Detection (F98 / H01 / F16)

Malfunction Decision Conditions

- During operation of cooling and heating, when an input over-current (X value in Total Running Current Control) is detected by checking the input current value being detected by current transformer (CT) with the compressor running.

Malfunction Caused

- Excessive refrigerant.
- Faulty outdoor unit PCB.

Troubleshooting

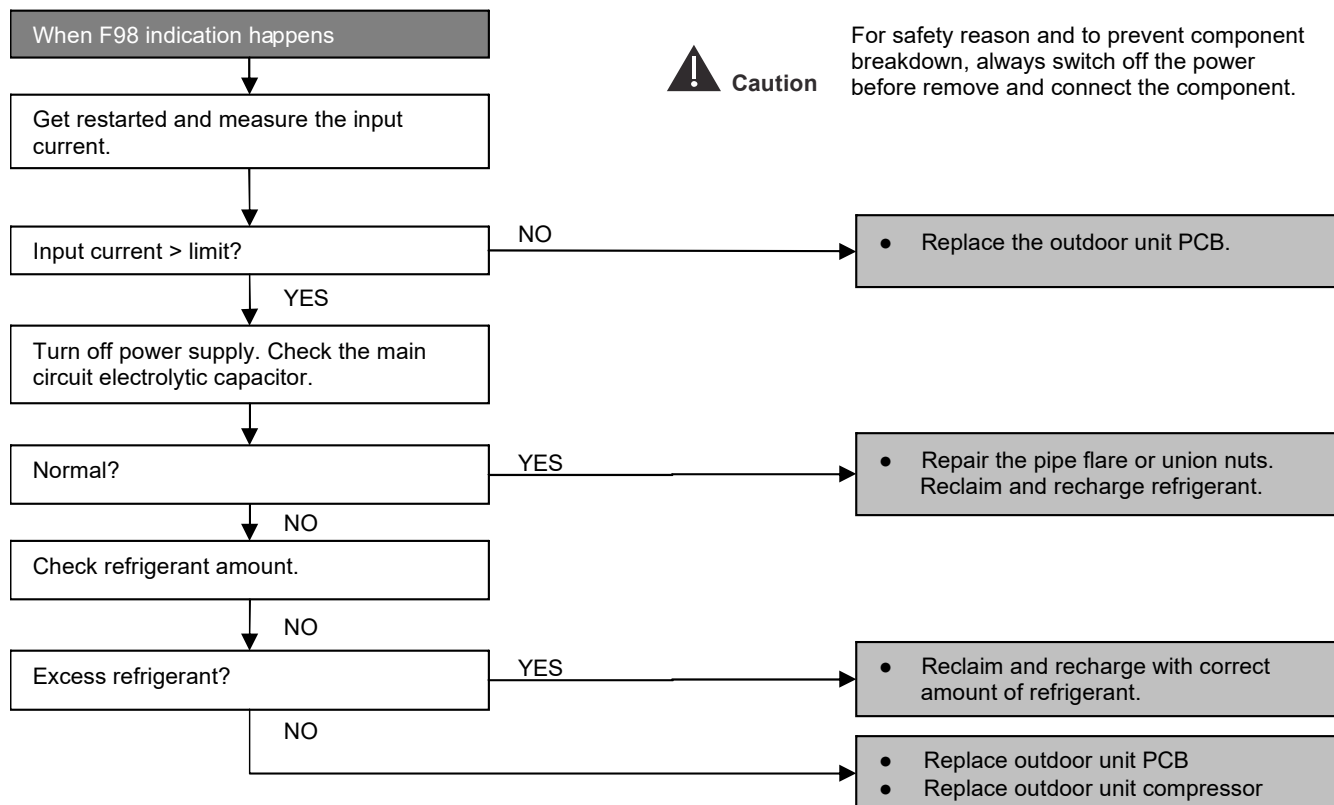

25.2.28 Compressor Overheating (F97 / P03 / F20)

Malfunction Decision Conditions:

During operation of cooling and heating, when temperature above 112°C is detected by the compressor tank temperature sensor.

Malfunction Caused:

1. Faulty compressor tank temperature sensor.
2. 2/3 way valve closed.
3. Refrigerant shortage (refrigerant leakage).
4. Clogged expansion valve or strainer.
5. Faulty outdoor unit PCB (main).
6. Faulty compressor.

Abnormality Judgment:

Continue 4 times in 30 minutes.

Troubleshooting:



Caution

For safety reason and to prevent component breakdown, always switch off the power before remove and connect the component.

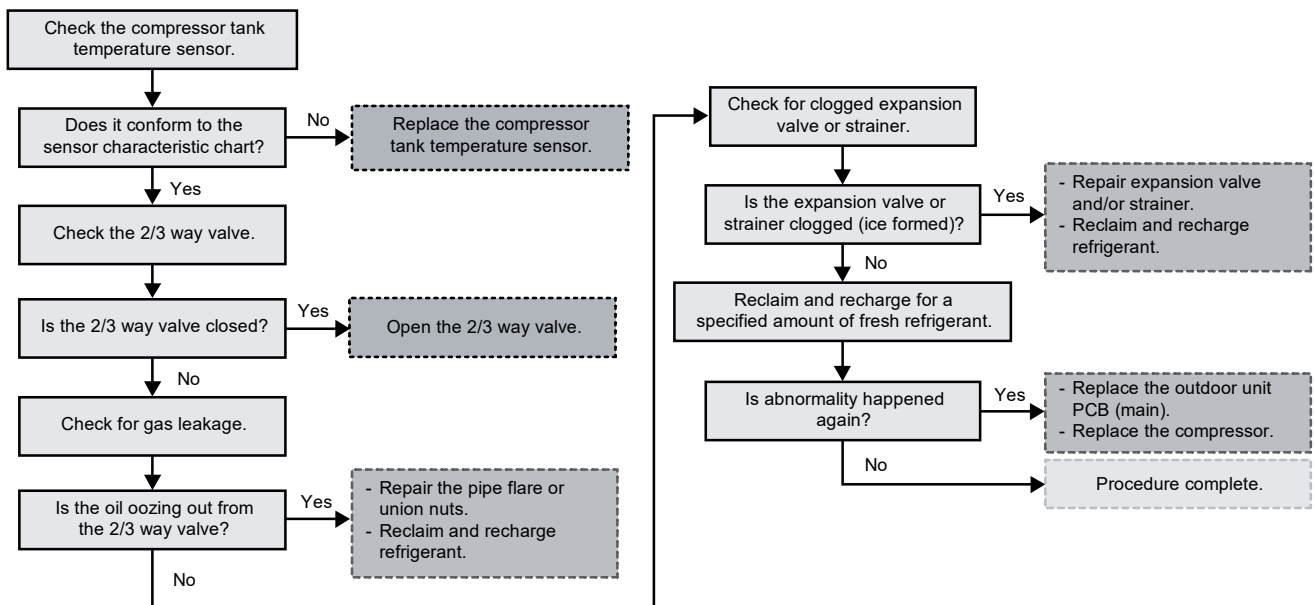

25.2.29 IPM Overheating (F96 / P07 / F22)

Malfunction Decision Conditions

- During operating of cooling and heating, when IPM temperature data (100°C) is detected by the IPM temperature sensor.

Multi Models only

- Compressor Overheating: During operation of cooling and heating, when the compressor OL is activated.
- Heat Sink Overheating: During operation of cooling and heating, when heat sink temperature data (90°C) is detected by the heat sink temperature sensor.

Malfunction Caused

- IPM overheats due to short circuit of hot discharge air flow.
- IPM overheats due to defective of outdoor fan motor.
- IPM overheats due to defective of internal circuitry of IPM.
- IPM overheats due to defective IPM temperature sensor.

Multi Models Only

- Compressor OL connector poor contact.
- Compressor OL faulty.

Troubleshooting

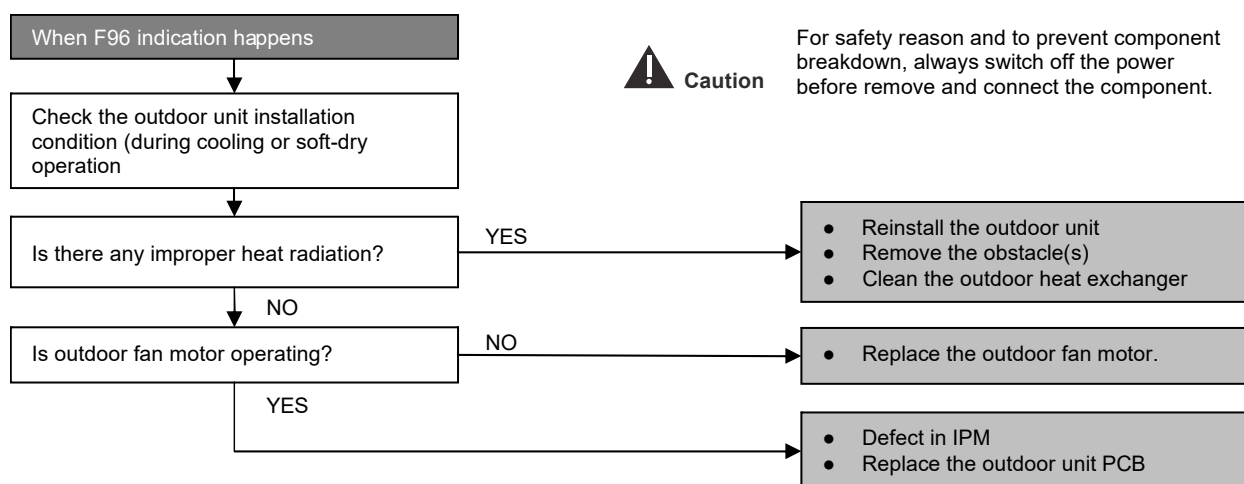

25.2.30 Output Over Current Detection (F99 / P16 / F23)

Malfunction Decision Conditions:

During operation of cooling and heating, when outdoor DC current is above set value is detected by the IPM DC Peak sensing circuitry in the outdoor unit PCB (main).

Malfunction Caused:

1. Faulty outdoor unit PCB (main).
2. Faulty compressor.

Abnormality Judgment:

Continue for 7 times.

Troubleshooting:  **Caution**

For safety reason and to prevent component breakdown, always switch off the power before remove and connect the component.

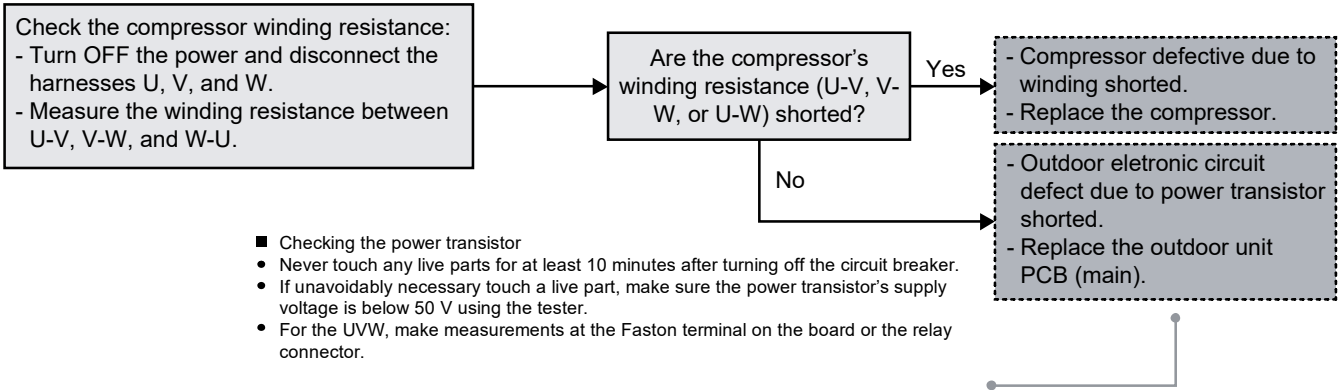

- Checking the power transistor
- Never touch any live parts for at least 10 minutes after turning off the circuit breaker.
- If unavoidably necessary touch a live part, make sure the power transistor's supply voltage is below 50 V using the tester.
- For the UVW, make measurements at the Faston terminal on the board or the relay connector.

Tester's negative terminal	Power transistor (+)	UVW	Power transistor (-)	UVW
Tester's positive terminal	UVW	Power transistor (+)	UVW	Power transistor (-)
Normal resistance	Several kohms to several Mohms			
Abnormal resistance	0 or ∞			

25.2.31 Refrigeration Cycle Abnormality (F91 / P15 / F24)

Malfunction Decision Conditions

- The input current is low while the compressor is running at higher than the setting frequency.

Malfunction Caused

- Lack of gas.
- 3-way valve close.

Troubleshooting

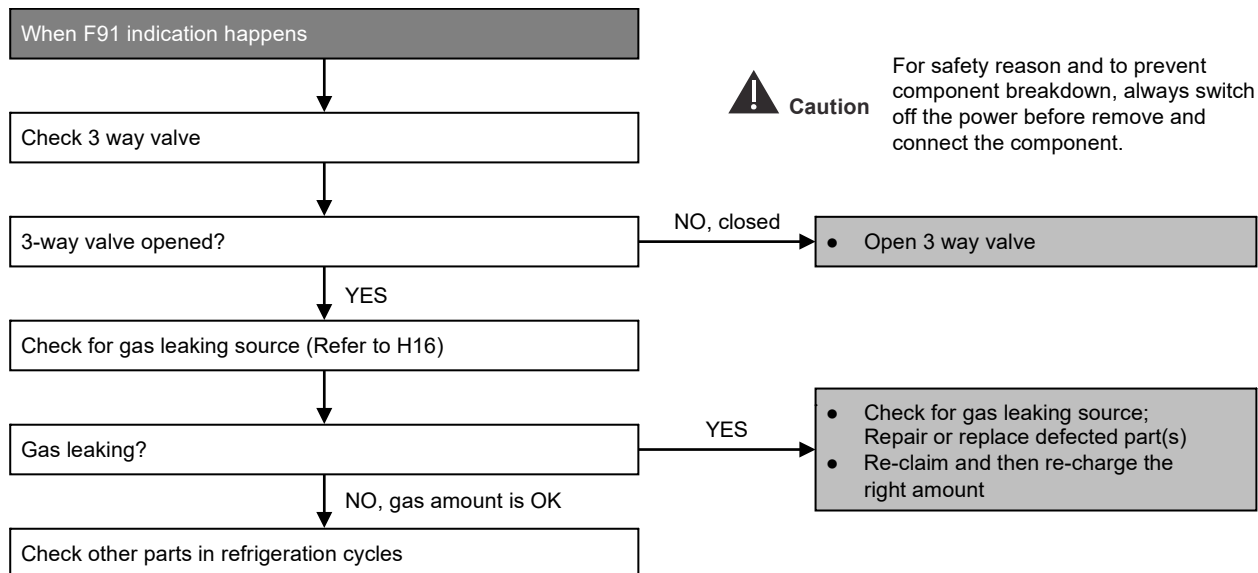

25.2.32 Four Way Valve Abnormality (F11 / L18 / F25)

Malfunction Decision Conditions

- When indoor heat exchanger is cold during heating (except deice) or when indoor heat exchanger is hot during cooling and compressor operating, the 4-way valve is detected as malfunction.

Malfunction Caused

- Indoor heat exchanger (pipe) thermistor
- 4-way valve malfunction

Troubleshooting

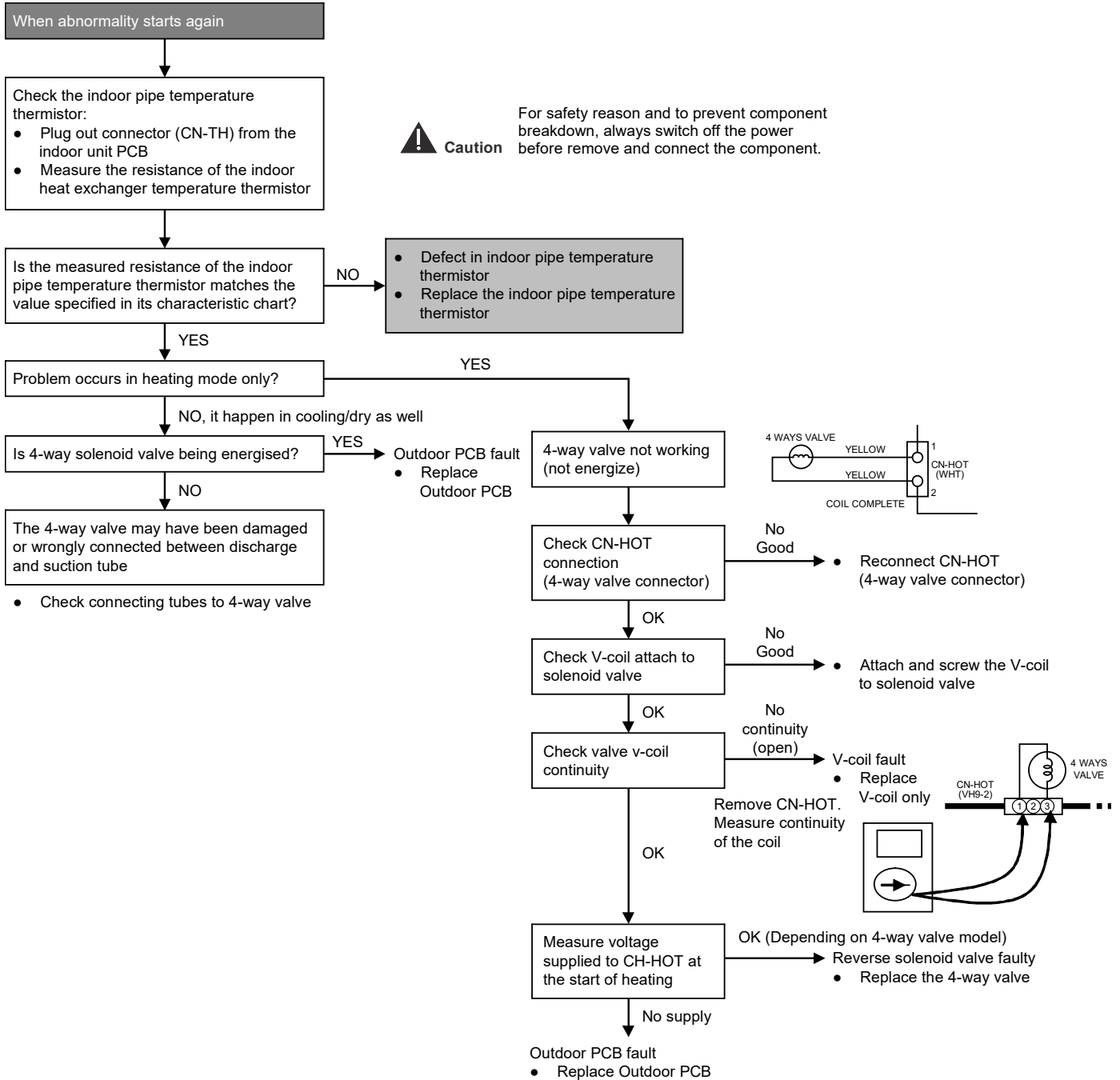

* Check gas side pipe – for hot gas flow in cooling mode

25.2.33 Outdoor High Pressure Switch Abnormal (H64 / P04 / F27)

Malfunction Decision Conditions:

During compressor stop, and outdoor high pressure switch is remain opened.

Malfunction Caused:

1. Faulty connector connection.
2. Faulty switch.
3. Faulty outdoor unit PCB (main).

Abnormality Judgment:

Continue for 1 minute.

Troubleshooting: Caution

For safety reason and to prevent component breakdown, always switch off the power before remove and connect the component.

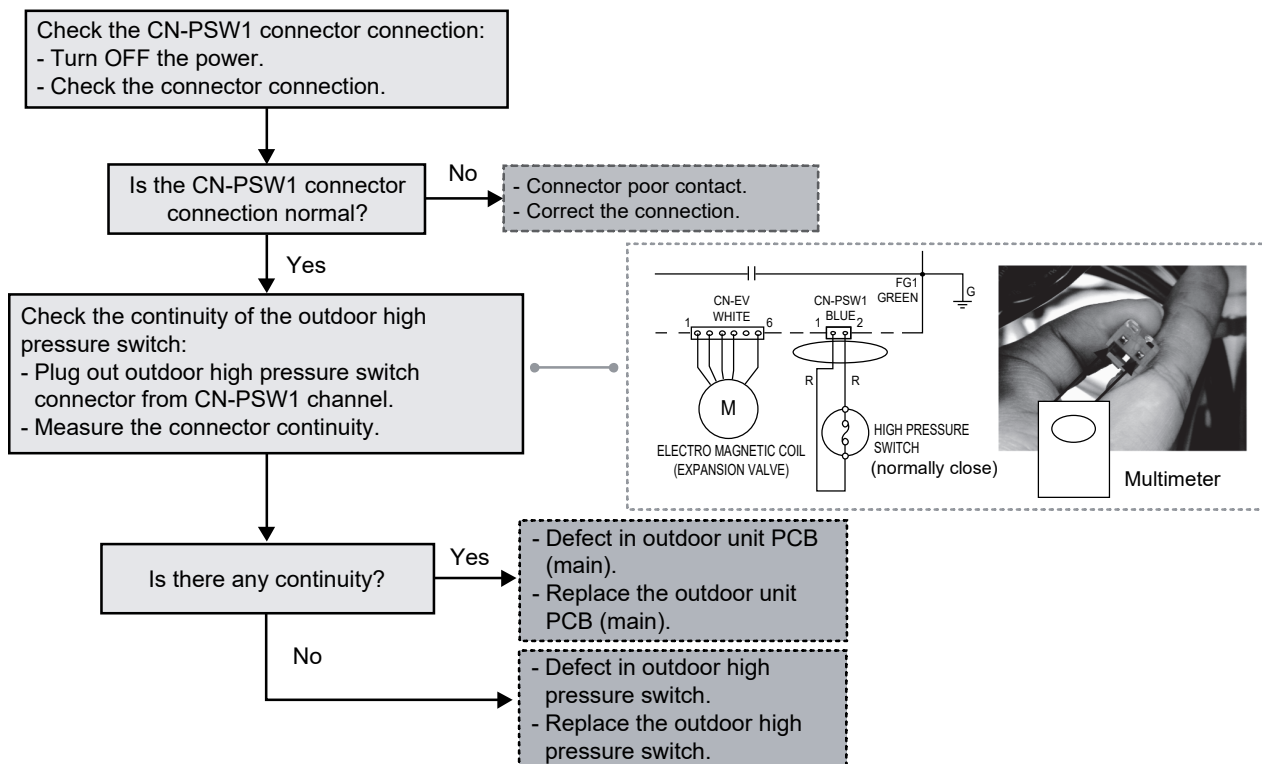

25.2.34 Indoor Water Outlet Temperature Sensor 2 Abnormality (- / - / F30)

Malfunction Decision Conditions:

During startup and operation of cooling and heating, the temperatures detected by the indoor water outlet temperature sensor 2 are used to determine sensor error.

Malfunction Caused:

1. Faulty connector connection.
2. Faulty sensor.
3. Faulty indoor unit PCB.

Abnormality Judgment:

Continue for 5 seconds.

Troubleshooting:



Caution

For safety reason and to prevent component breakdown, always switch off the power before remove and connect the component.

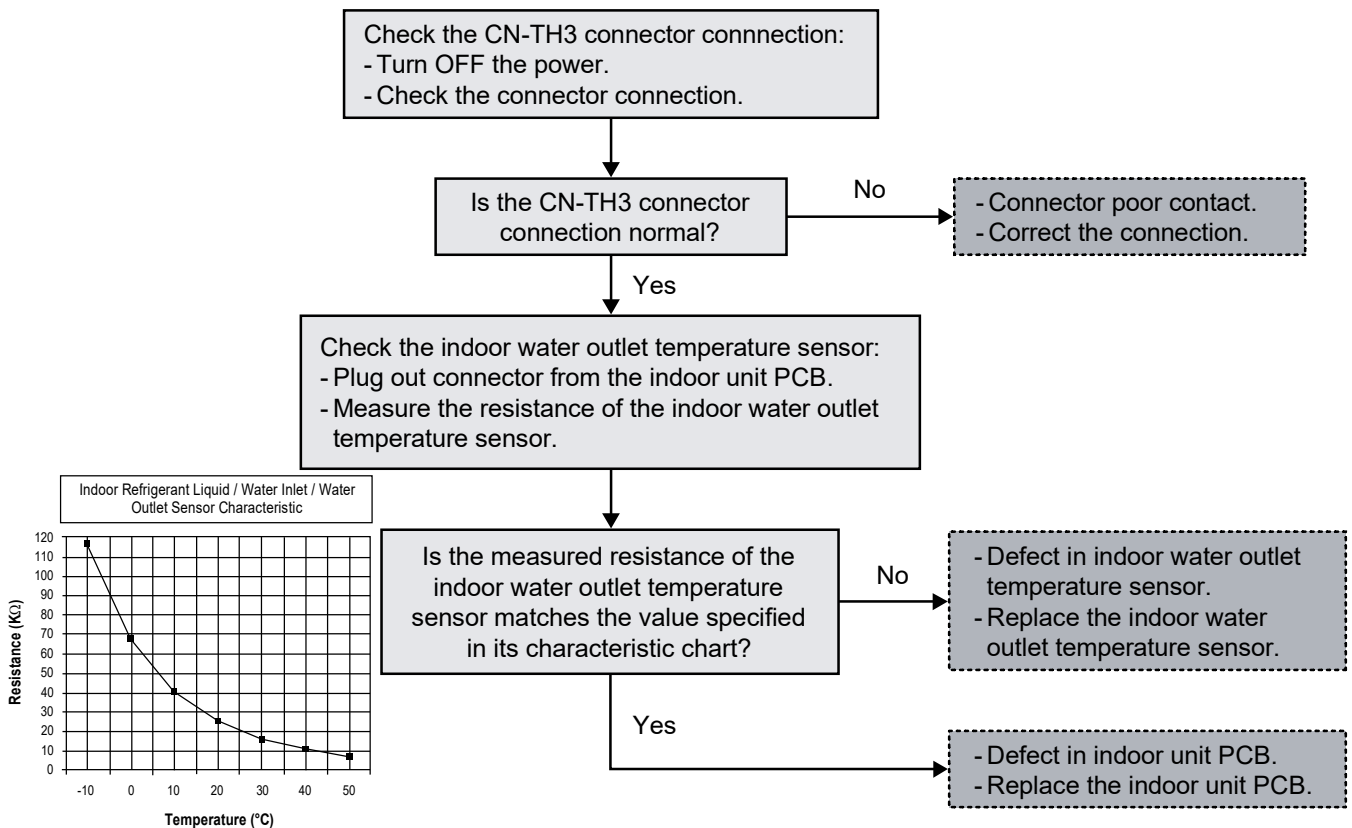

25.2.35 Outdoor Air Temperature Sensor Abnormality (H27 / F08 / F36)

Malfunction Decision Conditions:

During startup and operation of cooling and heating, the temperatures detected by the outdoor air temperature sensor are used to determine sensor error.

Malfunction Caused:

1. Faulty connector connection.
2. Faulty sensor.
3. Faulty outdoor unit PCB (main).

Abnormality Judgment:

Continue for 5 seconds.

Troubleshooting

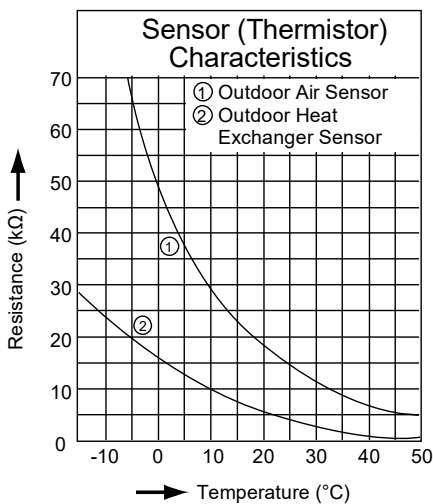
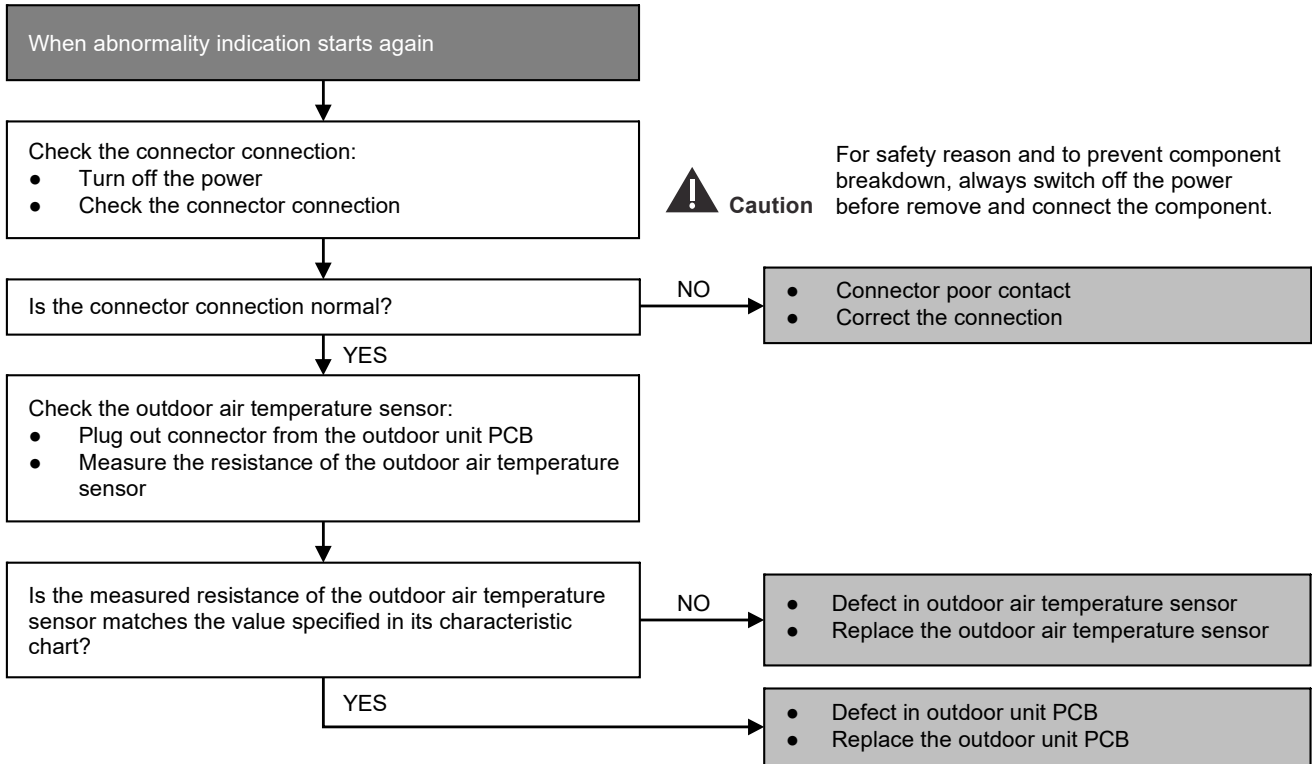

25.2.36 Indoor Water Inlet Temperature Sensor Abnormality (- / - / F37)

Malfunction Decision Conditions:

During startup and operation of cooling and heating, the temperatures detected by the indoor water inlet temperature sensor are used to determine sensor error.

Malfunction Caused:

1. Faulty connector connection.
2. Faulty sensor.
3. Faulty indoor unit PCB (main).

Abnormality Judgment:

Continue for 5 seconds.

Troubleshooting:



Caution

For safety reason and to prevent component breakdown, always switch off the power before remove and connect the component.

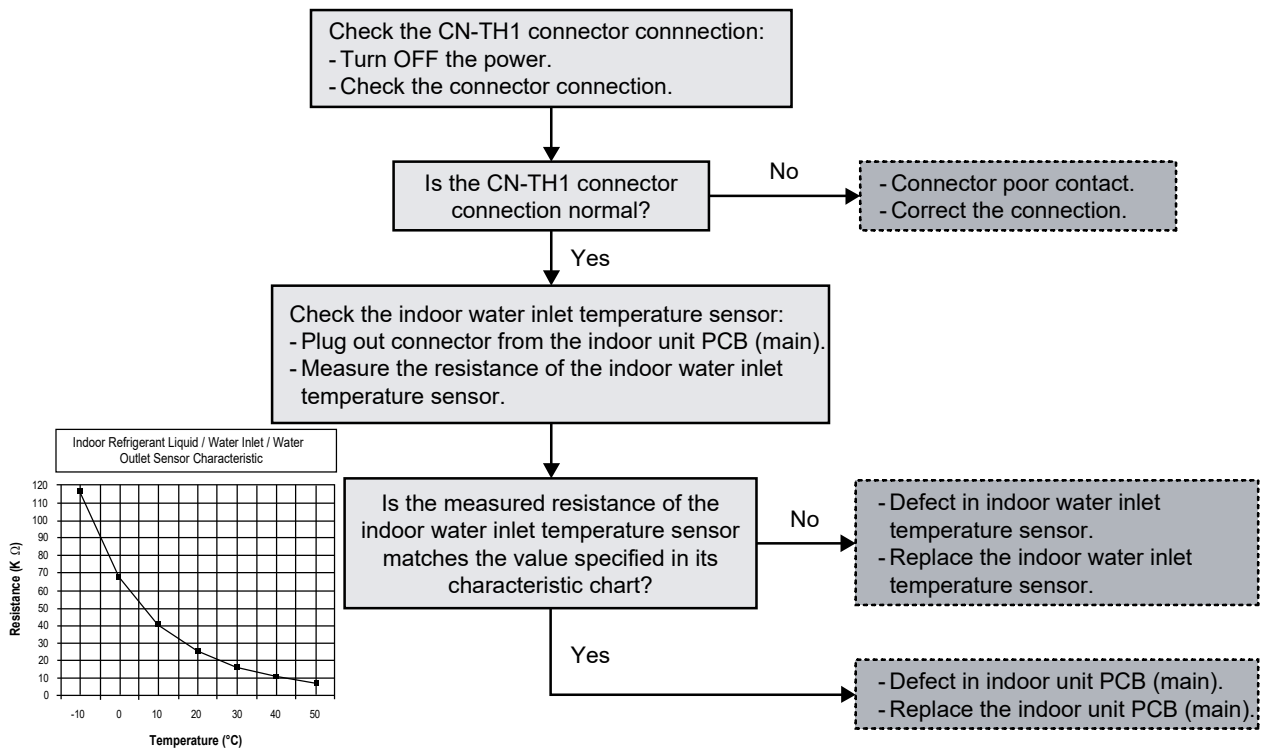

25.2.37 Outdoor Discharge Pipe Temperature Sensor Abnormality (H30 / F04 / F40)

Malfunction Decision Conditions

- During startup and operation of cooling and heating, the temperatures detected by the outdoor compressor temperature sensor are used to determine sensor errors.

Malfunction Caused

- Faulty connector connection.
- Faulty sensor.
- Faulty PCB.

Troubleshooting

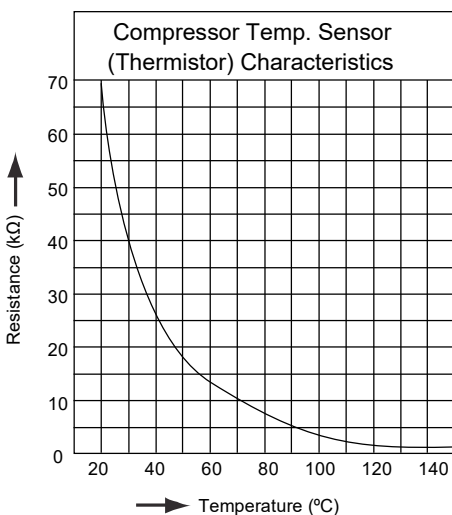
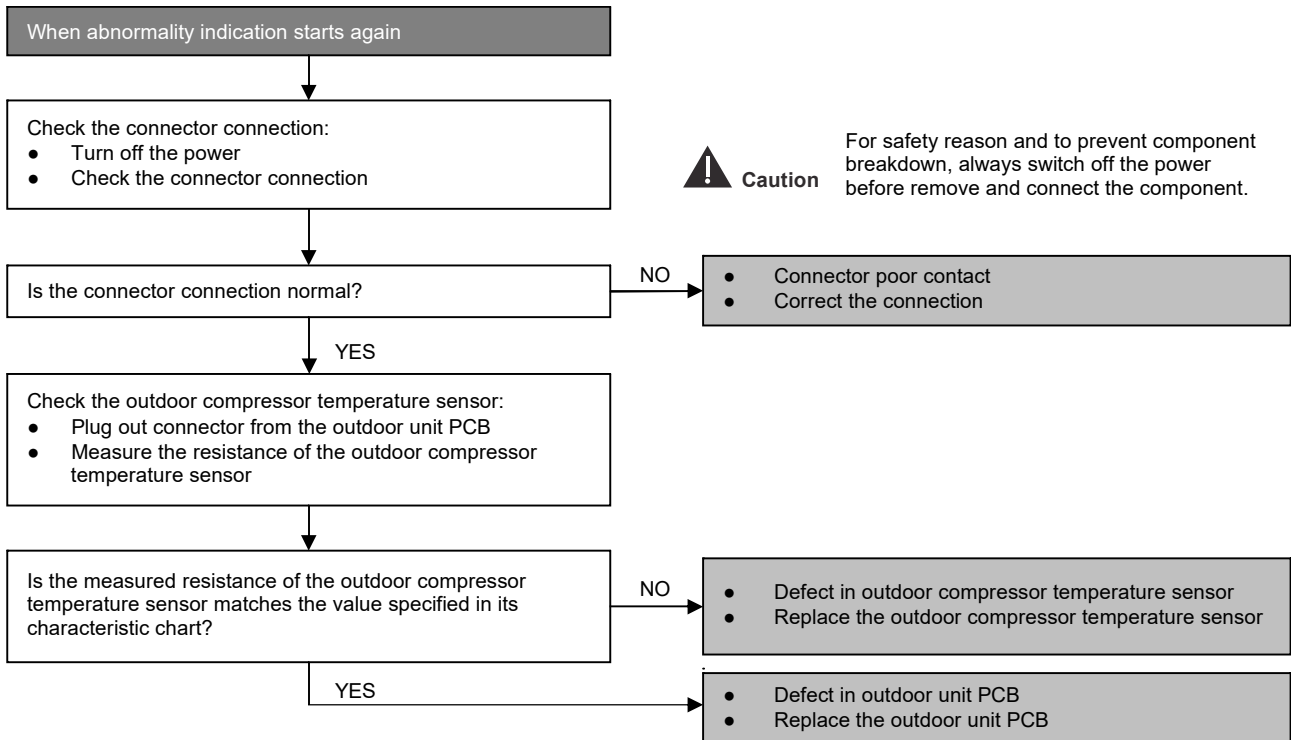

25.2.38 Power Factor Correction (PFC) Abnormality (F90 / H02 / F41)

Malfunction Decision Conditions

- To maintain DC voltage level supply to power transistor.
- To detect high DC voltage level after rectification.

Malfunction Caused

- During startup and operation of cooling and heating, when Power Factor Correction (PFC) protection circuitry at the outdoor unit main PCB senses abnormal DC voltage level for power transistors.
- When DC voltage detected is LOW, transistor switching will turn ON by controller to push-up the DC level.
- When DC voltage detected is HIGH (391Vdc – 425Vdc), active LOW signal will send by the controller to turn OFF relay RY-C.

Troubleshooting

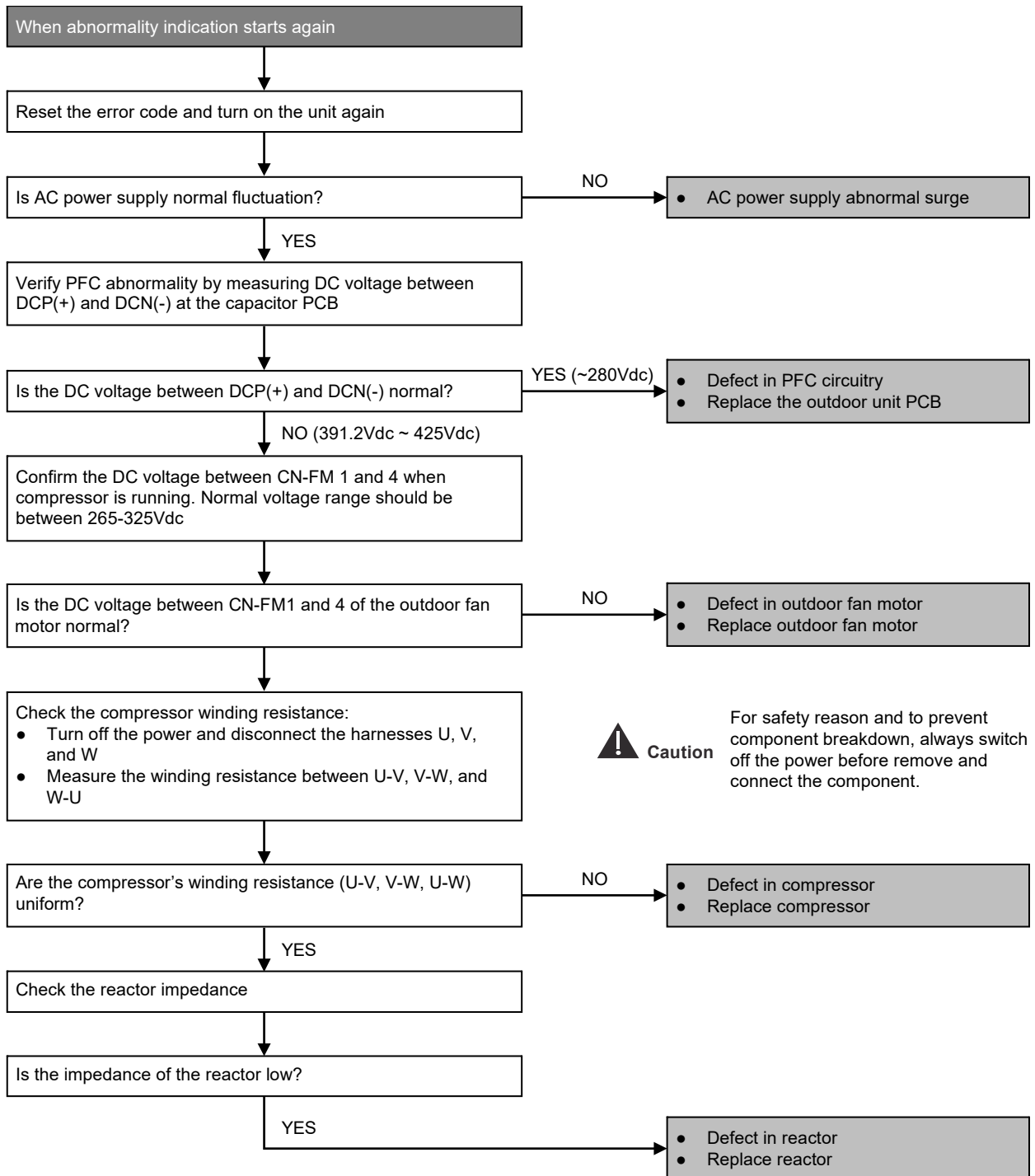

25.2.39 Outdoor Pipe Temperature Sensor Abnormality (H28 / F06 / F42)

Malfunction Decision Conditions

- During startup and operation of cooling and heating, the temperatures detected by the outdoor pipe temperature sensor are used to determine sensor errors.

Malfunction Caused

- Faulty connector connection.
- Faulty sensor.
- Faulty PCB.

Troubleshooting

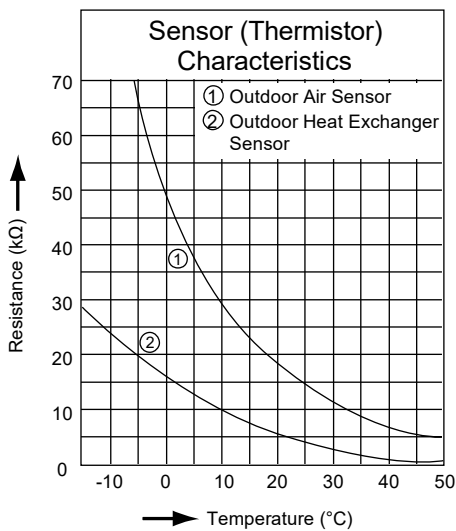
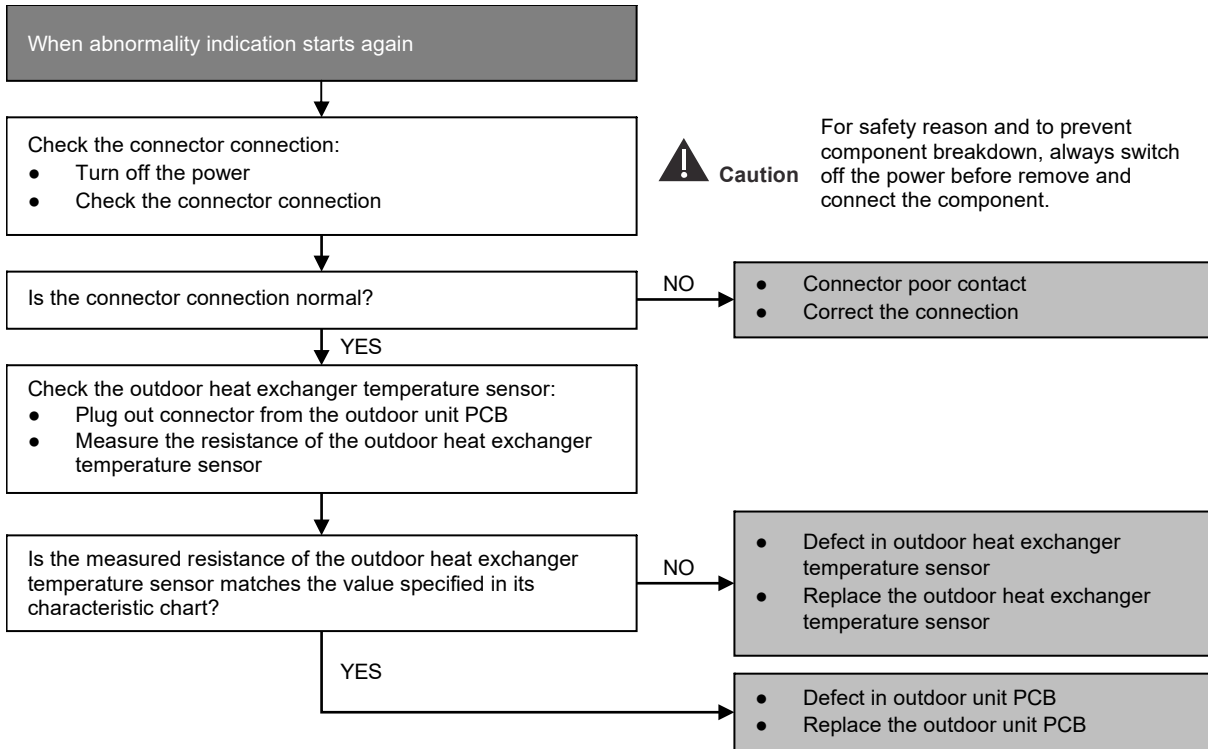

25.2.40 Outdoor Defrost Temperature Sensor Abnormality (H32 / F07 / F43)

Malfunction Decision Conditions

- During startup and operation of cooling and heating, the temperatures detected by the outdoor heat exchanger temperature sensor are used to determine sensor errors.

Malfunction Caused

- Faulty connector connection.
- Faulty sensor.
- Faulty PCB.

Troubleshooting

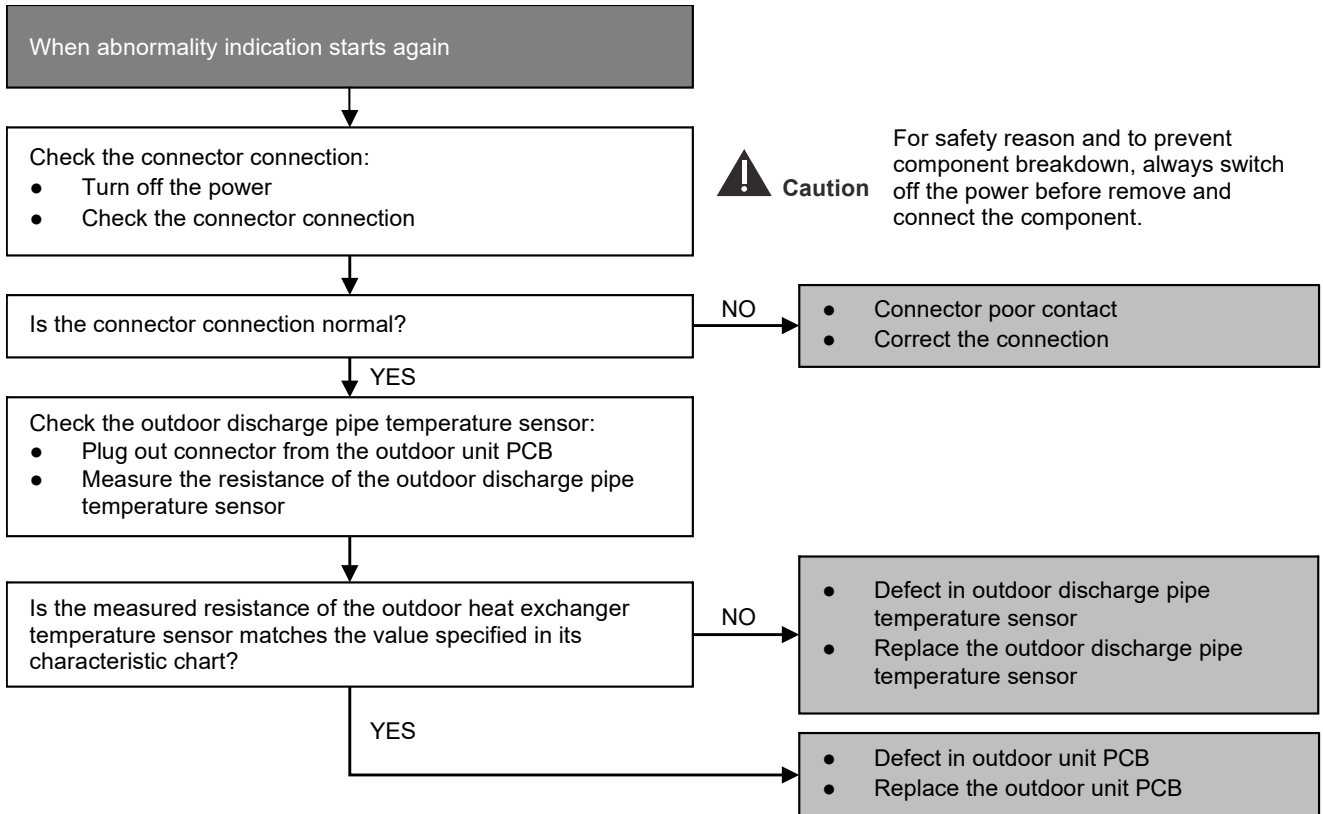

25.2.41 Indoor Water Outlet Temperature Sensor Abnormality (- / - / F45)

Malfunction Decision Conditions:

During startup and operation of cooling and heating, the temperatures detected by the indoor water outlet temperature sensor are used to determine sensor errors.

Malfunction Caused:

1. Faulty connector connection.
2. Faulty sensor.
3. Faulty indoor unit PCB (main).

Abnormality Judgment:

Continue for 5 seconds.

Troubleshooting: Caution

For safety reason and to prevent component breakdown, always switch off the power before remove and connect the component.

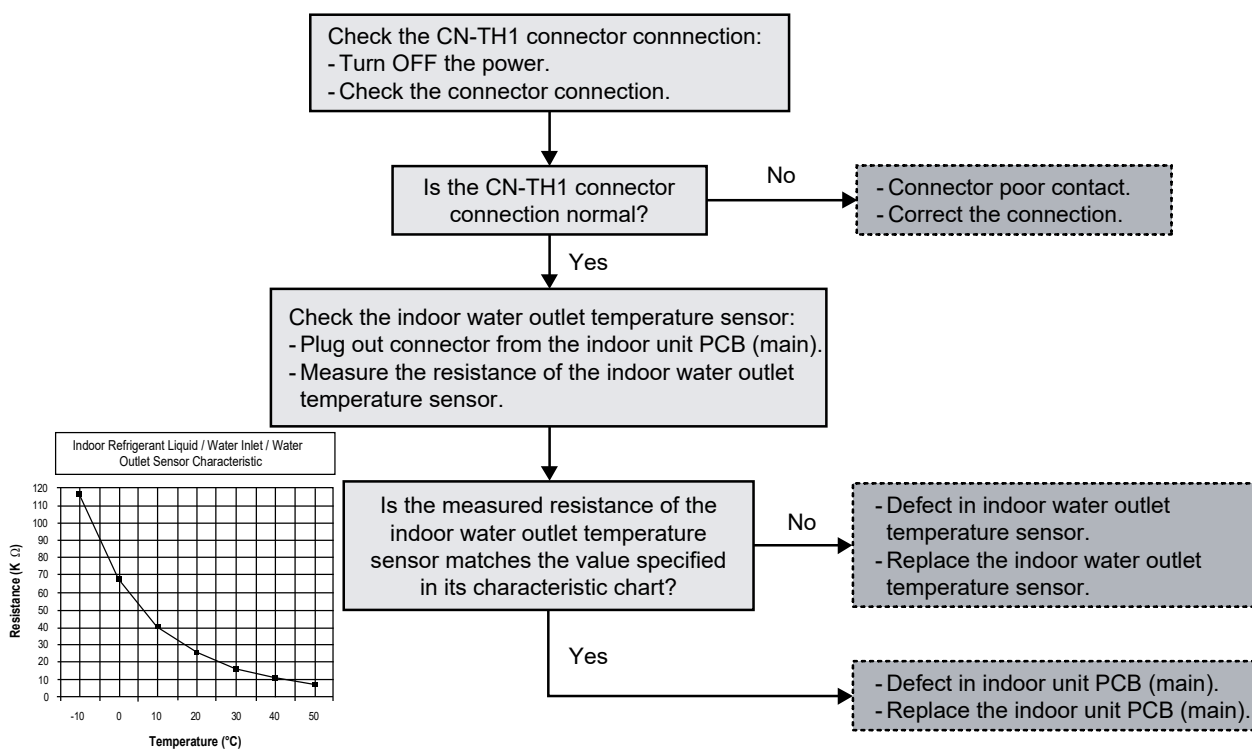

25.2.42 Outdoor Current Transformer Open Circuit (H16 / H03 / F46)

Malfunction Decision Conditions

- An input current, detected by Current Transformer CT, is below threshold value when the compressor is operating at certain frequency value for 3 minutes.

Malfunction Caused

- Lack of gas
- Broken CT (current transformer)
- Broken Outdoor PCB

Troubleshooting

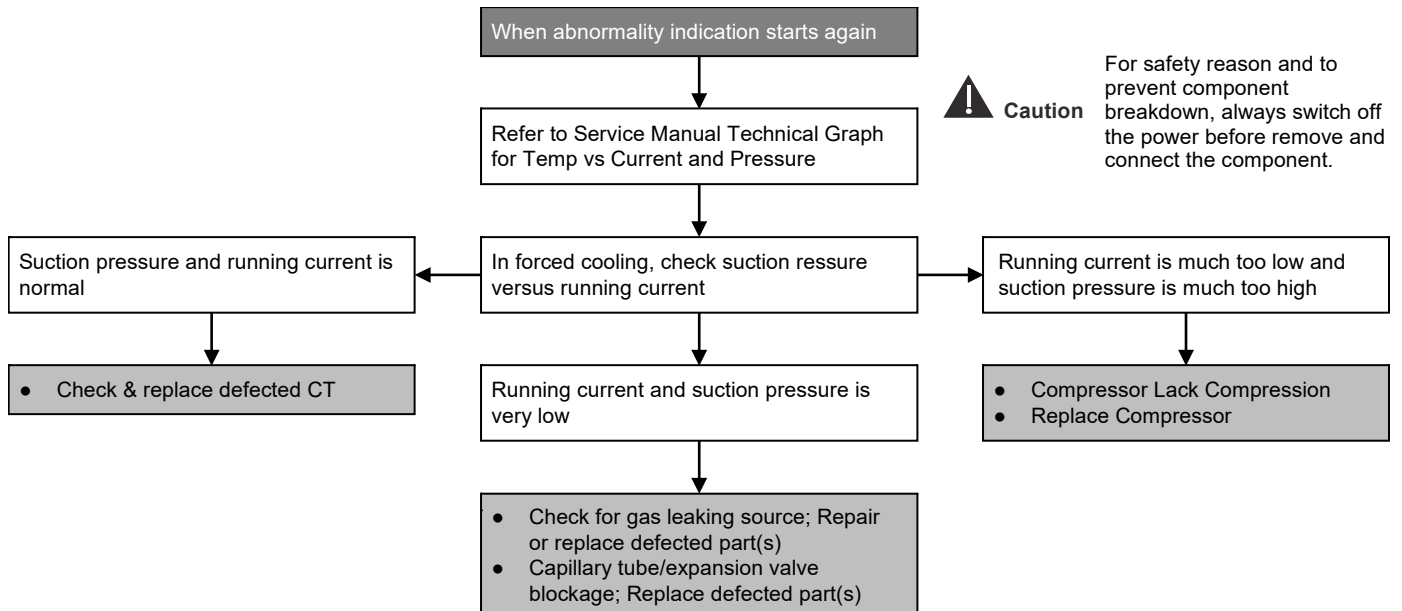

26. Disassembly and Assembly Instructions (WH-ADF0309J3E5CM)

⚠ WARNING

High Voltage are generated in the electrical parts area by the capacitor. Ensure that the capacitor has discharged sufficiently before proceeding with repair work. Failure to heed this caution may result in electric shocks.

26.1 To Remove Front Plate and Top Plate

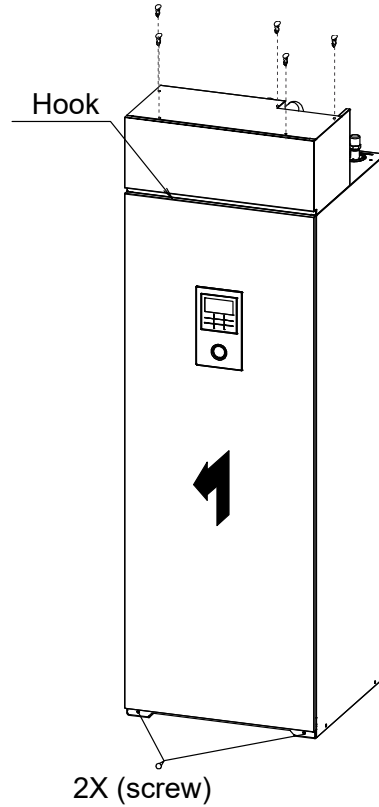

1. Remove 2 screw at the bottom to remove the Front Plate
2. Remove 12 screw at the top to remove the Top Plate

26.2 To Remove Pressure Gauge

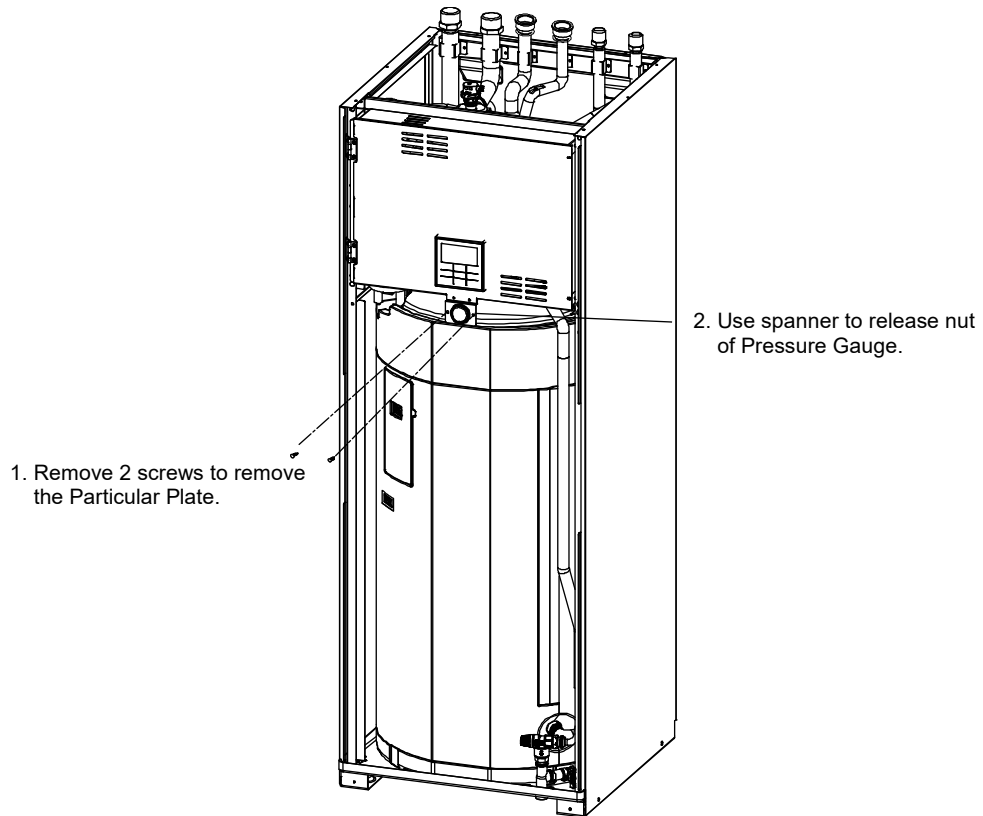

26.3 To Remove Remote Control

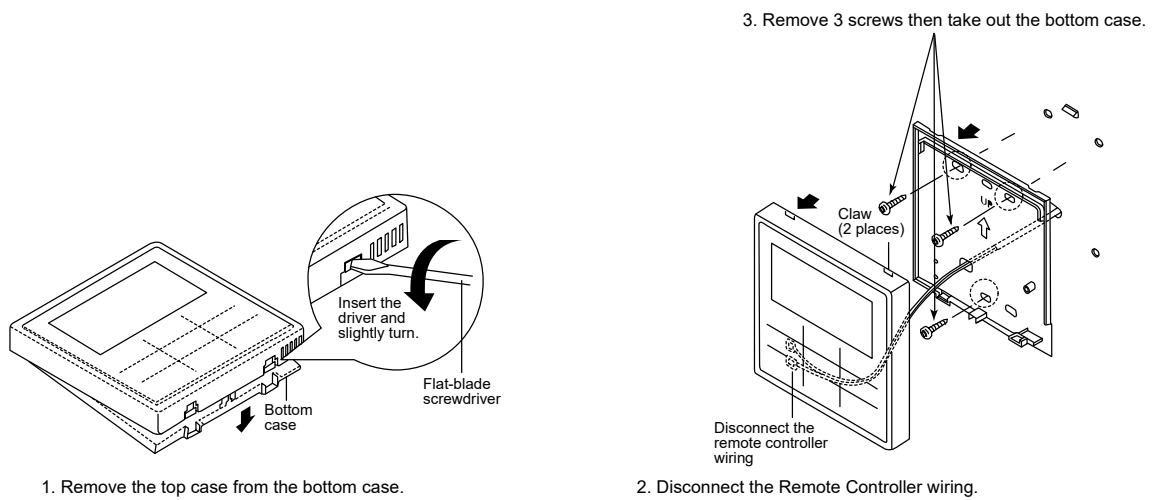

26.4 To Remove RCCB

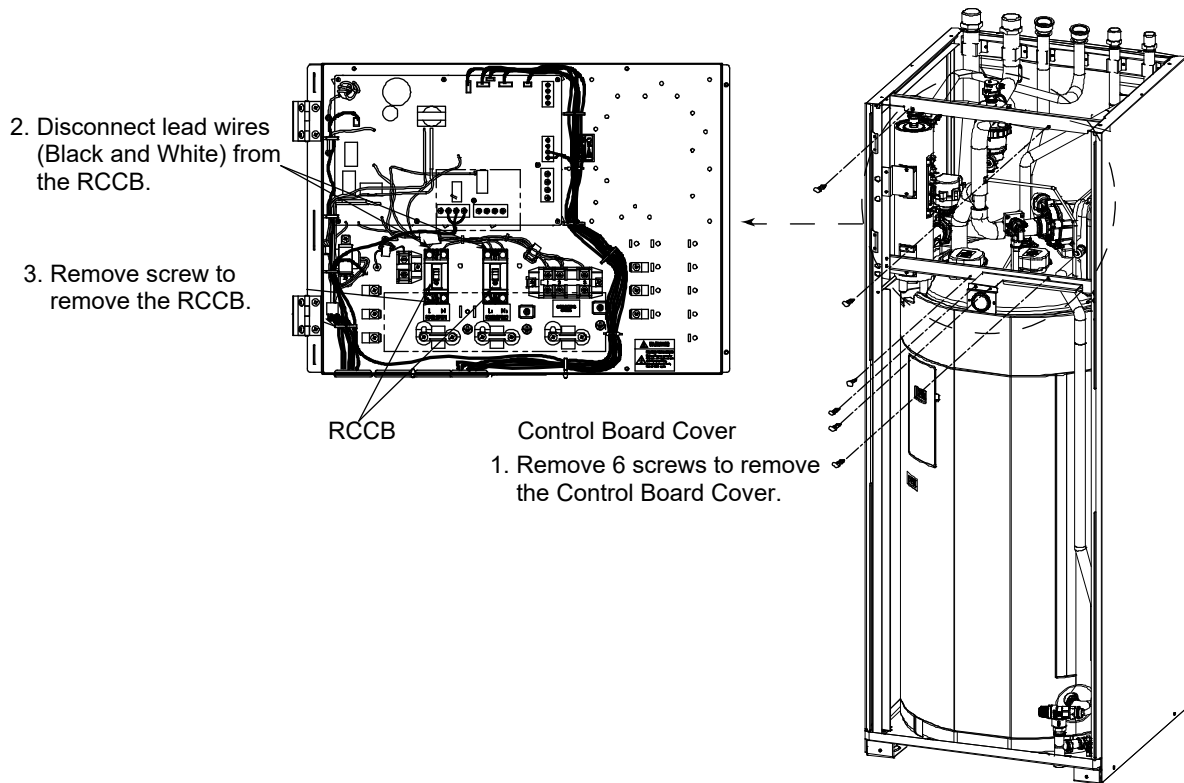

26.5 To Remove Electronic Controller

1. Disconnect all connectors from main PCB, CN-FLWSEN, CN-PUMP1, CN-TH1, CN-TH2, CN-TH3, CN-OLP1, CN1, CN2, CN3, CN4, CN5, CN6. Detach all wires, REMOTE CONTROLLER, 3 WAY VALVE, AC1-L3, AC1-N, G01, DATA, G02, L2, L1, G03, HT1-L3, AC2-L3, AC2-N2, AC2-N3.

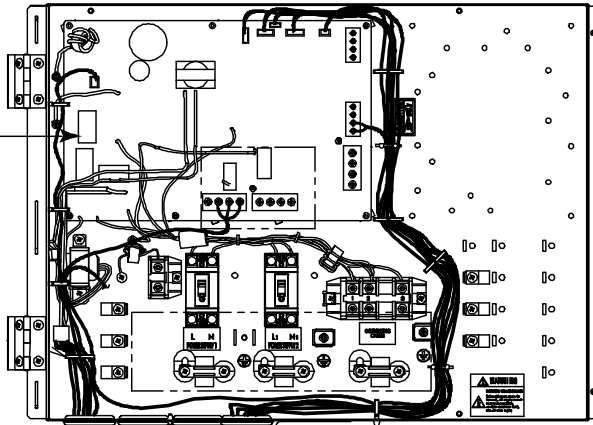

26.6 To Remove Flow Switch and Air Purge Valve

1. Turn the Air Purge Valve anti-clockwise then remove.
2. Detach the flow sensor lead wire.

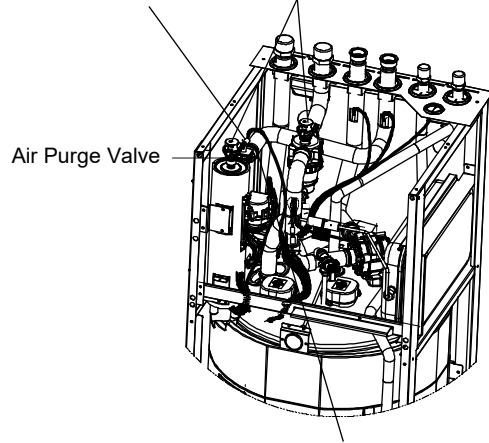

3. Remove 2 retaining rings, then remove the Flow Sensor.

⚠ When reinstall Flow Switch, ensure the arrow on the flow switch is parallel with the pipe shaft and is facing in the direction of flow.

⚠ During reinstall Air Purge Valve.

Make sure plug is fully close in clockwise direction.

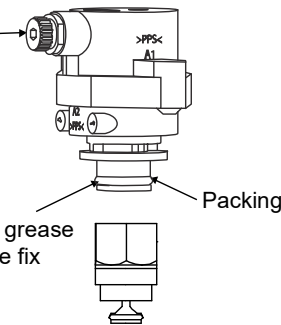

Apply some water based grease on packing surface before fix with shut off valve.

26.7 To Remove Water Pump

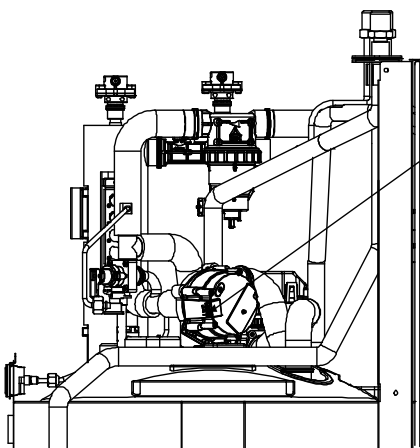

1. Disconnect CN-PUMP1 from electronic controller.

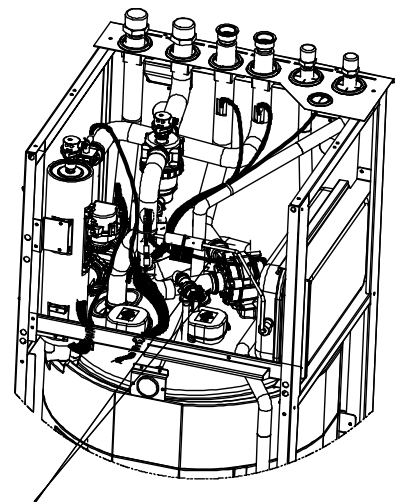

2. Disconnect 2 pipe connection.

26.8 To Remove Bottle Complete

1. Disconnect the connector CN-OLP1 from the Electronic Controller and detached the lead wire HT1-L3 (Red) and AC2-L3 (Black).

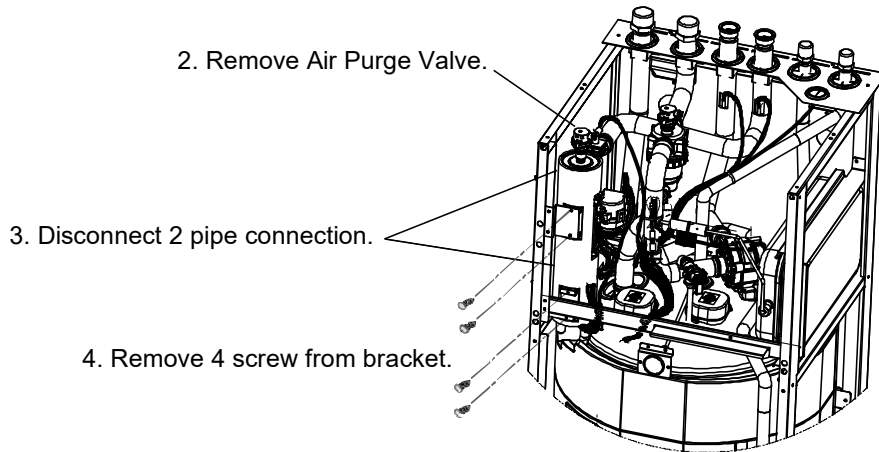

26.9 To Remove Water Filter

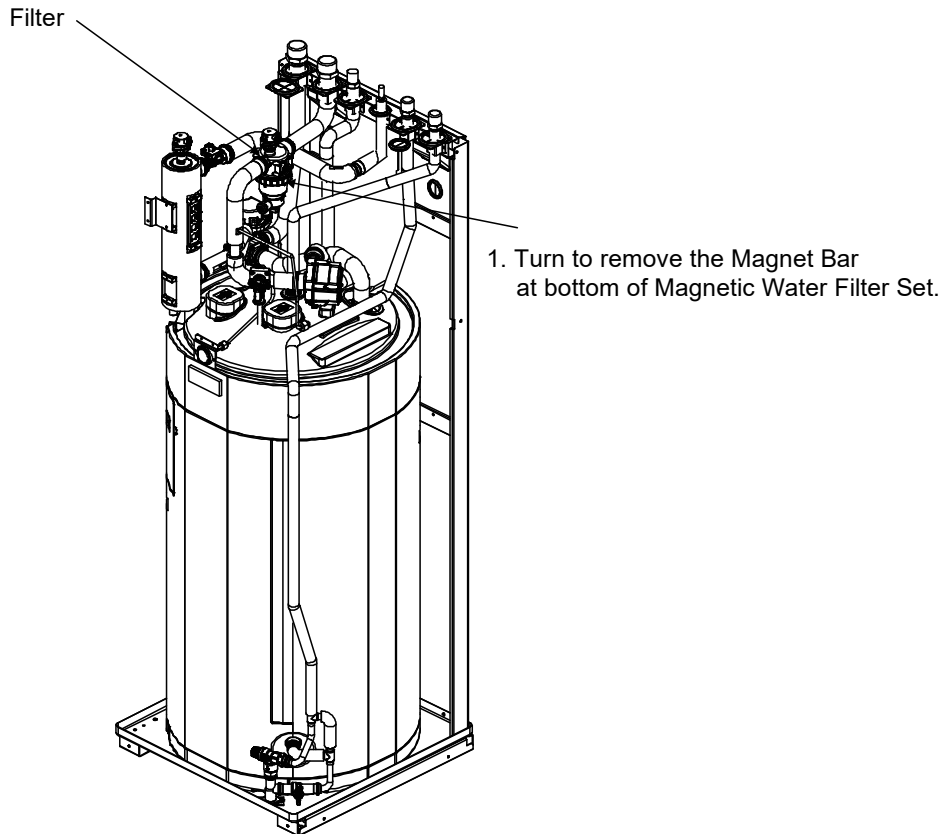

27. Disassembly and Assembly Instructions (S-71WF3E)

WARNING

High Voltage is generated in the electrical parts area by the capacitor. Ensure that the capacitor has discharged sufficiently before proceeding with repair work. Failure to heed this caution may result in electric shocks.

27.1 Indoor Electronic Controller Removal Procedures

1 Remove the 1 screw of the Rain Cover.

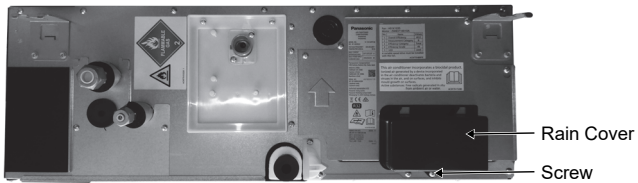

Fig. 1

4 Remove the Electronic Controller from 2 Hook.

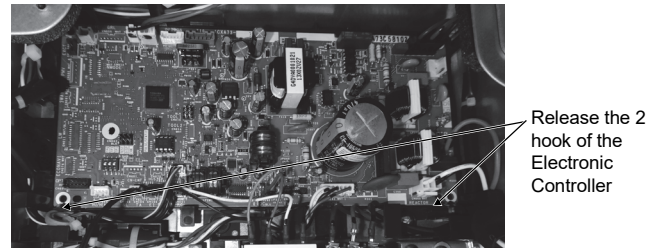

Fig. 4

2 Remove the 5 screws of the Control Board Cover.

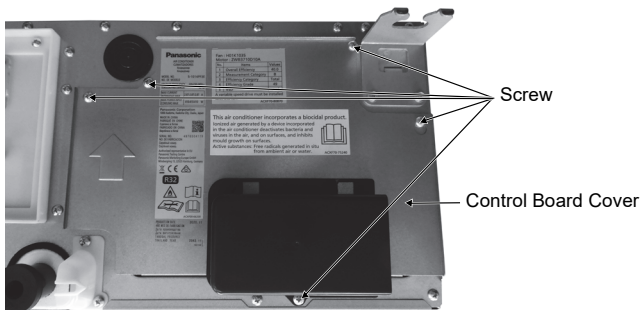

Fig. 2

3 Detach all connectors from Electronic Controller.

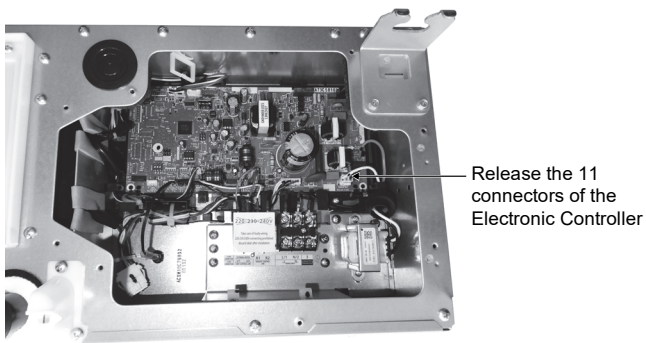

Fig. 3

28. Disassembly and Assembly Instructions (CU-2WZ71YBE5)

⚠ WARNING

High Voltage is generated in the electrical parts area by the capacitor. Ensure that the capacitor has discharged sufficiently before proceeding with repair work. Failure to heed this caution may result in electric shocks.

28.1 Outdoor Unit Removal Procedure

⚠ Caution! When handling electronic controller, be careful of electrostatic discharge.

28.1.1 Removing the Cabinet Top Plate

1. Remove the cabinet top plate (remove the 11 screws).



Fig. 1

28.1.2 Remove the Control Board Cover and Particular Plates

2. Remove the control board cover (remove the 5 screws).

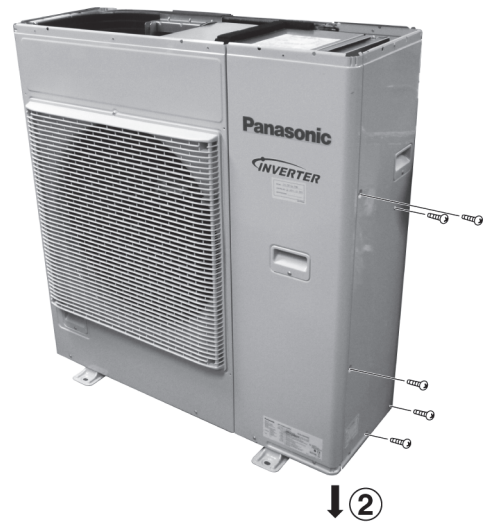

Fig. 2

3. Remove the particular plate (remove the 3 screws).

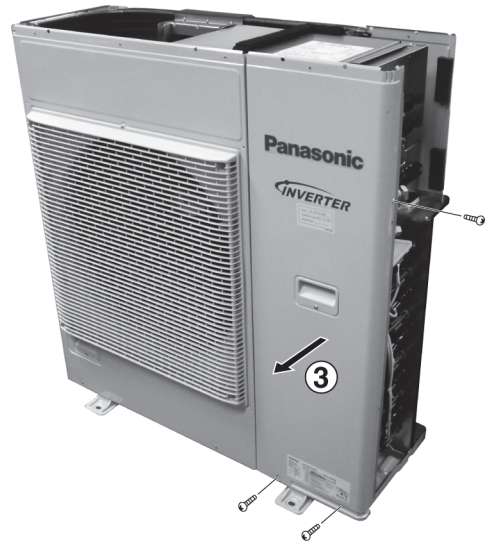

Fig. 3

4. Remove the particular plate (remove the 5 screws).



Fig. 4

28.1.3 Removing the Cabinet Front Plate

5. Remove the cabinet front plate (remove the 7 screws).

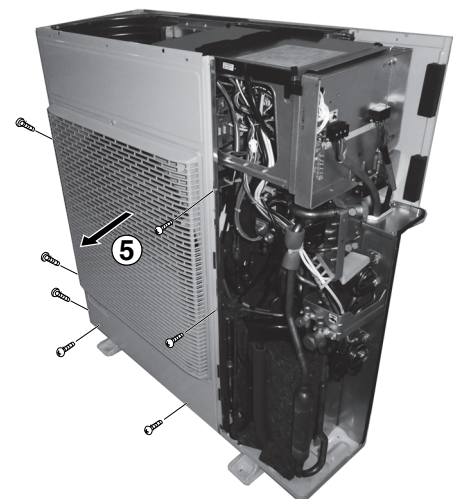

Fig. 5

28.1.4 Removing the Control P.C. Board

6. Remove the cover by release the screw.

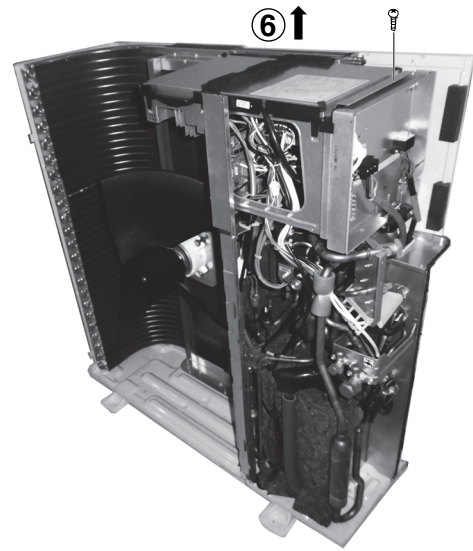

Fig. 6

7. Disconnect the connectors (lead wires of the compressor, sensors, and others).
8. Release the Control P.C. Board tab to remove the Control P.C. Board.

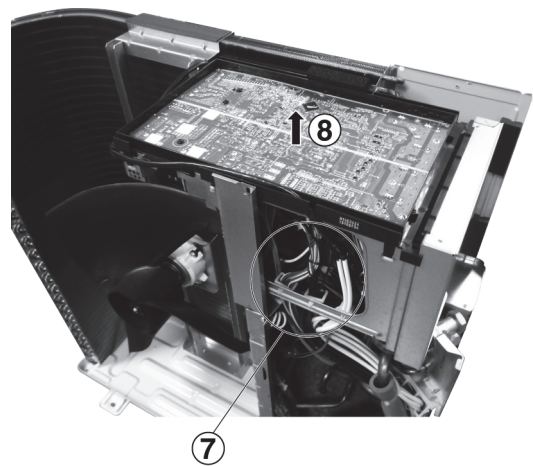

Fig. 7

28.1.5 Removing the Propeller Fan and Fan Motor

9. Remove the propeller fan by removing the nut turning clockwise as its center.
10. Disconnect the fan motor connector from the Control P.C. Board. Loosen the 4 fan motor mounting screws then remove the fan motor.

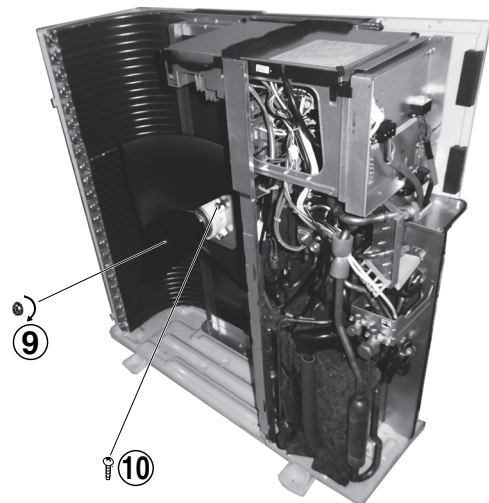

Fig. 8

29. Technical Data (WH-ADF0309J3E5CM)

29.1 Operation Characteristics

Heating Characteristics at Different Outdoor Air Temperature

Condition

Outdoor air temperature : 7°C (DBT), 6°C (WBT)

Indoor water inlet temperature : 30°C

Indoor water outlet temperature : 35°C

Piping length : 7 m

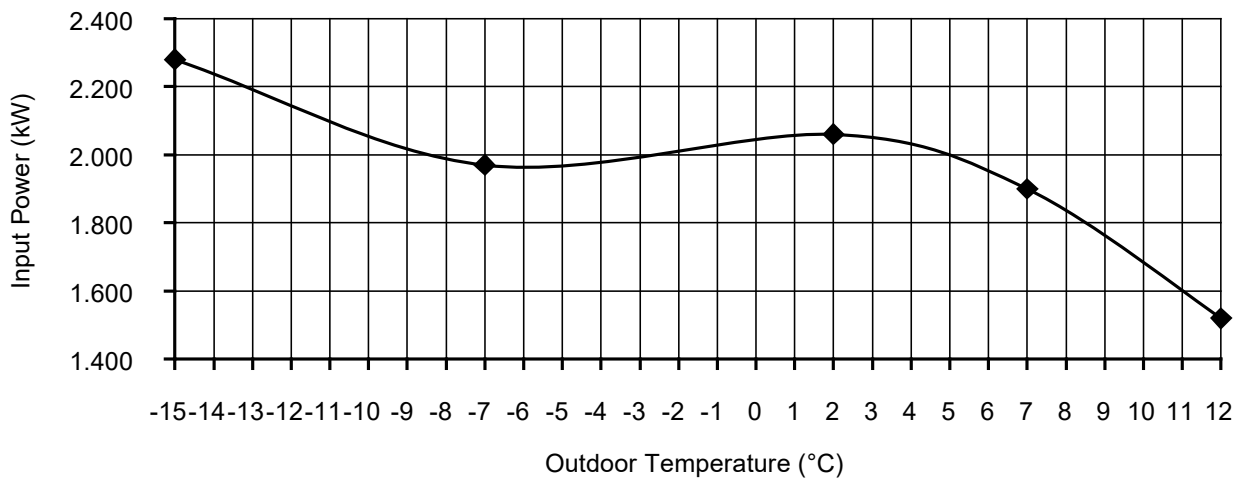
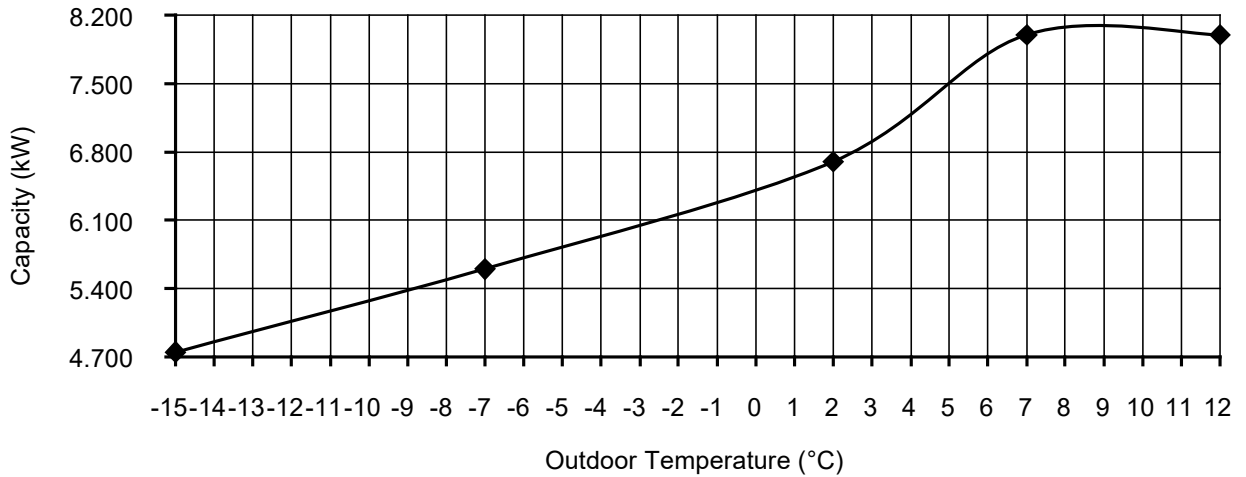

29.2 Heating Capacity Table

Water Out (°C)	25		35		45		55	
	Capacity (W)	Input Power (W)	Capacity (W)	Input Power (W)	Capacity (W)	Input Power (W)	Capacity (W)	Input Power (W)
Outdoor Air (°C)								
-15	4850	2150	4750	2280	4650	2440	4500	3200
-7	5400	1700	5600	1970	5600	2400	5300	2780
2	6500	1770	6700	2060	6600	2450	6000	2890
7	8160	1630	8000	1900	8000	2300	8000	2850
12	8220	1280	8000	1520	8000	2000	8000	2600

30. Technical Data (S-71WF3E)

30.1 Fan Performance

S-71WF3E	Cooling	IVDS AF	Power level dB	dB(A)	Heating	IVDS AF	Power level dB	dB(A)
Hi	960	22.70	57.00	34.00	960	22.70	57.00	34.00
Me	800	19.80			800	19.80		
Lo	640	15.00	49.00	26.00	640	15.00	49.00	26.00

30.2 Indoor Fan Performance

PQ Diagram

External static pressure 150Pa, 90Pa

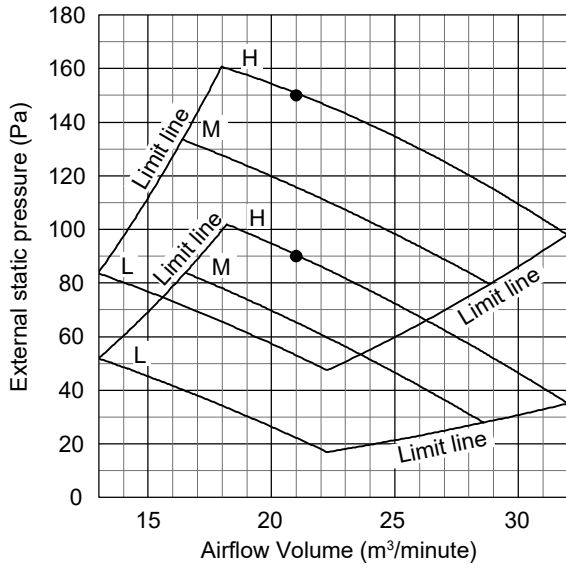

External static pressure 120Pa, 30Pa

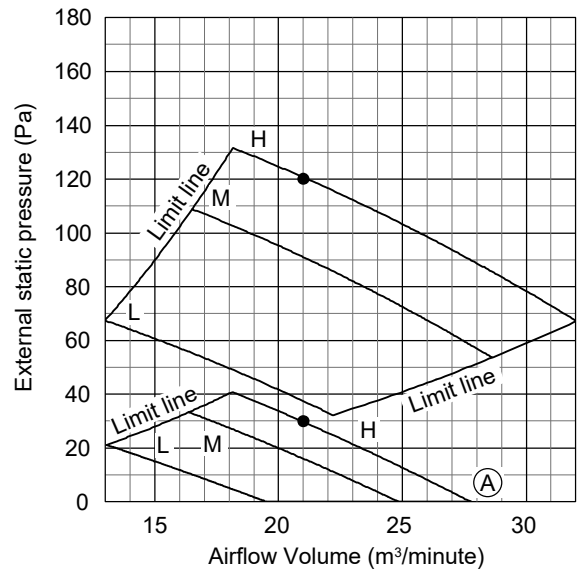

External static pressure 140Pa, 70Pa

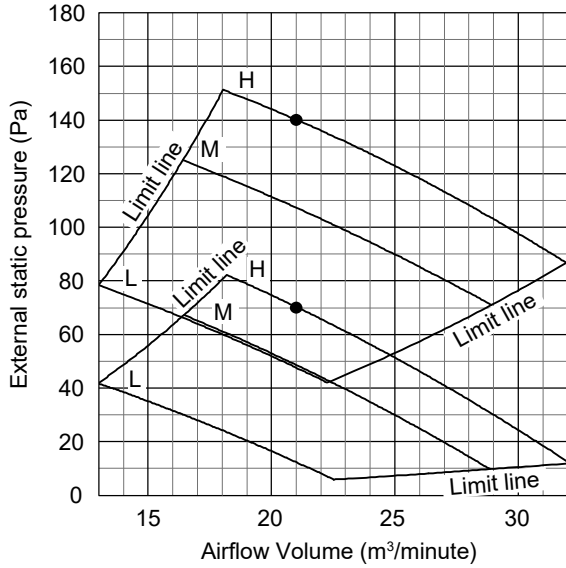

External static pressure 110Pa, 10Pa

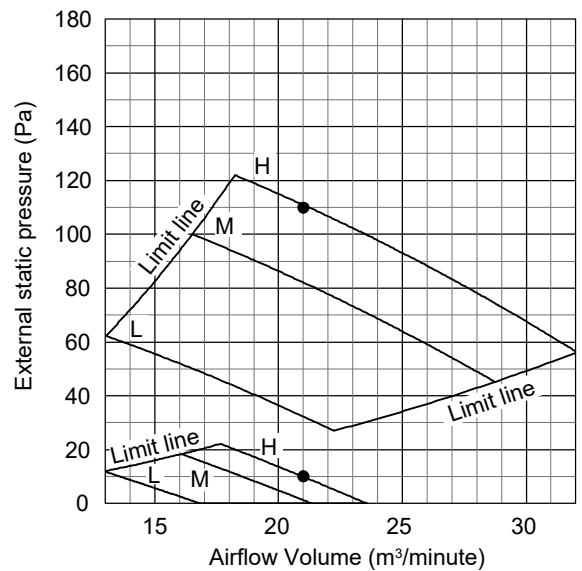

External static pressure 130Pa, 50Pa

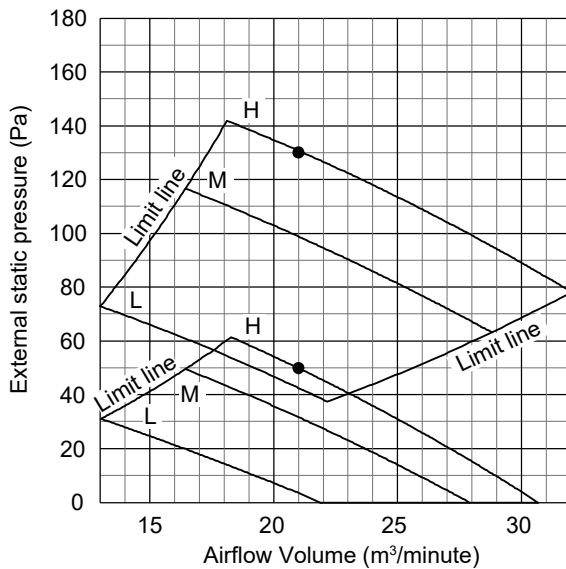

31. Technical Data (CU-2WZ71YBE5)

Technical data provided are based on the air conditioner running under free frequency.

31.1 Air Cool Mode Performance Data

Unit setting: Standard piping length, Hi Fan, Cool mode at 16°C

Voltage: 230V, 50Hz

Outdoor Air Temp. °C dB	Indoor Air Temp. °C											
	27/16		27/17.5		27/18		27/19		27/22		27/24	
	Q	W	Q	W	Q	W	Q	W	Q	W	Q	W
22	7.86	2.27	8.26	2.28	8.54	2.28	8.67	2.28	9.34	2.32	10.33	2.37
25	7.71	2.44	8.63	2.53	9.25	2.59	9.56	2.62	9.88	2.65	10.36	2.70
29	7.51	2.67	8.09	2.82	8.48	2.92	8.67	2.97	9.36	3.04	10.38	3.15
32	7.37	2.93	7.90	3.02	8.26	3.09	8.44	3.12	9.10	3.14	10.10	3.17
35	7.22	3.18	7.61	3.23	7.73	3.22	8.10	3.28	8.79	3.24	9.82	3.18
40	6.21	2.71	6.43	2.72	6.58	2.73	6.66	2.74	7.19	2.72	7.99	2.70
43	5.74	2.60	5.94	2.63	6.07	2.65	6.14	2.66	6.57	2.63	7.21	2.60
46	5.26	2.49	5.37	2.50	5.44	2.51	5.47	2.51	5.85	2.51	6.42	2.51

31.2 Air Heat Mode Performance Data

Unit setting: Standard piping length, Hi Fan, Heat mode at 30°C

Voltage: 230V, 50Hz

Indoor Air Temp. °C	Outdoor Air Temp. °C											
	16/15		15/14		10/9		7/6		6/5		2/1	
	Q	W	Q	W	Q	W	Q	W	Q	W	Q	W
16	9.82	2.13	9.90	2.24	10.31	2.83	10.56	3.18	10.31	3.15	9.31	3.05
18	9.62	2.16	9.71	2.29	10.14	2.91	10.39	3.29	10.14	3.26	9.15	3.13
20	9.43	2.20	9.51	2.33	9.94	3.00	10.20	3.40	9.96	3.36	8.98	3.22
21	9.29	2.21	9.38	2.35	9.84	3.04	10.11	3.46	9.87	3.42	8.90	3.27
22	9.16	2.23	9.25	2.37	9.74	3.08	10.04	3.51	9.80	3.47	8.83	3.31
24	8.89	2.26	9.00	2.41	9.53	3.16	9.85	3.62	9.62	3.57	8.69	3.40

Indoor Air Temp. °C	Outdoor Air Temp. °C											
	0/-1		-5/-6		-7/-8		-10/-11		-15/-			
	Q	W	Q	W	Q	W	Q	W	Q	W		
16	8.81	2.99	8.08	2.89	7.79	2.85	7.10	2.54	5.96	2.41		
18	8.65	3.07	7.77	2.91	7.41	2.85	6.56	2.58	5.15	2.45		
20	8.49	3.15	7.45	2.94	7.04	2.86	6.03	2.58	4.34	2.47		
21	8.42	3.19	7.42	2.98	7.02	2.90	6.00	2.61	4.30	2.48		
22	8.35	3.23	7.39	3.03	7.01	2.95	5.98	2.62	4.26	2.50		
24	8.22	3.32	7.33	3.12	6.97	3.04	5.93	2.69	4.18	2.55		

32. Exploded View and Replacement Parts List

32.1 WH-ADF0309J3E5CM

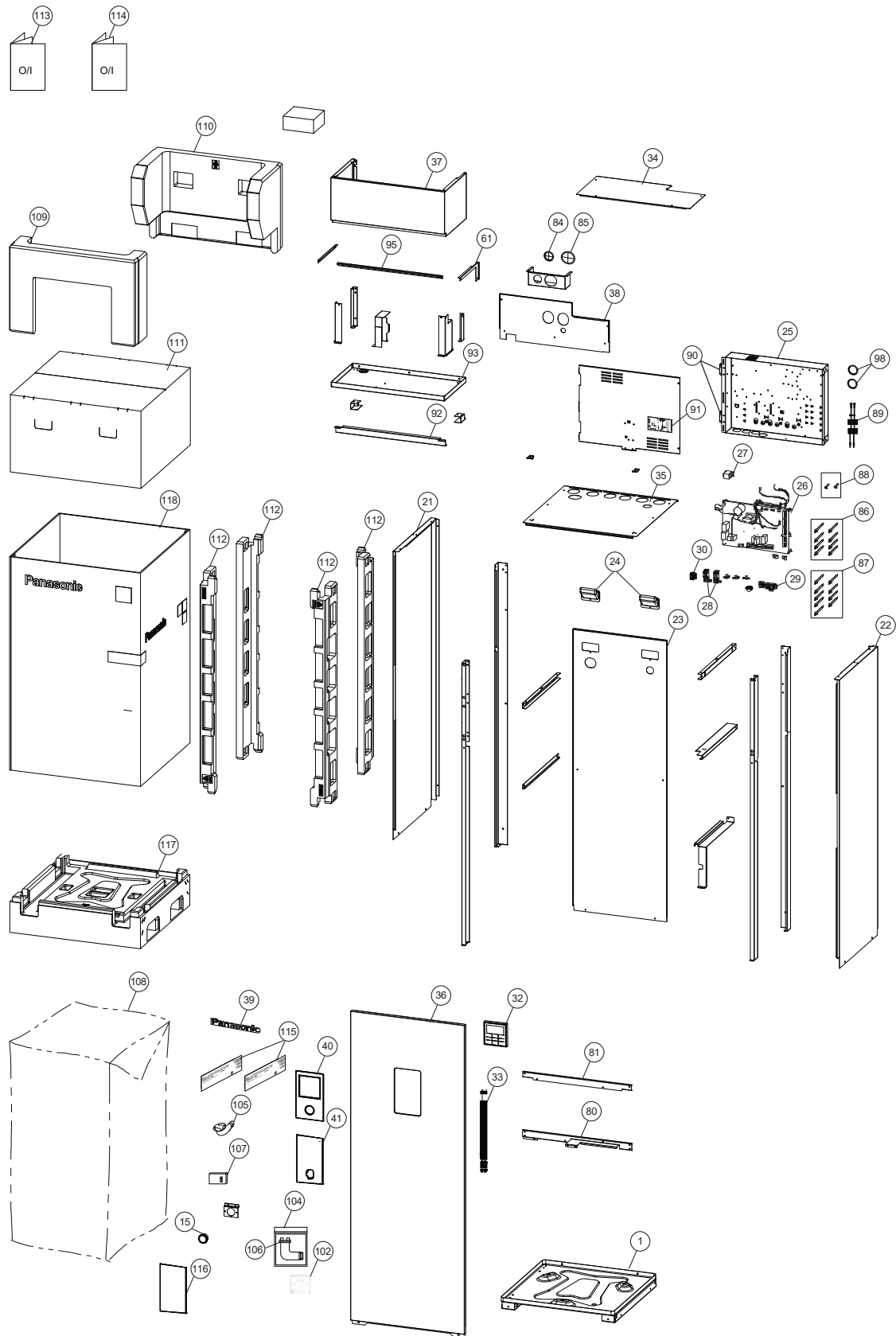

Note:

The above exploded view is for the purpose of parts disassembly and replacement. The non-numbered parts are not kept as standard service parts.

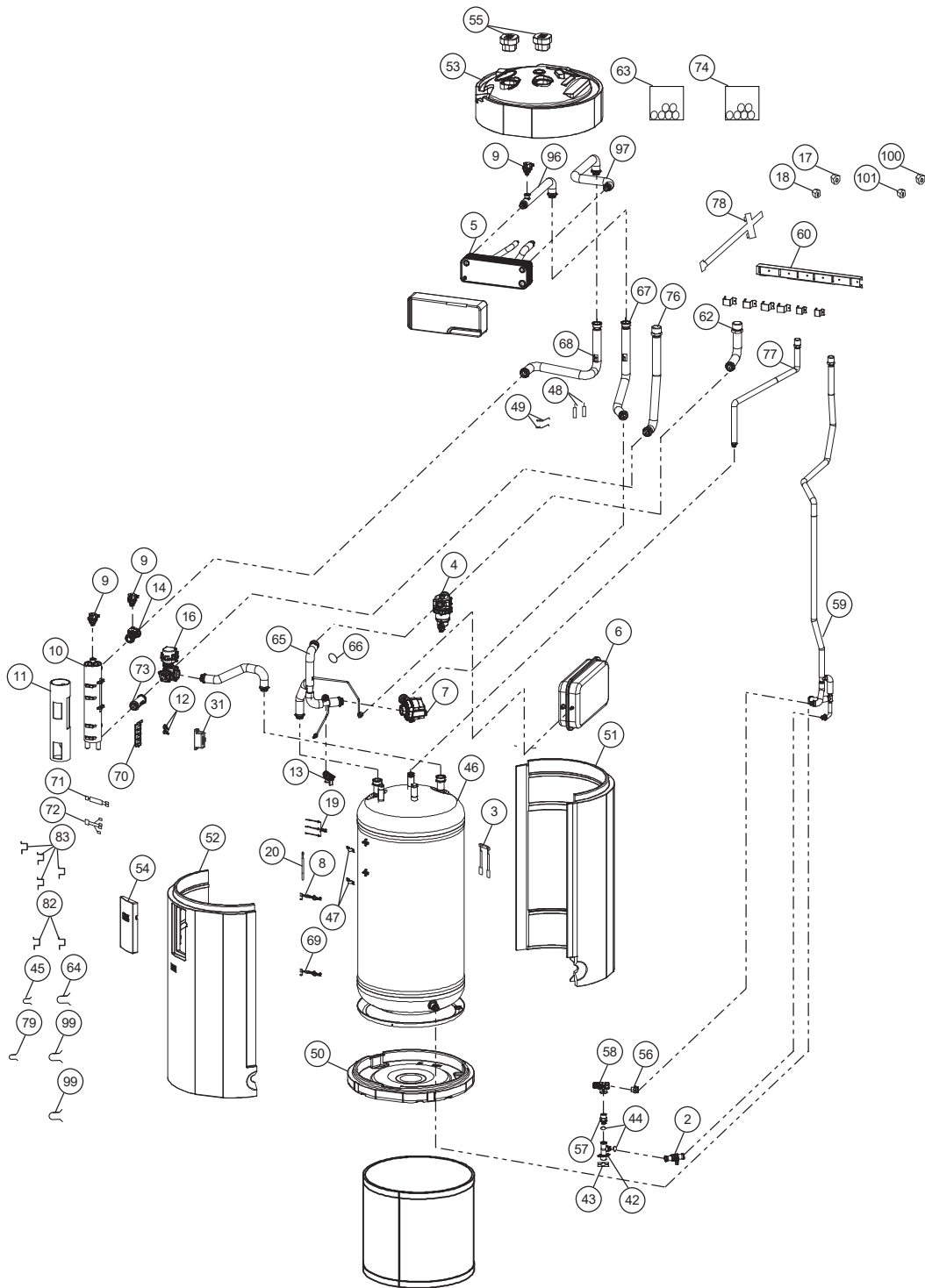

Note:

The above exploded view is for the purpose of parts disassembly and replacement.
 The non-numbered parts are not kept as standard service parts.

SAFETY	REF. NO.	DESCRIPTION & NAME	QTY.	WH-ADF0309J3E5CM	REMARK
	1	CHASSIS - COMPLETE	1	ACXD50C03830	
	2	VALVE - COMPLETE	1	ACXB65C00111	
	3	SENSOR - COMPLETE (CN-TH2)	1	ACXA50C16520	
	4	FILTER COMPLETE	1	ACXB51C00110	
	5	HOT WATER COIL - COMPLETE	1	ACXB90C01561	
	6	RECEIVER	1	CWB141039	
⚠	7	ELECTRIC LIQUID PUMP (VOLUTE PUMP)	1	ACXB53-00390	
⚠	8	LEAD WIRE - COMPLETE (CN-PUMP1)	1	ACXA60C73630	
	9	AIR PURGE VALVE	3	ACXB62-00130	
⚠	10	HEATER ASSY	1	ACXA34K00460	
	11	SOUND PROOF MATERIAL	1	ACXG30-08750	
⚠	12	THERMOSTAT	2	CWA151074	
	13	PRESSURE RELIEF VALVE	1	ACXB62-00100	
⚠	14	FLOW SENSOR	1	ACXB62-00931	
	15	PRESSURE GAUGE	1	ACXB07-00101	
⚠	16	3 WAY VALVE (CN1)	1	ACXB62-00091	
	17	FLARE NUT (5/8)	1	CWT251079	
	18	FLARE NUT (1/4)	1	CWT251063	
⚠	19	SENSOR - COMPLETE (CN-TH1)	1	ACXA50C18190	
⚠	20	SENSOR - COMPLETE (CN-TH3)	1	ACXA50C18200	
	21	CABINET SIDE PLATE (L)	1	ACXE04-12760A	
	22	CABINET SIDE PLATE (R)	1	ACXE04-12770A	
	23	CABINET REAR PLATE	1	ACXE02-03020	
	24	HANDLE	2	ACXE16-00300	
	25	CONTROL BOARD	1	ACXH10-08530	
⚠	26	ELECTRONIC CONTROLLER - MAIN	1	ACXA73C80820	
⚠	27	REACTOR	1	G0C103Z00003	
⚠	28	CIRCUIT BREAKER	2	K5KYAY00003	
⚠	29	TERMINAL BOARD ASS'Y (1, 2, 3)	1	CWA28K1217	
⚠	30	TERMINAL BOARD ASS'Y (A, B)	1	CWA28K1200	
	31	TERMINAL COVER	1	CWH171051	
⚠	32	REMOTE CONTROL SWITCH - COMPLETE	1	ACXA75C22411	
⚠	33	LEAD WIRE - COMPLETE (CONTROL PANEL)	1	ACXA60C04350	
	34	CABINET TOP PLATE	1	ACXE03-04670	
	35	CABINET TOP PLATE	1	ACXE03-04660	
	36	CABINET FRONT PLATE	1	ACXE06-04660A	
	37	CABINET FRONT PLATE	1	ACXE06-04970A	
	38	CABINET REAR PLATE	1	ACXE02-03270	
	39	PANASONIC BADGE	1	CWE375343	
	40	DECORATION BASE ASSY	1	ACXE35K02660	
	41	ACCESSORY - CO. (DECORATION BASE)	1	CWH82C2174	
	42	TUBE CONNECTER	1	ACXT29-02200	

SAFETY	REF. NO.	DESCRIPTION & NAME	QTY.	WH-ADF0309J3E5CM	REMARK
	43	PACKING	2	ACXB81-06531	
	44	PACKING	1	ACXB81-00010	
	45	RETAINING RING	1	CWH581007	
	46	TANK COMPLETE	1	ACXB56C00952	
	47	PARTICULAR PIECE	2	CWD934023	
	48	STRAIGHT TUBE	2	CWT102044	
	49	PLATE SPRING	2	CWH711010	
	50	FOAMED POLYSTYRENE	1	ACXG07-06740	
	51	FOAMED POLYSTYRENE	1	ACXG07-06750	
	52	FOAMED POLYSTYRENE	1	ACXG07-06760	
	53	FOAMED POLYSTYRENE	1	ACXG07-06770	
	54	FOAMED POLYSTYRENE	1	ACXG07-06780	
	55	FOAMED POLYSTYRENE	2	CWG071761	
	56	SOCKET	1	ACXT27-00090	
	57	SOCKET	1	ACXT27-00020	
	58	SAFETY RELIEF VALVE	1	ACXB62-00111	
	59	TUBE ASSY - COMPLETE	1	ACXT00C32851	
	60	CONNECTING BAR	1	ACXE26-02770	
	61	PARTICULAR PLATE	1	ACXD90-26060	
	62	TUBE ASSY - COMPLETE	1	ACXT00C32681	
	63	PACKING	1	CWB811224	
	64	RETAINING RING	1	ACXH58-00370	
	65	TUBE ASSY - COMPLETE	1	ACXT00C32692	
	66	PACKING	1	CWB811179	
	67	TUBE ASSY - COMPLETE	1	ACXT00C39030	
	68	TUBE ASSY - COMPLETE	1	ACXT00C39040	
	69	LEAD WIRE - COMPLETE (CN-FLWSEN)	1	ACXA60C82910	
	70	U-SHAPED PIECE	1	CWD721031	
	71	LEAD WIRE - COMPLETE (CN-OLP1)	1	ACXA60C62220	
	72	LEAD WIRE - COMPLETE (OLP, HEATER)	1	ACXA60C82920	
	73	TUBE ASSY - COMPLETE	1	ACXT00C32731	
	74	PACKING	2	ACXB81-06910	
	75	TUBE ASSY - COMPLETE	1	ACXT00C32740	
	76	TUBE ASSY - COMPLETE	1	ACXT00C32750	
	77	TUBE ASSY - COMPLETE	1	ACXT00C32760	
	78	TUBE ASSY	1	ACXT00-06230	
	79	RETAINING RING	1	CWH581038	
	80	CONNECTING BAR	1	ACXE26-02521	
	81	CONNECTING BAR	1	ACXE26-02530	
	82	PARTICULAR PIECE	2	ACXD93-01870	
	83	PARTICULAR PIECE	4	ACXD93-01880	
	84	PACKING	1	ACXB81-00030	
	85	PACKING	1	ACXB81-00040	

SAFETY	REF. NO.	DESCRIPTION & NAME	QTY.	WH-ADF0309J3E5CM	REMARK
	86	SPACER	8	CWH54294	
	87	SPACER	9	CWH54295	
	88	SELF TAPPING SCREW	2	XTN4+25CFJ	
	89	LEAD WIRE - COMPLETE (L, N)	1	ACXA60C90150	
	90	HINGE	2	CWH611006	
	91	WIRING DIAGRAM	1	ACXF29-00770	
	92	BRACKET - UNIT MOUNTING	1	ACXD57-03030	
	93	BASE PAN	1	ACXD52-06061	
	94	BAG - COMPLETE (L-TUBE)	1	CWG87C900	
	95	CONNECTING BAR	1	ACXE26-02780	
	96	TUBE ASSY - COMPLETE	1	ACXT00C39051	
	97	TUBE ASSY - COMPLETE	1	ACXT00C39061	
	98	PACKING	2	ACXB81-06900	
	99	RETAINING RING	2	CWH581012	
	100	FLARE NUT (1/2)	1	CWT251032	
	101	FLARE NUT (1/4)	1	CWT251063	
	102	INDICATION LABEL	1	ACXF71-03400	
	103	ACCESSORY - COMPLETE	1	ACXH82C04160	
	104	ACCESSORY - COMPLETE (L-TUBE)	1	ACXH82C21740	
	105	L-TUBE	1	CWH5850080	
	106	PACKING	1	CWB81012	
	107	NETWORK ADAPTER	1	ACXG50C03490	
	108	BAG	1	ACXG86-06130	
	109	SHOCK ABSORBER	1	ACXG70-14150	
	110	SHOCK ABSORBER	1	ACXG70-14160	
	111	CORRUGATED CARDBOARD	1	ACXG57-10710	
	112	SHOCK ABSORBER	4	CWG713134	
	113	OPERATING INSTRUCTION	1	ACXF55-32360	
	114	OPERATING INSTRUCTION	1	ACXF55-32372	
	115	MODEL LABEL	2	ACXF85-83781	
	116	BAG	1	ACXG86-05820	
	117	BASE BOARD - COMPLETE	1	ACXG62C02121	
	118	C.C. CASE	1	ACXG50-59690	

Note:

- All parts are supplied from PAVCCZ, Czech (Vendor Code: 00029407).
- "O" marked parts are recommended to be kept in stock.

32.2 S-71WF3E

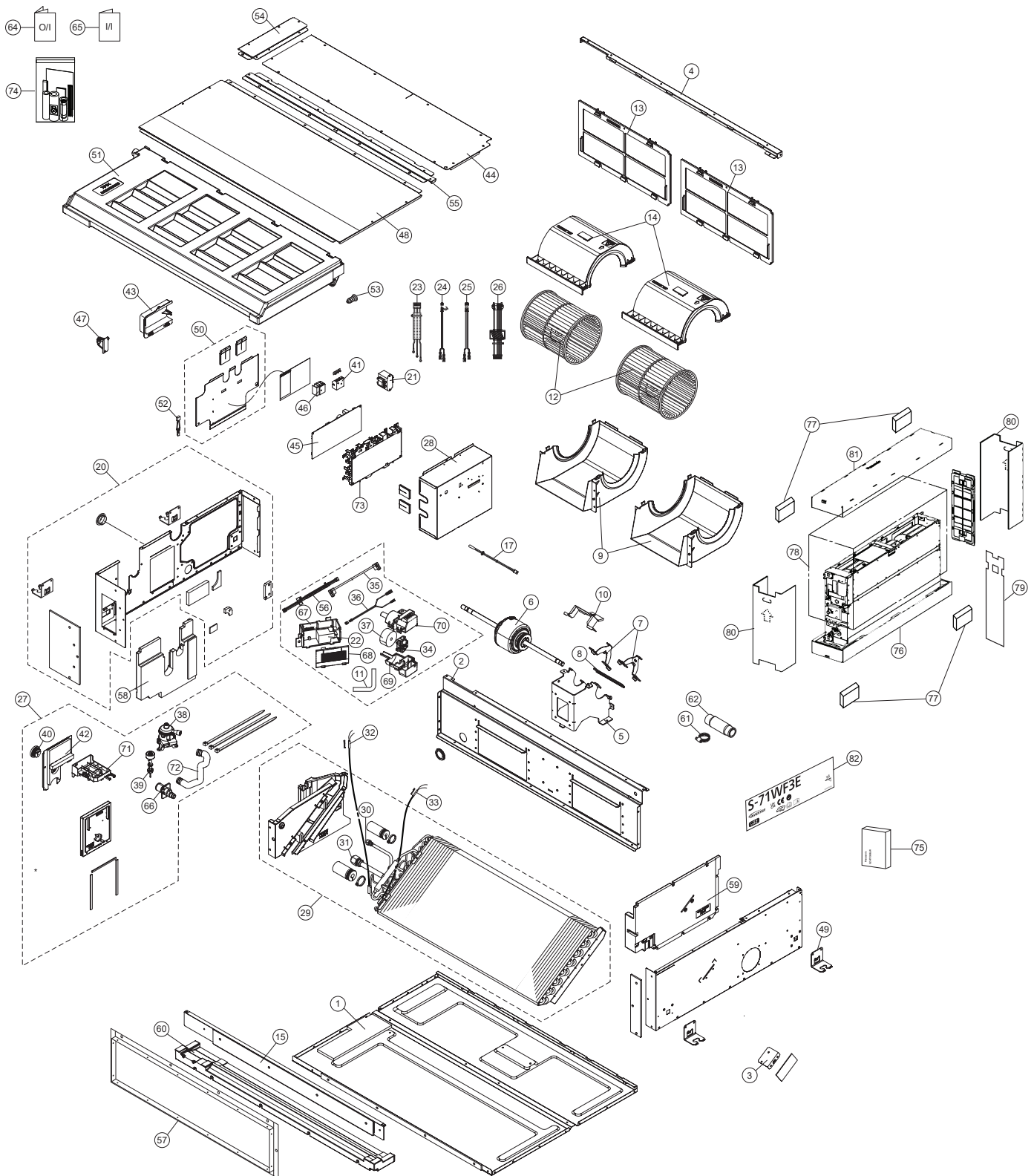

Note:
The above exploded view is for the purpose of parts disassembly and replacement.
The non-numbered parts are not kept as standard service parts.

SAFETY	REF. NO.	PART NAME & DESCRIPTION	QTY.	S-71WF3E	REMARK
	1	CABINET TOP PLATE - COMPLETE	1	ACXE03C01870	
	2	BULKHEAD	1	ACXD53-01781	
	3	PARTICULAR PLATE	1	ACXD90-23740	
	4	PARTICULAR PLATE	1	ACXD90-23700	
	5	FAN MOTOR BRACKET	1	ACXD54-04010A	
⚠	6	DC MOTORS (BRUSHLESS GENERAL USE)	1	L6CBYYL0331	
	7	FAN MOTOR BRACKET	2	ACXD54-04020	
	8	FAN MOTOR BRACKET	1	ACXD54-04110	
	9	AIR GUIDER B.W.	2	ACXD32-01260-B	
	10	FAN MOTOR BRACKET	1	ACXD54-04321	
	11	NOZZLE	1	ACXH43-00470	
	12	BLOWER WHEEL ASSY	2	CWH01K1035A	
	13	AIR FILTER	2	ACXD00-02681	
	14	AIR GUIDER B.W. COMPLETE	2	ACXD32C00100	
	15	PARTICULAR PLATE - COMPLETE	1	ACXD90C03920	
⚠	17	SENSOR - COMPLETE	1	ACXA50C15630	
	20	CABINET SIDE PLATE - COMPLETE	1	ACXE04C06580	
⚠	21	FIXED INDUCTORS	1	G0C153K00011	
⚠	22	HIGH VOLTAGE POWER SUPPLIES (VO 600V-)	1	N0GE1E000011	
⚠	23	LEAD WIRE - COMPLETE	1	ACXA60C79150	
⚠	24	LEAD WIRE - COMPLETE	1	ACXA60C79090	
⚠	25	LEAD WIRE - COMPLETE	1	ACXA60C79100	
⚠	26	LEAD WIRE - COMPLETE	1	ACXA60C79110	
	27	PUMP BRACKET COMPLETE	1	ACXD58C00012	
	28	CONTROL BOARD ASSY	1	ACXH10K02320	
	29	FIN & TUBE EVAPORATER - COMPLETE	1	ACXB30C35640	
	30	UNION NUT - LIQUID	1	ACXT25-00150	
	31	UNION NUT - GAS	1	ACXT25-00170	
⚠	32	SENSOR - COMPLETE	1	ACXA50C15611	
⚠	33	SENSOR - COMPLETE	1	ACXA50C15620	
⚠	34	GENERATOR COMPLETE	1	ACXH94C01040	
⚠	35	LEAD WIRE - COMPLETE	1	ACXA60C79120	
⚠	36	LEAD WIRE - COMPLETE	1	ACXA60C79140	
	37	SOUND PROOF MATERIAL	1	ACXG30-00900	
⚠	38	PUMP	1	ACXB53-00711	
⚠	39	OVER LOAD PROTECTOR	1	ACXA12-01031	
	40	PLUG	1	ACXB82-00710	
⚠	41	TERMINAL BOARD ASSY	1	ACXA28K02560	
	42	PARTICULAR PLATE - COMPLETE	1	ACXD90C03940	
	43	RAIN COVER	1	ACXH81-01550	

SAFETY	REF. NO.	PART NAME & DESCRIPTION	QTY.	S-71WF3E	REMARK
	44	CABINET BOTTOM PLATE	1	ACXE05-01620	
⚠	45	ELECTRONIC CONTROLLER - COMPLETE	1	ACXA73C80480	
⚠	46	TERMINAL BOARD	1	ACXA28-00140	
	47	RAIN COVER	1	ACXH81-01510	
	48	CABINET BOTTOM PLATE - COMPLETE	1	ACXE05C00350	
	49	CABINET SIDE PLATE - COMPLETE	1	ACXE04C06590	
	50	CONTROL BOARD COVER - COMPLETE	1	ACXH13C05400	
	51	DRAIN PAN - COMPLETE	1	ACXH40C01471	
⚠	52	LEAD WIRE - COMPLETE	1	ACXA60C79400	
	53	PLUG	1	CWB821037	
	54	CABINET BOTTOM PLATE	1	ACXE05-01600	
	55	CABINET BOTTOM PLATE	1	ACXE05-01550	
⚠	56	LEAD WIRE - COMPLETE	1	ACXA60C79130	
	57	L-SHAPED PLATE - COMPLETE	1	CWD60C1021	
	58	FOAMED STYRENE COMPLETE	1	ACXG07C00760	
	59	FOAMED STYRENE COMPLETE	1	ACXG07C00750	
	60	FOAMED STYRENE COMPLETE	1	ACXG07C00781	
	61	WIRE SPRING	1	CWH722020	
	62	FLEXIBLE PIPE	1	CWH851211	
	64	OPERATING INSTRUCTION	1	ACXF55-32380	
	65	INSTALLATION INSTRUCTION	1	ACXF60-45201	
	66	DRAIN NOZZLE	1	ACXH41-00600	
	67	PARTICULAR PIECE	1	ACXD93-19650	
	68	PARTICULAR PIECE	1	ACXD93-19660	
	69	PARTICULAR PIECE	1	ACXD93-18402	
	70	PARTICULAR PIECE	1	ACXD93-18411	
	71	PUMP BRACKET	1	ACXD58-00230-B	
	72	FLEXIBLE PIPE - COMPLETE	1	CWH85C1119	
	73	PARTICULAR PLATE	1	ACXD90-23650	
	74	ACCESSORY - COMPLETE	1	ACXH82C21631	
⚠	75	REMOTE CONTROL SWITCH - COMPLETE	1	ACXA75C22650	
	76	BASE BOARD - COMPLETE	1	ACXG62C02610	
	77	FOAMED POLYSTYRENE	4	ACXG07-07161	
	78	BAG	1	ACXG86-05121	
	79	CORRUGATED CARDBOARD	1	ACXG57-11620	
	80	CORRUGATED CARDBOARD	2	ACXG57-11630	
	81	C.C. CASE - COMPLETE	1	ACXG50C10070	
	82	MODEL LABEL	3	ACXF85-83790	

(Note)

- All parts are supplied from PAPAGZ, China (Vendor Code: 00029059).
- "O" marked parts are recommended to be kept in stock.

32.3 CU-2WZ71YBE5

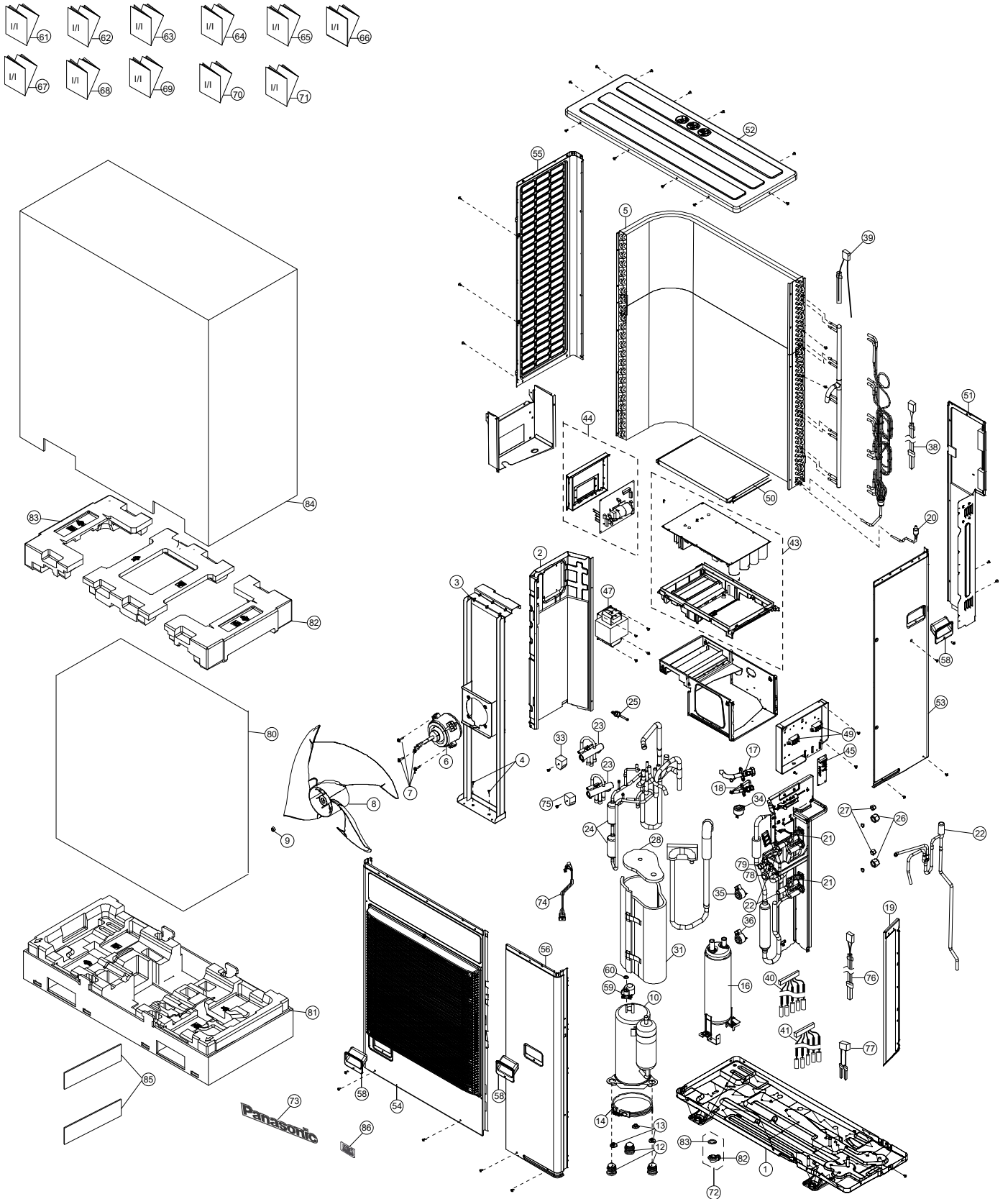

Note
 The above exploded view is for the purpose of parts disassembly and replacement.
 The non-numbered parts are not kept as standard service parts.

SAFETY	REF. NO.	DESCRIPTION & NAME	QTY.	CU-2WZ71YBE5	REMARK
	1	BASE PAN ASS'Y	1	CWD52K1345A	
	2	SOUND - PROOF BOARD	1	CWH151367	
	3	FAN MOTOR BRACKET	1	ACXD54K02270	
	4	SCREW - BRACKET FAN MOTOR	2	CWH551040J	
	5	CONDENSER COMPLETE	1	ACXB32C25400	
⚠	6	FAN MOTOR	1	L6CBYYYYL0098	
	7	SCREW - FAN MOTOR MOUNT	4	CWH551323	
	8	PROPELLER FAN ASSY	1	CWH03K1075	
	9	NUT	1	CWH561092	
⚠	10	COMPRESSOR	1	9KD240XBB21	
	12	BUSHING - COMPRESSOR MOUNT	3	CWH50055	
	13	NUT - COMPRESSOR MOUNT	3	CWH561049	
⚠	14	CRANKCASE HEATER	1	CWA341093	
	16	ACCUMULATOR	1	CWB131064	
	17	3-WAYS VALVE (GAS)	1	CWB011769	
	18	3-WAY VALVE (LIQUID)	1	CWB011770	
	19	HOLDER COUPLING	1	CWH351262	
	20	STRAINER	1	CWB11061	
	21	STRAINER	2	ACXB11-01560	
	22	EXPANSION VALVE	3	CWB051029	
	23	4-WAYS VALVE	2	ACXB00-01470	
	24	DISCHARGE MUFFLER	2	ACXB12-00650	
⚠	25	HEATING PRESSURE SWITCH	1	ACXA10-00640	
	26	FLARE NUT (1/4)	2	CWT251030	
	27	FLARE NUT (3/8)	2	CWT251032	
	28	SOUND PROOF MATERIAL	1	CWG302804	
	31	SOUND PROOF MATERIAL	1	CWG302801	
⚠	33	V-COIL CO. (4 WAY VALVE CN-HOT1)	1	CWA43C2586	
⚠	34	V-COIL CO. (EXPAND VALVE - WHITE CN-STM1)	1	CWA43C2587	
⚠	35	V-COIL CO. (EXPAND VALVE - YELLOW CN-STM2)	1	CWA43C2588	
⚠	36	V-COIL CO. (EXPAND VALVE - BLUE CN-STM3)	1	CWA43C2589	
⚠	38	SENSOR - COMPLETE (DEFROST TEMP SENSOR CN-TH2)	1	CWA50C3087	
⚠	39	SENSOR - COMPLETE (OUTDOOR TEMP SENSOR CN-TH1)	1	ACXA50C00930	
⚠	40	SENSOR - COMPLETE (CN-TH4)	1	ACXA50C18290	
⚠	41	SENSOR - COMPLETE (CN-TH3)	1	ACXA50C18280	
⚠	43	ELECTRONIC CONTROLLER - MAIN	1	ACXA73C83730R	
⚠	44	ELECT. CONTROLLER - NOISE FILTER	1	ACXA73C29300	
⚠	45	ELECTRONIC CONTROLLER (DISPLAY)	1	CWA747223	
⚠	47	REACTOR	1	G0C602J00013	
⚠	49	TERMINAL BOARD ASS'Y (1,2,3)	2	CWA28K1196	

SAFETY	REF. NO.	DESCRIPTION & NAME	QTY.	CU-2WZ71YBE5	REMARK
	50	CONTROL BOARD COVER (TOP PCB)	1	CWH131613	
	51	CABINET REAR PLATE - COMPLETE	1	ACXE02C01670	
	52	CABINET TOP PLATE	1	CWE03C1150	
	53	CABINET SIDE PLATE - COMPLETE	1	ACXE04C08390	
	54	CABINET FRONT PLATE	1	CWE06C1475	
	55	CABINET SIDE PLATE	1	CWE041734A	
	56	CABINET FRONT PLATE - COMPLETE	1	CWE06C1476	
	58	HANDLE	3	CWE161021	
	59	TERMINAL COVER	1	CWH171039A	
	60	NUT - TERMINAL COVER	1	CWH7080300J	
	61	INSTALLATION INSTRUCTION	1	ACXF60-45790	
	62	INSTALLATION INSTRUCTION	1	ACXF60-45800	
	63	INSTALLATION INSTRUCTION	1	ACXF60-45810	
	64	INSTALLATION INSTRUCTION	1	ACXF60-45820	
	65	INSTALLATION INSTRUCTION	1	ACXF60-45830	
	66	INSTALLATION INSTRUCTION	1	ACXF60-45840	
	67	INSTALLATION INSTRUCTION	1	ACXF60-45850	
	68	INSTALLATION INSTRUCTION	1	ACXF60-45860	
	69	INSTALLATION INSTRUCTION	1	ACXF60-45870	
	70	INSTALLATION INSTRUCTION	1	ACXF60-45880	
	71	INSTALLATION INSTRUCTION	1	ACXF60-45890	
	72	ACCESSORY CO. (DRAIN ELBOW)	1	ACXH82C21740	
	73	BADGE PANASONIC	1	CWE373439	
⚠	74	LEAD WIRE - COMPRESSOR	1	CWA68C1395	
⚠	75	V-COIL CO. (4 WAY VALVE CN-HOT2)	1	ACXA43C07380	
⚠	76	SENSOR - COMPLETE (CN-TANK)	1	ACXA50C18300	
⚠	77	SENSOR - COMPLETE (CN-TH5)	1	ACXA50C18310	
	78	3-WAYS VALVE	1	ACXB01-05870	
	79	3-WAYS VALVE	1	ACXB01-05880	
	80	BAG	1	ACXG86-05740	
	81	BASE BOARD - COMPLETE	1	ACXG62C02470	
	82	SHOCK ABSORBER	2	ACXG70-14500A	
	83	SHOCK ABSORBER	1	ACXG70-14510A	
	84	C.C. CASE	1	ACXG50-60040	
	85	MODEL LABEL	2	ACXF85-86020	
	86	INDICATION LABEL - R32	1	CWF746074	

(Note)

- All parts are supplied from PAPAMY, Malaysia (Vendor Code: 00029488).
- "O" marked parts are recommended to be kept in stock.