

MASTER UNIT

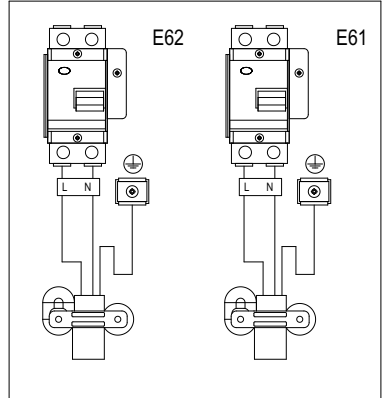

connection type
 ——— required
 - - - - optional

SUB UNITS

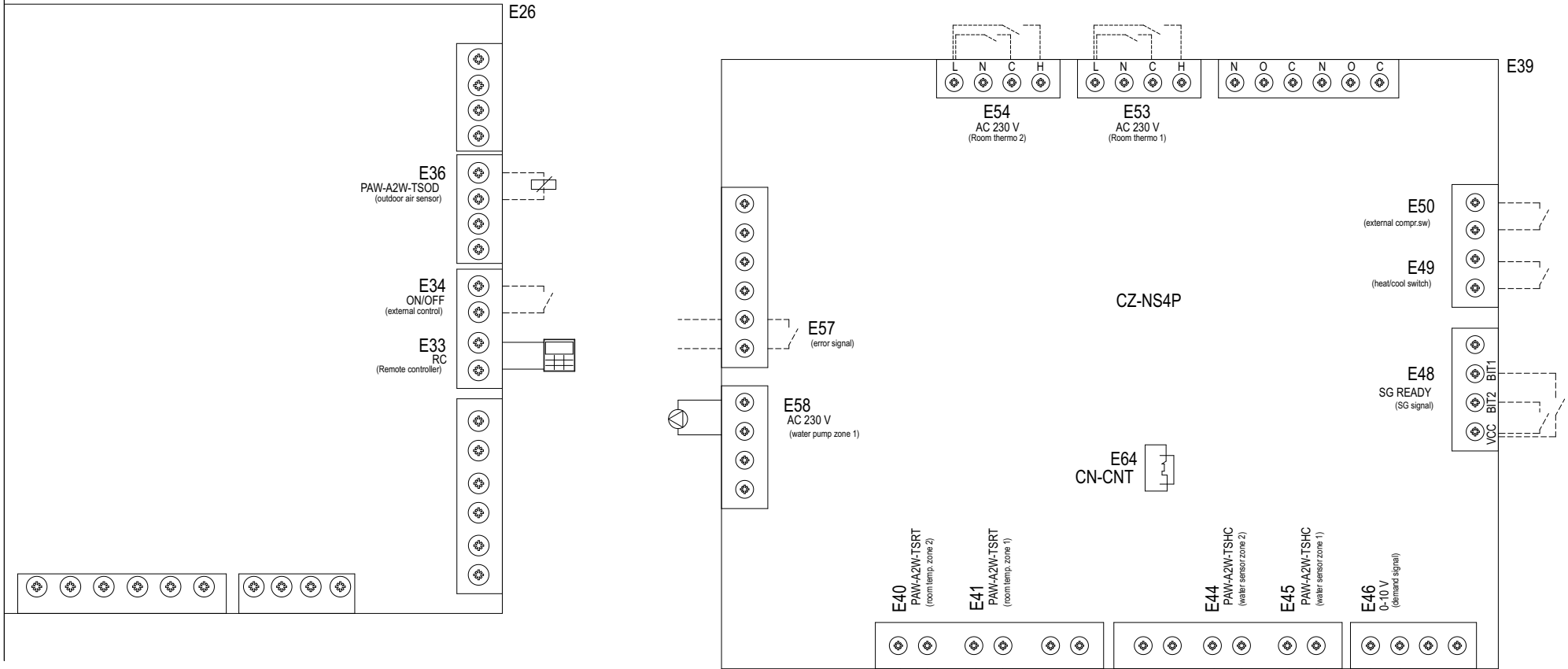
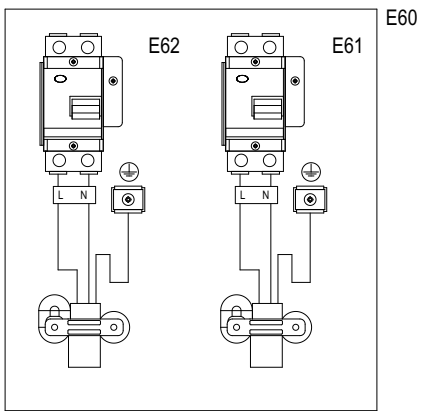
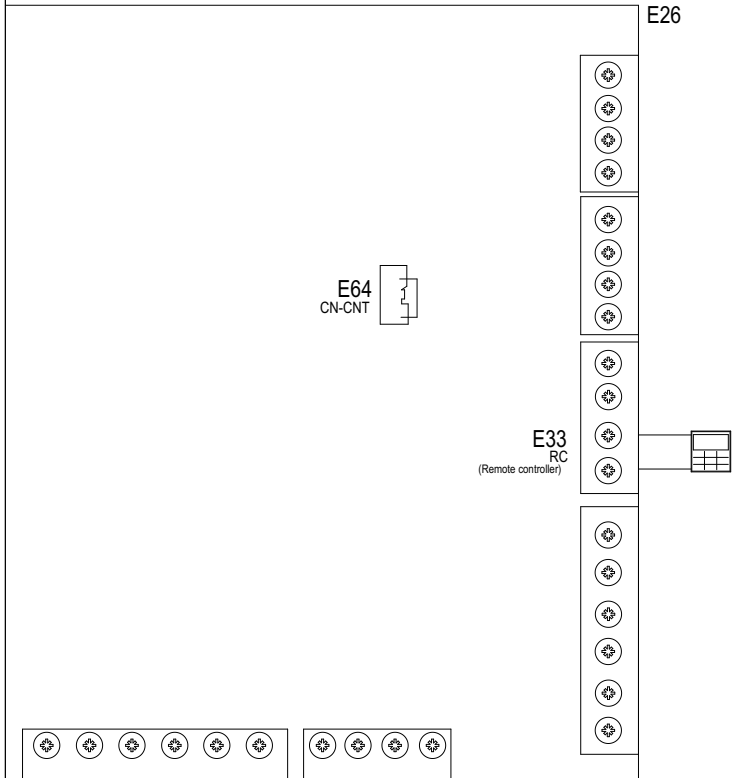

connection type
 ——— required
 - - - - optional

Lista de componentes del sistema

Panasonic Components

REF	CODE	NR	DESCRIPTION
H1	WH-MDC09J3E5	2	Unidad exterior ⁽³⁾ [09, E5]
H9	PAW-A2W-TSRT	2	Sensor de sala (en caso necesario) ⁽¹⁾
H12	CZ-NS4P	1	PCB opcional para bombas de calor de generación H y J
H27	PAW-AW-MBS-H	2	Modbus interface
H28	PAW-A2W-CMH-2	1	Cascade Manager
H29	Manifold/header	1	To be defined according to the system requirements
E36	PAW-A2W-TSOD	2	Sensor de aire exterior (opcional)
---	CZ-NE3P	2	Resistencia para bandeja de condensados (opcional)
E45/E44	PAW-A2W-TSHC	2	Sensor de agua (obligatorio)











Third Party Components

REF	CODE	NR	DESCRIPTION
H5	Retorno	1	Obligatorio para Francia y Bélgica, opcional para otros países
H6	Vaso de expansión	1	en caso necesario
H8	Válvula de rebose	1	Debe definirse según los requisitos del sistema
H9	Termostato de sala	2	en caso necesario ⁽¹⁾
H14	Bomba de agua	1	Debe definirse según los requisitos del sistema

Footnotes

1	Seleccionar los termostatos de sala o los sensores de sala según el control de circuitos seleccionado.
3	Para un funcionamiento normal, la lectura de la presión de agua debe estar entre 0,5 bar y 3 bar.

LEGEND – Monobloc System

Legend for the hydraulic part	
H1	Monobloc heat pump outdoor unit (provide outdoor unit drain).
H2	Remote controller: included with all Monobloc units. Connecting cable (field supplied) can be a maximum of 50m in length
H3	Propylene glycol should be added to prevent freezing of water when no power is to unit. Glycol level to be added will be determined by geographical install location requirements, maximum level of glycol to be added 40% (equivalent to -20°C)
H4	The Y magnetic filter and the flow meter are included in all J generation heat pumps.
H5	System charge and backflow device
H6	Expansion vessel: Every HP has a 10 litre expansion vessel (except WH-MDC05J3E5, WH-MDC07J3E5 and WH-MDC09J3E5 that has a 6 litre) this will cater for 200 litres (150 litres) at 55°C in the fully open heating circuit. Any variation greater than the specification stated, will require a secondary expansion vessel added to the system.
H7	Electrical connections: to be defined when the hydraulic scheme and the system control logic have been selected.
H8	Automatic bypass valve
H9	Optional thermostat: every circuit can be controlled with one optional thermostat, with one room sensor or with the remote controller (only for 1 circuit).
H10	Buffer tank / Volumiser: in the open primary circuit (when all heating – cooling circuits are closed) it is recommended a minimum water volume of at least 30 litres up to and including 9 kW units and 50 litres for 12 (kW stated is nominal heating capacity of the heat pump A7/W35).
H11	Heating/cooling circuit: If the HP is connected directly to the system, the minimum water flow rate must be guaranteed. Provide an automatic bypass valve (recommended 1" diameter) or a 3-way diverting valve on hydronic indoor units (fan-coil, duct unit etc.) or a thermostat must be removed to ensure sufficient flow. If you have floor heating provide a safety thermostat (for heating mode) and a dew-point sensor (for cooling mode).
H12	Optional PCB - CZ-NS4P - needed for this scheme
H13	Mix valve with 3 points control
H14	Secondary water pump: they must be chosen according to the system hydraulic performance.
H15	Boiler
H16	Solar panels
H17	Solar pump
H18	Pool pump
H19	Heat exchanger for the swimming pool (to be sized)
H20	Swimming pool
H21	Expansion vessel (cold water)
H22	Sanitary equipment
H23	Circulation pump (optional) and timer
H24	Domestic hot water tank: If the DHW tank is supplied by Panasonic the DHW temperature sensor is included. If not it is necessary to order one of the following codes: CZ-TK1 (sensor with 20 meter sensor cable and copper pocket) or PAW-TS1 / PAW-TS2 (sensor with 6/20 meter sensor cable).
H25	3 way valve: it is possible to install the Panasonic 3 way valve outside the monobloc unit (code PAW-3WYVLV-SI). The DHW temperature sensor must be ordered separately (see point H24).
	Shut-off valve
	Non-return valve
	Security valve
	Thermostatic mixing valve (optional)
	Pressure regulator
	Boiler circuit pipes
	Solar panels circuit pipes
	Pipes
	Domestic cold water pipe
	Electrical wired cables

Legend for the electric part	
E26	Main board PCB: the maximum cable length for sensor inputs is 30 meters and the maximum cable length for outputs and other inputs is 50 meters.
E27	2 way valve: open for heating (O+N) and close for cooling (C+N)
E28	3 way valve: open for DHW (O+N) and close for heating/cooling system (C+N)
E29	Optional thermostat 1: every circuit can be controlled with one optional thermostat (E29 for one zone and E53 and E54 for 2 zones), with one room sensor (E37 for one zone or E40 and E41 for 2 zones) or with the remote controller (E33, only for 1 circuit).
E30	Booster heater
E31	Extra pump control
E32	ON/OFF boiler or deice output (dry contact)
E33	Remote Controller: the H generation heat pump remote controller can be used as a room thermostat for only one circuit. The cables maximum length is 50 meters.
E34	External ON/OFF (dry contact)
E35	DHW tank sensor
E36	Outdoor air sensor (optional)
E37	Zone 1 room sensor (see point E29)
E38	OLP booster heater: on the OLP contact must be put a jumper if external booster heater is used and controlled by Panasonic heat pumps.
E39	Optional PCB: the maximum cable length for sensor inputs is 30 meters and the maximum cable length for outputs and other inputs is 50 meters. If the optional PCB (CZ-NS4P) is installed, the room sensor 1 and the extra pump control contacts of the main PCB are disabled
E40	Zone 2 room sensor (see point E29)
E41	Zone 1 room sensor (see point E29)
E42	Buffer tank sensor
E43	Pool water sensor
E44	Water sensor zone 2 (see point E29)
E45	Water sensor zone 1 (see point E29)
E46	Demand signal (0-10 V)
E47	Solar sensor
E48	Smart Grid signal: the 2 contacts can increase the set-point for DHW and heating or cooling if there is energy production from the PV panels.
E49	Heat / cool switch
E50	External compressor switch
E51	Mixing valve zone 2
E52	Mixing valve zone 1
E53	Optional thermostat 1 (see point E29)
E54	Optional thermostat 2 (see point E29)
E55	Pool pump
E56	Solar pump
E57	Error signal (dry contact)
E58	Pump zone 1
E59	Pump zone 2
E60	Monobloc unit power supply
E61	Monobloc unit power supply 1 - main
E62	Monobloc unit power supply 2 - heaters

Attention: All requirements in this page are only examples and they are not a project design specific. Refer always to the documentation provided by Panasonic.

Panasonic is not responsible, directly or indirectly, towards users and in general towards any third party for any delays, inaccuracies, errors, omissions, damages (direct, indirect, consequential, and punishable) arising from such contents. Texts, photos, graphics, may not be published, rewritten, marketed and distributed by users and third parties in general, in any way and in any form if not expressly indicated in written form by Panasonic itself.

Legend Appendix for Cascade Items

Label	Item	Details
H27	PAW-AW-MBS-H	Modbus interface
H28	PAW-A2W-CMH-2	Cascade Manager
H29	Manifold/header	To be defined according to the installation requirement

Installation Guidance for Cascade Manager and Interface

Always refer to the installation instructions provided with the Cascade Manager and Interface for full installation details.

The basic installation concept is explained in the points and diagram shown below:

1. The Cascade Manager requires a 230 V AC power supply.
2. Each heat pump requires an interface to communicate with the Cascade Manager. The interface must be connected to the heat pump on the CN-CNT connection port. A connection cable is provided with each interface.
3. Each interface must be connected to the Cascade Manager by using a bus line to allow Modbus communication.
4. The bus terminating resistor must be activated at the last unit on the bus line, which is farthest away from the Cascade Manager.
5. Each heat pump must be assigned a Modbus address, which corresponds to the heat pump's number. (Heat Pump 1 = 1, HP2 = 2, ...HP10 = 10).
6. If heat pumps 2 to 10 are also to be used for "Tank" mode, either a real tank temperature sensor or a substitute resistor is needed for each of them. A small plastic bag labelled "HP2-10 TANK SENSOR" is fixed to the Cascade Manager's base plate. This bag contains 9 resistors, which are supplied as a substitute for the tank temperature sensors of heat pumps 2 to 10.

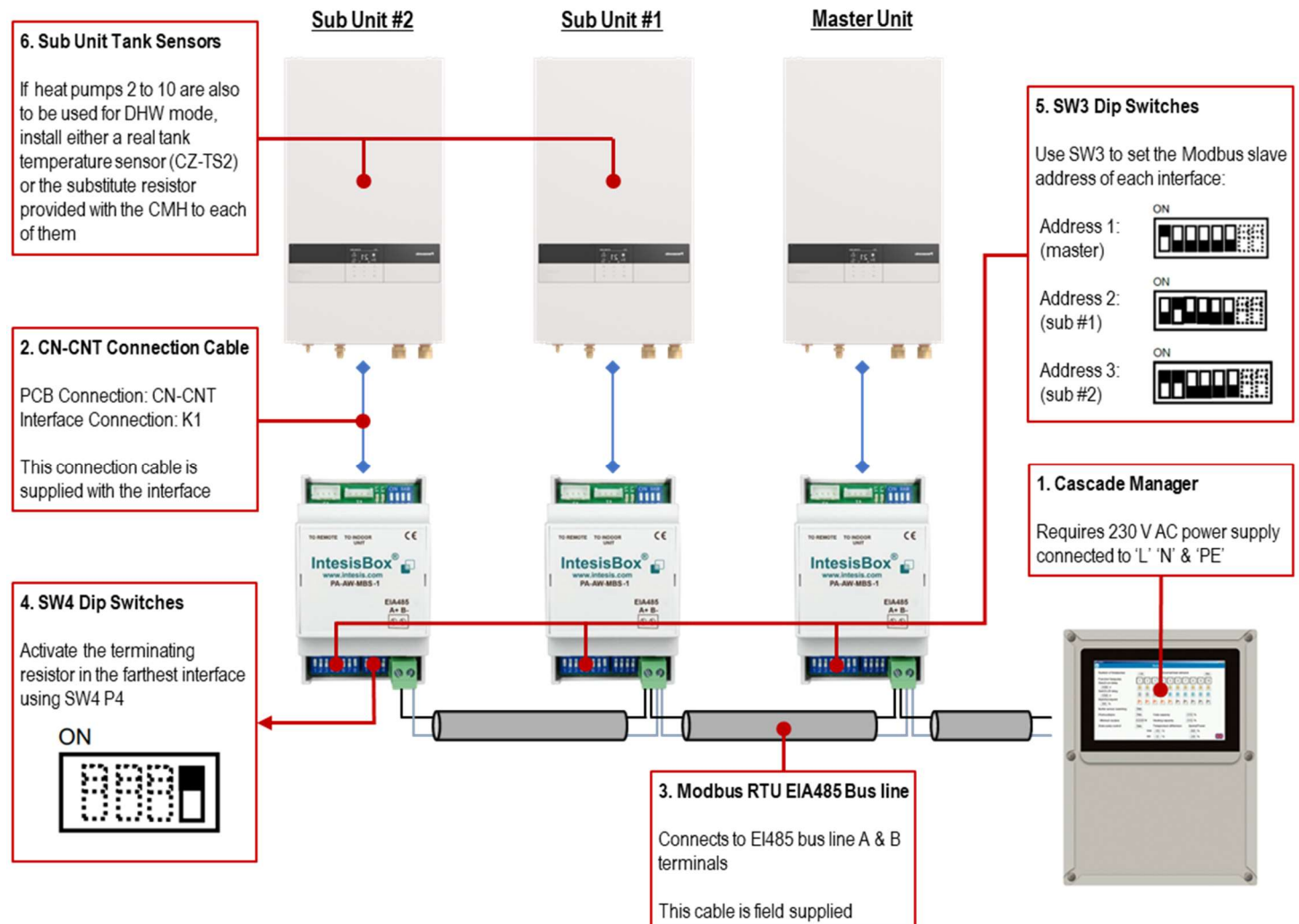

Cascade Manager Terminal Block

The following table shows the terminal assignment and description of the Cascade Manager. It can also be found on a label within the controller housing next to the cable glands.

Terminal Section	Function	Terminals																		
<table border="1"> <tr> <td>L</td> <td>N</td> <td>PE</td> </tr> <tr> <td colspan="3">Power</td> </tr> <tr> <td colspan="3">230V AC IN</td> </tr> </table>	L	N	PE	Power			230V AC IN			Mains power supply cable NOTICE: an external power fuse (max 2 A) must be installed	L	= Phase, black								
	L	N	PE																	
	Power																			
230V AC IN																				
N	= Neutral line, blue																			
PE	= Ground wire, green/yellow																			
<table border="1"> <tr> <td>A</td> <td>B</td> </tr> <tr> <td colspan="2">EIA485 Modbus</td> </tr> <tr> <td colspan="2">HP1-10 E-Meter</td> </tr> </table>	A	B	EIA485 Modbus		HP1-10 E-Meter		Modbus communication between CMH, heat pumps and electricity meters for PV function	A	= Modbus EIA485, terminal A											
	A	B																		
EIA485 Modbus																				
HP1-10 E-Meter																				
B	= Modbus EIA485, terminal B																			
<table border="1"> <tr> <td>HEAT</td> <td>COOL</td> <td>N</td> <td>PE</td> </tr> <tr> <td colspan="4">230V AC OUT BUFFER VALVE</td> </tr> </table>	HEAT	COOL	N	PE	230V AC OUT BUFFER VALVE				Direction control valve for heating/cooling changeover of the buffer tank	HEAT	= Relay output 230 V AC phase, to open the heating buffer tank									
	HEAT	COOL	N	PE																
	230V AC OUT BUFFER VALVE																			
	COOL	= Relay output 230 V AC phase, to open the cooling buffer tank																		
N	= Neutral line																			
PE	= Ground wire																			
<table border="1"> <tr> <td>⊥</td> <td>H</td> <td>⊥</td> <td>C</td> <td>⊥</td> <td>B</td> </tr> <tr> <td>IN HEAT</td> <td>IN COOL</td> <td colspan="3">OUT HP1</td> </tr> <tr> <td colspan="6">SENSOR BUFFER TANK</td> </tr> </table>	⊥	H	⊥	C	⊥	B	IN HEAT	IN COOL	OUT HP1			SENSOR BUFFER TANK						Buffer tank sensor changeover Note: When connecting the buffer tank sensor to the Cascade Manager, you will also need to connect from "OUT HP1" to the "buffer tank sensor" terminals of the Master unit.	⊥	= Sensor ground
	⊥	H	⊥	C	⊥	B														
	IN HEAT	IN COOL	OUT HP1																	
	SENSOR BUFFER TANK																			
	H	= Signal input from the heating buffer sensor																		
	⊥	= Sensor ground																		
C	= Signal input from the cooling buffer sensor																			
⊥	= Sensor ground																			
B	= Signal output to Heat Pump 1 (optional PCB, terminal section: buffer tank sensor)																			
<table border="1"> <tr> <td>⊥</td> <td>P</td> </tr> <tr> <td>G</td> <td>W</td> </tr> <tr> <td>N</td> <td>M</td> </tr> <tr> <td>D</td> <td></td> </tr> <tr> <td colspan="2">Pump Solar</td> </tr> </table>	⊥	P	G	W	N	M	D		Pump Solar		Solar thermal system, speed control of the solar circuit pump by PWM signal	⊥	= Ground, reference potential							
	⊥	P																		
G	W																			
N	M																			
D																				
Pump Solar																				
PWM	= output for pulse width modulation control signal																			
<table border="1"> <tr> <td>⊥</td> <td>↑</td> </tr> <tr> <td colspan="2">10V DC IN</td> </tr> <tr> <td colspan="2">Heat: 2.5-6.5V</td> </tr> <tr> <td colspan="2">Cool: 0.5-2V ext. demand</td> </tr> </table>	⊥	↑	10V DC IN		Heat: 2.5-6.5V		Cool: 0.5-2V ext. demand		External heating/cooling demand signal	⊥	= Ground, reference potential									
	⊥	↑																		
	10V DC IN																			
Heat: 2.5-6.5V																				
Cool: 0.5-2V ext. demand																				
↑	= Input 0 – 10 V																			
Heating demand: HEAT: 2.5 – 6.5V = 25 – 65 °C Cooling demand: COOL: 0.5 – 2V = 5 – 20 °C																				