

IL FUOCO 5.0



TARIFA IBÉRICA

20
SEPTIEMBRE 24

 **EK3**
Smart Fire

edilkamin.com

Follow us   

CONTACTOS ÚTILES

Realización y consulta pedidos info comerciales
celia.vinolas@edilkamin.com

Contabilidad
anna.gifre@edilkamin.com

Logística y gestión entregas
jordi.porcell@edilkamin.com

Administración SAT
anna.bou@edilkamin.com

Consultas Pre-Venta
preventa@edilkamin.com

Marketing
marketingiberica@edilkamin.com

PELLET

AIRE CALIENTE

ESTUFAS ESTANCAS 8 - 31

Berry90+	18-19
Cell80+	26-27
Daily130++	22-23
Dub100++	30-31
Entity90+	28-29
Gotha70	24-25
Like80	8-9
Metro110+	20-21
Spy110+	12-13
Tweed90+	10-11
Yung130++	14-15
Zone80	16-17

ESTUFAS 32 - 33

Maison80	32-33
Maison80+	32-33

INSERTABLES 34-35

Pellek110+ Evo	34-35
Pellek80 Evo	34-35

AGUA CALIENTE

TERMOSTUFE 36-37

Spot100 H	36-37
Spot100 H Evo	36-37

CALDERAS 38-39

Kappa200	38-39
Kappa240	38-39
Kappa270	38-39

LEÑA

AIRE CALIENTE

ESTUFAS 41 - 43

Fancy/Fancy Evo	41
Decor/Decor Evo	42-43
Decor C/Decor C Evo	44-45

CHIMENEAS 46-47

Firek 1	46-47
Firek 2	46-47
Firek 3	46-47

Accesorios (también válidos para Italiana Camini)	48-57
--	-------

Datos técnicos	58-61
----------------	-------

Condiciones generales de venta (también válidos para Italiana Camini)	62
--	----

Informaciones/Leyenda símbolos	62-63
--------------------------------	-------

EK63 es la nueva marca de **Edilkamin** que ofrece soluciones “inteligentes” para una nueva generación de calefacción más económica: las más **modernas tecnologías están ahora al alcance de todos**. No basta con planificar la calefacción, hoy es necesario **gestionar el calor de casa en todo momento** según la dinámica de la vida cotidiana!

Las estufas y los insertables de pellets con **wi-fi integrado** establecen un contacto directo con el usuario, que a distancia puede **en todo momento decidir la comodidad** del propio hogar.

La gama también incluye varios modelos de estufas herméticas, ideales en las casas pasivas, pero adecuadas para cualquier hogar. Las estufas herméticas extraen el aire de combustión directamente del exterior de la casa y no del hogar, lo que garantiza un calor más limpio y confortable.

Para aquellos que les gusta el **fuego tradicional** pero quieren **fiabilidad, seguridad y combustión en equilibrio con la naturaleza**, la gama también incluye **estufas y hogares de leña**.

EK63 Smart Fire:

deseo de alta tecnología, cuidado del ahorro, alma “verde”.

Entre las **estufas** y los **insertables de pellet**, algunos modelos pueden **canalizar el aire caliente** a otra estancia además de la de instalación (**modelos +**) o en otras dos estancias (**modelos ++**).

También los **hogares de leña** están preparados para la canalización (disponible kit opcional).

¡hay más confort en más estancias!

La tecnología E-Smart

E-Smart es el sistema innovador con WI-FI integrado que conecta estufas e insertables de pellets de la gama EK63 a la red wi-fi de casa. La gestión de la calefacción, simple e intuitiva, es posible utilizando el display, la App SmartEK63 o el radio mando opcional.

E-Smart es la calefacción que sigue su estilo de vida, dentro y fuera de la casa!

Display y App

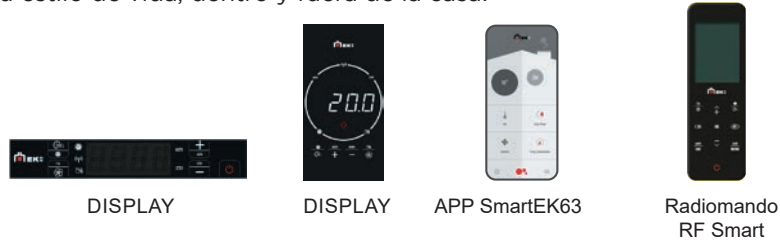

Los productos de pellets de la gama EK63 (estufas e insertables) se pueden gestionar directamente desde el display o de forma remota mediante App SmartEK63.

Las principales funciones:

- WI-FI, para gestionar en remoto la calefacción.
- Funcionamiento MANUAL/AUTOMÁTICO: en automático, se establece el confort deseado y la potencia se ajusta automáticamente. En manual, se establece directamente la potencia.

Función RELAX, ventilación aire caliente desactivable. Confort clima (STBY - Stand-by), la estufa se apaga al llegar a la temperatura deseada. Fire Control, modulación automática del aporte de combustible (consumo óptimo). Programador Horario, programador horario: encendido/apagado en el horario deseado. Función EASY TIMER, simplificación de la programación de encendido/apagado.

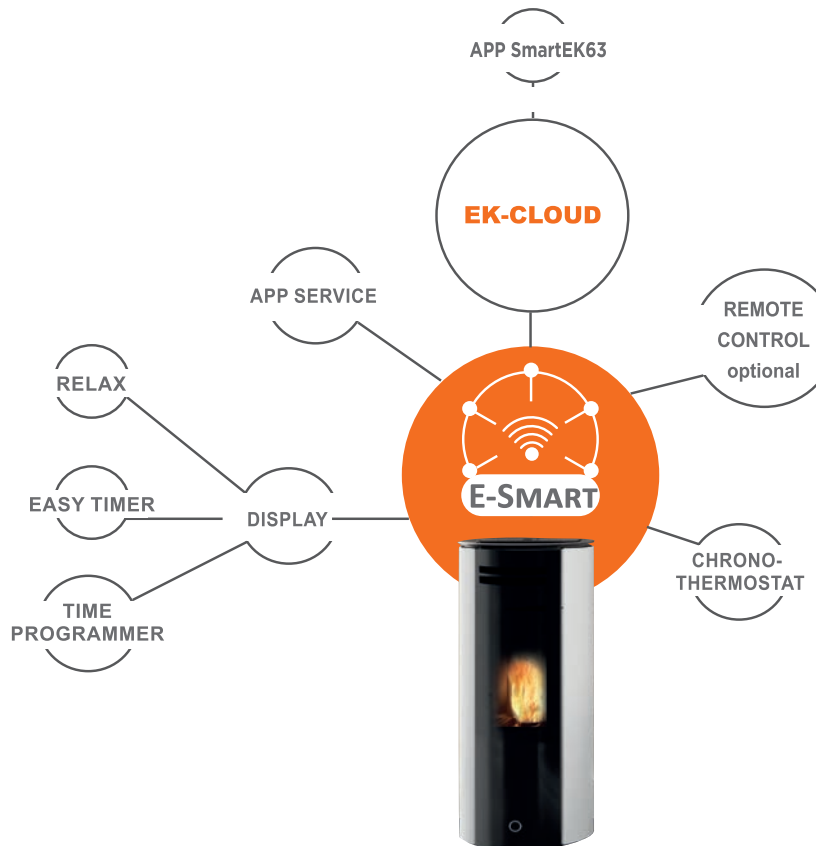

N.B. Los requisitos mínimos para utilizar la APP SmartEK63 en los dispositivos móviles son los siguientes:

- Sistema operativo iOS 14 o superior o Android 9.0 o superior.
 - En los iPhone 6S, 7 y 8 no se puede utilizar la función de "zoom" de la pantalla.
- Además, le informamos que los dispositivos de la marca HUAWEI (y las marcas asociadas, por ejemplo: HONOR), no son compatibles con la aplicación SmartEK63.

Esta informaciones pueden sufrir cambios o actualizaciones.





Calentar con el

El aire

Las estufas y los insertables de pellet producen aire caliente para calentar la estancia en la que están instalados y, según el modelo, también pueden suministrar aire caliente a **otras estancias**, con las correspondientes **canalizaciones**. El aire se suministra con ventilación forzada y los ventiladores pueden ajustarse por separado para adaptarse a sus necesidades.

6



Estufas estancas Air Tight



Like80
7,6 kW
pág. 8-9



Tweed90+
9,2 kW
pág. 10-11



Spy110+
10,5 kW
pág. 12-13



Yung130++
12,5 kW
pág. 14-15



Zone80
7,6 kW
pág. 16-17



Berry90+
9,2 kW
pág. 18-19



Metro110+
10,5 kW
pág. 20-21



Daily130++
12,5 kW
pág. 22-23



Gotha70
6,7 kW
pág. 24-25



Cell80+
7,7 kW
pág. 26-27



Entity90+
8,7 kW
pág. 28-29



Dub100++
10,1 kW
pág. 30-31

Estufas



Maison80
Maison80+
8,2/8 kW
pág. 32-33

Insertables



Pellek80 Evo
Pellek110+ Evo
8,1/9,8 kW
pág. 34-35



pellet

El pellet es un combustible **económico** y **en equilibrio con el medio ambiente**, consistente exclusivamente en serrín de madera comprimido. Su uso permite **un funcionamiento programable y automático**, que también se puede gestionar a distancia.



El agua

Las **termoestufas y calderas de pellets** calientan el agua que alimenta los radiadores y los paneles de calefacción por suelo radiante de toda la casa. Algunos modelos también pueden producir agua caliente sanitaria, que puede almacenarse en calentadores especiales. **EK63** ofrece modelos para calentar todo tipo de espacios y proporciona kits hidráulicos premontados para su correcta instalación.

7



Termo-estufas



Spot100 H
Spot100 H Evo
10,1 kW
pág. 36-37

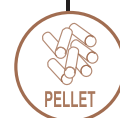

Calderas



Kappa200
21,5 kW
pág. 38-39



Kappa240
25,8 kW
pág. 38-39



Kappa270
29,2 kW
pág. 38-39





8



Cerámica tortora

LIKE80



Apta para casas pasivas

- Hogar de vermiculita
- Resistencia cerámica
- Salida humos:
 - Ø 8 cm superior, hembra (versiones en acero y en cerámica)
 - Ø 8 cm posterior, macho (versiones en acero negro mate y blanco perla)
 - Ø 8/13 cm coaxial
- Ventilación aire caliente superior
- Sistema Smart con Wi-Fi integrado
- Panel sinóptico superior
- Programación diaria / semanal
- Función EASY TIMER
- Función RELAX

Cerámica



Acero



Like80 3,4-7,6 90,8 200 0,8-1,7 9-19 15 V opcional ● ● ● ● ● ● ● ● ● ●



SALIDA HUMOS Ø 8 cm superior hembra			CÓDIGO	EUROS precios sin IVA
Like80	Acero	Blanco perla	813160	2.050
		Tortora	813170	
		Burdeos	813180	
		Negro mate	813190	

SALIDA HUMOS Ø 8/13 cm superior coaxial			CÓDIGO	EUROS precios sin IVA
NEW Like80	Acero	Blanco perla	815330	2.590
		Tortora	815340	
		Negro mate	815360	

SALIDA HUMOS Ø 8 cm posterior macho			CÓDIGO	EUROS precios sin IVA
Like80	Acero	Blanco perla	813210	2.050
		Negro mate	813220	

SALIDA HUMOS Ø 8 cm superior hembra			CÓDIGO	EUROS precios sin IVA
Estructura*			813200	1.950

***Es indispensable comprar una de las series abajo detalladas.**

Like80	serie cerámica	Blanco mate	1148020	520
		Tortora	1148030	
		Burdeos	1148040	

DOTACIÓN

Sistema Smart con Wi-Fi integrado	--	--
-----------------------------------	----	----

OPCIONAL

Radiomando RF Smart	1153710	140
---------------------	---------	-----

Salida humos Ø 8 cm superior

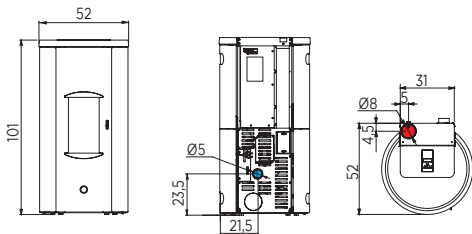

Salida humos Ø 8 cm posterior

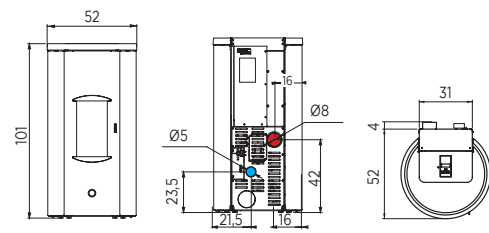

Salida humos Ø 8/13 cm superior coaxial

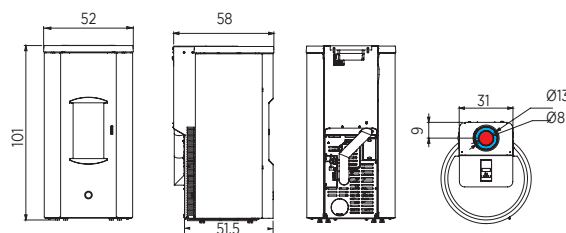

Ø8 F	/	90 acero	52x52x101h	/
Ø8 M	/	120 cer.		

/	Ø8/13 F	90 acero	52x58x101h	/





10



Cristal negro

TWEED90+ canalizable



Apta para casas pasivas

- Hogar de vermiculita
- Resistencia cerámica
- Salida humos:
 - Ø 8 cm superior, hembra (en acero y cristal)
 - y posterior, macho (acero negro mate y cristal blanco)
 - Ø 8/12,5 cm coaxial (con kit opcional)
- 1 salida aire caliente canalizable posterior Ø 8 cm
- Ventilación aire caliente frontal
- Sistema Smart con Wi-Fi integrado
- Panel sinóptico superior
- Programación diaria / semanal
- Función EASY TIMER
- Función RELAX

Cristal









Acero



Tweed90+ 3,4-9,2 90,9 240 0,8-2,1 7-19 15 V opcional ● ● ● ● ● ● ● ●





Acero burdeos

SALIDA HUMOS Ø 8 cm superior hembra		CÓDIGO	EUROS precios sin IVA
Tweed90+	Acero	 Blanco perla	813230
		 Tortora	813240
		 Burdeos	813250
		 Negro mate	813260
Tweed90+	Cristal	 Blanco	813280
		 Negro	813270

2.260

2.570

SALIDA HUMOS Ø 8 cm posterior macho		CÓDIGO	EUROS precios sin IVA
Tweed90+	Cristal	 Blanco	813300
	Acero	 Negro mate	813290

2.570

2.260

OPCIONAL para versión Ø 8 cm posterior

Kit salida de humos coaxial Ø8/12,5 cm	1146140	310
--	---------	-----

DOTACIÓN

Sistema Smart con Wi-Fi integrado	--	--
-----------------------------------	----	----

OPCIONAL

Radiomando RF Smart	1153710	140
KIT 12, canalización para un local contiguo (ver pág. 48)	778150	90
KIT 12 bis, canalización para un local distante (ver pág. 48)	778160	115
Rejas C4 9,3x9,3 cm raccord Ø 8 cm blanco mate (ver pág. 49)	1112270	50
Kit deflector aire (es obligatoria su compra para la instalación en el caso en que la estufa no viniera canalizada).	1155280	45

Salida humos Ø 8 cm superior

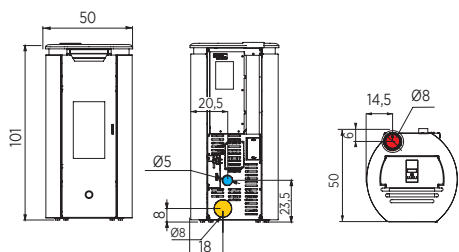

Salida humos Ø 8 cm posterior

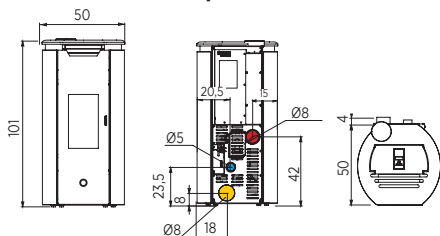

Ø8 M
Ø8 F



Ø8/12,5
kit opcional



95



50x50x101 h



nº1
Ø 8 cm





Cristal blanco

SPY110+ canalizable



El cristal "Magic" cuando la estufa está funcionando, regala una placentera visión de la llama. Con la estufa apagada, el cristal totalmente negro, deja invisible el hogar, exaltando la elegancia del diseño.

Apta para casas pasivas

- Hogar de vermiculita
- Resistencia cerámica
- Salida humos: Ø 8 cm posterior macho
Ø 8/12,5 cm coaxial (Kit opcional)
- 1 salida aire caliente canalizable posterior Ø 8 cm
- Ventilación aire caliente frontal
- Sistema Smart con Wi-Fi integrado
- Doble puerta interna de fundición y externa en cristal "Magic"
- Panel sinóptico superior
- Programación diaria/semanal
- Función EASY TIMER
- Función RELAX

Cristal









Acero



Spy110+ 3,7-10,5 91,9 275 0,8-2,4 9-28 22 V opcional ● ● ● ● ● ● ● ●



SALIDA HUMOS Ø 8 cm posterior macho			CÓDIGO	EUROS precios sin IVA
Spy110+	Acero	 Blanco perla	813460	2.570
		 Tortora	813470	
		 Burdeos	813480	
		 Negro mate	813490	
Spy110+	Cristal	 Blanco	813500	2.990
		 Negro	813510	
DOTACIÓN				
Sistema Smart con Wi-Fi integrado			--	--
OPCIONAL				
Radiomando RF Smart			1153710	140
Kit salida de humos coaxial Ø8/12,5 cm			1146140	310
KIT 12, canalización para un local contiguo (ver pág. 48)			778150	90
KIT 12 bis, canalización para un local distante (ver pág. 48)			778160	115
Rejas C4 9,3x9,3 cm raccord Ø 8 cm blanco mate (ver pág. 49)			1112270	50
Kit deflector aire (es obligatoria su compra para la instalación en el caso en que la estufa no viniera canalizada).			1155280	45



13

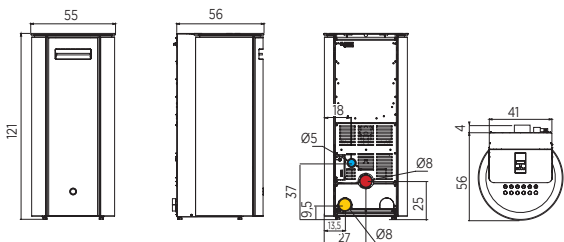

Ø8 M



Ø 8/12,5
kit opcional



130



55x56x121



nº
Ø 8 cm



Cerámica blanco mate

YUNG130++ canalizable



Apta para casas pasivas

- Hogar de vermiculita
- Resistencia cerámica
- Salida humos: Ø 8 cm posterior macho
Ø 8/12,5 cm coaxial (Kit opcional)
- 2 salidas aire caliente canalizable posterior Ø 8 cm
- Ventilación aire caliente frontal
- Sistema Smart con Wi-Fi integrado
- Panel sinóptico superior
- Programación diaria/semanal
- Función EASY TIMER
- Función RELAX



Yung130++

3,7-12,5

90,2

325

0,8-2,9

8-28

22

V

opcional

●

●

●

●

●





●

●

●



Cerámica tortora

SALIDA HUMOS Ø 8 cm posterior macho		CÓDIGO	EUROS precios sin IVA	
Estructura*		 813520	2.820	
*Es indispensable comprar una de las series abajo detalladas.				
Yung130++	serie cerámica	 Blanco mate	1148080	270
		 Tortora	1148090	
		 Burdeos	1148100	
		 Negro mate	1148440	
DOTACIÓN				
Sistema Smart con Wi-Fi integrado		--	--	
OPCIONAL				
Radiomando RF Smart		1153710	140	
Kit salida de humos coaxial Ø8/12,5 cm		1146140	310	
KIT 12, canalización para un local contiguo (ver pág. 48)		778150	90	
KIT 12 bis, canalización para un local distante (ver pág. 48)		778160	115	
Rejas C4 9,3x9,3 cm raccord Ø 8 cm blanco mate (ver pág. 49)		1112270	50	
Kit deflector aire (es obligatoria su compra para la instalación en el caso en que la estufa no viniera canalizada).		1155280	45	

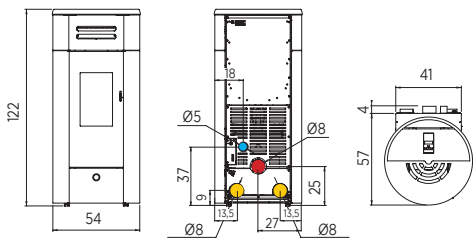

Ø8 M



Ø 8/12,5
kit opcional



155



54x57x122h



n°2
Ø 8 cm





Acero negro mate

ZONE80



Apta para casas pasivas

- Hogar de vermiculita
- Resistencia cerámica
- Salida humos Ø 8 cm posterior macho
Ø 8/12,5 cm coaxial (Kit opcional)
- Ventilación aire caliente superior
- Sistema Smart con Wi-Fi integrado
- Panel sinóptico superior
- Programación diaria/semanal
- Función EASY TIMER
- Función RELAX



Zone80

3,4-7,6

90,8

200

0,8-1,7

9-19

15



V

opcional





Acero burdeos

SALIDA HUMOS Ø 8 cm posterior macho		CÓDIGO	EUROS precios sin IVA
Zone80	Acero	 Blanco perla	813110
		 Tortora	813120
		 Burdeos	813130
		 Negro mate	813140
DOTACIÓN			1.640
Sistema Smart con Wi-Fi integrado		--	
OPCIONAL			
Radiomando RF Smart		1153710	140
Kit salida de humos coaxial Ø8/12,5 cm		1146140	310

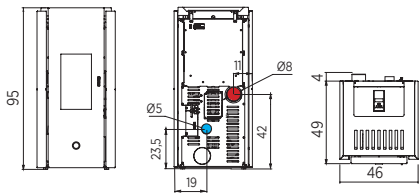

Ø8 M



Ø8/12,5
opcional



95



46x49x95h



/



18



Cerámica blanco mate

BERRY90+ canalizable



Apta para casas pasivas

- Hogar de vermiculita
- Resistencia cerámica
- Salida humos: Ø 8 cm posterior macho
Ø 8/12,5 cm coaxial (Kit opcional)
- 1 salida aire caliente canalizable posterior Ø 8 cm
- Ventilación aire caliente frontal
- Sistema Smart con Wi-Fi integrado
- Panel sinóptico superior
- Programación diaria/semanal
- Función EASY TIMER
- Función RELAX



Berry90+ 3,4-9,2 90,9 240 0,8-2,1 10-25 20 V opcional ● ● ● ● ● ● ● ● ●



Cerámica tortora

SALIDA HUMOS Ø 8 cm posterior macho		CÓDIGO	EUROS precios sin IVA
Estructura*		 813150	1.790
*Es indispensable comprar una de las series abajo detalladas.			
Berry90+	serie cerámica	 Blanco mate	1147990
		 Tortora	1148000
		 Burdeos	1148010
			270

DOTACIÓN

Sistema Smart con Wi-Fi integrado	--	--
-----------------------------------	----	----

OPCIONAL

Radiomando RF Smart	1153710	140
Kit salida de humos coaxial Ø8/12,5 cm	1146140	310
KIT 12, canalización para un local contiguo (ver pág. 48)	778150	90
KIT 12 bis, canalización para un local distante (ver pág. 48)	778160	115
Rejas C4 9,3x9,3 cm raccord Ø 8 cm blanco mate (ver pág. 49)	1112270	50
Kit deflector aire (es obligatoria su compra para la instalación en el caso en que la estufa no viniera canalizada).	1155280	45

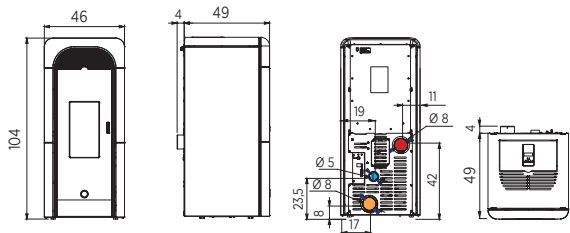

Ø8 M



Ø8/12,5
kit opcional



125



46x49x104h



nº1
Ø 8 cm





20



Acero negro mate

METRO110+ canalizable



Apta para casas pasivas





- Hogar de vermiculita
- Resistencia cerámica
- Salida humos: Ø 8 cm posterior macho
Ø 8/12,5 cm superior coaxial (Kit opcional)
- 1 salida aire caliente canalizable posterior Ø 8 cm
- Ventilación aire caliente frontal
- Sistema Smart con Wi-Fi integrado
- Panel sinóptico superior
- Programación diaria/semanal
- Función EASY TIMER
- Función RELAX



Metro110+ 3,7-10,5 91,9 275 0,8-2,4 10-29 23 V opcional ● ● ● ● ● ● ● ● ● ●



Acero blanco perla

SALIDA HUMOS Ø 8 cm posterior macho		CÓDIGO	EUROS precios sin IVA
Metro110+	Acero	 Blanco perla	813410
		 Tortora	813420
		 Burdeos	813430
		 Negro Mate	813440
			2.260

DOTACIÓN

Sistema Smart con Wi-Fi integrado	--	--
-----------------------------------	----	----

OPCIONAL

Radiomando RF Smart	1153710	140
Kit salida de humos coaxial Ø8/12,5 cm	1146140	310
KIT 12, canalización para un local contiguo (ver pág. 48)	778150	90
KIT 12 bis, canalización para un local distante (ver pág. 48)	778160	115
Rejas C4 9,3x9,3 cm raccord Ø 8 cm blanco mate (ver pág. 49)	1112270	50
Kit deflector aire (es obligatoria su compra para la instalación en el caso en que la estufa no viniera canalizada).	1155280	45

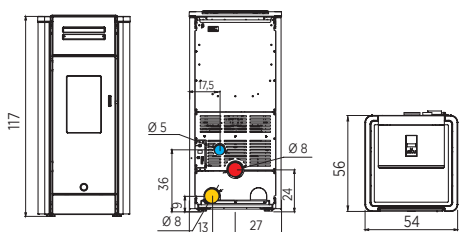

Ø8 M



Ø8/12,5
kit opcional



160



54x56x117h



n°1
Ø 8 cm





Cerámica tortora

DAILY130++ canalizable



Apta para casas pasivas

- Hogar de vermiculita
- Resistencia cerámica
- Salida humos: Ø 8 cm posterior macho
Ø 8/12,5 cm superior coaxial (Kit opcional)
- 2 salidas aire caliente canalizable posterior Ø 8 cm
- Ventilación aire caliente frontal
- Sistema Smart con Wi-Fi integrado
- Panel sinóptico superior
- Programación diaria/semanal
- Función EASY TIMER
- Función RELAX



Daily130++ 3,7-12,5 90,2 325 0,8-2,9 8-29 23 V opcional ● ● ● ● ● ● ● ● ● ●



SALIDA HUMOS Ø 8 cm posterior macho		CÓDIGO	EUROS precios sin IVA
Estructura*		813450	2.510
*Es indispensable comprar una de las series abajo detalladas.			
Daily130++	serie cerámica	 Blanco mate	1148050
		 Tortora	1148060
		 Burdeos	1148070
			630

DOTACIÓN		
Sistema Smart con Wi-Fi integrado	--	--
OPCIONAL		
Radiomando RF Smart	1153710	140
Kit salida de humos coaxial Ø8/12,5 cm	1146140	310
KIT 12, canalización para un local contiguo (ver pág. 48)	778150	90
KIT 12 bis, canalización para un local distante (ver pág. 48)	778160	115
Rejas C4 9,3x9,3 cm raccord Ø 8 cm blanco mate (ver pág. 49)	1112270	50
Kit deflector aire (es obligatoria su compra para la instalación en el caso en que la estufa no viniera canalizada).	1155280	45

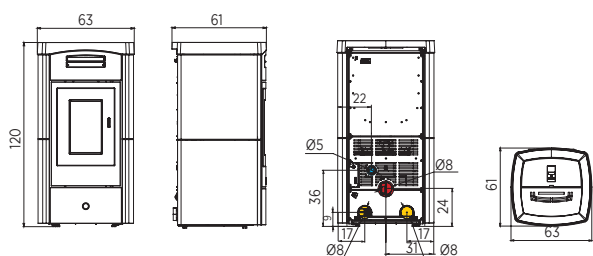

Ø8 M



Ø8/12,5
kit opcional



210



63x61x120h



nº2
Ø 8 cm





24



Acero burdeos

GOTHA70



Apta para casas pasivas

Profundidad reducida (cm 30).

- Hogar de vermiculita
- Resistencia cerámica
- Salida humos Ø 8 cm superior, hembra
- Ventilación aire caliente superior
- Sistema Smart con Wi-Fi integrado
- Panel sinóptico superior
- Programación diaria/semanal
- Función EASY TIMER
- Función RELAX



Gotha70

2,7-6,7

88,4

175

0,6-1,6

8-20

12





V

opcional





Acero blanco perla

SALIDA HUMOS Ø 8 cm superior hembra		CÓDIGO	EUROS precios sin IVA	
Gotha70	Acero	 Blanco perla	813310	1.840
		 Tortora	813320	
		 Burdeos	813330	
		 Negro mate	813340	
DOTACIÓN				
Sistema Smart con Wi-Fi integrado		--	--	
OPCIONAL				
Radiomando RF Smart		1153710	140	



25

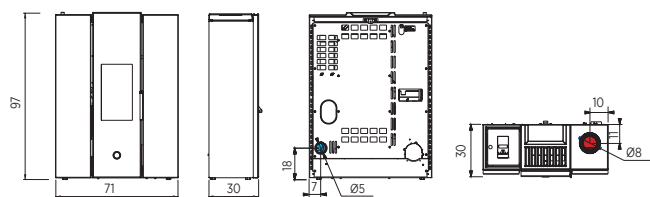

Ø8 F



/



105



71x30x97h



/



Acero blanco perla

CELL80+ canalizable



Apta para casas pasivas

Profundidad reducida (cm 30,5).

- Hogar de vermiculita
- Resistencia cerámica
- Salida de humos: Ø 8 cm superior, hembra Ø 8/13 cm coaxial (acero negro mate y blanco perla)
- 1 aire caliente canalizable posterior o lateral Ø 8 cm
- Ventilación aire caliente frontal
- Sistema Smart con Wi-Fi integrado
- Panel sinóptico superior
- Programación diaria/semanal
- Función EASY TIMER
- Función RELAX



Cell80+

2,8-7,7

90,5

200

0,6-1,8

8-25

15







V

opcional





Acero negro mate
(salida humos Ø 8/13 cm coaxial)

SALIDA HUMOS Ø 8 cm superior hembra			CÓDIGO	EUROS precios sin IVA
Cell80+	Acero	 Blanco perla	813350	2.050
		 Tortora	813360	
		 Burdeos	813370	
		 Negro mate	813380	
SALIDA HUMOS Ø 8/13 cm superior coaxial			CÓDIGO	EUROS precios sin IVA
Cell80+	Acero	 Blanco perla	813390	2.260
		 Negro mate	813400	
DOTACIÓN				
Sistema Smart con Wi-Fi integrado			--	--
OPCIONAL				
Radiomando RF Smart			1153710	140
KIT 12, canalización para un local contiguo (ver pág. 48)			778150	90
KIT 12 bis, canalización para un local distante (ver pág. 48)			778160	115
Rejas C4 9,3x9,3 cm raccord Ø 8 cm blanco mate (ver pág. 49)			1112270	50
Kit deflector aire (es obligatoria su compra para la instalación en el caso en que la estufa no viniera canalizada).			1155280	45



Salida humos Ø 8 cm superior

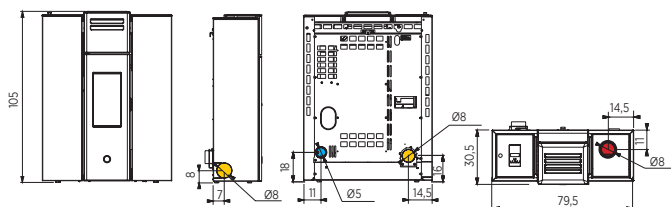

Salida humos Ø 8/13 cm superior coaxial

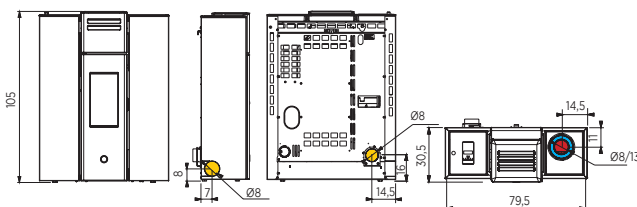

Ø8 F



/



125



79,5x30,5x105h



n°1
Ø 8 cm



/



Ø8/13



125



79,5x30,5x105h



n°1
Ø 8 cm



Acero tortora

ENTITY90+ canalizable



Apta para casas pasivas

Profundidad reducida (cm 31).







- Hogar de vermiculita
- Resistencia cerámica
- Salida de humos: Ø 8 cm superior, hembra Ø 8/13 cm coaxial (acero negro mate y blanco perla)
- 1 aire caliente canalizable posterior o lateral Ø 8 cm
- Ventilación aire caliente frontal
- Sistema Smart con Wi-Fi integrado
- Panel sinóptico superior
- Programación diaria/semanal
- Función EASY TIMER
- Función RELAX



Entity90+ 3,9-8,7 88,1 225 0,9-2,1 8-19 17 V opcional ● ● ● ● ● ● ● ● ● ●



Acero blanco perla
(salida humos Ø 8/13 cm coaxial)

SALIDA HUMOS Ø 8 cm superior hembra			CÓDIGO	EUROS precios sin IVA
Entity90+	Acero	 Blanco perla	813530	2.460
		 Tortora	813540	
		 Burdeos	813550	
		 Negro mate	813560	
SALIDA HUMOS Ø 8/13 cm superior coaxial			CÓDIGO	EUROS precios sin IVA
Entity90+	Acero	 Blanco perla	814050	2.720
		 Negro mate	814060	
DOTACIÓN				
Sistema Smart con Wi-Fi integrado			--	--
OPCIONAL				
Radiomando RF Smart			1153710	140
KIT 12, canalización para un local contiguo (ver pág. 48)			778150	90
KIT 12 bis, canalización para un local distante (ver pág. 48)			778160	115
Rejas C4 9,3x9,3 cm raccord Ø 8 cm blanco mate (ver pág. 49)			1112270	50
Kit deflector aire (es obligatoria su compra para la instalación en el caso en que la estufa no viniera canalizada).			1155280	45



29

Salida humos Ø 8 cm superior

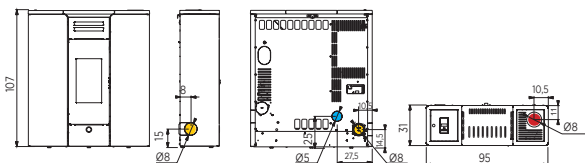

Salida humos Ø 8/13 cm superior coaxial

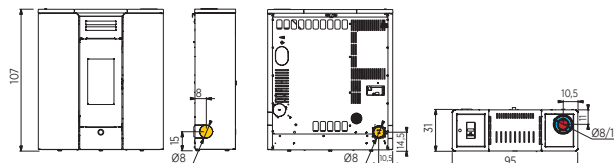

Ø 8 F



/



120



95x31x107h



n°1
Ø 8 cm



/



Ø 8/13



120



95x31x107h



n°1
Ø 8 cm



30



Cerámica negro mate

DUB100++ canalizable



Apta para casas pasivas profundidad reducida (cm 36).

- Hogar de vermiculita
- Resistencia cerámica
- Salida de humos: Ø 8 cm superior, hembra
- 2 salidas aire caliente canalizable posterior o lateral Ø 8 cm
- Ventilación aire caliente frontal
- Doble puerta fundición
- Sistema Smart con Wi-Fi integrado
- Panel sinóptico superior
- Programación diaria/semanal
- Función EASY TIMER
- Función RELAX



Dub100++

3,9-10,1

88,1

265

0,9-2,4

7-19

17

V

opcional





Cerámica burdeos

SALIDA HUMOS Ø 8 cm superior y posterior		CÓDIGO	EUROS precios sin IVA	
Maison80	cerámica	Tortora	813610	1.990
Maison80+			813640	2.190
Maison80		Cuero	813600	1.990
Maison80+			813630	2.190
Maison80		Burdeos	813590	1.990
Maison80+			813620	2.190
DOTACIÓN				
Sistema Smart con Wi-Fi integrado		--	--	
OPCIONAL				
Radiomando RF Smart		1153710	140	
KIT 12, canalización para un local contiguo (ver pág. 48) para Maison80+		778150	90	
KIT 12 bis, canalización para un local distante (ver pág. 48) para Maison80+		778160	115	
Rejas C4 9,3x9,3 cm raccord Ø 8 cm blanco mate (ver pág. 49)		1112270	50	
Kit deflector aire (Maison80+) (es obligatoria su compra para la instalación en el caso en que la estufa no viniera canalizada).		1155280	45	

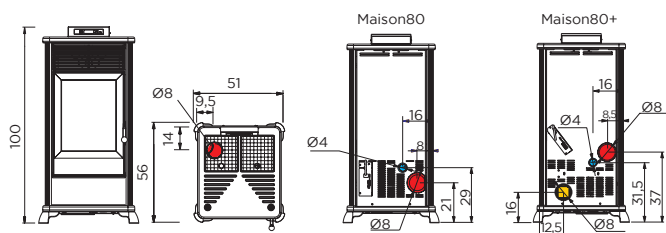

Ø8 M
Ø8 M

151
154

51x56x100h /
51x56x100h n°1 Ø 8 cm



Kit cajón de carga frontal

PELLEK80 EVO PELLEK110+ EVO canalizable



Hogar de pellet compacto, ideal para recuperar una chimenea antigua abierta o para realizar una nueva.

- Hogar de fundición
- Resistencia cerámica
- Salida humos Ø 8 cm superior, macho
- 1 salida aire de canalización Ø 6 cm (Pellek110+ Evo)
- Ventilación aire caliente frontal
- Sistema Smart con Wi-Fi integrado
- Panel sinóptico frontal
- Programación diaria/semanal
- Función EASY TIMER



Pellek80 Evo	3,8-8,1	91,2	210	1-1,9	6-11	11	G	opcional	●	●	●	●	●	●	●	/
Pellek110+ Evo	3,8-9,8	89,3	255	1-2,3	5-11	11	G	opcional	●	●	●	●	●	●	●	/



Kit cajón de carga frontal



Kit de carga superior con pendiente

SALIDA HUMOS Ø 8 cm superior		CÓDIGO	EUROS precios sin IVA
Estructura*	 Pellek80 Evo	813840	3.040
	Pellek110+ Evo	813830	3.250

*Es indispensable comprar una de las series abajo detalladas.

Kit cajón de carga frontal (completo con: cajón de doble guía y cornisa contorno boca)	1167410	285
Kit de carga superior con pendiente (completo con: cargador de trampilla con puerta abatible, y tubo flexible con brida, abrazaderas de fijación y cornisa contorno boca)	1167450	255

DOTACIÓN			
Sistema Smart con Wi-Fi integrado		--	--
OPCIONAL			
Radiomando RF Smart		1153710	140
Caballete para instalación como chimeneas		1011650	205
Para la canalización Pellek110+ Evo	Kit prolongación 3 metros tubo aislado Ø 6,5 cm	804280	70
	Rejas C5 raccord Ø 6 cm	1112260	50



Pellek80 Evo

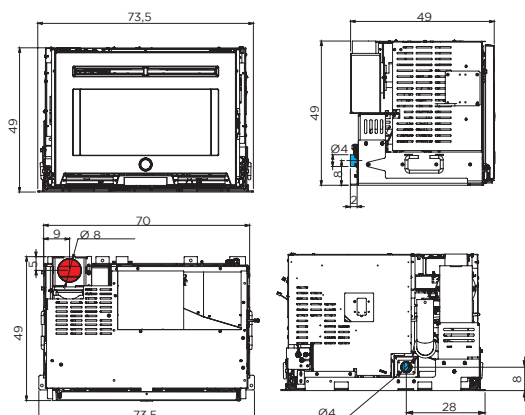

Pellek110+ Evo

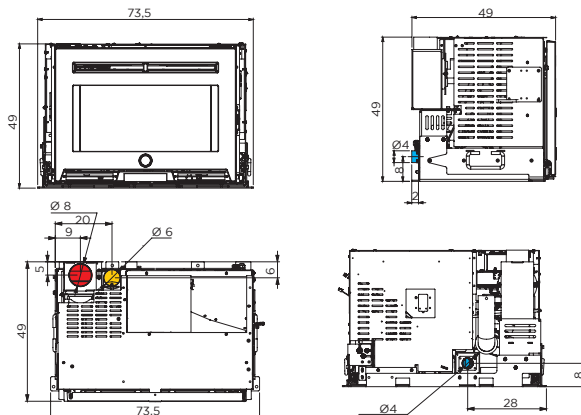

Ø 8 M 151 73,5x49x49 /
Ø 8 M 155 73,5x49x49 n°1 Ø 6 cm



Cerámica blanco crema

SPOT100 H SPOT100 H EVO



- Hogar de acero y vermiculita
- Salida humos Ø 8 cm posterior, macho superior y lateral izquierdo (kit opcional)
- Panel sinóptico superior
- Programación diaria/semanal





Spot100 H	3,8-10,1	6,5	91,2	265	0,9-2,3	6-16	14	A-V	●	●	●	●	●	●	●
*Spot100 H Evo	*3,8-10,1	*6,5	*91,2	*265	*0,9-2,3	*6-16	14	A-V	●	●	●	●	●	●	●



*producto en fase de certificación



Cerámica gris oscuro

SALIDA HUMOS Ø 8 cm posterior		CÓDIGO	EUROS precios sin IVA
Spot100 H	Cerámica	 Blanco crema	813710
		 Burdeos	813720
		 Gris oscuro	813730
			2.930

SPOT100 H EVO estará disponible SOLO hasta que se agoten las existencias de los códigos arriba detallados.

SALIDA HUMOS Ø 8 cm posterior		CÓDIGO	EUROS precios sin IVA
Spot100 H Evo	Cerámica	 Blanco crema	815670
		 Burdeos	815680
		 Gris oscuro	815690
			2.930

DOTACIÓN

Kit hidráulico incorporado con vaso de expansión cerrado, circulador y válvula de sobrepresión.	--	--
Telemando slim	--	--

OPCIONAL

KIT SALIDA HUMOS múltiple para instalación con salida superior o lateral (formado por 1 curva 90° con inspección, 1 brida de salida y tornillería)	684930	65
KIT *A2: Kit hidráulico pre-instalado	801170	930
KIT P: Kit hidráulico pre-instalado	1155270	980
Centralita con display (ver pág. 50) <i>comprar para kit P en caso de necesidad</i>	1156200	165
Accesorios para la instalación y producción de agua caliente sanitaria	ver pág. 51	

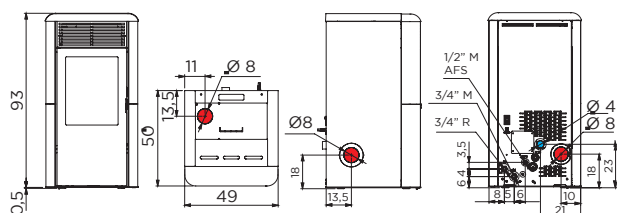

*Fin de existencias



Ø 8 M



150



49x50x93h



10





KAPPA200 KAPPA240 KAPPA270



- Hogar en acero y fundición
 - Salida humos Ø 8 cm posterior, macho
 - Doble puerta aislada
 - Depósito 60 kg/94 L
 - Panel sinóptico frontal
 - Programación diaria/semanal
- CLASE 5 según las normas EN 303-5.

Kappa200	21,5	6-20,1	93,5	525	1,3-4,5	13-46	60/94	G-A	●	●	●	●	●	●
Kappa240	25,8	6-24	92,9	625	1,3-5,4	11-46	60/94	G-A	●	●	●	●	●	●
Kappa270	29,2	6-27	92,5	705	1,3-6,1	10-46	60/94	G-A	●	●	●	●	●	●

SALIDA HUMOS Ø 8 cm posterior macho	CÓDIGO	EUROS precios sin IVA
Kappa200	813800	4.220
Kappa240	813810	4.390
Kappa270	813820	4.560
Para un correcto funcionamiento es indispensable la instalación de un kit abajo detallado.		
KIT R in producción de agua caliente sanitaria (ver pág. 50)	1015630	435
KIT RW con producción de agua caliente sanitaria (ver pág. 50)	1015640	625
KIT R2 sin producción de agua caliente sanitaria y separador instalación (ver pág. 50)	1015650	775
KIT RW2 con producción de agua caliente sanitaria y separador instalación (ver pág. 50)	1015660	970

DOTACIÓN		
Vaso de expansión cerrado	--	--
CABLE AZUL de conexión para termostato ambiente	--	--
OPCIONAL		
Válvula anticondensación	1095280	130
Accesorios	ver pág. 51	
Depósitos de acero y accesorios	ver pág. 50	

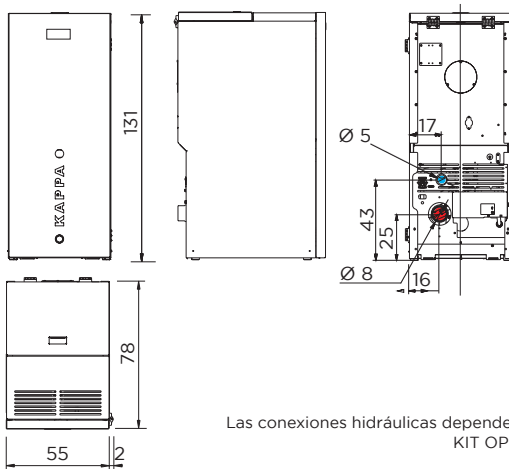

Las conexiones hidráulicas dependen de los
KIT OPCIONAL



Ø8 M	302	55x78x131 h	40
Ø8 M	335	55x78x131 h	40
Ø8 M	328	55x78x131 h	40



La leña entre tradición y modernidad.

Las **estufas y los hogares de leña** representan el perfecto encuentro entre tradición e innovación: **EK63** ofrece soluciones **de moderna concepción**, para ofrecer el máximo confort de uso y una combustión con el máximo equilibrio con el medio ambiente. **Las estufas** y los hogares de leña calientan con aire caliente el local de instalación; lo hogares pueden también canalizar el aire caliente en otros locales. La leña es la más importante fuente de **energía renovable**: durante la combustión, relanza la misma cantidad de CO₂ que produciría durante la natural descomposición en el terreno.



Estufas



**Fancy
Fancy Evo**
9/ 10,8 kW
p. 41



**Decor
Decor Evo**
7,2/7,5 kW
p. 42



**Decor C
Decor C Evo**
7,2/ 7,5 kW
p. 44

Chimeneas



Firek 1
15,2 kW
p. 46-47



Firek 2
15,2 kW
p. 46-47



Firek 3
15,2 kW
p. 46-47



Cerámica cuero

FANCY FANCY EVO



- Hogar de fundición
- Salida humos Ø 15 cm superior, macho (Fancy)
- Salida humos Ø 15 cm superior, hembra (Fancy Evo)
- Troncos de leña de hasta 40 cm en vertical
- Anillos extraíbles para calentar los platos

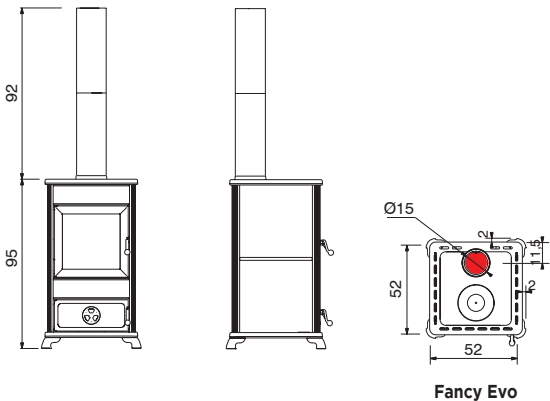

Fancy Evo

SALIDA HUMOS Ø 15 cm superior macho		CÓDIGO	EUROS precios sin IVA
Fancy	cerámica	Tortora	814250
		Cuero	813850
		Burdeos	813860
			1.360

La estructura FLEX estará disponible SOLO hasta que se agoten las existencias de los códigos arriba detallados

SALIDA HUMOS Ø 15 cm superior hembra		CÓDIGO	EUROS precios sin IVA
Fancy Evo	Estructura*	814860	1.400
*Es indispensable comprar una de las series abajo detalladas.			
Serie cerámica		Tortora	1153400
		Cuero	1153390
		Burdeos	1153380
DOTACIÓN			
2 tubos de 50 cm y Ø 15 cm		--	--



Fancy	9	78,3	235	2,5	G	Ø 15 M	147	52x52x95h
Fancy Evo	10,8	86,1	280	2,7	39x40x42	Ø 15 F	147	52x52x95h



42



cerámica tortora

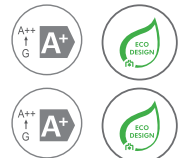

DECOR DECOR EVO

- Hogar de fundición
- Salida humos Ø 13 cm superior, macho (Decor)
- Salida humos Ø 15 cm superior, hembra (Decor Evo)
- Anillos extraíbles para calentar los platos
- Troncos de leña de hasta 33 cm en vertical



Decor	7,2	82,6	190	1,9	G
Decor Evo	7,5	86,5	195	1,9	33x30x33



SALIDA HUMOS Ø 13 cm superior macho			CÓDIGO	EUROS precios sin IVA
Decor	cerámica	Tortora 	814260	1.150
		Cuero 	813880	
		Burdeos 	813870	

La estructura FLEX estará disponible SOLO hasta que se agoten las existencias de los códigos arriba detallados

SALIDA HUMOS Ø 15 cm superior hembra		CÓDIGO	EUROS precios sin IVA
Decor Evo	 Estructura*	814870	1.180

*Es indispensable comprar una de las series abajo detalladas.

Serie cerámica	Tortora 	1153490	220
	Cuero 	1153480	
	Burdeos 	1153470	

DOTACIÓN

2 tubos de 50 cm y Ø 15 cm

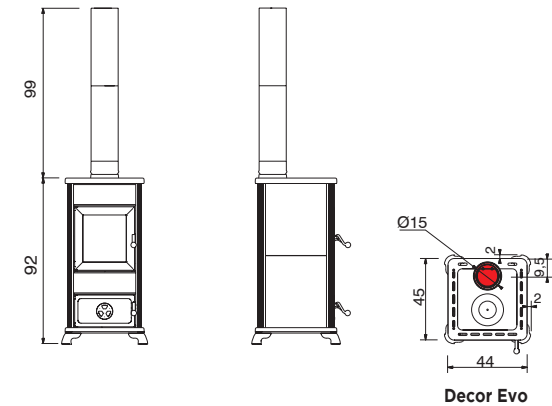

Decor Evo



Ø13 M
Ø15 F



109
109



44x45x92h
44x45x92h



cerámica burdeos

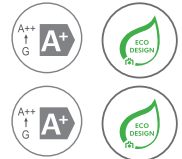

DECOR C DECOR C EVO



- Hogar de fundición
- Salida humos Ø 13 cm superior, macho (Decor C)
- Salida humos Ø 15 cm superior, hembra (Decor C Evo)
- Anillos extraíbles para calentar los platos
- Troncos de leña de hasta 33 cm en vertical
- Horno, en acero inoxidable, dimensiones internas cm 27x30x24h



Decor C	7,2	82,6	190	1,9	G
Decor C Evo	7,5	86,5	195	1,9	33x30x33

SALIDA HUMOS Ø 13 cm superior macho			CÓDIGO	EUROS precios sin IVA
Decor C	cerámica	Tortora 	814270	1.570
		Cuero 	813900	
		Burdeos 	813890	

La estructura FLEX estará disponible SOLO hasta que se agoten las existencias de los códigos arriba detallados

SALIDA HUMOS Ø 15 cm superior hembra			CÓDIGO	EUROS precios sin IVA
Decor C Evo	 Estructura*		814880	1.530

*Es indispensable comprar una de las series abajo detalladas.

Serie cerámica	Tortora 	1153550	350
	Cuero 	1153540	
	Burdeos 	1153530	

DOTACIÓN

2 tubos de 50 cm y Ø 15 cm

--

--

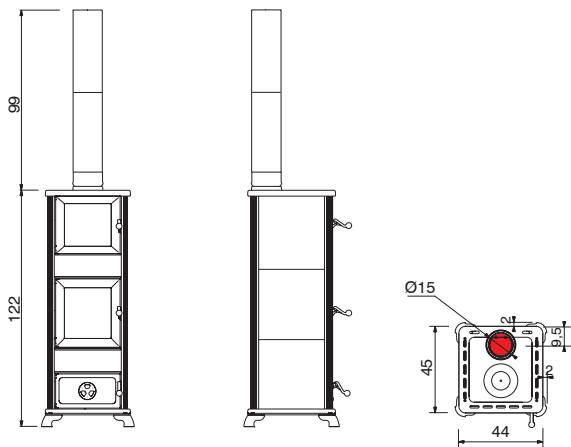

Decor C Evo



Ø13 M
Ø15 F



134
134



44x45x122h
44x45x122h



Firek 1
Frontal



Firek 2
Lateral de vidrio L - izquierdo



Firek 3
Prismático



Firek 2
Lateral de vidrio R - derecho

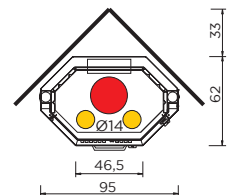
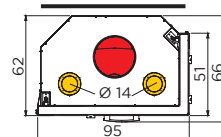
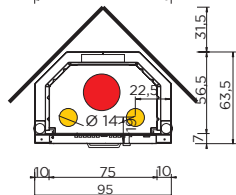
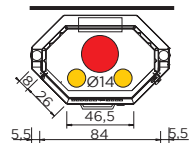
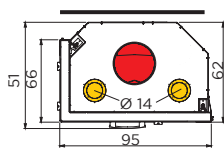
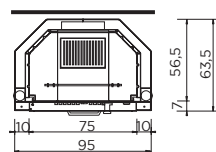
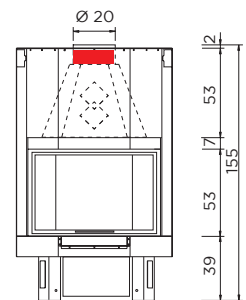
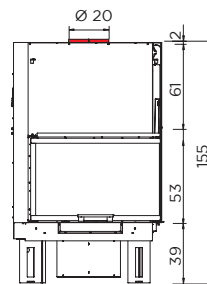
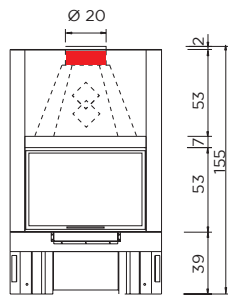



FIREK 1 Frontal
FIREK 2 Lateral de vidrio
FIREK 3 Prismático

- Hogar de fundición y acero
- Salida humos superior Ø 20 cm, hembra
- 2 salidas aire caliente canalizable superior Ø 14 cm
- Post combustión
- **Firek 1:** disponible versión N (convección natural) y versión V (Ventilación forzada), completo con: centralita electrónica "touchscreen" y telemando
- **Firek 2-3:** disponible versión V (Ventilación forzada), completo con: centralita electrónica "touchscreen" y telemando



	kW	%	m ³	Kg/h	A-G	Ø	Kg	cm	V
Firek 1	15,2	78	395	4,2	75x48x50	Ø 20 F	251	95x63,5x155	nº2 Ø 14
Firek 2	15,2	78	395	4,2	78x48x54	Ø 20 F	252	95x66x155h	nº2 Ø 14
Firek 3	15,2	78	395	4,2	75x48x50	Ø 20 F	243	95x62x155h	nº2 Ø 14

PRODUCTOS	VERSIÓN	CÓDIGO	EUROS precios sin IVA
Firek 1 frontal	NEW N	813910	2.390
	V	813920	2.690
Firek 2 lateral de vidrio	R derecho	V 813940	2.960
	L izquierdo	V 813960	
Firek 3 prismático	V	813980	2.890
OPCIONAL			
Soporte campana	Firek 1		248000
	Firek 2	R derecho	1082990
		L izquierdo	1083000
Firek 3		218260	
Marco contorno boca	Firek 1		1100420
	Firek 2	R derecho	1100600
		L izquierdo	1100430
Firek 3		1100440	
KIT UNO/ Bis Canalización aire caliente en el local de la instalación (ver pág. 48)	aluminio	112830	185
	blanco mate	1112330	220
KIT DUE/ Bis Canalización aire caliente en el local de la instalación + 1 local adyacente (ver pág. 48)	aluminio	112850	220
	blanco mate	1112350	245
KIT TRE/bis Canalización aire caliente en el local de la instalación + 2 locales adyacentes (ver pág. 48)	aluminio	112870	235
	blanco mate	1112370	255
Tubo aluminio Ø14 cm para canaliz. aire caliente	1,5 m	76770	30
	3 m	76790	40
Tubo aluminio Ø20 cm para toma aire exterior	1,5 m	149210	35
	3 m	149230	55

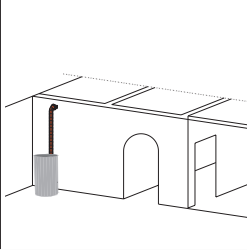
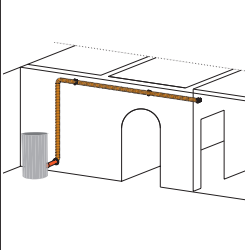
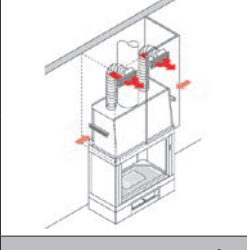
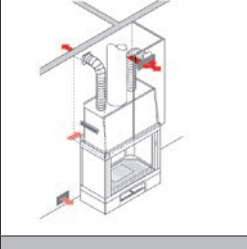
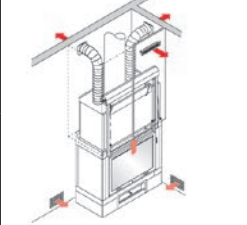

KIT PARA CANALIZACIÓN AIRE CALIENTE

					CÓDIGO	EUROS precios sin IVA
KIT CANALIZACIÓN PARA UN LOCAL CONTIGUO, PARA USO DE UNA SOLA SALIDA						
	KIT 12 compuesto por: 1 ud. tubo Ø 8 cm, longitud máx 3 m; 1 ud. boca terminal; 2 ud. abrazaderas bloqueo tubos.	Berry90+, Cell80+, Daily130++, Dub100++, Entity90+, Maison80+, Metro110+, Pellek110+ Evo, Spy110+, Tweed90+, Yung130++. Brand Italiana Camini: Classica Plus, Layma2 Evo, Piro9+ Evo, Piro2 Plus, Point Plus.	778150	90		
KIT CANALIZACIÓN PARA UN LOCAL DISTANTE, PARA USO DE UNA SOLA SALIDA						
	KIT 12 bis compuesto por: 1 ud. tubo Ø 8 cm, longitud máx 6 m; 1 ud. boca terminal; 2 ud. abrazaderas bloqueo tubos.	Berry90+, Cell80+, Daily130++, Dub100++, Entity90+, Maison80+, Metro110+, Pellek110+ Evo, Spy110+, Tweed90+, Yung130++. Brand Italiana Camini: Classica Plus, Layma2 Evo, Piro2 Plus, Piro9+ Evo, Point Plus.	778160	115		
					CÓDIGO	EUROS precios sin IVA
KIT CANALIZACIÓN AIRE CALIENTE en el LOCAL de la INSTALACIÓN (2 SALIDAS AIRE)						
	KIT UNO/bis Compuesto por: 2 ud. tubos flexibles aluminio Ø 14 cm longitud ml. 1,5. 4 ud. abrazaderas Ø 14 cm 2 ud. rejas (B2) con marco, rejilla y conector.	aluminio	Firek 1, Firek 2, Firek 3 Brand Italiana Camini:	112830	185	
		blanco mate	IC Tekno 2, IC Tekno 3	1112330	220	
KIT CANALIZACIÓN AIRE CALIENTE en el LOCAL de la INSTALACIÓN + 1 LOCAL ADYACENTE (2 SALIDAS AIRE)						
	KIT DUE/bis Compuesto por: 2 ud. tubos flexibles aluminio Ø 14 cm longitud ml. 1,5. 4 ud. abrazaderas Ø 14 cm 1 ud. reja B1: marco, rejilla, registro regulable y conector. 1 ud. reja B3: marco, rejilla, registro regulable y conector.	aluminio	Firek 1, Firek 2, Firek 3 Brand Italiana Camini:	112850	220	
		blanco mate	IC Tekno 2, IC Tekno 3	1112350	245	
KIT CANALIZACIÓN AIRE CALIENTE en el LOCAL de la INSTALACIÓN + 2 LOCALES ADYACENTES (2 SALIDAS AIRE)						
	KIT TRE/bis Compuesto por: 2 ud. tubos flexibles aluminio Ø 14 cm longitud ml. 1,5. 4 ud. abrazaderas Ø 14 cm 2 ud. rejas B3: marco, rejilla, registro regulable y conector. 1 ud. ranura G1 para montar en la base campana.	aluminio	Firek 1, Firek 2, Firek 3 Brand Italiana Camini:	112870	235	
		blanco mate	IC Tekno 2, IC Tekno 3	1112370	255	

REJAS envío aire caliente					CÓDIGO	EUROS precios sin IVA
C1 raccordo Ø 14 cm		con marco, rejilla (1), registro regulable (2), conector (R1)	37x12 cm	Blanco mate	1112280	125
C3 raccordo Ø 14 cm			22x12 cm	Blanco mate	1112290	100
C4 raccordo Ø 8 cm			9,3x9,3 cm	Blanco mate	1112270	50
C5 raccordo Ø 6 cm			9,3x9,3 cm	Blanco mate	1112260	50

REJAS - GRILLE				CÓDIGO	EUROS	CÓDIGO	EUROS
REJAS envío aire caliente 	B1 con marco, rejilla (1), registro regulable (2), conector (R1)	36x9 cm	aluminio	54210	80	54190	430
			blanco mate	1112100	95	1112180	520
	B3 ídem c.s.	18x9 cm	aluminio	86270	70	86280	375
			blanco mate	1112110	75	1112190	405
	B2 ídem c.s.	36x9 cm	aluminio	83560	60	83570	295
			blanco mate	1112120	70	1112200	385
B4 ídem c.s.	18x9 cm	aluminio	86300	55	86310	280	
		blanco mate	1112130	60	1112210	310	
REJAS toma aire exterior 	G1 para toma aire en soporte campana, con marco	36x3 cm	aluminio	54230	35	54240	165
			blanco mate	1112140	45	1112220	225
	G9 ídem c.s.	18x3 cm	aluminio	89360	35	89370	140
			blanco mate	1112150	35	1112230	160
	G4 ídem c.s.	36x9 cm	aluminio	83590	45	83600	200
			blanco mate	1112160	55	1112240	280
	G7 ídem c.s.	18x9 cm	aluminio	86330	40	86340	165
			blanco mate	1112170	45	1112250	195
REJAS aire exterior 	G5	24x16 cm	aluminio	83060	40	83070	155
	G6	36x16 cm	aluminio	83090	40	83100	165
		25x25 cm	aluminio	4180	40	5580	180

CONECTORES - REDUCCIONES					
CONECTORES Y REDUCCIONES	R1 para conectar tubos flexibles Ø 14 a las Rejas envío		unidad	54360	30
			pack de 6 piezas	54370	125
	R2 para conectar tubos flexibles Ø 14 a la chimena para kit 1-2-3-4-5		unidad	4400	20
			pack de 6 piezas	54390	45









	CÓDIGO	EUROS precios sin IVA
KIT PARA INSTALACIÓN ÚNICA FUENTE DE CALOR SIN PRODUCCIÓN DE AGUA CALIENTE SANITARIA.		
Kit R para Kappa200, Kappa240, Kappa270 Compuesto por: circulador alta eficiencia, válvula carga, válvula descarga, válvula de seguridad, presostato agua, conexión para manómetro incorporado en la termo-estufa, conexión a vaso de expansión incorporado.	1015630	435
KIT PARA INSTALACIÓN ÚNICA FUENTE DE CALOR CON PRODUCCIÓN INSTANTÁNEA DE AGUA CALIENTE SANITARIA.		
Kit RW para Kappa200, Kappa240, Kappa270 Compuesto por: circulador de alta eficiencia, conexión para manómetro incorporado en la termo-estufa/ caldera, conexión para vaso de expansión incorporado en la termo-estufa/ caldera, válvula de carga, presostato agua, válvula de seguridad, intercambiador, válvula de descarga, fluxostato, válvula de 3 vías motorizada, válvula bypass.	1015640	625
KIT PARA INSTALACIÓN COMBINADO CON CALDERA DE GAS Y SEPARADOR INSTALACIÓN SIN PRODUCCIÓN DE AGUA CALIENTE SANITARIA.		
Kit R2 para Kappa200, Kappa240, Kappa270 Compuesto por: circulador alta eficiencia, válvula carga, válvula descarga, válvula de seguridad, presostato agua, conexión para manómetro incorporado en la termo-estufa, conexión a vaso de expansión incorporado, intercambiador para separación de instalación.	1015650	775
KIT PARA INSTALACIÓN COMBINADO CON CALDERA DE GAS Y SEPARADOR INSTALACIÓN CON PRODUCCIÓN DE AGUA CALIENTE SANITARIA.		
Kit RW2 para Kappa200, Kappa240, Kappa270 Compuesto por: circulador de alta eficiencia, conexión para manómetro, conexión para vaso de expansión, válvula de carga, presostato agua, válvula de seguridad, intercambiador para producción de agua caliente sanitaria, válvula de descarga, fluxostato, válvula de 3 vías motorizada, válvula bypass, intercambiador para separación de la instalación.	1015660	970
KIT PARA INSTALACIÓN ÚNICA FUENTE DE CALOR SIN PRODUCCIÓN DE AGUA CALIENTE SANITARIA.		
Kit R-FX - Brand Italiana Camini: Layma2 Idro 18, Layma2 Idro 22 Compuesto por: circulador de alta eficiencia, conexión para manómetro incorporado en la termo-estufa/ caldera, conexión para vaso de expansión incorporado en la termo-estufa/caldera, válvula de carga, presostato agua, válvula de seguridad, intercambiador, válvula de descarga, fluxostato, válvula de 3 vías motorizada, válvula bypass.	1106770	480
KIT PARA INSTALACIÓN ÚNICA FUENTE DE CALOR CON PRODUCCIÓN INSTANTÁNEA DE AGUA CALIENTE SANITARIA.		
Kit RW-FX - Brand Italiana Camini: Layma2 Idro 22 Compuesto por: circulador de alta eficiencia, conexión para manómetro incorporado en la termo-estufa/ caldera, conexión para vaso de expansión incorporado en la termo-estufa/ caldera, válvula de carga, presostato agua, válvula de seguridad, intercambiador, válvula de descarga, fluxostato, válvula de 3 vías motorizada, válvula bypass.	1106780	675
KIT PARA INSTALACIÓN COMBINADO CON CALDERA DE GAS Y SEPARADOR INSTALACIÓN SIN PRODUCCIÓN DE AGUA CALIENTE SANITARIA.		
Kit R2-FX- Brand Italiana Camini: Layma2 Idro 18, Layma2 Idro 22 Compuesto por: circulador de alta eficiencia, válvula de carga, válvula de descarga, válvula de seguridad, presostato agua, conexión para manómetro incorporado en la termo-estufa/ caldera, conexión para vaso de expansión incorporado, intercambiador para separación de la instalación.	1106790	985
KIT PARA INSTALACIÓN TERMO-ESTUFA, CALDERA Y TERMO-CHIMENEA DE PELLET EN COMBINACIÓN CON CALDERA DE GAS (IDEAL PARA SEPADOR INSTALACIONES)		
*Kit A2 para Spot100 H, Spot100 H Evo - Brand Italiana Camini: Idropoint2, Idropoint H 10 Evo, Dida Idro Compuesto por: intercambiador 30 láminas, circulador instalación, 2 purgadores, válvula de seguridad, display remoto para gestión temperatura.	801170	930
Kit P Compuesto por: intercambiador 34 láminas, circulador instalación, 2 purgadores, centralita con display opcional (ver cod. 1156200)	1155270	980
Centralita con display (para Kit P)	1156200	165

*Fin de existencias

ACCESORIOS

PARA PRODUCTOS DE AGUA





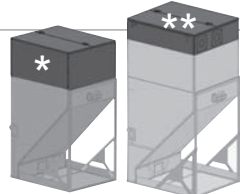

			CÓDIGO	EUROS precios sin IVA
	Válvula de 3 vías 1" F		1033070	175
	Válvula de seguridad 1/2"		281710	30
	Válvula salida aire 3/8"		284150	25
	Válvula descarga térmica 3/4"		72940	70
	Fluxostato para agua sanitaria 1/2"		220830	85
	Tramo tubo con registro Ø 25 cm		262920	90
	Intercambiador a	20 láminas	262570	100
		30 láminas	671810	195
	Intercambiador 3 vías		638100	270





		CÓDIGO	EUROS precios sin IVA
DEPÓSITO DE ACERO (SIN CÓCLEA Y MOTOR) PARA COMBINAR A LA CÓCLEA			
	Depósito 250 kg/385 L con estructura de acero predisposición para la carga automática	758900	1.310
	Depósito 500 kg/769 L con estructura de acero predisposición para la carga automática	758910	1.840
	***Kit con capacidad 300 kg/462 L para transformación depósito de 500 a 800 kg (*) / de 769 a 1.231 L (*)	683000	250
	***Kit con capacidad 200 kg/308 L para transformación depósito de 800 a 1000 kg (**) / de 1.231 a 1.538 L (**)	745040	235

***componentes y ejemplo utilizando 2 KIT, hasta una capacidad máxima de 1.000 kg/1.538 L

ATENCIÓN: combinar siempre el depósito con una de las cócleas

SISTEMAS MECÁNICOS PARA ALIMENTACIÓN PELLET (la medida indicada es del centro depósito a conexión caldera)			
	Cóclea de 100 cm con motor y accesorios	1004440	610
	Cóclea de 150 cm con motor y accesorios	683010	660
	Cóclea de 300 cm con motor y accesorios	683020	790
	Cóclea de 500 cm con motor y accesorios	683030	955
	Kit collar para suspensión cóclea a techo (incluidos tirantes)	748060	45

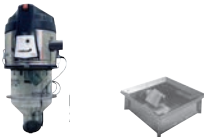
SILOS REMOTOS DE TEJIDO			
	Silos almacenamiento pellet (capacidad de 2,1 a 3,2 t) (A)	682860	3.040
	Silos almacenamiento pellet (capacidad de 4,2 a 6,7 t)	682870	3.900

SISTEMAS NEUMÁTICOS PARA ALIMENTACIÓN PELLET			
	Sistema neumático para transporte pellet, a colocar sobre la caldera	1058160	2.835
	Unidad para la extracción y aspiración, a colocar debajo del silo (mecánico sin motor ni cóclea)	1058170	565
	Kit Rejas para relleno con accesorios - SISTEMA STORTZ	682880	485
	Kit Rejas para relleno con accesorios - SISTEMA GUILLEMIN (sistema francés)	752940	515

SISTEMA DE ALIMENTACIÓN

Almacenaje y cargo combinables con las calderas de pellet

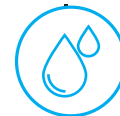

A CÓCLEA



Longitudes cócleas con motor y accesorios



Depósitos en acero con cargador de cóclea.



250 kg/385 L
cm 60x67x132 h



500 kg/769 L
cm 90x110x140 h

KIT para aumentar la capacidad del depósito de 500 kg/769 L

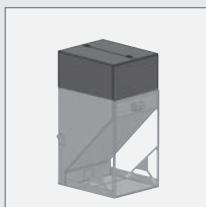

KIT con la capacidad 300 kg/462 L (de 500kg/769L a 800 kg/1,231 L)



KIT con la capacidad 200 kg / 308 L (de 800kg /1.231 L a 1000 kg/1538 L)

NEUMÁTICO



Silos en tejido equipados con rejillas y unidades de extracción*

2 modelos con capacidad de:
- da 2,1 a 3,2 t cm 170x170x180/250 h
- da 4,2 a 6,7 t cm 250x250x180/250 h



Ejemplo de aprovisionamiento de pellet mediante camión cisterna



Aparato alimentador**

Longitud máxima conductos 10 m
Desnivel máximo de transporte 3 m

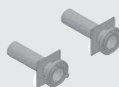

Sistema GUILLEMIN
Sistema STORTZ

TUBO DOBLE PARED INTERNA EN INOX AISLADOS para EXTERIOR

Pared externa en **ALUMINIO PINTADO MARRÓN** Ø 10 cm - pared interna en **inox** aisl. 316/L Ø cm 8

54

		CÓDIGO	EUROS precios sin Iva	COMP. NÚMERO DE PIEZAS	
<p>ESQUEMA INSTALACIÓN BASE</p> <p>Q I₂ (cm 50) N I₃ (cm 100) O V</p>	tubo	25 cm	606280	50	1
		50 cm	606290	65	1
		100 cm	606300	95	1
	codo	45°	606310	90	1
		90°	606320	165	1
	anillo para fijación a pared (N)		606340	25	1
	abrazadera (T)		606410	25	1
	soporte a pared (V)		606360	130	1
	tubo a T (O)		606350	150	1
	tapón con descarga condensación		606370	50	1
teja con casquete inferior y casquete superior (U)		RFIN100	130	1/1	
terminal descarga humos (Q)		606390	65	1	

Pared externa en **COBRE** Ø 10 cm - pared interna en **inox** aisl. 316/L Ø cm 8

<p>ESQUEMA INSTALACIÓN BASE</p> <p>Q I₂ (cm 50) N I₃ (cm 100) O V</p>	tubo	(I ₁) 25 cm	RDBAS200/80	65	1
		(I ₂) 50 cm	RDBAS450/80	85	1
		(I ₃) 100 cm	RDBAS950/80	140	1
	codo	(L ₁) 45°	RDC45/80	115	1
		(L ₂) 90°	RDC90/80	150	1
	anillo para fijación a pared (N)		RFIS100	25	1
	abrazadera (T)		RDFAS80	25	1
	soporte a pared (V)		RMEN80	180	1
	tubo a T (O)		RDT90/80	210	1
	tapón con descarga condensación		RDTAP80	70	1
terminal descarga humos (Q)		RDBOT80	80	1	

ACCESORIOS TUBO

MONOPARED INOX PARA INTERIOR

Monopared en INOX aisi 316/L PINTADO NEGRO Ø 8 cm - con juntas

		CÓDIGO	EUROS precios sin IVA	COMP. NÚMERO DE PIEZAS	
	tubo	(A ₁) 25 cm	EBAS200/80N	40	4
		(A ₂) 50 cm	EBAS450/80N	40	9
		(A ₃) 100 cm	EBAS950/80N	55	9
		150 cm	EBAS1450/80N	75	6
	Separador de cámara con protección térmica NO sobreponibles	150 cm	EBAS1450/80NPT	135	4
	codo	(B ₁) 45°	EC45/80N	50	6
		(B ₂) 90°	EC90/80N	60	6
	rosetón a pared (C)		EROS80N	30	10
	anillo para fijación a pared (D)		EFIS80N	25	10
	tubo a T macho (E)		ET90/80N	70	4
tubo a T hembra (E)		ETF90/80N	70	4	
tapón sin descarga condensación (F)		ETAP80N	40	1	
sombrero protege lluvia (G)		EPAR80N	90	5	
doble tubo hembra (H)		EDFF80N	45	6	
terminal descarga humos		ESCAR80N	45	4	

Monopared en INOX aisi 316/L INOX Ø 8 cm - con juntas

	tubo	(A ₁) 25 cm	EBAS200/80	30	9
		(A ₂) 50 cm	EBAS450/80	35	9
		(A ₃) 100 cm	EBAS950/80	45	9
	codo	(B ₁) 45°	EC45/80	40	4
		(B ₂) 90°	EC90/80	50	4
	rosetón a pared (C)		EROS80	25	1
	anillo para fijación a pared (D)		EFIS80	25	10
	tubo a T macho (E)		ET90/80	60	4
	tubo a T hembra (E)		ETF90/80	60	4
	tapón sin descarga condensación (F)		ETAPSSC80	40	10
sombrero protege lluvia (G)		EPAR80	55	5	
doble tubo hembra (H)		EDFF80	35	6	
abrazadera		EFAS80	20	10	

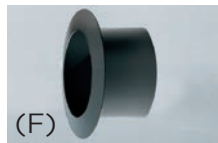





**Ø 15 cm para Fancy - Fancy Evo
Decor Evo -Decor C Evo**

		gris		negro	
		CÓDIGO	EUROS precios sin IVA	CÓDIGO	EUROS precios sin IVA
tubo con codo a 90° con inspección y registro (B)		204490	140	112220	140
tubo (C)	25 cm	204500	35	112230	35
	50 cm	204510	45	112240	45
	100 cm	204520	60	112250	60
tubo con registro (A)	30 cm	204530	45	112260	45
kit anticondensación (I)		204540	40	174300	40
rosetón fijo a pared (F)		204550	45	113750	45
rosetón telescópico (G)		204560	100	174290	100
rosetón para codo (H)	45°	292590	90	292600	90
codo con inspección (D/E)	45°	204570	60	112270	60
	90°	204580	65	112280	65

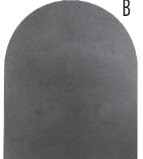
Ø 13 cm para Decor - Decor C

		gris		negro	
		CÓDIGO	EUROS precios sin IVA	CÓDIGO	EUROS precios sin IVA
tubo con registro (A)	30 cm	170360	45	204430	45
tubo con codo a 90° con inspección y registro (B)		170340	135	204390	135
codo con inspección (D/E)	45°	170370	55	204470	55
	90°	170380	65	204480	65
tubo (C)	25 cm	170310	35	204400	35
	50 cm	170320	45	204410	45
	100 cm	170330	60	204420	60
rosetón fijo a pared (F)		170350	45	204450	45
rosetón telescópico (G)		174800	95	204460	95
rosetón para codo (H)	45°	241810	90	241820	90
kit anticondensación (I)		174780	40	204440	40

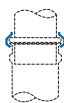
			CÓDIGO	EUROS precios sin IVA
 A  B  C	Glasskamin (A)	limpia cristales cerámicos 12 botellas de 75 cl	155240	140
	Placa de acero para suelo (B)	100x120 cm	112700	260
	Placa de cristal para suelo espesor 8 mm (C)	80x80 cm	784420	140
	Botes de pintura	para chimeneas parte interna gris antracita	693840	30
	para chimeneas parte externa negro	935514	25	

 	Abrazadera canalización rígida monopared EFAS	Ø 20 cm	EFAS200	20
		Ø 16 cm	ERFL160	35
	Conector a tubo flexible DOBLE PARED ERFL para chimeneas con salida humos hembra	Ø 20 cm	ERFL200	35
		Ø 22 cm	ERFL220	35
		Ø 25 cm	ERFL250	40

	Reducciones acero inox para chimeneas	de Ø 25 a Ø 22 cm	ERID-MF250/220	75
--	---------------------------------------	-------------------	----------------	----





Berry90+	•	•	nº 1	•	R opcional	•	•	•	•	•	•	•	/
Cell80+	•	•	nº 1	•	R opcional	•	•	•	•	•	•	•	/
Daily130++	•	•	nº 2	•	R opcional	•	•	•	•	•	•	•	/
Decor Evo	/	/	/	/	/	/	/	/	/	/	/	/	/
Decor C Evo	/	/	/	/	/	/	/	/	/	/	/	/	/
Decor Decor C	/	/	/	/	/	/	/	/	/	/	/	/	/
Dub100++	•	•	nº 2	•	R opcional	•	•	•	•	•	•	•	/
Entity90+	•	•	nº 1	•	R opcional	•	•	•	•	•	•	•	/
Fancy Evo	/	/	/	/	/	/	/	/	/	/	/	/	/
Fancy	/	/	/	/	/	/	/	/	/	/	/	/	/
Firek 1	/	/	nº 2	/	/	/	/	/	/	/	/	/	/
Firek 2	/	/	nº 2	/	/	/	/	/	/	/	/	/	/
Firek 3	/	/	nº 2	/	/	/	/	/	/	/	/	/	/
Gotha70	•	•	/	•	R opcional	•	•	•	•	•	•	•	/
Kappa200	/	/	/	•	/	•	•	•	•	•	/	/	/
Kappa240	/	/	/	•	/	•	•	•	•	•	/	/	/
Kappa270	/	/	/	•	/	•	•	•	•	•	/	/	/
Like80	•	•	/	•	R opcional	•	•	•	•	•	•	•	/
Maison80	/	/	/	•	R opcional	•	•	•	•	•	•	•	/
Maison80+	/	/	nº 1	•	R opcional	•	•	•	•	•	•	•	/
Metro110+	•	•	nº 1	•	R opcional	•	•	•	•	•	•	•	/
Pellek110+ Evo	/	/	nº 1	•	R opcional	•	•	•	•	•	/	•	/
Pellek80 Evo	/	/	/	•	R opcional	•	•	•	•	•	/	•	/
Spot100 H *Spot100 H Evo	/	/	/	•	T	•	•	•	•	•	/	/	/
Spy110+	•	•	nº 1	•	R opcional	•	•	•	•	•	•	•	/
Tweed90+	•	•	nº 1	•	R opcional	•	•	•	•	•	•	•	/
Yung130++	•	•	nº 2	•	R opcional	•	•	•	•	•	•	•	/
Zone80	•	•	/	•	R opcional	•	•	•	•	•	•	•	/

* producto en fase de certificación



Berry90+	/	3,4-9,2	/	90,9	240	0,8-2,1	10-25	20	V	/	46x49x104h	125	Ø8 ↗	Ø8/12,5 opcional
Cell80+	/	2,8-7,7	/	90,5	200	0,6-1,8	8-25	15	V	/	79,5x30,5x105h	125	Ø8 ↑	Ø8/13
Daily130++	/	3,7-12,5	/	90,2	325	0,8-2,9	8-29	23	V	/	63x61x120h	210	Ø8 ↗	Ø8/12,5 opcional
Decor Evo	/	7,5	/	86,5	195	1,9	/	/	G	/	44x45x92h	109	Ø15 ↑	/
Decor C Evo	/	7,5	/	86,5	195	1,9	/	/	G	/	44x45x122h	134	Ø15 ↑	/
Decor Decor C	/	7,2	/	82,6	190	1,9	/	/	G	/	44x45x92h 44x45x122h	109 134	Ø13 ↑	/
Dub100++	/	3,9-10,1	/	88,1	265	0,9-2,4	7-19	17	V	/	95x36x112h	155	Ø8 ↑	/
Entity90+	/	3,9-8,7	/	88,1	225	0,9-2,1	8-19	17	V	/	95x31x107h	120	Ø8 ↑	Ø8/13
Fancy Evo	/	10,8	/	86,1	280	2,7	/	/	G	/	52x52x95h	147	Ø15 ↑	/
Fancy	/	4,4-9	/	78,3	235	1,2-2,5	/	/	G	/	52x52x95h	147	Ø15 ↑	/
Firek 1	/	15,2	/	78	395	4,2	/	/	A-G	/	95x63,5x155h	248	Ø20 ↑	/
Firek 2	/	15,2	/	78	395	4,2	/	/	A-G	/	95x66x155h	248	Ø20 ↑	/
Firek 3	/	15,2	/	78	395	4,2	/	/	A-G	/	95x62x155h	238	Ø20 ↑	/
Gotha70	/	2,7-6,7	/	88,4	175	0,6-1,6	8-20	12	V	/	71x30x97h	105	Ø8 ↑	/
Kappa200	21,5	/	6-20,1	93,5	525	1,3-4,5	13-46	60 kg 94 l	A-G	40	55x78x131h	302	Ø8 ↗	/
Kappa240	25,8	/	6-24	92,9	625	1,3-5,4	11-46	60 kg 94 l	A-G	40	55x78x131h	335	Ø8 ↗	/
Kappa270	29,2	/	6-27	92,5	705	1,3-6,1	10-46	60 kg 94 l	A-G	40	55x78x131h	328	Ø8 ↗	/
Like80	/	3,4-7,6	/	90,8	200	0,8-1,7	9-19	15	V	/	52x52x101h 52x58x101h	90/120	Ø8 ↗	Ø8/13
Maison80	/	2,5-8,2	/	88,7	215	0,6-1,9	8-25	15	V	/	51x56x100h	151	Ø8 ↗	/
Maison80+	/	2,5-8	/	91,5	210	0,6-1,8	8-25	15	V	/	51x56x100h	154	Ø8 ↗	/
Metro110+	/	3,7-10,5	/	91,9	275	0,8-2,4	10-29	23	V	/	54x56x117h	160	Ø8 ↗	Ø8/12,5 opcional
Pellek110+ Evo	/	3,8-9,8	/	89,3	255	1-2,3	5-11	11	G	/	73,5x49x49h	155	Ø8 ↑	/
Pellek80 Evo	/	3,8-8,1	/	91,2	210	1-1,9	6-11	11	G	/	73,5x49x49h	151	Ø8 ↑	/
Spot100 H *Spot100 H Evo	/	3,8-10,1 *3,8-10,1	6,5 *6,5	91,2 *91,2	265 *265	0,9-2,3 *0,9-2,3	6-16 *6-16	14	A-V	10	49x50x93h	150	Ø8 ↗	/
Spy110+	/	3,7-10,5	/	91,9	275	0,8-2,4	9-28	22	V	/	55x56x121h	130	Ø8 ↗	Ø8/12,5 opcional
Tweed90+	/	3,4-9,2	/	90,9	240	0,8-2,1	7-19	15	V	/	50x50x101h	95	Ø8 ↗	Ø8/12,5 opcional
Yung130++	/	3,7-12,5	/	90,2	325	0,8-2,9	8-28	22	V	/	54x57x122h	155	Ø8 ↗	Ø8/12,5 opcional
Zone80	/	3,4-7,6	/	90,8	200	0,8-1,7	9-19	15	V	/	46x49x95h	95	Ø8 ↗	Ø8/12,5 opcional

* producto en fase de certificación

		ACERO				CRISTAL	
		Blanco perla	Tortora	Burdeos	Negro mate	Blanco	Negro
Berry90+	↗ Ø8	/	/	/	/	/	/
Cell80+	↑ Ø8	○	●	●	●	/	/
	↑  Ø8/13	○	/	/	●	/	/
Daily130++	↗ Ø8	/	/	/	/	/	/
Decor/Decor C	↑ Ø13	/	/	/	/	/	/
Decor Evo/Decor C Evo	↑ Ø15	/	/	/	/	/	/
Dub100++	↑ Ø8	/	/	/	/	/	/
Entity90+	↑ Ø8	○	●	●	●	/	/
	↑  Ø8/13	○	/	/	●	/	/
Fancy/Fancy Evo	↑ Ø15	/	/	/	/	/	/
Gotha70	↑ Ø8	○	●	●	●	/	/
Like80	↑ Ø8	/	/	/	/	/	/
	↑ Ø8	○	●	●	●	/	/
	↗ Ø8	○	/	/	●	/	/
	↑  Ø8/13	○	●	/	●	/	/
Maison80	↗ Ø8	/	/	/	/	/	/
Maison80+	↗ Ø8	/	/	/	/	/	/
Metro110+	↗ Ø8	○	●	●	●	/	/
Spot100 H Spot100 H Evo	↗ Ø8	/	/	/	/	/	/
Spy110+	↗ Ø8	○	●	●	●	○	●
Tweed90+	↑ Ø8	○	●	●	●	○	●
	↗ Ø8	/	/	/	●	○	/
Yung130++	↗ Ø8	/	/	/	/	/	/
Zone80	↗ Ø8	○	●	●	●	/	/

CONDICIONES GENERALES DE VENTA (Válido también para Italiana Camini)

• Los precios de la presente tarifa no incluyen el I.V.A.

• Los pedidos se aceptarán sólo si se reciben por escrito o vía mail

1.1 Los precios a los que se hace referencia en la confirmación a la recepción del pedido están sujetos a posibles cambios en concepto de aumentos en los costos de las materias primas y/o cualquier otro costo de producción y de transporte, que puedan acaecer en el período comprendido entre la fecha del pedido y la fecha de entrega. Por lo tanto, cualquier variación de los factores antes mencionados, que se produzca después de la fecha de confirmación del pedido, dará derecho a la empresa Edilkamin S.p.A. a cambiar el precio acordado.

1.2 Los ajustes a los que se refiere el artículo anterior (1.1) podrán ser aplicados por la sociedad Edilkamin S.p.a. hasta una semana antes de la fecha de entrega efectiva y debe ser comunicado al Comprador por la empresa Edilkamin S.p.A. por correo electrónico.

1.3 El Comprador, dentro de las 48 (cuarenta y ocho) horas siguientes a la recepción de la comunicación del cambio de precio a que se refiere el artículo anterior (1.2), tendrá derecho a cancelar el pedido confirmado por escrito mediante correo electrónico, o en su defecto, el cambio de precio se considerará aceptado.

• Cualquier venta a crédito estará condicionada al límite autorizado por la compañía aseguradora.

• Toda pieza enviada por Edilkamin Iberica, hasta el almacén del comprador, conllevará un cargo en concepto de colaboración transporte del 2% para España y 3% para Portugal del valor neto del producto, que se aplicará en factura.

Los materiales devueltos serán abonados por un importe de un 80% del precio de facturación, siempre que la mercancía esté en perfecto estado y con el embalaje de origen.

• Todas las mercancías pertenecen a EDILKAMIN IBÉRICA S.L.U. hasta su total pago.

• La realización de un pedido implica la aceptación íntegra de todas las condiciones arriba indicadas.

Las entregas en direcciones distintas del almacén del comprador tendrán que ser autorizadas por la Dirección Comercial, y tendrán un cargo de portes, que será calculado por este Departamento, en base al destino y peso de la mercancía.

• La mercancía viaja por cuenta y riesgo del comprador, quién tiene la obligación de verificar el producto a su llegada.

• EDILKAMIN IBÉRICA S.L.U. sólo tendrá en consideración aquellas reclamaciones formuladas al recibo del material informadas como "POSIBLE ROTURA" con anotación en el albarán de la agencia de transportes correspondiente, o bien por escrito hasta 24 horas después del recibo de éste.

• Sólo se aceptará devolución de material por causas imputables a EDILKAMIN IBÉRICA S.L.U. si se alcanzara algún acuerdo excepcional, autorizado por escrito por la Dirección Comercial, que permita la devolución de material.

CERTIFICACIONES

Los productos, además del marcaje CE, en base a las normas:

- EN 13229 - Hogares de leña
- EN 13240 - Estufas de leña
- EN 14785 - Estufas de pellet
- EN 303-5 - Calderas

según las necesidades, respetan los criterios de:

- FLAMME VERTE: Certificación francesa de calidad
- BAFA: Ministerio de Energía alemán
- BImSchV: Requisitos para el mercado alemán

CLASES DE EFICIENCIA ENERGÉTICA

Todos los productos Edilkamin pertenecen a las clases de eficiencia energética, según los reglamentos UE 2015-1186/1187.

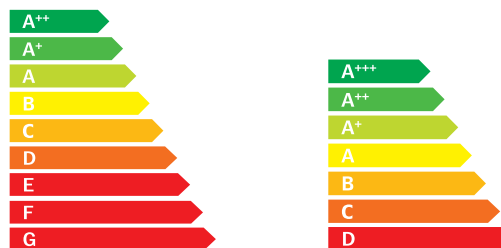

ECODESIGN

Define los requisitos mínimos que los productos de combustible sólido, usan para calentar, deben respetar, para poder ser introducidos en el mercado europeo; calderas desde 2020, otros productos desde el 2022.

INFORMACIÓN ÚTIL

Para pedidos de chimeneas de ubicación en ángulo, indique DERECHA cuando estos deban colocarse a la derecha y viceversa:



LEYENDA SÍMBOLOS

	Potencia nominal		Instalación coaxial
	Potencia al agua		R Radiomando T Telemando
	Potencia útil min-max		Panel sinóptico
	Rendimiento		Programación diaria / semanal encendido/apagado en horario deseado
	*Volumen calentable		Autocheck en frío: que permite encontrar inmediatamente eventuales inconvenientes
	**Consumo Min-Max		Autoclean: Limpieza automática del crisol
	Autonomía Min-Max		E-Smart es el sistema innovador, con WI-FI integrado
	Depósito pellet		Confort clima: Apagado al alcanzar la temperatura
	Salida humos ↑ SUPERIOR ↗ TRASERA ↔ LATERAL		FIRE CONTROL Regula adecuadamente la cantidad de combustible.
	Hogar: G: fundición, A: acero, V: vermiculita, E: Ecokeram		Air Tight Estufas de pellet estanca completamente herméticas respecto al ambiente de la instalación.
	Peso con embalaje		Passive House Apta para casas pasivas
	Dimension: Largo/Profundidad/Altura		EASY TIMER Permite programar el encendido y el apagado de la estufa.
	Canalización		RELAX La estufa funciona a convección natural. Disfruta el bienestar de la calefacción por radiación y reduce el ruido al mínimo.
	Contenido de agua		Ventilación aire caliente desactivable

*Se calcula en base a una necesidad de 33 kcal/m³h. El mismo volumen puede variar sensiblemente en consideración al grado de aislamiento de la habitación, de su exposición, de la zona climática, etc.

**Para el cálculo del consumo de combustible se usa un poder calorífico de 4,6 kW/kg para la leña y 4,8kW/kg para el pellet.

*** El Ø de la salida de humos no es el Ø del sistema de chimenea que deberá ser dimensionado de conformidad con las normas nacionales y locales y en particular, aunque no exhaustivas, EN 13384, EN 1443, EN 1856, EN 1457.

****La longitud de la canalización y la temperatura de la salida de aire, dependen de las condiciones de uso e instalación. Sugerimos dimensionar el sistema de canalización.



*** EK63**

Se reserva la facultad de modificar en cualquier momento, sin previo aviso, las características técnicas y estéticas de los elementos ilustrados y declina cualquier responsabilidad por posibles errores de impresión presentes. Las imágenes son puramente indicativas. En el momento de la entrega, las partes en piedra de los revestimientos pueden presentar diferencias con respecto a las imágenes contenidas en este documento. Las partes de cerámica, con el uso del producto y con el paso del tiempo, pueden sufrir un natural efecto craquelado y opacificación que no deben considerarse defectos (no conformidad). Para una correcta instalación seguir cuanto se reporta en el manual de instalación.